

OWNER'S MANUAL

Cat. No. 20-118

PRO-2011
PROGRAMMABLE SCANNER
FM Monitor Receiver
VHF: 30 – 54 MHz / 138 – 174 MHz
UHF: 380 – 512 MHz

PLEASE READ BEFORE USING THIS EQUIPMENT



REALISTIC®

You'll hear all the action with your new Realistic® PRO-2011 Programmable Scanning Receiver! You have direct access to over 22,000 frequencies in eight action radio bands including police, fire, ambulance, ham radio, and transportation services! And your PRO-2011 scans up to 20 channels so you won't miss any of the excitement.

Your PRO-2011 superior performance is a result of the very latest in solid-state technology. It contains a custom-designed microprocessor. A computer on a chip! Now you can easily enter and change frequencies whenever you wish by using the keyboard. You no longer need to obtain crystals for specified frequencies.

CONTENTS

A Quick Look at Your PRO-2011	4
Preparation	6
Operation	7
Understanding the Display and Keyboard	7
Programming Frequencies	9
Hints and Tips in Programming	10
Manual Mode	11
Scanning Frequencies	11
Delay	11
Locking Out Frequencies	12
Birdies	13
Types of Signals You Will Be Able to Monitor ..	14
Before You Call for Help	16
Maintenance	17
Specifications	18
Block Diagram	19

WARNING: TO PREVENT FIRE OR SHOCK HAZARD, DO NOT EXPOSE THIS RECEIVER TO RAIN OR MOISTURE.

Copyright 1986, Tandy Corporation

Your PRO-2011 Programmable Scanner is loaded with features.

- Covers all these bands:
 - 30 – 50 MHz (VHF Lo)
 - 50 – 54 MHz (ham radio 6 meter band)
 - 138 – 144 MHz (government)
 - 144 – 148 MHz (ham radio 2 meter band)
 - 148 – 174 MHz (VHF Hi)
 - 380 – 450 MHz (ham radio and government)
 - 450 – 470 MHz (UHF Lo)
 - 470 – 512 MHz (UHF Hi)

Over 22,000 frequencies!

- A total of 20 channels for storing frequencies
- Large multi-purpose LCD showing which channels and frequencies are being scanned or programmed as well as the status of the channels and the operation mode of the PRO-2011
- Channel lockout with built-in skipper circuit
- Optional two-second scan delay to eliminate missed replies on any channel
- PLL tuning circuit for lock-stable reception
- 455 kHz ceramic filter and the 10.7 MHz crystal filter for outstanding adjacent channel selectivity and reduced interference
- Holds memorized frequencies in memory backup circuit

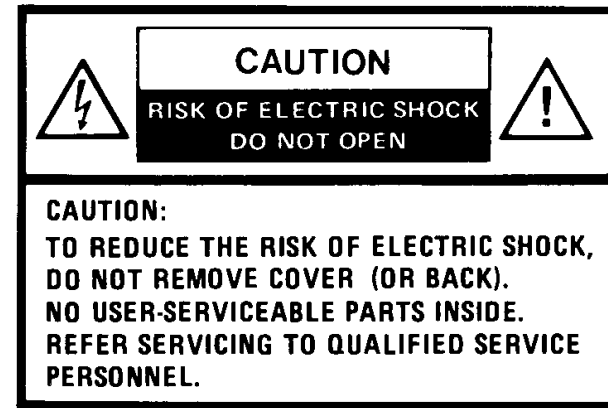

The lightning flash with arrowhead within the triangle is intended to alert the user to dangerous voltage inside this unit that can cause shock. Do not open enclosure.



The exclamation point within the triangle is intended to alert the user to important operating and maintenance instructions in this owner's manual.

For your personal records, record your scanner's serial number in the box below. You'll find the serial number on the rear panel of the unit.

Serial Number

A QUICK LOOK AT YOUR PRO-2011

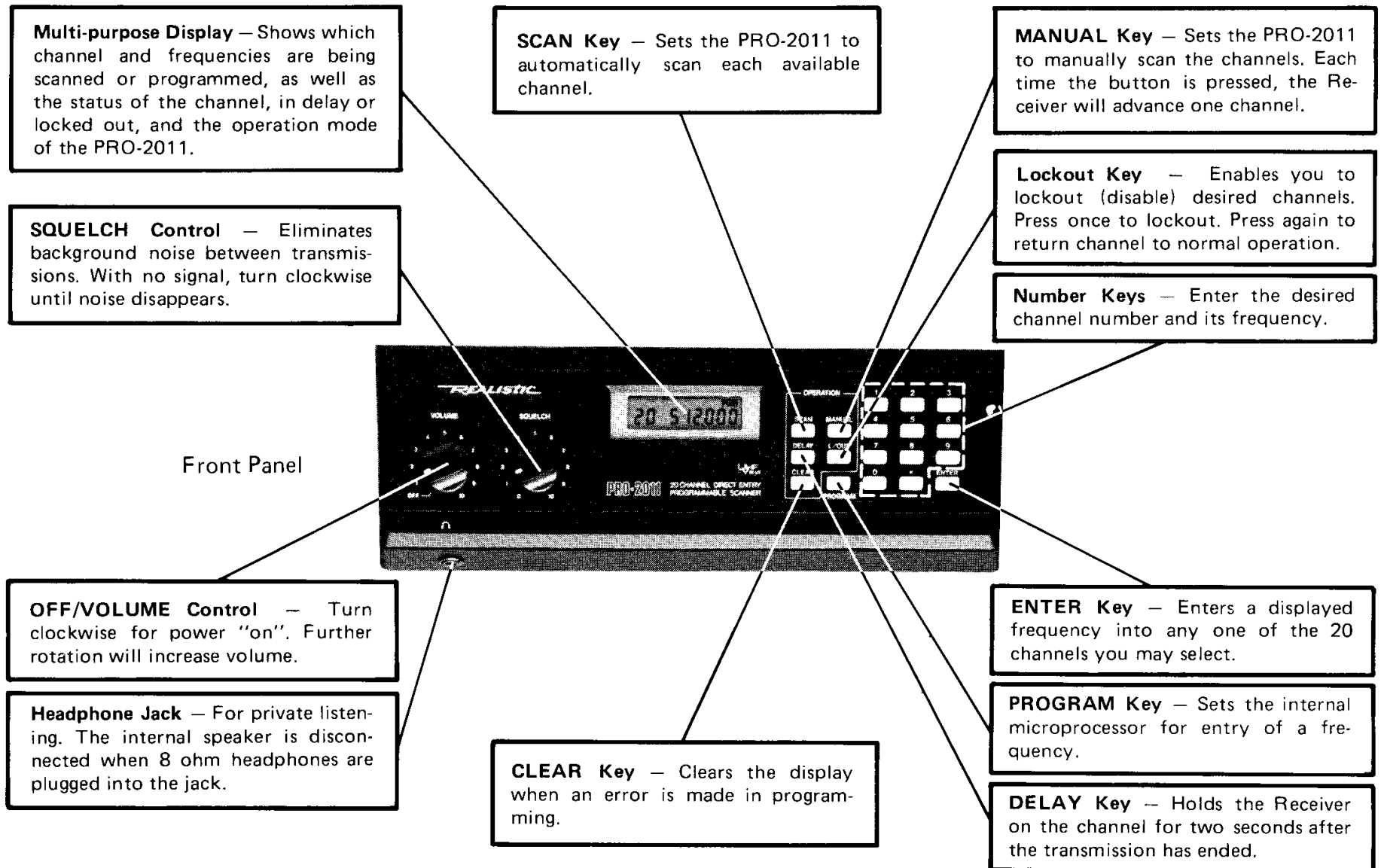

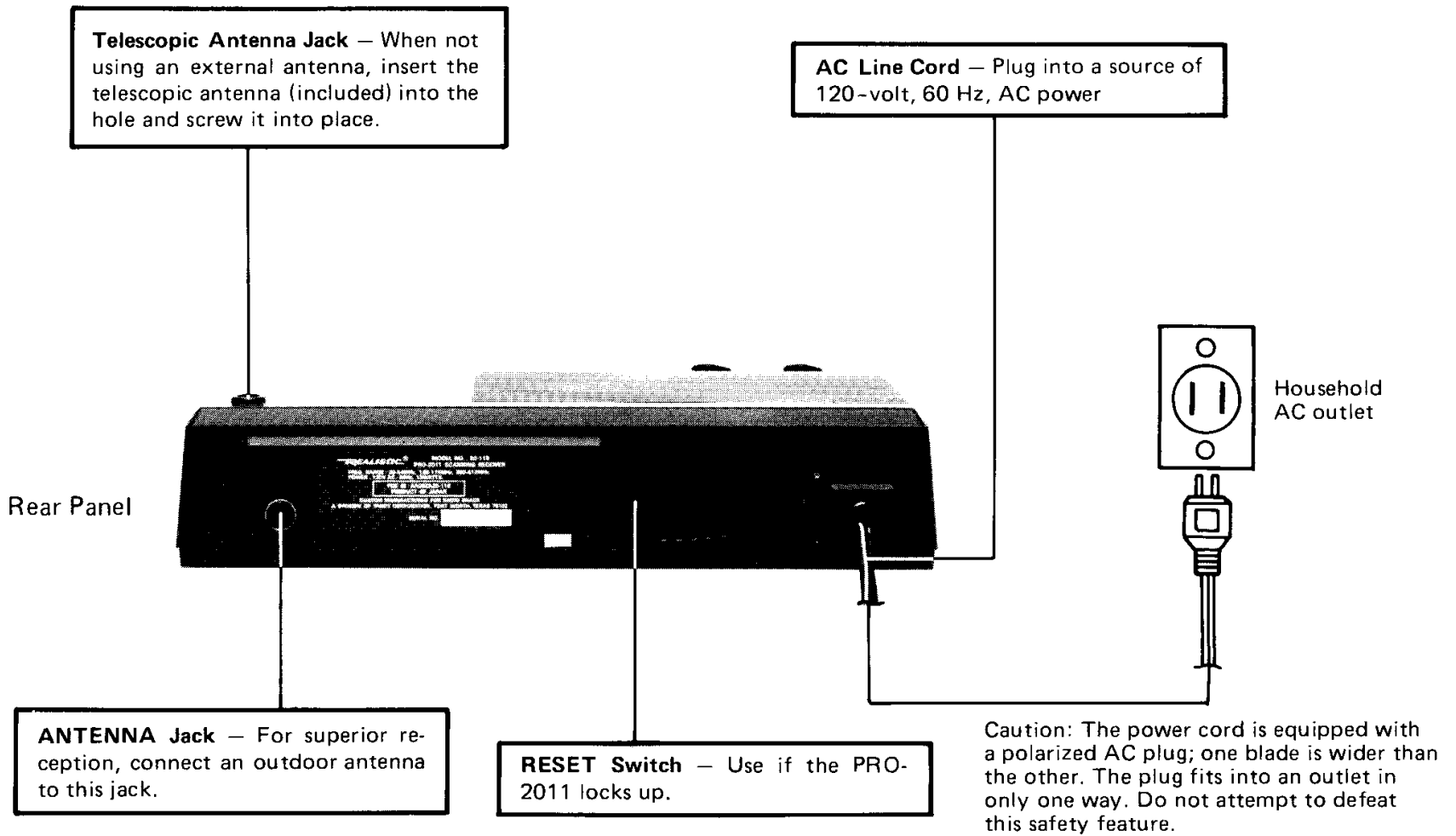

PREPARATION

Powering Your PRO-2011

To use your PRO-2011, you must do three things.

1. Connect an antenna. A telescoping antenna is provided with your Scanner. Screw it into the hole in the top of the case. The telescopic antenna included is adequate for strong local signals. But the best reception will result from a multi-band outdoor antenna. It should be mounted as high as possible, because the VHF and UHF signals your Receiver picks up travel in a straight line. The higher your antenna the better your reception.

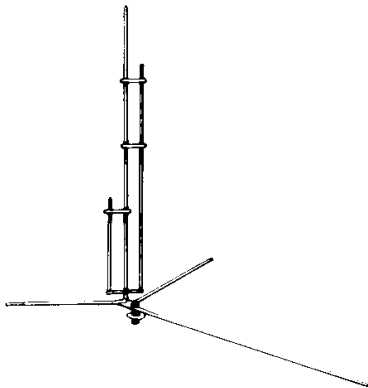

20-014

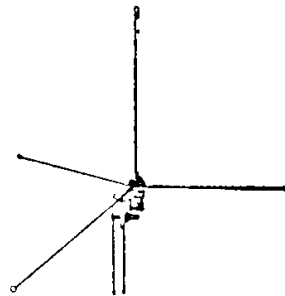

20-176

WARNING WARNING WARNING

When installing or removing base station antennas, use extreme caution. If the antenna starts to fall, let it go! It could contact overhead power lines. **If the antenna touches the power line, contact with the antenna, mast, cable or guy wires can cause electrocution and death!** Call the power company to remove the antenna. Do not attempt to do so yourself.

2. Connect power. After a few minutes, the memory backup circuit starts functioning. The frequencies you enter will not be lost when you turn the power off. In the event of power failure, or if the power cord becomes disconnected, the circuitry will hold the memory for approximately one hour.
3. Enter the frequencies into the PRO-2011. This is explained under Programming Frequencies.

RESET Switch

When the LCD shows random display or no display at all, use the Reset switch on the rear panel to clear the PRO-2011. With power turned on, press the switch with a ball-point pen or similar object. Note however, **all the memories stored in your PRO-2011 will be cleared** by the reset and your scanner will have to be reprogrammed.

Headphones Listening

If you have difficulty hearing in a noisy area, such as a factory, at the scene of a fire or accident, or if you don't want your Scanner to bother other people, plug headphones into the Headphones jack for private listening. This will automatically disconnect the built-in speaker.

OPERATION

Turn on your PRO-2011 by rotating VOLUME clockwise. When first turned on, your PRO-2011 might start scanning.

Rotate SQUELCH fully counterclockwise. You'll hear a rushing noise from the speaker — if not, rotate VOLUME a little further clockwise — and the scanning will stop. Slowly rotate SQUELCH clockwise until the noise stops, and scanning resumes. You are now ready to start entering frequencies.

Understanding the Display and Keyboard

The liquid crystal display (LCD) on your PRO-2011 displays the channel number, the frequency being received, status of different functions, **DELAY** or **Lock OUT**, and current operation mode. The illustration shows the location of the symbols. As they move on and off the display, you can see which mode of operation is engaged.

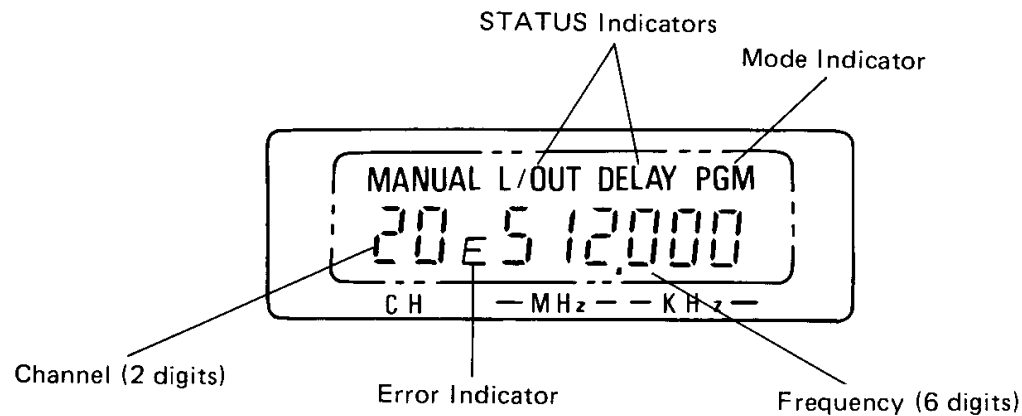

The three operating modes include Programming, Manual, and Scanning.

ERROR Indicator

Sometimes when you try to enter a frequency for a channel, you will see an E on the display. This means the frequency is in error and you won't be able to enter it into your PRO-2011.

Such frequency errors usually mean you've entered a frequency outside the ranges your PRO-2011 operates

on, such as 225.00 MHz or you've put the decimal point in the wrong place, for example, 14.682 MHz instead of 146.82 MHz. Check carefully to find your mistake and then press **CLEAR**. You can now enter the correct frequency.

Note: All the settings of delay/lockout/skipping channels are retained when you turn power off. The next time you turn the PRO-2011 on, the same settings as when you turned the unit off are still in effect.

Programming Frequencies

The programming of the PRO-2011 is as simple as 1–2–3.

1. Select the desired channel.
2. Press **PROGRAM** to enter programming mode.
3. Enter the desired frequency. Press **ENTER**.

Note: If you are uncertain about specific frequencies in your locale, Radio Shack's "Police Call Directory Including Fire & Emergency Services" is an excellent reference.

Example for Programming a Frequency
(frequency 162.55 MHz into channel 20)

Step 1.

Select the channel in one of three ways:

- a. Press **MANUAL**. Continue pressing until the display shows channel 20. Press **PROGRAM**.
- b. Press **2** **0** **MANUAL**. Press **PROGRAM**.

— or —

- c. Press **PROGRAM**.

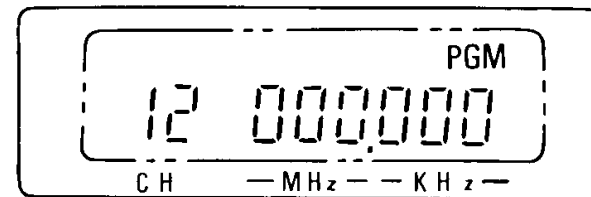

Press **2** **0**.

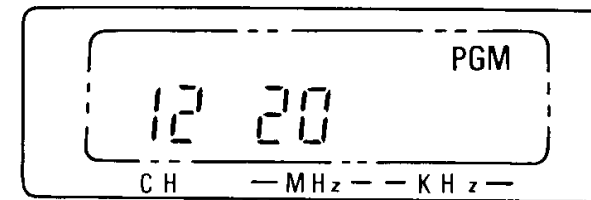

Press **PROGRAM**.



Step 2.

Press the keys **1** **6** **2** **.** **5** **5** .

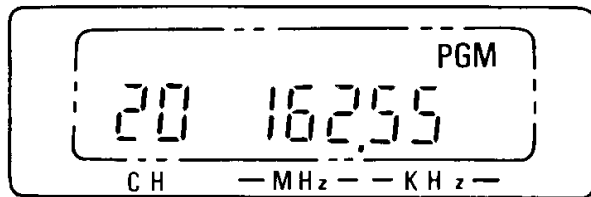

Step 3.

Press **ENTER** .

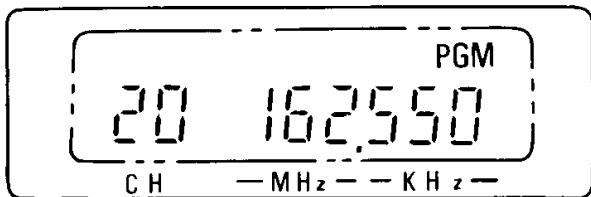

To program the next frequency, press **PROGRAM** to advance to the next channel.



Repeat the same steps to add more frequencies.

Hints and Tips for Programming

When you make a mistake while entering a number, press **CLEAR** and re-enter the correct frequency.

If you enter a frequency that is outside a PRO-2011 band range, Error indicator lights.

Press **CLEAR** and select another frequency.

Any frequency within a PRO-2011 band range will be accepted. However the frequency that can be stored into PRO-2011 memory is in 5 kHz step in the VHF bands and 12.5 kHz step in the UHF bands. The scanner will automatically round off the entered frequency to the closest valid frequency. For example, if you enter 145.234 MHz, the PRO-2011 will accept this entry as 145.230 MHz. Or the entry 398.263 MHz will be treated as 398.262 MHz.

The tuning range of your PRO-2011 is permanently stored in the microprocessor chip. There's no way it can be extended or altered – even by a skilled electronics technician. So if you try to enter a frequency not in the PRO-2011's tuning range, you'll get an error message every time.

If you want to change the frequency entered for a specific channel, enter the new frequency over the old one, following the steps under **Programming Frequencies**.

Manual Mode

When you want to stay on a frequency, press **MANUAL**. In the manual mode, you can manually advance through the memory channels by pressing **MANUAL** repeatedly. Or enter the channel number and press **MANUAL** to reach the desired channel directly. Also note that in manual mode, you can access locked out channels.

Scanning Frequencies

Your PRO-2011 will automatically scan all the channels you have programmed and stop whenever it finds a signal.

To stop scanning, press **MANUAL**. Then you can select a specific channel you want to listen to. Enter the channel number, then press **MANUAL**. Or press **MANUAL** and continue pressing until you reach the frequency you want.

Important! Your PRO-2011 won't scan unless SQUELCH is set to the point where no sound is heard between transmissions, that is, no "hiss" sound.

Delay

In the scanning mode, your PRO-2011 will stop when it finds a channel with a signal. As soon as the signal ends, it immediately begins scanning other channels. Most transmissions are part of a two-way communication.

Press **DELAY** when you wish to hold a channel you are listening to.

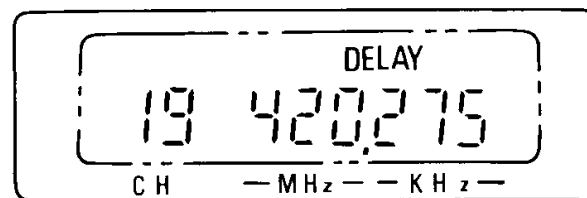

Your PRO-2011 will then hold the channel at least two seconds after each transmission, giving you time to listen.

DELAY appears on the LCD to show that the delay function is engaged for the selected channel.

To release the delay function, press **DELAY** again. It disappears from the display.

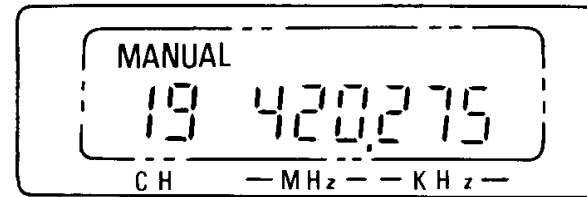
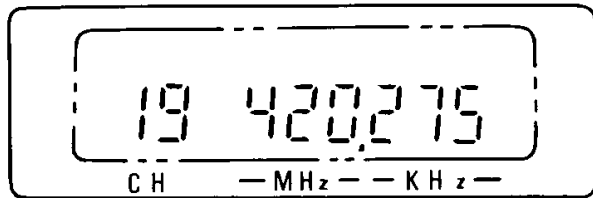

3. Press **L/OUT**. **L/OUT** appears on the display, indicating this channel will be skipped during scanning.

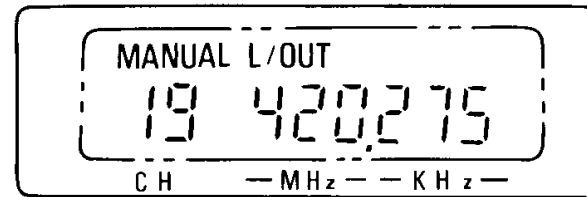

Locking Out Frequencies (Skipping Frequencies)

You might want your PRO-2011 to skip certain frequencies while it's scanning, such as continuously transmitted weather broadcasts. To lock out such channels, follow these steps:

1. Press **MANUAL** to stop scanning.
2. Continue pressing **MANUAL** until you reach the channel you want to lock out. If you know the channel number, this can be done more quickly. Enter the channel number then press **MANUAL**.

Note: In manual scanning you can access the locked out channels.

Releasing the lockout functions

1. Press **MANUAL** to stop scanning.
2. Advance to the channel that is locked out.

3. Press **L/OUT** again. **L/OUT** disappears from the display.

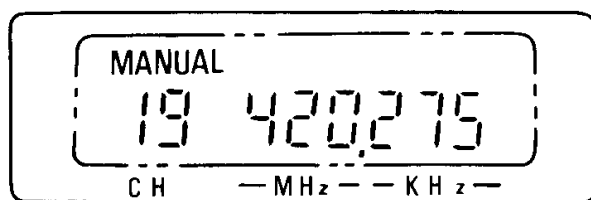

You can lock out as many channels as you like. But there must be at least one channel that is not locked out. The last channel cannot be locked out.

Birdies

“Birdies” are the products of internally generated signals that make some frequencies difficult or impossible to receive. If you program one of these, the Receiver locks up and you’ll hear only noise on that frequency.

If the interference is not severe, you might be able to rotate **SQUELCH** clockwise to cut out the birdie. The most common “birdies” to watch out for are listed below.

Birdies Frequencies

30.735 MHz	140.800 MHz	390.400 MHz
32.000 MHz	147.200 MHz	403.200 MHz
32.090 MHz	153.600 MHz	416.000 MHz
to	160.000 MHz	428.800 MHz
32.130 MHz	166.400 MHz	441.600 MHz
38.400 MHz	172.800 MHz	
44.800 MHz		

Even with the **SQUELCH** control set to maximum (fully clockwise), scanning may stop on or around some of these frequencies. If the signal is strong enough (above $10 \mu\text{V}$ in technical terms) you can listen for transmissions on the channel. But you will have to use **MANUAL** to move off the troublesome frequency.

TYPES OF SIGNALS YOU WILL BE ABLE TO MONITOR

Your community is alive with action — action which is constantly being reported on the air waves. And your PRO-2011 will automatically scan the air waves to bring you that action — your police force at work, a fire truck on a mission, sheriff's department, state police, the national weather service, ham radio operators, highway and other emergency-type services, some industrial services, some transportation services (taxi, trucks, railroad), plus some government services. Lots of things are going on that most of us just are never aware of. But, with the right frequencies programmed in your PRO-2011, you can monitor such exciting signals. You'll have to do a little investigation in your community to find out what services are active and on what frequencies. You will find a copy of Radio Shack's "Police Call Radio Directory" most helpful.

What to listen for and where? That is a little difficult for a specific answer. Each area of the country can and will use different channels. All we can do is give you some general pointers and then let you take it from there.

Find out if there is a local club which monitors these frequencies. Often a local electronics repair shop that does work on the equipment can give you the channel frequencies used by local radio services. A volunteer police or fire employee can also be a good source of this information.

An interesting service is the mobile telephone. FCC has assigned this service channels in the range of 152.51 to 152.81 MHz at every 0.030 MHz (channels are 30 kHz apart). Also 454.375 to 454.95 MHz with channels 25 kHz apart from 454.375 to 454.625 and then every 50 kHz up to 454.95.

As a general rule on VHF-Hi, most activity will be concentrated between 153.785 and 155.98 and then again from 158.73 to 159.46 MHz. Here you'll find local government, police, fire and most emergency services. If you are near a railroad yard or major railroad tracks, look around 160.0 to 161.9 for them.

In some of the larger cities, there has been a move to the UHF bands for emergency services. Here, most of the activity is in a spread of 453.05 — 453.95 and again at 456.025 — 459.95 MHz.

In the UHF band, the overall spread of 456.025 – 459.95 and again at 465.025 – 469.975 MHz is used by mobile units and control stations associated with base and repeater units which operate 5 MHz lower (that is, 451.025 – 454.95 and 460.025 – 464.975 MHz). This means that if you find an active channel inside one of these spreads, you can look 5 MHz lower (or higher as the case may be) to find the major base station/repeater for that radio service.

NATIONAL WEATHER SERVICE RECEPTION

Continuous weather broadcasts are transmitted 24 hours a day in many parts of the country. Your PRO-2011 will automatically lock in on one of the channels assigned (162.55, 162.40, 162.475 MHz, or 162.425, 162.450, 162.500, 165.525 MHz), because the broadcasts are continuous. To prevent automatic locking, use the channel lockout feature on the weather channel. The first three channels are the most widely used frequencies. The remaining four are in use in some areas. When you want a weather report, access the weather channel in the Manual mode. In areas where stations are close to each other, one will use 162.55, another will use 162.40, and a third might use 162.475 MHz. Check with your local FCC office or the National Weather Service for the frequency used in your area. You can also write to:

National Weather Service Office
Attn: W/OM 15x2
National Oceanic and Atmospheric Administration,
Silver Spring, Md. 20910.

BEFORE YOU CALL FOR HELP

The frequencies stored in the Scanner memory circuit can be held for approximately an hour if the unit is unplugged.

If for some reason, the memory becomes lost, press the RESET button and re-enter the frequencies.

If you have problems . . .

We hope you don't – but here are some suggestions:

Problem	Possible Cause	Remedy
Scanner is totally inoperative.	No power	Check to see that unit is plugged into a working AC outlet.
Scanner is on, but will not scan.	1) Channels are locked out. 2) Squelch control is not adjusted correctly.	1) Press MANUAL , then release each channel from lockout one-by-one. 2) Adjust SQUELCH clockwise.
Scan locks on frequencies having no clear transmission.	"Birdies"	Avoid programming frequencies listed on page 13, or only listen to them by using the manual mode.

If none of these suggested remedies solves the problem, return your set to your nearby Radio Shack store for assistance.

MAINTENANCE

Your PRO-2011 represents a fine example of electronic engineering and construction. As such it should be treated accordingly. We offer the following suggestions so you will enjoy this product for many years to come.

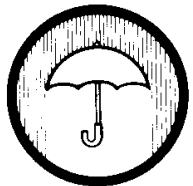

Keep it dry. If water should get on it, wipe it off immediately. Water contains minerals that can corrode electronic circuits.



Do not store in hot areas. High temperatures can shorten the life of electronic devices and can even distort or melt certain plastics.



Do not drop your product. This will likely result in failure to operate. Circuit boards can crack and cases may not survive the impact. Handling your product roughly will shorten its useful life.

If at anytime you suspect that your unit is not performing as it should, stop by your local Radio Shack store. Our personnel are there to assist you and arrange for service, if needed.



Do not use or store in areas of high levels of dirt or dust. The electronics may be contaminated. Any moving parts will wear prematurely.



Do not use harsh chemicals, cleaning solvents or strong detergents to keep your unit looking new. You need only wipe it with a dampened cloth from time to time.

SPECIFICATIONS

FREQUENCY COVERAGE:

VHF-Lo

30–50 MHz in 5 kHz steps

Ham

50–54 MHz in 5 kHz steps

Government

138–144 MHz in 5 kHz steps

Ham

144–148 MHz in 5 kHz steps

VHF-Hi

148–174 MHz in 5 kHz steps

Ham/Gov't.

380–450 MHz in 12.5 kHz steps

UHF-Lo

450–470 MHz in 12.5 kHz steps

UHF-Hi ("T")

470–512 MHz in 12.5 kHz steps

CHANNELS OF OPERATION:

Any 20 channels in any band combinations.

SENSITIVITY:

20 dB Signal-to-Noise ratio at 3 kHz deviation

30– 54 MHz 0.5 μ V

138–174 MHz 1.0 μ V

380–512 MHz 1.0 μ V

SPURIOUS REJECTION:

30– 54 MHz 50 dB at 40 MHz

138–174 MHz

50 dB at 154 MHz

380–512 MHz

Not specified.

SELECTIVITY:

\pm 9 kHz, –6 dB

\pm 15 kHz, –50 dB

IF REJECTION:

10.7 MHz

50 dB at 154 MHz

SCANNING RATE:

8 channels/sec.

DELAY TIME:

2 seconds

MODULATION ACCEPTANCE:

\pm 8 kHz

INTERMEDIATE FREQUENCIES:

10.7 MHz and 455 kHz

FILTERS:

1 crystal filter,

1 ceramic filter

SQUELCH SENSITIVITY:

Threshold

Less than 1.0 μ V

Tight

(S+N)/N 25 dB

ANTENNA IMPEDANCE:

50 ohms

AUDIO POWER:

1.5 watts maximum, 1.2 watts nominal

BUILT-IN SPEAKER:
 3" (77 mm) 8 ohm, dynamic type

POWER REQUIREMENTS:
 AC, 120 Volts, 13 watts

DIMENSIONS:
 2" (52mm) x 9-5/6" (250mm) x 7" (175mm) HWD

WEIGHT:
 1.9 lbs (900 g)

BLOCK DIAGRAM

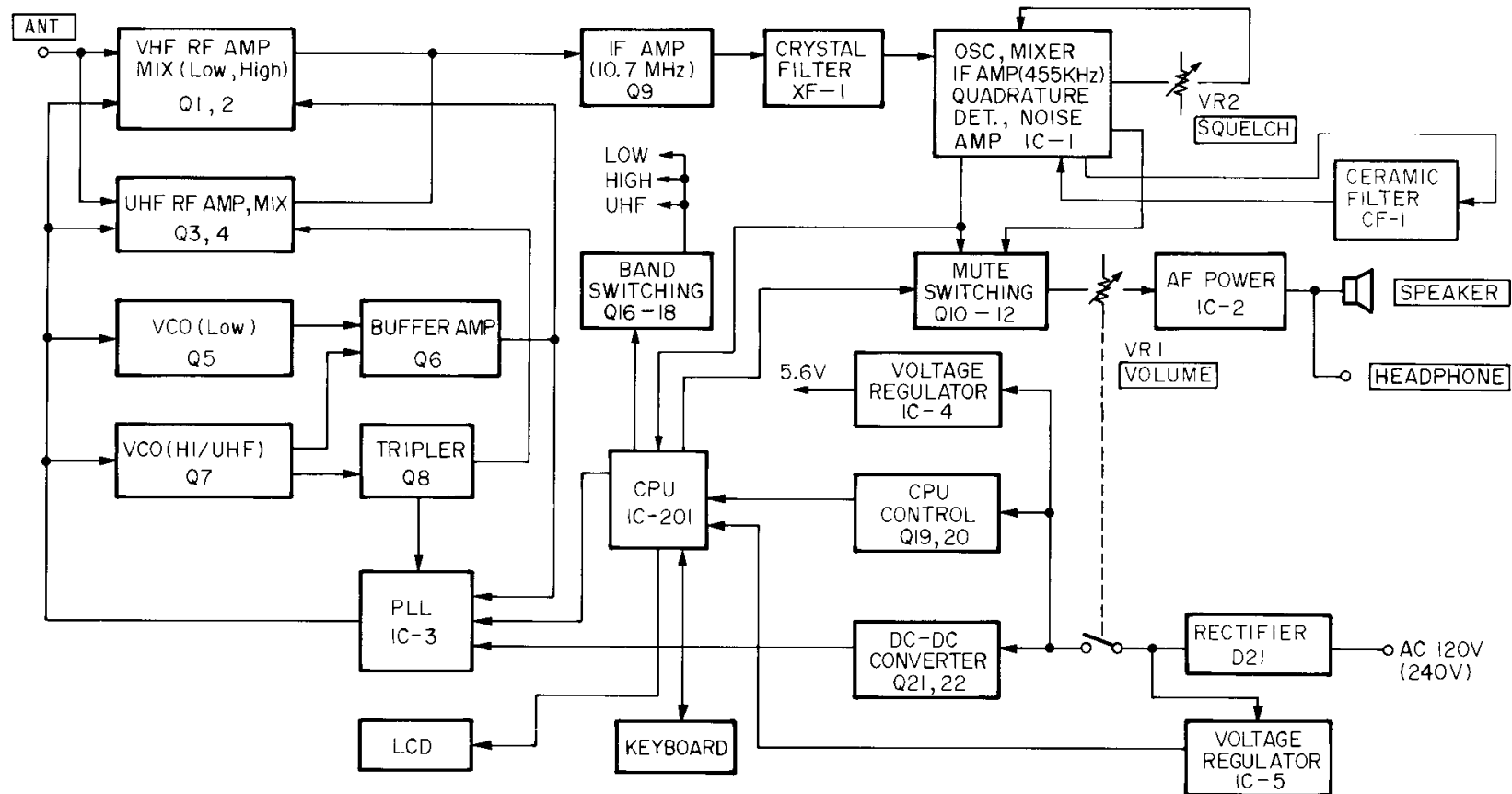

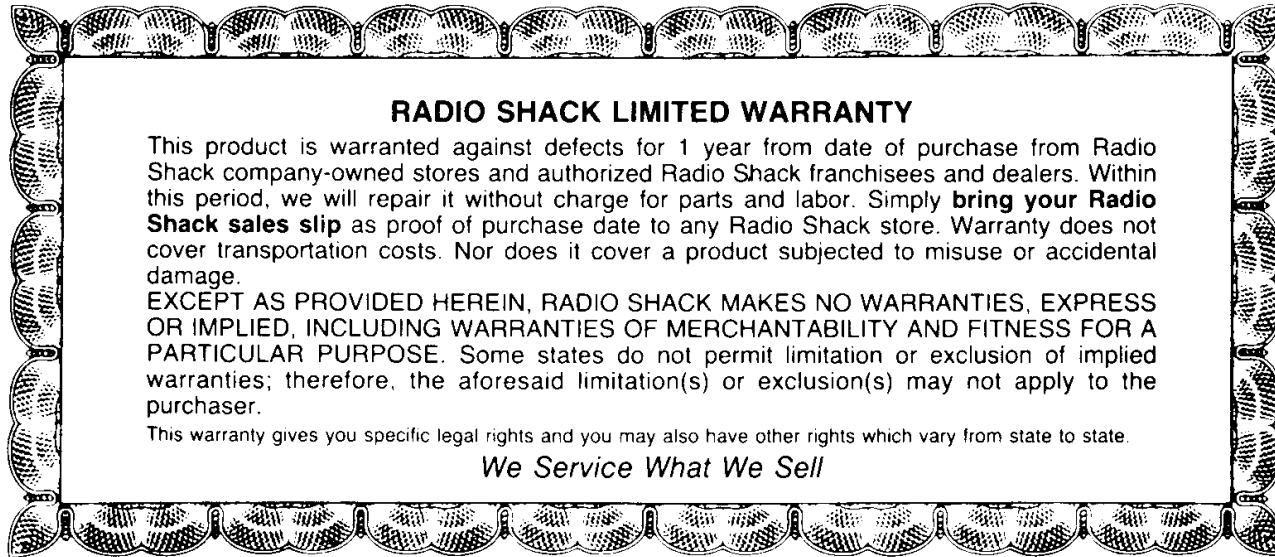

RADIO SHACK LIMITED WARRANTY

This product is warranted against defects for 1 year from date of purchase from Radio Shack company-owned stores and authorized Radio Shack franchisees and dealers. Within this period, we will repair it without charge for parts and labor. Simply **bring your Radio Shack sales slip** as proof of purchase date to any Radio Shack store. Warranty does not cover transportation costs. Nor does it cover a product subjected to misuse or accidental damage.

EXCEPT AS PROVIDED HEREIN, RADIO SHACK MAKES NO WARRANTIES, EXPRESS OR IMPLIED, INCLUDING WARRANTIES OF MERCHANTABILITY AND FITNESS FOR A PARTICULAR PURPOSE. Some states do not permit limitation or exclusion of implied warranties; therefore, the aforesaid limitation(s) or exclusion(s) may not apply to the purchaser.

This warranty gives you specific legal rights and you may also have other rights which vary from state to state.

We Service What We Sell

U.S. PATENT NOS.

- 3,794,925
- 3,801,914
- 3,961,261
- 3,962,644
- 4,027,251
- 4,092,594
- 4,123,715
- 4,245,348

RADIO SHACK
A Division of Tandy Corporation
Fort Worth, Texas 76102

Free Manuals Download Website

<http://myh66.com>

<http://usermanuals.us>

<http://www.somanuals.com>

<http://www.4manuals.cc>

<http://www.manual-lib.com>

<http://www.404manual.com>

<http://www.luxmanual.com>

<http://aubethermostatmanual.com>

Golf course search by state

<http://golfingnear.com>

Email search by domain

<http://emailbydomain.com>

Auto manuals search

<http://auto.somanuals.com>

TV manuals search

<http://tv.somanuals.com>