

OWNER'S MANUAL

PRO-2042

1000-Channel Programmable Home Scanner

Please read before using this equipment.

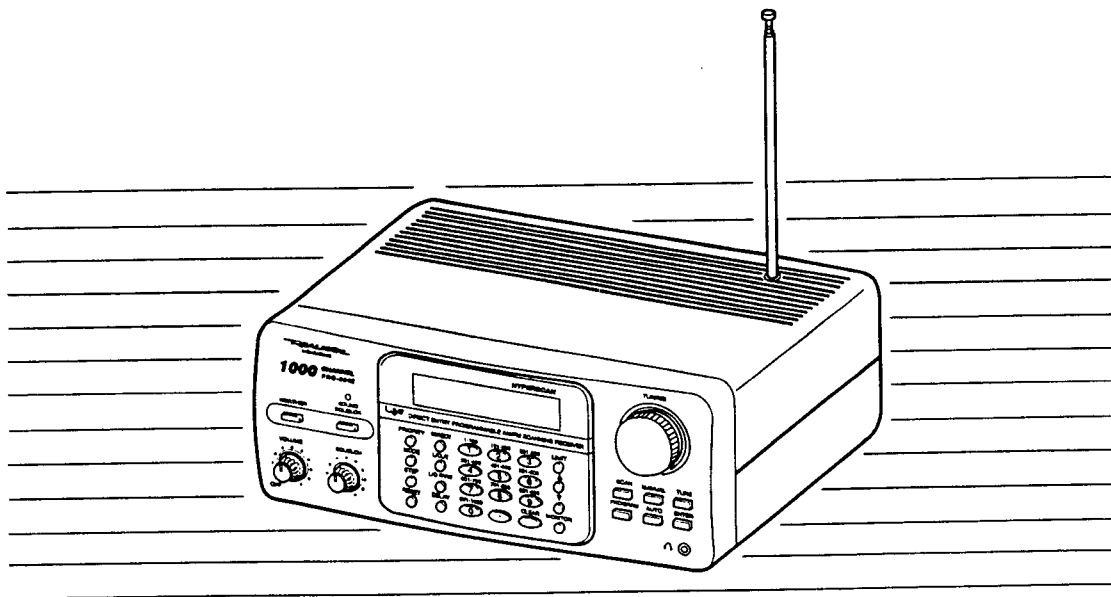

20-9464

REALISTIC
by RadioShack

INTRODUCTION

Your new Realistic by RadioShack PRO-2042 1000-Channel Programmable Home Scanner lets you in on all the action! With its convenient rotary tuner and keypad, you can quickly tune to over 196,000 frequencies (within the ranges of 25-1300 MHz).

The secret to your scanner's ability to scan so many frequencies is its custom-designed microprocessor — a tiny, built-in computer.

Your scanner has all these special features.

Hyperscan — lets you scan up to 50 channels per second and search up to 50 steps per second.

Ten Channel-Storage Banks — you can store 100 channels in each bank to group channels so calls are easier to identify. The scanner automatically warns you if you try to store duplicate frequencies (except when storing frequencies into channels from monitor memories).

100 Monitor Memories — temporarily save up to 100 frequencies located during a frequency search, letting you move selected frequencies to permanent channel storage later.

Priority Channel — you can set the scanner to check one channel every 2

seconds so you do not miss important calls.

Auto Store — quickly finds and automatically stores active frequencies in each channel, then searches for additional active frequencies while skipping previously stored channels.

TAPE OUT Jack — lets you connect an optional tape recorder to the scanner to record transmissions.

Rotary Tuner — lets you manually tune and select desired frequencies or channels. The scanner's tune speed automatically changes depending on how fast you turn the rotary tuner.

Two-Second Channel Scan Delay — delays scanning for 2 seconds before moving to another channel, so you can hear more replies.

© 1996 InterTAN Inc.
All Rights Reserved.

Memory Backup — keeps channel frequencies stored in memory for up to 3 months during a power loss.

Lock-Out Function — lets you set your scanner to skip over specified channels or frequencies when scanning or searching.

Frequency Sort — lets you sort frequencies stored in a bank from the highest to the lowest or the lowest to the highest frequency, to help you organize stored frequencies in your scanner's memory.

Ten Preprogrammed Frequency Ranges — let you search for transmissions within preset frequency ranges or within ranges you set, to reduce search time and select interesting frequencies more quickly.

Direct Frequency Search — lets you search for new and unlisted frequencies.

Sound Squelch — keeps the scanner from stopping on frequencies with only a carrier signal and no voice or other sound, so you can hear only calls instead of static.

Backlit Display — makes it easy to view and change programming information.

Two Power Options — let you power the scanner from standard AC power (with the supplied AC power cord), or your vehicle's battery (with an optional DC cigarette lighter power cord).

For your records, we urge you to record your scanner's serial number in the space below. The serial number is located on the scanner's back panel.

Serial Number: _____

Warning: To prevent fire or shock hazard, do not expose this product to rain or moisture.

Your PRO-2042 scanner can receive all of these bands:

- 25–520 MHz
- 760–1300 MHz

NOTICE

Your scanner might cause TV or radio interference even when it is operating properly. To determine whether or not your scanner is causing the interference, turn off your scanner. If the interference goes away, your scanner is causing it. Try to eliminate the interference by:

- Moving your scanner away from the receiver.
- Connecting your scanner to an outlet that is on a different electrical circuit from the receiver.
- Contacting your local Tandy store for help.

If you cannot eliminate the interference, local regulations may require you to stop using your scanner.

For U.K. Only

The supplied appliance is fitted with an approved 13 Amp standard UK type plug. If this plug is not compatible with your mains socket outlet it should be cut off and disposed of immediately as it is a shock hazard if inserted into a live socket outlet. An approved type plug that is compatible with your socket outlets must then be fitted.

Important: The wires in the mains lead are coloured in accordance with the following codes:

Blue.....Neutral
Brown..... Live

The wires in the mains lead must be connected to the terminals in the plug as follows:

Mains Lead Wire Colour	Plug Terminal Marking
Blue	N or Black or Blue
Brown.....	L or Red or Brown

Do not connect either wire to the earth terminal marked or by the letter E or by the safety earth symbol () or coloured green or green-and-yellow.

If the plug required for your socket outlets is fitted with a fuse, this must be a 3 Amp type and should carry BS kite or ASTA mark.

Never use a plug without a fuse cover fitted.

If the plug is not fusible type, the master fuse for the mains outlet sockets should not be greater than 5 Amps.

If in doubt refer to a qualified electrician.

Warning: This equipment should be disconnected when not in use for an extended period.

CONTENTS

Preparation	7
Connecting an Antenna	7
Connecting Power	8
Using Your Vehicle's Battery	9
Restarting/Resetting the Scanner	9
Connecting Optional Equipment	11
Connecting an External Speaker	11
Connecting Headphones	11
Listening Safely	12
Connecting a Tape Recorder	12
Understanding Your Scanner	13
A Look at the Keyboard	13
A Look at the Display	15
Understanding Banks/Memories	17
Channel-Storage Banks	17
Monitor Memories	17
Operation	18
Turning on the Scanner/Setting Volume and Squelch	18
Using the Rotary Tuner	18
Tuning Channel Numbers	18
Tuning Frequencies	18
Using Monitor Memories	19
Searching For and Storing Active Frequencies	19
Manually Storing Frequencies	20
Automatically Storing Frequencies	20
Limit Search	23
Searching a Preprogrammed Frequency Range.....	23
Changing a Preprogrammed Range.....	24
Direct Search	25
Scanning the Channels	26
Turning Channel-Storage Banks Off and On	26
Moving Frequencies	27
Moving a Frequency from a Monitor Memory to a Channel	27
Moving Frequencies from Monitor Memories to a Bank	27
Moving Frequencies Within Banks	28
Moving Frequencies from Banks to Monitor Memories	28

Deleting Frequencies	29
Deleting a Frequency from a Channel or Monitor Memory.....	29
Deleting Frequencies from All Locked-Out Channels Within a Bank	29
Deleting Frequencies from All Channels Within a Bank	29
Sorting Frequencies Within a Bank.....	30
Special Features	31
Delay	31
Using the ATT Switch	31
Using the Sound Squelch Switch	31
Locking Out Channels and Frequencies	32
Reviewing Locked-Out Channels and Frequencies	33
Deleting All Locked-Out Frequencies	33
Priority	33
Manually Selecting a Channel	34
Band Mode and Frequency Step	35
Changing/Resetting the Band Mode	35
Changing/Resetting the Frequency Step	35
A General Guide to Scanning	37
Guide to Frequencies	37
Ham Radio Frequencies	37
Birdie Frequencies	38
Specified Intervals	39
Frequency Conversion.....	40
Troubleshooting	41
Care and Maintenance	42
Specifications	43

PREPARATION

This scanner is primarily designed for use in the home as a base station. You can place it on a desk, shelf, or table.

Your scanner's front feet fold up or down. Adjust them to give you the best view of the display.

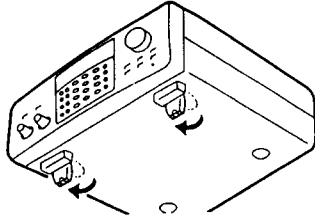

CONNECTING AN ANTENNA

The supplied telescoping antenna helps your scanner receive strong local signals. To install the antenna, screw it clockwise into the hole on the scanner's top.

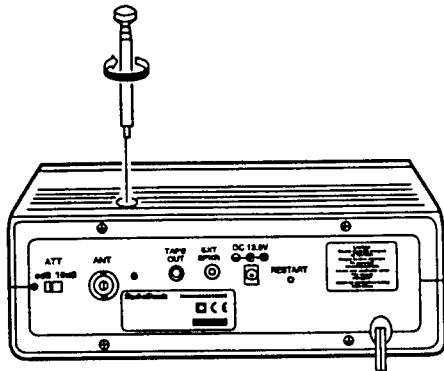

The scanner's sensitivity depends on the antenna's length and various environmental conditions. For the best reception of the transmissions you want to hear, adjust the antenna's length.

Frequency	Antenna Length
25-300 MHz	Extend fully
300-520 MHz	Extend three segments
760-1300 MHz	Collapse all segments

Instead of the supplied antenna, you can connect an outdoor base antenna (not supplied) to your scanner. Your local Tandy store sells a variety of antennas. Choose the one that best meets your needs.

When deciding on an outdoor base antenna and its location, consider the following:

- The location of the antenna should be as high as possible.
- The antenna and antenna cable should be as far as possible from sources of electrical noise (appliances, other radios, and so on).
- The antenna should be vertical for the best performance.

To connect an optional antenna, always use 50-ohm coaxial cable, such as RG-58 or RG-8. For length over 14.24 m (50 feet), use RG-8 low-loss dielectric coaxial cable. If the coaxial cable's connector does not fit in the ANT jack, you might also need a PL-259-to-BNC antenna plug adapter. Your local Tandy store carries a wide variety of coaxial antenna cable and connectors.

Follow the mounting instructions supplied with the antenna. Then route the antenna cable to the scanner, and connect it to the **ANT** jack on the back of the scanner.

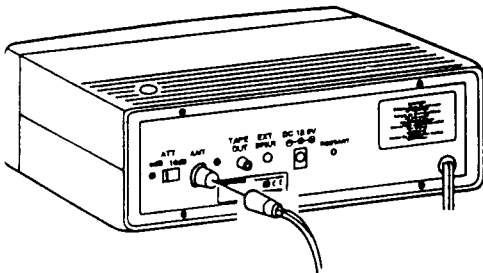

Caution: Do not run the cable over sharp edges or moving objects.

Warning: Use extreme caution when you install or remove an outdoor antenna. If the antenna starts to fall, let it go! It could contact overhead power lines. If the antenna touches a power line, contact with the antenna, mast, cable, or guy wires can cause electrocution and death. Call the power company to remove the antenna. **DO NOT** attempt to do so yourself.

CONNECTING POWER

Plug the scanner's attached AC power cord into a standard AC outlet.

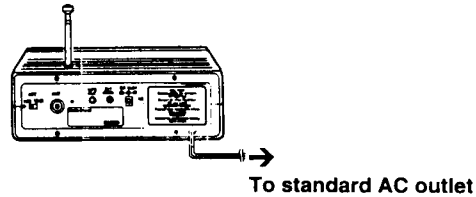

The memory backup circuit begins to function a few minutes after you supply power to the scanner. How long the scanner will maintain channels stored in memory depends on how long power has been supplied to the scanner. For example, if power is supplied to the scanner for at least 4 days, the memory backup circuit maintains the channels stored in memory for up to 3 months.

Using Your Vehicle's Battery

If your AC power does not work in an emergency, you can power your scanner from your vehicle's cigarette lighter socket with an optional DC cigarette lighter power cable (not supplied).

To connect an optional DC cigarette lighter power cable, insert its barrel plug into the **DC 13.8V** jack on the back of the scanner, then plug the power cable into your vehicle's cigarette lighter socket.

Caution: If you use a DC cigarette lighter power cable with the scanner, it must supply 12 volts and deliver at least 1 amp. Its center tip must be set to positive, and its plug must correctly fit the **DC 13.8V** jack on the back of the scanner. Using a power cable that does not meet these specifications could seriously damage the scanner or the power cable.

Note: Mobile use of this scanner is unlawful or requires a permit in some areas. Check the laws in your area.

RESTARTING/ RESETTING THE SCANNER

If the scanner's display locks up or the scanner does not work properly after you connect power, you might have to restart or reset the scanner.

Restarting the scanner clears and resets the scanner's display, but does not erase any channel information stored in the scanner's memory. Follow these steps to *restart* the scanner.

1. Use **OFF/VOLUME** to turn off the scanner, then turn it on again.

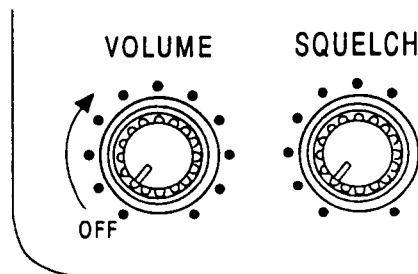

2. Insert a pointed object, such as a straightened paper clip, into the **RESTART** hole on the back of the scanner.

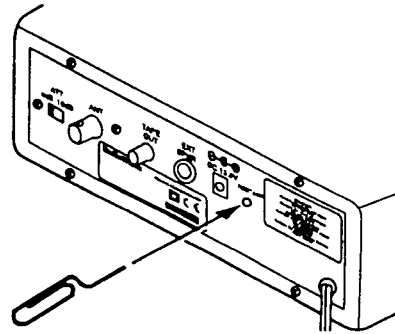

If the scanner still does not work properly, you might have to *reset* it.

Caution: This procedure clears all the information you have programmed into the scanner. Use this procedure only when you are sure your scanner is not working properly.

1. Use **OFF/VOLUME** to turn off the scanner, then turn it on again.
2. Press and hold down **CLEAR**.

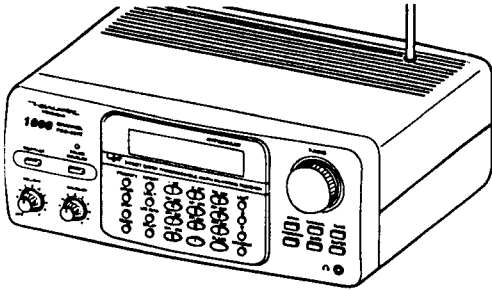

3. While inserting a pointed object such as a straightened paper clip into the **RESTART** hole on the back of the scanner, press it until the information on the display disappears. Then release it.
4. After the information reappears on the scanner's display, release **CLEAR**.

CONNECTING OPTIONAL EQUIPMENT

CONNECTING AN EXTERNAL SPEAKER

You can connect an optional external speaker with a 3.5 mm (1/8-inch) plug to the scanner. Use an 8-ohm external speaker capable of handling over 2.5 watts of power (not supplied).

Insert the speaker's plug into the **EXT SPKR** jack on the back of the scanner.

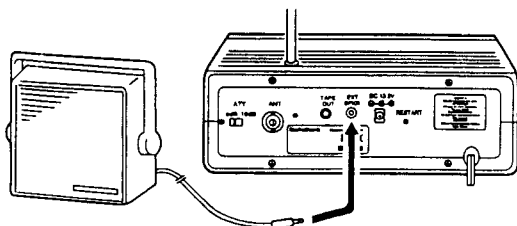

Note: Plugging in an external speaker disconnects the scanner's internal speaker.

CONNECTING HEADPHONES

You can connect an optional pair of headphones with a 3.5 mm (1/8-inch) plug to the scanner. Use monaural headphones.

Insert the headphones' plug into the  jack on the front of the scanner.



Note: Plugging in headphones disconnects the scanner's internal speaker.

Listening Safely

To protect your hearing, follow these guidelines when you use headphones.

- Set **OFF/VOLUME** to the lowest setting before you begin listening. After you put on the headphones, adjust **OFF/VOLUME** to a comfortable level.
- Do not listen at extremely high volume levels. Extended high-volume listening can lead to permanent hearing loss.
- Once you set **OFF/VOLUME**, do not increase it. Over time, your ears adapt to the volume level, so a volume level that does not cause discomfort might still damage your hearing.

CONNECTING A TAPE RECORDER

You can connect an optional tape recorder to your scanner to record transmissions. To record from the scanner, you need a tape recorder with a microphone jack (not supplied). Also, you need a connecting cable with a phono plug and a 3.5 mm ($\frac{1}{8}$ -inch) plug (not supplied).

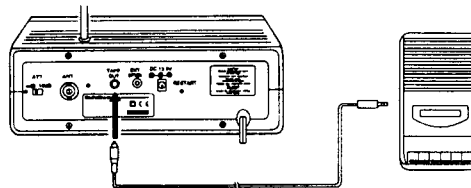

1. Insert the connecting cable's phono plug into the **TAPE OUT** jack on the back of the scanner.
2. Connect the other end of the connecting cable to your tape recorder's microphone jack.

Follow the instructions provided with your tape recorder to record transmissions while the scanner is on.

UNDERSTANDING YOUR SCANNER

A LOOK AT THE KEYBOARD

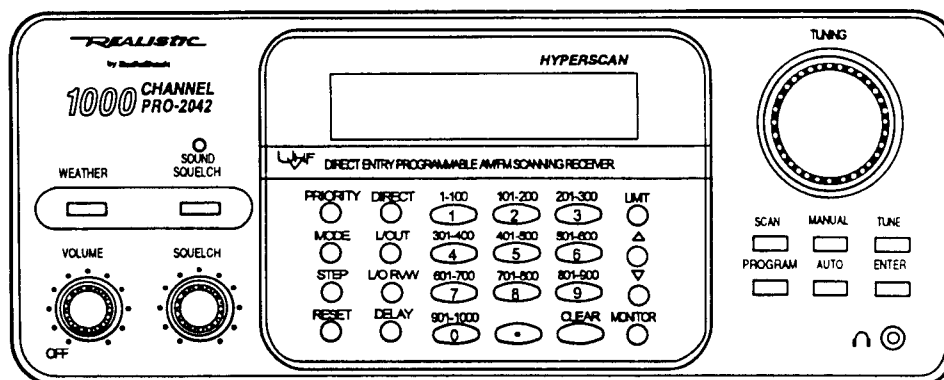

A quick glance at this section should help you understand each key's function.

PRIORITY — sets and turns on and off priority for a particular channel.

MODE — changes the band mode (AM, NFM, or WFM).

STEP — changes the frequency step (5, 12.5, or 50 kHz).

RESET — resets the default band mode and frequency step.

DIRECT — starts a direct frequency search.

L/OUT — lets you lock out selected channels or frequencies.

L/O RVW — lets you review locked-out channels or frequencies.

DELAY — programs a 2-second delay for the selected mode.

Number Keys — each key has a single-digit label and a range of numbers. Use the digits on the keys to enter the numbers for a channel or a frequency. Use the range of numbers above the key (201-300, for example) to select the channels in a channel-storage bank. See "Understanding Banks/Memories" on Page 17.

WEATHER — scans through the ten preprogrammed weather channels. The channels are not available in the U.K.

SOUND SQUELCH — sets the scanner to continue to scan if it stops on a carrier signal with no voice or other sound.

OFF/VOLUME — turns the scanner on or off and adjusts the volume.

SQUELCH — adjusts the scanner's squelch.

• — enters the decimal point when you enter a frequency.

CLEAR — clears an incorrect entry.

LIMIT — sets the frequency range you want to search.

△ and ▽ — searches up or down from the currently displayed frequency.

MONITOR — accesses the 100 monitor memories.

TUNING knob — turn to tune through channels or frequencies. Turn **TUNING** faster to increase the speed at which you tune.

SCAN — scans through the channels.

MANUAL — stops scanning to let you directly enter a channel number or frequency.

TUNE — lets you use the scanner's rotary tuner to tune through frequencies.

PROGRAM — lets you program frequencies into channels.

AUTO — automatically programs frequencies into channels.

ENTER — enters frequencies into channels.

A LOOK AT THE DISPLAY

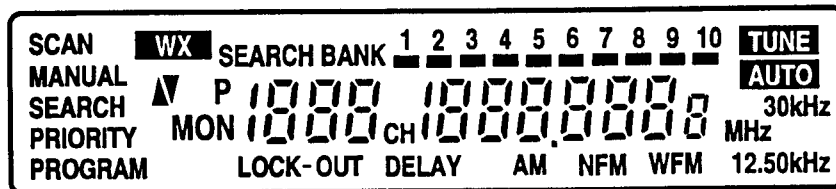

The display has indicators that show the scanner's current operating mode. A good look at the display will help you understand your scanner.

SCAN — appears when you scan channels.

MANUAL — appears when you manually select a channel.

SEARCH — appears during a direct search and a limit search.

PRIORITY — appears when the priority feature is turned on.

PROGRAM — appears when you press **PROGRAM** while selecting a channel to store a frequency in, or while selecting a search bank.

WX — appears when you scan the ten preprogrammed weather band channels. The weather band channels are not available in the U.K.

▲ and ▼ — appear when the scanner is scanning, when you press ▲ and ▼ while the scanner is doing a limit or direct search, when you tune

through weather channels, or when you store frequencies.

MON — appears with a number (1-100) to show which monitor memory you are listening to.

P — appears when the scanner is set to the priority channel.

SEARCH BANK — appears with numbers (1-10). Numbers with a bar under them show which search banks are turned on for a limit search.

BANK — appears with numbers (1-10). Numbers with a bar under them show which channel-storage banks are turned on for scanning. See "Understanding Banks/Memories" on Page 17.

CH — appears with a number (1-1000) to show which of the scanner's 1,000 channels it is tuned to.

LOCK-OUT — appears when you lock out a channel or frequency.

MHz — appears with digits to show which frequency your scanner is currently tuned to.

DELAY — appears when scanning stops at a channel you have programmed for a 2-second delay.

AM — appears when the scanner scans a frequency set to the AM mode or when you change a frequency to the AM mode. See “Band Mode and Frequency Step” on Page 35.

NFM — appears when the scanner scans a frequency set to the narrowband FM mode, or when you change a frequency to the narrowband FM mode. See “Band Mode and Frequency Step” on Page 35.

WFM — appears when the scanner scans a frequency set to the wideband FM mode, or when you change a frequency to the wideband FM mode. See “Band Mode and Frequency Step” on Page 35.

TUNE — appears when you press **TUNE** to use the scanner’s rotary tuner.

AUTO — appears when the scanner automatically stores frequencies into channels.

kHz — appears with digits to show which frequency step (5, 12.5, or 50) the scanner is set to.

-d- — appears instead of the channel number during a direct search.

Error — appears when you make an invalid entry.

Sort. — appears when the scanner sorts frequencies. See “Sorting Frequencies Within a Bank” on Page 30.

A-FULL — appears when you select a full bank, or when you finish sorting a full bank. See “Automatically Storing Frequencies” on Page 20.

AC — appears with a number to show the number of empty channels in a bank.

DUPL — briefly flashes when you try to program a duplicate frequency within a channel. See “Manually Storing Frequencies” on Page 20.

UNDERSTANDING BANKS/MEMORIES

You can store frequencies into either a permanent memory location called a channel, or a temporary memory location called a monitor memory. You can store up to 1,000 channels and up to 100 monitor memories.

CHANNEL-STORAGE BANKS

To make it easier to identify and select the channels you want to listen to, channels are divided into 10 channel-storage banks (1-10) of 100 channels each. You can use each channel-storage bank to group frequencies.

MONITOR MEMORIES

The scanner also has 100 monitor memories. Use these memories to temporarily store frequencies while you decide whether to save them into channels. This is handy for quickly storing an active frequency when you are searching through an entire band.

To store a frequency into a monitor memory, you must perform a limit or direct search. See "Searching For and Storing Active Frequencies" on Page 19.

You can select monitor memories either manually or by using the scanner's rotary tuner, but you cannot scan them. See "Using Monitor Memories" on Page 19.

OPERATION

TURNING ON THE SCANNER/SETTING VOLUME AND SQUELCH

1. Turn **SQUELCH** fully counterclockwise.
2. Turn **VOLUME** clockwise until you hear a hissing sound. The scanner turns on and **SCAN**, a channel number, and a frequency appear on the display. Then the scanner scans any frequencies already stored in any active banks.

Note: If you have not stored any frequencies or activated any banks yet, the scanner does not scan.

3. Turn **SQUELCH** clockwise, then leave it set to a point just after the hissing sound stops.

Note: If the scanner picks up unwanted, partial, or very weak transmissions, turn **SQUELCH** clockwise to decrease the scanner's sensitivity to these signals. If you want to listen to a weak or distant station, turn **SQUELCH** counterclockwise.

USING THE ROTARY TUNER

When you set the scanner to scan or search, it uses hyperscan to automatically scan up to 50 channels or search up to 50 steps per second.

The scanner's rotary tuner lets you quickly select channels and frequencies manually. As you turn **TUNING** one click, the channel or frequency changes one step at a time.

Note: If you quickly turn **TUNING**, the rate at which the scanner tunes through the channels or frequencies becomes faster.

Tuning Channel Numbers

To tune channel numbers, press **MANUAL**, then turn **TUNING** clockwise (to tune to higher channel numbers) or counterclockwise (to tune to lower channel numbers).

Notes:

- If you have not stored any frequencies into channels yet, the scanner displays the empty channels.
- You cannot use the rotary tuner to tune to a channel while the scanner is scanning the priority channel.

Tuning Frequencies

Notes:

- You can use the rotary tuner to tune frequencies during a search (see "Searching For and Storing Active Frequencies" on Page 19).

-
- If you turn **TUNING** too slowly, the scanner might accidentally change the search or scan direction.

Follow these steps to use the rotary tuner to tune frequencies.

1. When the scanner stops on a frequency while searching, press **TUNE**. The frequency number and **TUNE** appear.
2. To tune frequencies, turn **TUNING** clockwise (to tune to higher frequencies) or counterclockwise (to tune to lower frequencies).

USING MONITOR MEMORIES

Monitor memories are temporary storage areas where you can store up to 100 frequencies while you decide whether or not to save them into channels. You can manually select monitor memories, but you cannot scan them.

You can store frequencies you find during a limit or direct search, or while tuning, into monitor memories. Simply press **MONITOR** when the desired frequency appears on the display. The channel number to the right of **MON** indicates the current monitor memory.

To listen to a monitor memory, press **MANUAL**, then press **MONITOR**. The current monitor memory appears. To select other monitor memories, either:

- Turn **TUNING** one click to select each monitor memory.
- Use the number keys to enter the monitor memory's number, then press **MONITOR**.

Both **MON** and the frequency stored in the monitor memory are displayed.

SEARCHING FOR AND STORING ACTIVE FREQUENCIES

You can store frequencies into channels using any of the following methods:

- Manual storage
- Auto storage
- Limit search (within a range of pre-programmed frequencies or frequencies you select)
- Direct search (within a range of frequencies before or after a frequency you select)
- Moving a frequency from a monitor memory

you do not have a reference to frequencies in your area, follow the steps in "Automatically Storing Frequencies" on this page, "Limit Search" on Page 3, or "Direct Search" on Page 25 to search for transmissions.

Manually Storing Frequencies

If you know a frequency you want to store, you can store it manually.

1. Press **PROGRAM**. **PROGRAM** appears.
2. To select the channel where you want to store the frequency, use the number keys to enter the channel number, then press **PROGRAM**. Or, turn **TUNING** until the channel number appears.
3. Using the number keys, enter the frequency you want to store into that channel.
4. Press **ENTER** to store the frequency.

Notes:

- If you entered an invalid frequency in Step 3, the scanner beeps and displays the channel number and **Error**. Simply repeat Steps 3 and 4.
- Your scanner automatically rounds the entered frequency down to the closest valid frequency. For example, if you try to enter a frequency of 151.473,

your scanner accepts it as 151.470.

- If you entered a frequency that is already stored in another channel, the scanner beeps three times and displays the lowest channel number where the frequency is already stored, and **DUPL** briefly flashes. If you want to store the frequency anyway, press **ENTER** again.
5. Repeat Steps 2-4 to store more frequencies into channels.

Automatically Storing Frequencies

Your scanner can automatically store active frequencies from a particular frequency range into empty channels in the banks you specify.

Notes:

- The scanner automatically prevents storage of duplicate frequencies during auto store. However, you can manually store a duplicate frequency.
- The scanner does not store locked-out frequencies during auto store (see "Locking Out Channels and Frequencies" on Page 32).

1. Press **AUTO**. **AUTO** appears.
2. Press the number key for each bank where you want to store frequencies.

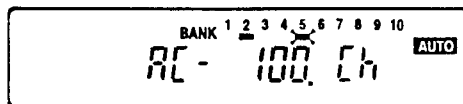

Notes:

- To select bank 10, press 0.
- If you select a bank that does not contain any empty channels, a bar flashes under the bank number, and **A-FULL** and **AUTO** appear. To enter new frequencies into this bank, you must delete one or more frequencies stored in it, then repeat Step 2. See "Deleting Frequencies" on Page 29.
- If you select a bank that contains at least one empty channel, a bar flashes under the

bank number, and **AC-**, the number of empty channels in the bank, **Ch**, and **AUTO** appear.

- If you do not want to select the bank, press the bank's number again. The bar under the bank disappears.
 - If you select more than one bank and want to review the number of empty channels in each bank, turn **TUNING** to select the bank you want to review. As you turn **TUNING**, a bar flashes under the selected bank's number.
3. Press **LIMIT**. **Lo** appears.
 4. Use the number keys to enter the lower limit of the frequency range you want to search, then press **ENTER**.

Note:

- If you enter an invalid frequency in Step 4 or 6, the scanner displays **Error**. Simply repeat the step.
5. Press **LIMIT**. **Hi** appears.

-
- Use the number keys to enter the upper limit of the frequency range you want to search, then press **ENTER**.
 - Press Δ to search from the lower to the upper limit, or ∇ to search from the upper to the lower limit. **AUTO** and the bar under the currently selected bank number flash on the display.

When the scanner finds an active frequency, it stores the frequency in the displayed channel, then continues searching for more active frequencies, storing them in any subsequent empty channels. When the scanner fills all channels within the selected banks, the scanner beeps rapidly and displays the number of the last channel where a frequency was stored.

Note: During auto store, you can manually change the band mode or frequency step. See "Changing/Resetting the Band Mode" or "Changing/Resetting the Frequency Step" on Page 35.

To pause auto store, press **AUTO**. The scanner displays the last channel number where a frequency was stored. To continue auto store, press Δ or ∇ .

- To stop auto store, press **MANUAL**. **MANUAL** appears.

Notes:

- If no frequencies are stored when you pause auto store by pressing **AUTO**, --- appears on the display.
- During auto store, the scanner beeps when the search reaches the upper limit frequency and continues searching at the lower limit frequency, or vice versa.
- If you set the limit range (in Steps 3-6) equal to or narrower than the frequency step of the band mode, the scanner beeps continuously.

LIMIT SEARCH

You can search for transmissions within a range of frequencies you select, called a limit search range. You can either use one of the scanner's 10 pre-programmed limit search ranges, or you can enter your own.

Notes:

- You can use the scanner's delay feature while using limit search. See "Delay" on Page 31.
- When the scanner searches for frequencies within a limit search range, you can store frequencies you hear during the search into monitor memories.
- The scanner does not search locked-out frequencies during limit search unless the locked-out frequency is the upper or lower limit frequency.

Searching a Preprogrammed Frequency Range

The scanner contains these preprogrammed limit search ranges, stored in search banks (1-10).

Search Bank	Limit Search Range (MHz)
1	25-1300
2	25-29.995
3	30-67.995

Search Bank	Limit Search Range (MHz)
4	68-87.495
5	87.5-107.95
6	108-136.9875
7	137-224.995
8	225-400
9	400.0125-520
10	760-1300

Note: You can replace a preprogrammed range (see "Changing a Preprogrammed Range" on Page 24).

Follow these steps to select preprogrammed limit search ranges and search them for active frequencies.

1. Press **LIMIT. I** and the number of the currently selected search banks appear, and a bar flashes under each of those search bank numbers.

Note: If you already entered your own limit search ranges in other search banks, a bar appears under each of those search bank numbers.

2. Using the number keys, enter the search bank number for each limit search range you want to select or remove.

Notes:

- You can search more than one limit search range at a time. For example, if you want to search both the 25–29.995 MHz and 68–87.495 MHz ranges, press 2, then press 4.
 - To select bank 10, press 0.
3. Press Δ to search from the lower to the upper limit, or ∇ to search from the upper to the lower limit. As the scanner searches, it displays **SEARCH**, and the bar under the selected search bank number flashes.

When the scanner finds an active frequency, it stops searching. To save the frequency into a monitor memory, press **MONITOR**. **MON** and the current monitor channel number appear on the display.

Press Δ or ∇ again to continue searching for additional active frequencies.

Notes:

- As the scanner automatically searches, you can also search through frequencies manually by pressing **TUNE**, then turning **TUNING**. Press **TUNE** again to continue the limit search.
- During limit search, you can manually change the band mode or frequency step. See “Changing/Resetting the Band Mode” or “Chan-

ging/Resetting the Frequency Step” on Page 35.

Changing a Preprogrammed Range

You can replace preprogrammed limit search ranges with frequency ranges you enter. This is useful if there is a range of frequencies you search often that is not within any of the preprogrammed ranges.

Note: You can restore preprogrammed limit search ranges you replaced by resetting the scanner. See “Restarting/Resetting the Scanner” on Page 9.

1. Press **PROGRAM**. **PROGRAM** appears.
2. Using the number keys, press the number for the preprogrammed limit search range you want to change.

Note: To select bank 10, press 0.

3. Press **LIMIT**. **SEARCH BANK** and **Lo** appear, and a bar flashes under the selected search bank’s number.

Note: If you already entered your own limit search ranges in other search banks, a bar appears under each of those search bank numbers.

4. Use the number keys to enter the lower limit of the frequency range you want to search, then press **ENTER**.

Note: If you enter an invalid frequency in Step 4 or 6, the scanner displays **Error**. Simply repeat the step.

5. Press **LIMIT SEARCH BANK** and **Hi** appear.
6. Use the number keys to enter the upper limit of the frequency range you want to search, then press **ENTER**. The scanner replaces the preprogrammed limit search range with the range you selected.

Notes:

- To review your limit search ranges, turn **TUNING** one click for each search bank. A bar flashes under the selected search bank number, and either **Lo** or **Hi** appears. Press **LIMIT** to review the high and low limits of the frequency range for the selected search bank.
- If the limit search range is narrower than the frequency step, **-PASS-** appears on the display and the scanner does not search. To correct this, either press **STEP** to change the frequency step (see "Changing/Resetting the Frequency Step" on Page 35) or enter a wider frequency range in Steps 4 and 6.

DIRECT SEARCH

You can search up or down from the currently displayed frequency and store frequencies you like into monitor memories.

Notes:

- You can use the scanner's delay feature while using direct search. See "Delay" on Page 31.
- The scanner does not search locked-out frequencies during direct search.

1. Press **MANUAL** or **PROGRAM**.
2. Use the number keys to enter the frequency you want to start the search from. Or, use the number keys to enter the channel number containing the starting frequency and press **MANUAL** or **PROGRAM** again.

-
-
3. Press **DIRECT SEARCH**, **-d-**, and the starting frequency appear on the display.
 4. Press Δ or ∇ to search up or down from the selected frequency.

When the scanner finds an active frequency, it stops searching. To save the frequency into a monitor memory, press **MONITOR**. **MON** and the current monitor channel number appear on the display. Press Δ or ∇ again to continue searching for more active frequencies.

Notes:

- As the scanner automatically searches, you can also use the **TUNING** knob to search through frequencies manually by pressing **TUNE**, then turning the **TUNING** knob. Press **TUNE** again to continue the direct search.
- During direct search, you can manually change the frequency step or band mode. See "Changing/Resetting the Band Mode" or "Changing/Resetting the Frequency Step" on Page 35.

SCANNING THE CHANNELS

To begin scanning channels or to start scanning again after monitoring a specific channel, press **SCAN**.

Notes:

- You must store frequencies into channels before the scanner can scan them (see "Searching For and Storing Active Frequencies" on Page 19).
- The scanner does not scan empty channels.

The scanner scans through all channels (except those you have locked out) in the active banks (see "Locking Out Channels and Frequencies" on Page 32 and "Turning Channel-Storage Banks Off and On" below).

To change the scanning direction, either press Δ or ∇ , or rotate **TUNING** counterclockwise to scan down or clockwise to scan up.

TURNING CHANNEL-STORAGE BANKS OFF AND ON

To turn off banks while scanning, press the bank's number key until the bar under the bank's number disappears. The scanner does not scan any of the channels within the banks you have turned off.

Notes:

- You cannot turn off all banks. There must be at least one active bank.

-
- You can manually select any channel in a bank, even if the bank is turned off.

To turn on banks while scanning, press the bank's number key until a bar appears under the bank's number.

MOVING FREQUENCIES

Moving a Frequency from a Monitor Memory to a Channel

1. Press **PROGRAM**.
2. Use the number keys to enter the channel number where you want to store the monitor frequency, then press **PROGRAM**.
3. Press **MONITOR**. **MON** flashes. Use the number keys to enter the monitor memory's number, then press **MONITOR**. Or, turn **TUNING** to select the monitor memory's number.
MON flashes and the monitor memory's number and frequency appear.
4. Press **ENTER**. The scanner stores the frequency in the selected channel.
5. To move another monitor memory frequency to the next channel, turn **TUNING** to select the next channel and repeat Steps 3-4.

Moving Frequencies from Monitor Memories to a Bank

Your scanner can move all the frequencies you have stored in monitor memories into a bank you specify.

Notes:

- If there are more frequencies in the monitor memories than there are empty channels in the bank you select, the scanner moves only as many frequencies from the monitor memories as it has room for in the bank, leaving the remaining frequencies in the monitor memories.
- The scanner programs monitor memory frequencies into channels even if the same frequencies are already programmed into other channels.

1. Press **AUTO**. **AUTO** appears.
2. Using the number keys, press the bank number where you want to store monitor memory frequencies.

If you select a bank that contains at least one empty channel, a bar flashes under the bank number, and **AC-**, the number of empty channels in the bank, **Ch**, and **AUTO** appear.

Notes:

- To select bank 10, press 0.
- If you do not want to select the bank, press the bank's number again.

If you select a bank that does not contain any empty channels, a bar flashes under the bank number, and **A-FULL** and **AUTO** appear. To store new frequencies into this bank, you must delete one or more frequencies stored in it, then repeat Step 2. See "Deleting Frequencies" on Page 29.

3. Press and hold down **ENTER**, then press **MONITOR**. A bar flashes under the bank number, and **AC-**, the number of empty channels in the bank, **Ch**, and **AUTO** appear. The scanner moves all frequencies stored in monitor memories into the bank you specified in Step 2.

Moving Frequencies Within Banks

You can move all stored frequencies within a bank from higher channels to lower, empty channels. This helps you group all of the frequencies you stored in a bank into consecutive channels. For example, if you stored frequencies in channels 1 through 25, left channels 26 through 30 empty, then stored more frequencies in channels 30 through 40, the scanner can move all the frequencies together into channels 1 through 35.

1. Press **AUTO**. **AUTO** appears.
2. Using the number keys, select the bank's number.

3. Press and hold down **ENTER**, then press **RESET**. The scanner automatically moves all frequencies in channels within the bank in consecutive order to the lowest available channels within the bank.

Moving Frequencies from Banks to Monitor Memories

You can move all stored frequencies within a bank to monitor memories. This lets you quickly clear channels within a bank without losing the frequencies.

Caution: If you move frequencies from a bank to monitor memories, all frequencies already in the monitor memories are replaced with those frequencies and any empty channels from the bank.

1. Press **AUTO**. **AUTO** appears.
2. Using the number keys, select the bank's number.
3. Press and hold down **ENTER**, then press **.** (decimal). The scanner automatically moves all frequencies in channels within the bank to monitor memories.

DELETING FREQUENCIES

Deleting a Frequency from a Channel or Monitor Memory

1. Press **PROGRAM**.
2. Use the number keys to enter the channel number or monitor memory containing the frequency you want to delete.
3. If you are deleting the frequency in a channel, press **PROGRAM**.

If you are deleting the frequency in a monitor memory, press **MONITOR**.

4. Press **0**, then press **ENTER**. The frequency is deleted.

Note: You can delete all frequencies in all banks at the same time by resetting the scanner. See "Restarting/Resetting the Scanner" on Page 9.

Deleting Frequencies from All Locked-Out Channels Within a Bank

You can delete the frequencies in all locked-out channels within a bank (see "Locking Out Channels and Frequencies" on Page 32). This lets you delete all the old or uninteresting frequencies in channels you have locked out.

1. Press **AUTO**. **AUTO** appears.
2. Using the number keys, select the bank's number.
3. Press and hold down **ENTER**, then press **L/OUT**.

Deleting Frequencies from All Channels Within a Bank

You can delete the frequencies in all channels within a bank. This lets you quickly delete all frequencies from a bank if, for example, you want to use the bank to store a different category of frequencies.

1. Press **AUTO**. **AUTO** appears.
2. Using the number keys, select the bank's number.
3. Press and hold down **ENTER**, then press **CLEAR**.

SORTING FREQUENCIES WITHIN A BANK

You can sort the frequencies you have stored within a bank. The scanner moves the frequencies into consecutive channels in numerical order, either from the lowest to the highest frequency, or the highest to the lowest frequency. This makes it easy for you to see the range of frequencies you found, for example, during auto store.

Notes:

- During frequency sort, the scanner moves the frequencies it finds within the bank from higher channels to lower, empty channels.
 - If the bank you are sorting contains the channel you programmed as the priority channel (see "Priority" on Page 33), the scanner might replace the frequency in the priority channel with another frequency. If this happens, you must find the channel where the scanner moved the frequency, then re-designate it as the priority channel.
1. Press **AUTO**. **AUTO** appears.
 2. Using the number keys, select the bank's number.
 3. Press and hold down **ENTER**, then press \blacktriangle to sort channels from the lowest to the highest frequency, or press \blacktriangledown to sort channels from the highest to the lowest frequency. As the scanner sorts the frequencies, **Sort** appears on the display.
- If you turn the scanner off during frequency sort, the scanner saves the portion of the sort it completed.

SPECIAL FEATURES

DELAY

Many agencies use a two-way radio system that might have a pause of several seconds between a query and a reply. Your scanner's delay feature lets it wait for 2 seconds after each transmission on a channel or frequency while scanning or searching.

To program a 2-second delay for a channel while scanning, manually select the channel and press **DELAY** until **DELAY** appears. When your scanner stops on the channel, it waits for 2 seconds after each transmission on that channel before it resumes scanning.

To program a 2-second delay for any active frequency while searching, press **DELAY** until **DELAY** appears. When your scanner stops on a transmission, it waits for 2 seconds after each transmission on that frequency before it resumes searching.

USING THE ATT SWITCH

To reduce interference or noise caused by signals from a strong local broadcaster, you can reduce the scanner's sensitivity to signals by setting the **ATT** (attenuate) switch on the back of the scanner. Switch **ATT** to 10 dB to reduce the scanner's sensitivity, or to 0 dB to increase it.

Note: If you switch **ATT** to 10 dB, your scanner might not receive weak signals.

USING THE SOUND SQUELCH SWITCH

You can have the scanner skip frequencies that broadcast only a carrier signal without an accompanying *modulated* (data or voice) signal by setting the **SOUND SQUELCH** switch on the front of the scanner. When **SOUND SQUELCH** is turned on, the scanner continues scanning if it does not detect a modulated signal on a frequency within 0.5 seconds.

Notes:

- This feature works only while the scanner is scanning or searching, or when monitoring the priority channel.
- The sound squelch feature might not work properly if the monitored frequency contains a transmission with a low modulated signal.

To set sound squelch, press **SOUND SQUELCH** until the scanner beeps and the **SOUND SQUELCH** indicator turns on.

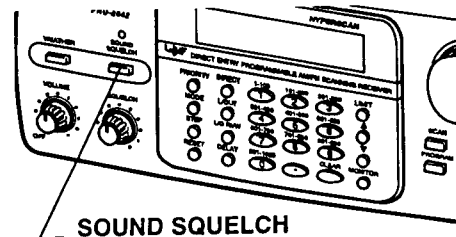

To turn off sound squelch, press **SOUND SQUELCH** again.

Note: If the scanner receives a frequency that broadcasts both a carrier and a modulated signal, it stops scanning and monitors the frequency.

If the modulated signal stops being broadcast on the frequency, the scanner stays on the frequency for 5 seconds, then resumes scanning.

If the carrier signal stops being broadcast on the frequency, the scanner resumes scanning immediately, unless **DELAY** is set.

LOCKING OUT CHANNELS AND FREQUENCIES

You can scan existing channels or search frequencies faster by locking out channels or frequencies that have a continuous transmission, such as a weather channel.

To lock out a channel while scanning, press **L/OUT** when the scanner stops on the channel. To lock out a channel manually, manually select the channel and press **L/OUT** until **LOCK-OUT** appears on the display.

To remove the lockout from a channel, manually select the channel and press **L/OUT** until **LOCK-OUT** disappears from the display.

Notes:

- You can delete the frequencies stored in locked-out channels within a bank. See "Deleting Frequencies from All Locked-Out Channels Within a Bank" on Page 29.
- You can still manually select locked-out channels.
- You cannot lock out all channels. There must be at least one active channel in each bank.

To lock out a frequency while searching, press **L/OUT** when the scanner displays the desired frequency. To lock out a frequency manually, manually select the frequency and press **L/OUT** until **LOCK-OUT** appears on the display.

To lock out a frequency during a limit or direct search, press **L/OUT** when the scanner stops on the frequency. The scanner locks out the frequency, then continues searching.

Notes:

- If you press **DIRECT**, **LIMIT**, or **TUNE**, then press **L/OUT**, the scanner will not lock out a channel or frequency. Choose another function, then try pressing **L/OUT** again.
- The scanner does not store locked-out frequencies during a limit or direct search.

-
- You can lock out as many as 200 frequencies. If you try to lock out more than 200 frequencies, **L-FULL** appears on the display.

Follow these steps to remove the lock-out from a frequency.

1. Press **TUNE**.
2. Repeatedly press **L/O RVW** until the frequency you want to remove the lockout from is displayed.
3. Press **L/OUT**. **LOCK-OUT** disappears from the display.

Reviewing Locked-Out Channels and Frequencies

You can review the channels or frequencies you locked out.

To review the channels you locked out, press **MANUAL**, then repeatedly press **L/O RVW**. As you press **L/O RVW**, the scanner displays all locked-out channels.

To review the frequencies you locked out, press **TUNE**, then press **L/O RVW**. The scanner sounds two short beeps, then displays **L-r**. As you rotate the **TUNING** knob, the scanner displays all locked-out frequencies. To return to the tune mode, press **L/O RVW** again.

Note: As you review locked-out frequencies, the scanner beeps when the display changes from the highest locked-out frequency to the lowest locked-out frequency.

Deleting All Locked-Out Frequencies

You can delete all locked-out frequencies at one time.

1. Press **TUNE**. **TUNE** appears on the display.
2. Press **L/O RVW**.
3. Press and hold down **CLEAR**, then press **LOCK-OUT**.

PRIORITY

With the priority feature, you can scan through programmed channels and still not miss an important or interesting call on a specific channel. You can program one stored channel as a priority channel.

Note: Before you first program your scanner, it automatically designates Channel 1 in Bank 1 as the priority channel.

Follow these steps to program a channel as the priority channel.

1. Press **PROGRAM**.
2. Use the number keys to enter the channel number you want to program as the priority channel, then press **PRIORITY**. **P** appears on the display to the left of the channel number.

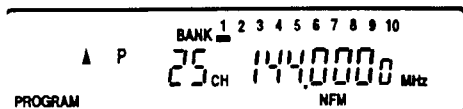

To turn on the priority feature, press **PRIORITY** during scanning. The scanner checks the priority channel every 2 seconds. It stays on the channel if there is activity, and **PRIORITY** appears.

To turn off the priority feature, press **PRIORITY**. **PRIORITY** disappears from the display.

MANUALLY SELECTING A CHANNEL

You can continuously monitor a specific channel without scanning. This is useful if you hear a broadcast on a channel and do not want to miss any details (even though there might be periods of silence) or if you want to monitor a locked-out channel.

Follow these steps to manually select a channel.

1. Press **MANUAL**.
2. Use the number keys to enter the channel number you want to hear, then press **MANUAL**.

Notes:

- If your scanner is scanning and stops at the channel you want, press **MANUAL** once.
- If you repeatedly press **MANUAL**, the scanner steps through the channels. To change the step direction, press either Δ or ∇ before you press **MANUAL**.

BAND MODE AND FREQUENCY STEP

The scanner scans in the following band modes:

- **AM** (amplitude modulation) — used in aircraft bands.
- **NFM** (narrowband frequency modulation) — used in action bands such as Marine, Amateur Radio, etc.
- **WFM** (wideband frequency modulation) — used in commercial FM broadcasts and television sound.

This table shows the preset band modes and frequency steps your scanner uses for each frequency range.

Frequency Range (MHz)	Band Mode	Frequency Step (kHz)
25.000 – 29.995	AM	5
30.000 – 87.495	NFM	5
87.500 – 107.950	WFM	50
108.000 – 136.9875	AM	12.5
137.000 – 224.995	NFM	5
225.000 – 400.000	AM	12.5
400.0125 – 520.000	NFM	12.5
760.000 – 1300.000	NFM	12.5

If you scan some of the 225-400 MHz and TV audio bands, you might have to manually change the band mode or frequency step.

Changing/Resetting the Band Mode

To change the displayed band mode while a frequency appears, press **MODE** until the desired band mode appears. The band mode flashes anytime it is different from the preset band mode. To reset the displayed band mode to its preset, press **RESET**.

Notes:

- You cannot change the band mode unless it appears on the display.
- Keep in mind that improperly changing the band mode can cause poor reception. For example, the sound is distorted when you listen to an FM broadcast or TV audio in the NFM mode or to an Amateur Radio in the WFM mode.

Changing/Resetting the Frequency Step

The scanner searches at a preset frequency step (5, 12.5 or 50 kHz) for each frequency range. However, if you search some of the 225–400 MHz and TV audio bands, you might have to manually change the frequency step.

When the scanner displays a frequency range, it also displays the frequency step. You can change the displayed frequency step while searching for frequencies or automatically storing frequencies.

To change the displayed frequency step, press **STEP** until the desired step appears. (The frequency step flashes anytime it is different from the preset frequency step.)

To change a displayed frequency step back to its preset value, press **RESET**.

Notes:

- You cannot change the frequency step unless it appears on the display.
- Keep in mind that improperly changing the frequency step can cause you to miss stations while scanning. For example, if you use a 50 kHz frequency step to search for broadcasts, and the band mode is set to NFM, you might miss frequencies between the 50 kHz steps.

A GENERAL GUIDE TO SCANNING

Reception of the frequencies covered by your scanner is mainly "line-of-sight." That means you usually cannot hear stations that are beyond the horizon.

During the summer months, you might be able to hear stations in the 30-50 MHz range located several hundred or even thousands of miles away. This is because of summer atmospheric conditions. This type of reception is unpredictable but often very interesting!

GUIDE TO FREQUENCIES

Ham Radio Frequencies

The following chart shows the voice frequencies that you can monitor.

Wavelength (meters)	Voice (MHz)	
10 – meter	28.300	29.700
6 – meter	50.100	54.000
2 – meter	144.100	148.000
70 – meter	420.000	450.000
23 – cm	1240.000	1300.000

Birdie Frequencies

Birdies are frequencies your scanner uses when it operates. These operating frequencies might interfere with broadcasts on the same frequencies. If you tune one of these frequencies, you hear only noise on that frequency.

If the interference is not severe, you might be able to turn **SQUELCH** clockwise to cut out the birdie. These are the most common birdies to watch for:

25.800 MHz	27.640 MHz	28.125 MHz	30.405 MHz	32.145 MHz
33.170 MHz	36.160 MHz	40.180 MHz	41.460 MHz	44.195 MHz
48.045 MHz	48.215 MHz	52.235 MHz	54.750 MHz	56.345 MHz
64.275 MHz	68.305 MHz	72.320 MHz	76.340 MHz	80.200 MHz
80.360 MHz	80.600 MHz	84.360 MHz	108.4825 MHz	112.500 MHz
116.525 MHz	120.5375 MHz	123.375 MHz	144.135 MHz	144.645 MHz
152.655 MHz	155.625 MHz	184.830 MHz	192.860 MHz	200.900 MHz
212.950 MHz	220.950 MHz	224.960 MHz	225.000 MHz	233.050 MHz
237.0125 MHz	241.075 MHz	249.1125 MHz	265.1875 MHz	299.5625 MHz
311.400 MHz	343.600 MHz	362.000 MHz	387.000 MHz	412.000 MHz
421.800 MHz	425.9125 MHz	466.250 MHz	467.250 MHz	490.375 MHz
491.375 MHz	772.200 MHz	773.400 MHz	774.600 MHz	907.5625 MHz
820.400 MHz	821.600 MHz	822.800 MHz	906.3125 MHz	1022.800 MHz
908.8125 MHz	1004.250 MHz	1008.600 MHz	1013.000 MHz	1090.400 MHz
978.500 MHz	1055.125 MHz	1068.4375 MHz	1074.600 MHz	1166.200 MHz
1025.6875 MHz	1117.6875 MHz	1152.750 MHz	1164.625 MHz	1281.250 MHz
1113.000 MHz	1186.800 MHz	1188.375 MHz	1196.125 MHz	
1182.4375 MHz	1227.000 MHz	1227.500 MHz	1251.875 MHz	
1200.250 MHz	1271.950 MHz			
1264.9375 MHz				

Note: Depending on the temperature of some of the scanner's components, you might hear birdies on frequencies slightly above or below the frequencies listed here.

Specified Intervals

Frequencies in different bands are accessible only at specific intervals. For example:

Band Type	Specified Interval (KHz)
VHF, HAM, and Government	5.0
Aircraft	25.0
All Others	12.5

Note: Your scanner automatically rounds the entered frequency down to the closest valid frequency. For example, if you try to enter a frequency of 151.473, your scanner accepts it as 151.470.

FREQUENCY CONVERSION

The tuning location of a station can be expressed in frequency (kHz or MHz) or in wavelength (meters). The following information can help you make the necessary conversions.

1 MHz (million)=1,000 kHz (thousand)

To convert MHz to kHz, multiply by 1,000.

30.62 MHz x 1000=30620 kHz

To convert from kHz to MHz, divide by 1,000.

$$\frac{127,800 \text{ kHz}}{1000} = 127.8 \text{ MHz}$$

To convert MHz to meters, divide 300 by the number of megahertz.

$$\frac{300}{171 \text{ MHz}} = 1.75 \text{ meters}$$

TROUBLESHOOTING

If your scanner is not working as it should, these suggestions might help you eliminate the problem. If the scanner still does not operate normally, take it to your local Tandy store for assistance.

Problem	Suggestion
Scanner is on, but will not scan.	Be sure SQUELCH is adjusted properly.
Scanner receives stations poorly or not at all.	<ul style="list-style-type: none">• Check the antenna (indoor or outdoor).• Signals may be blocked from being received by the scanner due to metal frames or material in the building. Change the scanner's location and try again.• Be sure frequencies are programmed properly and set with the correct mode (AM, NFM, or WFM).
Scanner's keys or display work poorly or not at all.	The scanner's processor might be locked. Restart the scanner. See "Restarting/Resetting the Scanner" on Page 9.
Scanner does not work at all.	Check the AC power cord and outlet.
Scanner locks on frequencies that have an unclear transmission.	Be sure birdie frequencies are not programmed, or listen to birdie frequencies manually. See "Birdie Frequencies" on Page 38.

CARE AND MAINTENANCE

Your Realistic by RadioShack PRO-2042 1000-Channel Programmable Home Scanner is an example of superior design and craftsmanship. The following suggestions will help you care for your scanner so you can enjoy it for years.



Keep the scanner dry. If it gets wet, wipe it dry immediately. Liquids can contain minerals that can corrode the electronic circuits.



Handle the scanner gently and carefully. Dropping it can damage circuit boards and cases, and can cause the scanner to work improperly.



Use and store the scanner only in normal temperature environments. Temperature extremes can shorten the life of electronic devices and distort or melt plastic parts.



Keep the scanner away from dust and dirt, which can cause premature wear of parts.



Wipe the scanner with a damp cloth occasionally to keep it looking new. Do not use harsh chemicals, cleaning solvents, or strong detergents to clean it.

Modifying or tampering with the scanner's internal components can cause a malfunction and might invalidate its warranty and void your unit's authorization to operate it. If your scanner is not operating as it should, take it to your local Tandy store for assistance.

SPECIFICATIONS

Frequency Coverage:

HF Hi	25–28 MHz (in 5 kHz steps)
Amateur Radio	28–29.7 MHz (in 5 kHz steps)
	50–54 MHz (in 5 kHz steps)
	144–148 MHz (in 5 kHz steps)
	222–225 MHz (in 5 kHz steps)
	420–450 MHz (in 12.5 kHz steps)
	1240–1300 MHz (in 12.5 kHz steps)
FM-TV Audio	54–72 MHz (in 5 kHz steps)
	76–87.5 MHz (in 5 kHz steps)
	87.5–107.95 MHz (in 50 kHz steps)
	174–216 MHz (in 5 kHz steps)
Amateur Radio/Government.....	406–450 MHz (in 12.5 kHz steps)
Aircraft	108–136.995 MHz (in 12.5 kHz steps)
	225–406 MHz (in 12.5 kHz steps)
Government	137–144 MHz (in 5 kHz steps)
	406–450 MHz (in 12.5 kHz steps)
VHF Hi	148–174 MHz (in 5 kHz steps)
	216–224.995 MHz (in 5 kHz steps)
UHF	450–470 MHz (in 12.5 kHz steps)
	470–520 MHz (in 12.5 kHz steps)
	760–805.995 MHz (in 12.5 kHz steps)
	806–956 MHz (in 12.5 kHz steps)
VHF Lo	29.7–50 MHz (in 5 kHz steps)
	72–76 MHz (in 5 kHz steps)
	956–1240 MHz (in 12.5 kHz steps)

General:

Channels of Operation 1100 Channels in Any Band Combinations
(100 channels per bank x 10 banks and 100 Monitor Channels)

Sensitivity:

AM (20 dB S/N with 60% modulation)

25-520 MHz 2 μ V
760-1000 MHz..... 2 μ V
1000.005-1300 MHz 5 μ V

NFM (20 dB S/N at 3 kHz deviation)

25-520 MHz 0.5 μ V
760-1000 MHz..... 0.5 μ V
1000.005-1300 MHz 3 μ V

WFM (30 dB S/N at 45 kHz deviation)

25-520 MHz 3 μ V
760-1000 MHz 3 μ V
1000.005-1300 MHz 10 μ V

Selectivity:

AM

\pm 6 kHz -6 dB
 \pm 12 kHz -50 dB

NFM

\pm 10 kHz -6 dB
 \pm 20 kHz -50 dB

WFM

\pm 150 kHz -6 dB
 \pm 300 kHz -50 dB

Scanning Rate Up to 50 channels/second

Search Rate Up to 50 steps/second

Automatic Memory Rate Up to 25 steps/second

Delay Time 2 seconds

Priority Sampling 2 seconds

Intermediate Frequencies (IF)

1st 609.005-613.5 MHz
2nd 48.5 MHz
3rd for Wide FM 10.7 MHz
3rd for Narrow FM and AM..... 455 kHz

IF Rejection	
612 MHz at 70 MHz (NFM)	60 dB
612 MHz at 1000 MHz (NFM)	60 dB
Squelch Sensitivity:	
AM/NFM Threshold	
25–520 MHz	0.5 μ V
760–1000 MHz	0.5 μ V
1000.005–1300 MHz	3 μ V
AM/NFM Tight	
25–520 MHz	25 dB
760–1000 MHz	25 dB
1000.005–1300 MHz	20 dB
WFM Threshold	
25–520 MHz	3 μ V
760–1000 MHz	3 μ V
1000.005–1300 MHz	15 μ V
WFM Tight	
25–520 MHz	40 dB
760–1000 MHz	40 dB
1000.005–1300 MHz	40 dB
Antenna Impedance	50 Ohms
Audio Output Power	
 Jack	16 mW
EXT SPKR Jack	1.8 Watts
TAPE OUT Jack	(Z=10 kohm) 600 mV Nominal
Built-In Speaker	3 Inches (77 mm), 8 Ohms, dynamic type
Audio Output Power (10%THD)	1.3 Watts Nominal
Power Requirements	
AC	230 Volts, 50 Hz, 18 Watts (for U.K.)
.....	240 Volts, 50 Hz, 18 Watts (for Australia)
DC	13.8 Volts, 10 Watts
Dimensions	90 x 232 x 210 mm HWD
	(3 ¹ / ₂ x 9 ¹ / ₈ x 8 ¹ / ₁₆ Inches)
Weight	2 kg (4 lbs 6.5 oz)

Specifications are typical; individual units might vary. Specifications are subject to change and improvement without notice.

NOTES



InterTAN WARRANTY

InterTAN warrants that this product will be free from defects in materials and workmanship for a period of one (1) year from the date of purchase. Within this period, simply take the product and your proof of purchase to any InterTAN store or dealer and the product will be repaired without charge for parts and labour. InterTAN reserves the right to charge for transportation. Any product which has been subject to misuse or accidental damage is excluded from this warranty.

This warranty is only applicable to a product purchased through InterTAN's company owned stores and dealers and to a product that is presented for repair in a country where InterTAN offers the product for sale. While this warranty does not confer any legal rights other than those set out above, you may have additional statutory rights which will vary under the laws of the various countries, states, provinces and other governmental entities in which InterTAN operates. This warranty is subject to all statutory rights you may have in the country of purchase.

WE SERVICE WHAT WE SELL

**MANUFACTURED IN JAPAN. IMPORTED FOR/IMPORTE POUR
InterTAN CANADA LTD., BARRIE, CANADA, L4M 4W5
InterTAN AUSTRALIA LTD., A.C.N. 002 511 944
InterTAN U.K. LTD., WEST MIDLANDS, WS2 7PS
REGISTERED TRADEMARK LICENSED BY RADIOSHACK
DIVISION OF TANDY CORPORATION (USA)**

GE-96D-2018

8A6

Printed in Japan

Free Manuals Download Website

<http://myh66.com>

<http://usermanuals.us>

<http://www.somanuals.com>

<http://www.4manuals.cc>

<http://www.manual-lib.com>

<http://www.404manual.com>

<http://www.luxmanual.com>

<http://aubethermostatmanual.com>

Golf course search by state

<http://golfingnear.com>

Email search by domain

<http://emailbydomain.com>

Auto manuals search

<http://auto.somanuals.com>

TV manuals search

<http://tv.somanuals.com>