

OWNER'S MANUAL

PRO-2006
Programmable Scanner

Please read before using this equipment

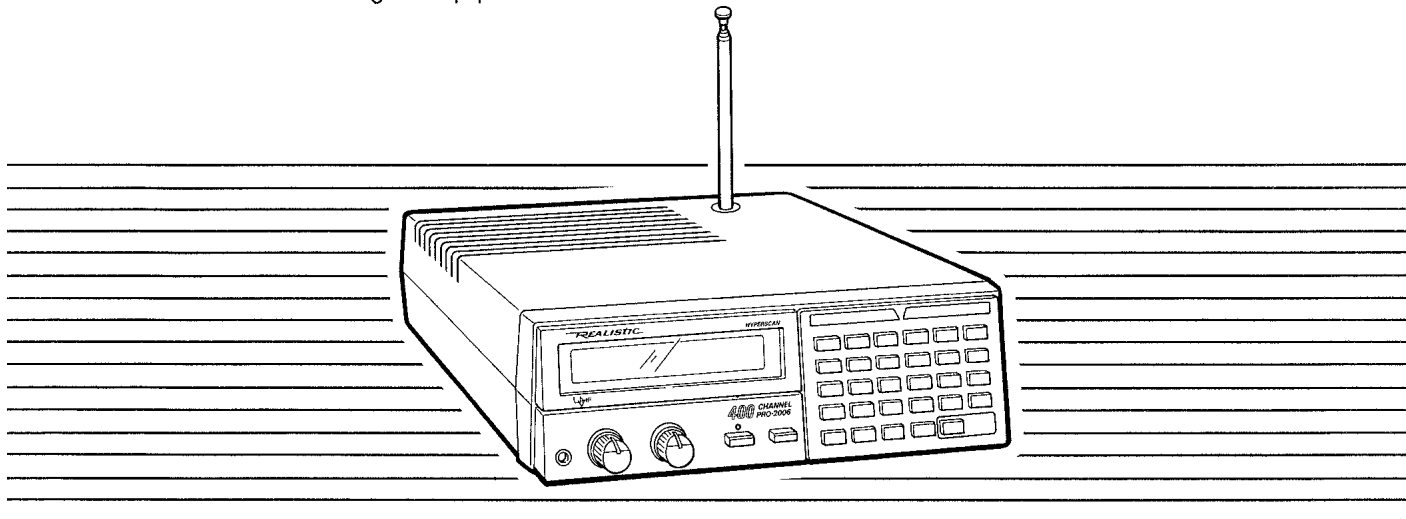

Cat. No. 20-145A

REALISTIC®

Your new Realistic PRO-2006 Desk-Top Programmable Scanner lets you in on all the action! Your scanner gives you direct access to over 196,000 frequencies in nine action-packed radio bands including police, fire, ambulance, aircraft, ham radio, and transportation services, in addition to normal FM broadcasts, TV sound, and CB. You can select up to 400 channels for your scanner to scan through, and you can change your channel selection at any time.

The secret of your PRO-2006 scanner is a custom-designed microprocessor—a computer-on-a-chip—that allows you to instantly select any frequency without having to change any crystals. This microprocessor also gives your scanner special functions, such as:

Liquid Crystal Display—shows the channel and the frequency you have selected, as well as other information.

Two-Second Scan Delay— helps to prevent your losing replies on a channel while you are scanning.

Memory Backup—keeps the channel frequencies stored in your scanner's memory if a power failure occurs.

Lock-Out Function—lets your scanner skip over a specified channel or group of channels.

Ten Channel Storage Banks—allow you to group your stored frequencies so that calls are easier to identify.

Priority Channel—helps to keep you from missing important calls on the selected channel.

Direct Frequency Search—allows you to scan through every available frequency to find interesting broadcasts.

Monitor Banks—allows you to save up to ten additional channels located during a frequency search.



Sound Squelch—keeps the scanner from stopping on a channel that is only broadcasting a carrier, with no voice or other sound.

Your PRO-2006 scanner covers a wide frequency range:

- 25 – 520 MHz
- 760 – 823.945 MHz
- 851 – 868.945 MHz
- 896 – 1300 MHz

© 1990 Tandy Corporation.
All Rights Reserved.

Realistic and Radio Shack are registered trademarks of Tandy Corporation.

	CAUTION RISK OF ELECTRIC SHOCK DO NOT OPEN	
CAUTION: TO REDUCE THE RISK OF ELECTRIC SHOCK, DO NOT REMOVE COVER (OR BACK). NO USER-SERVICEABLE PARTS INSIDE. REFER SERVICING TO QUALIFIED SERVICE PERSONNEL.		

WARNING: TO PREVENT FIRE OR SHOCK HAZARD, DO NOT EXPOSE THIS RECEIVER TO RAIN OR MOISTURE.

For your important records, please record your scanner's serial number in the box below. The serial number is located on the back panel of your scanner.



The lightning flash with arrowhead within the triangle is intended to alert you to dangerous voltage inside this unit that can cause shock. Do not open enclosure.



The exclamation point within the triangle is intended to alert you to important operating and maintenance instructions in this owner's manual.

Serial Number: _____

CONTENTS

A Quick Look at Your Scanner.....	5	Using the Delay Feature	24
Preparation	7	Setting the Scanning Speed	24
Battery Installation	7	Looking Out Channels	24
Power Sources	8	Turning Banks On and Off	25
AC Power Operation	8	Using the Priority Feature	25
Car Battery Operation.....	8	Manually Selecting a Channel	25
Connecting the Antenna	9	Using the Light Switch	25
Using the Folding Feet	10	A General Guide to Scanning	26
Connecting Headphones	10	Birdies	26
Connecting an Extension Speaker	10	Cross Modulation	26
Connecting an External Tape Recorder	11	Reception Notes	26
Understanding Your PRO-2006 Scanner	12	Guide to the Action Bands	27
A Look at the Display	12	Typical Band Usage	28
A Look at the Keyboard	14	Maintenance	30
Understanding Channel Storage Banks and Search Banks	16	Before You call for Help	31
Operation	17	If You Have Problem	31
Programming the PRO-2006 Scanner	17	Specifications	32
Searching for Active Frequencies	18		
Moving a Frequency from a Monitor Memory to a Channel	21		
Understanding Band Modes and Frequency Steps	22		
Using the Restart Switch	23		
Setting the Volume and Squelch	23		
Using the Sound Squelch Switch	23		
Scanning the Channels	23		

A QUICK LOOK AT YOUR SCANNER

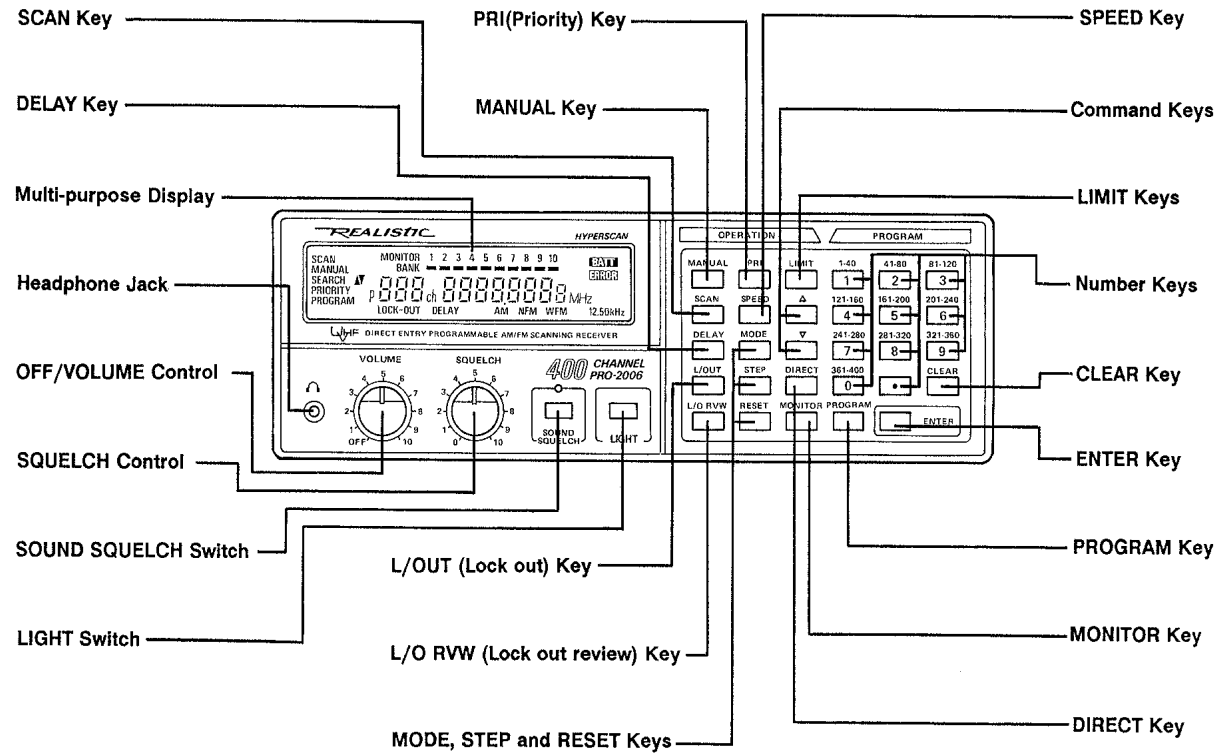

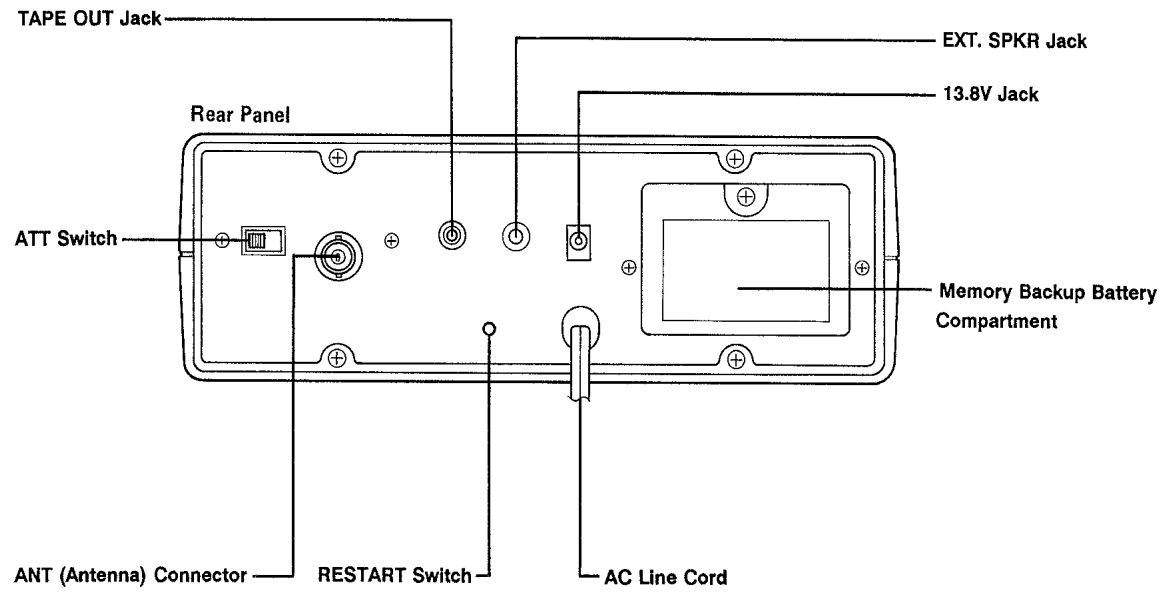

PREPARATION

BATTERY INSTALLATION

Your scanner uses a 9-volt battery for memory backup. For longest operation and best performance, we recommend an alkaline battery, such as Radio Shack's Cat. No. 23-553. For best results, replace the battery every six months.

"BATT" flashes in the display and beeps sound when the battery is low or not installed. When this happens, replace or install the battery immediately.

Caution: Your scanner can keep channels stored in its memory for a few minutes even with the AC cord unplugged and the 9-volt battery disconnected. But, to avoid loss of memory information, do not unplug the scanner when replacing the battery.

In addition, never leave a weak or dead battery in your scanner; even "leakproof" batteries can leak damaging chemicals. Battery life is about six months when household AC power or automotive DC power is off for a prolonged period of time.

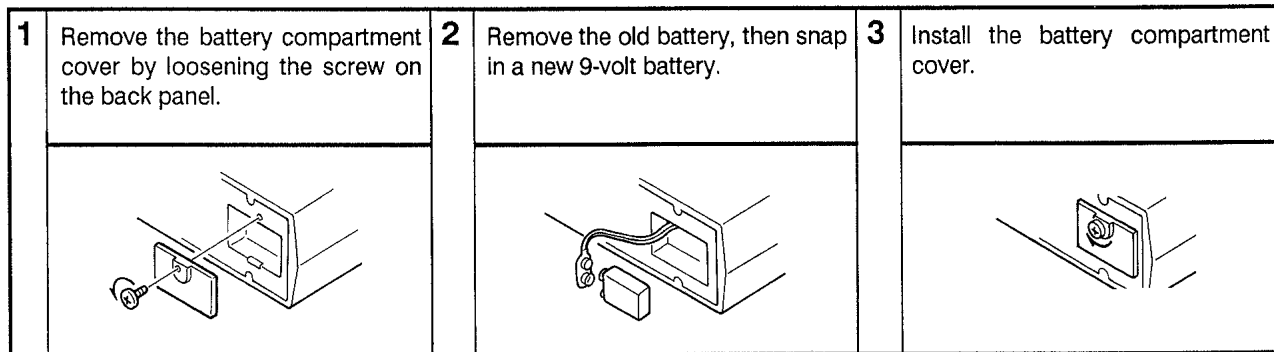

POWER SOURCES

You can power your scanner from the following sources:

- A standard AC outlet
- Your vehicle's battery (using an optional DC power cable)

AC Power Operation

Connect the scanner's AC power cord to a standard AC outlet.

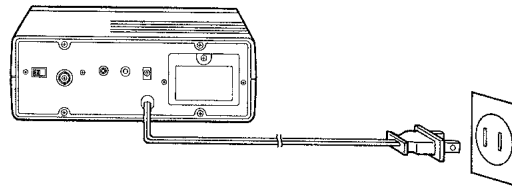

Car Battery Operation

You can power your scanner from your vehicle's cigarette lighter socket, provided the vehicle has a 12 volt, negative ground system. To use DC power, you need Radio Shack's DC power cable (Cat. No.270-1534B).

Connect the DC power cable's plug to the 13.8 volt jack on the rear panel. Then, plug the DC power cable into the cigarette lighter socket of your vehicle.

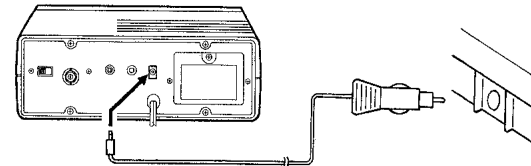

Note: Mobile use of scanners might be unlawful or require a permit in some areas. Check with your local authorities.

CONNECTING THE ANTENNA

We have provided a telescoping antenna with your scanner. This antenna is adequate for strong local signals. To install it, simply screw it into the hole on the top of the scanner.

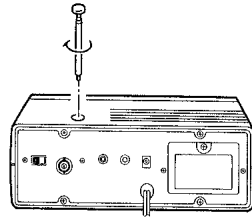

Antenna length controls the sensitivity: adjust the length of the telescoping antenna for best reception. Refer to the table below.

25 MHz – 300 MHz	extend fully
300 MHz – 520 MHz	extend 3 segments
760 MHz – 1300 MHz	collapse fully (one segment only)

Your scanner has better reception when you attach a multi-band outdoor antenna to it. Radio Shack stores sell a complete line of outdoor scanner antennas.

To install an outdoor antenna:

1. Select a location for the outdoor antenna that is as high as possible.
2. Following the instructions that came with the antenna and its mounting hardware, mount the antenna.
3. Connect the antenna to the scanner using coaxial cable. Always use 50 ohm coaxial cable. For lengths over 50 feet, use RG8 low-loss, dielectric coaxial cable.

WARNING WARNING WARNING

When installing or removing outdoor antennas, use extreme caution. If the antenna starts to fall, let it go! It could contact overhead power lines. IF THE ANTENNA TOUCHES THE POWER LINE, CONTACT WITH THE ANTENNA, MAST, CABLE, OR GUY WIRES CAN CAUSE ELECTROCUTION AND DEATH! Call the power company to remove the antenna. Do not attempt to do so yourself.

USING THE FOLDING FEET

Your scanner's front feet are folding type. Use them according to the location of the scanner.

CONNECTING HEADPHONES

For private listening or in a noisy environment, plug headphones into the headphone jack on front of your scanner. Plugging in headphones automatically disconnects the internal speaker. We recommend Radio Shack's mono headset (Cat. No. 20-210).

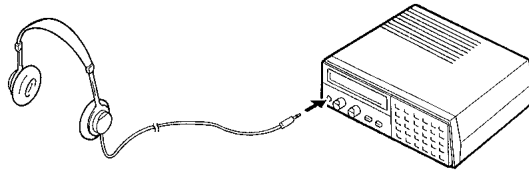

CONNECTING AN EXTENSION SPEAKER

In a noisy area, an extension speaker (such as Radio Shack's Cat. No. 21-549), positioned in the right place, might provide more comfortable listening. Plug the speaker cable's 1/8-inch mini-plug into your scanner's EXT SPKR jack.

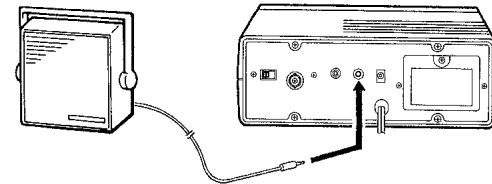

CONNECTING AN EXTERNAL TAPE RECORDER

You can record scanner transmissions with a tape recorder through the TAPE OUT jack. Consult your local Radio Shack store for the appropriate connecting cable.

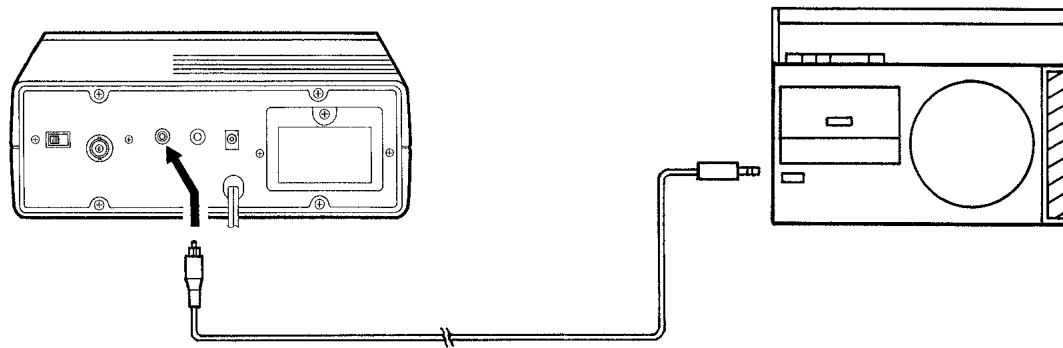

UNDERSTANDING YOUR PRO-2006 SCANNER

A LOOK AT THE DISPLAY

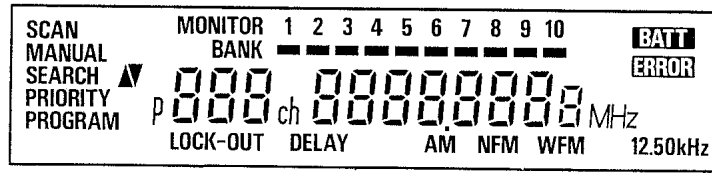

The display has several abbreviated indicators that show your scanner's current operating mode. A quick look at the display will help you understand how your scanner operates.

The above illustration shows your scanner's display with all the indicators on. The following is a brief explanation of the indicators.

BANK—bars to the right of this indicator show which memory banks are currently turned on for the scan mode. See "Understanding Channel Storage Banks and Search Banks."

SCAN—comes on when the scanner is in the scan mode.

DELAY—appears when the scanner is on a channel that you have programmed with the delay feature. See "Using the Delay Feature."

LOCK-OUT—appears when the channel you are listening to is locked out of the scan mode. See "Locking Out Channels."

MANUAL—comes on when the scanner is in the manual channel selection mode.

ch—digits preceding this indicator show which channel the scanner is currently tuned to.

MHz—digits preceding this indicator show the frequency the scanner is currently tuned to.

MONITOR—appears when the scanner is in the monitor mode. See "Moving a Frequency from a Monitor Memory to a Channel."

PRIORITY—appears when you have turned on the priority channel feature.

PROGRAM—appears when the scanner is ready for programming.

BATT—flashes when the batteries need to be installed or replaced.

P—appears when you are listening to the priority channel.

SEARCH—appears during a limit search or a direct frequency search. ▲ and ▼ also appear in the display to show the direction of the search.

AM, NFM, WFM—shows which band mode is currently selected. See "Understanding Band Modes and Frequency Steps."

5, 12.5, 50—shows which frequency step is currently selected. See "Understanding Band Modes and Frequency Steps."

A LOOK AT THE KEYBOARD

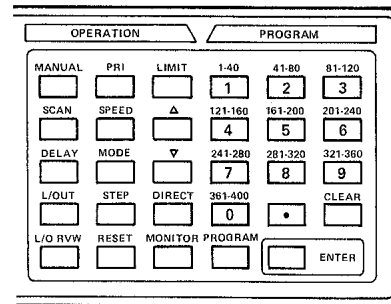

The keys on your scanner might seem cryptic at first, but a quick glance at this page should help you understand each key's function.

Number Keys—each have a single digit, and a range of numbers printed above it. The single digit is the number entered when you are entering a channel number or a frequency. The range of numbers (1-40, for example) shows the channels that make up a memory bank. See "Understanding Channel Storage Banks and Search Banks."

SCAN—causes your scanner to scan through the programmed channels.

MANUAL—stops scanning and allows you to directly enter a channel number.

CLEAR—deletes an incorrect entry.

L/OUT—turns on the lockout function. See "Locking Out Channels."

L/O RVW—recalls locked out channels sequentially.

DELAY—turns the delay feature on or off for the current channel.

SPEED—changes the scanning and search speed.

MONITOR—is used to access the monitor memories. See "Moving a Frequency from Monitor Memory to a Channel."

PRI—selects the priority channel.

PROGRAM – is used when programming frequencies into channels.

ENTER – used to enter the frequency when programming channels.

LIMIT, ▲, and ▼ – are used during frequency searching. See "Searching for Active Frequencies."

DIRECT – starts the direct search.

MODE – changes the band mode in the following order: AM–NFM–WFM.

STEP – used to change frequency steps in the following order: 5 kHz–12.5 kHz–50 kHz.

RESET – initializes band mode and frequency step.

UNDERSTANDING CHANNEL STORAGE BANKS AND SEARCH BANKS

Your scanner can store up to 410 frequencies. You store each frequency in either a permanent memory, called a *channel*, or a temporary memory, called a *monitor*. The scanner has 400 channels and ten monitor memories.

To make it easier to identify and select the channels you want to listen to, channels are divided into ten groups of 40 channels. Each group of channels is called a bank. Perhaps the best way to explain the use of memory banks is through a practical example.

Suppose you want to monitor four different agencies: police, fire, ambulance, and aircraft. As a rule, each agency has several different frequencies they use for different purposes. The police might have four frequencies, one for each side of town. To make it easier to quickly determine which agency you are listening to, you could program the police frequencies starting with Channel 1 (Bank 1). Then, start the fire department on Channel 41 (Bank 2), ambulance service on Channel 81 (Bank 3), and aircraft frequencies on Channel 121 (Bank 4).

Now, when you want to listen to only fire calls, it is simple to turn off Banks 1 and 3 through 10 so that only Bank 2 is scanned. You could also use this feature to group the channels by city or by county. Simply press the number

corresponding to the bank you want to turn on or off. The bar below the number in the display shows that bank is on.

Your scanner also has ten temporary monitor memories. You use these memories to store frequencies temporarily, while you decide whether to save them in one of the permanent channels. This is handy for quickly storing an active frequency when you are searching through an entire band. See "Searching for Active Frequencies."

When you are in the monitor mode, the ten numbers at the top of the display represent the ten monitor memories. The flashing number shows the current monitor memory.

In addition, your scanner has ten search banks. You can use these banks to store your selected limit search ranges. See "Searching for Active Frequencies."

OPERATION

PROGRAMMING THE PRO-2006 SCANNER

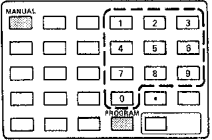
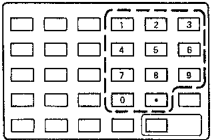
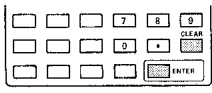
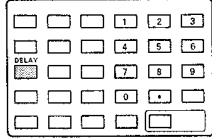
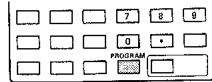

1	<p>Select a channel to program by pressing [MANUAL], and entering the channel number you want to program. Then, press [PROGRAM]. "PROGRAM" appears in the display to indicate that your scanner is in the programming mode.</p>	
2	<p>Enter a frequency. A good reference for active frequencies is Radio Shack <i>Police Call Directory Including Fire and Emergency Services</i>. We update this directory yearly, so be sure to get a current one. Also refer to "Reception Notes" and "Searching for Active Frequencies" in this manual.</p>	
3	<p>Press [ENTER]. This stores the frequency. If you made a mistake in Step 2, "Error" appears in the display and three beeps sound. Press [CLEAR] and proceed again from Step 2.</p>	
4	<p>Press [DELAY]. If you want your scanner to pause after each transmission before scanning to the next channel, press [DELAY]. "DELAY" appears in the display. If you do not want your scanner to pause, press [DELAY] again. "DELAY" disappears from the display.</p>	
5	<p>Repeat Steps 1–4 to program more channels. NOTE: If you want to program the next channel in sequence, just press [PROGRAM] and proceed to Step 2.</p>	

SEARCHING FOR ACTIVE FREQUENCIES

Use these procedures to search for a transmission. This is helpful if you do not have a reference to frequencies in your area. Also, see "Guide to the Action Bands" in this manual.

Limit Search

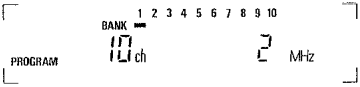
The limit search procedure allows you to search within a range of frequencies. You can store up to ten limit search ranges in the search banks.

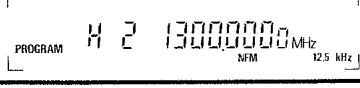
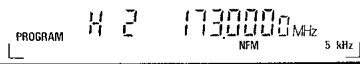
1	Press [PROGRAM], and the search bank number in which you wish to store the limit search range. Press [0] for bank number 10.	 <p>The display shows a row of numbers 1 through 10 under the label 'BANK'. The number '10' is highlighted. Below it, 'PROGRAM' is displayed, followed by '10 ch' and '2 MHz'.</p>
2	Press [LIMIT]. "L" and the search bank number appears in the display.	 <p>The display shows 'PROGRAM' followed by 'L 2' and '250000 MHz'. 'AM' is displayed below the frequency.</p>
3	Enter the lower limit of the frequency range. Then, press [ENTER].	 <p>The display shows 'PROGRAM' followed by 'L 2' and '1500000 MHz'. 'NFM' and '5 kHz' are displayed below the frequency.</p>
4	Press [LIMIT]. "L" changes to "H" in the display.	 <p>The display shows 'PROGRAM' followed by 'H 2' and '1300000 MHz'. 'NFM' and '12.5 kHz' are displayed below the frequency.</p>
5	Enter the upper limit of the frequency range. Then, press [ENTER].	 <p>The display shows 'PROGRAM' followed by 'H 2' and '1730000 MHz'. 'NFM' and '5 kHz' are displayed below the frequency.</p>

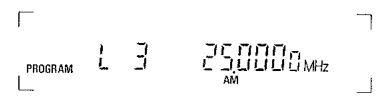
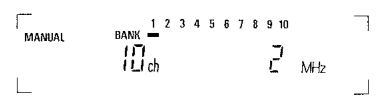
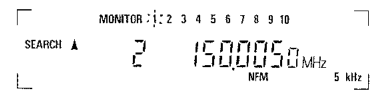
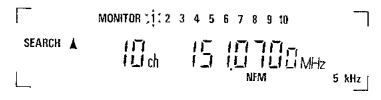
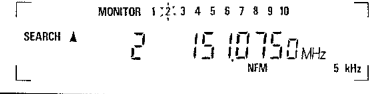
6	Repeat steps 1–5 to store the limit-search range into the search banks. You can store up to 10 limit-search ranges.	
7	To recall a limit-search range, press the appropriate bank number.	
8	Press [▼] to search from the upper limit down to the lower limit. Or press [▲] to search upward starting from the lower limit.	
9	When the scanner stops on a transmission, press [MONITOR] to store the frequency in the current monitor memory. The memory number flashing on the display indicates the current monitor memory.	
10	To continue the search, press [▼] or [▲].	

Notes:

- Press [SPEED] to speed up or slow down the search.
- Press [DELAY] to make the scanner pause 2 seconds after a transmission, before proceeding to the next frequency.

Limit-Search Memory

When you change your scanner's mode from limit search to manual, program, scan, direct search, and so on, your scanner retains the last frequency before you change the mode. Your scanner resumes the search from that frequency when you change the mode to limit search again.

Note: You can change the upper or lower limit frequency without affecting the memorized frequency if the frequency is within the new limit range. If the frequency is out of the new limit range, the search starts from the new upper or lower limit frequency.

Direct Search

When you are in program or manual mode, you can search up or down from the current frequency.

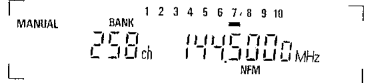
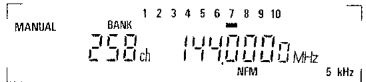
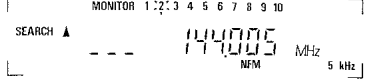
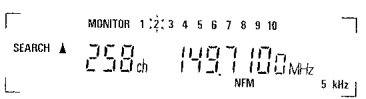
<p>1 Select a currently programmed channel by pressing [MANUAL], and the channel number. Then, press either [MANUAL] or [PROGRAM].</p>	 <p>MANUAL BANK 1 2 3 4 5 6 7 8 9 10 258 ch 144.5000 MHz NFM</p>
<p>2 Press [DIRECT]. The step frequency appears in the display.</p>	 <p>MANUAL BANK 1 2 3 4 5 6 7 8 9 10 258 ch 144.0000 MHz NFM 5 kHz</p>
<p>3 Press [▲] to search through higher frequencies or [▼] to search through lower frequencies.</p>	 <p>MONITOR 1 2 3 4 5 6 7 8 9 10 SEARCH ▲ --- 144.0000 MHz NFM 5 kHz</p>
<p>4 When the search stops on a transmission, you can store that frequency into a monitor memory by pressing [MONITOR]. The memory number flashing on the display indicates the current memory number. To continue the search, press [▼] or [▲].</p>	 <p>MONITOR 1 2 3 4 5 6 7 8 9 10 SEARCH ▲ 258 ch 149.1000 MHz NFM 5 kHz</p>

Notes:

- When you press [DIRECT] during limit, your scanner enters direct search mode.
- When you press a numeric key during a direct search, your scanner changes to limit search mode. The key you press corresponds with the limit-search bank number.

MOVING A FREQUENCY FROM A MONITOR MEMORY TO A CHANNEL

As you store frequencies in monitor memories, the memory number flashing on the display shows the current monitor memory. You can listen to monitor memories by pressing [MANUAL], [MONITOR], then the number of the monitor memory you want to listen to.

If there is a frequency you wish to transfer to a channel, follow this procedure to move it from the monitor memory:

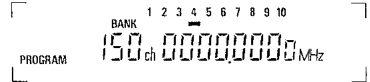
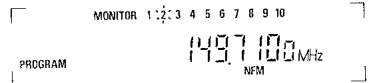
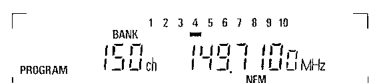
1	Press [MANUAL], and the channel number in which you want to store the frequency. Then, press [PROGRAM].	
2	Press [MONITOR], and the memory number you want to move.	
3	Press [ENTER]. The scanner stores the frequency in the channel you entered.	

If you want to return to a limit search after this procedure, either [▲] or [▼] to continue searching. press [LIMIT], and the search bank number. Then, press

UNDERSTANDING BAND MODES AND FREQUENCY STEPS

We designed your scanner to adjust itself for the band modes and frequency steps for each frequency range. Default settings are as shown below.

FREQUENCY VS. MODE AND STEP

FREQUENCY (MHz)	MODE	STEP (kHz)
25.000 – 29.995	AM	5
30.000 – 87.495	NFM	5
87.500 – 107.995	WFM	50
108.000 – 135.995	AM	12.5
136.000 – 224.995	NFM	5
225.000 – 520.000	NFM	12.5
760.000 – 1300.000	NFM	12.5

WFM: Wideband FM for normal FM broadcasts or TV sound.

NFM: Narrowband FM for action radio bands, police, fire, ambulance, ham radio, and so on.

AM: For aircraft band, CB, and so on.

Normally, the preset mode/step works within each band as shown above. However, for some of the ham radio, military aircraft (225–400 MHz), and TV audio (WFM) bands, you must change the mode or step manually. To change the band mode, press [MODE] when your scanner is in manual mode. To change the frequency step, press [STEP] in search mode. Note that when you change the preset modes/steps, the corresponding indicator flashes to show you that you changed the default setting.

When you want to return to the default setting, press [RESET]. The display stops flashing.

Keep in mind that improperly setting the modes or steps can cause poor reception. When you listen to an FM broadcast or TV sound in the NFM mode, the sound is very distorted. If you monitor police band in WFM mode, the sound is masked by noise. Or if you use 5 kHz or 12.5 kHz steps to search for FM broadcasts or TV sound, the search might stop on the sideband of the frequency. In that case, press [▲] or [▼] to get the center frequency. If you use 50 kHz steps for NFM band, you might miss the frequencies between the 50 kHz steps.

USING THE RESTART SWITCH

The scanner's display might lock up the first time you plug in and turn on your scanner, or if the battery is left out for an extended period of time. If the display locks, use a pointed object, like a paper clip, to press and release the restart switch while power is on.

To clear all the memories, be sure the scanner is turned on and:

1. Press and hold [CLEAR].
2. Using a pointed object, press and release the restart switch.
3. After confirming that the display goes blank, release [CLEAR].

SETTING THE VOLUME AND SQUELCH

Turn VOLUME clockwise and SQUELCH counterclockwise until you hear a hissing sound. Then, slowly turn SQUELCH clockwise until the noise stops. Leave VOLUME set to a comfortable listening level.

If the scanner picks up unwanted weak transmissions, turn SQUELCH clockwise to decrease the scanner's sensitivity to these signals.

USING THE SOUND SQUELCH SWITCH

If the scanner stops at a transmission during scan, search, or priority modes, the [SOUND SQUELCH] switch lets the

scanner start scanning again if the transmission contains no sound (carrier only without modulated signals).

If your scanner stops at a frequency that has no sound, press [SOUND SQUELCH]. The indicator lights. If the scanner detects no sound within 0.5 seconds, it goes to the next transmission.

When the scanner receives a frequency that contains sound, it halts at the frequency. If the sound ceases, the scanner stays on the frequency for 5 seconds, and resumes scanning. If the carrier stops, the scanner begins to scan immediately if the delay function is off, or after 2 seconds if the delay function is on.

To cancel sound squelch, press [SOUND SQUELCH] again. The indicator goes off.

Note: If a frequency contains a transmission with low modulation, the sound squelch circuit might not work properly.

SCANNING THE CHANNELS

To begin scanning channels, just press [SCAN]. Your scanner scans through all the channels that you have not locked out of the banks that are turned on. You must set SQUELCH so that you do not hear the hissing sound between transmissions. Be sure to read the following sections to get the full benefit from the special features of your scanner.

USING THE DELAY FEATURE

Many agencies use two-way radio systems that might have a period of several seconds between a query and a reply. To keep from missing a reply, program a delay on the channels you identify as operating this way. To program a delay, manually select the channel, and press [DELAY]. "DELAY" appears in the display. Now, when you are scanning through channels, your scanner pauses for two seconds after the completion of each transmission on that channel before resuming scanning.

Some radio systems, especially those above 800 MHz, use a special "trunked" system. In these systems, the transmitter selects an available frequency each time the operator keys the radio. Therefore, it is possible for the query to be on one frequency and the reply on another. To ensure the best possibility of hearing the full reply, you want the scanner to begin scanning immediately when the first transmission ends. In this case, select the channel manually and ensure that "DELAY" is not in the display. If "DELAY" is indicated, press [DELAY] to turn off this feature for that channel.

SETTING THE SCANNING SPEED

Your scanner has two different scanning speeds – 13 channels per second and 26 channels per second. To switch between the two scanning speeds, press [SPEED] during scanning.

LOCKING OUT CHANNELS

You can increase the effective scanning speed by locking out channels that you have not programmed. Manually select the channel, and then press [L/OUT], so that "LOCK-OUT" appears in the display. This is also handy for locking out channels that have a continuous transmission, such as a weather channel. You can still manually select locked-out channels for listening.

To disable the lock-out function, manually select the channel and press [L/OUT]. Or, press [L/O RVW] in manual or program mode to call out locked-out channels one by one. Then, press [L/OUT] again.

Note: You can lock out as many channels as you like. But there must be at least one channel that you have not locked out in each bank.

TURNING BANKS ON AND OFF

As explained in "Understanding Channel Storage Banks and Search Banks" your scanner splits the 400 channels into ten banks of forty channels each. The small bars under the numbers at the top of the display are the bank indicators. You can turn each bank on and off, so that all the channels in a bank are either scanned or locked out. In scan mode, press the number key for the bank you want to turn on or off. If the bank indicator is on, you have turned on the bank and the scanner scans all the channels within that bank that you have not locked out. If the indicator is off, the scanner does not scan any of the channels within that bank. You can still manually select any channel in a bank, even if you have turned off the bank. You cannot turn off all banks – one must be turned on.

USING THE PRIORITY FEATURE

You can scan through all your programmed channels, and still not miss an important or interesting call on a specific channel. Simply program your desired channel as the priority channel, and turn on the priority feature by pressing [PRI] during scanning. The scanner now checks the priority channel every two seconds, and stays on the channel if there is activity.

To program a priority channel, simply press [PROGRAM], and the desired channel number. Then, press [PRI]. "P" appears in the display whenever the scanner is set to the priority channel. You can only program one channel as the priority channel. If you program a new channel as the priority channel, the previous channel you chose is automatically cleared.

Note: Channel 1 is automatically designated as the priority channel the first time you turn on your scanner.

MANUALLY SELECTING A CHANNEL

You can continuously monitor a single channel without scanning. This is useful if you hear an emergency broadcast on a channel and do not want to miss any of the details – even though there might be periods of silence – or if you want to monitor a channel that you have locked out. To select a channel to monitor, just press [MANUAL], and enter the channel number. Then, press [MANUAL] again. Or, if your scanner is scanning and has stopped at the desired channel, just press [MANUAL] once. Pressing [MANUAL] additional times causes your scanner to step through the channels one at a time.

USING THE LIGHT SWITCH

Press [LIGHT] to turn on or off the display's backlight. For longest backlight life, be sure to turn off the backlight when you do not need it.

A GENERAL GUIDE TO SCANNING

BIRDIES

Birdies are the products of internally generated signals that make some frequencies difficult or impossible to receive. If you program one of these frequencies, you hear only noise on that frequency.

If the interference is not severe, you might be able to turn SQUELCH clockwise to cut out the birdie. The most common birdies to watch out for are listed below.

Birdie Frequencies

(MHz)	(MHz)	(MHz)	(MHz)	(MHz)	(MHz)
30.135	130.9375	342.000	851.875	1098.250	1245.850
45.200	144.135	342.800	854.375	1104.250	1248.650
48.045	155.125	366.000	856.875	1107.000	1260.000
51.230	185.450	366.750	867.9375	1109.750	1262.750
57.260	203.500	464.250	900.0625	1112.500	1265.500
59.500	208.000	465.250	902.5625	1125.000	1272.350
60.260	220.750	488.375	905.0625	1163.6875	1275.150
63.275	244.250	489.375	916.125	1166.4375	1277.950
69.300	249.750	500.4375	918.625	1169.1875	1280.750
72.315	250.500	501.4375	921.125	1203.3125	1288.400
75.330	278.4375	767.400	948.250	1206.0625	1291.200
78.330	279.1875	769.800	950.750	1208.8125	1294.000
79.800	298.0625	785.250	953.250	1224.200	1296.800
84.375	298.8125	803.550	1015.000	1227.000	
87.395	309.800	805.950	1017.500	1229.800	
122.375	310.600	815.600	1026.000	1232.600	
122.875	327.500	818.000	1052.750	1240.250	
130.4375	334.750	822.250	1088.875	1243.050	

CROSS MODULATION

When using an external antenna, a strong frequency close to the reception frequency might cause cross modulation (like cross talk). Set the ATT switch on the back panel to -10 dB to minimize cross modulation.

RECEPTION NOTES

Reception on the frequencies covered by your scanner is mainly "line of sight." That means you usually cannot hear stations at your listening location that are located beyond the horizon.

During summer months, you might be able to hear stations in the 30–50 MHz range located several hundred or even thousands of miles away. This is due to summer atmospheric conditions. This type of reception is unpredictable, but often very interesting!

One very useful service is the National Weather Service's continuous weather broadcasts. These broadcasts contain weather forecasts and data for the area around the station, plus bulletins on any threatening weather conditions. These stations use three frequencies: 162.40, 162.475, and 162.55 MHz. In most areas of the country, you can receive one of these frequencies.

GUIDE TO THE ACTION BANDS

With the right frequencies programmed into your scanner, you can monitor exciting events. With a little investigation, you can find active frequencies in your community. We can give you some general pointers, and you can take it from there. Please use caution and common sense when you hear an emergency call. Never go to the scene of an emergency – it could be the most dangerous thing you could ever do.

Find out if there is a local club that monitors your community's frequencies. Perhaps, a local electronics repair shop that works on equipment similar to your scanner can give you channel frequencies used by local radio services. A volunteer police or fire employee can also be a good source of this information.

As a general rule on VHF, most activity concentrates between 153.74 and 156.21 MHz and then again from 158.73 to 159.465 MHz. Here you find local government, police, fire, and most such emergency services. If you are near a railroad yard or major railroad tracks, look around 160.0 to 161.9 for signals.

In some larger cities there has been a move to the UHF bands for emergency services. Here, most of the activity is in a spread of 435.025–453.95 MHz and again between 456.025–460.625 MHz.

In the UHF band, mobile units and control units associated with base and repeater units occur in the overall spreads of 456.025–459.95 and 465.025–469.975. The repeater units operate 5 MHz lower (that is, 451.025–454.95 and 460.025–464.975 MHz) than the base units. This means that if you find an active frequency inside one of these spreads, you can look 5 MHz lower (or higher, as the case may be) to find that radio service.

A new technology is now available that allows the use of the 800 MHz band for many services. Some public safety agencies use trunked radio, introduced to business systems in 1979. With as many as twenty channels available, the transmitter automatically selects an unused channel each time it is activated. Several agencies can share such a system without causing interference. This system can also be programmed to provide secure communications for selected units, with unselected units unable to hear the message.

Frequencies in different bands are accessible only at specific intervals. However, the frequencies that you can store into your scanner's memory are in 5 kHz, 12.5 kHz, or 50 kHz steps. Your scanner automatically rounds the entered frequency down to the nearest valid frequency. For example, if you try to enter a frequency of 151.473, your scanner accepts this entry as 151.470.

TYPICAL BAND USAGE

The following is a brief listing of the typical services using the bands your PRO-2006 can receive. This listing can help you decide which ranges you would like to scan.

These frequencies are subject to change, and might vary some from area to area. For a more complete listing, refer to the "Police Call Radio Guide Including Fire & Emergency Services." at your local Radio Shack.

Abbreviations:

BA..... Remote Broadcast (Radio & TV)
 CA..... General Mobile (Radio)
 CAP..... Civil Air Patrol
 IB..... Business
 IF..... Forest Products
 IM..... Motion Picture Industry
 IP..... Petroleum Industry
 IS..... Special Industrial (Construction, farming, etc.)
 IT..... Telephone Maintenance
 IW..... Power and Water Utilities
 IX..... Manufacturers
 IY..... Relay Press (newspaper reporters)
 LA..... Automotive Emergency (tow trucks)
 LJ..... Motor Carrier, Trucks
 LR..... Railroad
 LU..... Motor Carrier, Buses
 LX..... Taxi
 MC..... Maritime Limited Coast (private stations)
 MG..... Maritime Government (Coast Guard)
 MP..... Maritime Public Coast (marine telephone)
 MS..... Maritime Shipboard
 PF..... Fire
 PH..... Highway Maintenance
 PL..... Local Government
 PM..... Medical Services

PO..... Forestry Conservation
 PP..... Police
 PS..... Special Emergency
 RA..... Mobile Telephone (aircraft)
 RC..... Mobile Telephone (radio common carrier)
 RT..... Mobile Telephone (landline companies)
 BIFC..... Boise Interagency Fire Cache

Government Agencies:

UAF..... Air Force
 UAR..... Army
 UBW..... International Boundary & Water Commission
 UCE..... Environmental Research Laboratories
 UCF..... Maritime Fisheries Service
 UCG..... Coast Guard
 UCM..... Maritime Administration
 UCO..... Ocean Survey
 UCP..... National Capitol Police
 UCW..... National Weather Service
 UCX..... Department of Commerce
 UEP..... Environmental Protection Agency
 UER..... Department of Energy
 UFA..... Federal Aviation Administration
 UFC..... Federal Communications Commission
 UGC..... Soil Conservation Service
 UGF..... Forest Service

UGS..... General Services Administration
 UGX..... Department of Agriculture
 UHW..... Dept. of Health and Human Services
 UIB..... Bonneville Power Administration
 UIF..... Bureau of Sport Fisheries and Wildlife
 UIG..... Geological Survey
 UII..... Bureau of Indian Affairs
 UIL..... Bureau of Land Management
 UIM..... Bureau of Mines
 UIP..... National Park Service
 UIR..... Bureau of Reclamation
 UIS..... Southwestern Power Administration
 UIX..... Department of the Interior
 UNO..... United Nations
 UNS..... NASA
 UPO..... Postal Service
 USA..... Federal Govt. Misc.
 USD..... State Department
 USN..... Navy
 UTC..... Bureau of Customs
 UTM..... Bureau of the Mint
 UTR..... Department of Transportation
 UTV..... Tennessee Valley Authority
 UTX..... Treasury Department
 UVA..... Veterans Administration
 UXX..... Classified

Abbreviations used by permission of the publishers of Police Call Radio Guide, Copyright Hollins Radio Data.

Band Usage:**30–50 MHz**

30.00–30.55	USA,UAR,USN,UCG,UAF
30.58–31.98	IS,IP,IB,LU,PO
32.00–32.99	..	USA,UAR,USN,UCG,UGX,UAF,UJR
33.02–33.98	PS,PH,IS,IB,IP,PF
34.01–34.99	UCG,UER,USA,UAR,UAF, USN,UGX,UJP,UJF
35.02–35.98	IB,IT,RC,RT,IS,PS
36.01–36.99	UIX,UER,USA,UAR,USN,UTR, UCO,IP,UHW,UGF,UGX,UAF
37.02–37.98	PP,PL,IW,PH,PS
38.27–38.99	USA,USN,UGX,UGF,UAR, UAF,UIX,UTV,UVA
39.02–39.98	PP,PL
40.01–41.99	UIA,UAR,UJP,UAF,USA,UVA,UER, USN,UJF,UJR,UTV,UIM,IP,UIX,UEP, UCG,UJL,BIFC,UHW,UTX
42.02–42.94	PP
42.96–43.68	IB,IS,IT,RC,RT,PS
43.70–44.60	LU,LJ
44.62–46.58	PP,PO,PL,PH,PF,PS
46.61–46.99	..	USA,UJL,BIFC,UAF,UAR,UGX,UGF
47.02–49.58	PH,PS,IS,IW,IF,IP
49.61–49.99	UJL,UAR,UGC,UAF,UAR, UGX,UGF,USA

150–173 MHz

150.775–151.985	PM,LA,IF,PH,PO,IS,IB
152.0075–152.84	PM,RC,LX,IF,IB,RT
152.87–153.725	IM,IS,IP,IX,IF,IW
153.74–156.24	PL,PF,IS,IB,PP,PM,PH
156.255–157.45	IP,MC,MS,MG,MP,PM
157.47–158.70	LA,LX,IF,IS,IB,RT,IW,IP,IX,IT,RC
158.73–159.48	PP,PL,PH,PO,IP
159.495–161.565	LR,LJ
161.58–162.00	IP,MC,BA,MP
162.025–173.9875	Misc. Govt. Agencies

406–512 MHz

406.125–419.975	Misc. Govt. Agencies
450.05–450.925	BA
451.00–451.70	IW,IF,IP,IT,IX
451.725–452.175	IS,IF,IP,LX
452.200–453.000	LX,LJ,LR,LA,IY
453.025–453.975	PF,PH,PL,PO,PP
454.025–454.975	RA,RC,RT
460.025–460.625	PF,PS,PP
460.065–462.525	IB,IF,IP,IT,IW,IX
462.550–462.725	GM
462.750–462.925	IB
462.975–463.175	PM
462.300–464.975	IB
470.0125–511.9875	MIXED SERVICES

THESE ALLOCATIONS REPEAT 5 MHz HIGHER.

Unlike the lower bands, frequencies in the 800 MHz band are not allocated by the FCC to specific services such as Police, Fire, Ambulance, and so on. In each area, the channels are licensed on a first come, first served basis. There are two categories for licensing: Public Safety and Industrial. Systems using one to five channels are conventional. Five channel systems might use trunking, but all systems with more than five channels must use trunking.

851.0125–855.9875	Conventional Systems
856.0125–860.9875	Conventional or Trunked
861.0125–865.9875	Trunked Systems
866.0125–868.9875	Public Safety
935.0125–939.9875	Private
940.0125–940.9875	General Purpose

Abbreviations used by permission of the publishers of Police Call Radio Guide, Copyright Hollins Radio Data.

You might discover some of your regular stations on another frequency that is not listed. It might be what is known as an "image." For example, you suddenly find 453.2750 also being heard on 474.8750. To see if it is an image, do a little math. Take the intermediate frequency of 10.7 MHz and double it. Then, subtract it from the "new" frequency. If the answer is the regular frequency, you have tuned to an image. Occasionally you might get interference on a weak or distant channel from a strong broadcast 21.4MHz below the tuned frequency. This is rare, and the image signal is usually cleared whenever a broadcast on the actual frequency is in progress.

MAINTENANCE

Your PRO-2006 is an example of superior design and craftsmanship. The following suggestions will help you care for the PRO-2006 so that you can enjoy it for years.

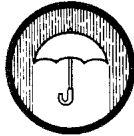

Keep the PRO-2006 dry. If it does get wet, wipe it dry immediately. Liquids can contain minerals that can corrode the electronic circuits.

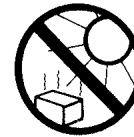

Use and store the PRO-2006 only in normal temperature environments. Extreme temperatures can shorten the life of electronic devices, damage batteries, and distort or melt plastic parts.



Use only fresh batteries of the recommended size and type. Always remove old or weak batteries. They can leak chemicals that destroy electronic circuits.



Keep the PRO-2006 away from dust and dirt, which can cause premature wear of parts.



Handle the PRO-2006 gently and carefully. Dropping it can damage circuit boards and cases and can cause the product to work improperly.



Wipe the PRO-2006 with a dampened cloth occasionally to keep it looking new. Do not use harsh chemicals, cleaning solvents, or strong detergents to clean the PRO-2006.

Modifying or tampering with the PRO-2006's internal components can cause a malfunction and might invalidate the PRO-2006's warranty. If your PRO-2006 is not performing as it should, take it to your local Radio Shack store. Our personnel can assist you and arrange for service if needed.

BEFORE YOU CALL FOR HELP

The frequencies stored in the PRO-2006 memory are held by the 9 V battery. You should replace the battery every 6 months. Use only alkaline type, such as Radio Shack's Cat. No. 23-553.

If You Have Problems...

We hope you don't — but here are some suggestions.

Problem	Possible Cause	Remedy
Scanner is totally inoperative.	No power	Check to see that unit is plugged into a working AC outlet, or DC power source.
Scanner is "ON" but will not scan.	Squelch control is not adjusted correctly.	Adjust SQUELCH clockwise.
Scan locks on frequencies having no clear transmission.	"Birdies"	Avoid programming frequencies listed on Page 26, or only listen to them manually.
Keys are inoperative or LCD display is random.	CPU locked-up.	See "Using the Restart Switch" on page 23.

If none of these suggested remedies solves the problem, return your set to your nearby Radio Shack for assistance.

SPECIFICATIONS

FREQUENCY COVERAGE:

25 MHz – 520 MHz
760 MHz – 823.945 MHz
851 MHz – 868.945 MHz
896 MHz – 1300 MHz

RECEPTION FREQUENCY INTERVAL:

5 kHz, 12.5 kHz, 50 kHz

RECEIVING WAVE MODE:

Wide FM (TV sound, FM broadcast)
Narrow FM (Business, communications, ham radio)
AM (Aircraft, CB radio)

CHANNELS OF OPERATION:

Any 400 channels in any band combinations.
(40 channels x 10 Monitor channels)

SENSITIVITY:

WFM: 30 dB S/N at 22.5 kHz deviation

25 MHz – 520 MHz 3 μ V
760 MHz – 1100 MHz 3 μ V
1100 MHz – 1300 MHz 10 μ V

NFM: 20 dB S/N at 3 kHz deviation

25 MHz – 520 MHz 0.5 μ V
760 MHz – 1100 MHz 0.5 μ V
1100 MHz – 1300 MHz 3 μ V

AM: 20 dB S/N at 60% modulation

25 MHz – 520 MHz 2 μ V
760 MHz – 1100 MHz 2 μ V
1100 MHz – 1300 MHz 5 μ V

IF REJECTION:

610 MHz at 70 MHz 60 dB
608MHz at 1000 MHz 60 dB

SELECTIVITY:

NFM and AM

\pm 9 kHz, -6 dB
 \pm 15 kHz, -50 dB

WFM

\pm 150 kHz, -6 dB
 \pm 300 kHz, -50 dB

SCANNING RATE:

Fast 26 channels/sec
Slow 13 channels/sec

PRIORITY SAMPLING:

2 seconds

DELAY TIME:

2 seconds

SQUELCH SENSITIVITY:**NFM and AM**

Threshold	25 MHz – 520 MHz	0.5 μ V
	760 MHz – 1100 MHz	0.5 μ V
	1100 MHz – 1300 MHz	3 μ V
Tight S/N	25 MHz – 520 MHz	25 dB
	760MHz – 1100MHz	25 dB
	1100 MHz – 1300 MHz	20 dB

WFM

Threshold	25 MHz – 520 MHz	3 μ V
	760 MHz – 1100 MHz	3 μ V
	1100 MHz – 1300 MHz	15 μ V
Tight S/N	25 MHz – 520 MHz	40 dB
	760 MHz – 1100 MHz	40 dB
	1100 MHz – 1300 MHz	40 dB

ANTENNA IMPEDANCE:

50 ohms

AUDIO POWER:

1.3 watts nominal

BUILT-IN SPEAKER:

3" (77 mm) 8 ohms, dynamic type

TAPE OUT (Z = 10 kohm):

600 mV nominal

POWER REQUIREMENTS:

AC 120 Volts 60 Hz 8 watts

DC 13.8 Volts 10 watts

MEMORY BACK-UP BATTERY:

9 Volts

DIMENSIONS:

2 7/8" (76 mm) x 8- 7/8" (220 mm) x 8 1/4" (205 mm)

HWD

WEIGHT:

77.6 oz. (2.2 kg)

Notes:

RADIO SHACK LIMITED WARRANTY

This product is warranted against defects for 1 year from date of purchase from Radio Shack company-owned stores and authorized Radio Shack franchisees and dealers. Within this period, we will repair it without charge for parts and labor. Simply **bring your Radio Shack sales slip** as proof of purchase date to any Radio Shack store. Warranty does not cover transportation costs. Nor does it cover a product subjected to misuse or accidental damage.

EXCEPT AS PROVIDED HEREIN, RADIO SHACK MAKES NO WARRANTIES, EXPRESS OR IMPLIED, INCLUDING WARRANTIES OF MERCHANTABILITY AND FITNESS FOR A PARTICULAR PURPOSE. Some states do not permit limitation or exclusion of implied warranties; therefore, the aforesaid limitation(s) or exclusion(s) may not apply to the purchaser.

This warranty gives you specific legal rights and you may also have other rights which vary from state to state.

We Service What We Sell

U.S. PATENT NOS.

3,794,925

3,801,914

3,961,261

3,962,644

4,027,251

4,092,594

4,123,715

4,245,348

RADIO SHACK
A Division of Tandy Corporation
Fort Worth, Texas 76102

1A0

Printed in Japan

Free Manuals Download Website

<http://myh66.com>

<http://usermanuals.us>

<http://www.somanuals.com>

<http://www.4manuals.cc>

<http://www.manual-lib.com>

<http://www.404manual.com>

<http://www.luxmanual.com>

<http://aubethermostatmanual.com>

Golf course search by state

<http://golfingnear.com>

Email search by domain

<http://emailbydomain.com>

Auto manuals search

<http://auto.somanuals.com>

TV manuals search

<http://tv.somanuals.com>