



US

OWNER/OPERATOR MANUAL

CHAINSAW

GZ3500T

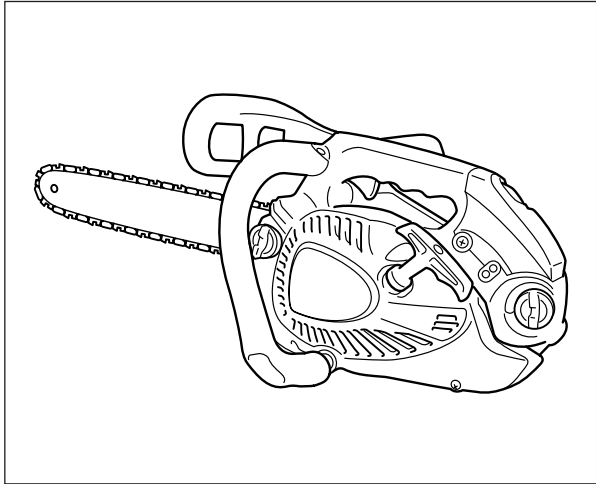

! WARNING !
The engine exhaust from this product contains chemicals known to the State of California to cause cancer, birth defects or other reproductive harm.

! WARNING !
Before using our product, please read this manual carefully to understand the proper use of your unit.

APPLICABLE SERIAL NUMBERS :

800001 and up

▲ SAFETY FIRST

Instructions contained in warnings within this manual marked with a ▲ symbol concern critical points which must be taken into consideration to prevent possible serious bodily injury, and for this reason you are requested to read all such instructions carefully and follow them without fail.

WARNINGS IN THE MANUAL

▲ WARNING

This mark indicates instructions, which must be followed in order to prevent accidents, which could lead to serious bodily injury or death.

ⓘ IMPORTANT

This mark indicates instructions, which must be followed, or it leads to mechanical failure, breakdown, or damage.

📖 NOTE

This mark indicates hints or directions useful in the use of the product.

SYMBOLS IN THE OPERATOR'S MANUAL



Read operator's instruction book before operating this machine.



Wear head, eye and ear protection.



Use the chain saw with two hands.



Warning! Danger of kickback.



Read, understand and follow all warnings.



Use appropriate protections for foot-leg and hand-arm.



Never touch hot surface.



This saw is for trained tree service operators only.

Contents

1. Parts location	3
2. Specifications	3
3. For safe operation	4
4. Symbols on the machine	7
5. Installing guide bar and saw chain	8
6. Fuel and chain oil	9
7. Operation	11
8. Sawing	12
9. Maintenance	14
10. Maintenance of saw chain and guide bar	15
11. Troubleshooting guide	16
12. Disposal	16

1. Parts location

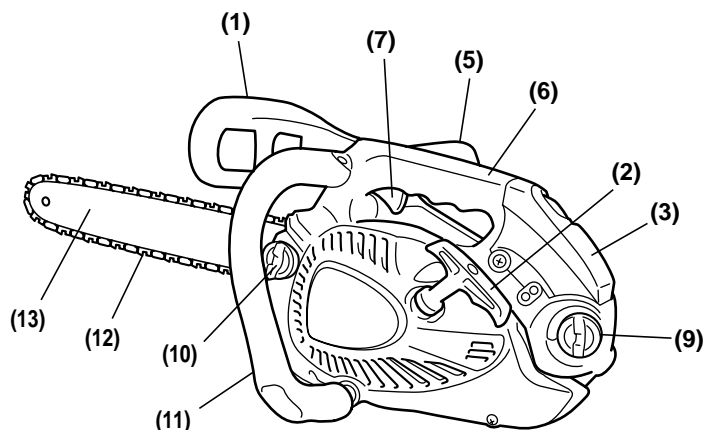

1. Front guard
2. Starter knob
3. Air cleaner cover
4. Choke knob
5. Throttle interlock
6. Right handle
7. Throttle lever
8. Engine switch
9. Fuel tank
10. Oil tank
11. Left handle
12. Saw chain
13. Guide bar
14. Priming bulb

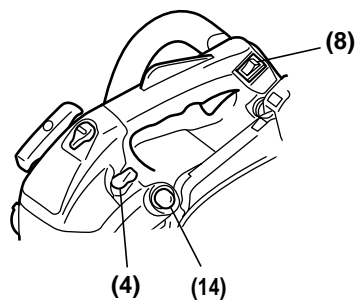

2. Specifications

■ GZ3500T

Power unit :

Displacement	2.15(35.2) cu-in(cm ³)
Fuel	Mixture(Gasoline 50 : Two-cycle oil 1)
.....	(when using RedMax/ZENOAH genuine oil)
Fuel tank capacity	8.5(0.25) fl.oz(ℓ)
Chain oil	Motor oil SAE #10W-30
Oil tank capacity	5.70(0.17) fl.oz(ℓ)
Carburetor	Diaphragm type (Walbro WT)
Ignition system	Digital
Spark plug	NGK CMR7H
Oil feeding system	Mechanical pump
Power	1.45/10,000 (kw/rpm)
Max speed	12,500 (rpm)
Idle speed	2,900 (rpm)
Sprocket : Pitch – No. of teeth	3/8in(9.53mm) – 6T
Dimensions : L – W – H	11.9(297)x9.2(235)x9.0(230) in(mm)
Dry weight : Power unit only	7.3(3.3) lbs(kg)

Cutting attachment :

Guide bar : Type – Size	Sprocket nose – 12(30), 14(35) in(cm)
Saw chain : Type – Pitch – Gauge	Oregon 91VG – 3/8(9.53) – 0.050(1.27) in(mm)

Specifications are subject to change without notice.

3. For safe operation

▲ WARNING

- This chainsaw has been especially designed for tree maintenance and should therefore only be used by trained operators when working up in the trees.
- Under no circumstances may the design of the machine be modified without the permission of the manufacturer. Always use genuine accessories. Non-authorized modifications and/or accessories can result in serious personal injury or the death of the operator or others.
- A chain saw is a dangerous tool if used carelessly or incorrectly and can cause serious, even fatal injuries. It is very important that you read and understand the contents of this operator's manual.



7. All chain saw service, other than the items listed in the Owner's Manual, should be performed by competent chain saw service personnel. (E.g., if improper tools are used to remove the flywheel, or if an improper tool is used to hold the flywheel in order to remove the clutch, structural damage to the flywheel could occur which could subsequently cause the flywheel to disintegrate.)

8. Always shut off the engine before setting it down.

9. Never cut in high wind, bad weather, when visibility is poor or in very high or low temperatures.

■ BASIC SAFETY RULES



1. Never operate a chain saw when you are fatigued, ill, or upset, or under the influence of medication that may make you drowsy, or if you are under the influence of alcohol or drugs.

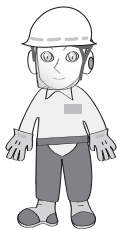

2. Use safety footwear, snug fitting clothing and eye, hearing and head protection devices. Use vibration reducing gloves. Most chain saw accidents happen when the chain touches the operator. Personal protective equipment cannot eliminate the risk of injury but it will reduce the degree of injury.



10. Operate the chain saw only in well ventilated areas. Never start or run the engine inside a closed room or building and potentially explosive atmosphere. Exhaust fumes contain dangerous carbon monoxide.

11. Never touch the cover, guide bar, saw chain or nut with bare hands while the engine is in operation or immediately after shutting down the engine. Doing so could result in serious burns because of high temperature.

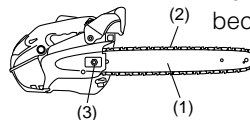

- (1) guide bar
(2) saw chain
(3) guide bar securing nut

3. Do not allow other person to be near the chain saw when starting or cutting. Keep bystanders and animals out of the work area. Children, pets and bystanders should be a minimum of 10 m away when you start or operate the chain saw.

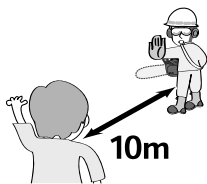

4. Never start cutting until you have a clear work area, secure footing, and a planned retreat path from the falling tree.

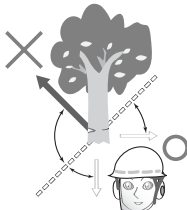

5. Always hold the chain saw firmly with both hands when the chain saw is running. Use a firm grip with thumb and fingers encircling the chain saw handles.

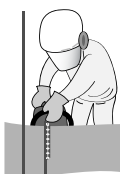

6. Keep all parts of your body away from the saw chain when the engine is running.



■ BEFORE USE

1. Keep the saw chain sharp and the anti-vibration system, well maintained. A dull chain will increase cutting time, and pressing a dull chain through wood will increase the vibrations transmitted to your hands. A saw with loose components or with damaged or worn AV buffers will also tend to have higher vibration levels.



2. Before you start the engine, make sure the saw chain is not contacting anything.



3. Always inspect the chain saw before each use for worn, loose, or damaged parts. Never operate a chain saw that is damaged, improperly adjusted, or is not completely and securely assembled. Be sure that the saw chain stops moving when the throttle control trigger is released.

■ CUTTING



1. Use extreme caution when cutting small size brush and saplings because slender material may catch the saw chain and be whipped toward you or pull you off balance.
2. When cutting a limb that is under tension, be alert for spring-back so that you will not be struck when the tension in the wood fibers is released.
3. Always check the tree for dead branches which could fall during the felling operation.
4. Do not operate the chain saw in a tree unless specially trained to do so.
5. Never use a chain saw by holding it with one hand. A chain saw is not safe if controlled with one hand; you can cut yourself. Always have a secure, firm grip around the handles with both hands.

■ TRANSPORT

1. Always carry the chain saw with the engine stopped, the guide bar and saw chain to the rear, and the muffler away from your body.
2. When transporting your chain saw, make sure the appropriate guide bar scabbard is in place.

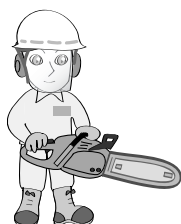

■ FUEL SAFETY



1. Always use caution when handling fuel. Wipe up all spills and then move the chain saw at least 10 ft(3 m) from the fueling point before starting the engine.



2. Eliminate all sources of sparks or flame (i.e. smoking, open flames, or work that can cause sparks) in the areas where fuel is mixed, poured, or stored.
3. Do not smoke while handling fuel or while operating the chain saw.
4. Keep the handles dry, clean and free of oil or fuel mixture.
5. Always store fuel in an approved container designed for that purpose.

■ STORAGE

1. Always store the chain saw and fuel so that there is no risk of leakages or fumes coming into contact with sparks or naked flames from electrical equipment, electric motors, relays/switches, boilers and the like.
2. For longer periods of storage or for transport of the chain saw, the fuel and chain oil tanks should be emptied.
3. When the chain saw is in storage make sure the appropriate guide bar scabbard is in place in order to prevent accidental contact with the sharp chain. Even a non-moving chain can cause serious cuts to yourself or persons you bump into with an exposed chain.

KICKBACK SAFETY PRECAUTIONS FOR CHAIN SAW USERS

WARNING

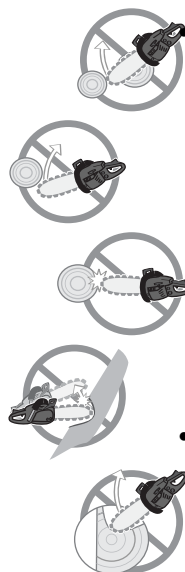

Kickback may occur when the nose or tip of the guide bar touches an object, or when the wood closes in and pinches the saw chain in the cut. Tip contact in some cases may cause a lightning fast reverse reaction, kicking the guide bar up and back towards the operator. Pinching the saw chain along the top of the guide bar may push the guide bar rapidly back towards the operator. Either of these reactions may cause you to lose control of the saw, which could result in serious personal injury.

- Do not rely exclusively on the safety devices built into your saw. As a chain saw user you should take several steps to keep cutting jobs free from accident or injury.



- With a basic understanding of kickback you can reduce or eliminate the element of surprise. Sudden surprise contributes to accidents.



- Keep a good grip on the saw with both hands, the right hand on the rear handle, and the left hand on the front handle, when the engine is running. Use a firm grip with thumbs and fingers encircling the chain saw handles. A firm grip will help you reduce kickback and maintain control of the saw.



- Make certain that the area in which you are cutting is free from obstructions. Do not let the nose of the guide bar contact a log, branch, or any other obstruction which could be hit while you are operating the saw.



- Cut at high engine speeds. (full throttle)

- Do not overreach or cut above shoulder height.

- If you have to cut branches or the like that are above shoulder height, a working platform or scaffold is recommended.



- Follow the manufacturer's sharpening and maintenance instructions for the saw chain.

- Only use replacement bars and chains specified by the manufacturer.

FOR PROTECTING YOUR BODY FROM VIBRATION

If you continue to use high-vibration tools these symptoms will probably get worse, for example:

- The numbness in your hands could become permanent and you won't be able to feel things at all;
- You will have difficulty picking up small objects such as screws or nails;
- The white finger syndrome could occur more frequently and affect more of your fingers.

Please observe the following, in order to protect the health of your body.

- Always use the right tool for each job (to do the job more quickly and expose you to less hand-arm vibration).
- Check tools before using them to make sure they have been properly maintained and repaired to avoid increased vibration caused by faults or general wear.
- Make sure cutting tools are kept sharp so that they remain efficient.
- Reduce the amount of time you use a tool at one time, by doing other jobs in between.
- Avoid gripping or forcing a tool or workpiece more than you have to.
- Store tools so that they do not have very cold handles when used.
- Encourage good blood circulation by:
 - keeping warm and dry (when necessary, wear gloves, a hat, waterproofs and use heating pads if available);
 - give up or cut down on smoking because smoking reduces blood flow; massage and exercise your fingers to increase blood circulation.

DISPOSAL

When disposing of your machine, fuel or oil in the machine, be sure to follow your local regulations.

4. Symbols on the Machine

▲ WARNING For safe operation and maintenance, symbols are carved or placed on the machine. According to these indications, please be careful not to make any mistake.



The port to refuel "MIX GASOLINE"
Position: Recoil case (in front of the fuel cap)



The port to fill chain oil
Position: Recoil case (under the oil cap)



Setting the switch to the "O" position, stops the engine immediately.
Position: Right side of the rear handle



Starting the engine. If you turn the choke knob to the point of the arrow, you can set the starting mode as follows:
Position: Upper-right of the air cleaner cover

H
L
T

The screw under the "H" stamp is The High-speed fuel mixture adjustment screw.
The screw under the "L" stamp is The Slow-speed fuel mixture adjustment screw.
The screw at the left of the "T" stamp is the Idle speed adjustment screw.
Position: Left side of the rear handle

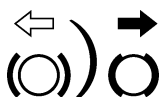

Shows the directions that the chain brake is released (white arrow) and brake is activated (black arrow).
Position: Front of the chain cover



If you turn the rod with screwdriver follow the arrow to the "⊕" position, the chain oil flows more, and if you turn to the "⊖" position, oil flow is less. (Standard width: 90°)
Position: Bottom of the power unit

■ EMISSION CONTROL

An emission control label is located on the engine.

IMPORTANT EMISSIONS INFORMATION
THIS ENGINE MEETS TO 2008*1 U.S. EPA AND 2008*1 CALIFORNIA EXH AND EVP EMISSION REGULATIONS FOR SI SORE's. COMPLIANCE PERIOD : CATEGORY A
ENGINE FAMILY : 8HQZS.0354BT*2 DISPL.: 35 cc
EMISSION CONTROL SYSTEM : EXH;EM
REFER TO OWNER'S MANUAL FOR MAINTENANCE, SPECIFICATIONS AND ADJUSTMENTS.
MANUFACTURED:
 USE JASO FD OR ISO L-EGD GRADE 50:1 OIL.
Husqvarna Zenoah Co., Ltd.

*1: The year will be changed every year of manufacturing.

*2: The initial number will be changed every year of manufacturing.

5. Installing Guide Bar and Saw Chain

A standard saw unit package contains the items as illustrated.

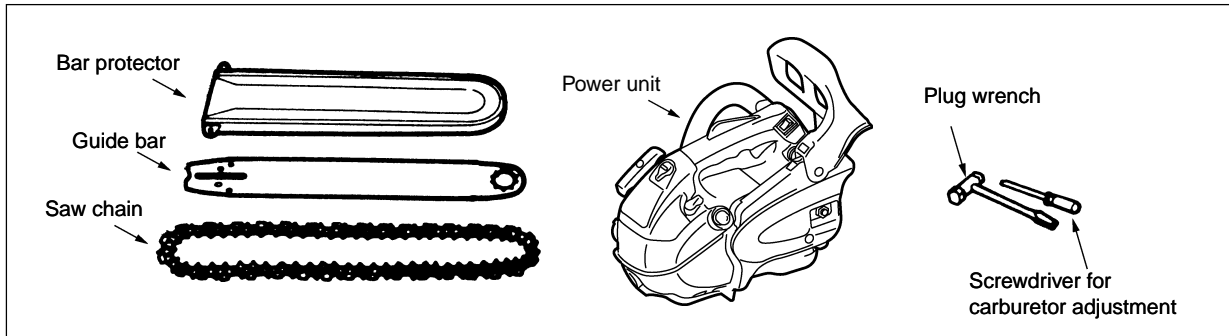

Open the box and install the guide bar and the saw chain on the power unit as follows:



The saw chain has very sharp edges. Use thick protective gloves for safety.

1. Pull the hand guard towards the front handle to check that the chain brake is not engaged.
2. Loosen the nuts and remove the chain cover.
3. Mount the guide bar then fit the saw chain around the bar and sprocket.

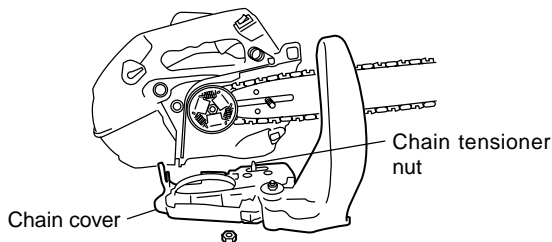

NOTE

Pay attention to the correct direction of the saw chain.

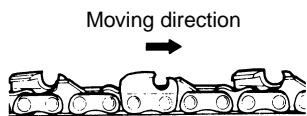

4. Fit the chain tensioner nut into the lower hole of the guide bar, then install the chain cover, and fasten the mounting nut finger tight.

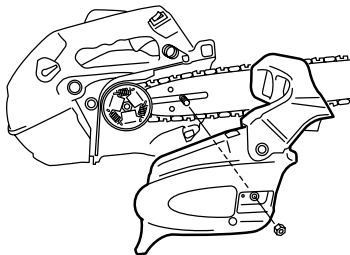

5. While holding up the tip of the bar, adjust the chain tension by turning the tensioner screw until the tie straps of chain just touch the bottom side of the bar rail.

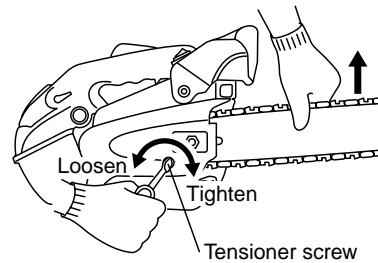

6. Tighten the nuts securely with the bar tip held up (11.8-14.7 N.m./120-150 kg-cm). Then check the chain for smooth rotation and proper tension while moving it by hand. If necessary, readjust with the chain cover loose.

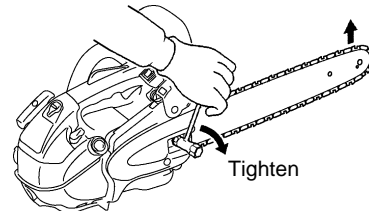

7. Tighten the tensioner screw.

WARNING

A new chain will stretch in its length in the beginning of use. Check and readjust the tension frequently as a loose chain can easily derail or cause rapid wear of itself and the guide bar.

6. Fuel and Chain Oil

FUEL

▲ WARNING

- **Gasoline is very flammable. Avoid smoking or bringing any flame or sparks near fuel. Make sure to stop the engine and allow it cool before refueling the unit. Select outdoor bare ground for fueling and move at least 10 ft (3 m) away from the fueling point before starting the engine.**



■ GASOLINE REQUIREMENTS

- All 2-Stroke RedMax Products are powered by Zenoah Professional-Commercial Duty, Hi-Performance, Hi-RPM, **Air Cooled** 2-Stroke engines. RedMax/Zenoah – Hi-Performance 2-stroke engines produce higher HP outputs as compared to standard Home Owner Duty or Light Commercial Duty production engines offered by most manufacturers.
- Exhaust emission are controlled by the fundamental engine parameters and components (eq., carburation, ignition timing and port timing) without addition of any major hardware or the introduction of an inert material during combustion.
- The RedMax/Zenoah Engines are registered and certified with CARB (California Air Resources Board) and EPA (Environmental Protection Agency) to operate on CLEAN Mid-grade 89 octane or Premium, unleaded (lead-free) gasoline and RedMax Air-Cooled "Max Life", Synthetic blend Premium two-stroke engine oil mixed at 50:1 ratio.
- Unleaded gasoline is recommended to reduce the contamination of the air for the sake of your health and the environment.
- This Hi-Performance Air Cooled 2-stroke Engine requires the use of **Minimum** 89 Octane $\frac{[R+M]}{2}$ (Mid grade or Premium) clean gasoline. Gasoline may contain maximum of 10% Ethanol (grain alcohol) or up to 15% MTBE (Methyl tertiary-butyl ether). Gasoline containing Methanol (Wood Alcohol) is **NOT** approved.

📖 NOTE

- IF octane rating of the Mid Grade gasoline in your area is lower than 89 Octane use Premium Unleaded Gasoline. The majority of all 2-stroke engine manufacturers in the USA and Canada recommend using gasoline with 89 Octane or higher.

▲ WARNING

- Gasoline with an octane rating lower than 89 will greatly increase the engines operating temperature. Low octane gasoline will cause detonation (knock) resulting in piston seizures and major internal engine components damage.
- Poor quality gasolines or oils may damage sealing rings, fuel lines or fuel tank of the engine.

📖 NOTE

- Failures caused by operating engines on gasoline with octane rating lower than 89 are not covered by the RedMax Two-Stroke engine warranty.

▲ WARNING

- **Alternative Fuels (Not Gasoline)**
Alternative fuels, such as E-15 (15% ethanol), E-20 (20% ethanol), E-85 (85% ethanol) are NOT classified as gasoline and are NOT approved for use in RedMax 2-stroke gasoline engines. Use of alternative fuels will cause major engine performance and durability problems such as: improper clutch engagements, overheating, vapor lock, power loss, lubrication deficiency, deterioration of fuel lines, gaskets and internal carburetor components, etc... Alternative fuels cause high moisture absorption into the fuel/oil mixture leading to oil and fuel separation.

■ OIL REQUIREMENTS

- Use only RedMax "Max Life", Synthetic blend Premium Air-Cooled two-stroke engine oil or oil certified to ISO-L-**EGD** (ISO/CD1378) standard AND one that is JASO-**FD** registered. RedMax Air-Cooled "Max Life", Synthetic blend Premium two stroke engine oil and ISO-L-**EGD** (ISO/CD1378) AND JASO-**FD** oils are fully compatible with gasoline's containing 10% Ethanol. RedMax Air-Cooled "Max Life", Synthetic blend Premium two stroke engine oil and ISO-L-**EGD** (ISO/CD1378) AND JASO-**FD** oils are **Universal** and should be mixed at 50:1 ratio for all 2 stroke air cooled engines sold in the past regardless of mixing ratios specified in those manuals.
- If the oil is registered with JASO, the JASO Logo with **FD** and registration number will be displayed on the container. The highest JASO rating is "FD", which equals the ISO-L-**EGD** rating. Lower ratings are "FC", "FB", and "FA".



- Engine problems due to inadequate lubrication caused by failure to use ISO-L-**EGD** certified and JASO **FD** registered oil such as "MaxLife", RedMax Synthetic blend Premium 2-stroke oil **WILL VOID THE REDMAX TWO-STROKE ENGINE WARRANTY.**

⚠ WARNING

- Do not use NMMA (National Marine Manufacturers Association), BIA (Boating Industry Association), and TCW (two cycle water cooled) oils designed for MoPeds or Outboard, water cooled Marine Engines. Do not use API (American Petroleum Institute), TC (Two Cycle) labeled oils. The API-TC test standard has been discontinued by API in 1995 and it no longer exists.

📌 IMPORTANT

• **Gasoline/Oil mixture Storage Recommendations**

Store your gasoline or gasoline/oil mixture in a cool dry area in a tightly sealed approved container to limit the entry of moisture and additional air (oxygen). Moisture and air cause the development of varnish and gum, making the fuel stale. Stored gasoline and gasoline/oil mixture ages and loses its octane rating and volatility. Do not mix more gasoline/oil than you intend to use in 30 days, and 60 days when fuel stabilizer is added. RedMax Air-Cooled "Max Life" Synthetic blend Premium two-stroke engine oil "**Contains fuel stabilizer**" and will automatically extend your gasoline/oil mixture life up to 60 days.

■ **HOW TO MIX FUEL**

RECOMMENDED MIXING RATIO GASOLINE 50 : OIL 1

(when using RedMax Air-Cooled "Max Life")



50:1 MIXING CHART

GASOLINE	gal.	1	2	3	4	5
2-CYCLE OIL	fl.oz	2.6	5.2	7.8	10.4	13

GASOLINE	liter	1	2	3	4	5
2-CYCLE OIL	ml	20	40	60	80	100

⚠ WARNING

• **Pay attention to agitation.**

1. Measure out the quantities of gasoline and oil to be mixed.
2. Put some of the gasoline into a clean, approved fuel container.
3. Pour in all of the oil and agitate well for 10seconds.
4. Pour in the rest of gasoline and agitate again for at least one minute. As some oils may be difficult to agitate depending on oil ingredients, sufficient agitation is necessary. Be careful that, if the agitation is insufficient, there is an increased danger of early piston seizure due to abnormally lean mixture.
5. Place a clear indication on the outside of the container to

US-10

- avoid mixing up with gasoline or other containers that dont contain oil.
6. Indicate the contents on outside of container for easy identification.

■ **FUELING THE UNIT**

1. Untwist and remove the fuel cap. Rest the cap on a clean surface.
2. Put fuel into the fuel tank to 80% of the full capacity.
3. Fasten the fuel cap securely and wipe up any fuel spillage around the unit.

⚠ WARNING

1. **Select flat and bare ground for fueling.**
2. **Move at least 10 feet (3 meters) away from the fueling point before starting the engine.**
3. **Stop the engine before refueling the unit. At that time, be sure to sufficiently agitate the mixed gasoline in the container.**

■ **FOR YOUR ENGINE LIFE, AVOID**

1. **FUEL WITH NO OIL (RAW GASOLINE)** – It will cause severe damage to the internal engine parts very quickly.
2. **GASOHOL** – It can cause deterioration of rubber and/or plastic parts and disruption of engine lubrication.
3. **OIL FOR 4-CYCLE ENGINE USE** – It can cause spark plug fouling, exhaust port blocking, or piston ring seizure.
4. **Mixed fuels which have been left unused for a period of one month or more** may clog the carburetor and result in the engine failing to operate properly.
5. In the case of storing the product for a long period of time, clean the fuel tank after rendering it empty. Next, Start the engine and run the carburetor dry residual fuel.
6. In the case of scrapping the used mixed oil container, scrap it only at an authorized depository site.

📖 NOTE

- As for details of quality assurance, read the description in the section Limited Warranty carefully. Moreover, normal wear and change in product with no functional influence are not covered by the warranty. Also, be careful that, if the usage in the instruction manual is not observed as to the mixed gasoline, type of oil or fuel to be used. described therein, it may not be covered by the warranty.

CHAIN OIL

- Use motor oil SAE #10W-30 all year round or SAE #30 ~ #40 in summer and SAE #20 in winter.

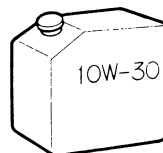

📖 NOTE

- Do not use wasted or regenerated oil that can cause damage to the oil pump.

7. Operating the Engine

▲ WARNING



It is very dangerous to run a chainsaw with mounts broken or any missing parts.

Before starting engine, make sure that all the parts including bar and chain are installed properly.

■ STARTING THE ENGINE

Normal start

1. Fill fuel and chain oil tanks respectively, and tighten the caps securely.

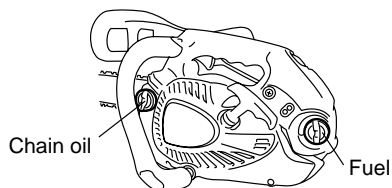

2. Continuously push the priming bulb until fuel comes in the bulb. Then press additional 5 times.

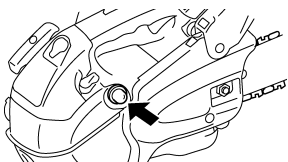

3. Set the switch to "I" position.

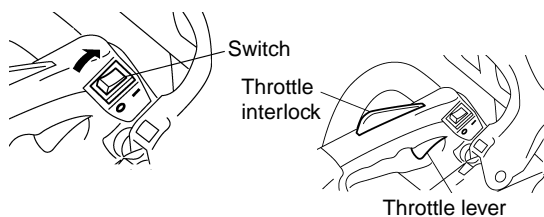

4. Turn the choke knob to the closed position.

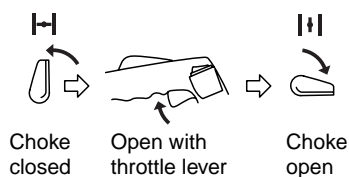

NOTE

When restarting immediately after stopping hot engine, choke knob should be in the open position.

5. While holding the saw unit securely on the ground, pull the starter rope using short strokes vigorously.

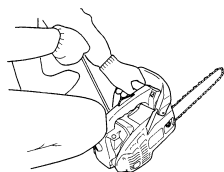

▲ WARNING

Do not start the engine while the chain saw hangs in one hand. The saw chain may touch your body. This

is very dangerous.

6. When engine has started, turn the choke knob to the closed position and then pull the starter again to run the engine.
7. Allow the engine to warm up with the throttle lever pulled slightly.

■ CHECKING THE OIL SUPPLY

▲ WARNING

Make sure the bar and the chain is in place when checking the oil supply.

If not, the rotating parts may be exposed. It is very dangerous.

After starting the engine, run the chain at medium speed and see if chain oil is scattered off as shown in the figure.

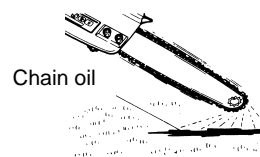

The chain oil flow can be changed by inserting a screwdriver in the hole on bottom of the clutch side. Adjust according to your work conditions.

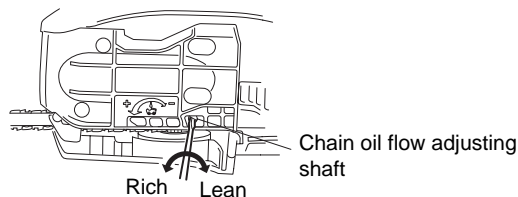

The oil tank should become nearly empty by the time fuel is used up. Be sure to refill the oil tank every time when refueling the saw.

NOTE

The adjustment range of the discharge is 90°. Pay attention not to turn any further, as this may damage the adjuster of the oil pump.

■ ADJUSTING THE CARBURETOR

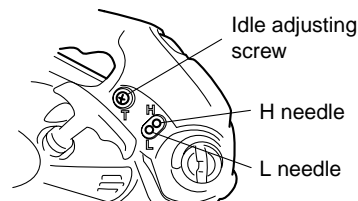

The carburetor on your unit has been factory adjusted, but may require fine tuning due to a change in operating conditions.

Before adjusting the carburetor, make sure that the provided air/fuel filters are clean and fresh and the fuel properly mixed.

When adjusting, take the following steps:

NOTE

Be sure to adjust the carburetor with the bar chain attached.

1. H and L needles are restricted within the number of turns as shown below.

H needle : -1/4
L needle : -1/4

2. Start the engine and allow it to warm up in low speed for a few minutes.
3. Turn the idle adjusting screw (T) counterclockwise so that the saw chain does not turn. If the idling speed is too slow, turn the screw clockwise.
4. Make a test cut and adjust the H needle for best cutting power, not for maximum speed.

■ CHAIN BRAKE

The chain brake is a device which stops the chain instantaneously if the chain saw recoils due to kickback. Normally, the brake is activated automatically by inertial force. It can also be activated manually by pushing the brake lever (left-hand guard) down toward the front. When the brake operates, a yellow cone pops up from the base of the brake lever.

Releasing the Brake

Pull the brake lever up and back toward the left-hand handle until it clicks into place.

▲ WARNING

- When the brake operates, release the throttle lever to slow down the engine speed. Continuous operation with the brake engaged will generate heat from the clutch and may cause overheating or clutch failure.
- At machine inspection prior to each job, check the operating condition of the brake following these steps.

1. Start the engine and grasp the handle securely with both hands.
2. Pulling the throttle lever to maintain the chain operation, push the brake lever (left-hand guard) down toward the front using the back of your left hand.
3. When the brake operates and the chain is stopped, release the throttle lever.
4. Release the brake.

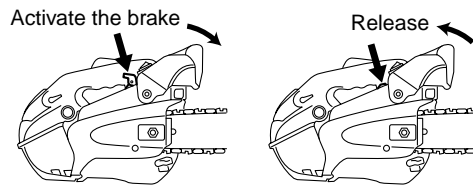

■ STOPPING THE ENGINE

1. Release the throttle lever to allow the engine to idle for a few minutes.
2. Set the switch to the "O" (STOP) position.

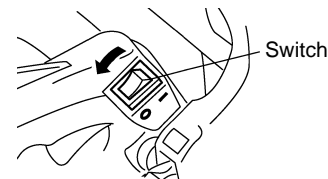

8. Sawing

▲ WARNING



- Before proceeding to your job, read the section "For Safe Operation". It is recommended to first practice sawing small logs. This also helps you get accustomed to your unit.



- The chain saw must only be used for cutting wood. It is forbidden to cut other types of material. Vibrations and kickback vary with different materials. Do not use the chain saw as a lever for lifting, moving or splitting objects. Do not lock it over fixed stands. It is forbidden to hitch tools or applications to the PTO other than those specified by the manufacturer.



- It is not necessary to force the saw into the cut. Apply only light pressure while running the engine at full throttle.
- When the saw chain is caught in the cut, do not attempt to pull it out by force, but use a wedge or a lever to open the way.

■ GUARD AGAINST KICKBACK

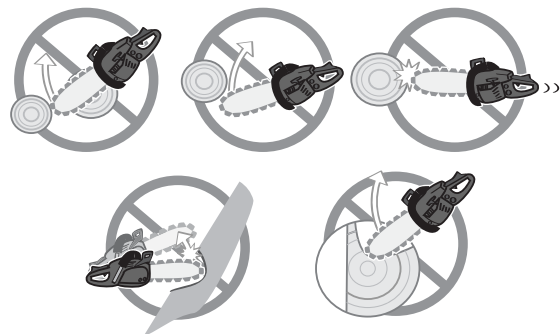



- This saw is equipped with a chain brake that will stop the chain in the event of kickback if operating properly. You must check the chain brake operation before each usage by running the saw at full the throttle for 1 - 2 seconds and pushing the front hand guard forward. The chain should stop immediately with the engine at full speed. If the chain is slow to stop or does not stop, replace the brake band and clutch drum before use.



- It is extremely important that the chain brake be checked for proper operation before each use and that the chain be sharp in order to maintain the kickback safety level of this saw. Removal of the safety devices, inadequate maintenance, or incorrect replacement of the bar or chain may increase the risk of serious personal injury due to kickback.

■ FELLING A TREE



Felling direction ←

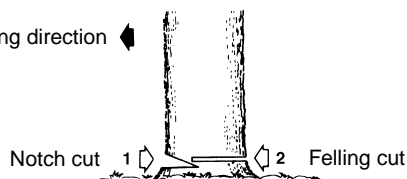

1. Decide the felling direction considering the wind, lean of the tree, location of heavy branches, ease of completing the task after felling and other factors.
2. While clearing the area around the tree, arrange a good foothold and retreat path.
3. Make a notch cut one-third of the way into the tree on the felling side.
4. Make a felling cut from the opposite side of the notch and at a level slightly higher than the bottom of the notch.

▲ WARNING

When you fell a tree, be sure to warn neighboring workers of the danger.

Bucking and Limbing

▲ WARNING

- Always ensure your foothold. Do not stand on the log.
- Be alert to the rolling over of a cut log. Especially when working on a slope, stand on the uphill side of the log.
- Follow the instructions in "For Safe Operation" to avoid kickback of the saw.

Before starting work, check the direction of bending force inside the log to be cut. Always finish cutting from the opposite side of the bending direction to prevent the guide bar from being caught in the cut.

A log lying on the ground

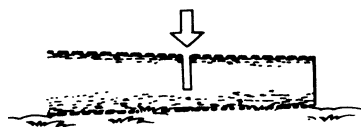

Saw down halfway, then roll the log over and cut from the opposite side.

A log hanging off the ground

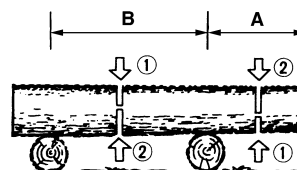

In area A, saw up from the bottom one-third and finish by sawing down from the top. In area B, saw down from the top one-third and finish by sawing up from the bottom.

Cutting the limbs of Fallen Tree

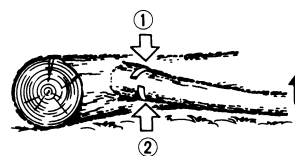

First check to which side the limb is bent. Then make the initial cut from the bent side and finish by sawing from the opposite side.

▲ WARNING

Be alert to the springing back of a cut limb.

Pruning of Standing Tree

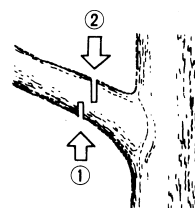

Cut up from the bottom, finish down from the top.

▲ WARNING

- Do not use an unstable foothold or ladder.
- Do not overreach.
- Do not cut above shoulder height.
- Always use both your hands to hold the saw.

9. Maintenance

▲ WARNING

Before cleaning, the inspecting or repairing the unit, make sure that engine has stopped and is cool. Disconnect the spark plug to prevent accidental starting.

■ MAINTENANCE AFTER EACH USE

1. Air filter

Loosen the knob and remove the air cleaner cover. Take off the filter elements and tap off attached sawdust. When they are extremely dirty, shakewash with soapy water. Do not use gasoline. Dry them completely before reinstalling.

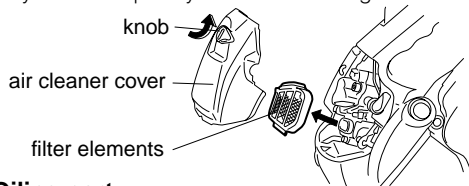

2. Oiling port

Remove the guide bar and check the oiling port for clogging.

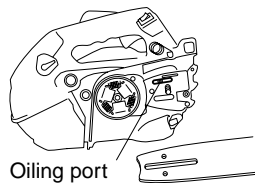

3. Guide bar

When the guide bar is removed, remove sawdust in the bar groove and the oiling port.

<Type : sprocket nose>

Grease the nose sprocket from the feeding port on the tip of the bar.

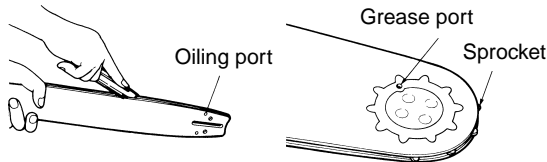

4. Others

Check for fuel leakage and loose fasteners and damage to major parts, especially handle joints and guide bar mounting. If any defects are found, make sure to have them repaired before operating the saw again.

■ PERIODICAL SERVICE POINTS

1. Cylinder fins

1. Remove the starter case.
2. Remove sawdust between the cylinder fins.
3. Clean the inside of the starter case.

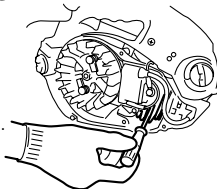

2. Fuel filter

- (a) Using a wire hook, pull out the filter from the filter port.

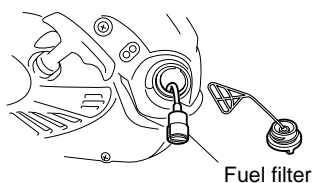

- (b) If dirty, replace filter.

Replace with new one if clogged with dirt.

US-14

▲ WARNING

When installing the filter, do not pinch or fold the suction pipe.

3. Oil filter

1. With a wire hook, take out the oil filter from the feeding port.

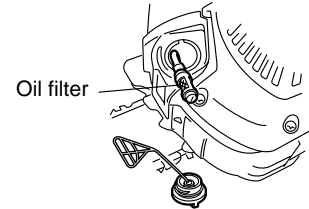

2. Wash the filter with non-flammable solvent.

▲ WARNING

When installing the filter, do not pinch or fold the suction pipe.

4. Spark plug

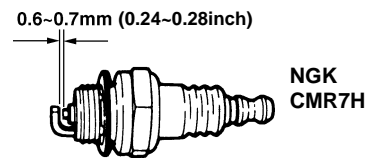

Clean the electrodes with a wire brush and reset the gap to 0.6 mm~0.7mm (0.24~0.28inch) as necessary.

5. Sprocket

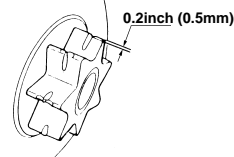

Check for cracks and for excessive wear interfering with the chain drive. If the wear is considerable, replace it with new one. Never fit a new chain on a worn sprocket, or a worn chain on a new sprocket.

6. Way of the cooling air



▲ WARNING

- The engine metal parts can burn your skin. Never touch the cylinder, muffler or ignition plug etc. during operation or right after stopping the engine.
- Before starting the engine, check around the muffler and remove sawdust. If you do not, it will cause the overheating. Keep clean area around the muffler.

This engine is air-cooled. Dirt clogging between the inlet port of the cooling air and cylinder fins will cause overheating of the engine. Periodically check and clean the cylinder fins after removing the air cleaner and the cylinder cover.

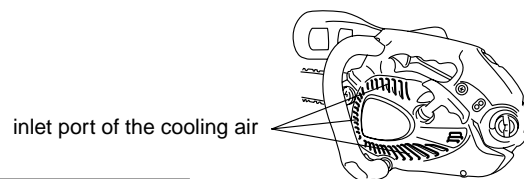

ⓘ IMPORTANT

When installing the cylinder cover, make sure that switch wires and grommets are positioned correctly in place.

7. Muffler

▲ WARNING



Regularly inspect the muffler for loose fastening screws, damage and rust. If you find that exhaust gas leaking remove the muffler. Remove carbon from exhaust port using a piece of wood or plastic. Make sure no carbon falls inside of the engine.

1. Removing the underside guard

Confirm that the chain break is released and remove the chain cover. Next, remove the screws of the recoil case and the screws of the chain catcher. Draw the underside guard out in the horizontal direction and remove it from the pin of the engine case in the downward direction.

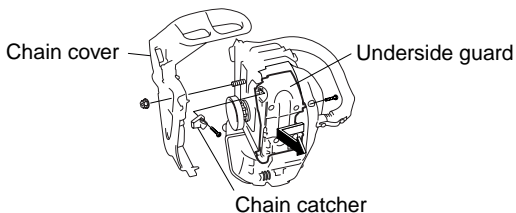

2. Removing the muffler

Remove the screws and nuts attaching the muffler and remove the muffler.

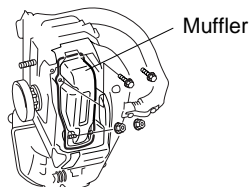

3. Removing the spark arrester

Lift up the claw of the guide muffler to take it off in the upward direction, and remove the arrester.

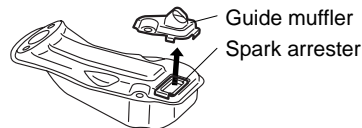

▲ WARNING

Right after stopping the engine, do not touch the muffler with one's bare hands. It will cause to burn your hands.

If carbon clogs between the muffler, it will cause poor-output and the trouble in starting. After each 100 hours, check and clean inside the muffler.

8. Spark arrester

The spark arrester is installed to prevent that burnt carbon is discharged from the muffler tail. Regularly clean it with a wire brush or a similar tool to remove the carbon.

NOTE

Never use a muffler if the spark arrester is missing or defective.

9. Exhaust port

Remove the muffler, insert a screwdriver into the vent, and wipe away any carbon buildup after every 100 hours of use. Wipe away any carbon buildup on the muffler exhaust vent and the clean cylinder exhaust port at the same time.

10. Maintenance of Saw Chain and Guide Bar

■ Saw Chain

▲ WARNING



It is very important for smooth and safe operation to always keep the cutters sharp.

The cutters need to be sharpened when:

- Sawdust becomes powder-like.
- You need extra force to saw in.
- The cut path does not go straight.
- Vibration increases.
- Fuel consumption increases.

Cutter setting standards:

▲ WARNING

Be sure to wear safety gloves.

Before filing:

- Make sure the saw chain is held securely.
- Make sure the engine is stopped.
- Use a round file of proper size for the chain.

Chain type: 91VG
File size: 5/32 in (4.0 mm)

Place the file on the cutter and push straight forward. Keep the file position as illustrated.

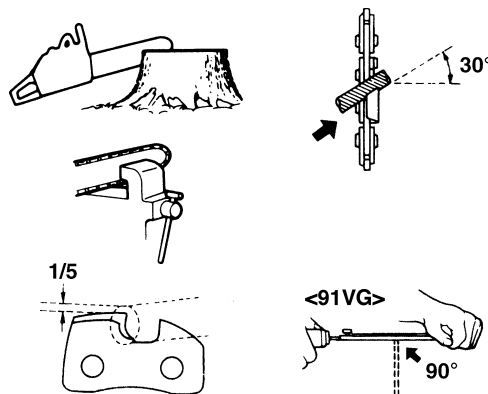

After each cutter has been filed, check the depth gauge and file it to the proper level as illustrated.

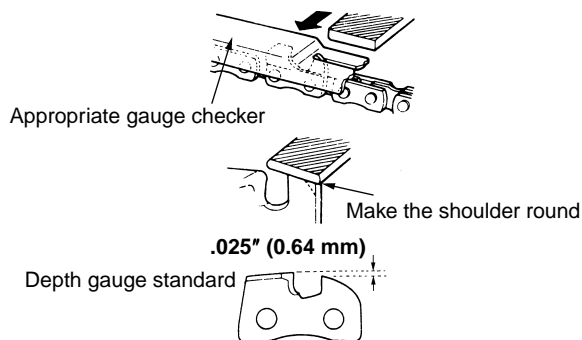

▲ WARNING

Be sure to round off the front edge to reduce the chance of kickback or tie-strap breakage.

Make sure every cutter has the same length and edge angles as illustrated.

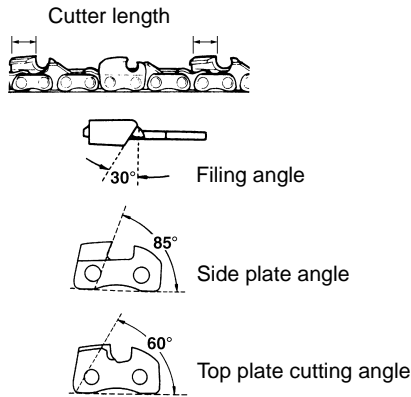

■ Guide Bar

- Reverse the bar occasionally to prevent partial wear.
- The bar rail should always be square. Check for wear of the bar rail. Apply a ruler to the bar and the out

side of a cutter. If a gap is observed between them, the rail is normal. Otherwise, the bar rail is worn. Such a bar needs to be corrected or replaced.

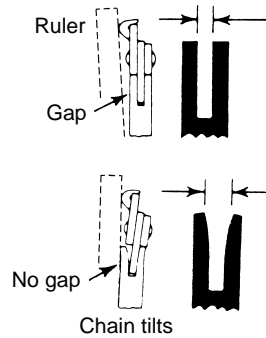

▲ WARNING:

This saw is equipped with one of the following low kickback bar/chain combinations:

Bar Size	Guide Bar	Saw Chain
12	G3112	91VG45X
14	G3114	91VG52X

11. Troubleshooting Guide

Case 1. Starting failure

▲ WARNING

Make sure the icing prevention system is not working.

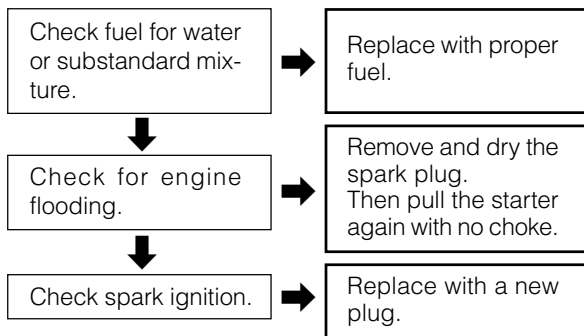

Case 2. Lack of power/Poor acceleration/Rough idling

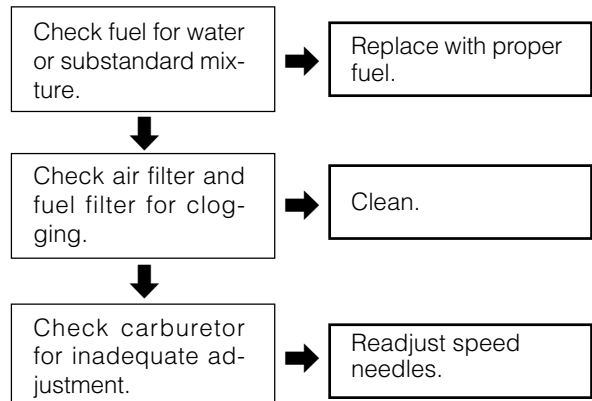

Case 3. Oil does not come out

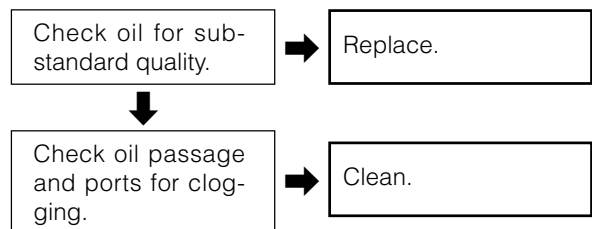

12. Disposal

When disposing your machine, fuel or oil for the machine, be sure to follow your local regulations.

If the unit seems to need further service, please consult with an authorized service shop in your area.

CALIFORNIA EMISSION CONTROL WARRANTY STATEMENT
YOUR WARRANTY RIGHTS AND OBLIGATIONS

The California Air Resources Board and ZENOAH AMERICA, INC. are pleased to explain the **emission control system warranty** on your **2007 and later** small off-road engine. In California, new small off-road engines must be designed, built and equipped to meet the state's stringent anti-smog standards. ZENOAH AMERICA, INC. must warrant the emission control system on your small off-road engine for the periods of time listed below provided there has been no abuse, neglect or improper maintenance of your small off-road engine.

Your emission control system may include parts such as the carburetor, fuel tank and the ignition system.

Where a warrantable condition exists, ZENOAH AMERICA, INC. will repair your small off-road engine at no cost to you including diagnosis, parts and labor.

Manufacturer's warranty coverage:

The 2007 and later small off-road engines are warranted for **two years**. If any emission-related part on your engine is defective, the part will be repaired or replaced by ZENOAH AMERICA, INC.

Owner's warranty responsibilities:

- As the small off-road engine owner, you are responsible for the performance of the **required maintenance listed in your owner's manual**. ZENOAH AMERICA, INC. recommends that you retain all receipts covering maintenance on your small off-road engine, but ZENOAH AMERICA, INC. can not deny warranty solely for the lack of receipts or for your failure to ensure the performance of all scheduled maintenance.

- As the small off-road engine owner, you should be aware, however, that ZENOAH AMERICA, INC. may deny you warranty coverage if your small off-road engine or a part has failed due to abuse, neglect, improper maintenance or unapproved modification.

- You are responsible for presenting your small off-road engine to a ZENOAH AMERICA, INC. distribution center as soon as a problem exists. The warranty repairs should be completed in a reasonable amount of time, not to exceed **30 days**.

If you have any questions regarding your warranty rights and responsibilities, you should contact ZENOAH AMERICA, INC. at (770)-381-5147 or you can write to

ZENOAH AMERICA, INC.
1100 Laval Blvd. Suite 110
Lawrenceville, Georgia 30043

LIMITED WARRANTY

EMISSION-RELATED PARTS, FOR TWO (2) YEARS FROM THE DATE OF ORIGINAL DELIVERY, RedMax / ZENOAH AMERICA, INC., THROUGH ANY RedMax DEALER, WILL REPAIR OR REPLACE, FREE OF CHARGE, FOR THE ORIGINAL AND EACH SUBSEQUENT PURCHASER, ANY PART OR PARTS FOUND TO BE DEFECTIVE IN MATERIAL AND/OR WORKMANSHIP.

EMISSION-RELATED PARTS ARE:

**THE CARBURETOR ASSEMBLY, COIL ASSEMBLY, ROTOR, SPARKPLUG,
AIR FILTER, FUEL FILTER, INTAKE MANIFOLD, AND THE GASKETS**

ALL OTHER PARTS EXCEPT ABOVE PARTS, FOR TWO (2) YEARS OF HOME USE, ONE (1) YEAR COMMERCIAL USE AND NINETY (90) DAYS FOR RENTAL USE FROM THE DATE OF ORIGINAL PURCHASE, THE COMPANY, THROUGH ANY RedMax DEALER, WILL REPAIR OR REPLACE, FREE OF CHARGE, FOR THE ORIGINAL PURCHASER, ANY PART OF PARTS FOUND TO BE DEFECTIVE IN MATERIAL AND/OR WORKMANSHIP. **THIS IS THE EXCLUSIVE REMEDY.**

THE PURCHASER SHALL BEAR COSTS OF TRANSPORTING THE UNIT TO AND FROM THE RedMax DEALER.

THE PURCHASER SHALL NOT BE CHARGED FOR DIAGNOSTIC LABOR WHICH LEADS TO THE DETERMINATION THAT A WARRANTED PART IS DEFECTIVE, IF THE DIAGNOSTIC WORK IS PERFORMED AT THE RedMax DEALER.

THE PURCHASER OR OWNER IS RESPONSIBLE FOR THE PERFORMANCE OF THE REQUIRED MAINTENANCE AS DEFINED BY THE MANUFACTURER IN THE OWNER/OPERATOR MANUAL.

ANY WARRANTED PART WHICH IS NOT SCHEDULED FOR REPLACEMENT AS REQUIRED MAINTENANCE, OR WHICH IS SCHEDULED ONLY FOR REGULAR INSPECTION TO THE EFFECT OF "REPAIR OR REPLACE AS NECESSARY" SHALL BE WARRANTED FOR THE WARRANTY PERIOD. ANY WARRANTED PART WHICH IS SCHEDULED FOR REPLACEMENT AS REQUIRED MAINTENANCE SHALL BE WARRANTED FOR THE PERIOD OF TIME UP TO THE FIRST SCHEDULED REPLACEMENT POINT FOR THE PART.

ANY REPLACEMENT PART THAT IS EQUIVALENT IN PERFORMANCE AND DURABILITY MAY BE USED IN NON-WARRANTY MAINTENANCE OR REPAIRS, AND SHALL NOT REDUCE THE WARRANTY OBLIGATION OF THE COMPANY.

THE COMPANY IS LIABLE FOR DAMAGES TO OTHER ENGINE COMPONENTS CAUSED BY THE FAILURE OF A WARRANTED PART STILL UNDER WARRANTY.

THE WARRANTY DOES NOT APPLY TO THOSE UNITS WHICH HAVE BEEN DAMAGED BY NEGLIGENCE OF INSTRUCTION LISTED IN THE OWNER/OPERATOR MANUAL FOR PROPER USE AND MAINTENANCE OF THE UNITS, ACCIDENTAL MISHANDLING, ALTERATION, ABUSE, IMPROPER LUBRICATION, USE OF ANY PARTS OR ACCESSORIES OTHER THAN THOSE SPECIFIED BY THE COMPANY, OR OTHER CAUSES BEYOND THE COMPANY'S CONTROL.

THIS WARRANTY DOES NOT COVER THOSE PARTS REPLACED BY NORMAL WEAR OR HARMLESS CHANGES IN THEIR APPEARANCE.

THERE ARE NO OTHER EXPRESS WARRANTIES.

IMPLIED WARRANTIES INCLUDING THOSE OF MERCHANTABILITY AND FITNESS FOR A PARTICULAR PURPOSE **ARE LIMITED** TO TWO (2) YEARS FOR HOME USE, ONE (1) YEAR FOR COMMERCIAL USE AND NINETY (90) DAYS FOR RENTAL USE, FROM THE ORIGINAL DELIVERY DATE.

LIABILITIES FOR INCIDENTAL OR CONSEQUENTIAL DAMAGE UNDER ANY AND ALL WARRANTIES ARE EXCLUDED.

SOME STATES DO NOT ALLOW LIMITATION ON HOW LONG AN IMPLIED WARRANTY LASTS OR EXCLUSION OR LIMITATION OF INCIDENTAL OR CONSEQUENTIAL DAMAGES, SO THE ABOVE LIMITATION OR EXCLUSION MAY NOT APPLY TO YOU.

THIS WARRANTY GIVES YOU SPECIFIC LEGAL RIGHTS, AND YOU MAY ALSO HAVE OTHER RIGHTS WHICH VARY FROM STATE TO STATE.

IF YOU NEED TO OBTAIN INFORMATION ABOUT THE NEAREST SERVICE CENTER, PLEASE CALL RedMax / ZENOAH AMERICA, INC. AT (770)-381-5147.

IMPORTANT: YOU WILL RECEIVE A WARRANTY REGISTRATION CARD AT TIME OF PURCHASE. PLEASE FILL OUT THE CARD AND SEND IT TO RedMax / ZENOAH AMERICA WITHIN SEVEN (7) DAYS. BE SURE TO KEEP A COPY FOR YOUR RECORDS.



RedMax[®]

ZENOAH AMERICA, INC.
1100 Laval Blvd. Suite 110
Lawrenceville, Georgia 30043

Free Manuals Download Website

<http://myh66.com>

<http://usermanuals.us>

<http://www.somanuals.com>

<http://www.4manuals.cc>

<http://www.manual-lib.com>

<http://www.404manual.com>

<http://www.luxmanual.com>

<http://aubethermostatmanual.com>

Golf course search by state

<http://golfingnear.com>

Email search by domain

<http://emailbydomain.com>

Auto manuals search

<http://auto.somanuals.com>

TV manuals search

<http://tv.somanuals.com>