



OWNER'S/OPERATOR'S MANUAL

EXtreme™

EXZ2450S-PH

BC-EX2

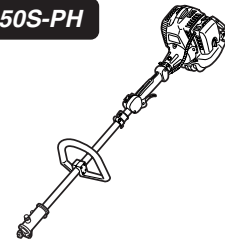
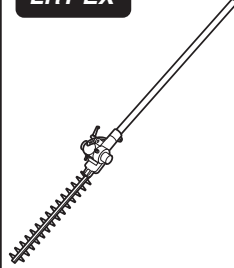
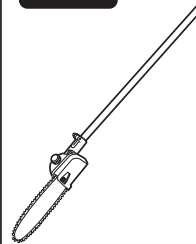
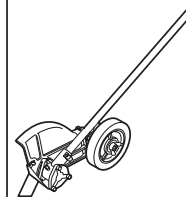
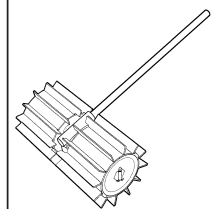
EXZ2450S-PH

LRT-EX

PS-EX

HE-EX2

RMS-EX

WARNING



The engine exhaust from this product contains chemicals known to the State of California to cause cancer, birth defects or other reproductive harm.



WARNING



Before using our products, please read this manual carefully to understand the proper use of your unit.

APPLICABLE SERIAL NUMBERS :

ENGINE UNIT	60100000	and up
PH-EXZ	60300000	and up
BC-EX2	50200000	and up
LRT-EX	000531	and up
PS-EX	000000	and up
HE-EX2	000101	and up
RMS-EX	000101	and up

SAFETY FIRST

Instructions contained in warnings within this manual marked with a  symbol concern critical points which must be taken into consideration to prevent possible serious bodily injury, and for this reason you are requested to read all such instructions carefully and follow them without fail.



■ WARNINGS IN THE MANUAL

WARNING

This mark indicates instructions which must be followed in order to prevent accidents which could lead to serious bodily injury or death.

IMPORTANT

This mark indicates instructions which must be followed, or it leads to mechanical failure, breakdown, or damage.

NOTE

This mark indicates hints or directions useful in the use of the product.

WARNING

1. Read this brushcutter Owner/Operator Manual carefully. Be sure you understand how to operate this unit properly before you use it. Failure to do so could result in serious injury.
2. Be sure to keep this manual handy so that you may refer to it later whenever any questions arise. Also note that you are requested to contact the dealer from whom you purchased the product for assistance the event that you have any questions which cannot be answered herein.
3. Always be sure to include this manual when selling, lending, or otherwise transferring the ownership of this product.
4. Do not lend or rent your machine without the owner's manual.
5. Be sure that anyone using your unit understands the information contained in this manual.
6. Never let a child under 13 years old use the machine.

Contents

1. Parts location	3
2. Specifications	4
3. Warning labels on the machine	5
4. Symbols on the machine	5
5. For safe operation	6
6. Set up	10
7. Fuel and Chain Oil.....	13
8. Operation.....	15
9. Maintenance	23
10. Storage	28
11. Disposal.....	28
12. Troubleshooting guide	28

1. Parts location

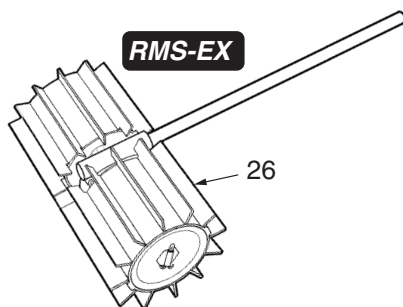
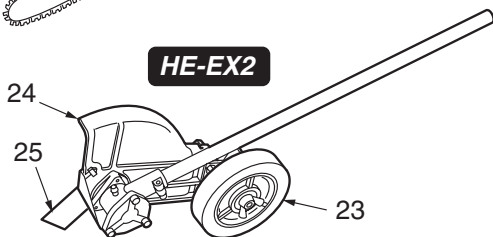
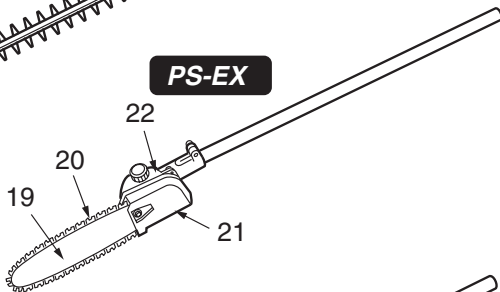
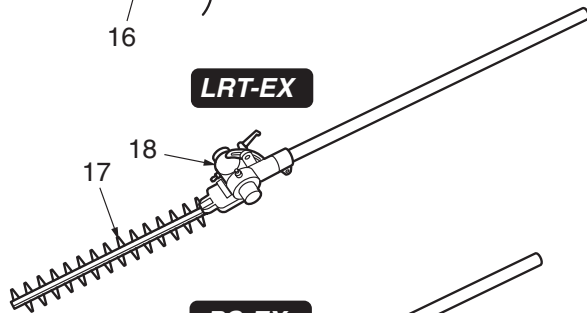
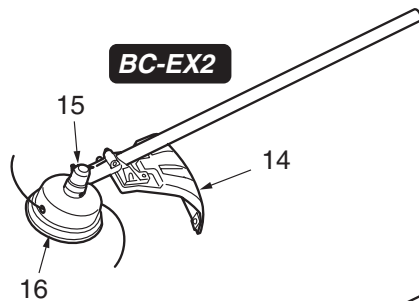
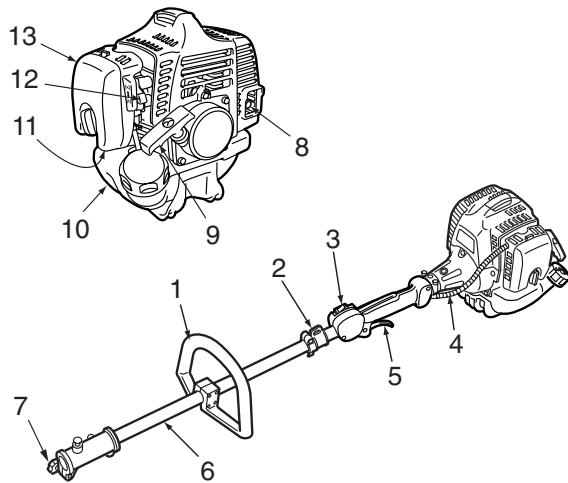

1. Loop handle
2. Suspension point
3. Stop switch
4. Throttle cable
5. Throttle trigger
6. Drive shaft housing
7. Knob bolt
8. Spark arrester
9. Starter knob
10. Fuel tank
11. Primer pump
12. Choke lever
13. Air cleaner cover
14. Debris guard
15. Gear case
16. Cutting line head
17. Blade
18. Gear case
19. Guide bar
20. Saw chain
21. Chain cover
22. Gear case
23. Wheel
24. Blade guard
25. Blade
26. Sweeper belt

2. Specifications

■ Model EXZ2450S-PH

Engine

Type	Air-cooled 2-stroke gasoline
Model	GZ23N
Displacement	1.5cu-in (23.6cm ³)
Max. output	1.15Hp (0.858kW)at 8000/min ⁻¹ (rpm)
Idle speed	3000±200/min ⁻¹ (rpm)
Fuel	Mixture(Gasoline 50 : Oil 1) (when using RedMax genuine oil)
Carburetor	Walbro Diaphragm type
Spark plug	NGK CMR7H
Fuel tank capacity	21.3 fl.oz (0.63 ℓ)
Durability period	300hrs.

■ BC-EX2

Overall size(LxWxH)	70.5(1790)x9.8(250)x12.2(310) in(mm)
Dry weight w/o acc.	11.5 lbs (5.2kg)
Transmission	Centrifugal clutch, Rigid driveshaft
Reduction ratio	1.462
Cutting head rotating direction	Counter-clockwise(Operator view)

■ LRT-EX

Overall size(LxWxH)	90.1(2300)x9.8(250)x12.2(310) in(mm)
Dry weight w/o acc.	13.4 lbs(6.1kg)
Transmission	Centrifugal clutch, Rigid driveshaft
Reduction ratio	4.0
Cutting head	
Type	Reciprocating Double blade
Tooth	28teeth
Pitch	30
Effective cut width	16 in (40cm)
Angle adjust range	90°(±45° from cutting head position aligned shaft)

■ PS-EX

Overall size(LxWxH)	83.9(2100)x9.8(250)x12.2(310) in(mm)
Dry weight w/o bar and chain	11.1 lbs (5.05 kg)
Transmission	Centrifugal clutch, Rigid driveshaft
Reduction ratio	0.94
Cutting head	
Guide bar : Type	OREGON DOUBLE GUARD 109666
: Size	12(300) in(mm)
Saw chain : Type	OREGON 90SG44X
: pitch x guage	3/8x0.042(9.53x1.07) in(mm)
Sprocket	7T
Oil pump	Plunger type

■ HE-EX2

Overall size(LxWxH)	71.2(1810)x9.4(240)x13.2(335) in(mm)
Dry weight w/o acc.	14.5 lbs (7.2kg)
Transmission	Centrifugal clutch, Rigid driveshaft, Bevel gears(Angle:90 deg.)
Reduction ratio	2.538(33.13)
Blade length	7.87(200) in(mm)

■ RMS-EX

Overall size(LxWxH)	71.3(1810)x27(686)x12.2(310) in(mm)
Dry weight w/o acc.	20.5 lbs (9.29kg)
Transmission	Centrifugal clutch, Rigid driveshaft
Reduction ratio	40

Specifications are subject to change without notice.

3. Warning labels on the machine

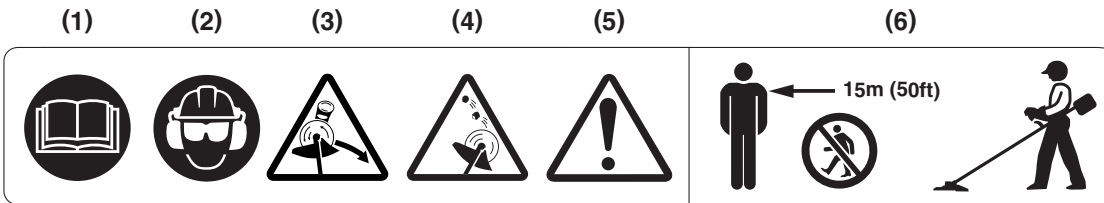

- (1) Read owner/operator manual before operating this machine.
- (2) Wear head, eye and ear protection.
- (3) Warning! Danger of kickback.
- (4) Beware of thrown objects.
- (5) Warning/Attention
- (6) Keep all children, bystanders and helpers 15 meters away from the brushcutter

IMPORTANT

If warning label peel off or become soiled and impossible to read, you should contact the dealer from which you purchased the product to order new labels and affix them in the required location(s).



WARNING

Never modify your brushcutter.

We won't warrant the machine, if you use the remodeled brushcutter or you don't observe the proper usage written in the manual.

4. Symbols on the machine

For safe operation and maintenance, symbols are carved in relief on the machine. According to these indications, please be careful not to take a mistake.

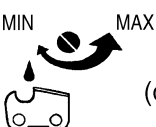
- (a)  (a) The port to refuel the "MIX GASOLINE"
Position: FUEL TANK CAP
- (b)  (b) The direction to close the choke
Position: AIR CLEANER COVER
- (c)  (c) The direction to open the choke
Position: AIR CLEANER COVER
- (EX-PS Only) (d)  (d) If you turn the rod by screwdriver follow the arrow to the "MAX" position, the chain oil flow more, and if you turn to the "MIN" position, less.
Position: Bottom of the GEAR CASE

EMISSION CONTROL

An emission control label is located on the engine.

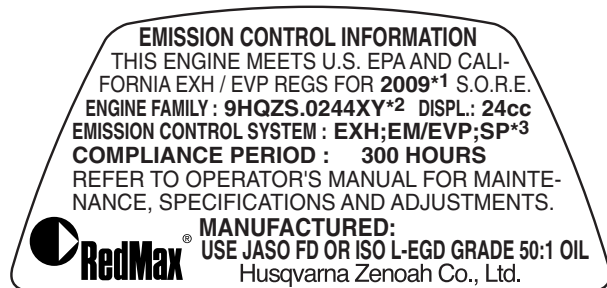

*1: The year will be changed every year of manufacturing.

*2: The initial number will be changed every year of manufacturing.

*3: SP : Sealed tank made of HDPE or PE.

▲ 5. For safe operation

▲ WARNING



- A brushcutter or trimmer can be dangerous if used incorrectly or carelessly, and can cause serious or fatal injury to the operator or others. It is extremely important that you read and understand the contents of this Owner's manual.
- Under no circumstances may the design of the machine be modified without the permission of the manufacturer. Always use genuine accessories and parts. Non-authorized modifications and/or accessories or parts can result in serious personal injury or the death of the operator or others.
- When planning your work schedule, allow plenty of time to rest. Limit the amount of time over which the product is to be used continuously to somewhere around 30 ~ 40 minutes per session. Also try to keep the total amount of work performed in a single day under 2 hours or less.
- If you don't observe the working time, or working manner (See p6), Repetitive Stress Injury(RSI) could occur. If you feel discomfort, redness and swelling of your fingers or any other part of your body, see a doctor before getting worse.



■ Basic safety rules

1. Never operate the product when you are fatigued, ill, or upset, or under the influence of medication that may make you drowsy, or if you are under the influence of alcohol or drugs.
2. Never use the product;
 - a: When the ground is slippery or when you can't maintain a steady posture.
 - b: At night, at times of heavy fog, or at any other times when your field of vision might be limited and it would be difficult to gain a clear view of the working area.
 - c: During rain storms, during lightning storms, at times of strong or gale-force winds, or at any other times when weather conditions might make it unsafe to use the product.
3. Wear the following protective equipments when operating the product.
 - a: Approved helmet to reduce the risk of falling objects.

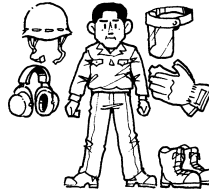

- b: Approved ear protection to reduce the risk of hearing loss.
- c: Approved (ANSI Z87.1.) eye protection and foot protection to reduce the risk of injury associated with thrown objects.
- d: Face filter mask in dusty conditions to reduce the risk of injury associated with the inhalation of dust.
- e: Wear sturdy rubber-soled shoes or shoes with some other form of anti-slip protection to help protect you against falling.
- f: Wear thick anti-vibration gloves to reduce the risk of whitefinger disease.
- g: Do not wear loose clothing, scarves, neck chains, unconfined long hair, and like to reduce the risk of injury associated with objects being drawn into air intake and rotating parts.

Personal protective equipment cannot eliminate the risk of injury but it will reduce the degree of injury.

4. The ignition system of your unit produces an electromagnetic field of a very low intensity. This field may interfere with some pacemakers. To reduce the risk of serious or fatal injury, persons with pacemaker should consult their physician and the pacemaker manufacturer before operating this tool.
5. The area within a perimeter of 50 feet (15 meters) of the person using the product should be considered a hazardous area into which no one should enter. If necessary yellow warning rope, warning signs should be placed around the perimeter of the area. When work is to be performed simultaneously by two or more persons, care should also be taken to constantly look around or otherwise check for the presence and locations of other people working so as to maintain a distance between each person sufficient to ensure safety.
6. Avoid using the product where stable footing and balance are not assured.
7. All product service, other than the items listed in the Owner's Manual, should be performed by competent service personnel.
8. Always shut off the engine before setting it down.
9. Start the engine only in well ventilated areas. Never start or run the engine inside a closed room or building and potentially explosive atmosphere. Exhaust fumes

▲ 5. For safe operation



- contain dangerous carbon monoxide.
- Never to touch the spark plug or plug cord while the engine is in operation. Doing so may result in being subjected to an electrical shock.
 - Never to touch the muffler, spark plug, other metallic parts of the engine or engine cover while the engine is in operation or immediately after shutting down the engine. These metallic parts and engine cover reach high temperatures during operation and doing so could result in serious burns.
 - To reduce the risk of injury associated with contacting rotating parts, stop the engine before installing or removing attachments. Always disconnect the spark plug before performing maintenance or accessing movable parts.

■ Before use

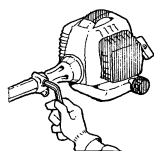

- Each time before starting the engine, inspect the entire unit to see if every part is in good order and is securely tightened in place. If any damage is found in the fuel line, the exhaust line, or the ignition wiring, do not use the product until it has been repaired.

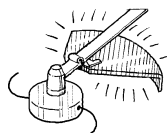

▲ WARNING

- Before starting operation, always make sure that the cutting attachment and the debris guard are properly installed and securely fastened.

- If the cutting head is the metal blade, change the guard and handle as shown in the Owner's manual (see P17).
- Check the condition of working area to avoid any accident by hitting hidden obstacles such as stumps, stones, cans, or broken grass.

⚠ IMPORTANT

Remove any obstacle before beginning work.

■ Starting the engine



- Keep bystanders and animals at least 50 feet (15 meters) away from the operating point. If you are approached, immediately stop the engine.
- The product is equipped with centrifugal clutch mechanism, so the cutting attachment could rotate as soon as the engine is started. When starting the engine, place the product onto the ground in a flat clear area and hold it firmly in

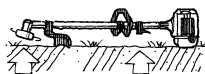

place so as to ensure that neither the cutting part nor the throttle come into contact with any obstacle when the engine starts.

▲ WARNING

Make sure the throttle is at idle position. Never place the throttle into the high speed position or half throttle position (throttle lock position) when starting the engine.

- After starting the engine, check to make sure that the cutting attachment stops rotating when the throttle is moved fully back to its original position (idle position). If it continues to rotate even after the throttle has been moved fully back, turn off the engine and take the unit to your authorized RedMax servicing dealer for repair.

■ Using the product

⚠ IMPORTANT

Cut only materials recommended by the manufacturer. And use only for tasks explained in the manual.



- Grip the handles firmly with both hands using your whole hand. Place your feet slightly apart (slightly further apart than the width of your shoulders) so that your weight is distributed evenly across both legs, and always be sure to maintain a steady, even posture while working.
- Keep cutting attachment below waist level.
- Maintain the speed of the engine at the level required to perform cutting work, and never raise the speed of the engine above the level necessary.
- If you detect abnormal vibration or noise during operation, promptly stop the product and check whether something has broken. If a breakdown has occurred, do not operate the product until the problem is fixed.
- Keep all parts of your body away from rotating cutting attachment.
- Guard against hazardous situations at all times. Warn adults to keep pets and children away from the area. Be careful if you are approached. Injury may result from flying debris.
- If someone calls out or otherwise interrupts you while working, always be sure to turn off the engine before turning around.
- After using the product and other



▲ 5. For safe operation

equipment, CLEAN UP!

■ Transport

1. Drain the fuel from the fuel tank before transporting or storing the product.
2. When hand-carrying the product, cover over the cutting part, lift up the product and carry it paying attention to the blade.
3. Secure the unit carefully to prevent movement when it is transported.
4. A unit that receives a strong shock during transport and unloading may malfunction.

■ Fuel safety

1. Always use caution when handling fuel. It is highly flammable. Wipe up all spills, screw the fuel cap back tightly, and then move the product at least 10 feet (3 meters) from the fueling point before starting the engine.
2. Eliminate all sources of sparks or flame (i.e. smoking, open flames, or work that can cause sparks) in the areas where fuel is mixed, poured, or stored.
3. Do not smoke while handling fuel or while operating the product.
4. Do not refuel a hot engine.
5. Do not refuel a running engine.
6. Keep the handles dry, clean and free of oil or fuel mixture.
7. Always store fuel in an approved container designed for that purpose.



■ Storage

1. Always store the product and fuel so that there is no risk of leakages or fumes coming into contact with sparks or naked flames from electrical equipment, electric motors, relays/switches, boilers and the like.
2. When storing the product, the fuel tank should be emptied.
3. When storing the product, choose a space indoors free from moisture and out of the reach of children.

■ Avoid noise problem

! IMPORTANT

Check and follow the local regulations as to sound level and hours of operations for the product.

1. Operate power equipment only at reasonable hours not early in the morning or late at night when people might be disturbed. Comply with times listed in local ordinances.

2. To reduce sound levels, limit the number of pieces of equipment used at any one time.
3. Operate the product at the lowest possible throttle speed to do the job.
4. Check your equipment before operation, especially the muffler, air intakes and air filters.

■ For protecting your body from vibration

! WARNING

Prolonged use of the product, exposing the operator to vibrations and cold may produce whitefinger disease (Raynaud's phenomenon), which symptoms are tingling and burning sensations followed by loss of color and numbness in the fingers.

All factors which contribute to whitefinger disease are not known, but cold weather, smoking diseases or physical conditions as well as long periods of exposure to vibration are mentioned as factors. In order to reduce the risk of whitefinger disease, the following precautions are strongly recommended.

- a: Keep your body warm. Never use the product during rains.
- b: Wear thick anti-vibration gloves.
- c: Take more than 5 minutes of break in warm place frequently.
- d: Maintain a firm grip at all times, but do not squeeze the handles with constant, excessive pressures.
- e: If you feel discomfort, redness and swelling of your fingers or any other part of your body, see a doctor before getting worse.

■ Maintenance

1. In order to maintain your product in proper working order, perform the maintenance and checking operations described in the manual at regular intervals.
2. Always be sure to turn off the engine and disconnect the spark plug before performing any maintenance or checking procedures.

! WARNING

The metallic parts and engine cover reach high temperatures immediately after stopping the engine.

3. Examine the product at intervals for loose fasteners and rusted or damaged parts. Use special care around the fuel line, the

▲ 5. For safe operation

muffler, and the ignition wiring.

4. When replacing the any other part, or any lubricant, always be sure to use only RedMax products or products which have been certified by RedMax for use with the RedMax product.
5. In the event that any part must be replaced or any maintenance or repair work not described in this manual must be performed, please contact a representative from the store nearest RedMax authorized servicing dealer for assistance.
6. Do not use any accessory or attachment other than those bearing the RedMax mark and recommended for the unit.
7. Under no circumstances should you ever take apart the product or alter it in any way. Doing so might result in the product becoming damaged during operation or the product becoming unable to operate properly.

■ Disposal

When disposing your machine, fuel or oil for the machine, be sure to allow your local regulations.

6. Set up

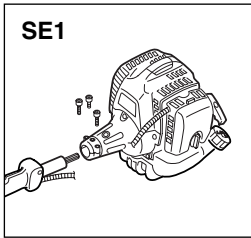

■ MOUNTING ENGINE (SE1)

1. Push the driveshaft housing toward the clutch housing and rotate it by hand to check that the driveshaft is engaged with the gears.
2. Insert the driveshaft housing into the clutch housing until it bottoms, and align the positioning holes on the clutch housing and the shaft tube and install the screw. When difficult to engage, twist the engine slightly.
3. Fasten the clamp securely with two screws.

⚠ IMPORTANT

Tighten the screws gradually by turns.

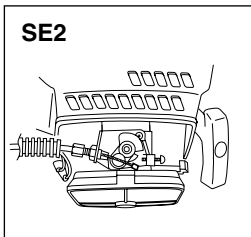

■ CONNECTING THROTTLE WIRE

1. Remove the air cleaner cover.
2. Connect the end of the throttle wire to the joint on the top of the carburetor. (SE2)

■ CONNECTING SWITCH WIRES

- Connect the switch wires between the engine and the main unit. Pair the wires of the same color.

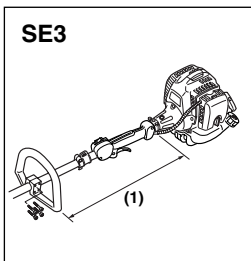

■ INSTALLING HANDLE

(BC-EX2, LRT-EX only) (SE3)

- Install the handle to the shaft tube and clamp it at a location that is comfortable to you.

(1) About 19 inches (48 cm)

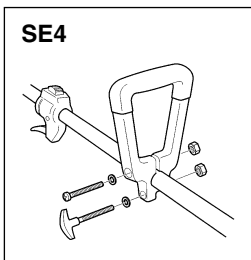

(RMS-EX only) (SE4)

1. Remove both screws from the handle.
2. While spreading the handle at the mounting hole, position the handle on the outer tube as shown.
3. Reinstall the two mounting screws in the handle, but do not tighten them at this time.

📖 NOTE

One side of the handle is recessed to receive the hex nuts.

4. Locate the handle at the best position for operator comfort (usually about

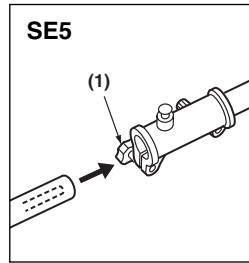

10 inches (25cm) ahead of the throttle lever), and secure it by tightening the knob at the handle base.

■ JOINT ATTACHMENT (SE5)

- Insert the attachment to the main shaft.
- Tighten the knob bolt securely.

(1) Knob bolt

(BC-EX2 only)

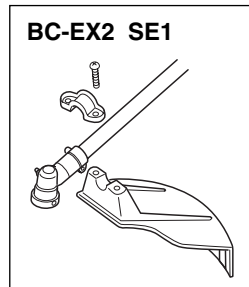

■ INSTALLING DEBRIS GUARD

- Put the debris guard on the gear box, attach it with the screws and hardware provided. (SE1)

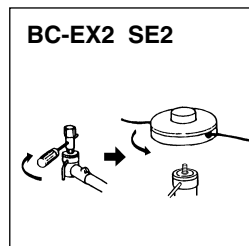

■ INSTALLING LINE HEAD (SE2)

1. While locking the gear shaft, by inserting the supplied tool into the upper holder on the gear box, loosen and remove the hexagon nut (left-handed)
2. Fit the line head assembly to the gear shaft over the holders. Hand-tighten it securely.



■ BALANCE UNIT

1. Put on strap and attach unit to strap.
2. Slide clamp up or down until unit balances with head just touching on the ground. (SE3)

(LRT-EX only)

■ ATTACHING THE TRIMMING MECHANISM (SE1)

1. Remove the screw screwed into the end of the trimming mechanism.
2. Insert the end of the trimming mechanism into the main pipe.
3. Line up the hole on the end of the trimming mechanism into which the screw is to be inserted with the hole on the main pipe, and screw the screw firmly in.
4. Using a wrench, screw in the bolt

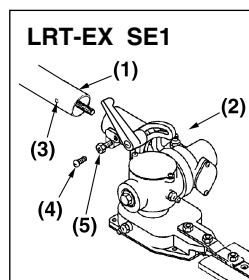

6. Set up

provided to fix the trimming mechanism into place.

- (1) Main pipe
- (2) Trimming mechanism
- (3) Screw hole
- (4) Screw
- (5) Fastening bolt

■ BALANCE UNIT

1. Put on strap and attach unit to strap.
2. Depending on the working posture, slide clamp up or down until unit balances and the strap fits your body.

(PS-EX only)

■ ATTACHING THE PRUNING MECHANISM (SE1)

1. Remove the cap on the end of the main pipe.
2. Remove the screw screwed into the end of the gear case.
3. Insert the end of the gear case into the main pipe.
4. Line up the hole on the end of the gear case into which the screw is to be inserted with the hole on the main pipe, and screw the screw firmly in.
5. Using a wrench, screw in the bolt provided to fix the mechanism into place.

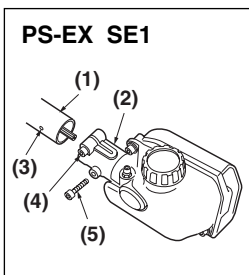

- (1) Main pipe
- (2) Gear case
- (3) Screw hole
- (4) Fastening bolt
- (5) Bolt

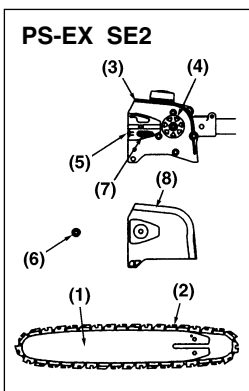

A standard package contains the items as shown below. (SE2)

- (1) Guide bar
- (2) Saw chain
- (3) Gear case
- (4) Sprocket
- (5) Chain tension adjust screw
- (6) Nut
- (7) Chain tensioner nut
- (8) Chain cover

Install the guide bar and the saw chain on the gear case as follows.



The saw chain has very sharp edges. Use protective gloves for safety.

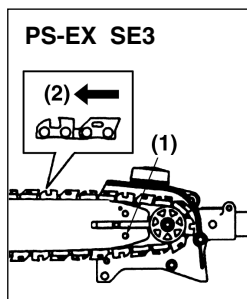

1. Loosen a nut and remove the chain cover.
2. Mount the guide bar then fit the saw chain around the bar and sprocket. (SE3)



Pay attention to the correct direction of the saw chain

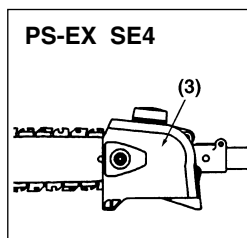

3. Fit the chain tensioner nut into the lower hole of the guide bar, then install the chain cover, and fasten the mounting nut to finger tightness. (SE3)(SE4)

- (1) Hole
- (2) Moving direction
- (3) Chain tensioner nut

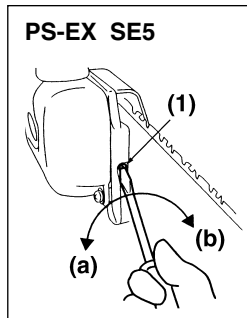

4. Adjust the chain tension by turning the tensioner screw until the tie straps just touch the bottom side of the bar rail. (SE5)

- (1) Chain tension adjusting screw
- (a) Loosen
- (b) Tighten

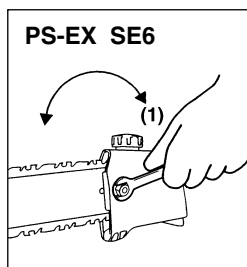

5. Tighten the mounting nut securely with the bar tip held up (TORQUE: 8.9~11.7 N.m./90~120 kg-cm). Then check the chain for smooth rotation and correct tension while moving it by hand. If necessary, readjustment. (SE6)

- (1) Tighten



It is very important to maintain the proper chain tension. Rapid wear of the guide bar or the chain coming off easily can be caused by improper tension. Especially when using a new chain, take good care of it since it should expand when first used.

■ BALANCE UNIT

1. Put on strap and attach unit to strap.
2. Depending on the working posture, slide clamp up or down until unit balances and the strap fits your body.

6. Set up

(HE-EX2 only)

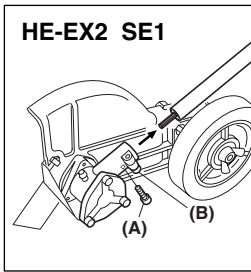

1. Attach the gearbox to the shaft tube as aligning the positioning holes and fasten the screw (A). Fasten the clamp bolt (B) firmly. (SE1)

- (A) Screw
 (B) Clamp bolt
 (B) Tightning Torque: 70~130 in-lb
 (8~15 N.m)

4. Use a cotter pin to secure the drum assembly on the axle (see inset) . The cotter pin is designed to fit tightly against the outboard end of the drum, so you may need to compress the drum face slightly during installation.
5. Repeat Steps 1-4 to install the remaining axle and drum assembly.

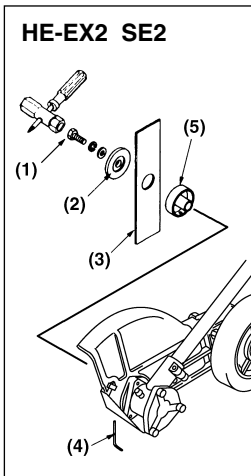

2. Place the blade between the cutter holders (A) and (B) while locking the gear shaft by putting the bar, one of the tools provided, through the key holes on the holder(A) and the gearcase. Use the socket and the screwdriver as shown in the picture below to tighten the blade mounting bolt. (SE2)

- (1) Blade mounting bolt (Left-handed)
 (2) Cutter holder (B)
 (3) Blade
 (4) Bar
 (5) Cutter holder (A)

(RMS-EX only)

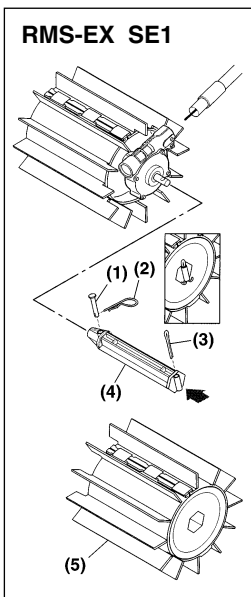

■ SWEEPER ASSEMBLY (SE1)

1. Push one of the drum axles onto either of the two gearcase output shafts. If necessary, rotate the drum axle until the clevis pin hole in the axle aligns with the matching hole in the gearcase output shaft.
2. Use a clevis pin and hitch pin to secure the drum axel to the shaft.
3. Slide the recessed end of a sweeper drum assembly over the assembled axle, and then push the drum down the axel until it bottoms at the clevis pin.

- (1) Clevis Pin
 (2) Hitch Pin
 (3) Cotter Pin
 (4) Drum Axle
 (5) Drum Assembly

! IMPORTANT

The two drum assemblies are identical, but each drum must be installed with its recessed end facing toward the gearcase.

7. Fuel and Chain Oil

FUEL

⚠ WARNING

- Gasoline is very flammable. Avoid smoking or bringing any flame or sparks near fuel. Make sure to stop the engine and allow it cool before refueling the unit. Select outdoor bare ground for fueling and move at least 10 feet (3 m) away from the fueling point before starting the engine.



■ GASOLINE REQUIREMENTS

- All 2-Stroke RedMax Products are powered by RedMax Professional-Commercial Duty, Hi-Performance, Hi-RPM, Air Cooled 2-Stroke engines. RedMax – Hi-Performance 2-stroke engines produce higher HP outputs as compared to standard Home Owner Duty or Light Commercial Duty production engines offered by most manufacturers.
- Exhaust emission are controlled by the fundamental engine parameters and components (eq., carburation, ignition timing and port timing) without addition of any major hardware or the introduction of an inert material during combustion.
- The RedMax Engines are registered and certified with CARB (California Air Resources Board) and EPA (Environmental Protection Agency) to operate on CLEAN Mid-grade 89 octane or Premium, unleaded (lead-free) gasoline and RedMax Air-Cooled "Max Life", Synthetic blend Premium two-stroke engine oil mixed at 50:1 ratio.
- Unleaded gasoline is recommended to reduce the contamination of the air for the sake of your health and the environment.
- This Hi-Performance Air Cooled 2-stroke Engine requires the use of **Minimum** 89 Octane $\left[\frac{R+M}{2} \right]$ (Mid grade or Premium) clean gasoline. Gasoline may contain maximum of 10% Ethanol (grain alcohol) or up to 15% MTBE (Methyl tertiary-butyl ether). Gasoline containing Methanol (Wood Alcohol) is **NOT** approved.

📖 NOTE

- If octane rating of the Mid Grade gasoline in your area is lower than 89 Octane use Premium Unleaded Gasoline. The majority of all 2-stroke engine manufacturers in the USA and Canada recommend using gasoline with 89 Octane or higher.

⚠ WARNING

- Gasoline with an octane rating lower than 89 will greatly increase the engines operating temperature. Low octane gasoline will cause detonation (knock) resulting in piston seizures and major internal engine components damage.
- Poor quality gasolines or oils may damage sealing rings, fuel

lines or fuel tank of the engine.

📖 NOTE

- Failures caused by operating engines on gasoline with octane rating lower than 89 are not covered by the RedMax Two-Stroke engine warranty.

⚠ WARNING

- Alternative Fuels (Not Gasoline)**
Alternative fuels, such as E-15 (15% ethanol), E-20 (20% ethanol), E-85 (85% ethanol) are **NOT** classified as gasoline and are **NOT** approved for use in RedMax 2-stroke gasoline engines. Use of alternative fuels will cause major engine performance and durability problems such as: improper clutch engagements, overheating, vapor lock, power loss, lubrication deficiency, deterioration of fuel lines, gaskets and internal carburetor components, etc... Alternative fuels cause high moisture absorption into the fuel/oil mixture leading to oil and fuel separation.

■ OIL REQUIREMENTS

- Use only RedMax "Max Life", Synthetic blend Premium Air-Cooled two-stroke engine oil or oil certified to ISO-L-**EGD** (ISO/CD1378) standard AND one that is JASO-FD registered. RedMax Air-Cooled "Max Life", Synthetic blend Premium two stroke engine oil and ISO-L-**EGD** (ISO/CD1378) AND JASO-**FD** oils are fully compatible with gasoline's containing 10% Ethanol. RedMax Air-Cooled "Max Life", Synthetic blend Premium two stroke engine oil and ISO-L-**EGD** (ISO/CD1378) AND JASO-**FD** oils are **Universal** and should be mixed at 50:1 ratio for all 2 stroke air cooled engines sold in the past regardless of mixing ratios specified in those manuals.
- If the oil is registered with JASO, the JASO Logo with **FD** and registration number will be displayed on the container. The highest JASO rating is "FD", which equals the ISO-L-**EGD** rating. Lower ratings are "FC", "FB", and "FA".



- Engine problems due to inadequate lubrication caused by failure to use ISO-L-**EGD** certified and JASO **FD** registered oil such as "MaxLife", RedMax Synthetic blend Premium 2-stroke oil **WILL VOID THE REDMAX TWO-STROKE ENGINE WARRANTY.**

⚠ WARNING

- Do not use NMMA (National Marine Manufacturers Association), BIA (Boating Industry Association), and TCW (two cycle water cooled) oils designed for MoPeds or Outboard, water cooled Marine Engines. Do not use API (American Petroleum Institute), TC (Two Cycle) labeled oils. The API-TC

7. Fuel and Chain Oil

test standard has been discontinued by API in 1995 and it no longer exists.

IMPORTANT

Gasoline/Oil mixture Storage Recommendations

Store your gasoline or gasoline/oil mixture in a cool dry area in a tightly sealed approved container to limit the entry of moisture and additional air (oxygen). Moisture and air cause the development of varnish and gum, making the fuel stale. Stored gasoline and gasoline/oil mixture ages and loses its octane rating and volatility. Do not mix more gasoline/oil than you intend to use in 30 days, and 60 days when fuel stabilizer is added. RedMax Air-Cooled "Max Life" Synthetic blend Premium two-stroke engine oil "**Contains fuel stabilizer**" and will automatically extend your gasoline/oil mixture life up to 60 days.

HOW TO MIX FUEL

RECOMMENDED MIXING RATIO

GASOLINE 50 : OIL 1

(when using RedMax Air-Cooled "Max Life")

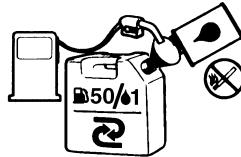

50:1 MIXING CHART

GASOLINE	gal.	1	2	3	4	5
2-CYCLE OIL	fl.oz	2.6	5.2	7.8	10.4	13

GASOLINE	liter	1	2	3	4	5
2-CYCLE OIL	ml	20	40	60	80	100

WARNING

Pay attention to agitation.

1. Measure out the quantities of gasoline and oil to be mixed.
2. Put some of the gasoline into a clean, approved fuel container.
3. Pour in all of the oil and agitate well for 10seconds.
4. Pour in the rest of gasoline and agitate again for at least one minute. As some oils may be difficult to agitate depending on oil ingredients, sufficient agitation is necessary. Be careful that, if the agitation is insufficient, there is an increased danger of early piston seizure due to abnormally lean mixture.
5. Place a clear indication on the outside of the container to avoid mixing up with gasoline or other containers that dont contain oil.
6. Indicate the contents on outside of container for easy identification.

FUELING THE UNIT

1. Untwist and remove the fuel cap. Rest the cap on a clean surface.
2. Put fuel into the fuel tank to 80% of the full capacity.
3. Fasten the fuel cap securely and wipe up any fuel spillage around the unit.

WARNING

1. Select flat and bare ground for fueling.
2. Move at least 10 feet (3 meters) away from the fueling point before starting the engine.
3. Stop the engine before refueling the unit. At that time, be sure to sufficiently agitate the mixed gasoline in the container.

FOR YOUR ENGINE LIFE, AVOID

1. FUEL WITH NO OIL (RAW GASOLINE) – It will cause severe damage to the internal engine parts very quickly.
2. GASOHOL – It can cause deterioration of rubber and/or plastic parts and disruption of engine lubrication.
3. OIL FOR 4-CYCLE ENGINE USE – It can cause spark plug fouling, exhaust port blocking, or piston ring seizure.
4. **Mixed fuels which have been left unused for a period of one month or more** may clog the carburetor and result in the engine failing to operate properly.
5. In the case of storing the product for a long period of time, clean the fuel tank after rendering it empty. Next, Start the engine and run the carburetor dry residual fuel.
6. In the case of scrapping the used mixed oil container, scrap it only at an authorized depository site.

NOTE

- As for details of quality assurance, read the description in the section Limited Warranty carefully. Moreover, normal wear and change in product with no functional influence are not covered by the warranty. Also, be careful that, if the usage in the instruction manual is not observed as to the mixed gasoline, type of oil or fuel to be used. described therein, it may not be covered by the warranty.

(PS-EX only)

CHAIN OIL

Use motor oil SAE #10W-30 all year round or SAE #30 ~ #40 in summer and SAE #20 in winter.

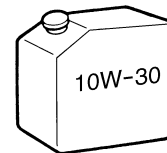

NOTE

Do not use wasted or regenerated oil that can cause damage to the oil pump.

8. Operation

(HE-EX2 only)

The RedMax stick edger is designed for edging lawn in gardens, parks, roadsides and so on.

Before starting the engine, take the operating position and adjust the handle position and the wheel height as necessary.

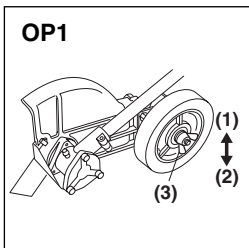

ADJUSTING WHEEL HEIGHT

1. Loosen the wing nut and change the wheel height to obtain desired cutting depth. (OP1)

- (1) Deep cut
- (2) Shallow cut
- (3) Wing nut

2. After adjusting the height, tighten the wing nut securely.

Tightening Torque:
51-68 in-lbs (6-8 N.m)



Never adjust wheel height with the engine running.

■ STARTING ENGINE



The cutting head will start rotating upon the engine starts.

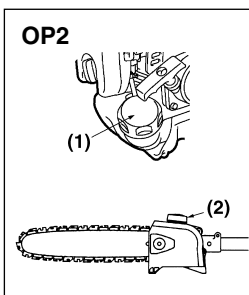

1. Feed fuel into the fuel tank and tighten the cap securely. (OP2)(1)
(PS-EX only) Feed the chain oil into the oil tank and tighten the cap securely, too. (OP2)(2)

- (1) Fuel
- (2) Chain oil

2. Rest the unit on a flat, firm place. Keep the cutting head off the ground and clear of surrounding objects as it will start rotating upon starting of the engine.

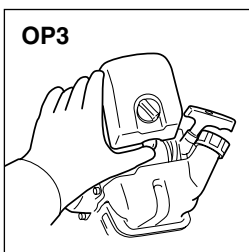

3. Push the primer pump several times until overflow fuel flows out in the clear tube. (OP3)

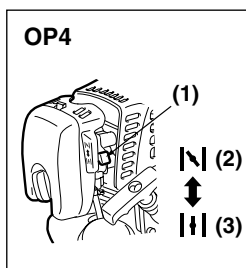

4. Move the choke lever to the closed position. (OP4)

- (1) choke lever
- (2) close
- (3) open

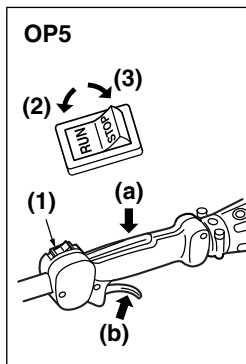

5. Set the stop switch to the "RUN" position. Place the unit on a flat, firm place. Keep the cutting head clear of everything around it. (OP5)

- (1) stop switch
- (2) RUN
- (3) STOP
- (a) lockout lever
- (b) throttle trigger

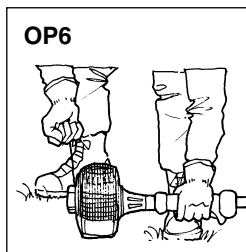

6. Firmly grasp (a) and (b) with left hand, pull the starter knob quickly until engine fires. (OP6)



- Avoid pulling the rope to its end or returning it by releasing the knob. Such actions can cause starter failures.

7. Move the choke lever downward to open the choke. And restart engine. (OP4)
8. Allow the engine to warm up for several minutes before starting operation.



1. When restarting the engine immediately after stopping it, leave the choke open.
2. Overchoking can make the engine hard to start due to excess fuel. When the engine failed to start after several attempts, open the choke and repeat pulling the rope, or remove the spark plug and dry it.

■ STOPPING ENGINE (OP5)

1. Release the throttle lever and run the engine for a half minute.
2. Shift the stop switch to the "STOP" position.



- Except for an emergency, avoid stopping the engine while pulling the throttle lever.

8. Operation

OP7

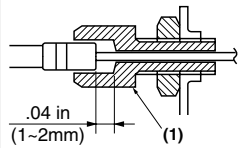

■ ADJUSTING THROTTLE CABLE

- The normal play is 1 or 2mm when measured at the carburetor side end. Readjust with the cable adjuster as required. (OP7)

(1) cable adjuster

OP8

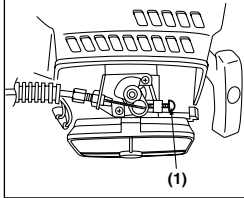

■ ADJUSTING IDLING SPEED (OP8)

- When the engine tends stop frequently at idling mode, turn the adjusting screw clockwise.
- When the cutting head keeps rotating after releasing the trigger, turn the adjusting screw counter-clockwise.

(1) idle adjusting screw



NOTE

- Warm up the engine before adjusting the idling speed.

(BC-EX2 only)

■ CUTTING WORK (LINE HEAD USAGE)



WARNING

- Always wear eye protection such as safety goggles. Never lean over the rotating cutting head. Rocks or other debris could be thrown into eyes and face and cause serious personal injury.
- Keep the debris guard in place at all times when the unit is operated.

TRIMMING GRASS AND WEEDS

- Always remember that the TIP of the line does cutting. You will achieve better results by not crowding the line into the cutting area. Allow the unit to trim at its own pace.

OP9

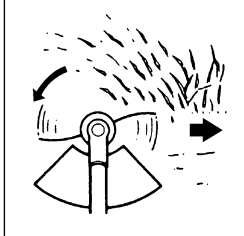

- Hold the unit so the head is off the ground and is tilted about 20 degrees toward the sweep direction. (OP9)
- You can avoid thrown debris by sweeping from your left to the right.
- Use a slow, deliberate action to cut heavy growth. The rate of cutting motion will depend on the material being cut. Heavy growth will require

slower action than will light growth.

- Never swing the unit so hard as you are in danger of losing your balance or control of the unit.
- Try to control the cutting motion with the hip rather than placing the full workload on the arm and hands.
- Take precautions to avoid wire, grass and dead, dry, long-stem weeds from wrapping around the head shaft. Such materials can stall the head and cause the clutch to slip, resulting in damage to the clutch system if repeated frequently.

ADJUSTING THE LINE LENGTH

- Your brushcutters is equipped with a semi- auto type nylon line head that allows the operator to advance the line without stopping the engine. When the line becomes short, lightly tap the head on the ground while running the engine at full throttle.
- Each time the head is bumped, the line advance about 1 inch(25.4 mm). For better effect, tap the head on bear ground or hard soil. Avoid bumping in thick, tall grass as the engine may stall by overload.

8. Operation (BC-EX2 only) Optional blade usage

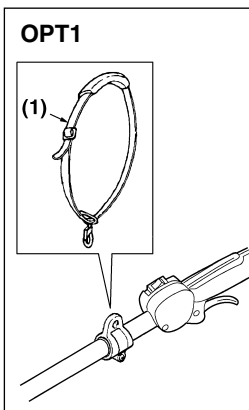

⚠ WARNING

- For security reason, in case of mounting the blade on this product and use it, purchase the blade kit (T3195-94000) and change guard, handle from the original ones, and use shoulder strap.

(1) Shoulder strap : T3300-17100

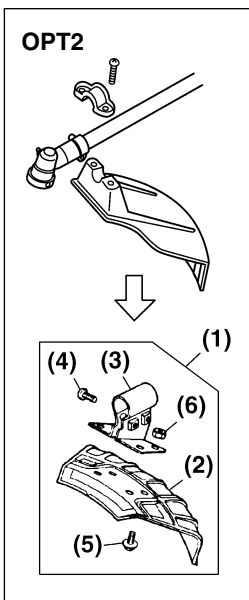

⚠ IMPORTANT

Change to the debris guard which is suitable for the metal blade. (OPT2)

TIGHTENING TORQUE :

130~174 in-lbs
(14.7~19.6 N.m.)

- (1) Guard-A : 5764-24000
(2) Guard : 5766-24110
(3) Bracket : 3250-24120
(4) Bolt : 0225-10620
(5) Screw : 0263-30614
(6) Nut : 0280-10605

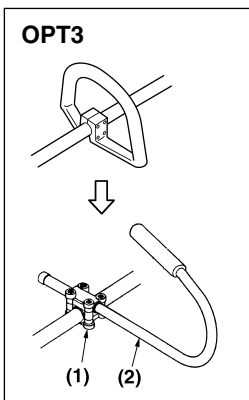

⚠ IMPORTANT

Change the loop handle to the J-handle for safe operation. (OPT3)

- (1) Bracket : 3583-14101
(2) J-handle : 6367-14200

⚠ WARNING

- When sharpening, removing, or reattaching the blade, be sure to wear thick, sturdy gloves and use only proper tools and equipment to prevent injury.

■ CHOOSE THE BLADE

Choose a suitable recommended cutting attachment according to the object to be cut. (OPT4)

- When replacing blade always be sure to use products which have been certified by RedMax.

OPT4	(1) (2)	(3) (4)	(5) (6)	(7)
(A)	○			
(B)		○		
(C)			○	○
(D)				○

- (1) 9" 22-tooth : SST229
(2) 9" 24-tooth : SST249
(3) 8" 8-tooth : SGB088
(4) 9" 8-tooth : SGB089
(5) 8" 4-tooth : SGB048
(6) 9" 4-tooth : SGB049
(7) Nylon line head

- (A) Under growth
(B) Heavy weeds
(C) Light weeds
(D) Grass

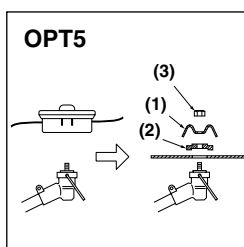

■ SET UP THE BLADE

- Detach the line head assembly. (OPT5)
- Put on the blade, making the marked side face the shaft side, put the holder and the cover on, and fasten the blade with the nut. (OPT5)

- (1) Cover : 3540-13283
(2) Holder (B) : 6019-13250 (STANDARD)
(3) Nut : T3002-13260 (STANDARD)



■ BALANCE UNIT

- Put on strap and attach unit to strap.
- Slide clamp up or down until unit balances with head just touching on the ground. (OPT6)

8. Operation (BC-EX2 only) Optional blade usage

■ STARTING THE ENGINE

Please refer 5.For safe operation (P.7),
8.Operation (P.15).

▲ WARNING

- The product is equipped with a centrifugal clutch mechanism, so the cutting attachment could rotate as soon as the engine is started. When starting the engine, place the product onto the ground in a flat clear area and hold it firmly in place so as to ensure that neither the cutting part nor the throttle come into contact with any obstacle when the engine starts. (OPT7)

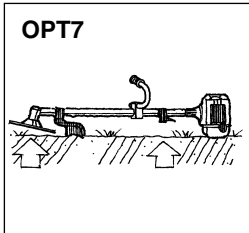

OPT10



- By using the shoulder strap, hang the unit on your right side. Adjust the strap length so that the cutting head may become parallel to the ground. (OPT10)

▲ WARNING

Make sure to use shoulder strap and debris guard. If not, it is very dangerous when you slip or lose your balance.

■ CUTTING METHOD

- Use the front left side cutting.
- Guide the blade from your right to left with it tilted slightly to your left. (OPT8)
- When mowing a wide area, start working from your left end to avoid interference of cut grass.
- The blade may be seized by weeds if the engine speed is too low, or the blade cuts too deep into weeds. Adjust the engine speed and cutting depth according to the condition of object.

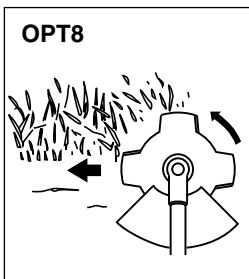

▲ WARNING

■ CONTROLLING BLADE THRUST

- Blade thrust can cause serious personal injury. **Carefully study this section.** It is important that you understand what causes blade thrust, how you can reduce the chance of blade thrust and how you can remain in control of the unit if blade thrust does occur.

▲ WARNING

- If the grass or other object gets caught in the blade, or if the unit starts to shake or vibrate, turn off the engine and check the whole unit. Change the blade if it has been damaged.
- Turn off the engine and make sure the blade has completely stop before checking the blade, and removing any object got caught in.

■ OPERATION

- Check the bolt to fasten the blade and be sure the bolt has no fault, and no abrasion.
- Be sure that the blade and the holder have been fastened according to instruction and the blade turns smoothly without abnormal noise. (OPT9)



▲ WARNING

- The rotating parts fastened incorrectly may cause serious accident to the operator.

1. What causes blade thrust:

- Blade thrust can occur when the moving blade contacts an object that it cannot cut. This contact causes the blade to stop for an instant and then suddenly move or "bounce" away from the object that was hit. The operator can lose control of the unit and the blade can cause serious personal injury to the operator or any person nearby if the blade contacts any part of the body.

2. How you can reduce the chance of blade thrust:

- Recognize that blade thrust can happen. By understanding and knowing about bounce, you can help eliminate the element of surprise.
- Cut fibrous weeds and grass only.** Do not let the blade contact materials it cannot cut such as hard, woody vines and brush or rocks, fences, metal, etc
- Be extra prepared for blade thrust if you must cut where you cannot see the blade making contact such as in

8. Operation (BC-EX2 only) Optional blade usage

areas of dense growth.

- d. **Keep the blade sharp.** A dull blade increase the chance of blade thrust.
- e. Avoid feeding the blade too rapidly. The blade can bounce away from material being cut if the blade is fed faster than its cutting capability.
- f. Cut only from your right to your left.
- g. Keep your path of advance clear of material that has been cut and other debris.

3. How you can maintain the best control:

- a. Keep a good, firm grip on the unit with both hands. A firm grip can help neutralize bounce. Keep your right and left hands completely around the respective handles.
- b. Keep both feet spread apart in a comfortable stance and yet braced for the possibility that the unit could bounce. Do not overreach. Keep firm footing and balance.

■ MAINTENANCE

BLADE

- Check the blade and the fasteners for looseness, cracking, or bending.
- Check the cutting edges and reform with a flat file.

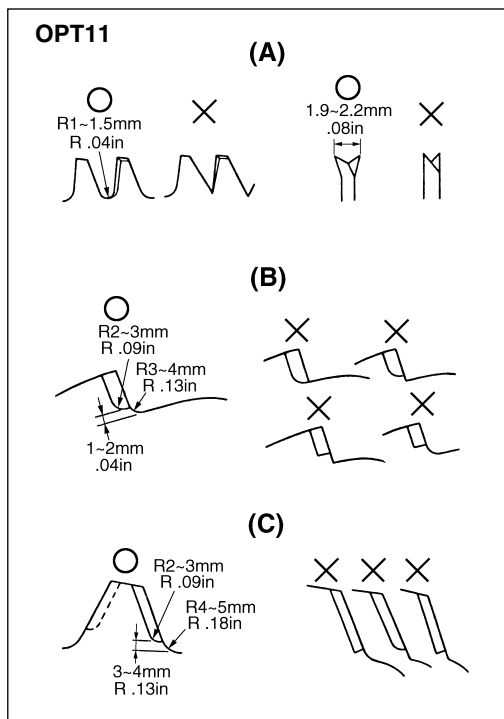

(A) 22, 24-tooth blade

(B) 8-tooth blade

(C) 4-tooth blade

Point (OPT11) :

1. Keep the end corner sharp.
2. Round the root of the edge, using round file.
3. Do not use water when using a grinder.

⚠ IMPORTANT

- It is recommended that filing should be done by professionals.
- Especially regarding filing the 22,24-tooth blade, Leave it to the professionals.

■ TRANSPORTING THE UNIT

- When you finish cutting in one location and wish to continue work in another spot, turn off the engine, and lift up the unit and carry it paying attention for the blade.
- Never forget to place the protective cover over the blades.
- When transporting the unit over long distances, detach the blade fix the unit by ropes.

8. Operation

(LRT-EX only)

⚠ WARNING

This product is equipped with extremely sharp blades, and when used improperly these blades can be extremely dangerous, and improper handling can cause accidents which may in turn lead to serious injury or death. For this reason, you should always be careful to follow the following instructions when using your trimmer.



- Never hold the trimmer in a way in which the blades are pointed towards someone else.
- Never allow the blades to come into proximity with your body while the engine of the trimmer is in operation.
- Always be sure to turn off the engine before changing the angle of the blades, removing branches which have become stuck in the blades, or at any other time when coming into close proximity with the blades.
- Always wear work gloves made of leather or some other sturdy material when using the trimmer.
- Always place the blade cover provided with the trimmer over the blades when not in use.
- **Falling branches may fall onto the face or into the eyes, resulting in injuries, scratches, and cuts, and for this reason you should always be sure to wear a helmet and face protector when using your trimmer.**

⚠ IMPORTANT

The thickness of branches which may be cut using this trimmer is limited to up to approximately 3/16" (5mm). Never try to cut branches thicker than this, as doing so may result in damage to the trimmer.

■ ADJUSTING THE ANGLE OF THE CUTTING BLADES (OP1)

1. Stop the engine.
2. Turn the bolt located on the top of the trimming mechanism counter-clockwise to loosen it.
3. Adjust the angle of the blades to the desired angle, and then fix the bolt firmly back into place.

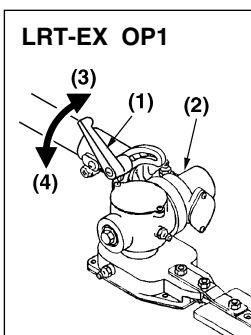

- (1) Clamp lever
- (2) Trimming mechanism
- (3) Tighten
- (4) Loosen

(PS-EX only)

■ CHECKING OIL SUPPLY

After starting the engine, run the chain at medium speed and see if chain oil is scattered off as shown in the figure. (OP1)

- (1) Chain oil

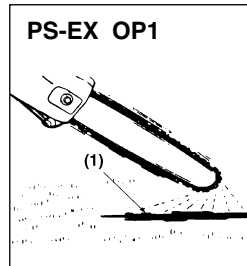

📖 NOTE

The oil reservoir has a capacity sufficient to provide about 40 minutes of cutting time (when set to deliver the minimum flow rate, or about as long as you'll get from a tank of fuel). Be sure to refill the oil tank every time when refueling the saw.

■ ADJUSTING OIL FLOW RATE

⚠ WARNING

Never fill the oil reservoir nor adjust the oiler with the engine running.

⚠ IMPORTANT

An increase in bar oil flow rate will speed oil consumption, requiring more frequent checks on the oil reservoir. To ensure sufficient lubrication, it may be necessary to check the oil level more frequently than at fuel tank refills.

The guide bar and chain are lubricated automatically by a pump that operates whenever the chain rotates. The pump is set at the factory to deliver a minimum flow rate, but it can be adjusted in the field. A temporary increase in oil flow is often desirable when cutting things like hardwood or wood with a lot of pitch.

Adjust the pump as follows:

1. Stop the engine and make sure the stop switch is in the OFF position.
2. Place the unit on its side with the oil reservoir up. (OP2)

- (1) Oil tank
- (2) Chain cover

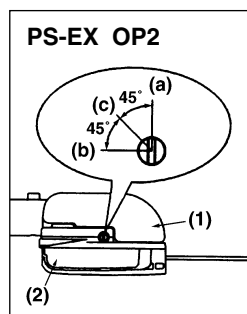

8. Operation

! IMPORTANT

The oil flow adjusting screw must be pressed in slightly in order to turn. Failure to do so could damage the pump and screw.

- With a screwdriver, push in on the oil flow rate adjusting screw and turn in the desired direction (there are three incremental settings):

- Clockwise-decrease lubrication.
- Counter clockwise-increase lubrication.
- Middle

! WARNING



- Always wear work gloves made of leather or some other sturdy material when using the polesaw.
- Falling branches may fall onto the face or into the eyes, resulting in injuries, scratches, and cuts, and for this reason you should always be sure to wear a helmet and face protector when using your polesaw.

(HE-EX2 only)

! WARNING

- Always wear eye protection such as safety goggles. Never lean over the rotating cutting head. Rocks or other debris could be thrown into eyes and face and cause serious personal injury.
- Keep the blade guard and the mad guard attached in place at all times when the unit is operated.
- Before starting a job, check the area and remove all obstacles and objects that could be thrown by the blade.
- Do not adjust the wheel height or try to remove anything entangled to the blade with the engine running.

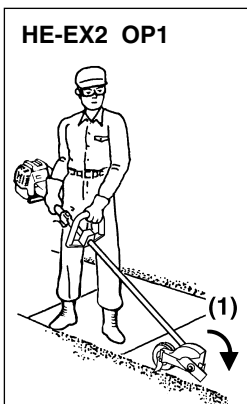

- Before starting the engine, adjust the wheel height for desired cutting depth (See page 15).
- Before starting a job, plan your direction of travel so that you can always hold the edger on you right side and can walk on a hard surface as much as possible.

- When starting to edge, run the engine at full throttle, and slowly have the blade cut into the edge groove.

(1) Direction of rotation

NOTE

- Before edging, make sure the area is soft enough so the blade does not bog down.
- Do not move the edger into the work so fast that the engine or blade bogs down.

(RMS-EX only)

■ BREAK-IN OPERATION

The Properly Dressed Operator (OP1)



- ALWAYS** wear hearing protective devices.
- ALWAYS** wear eye protection such as goggles or safety glasses.
- ALWAYS** wear a mask to protect against dust or other airborne particles.
- ALWAYS** wear close fitting clothes. Gloves offer added protection and are strongly recommended. Do not wear clothing or jewelry that could get caught in machinery.
- ALWAYS** wear leather or heavy-rubber shoes. NEVER work barefooted!
- BEWARE** of thrown debris!
- DIRECTION OF ROTATION

- The RedMax Sweeper works best when its rubber fins can quickly slide or "skim" over the surface being swept.
- New or replacement sweeper belts tend to grip or drag on hard surfaces, and should be thoroughly broken in or "scuffed" before the broom is actually put to work.
- Break-in is easily accomplished by operating the RedMax Sweeper at full throttle for 3 to 5 minutes in loose gravel or similar abrasive material. Once broken in, a RedMax Sweeper will effortlessly move an amazing variety of materials, ranging from snow or standing water to heavier objects such as wood chips or gravel.
- Experience will help you understand the operating principles of the RedMax Sweeper, but safe operation must be practiced from the start.

8. Operation

■ OPERATING TECHNIQUES (OP2)(OP3)(OP4)

Operate the RedMax Sweeper at or near full throttle with its sweeper fins resting on the work surface.

NOTE

- It is both tiring and unnecessary to lift or hold the fins from the work surface during sweeping.
- When sweeping narrow areas such as sidewalks, the RedMax Sweeper can be used to throw material directly ahead of the operator. Clearing wider areas may require sweeping at an angle to create windrows to one side of the path being cleared.
- Windrows of lighter materials often can be combined into one main row or pile for eventual pickup, while heavy or bulky material may need to be collected row-by-row.
- To pull debris from corners, reverse sweeper drum rotation by turning the powerhead over (throttle facing "up") .
- Sweeping corners with the RedMax Sweeper upside down. (OP3)

(1) Direction of rotation

- For long-term inverted operation, loosen the adjustment knob to reverse the handle. (OP4)

(1) Adjustment Knob

WARNING

Reversing the RedMax Sweeper will cause debris to be thrown back toward the operator. When reversing the RedMax Sweeper, use lower throttle settings and beware that thrown debris may also affect your footing!

■ OPERATING AND SAFETY TIPS (OP5)

WARNING

Maintain a shallow angle to the work surface!

- A high angle of operation tends to propel the broom toward you, risking

RMS-EX OP5

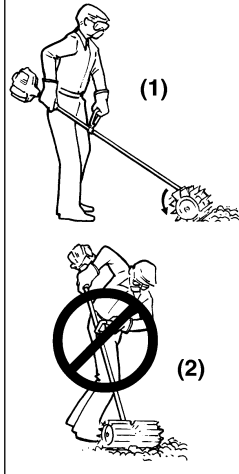

loss of control of the machine.

- (1) Maintain a shallow working angle.
- (2) A steep working angle risks loss of control!

The sweeper belts may rotate when the RedMax Sweeper is started!

- Always maintain a firm grip when starting the RedMax Sweeper. Beware of objects that could become entangled in or be thrown by the rotating sweeper belts.

YOU MUST ALWAYS GUARD AGAINST THROWN DEBRIS!

- Although the RedMax Sweeper's sweeper belts are less forceful than a lawnmower blade, you must avoid any operation where thrown objects could pose a threat to persons or property!

Never operate the RedMax Sweeper if any protective devices (engine covers, stop switch, etc.) are missing or damaged!

Never operate the engine at high rpms without a load!

- Doing so could damage the engine.

Avoid low rpm operation

- Continuous low-rpm operation can lead to premature clutch failure.

■ GENERAL SAFETY INSTRUCTIONS

Work Safely

The operator or bystanders can be injured if the RedMax Sweeper is misused or abused. Never allow a person without training or instruction to operate your machine.

WARNING

Never make unauthorized attachment installations.

Stay Alert

You must be physically and mentally fit to operate this machine safely.

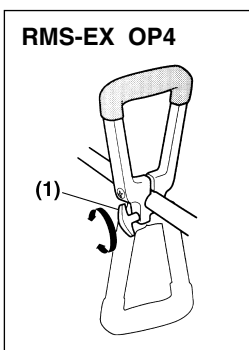
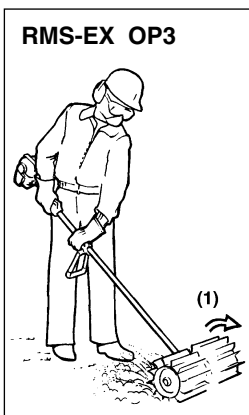
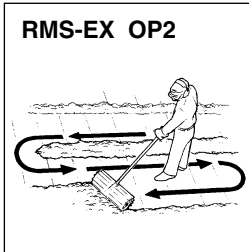

9. Maintenance

Maintenance, replacement, or repair of the emission control device and systems may be performed by any non-road engine repair establishment or individual.

■ MAINTENANCE CHART

	system/component	procedure	before use	every 25 hours after	every 50 hours after	every 100 hours after	note
ENGINE	fuel leaks, fuel spillage	wipe out	✓				
	fuel tank, air filter, fuel filter	inspect/clean	✓	✓			replace, if necessary
	idle adjusting screw	see ■ADJUSTING IDLING SPEED (p.16)	✓				replace carburetor if necessary
	spark plug	clean and readjust plug gap			✓		GAP: .025in(0.6-0.7mm) replace, if necessary
	cylinder fins, intake air cooling vent	clean		✓			
	muffler, spark arrester, cylinder exhaust port	clean				✓	
SHAFT	throttle lever, ignition switch	check operation	✓				
	cutting parts	replace if something's wrong	✓				BC-EX2, LRT-EX, HE-EX2
	debris guard	make sure to attach	✓				BC-EX2, HE-EX2
	gear case	grease		✓			
	screws/nuts/bolts	tighten/replace	✓			✓	not adjusting screws
CUTTING UNIT	oiling port	clean	✓				PS-EX only
	guide bar	clean	✓				PS-EX only
	sprocket	inspect/replace			✓		PS-EX only
	saw chain	inspect/sharp	✓				PS-EX only
	sweeper unit	replace if something's wrong	✓				RMS-EX only

⚠ WARNING

- Make sure that the engine has stopped and is cool before performing any service to the machine. Contact with moving cutting head or hot muffler may result in a personal injury.

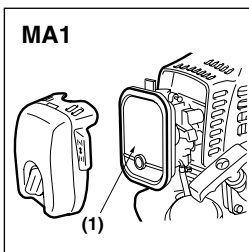

■ AIR FILTER

- The air filter, if clogged, will reduce the engine performance. Check and clean the filter element. If the element is broken or clogged, replace with a new one. (MA1)

(1) air filter

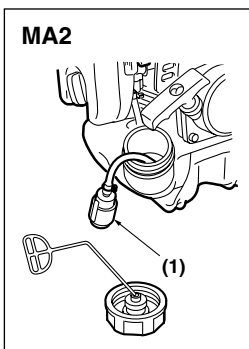

■ FUEL FILTER

- When the engine runs short of fuel supply, check the fuel cap and the fuel filter for blockage. (MA2)

(1) fuel filter

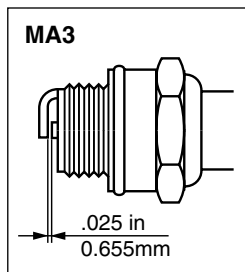

■ SPARK PLUG

- Starting failure and mis-firing are often caused by a fouled spark plug. Clean the spark plug and check that the plug gap is in the correct range. For a replacement plug, use the correct type specified by RedMax. (MA3)
- REPLACEMENT PLUG IS A NGK CMR7H.

⚠ IMPORTANT

- Note that using any spark plug other than those designated may result in the engine failing to operate properly or in the engine becoming overheated and damaged.
- To install the spark plug, first turn the plug until it is finger tight, then tighten it a quarter turn more with a socket wrench.

TIGHTENING TORQUE:

87~104 in-lbs
(9.8~11.8 N.m.)

9. Maintenance

■ MUFFLER

⚠ WARNING

- Inspect periodically, the muffler for loose fasteners, any damage or corrosion. If any sign of exhaust leakage is found, stop using the machine and have it repaired immediately.
- **Note that failing to do so may result in the engine catching on fire.**

■ SPARK ARRESTER

- The muffler is equipped with a spark arrester to prevent red hot carbon from flying out of the exhaust outlet. Periodically inspect and clean as necessary with a wire brush. In the State of California it is required by law (Section 4442 of the California Public Resources Code) to equip a spark arrester when a gas powered tool is used in any forest covered, brush covered, or grass covered unimproved land. (MA4)

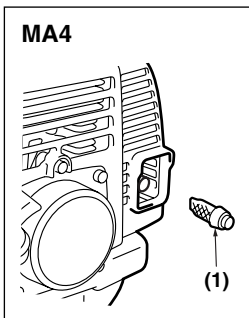

(1) spark arrester

■ INTAKE AIR COOLING VENT

⚠ WARNING

- **Never touch the cylinder, muffler, or spark plugs with your bare hands immediately after stopping the engine. The engine can become very hot when in operation, and doing so could result in severe burns.**
- **When checking the machine to make sure that it is okay before using it, check the area around the muffler and remove any wood chips or leaves which have attached themselves to the brushcutter. Failing to do so could cause the muffler to become overheated, and that this in turn could cause the engine to catch on fire. Always make sure that the muffler is clean and free of wood chips, leaves, and other waste before use.**
- Check the intake air cooling vent and the area around the cylinder cooling fins after every 25 hours of use for blockage, and remove any waste which has attached itself to the brushcutter. Note that it is necessary to remove the

engine cover shown in (MA5) in order to be able to view the upper part of the cylinder.

⚠ IMPORTANT

- If waste gets stuck and causes blockage around the intake air cooling vent or between the cylinder fins, it may cause the engine to overheat, and that in turn may cause mechanical failure on the part of the brushcutter. (MA5)

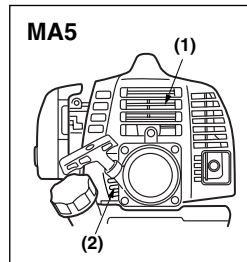

(1) cylinder

(2) intake air cooling vent (back)

■ PROCEDURES TO BE PERFORMED AFTER EVERY 100 HOURS OF USE

1. Remove the muffler, insert a screwdriver into the vent, and wipe away any carbon buildup. Wipe away any carbon buildup on the muffler exhaust vent and cylinder exhaust port at the same time.
2. Tighten all screws, bolts, and fittings.
3. Check to see if any oil or grease has worked its way in between the clutch lining and drum, and if it has wipe it away using oil-free, lead-free gasoline.

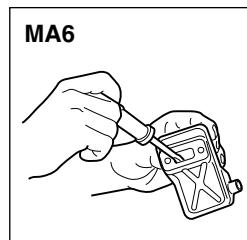

9. Maintenance

⚠ WARNING

Make sure that the engine has stopped and is cool before performing any service to the unit. Contact with any moving parts, the cutting head or a hot muffler may result in personal injury.

(LRT-EX only)

■ BLADES (MA1)

- When refilling the tank or resting, it is often a good idea to use the time to oil the cutting blades.
- If a gap exists between the upper and lower blades, follow the procedure below to adjust them so that they fit more closely together.

1. Loosen lock nut (A) as shown in the diagram.
2. Tighten screw (B) fully, and then turn one-third to one-half of a rotation backward.
3. While holding onto the screw to keep it in position, tighten the lock nut.
4. Check to make sure that the flat washer (C) is loose enough so that it may be turned by pressing on it with a finger.

(1) Upper blade

(2) Lower blade

📖 NOTE

Screwing in the screw too tightly may make it impossible for the blades to move. Conversely, not screwing in the screw tightly enough may make the blades of the trimmer feel dull and cause leaves and branches to become caught in the blades of the trimmer.

QUICK TIP

If the blades become so worn down that it is no longer possible to eliminate the gap between them, you should contact the authorized RedMax servicing dealer from which you purchased your RedMax trimmer to have the blades resharpened or replaced.

■ GEAR CASE

The reduction gears are lubricated by multipurpose, lithium-based grease in the gearcase.

Supply new grease every 25 hours of use or more often depending on the job condition.

When adding lubricant, use a grease gun to insert lubricant into the three grease nipples located on the gear case. (MA2)

(1) Grease fitting

(BC-EX2 only)

■ REFILLING TRIMMING LINE (MA1)

⚠ WARNING

For safety reasons, do not use metalreinforced line.

1. For replacement line, use a diameter of .095in (2.4mm). The spool is capable for a line up to 20feet (6m) on the 4" head. Avoid using a larger line as it may cut down the trimming performance.
2. Pinch the slotted area on the both sides of the spool housing to unhook the bottom cap.
3. Take out the spool and pull off the old line. Fold new line so that one half line is 4.7in.(12cm) shorter than another half. And then, hook bended end in the slot of the spool.
4. Wind up the line in the correct direction as indicated on the spool.
5. Hook each end of the line in the slot on the edge of the spool, and then put the ends through the eyelets on the housing. Make sure that the spring and the washers are in place.
6. While holding the spool against the housing, pull the line ends to release them from the slot.
7. Line up the slot on the bottom cap with the hook on the housing, press the cap against the housing until it clicks.

■ GEAR CASE (MA2)

- The reduction gears are lubricated by multipurpose, lithium-based grease in the gear case. Supply new grease every 25 hours of use or more often depending on the job condition.
- Remove the side bolt in gear case opposite of grease nipple before installing new grease to arrange for old grease to exit.

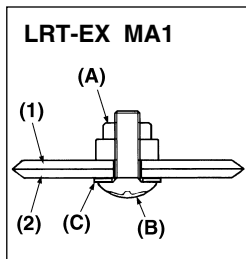

LRT-EX MA2

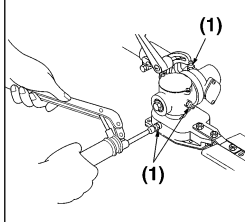

BC-EX2 MA1

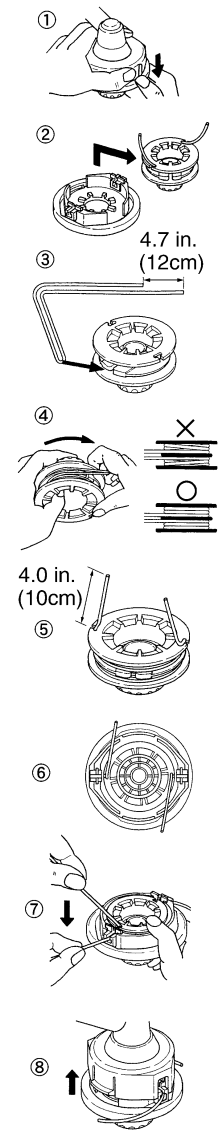

BC-EX2 MA2

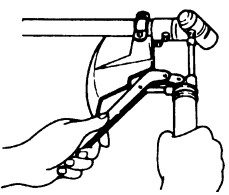

9. Maintenance

(PS-EX only)

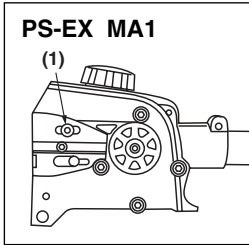

PS-EX MA1

(1)

■ OILING PORT

Dismount the guide bar and check the oiling port for clogging. (MA1)

(1) Oiling port

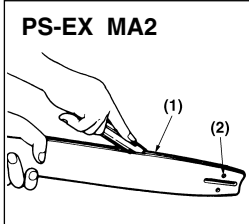

PS-EX MA2

(1)

(2)

■ GUIDE BAR

Remove sawdust in the bar groove and the oiling port. (MA2)

(1) Groove

(2) Oiling port

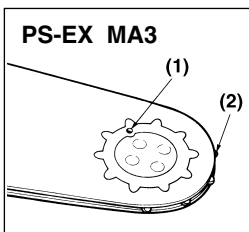

PS-EX MA3

(1)

(2)

(Type: Sprocket nose)

Grease the nose sprocket from the feeding port on the tip of the bar. (MA3)

(1) Grease port

(2) Sprocket

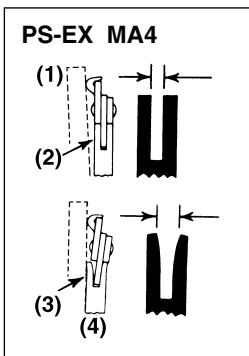

PS-EX MA4

(1)

(2)

(3)

(4)

The bar rail should always be a square. Check for wear of the bar rail. Apply a ruler to the bar and the outside of a cutter. If a gap is observed between them, the rail is normal. Otherwise, the bar rail is worn. Such a bar needs to be corrected or replaced. (MA4)

(1) Ruler

(2) Gap

(3) No gap

(4) Chain tilts

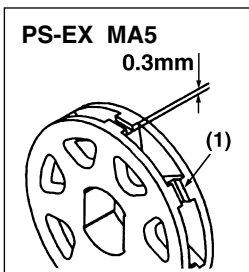

PS-EX MA5

0.3mm

(1)

■ SPROCKET

Check for extensive wear, and replace it when the teeth are worn over 0.3mm. (MA5)

(1) Sprocket

■ SAW CHAIN

▲ WARNING

It is very important for smooth and safe operation to keep the cutters always sharp.

Your cutters need to be sharpened when:

- Sawdust becomes powder-like.
- You need extra force to saw in.
- The cut way does not go straight.
- Vibration increases.
- Fuel consumption increases.

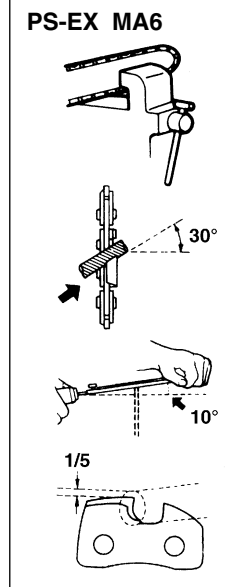

PS-EX MA6

30°

10°

1/5

Cutter setting standards:

▲ WARNING

Be sure to wear safety gloves.

Before filing:

- Make sure the saw chain is held securely.
- Make sure the engine is stopped.
- Use a round file of proper size for your chain.

Chain type : 90SG

File size : 5/32 in (4.0mm)

Place your file on the cutter and push straight forward. Keep the file position as illustrated. (MA6)

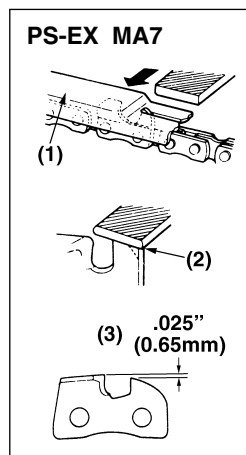

PS-EX MA7

(1)

(2)

(3) .025" (0.65mm)

After every cutter has been set, check the depth gauge and file it to the proper level as illustrated. (MA7)

▲ WARNING

Be sure to round off the front edge to reduce the chance of kickback or tie-strap breakage.

(1) Appropriate gauge checker

(2) Make the shoulder round

(3) Depth gauge standard

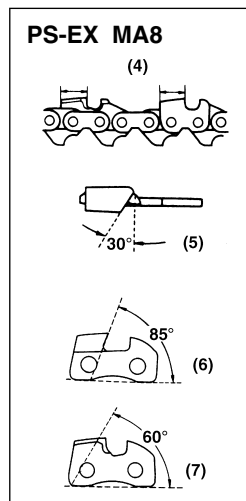

PS-EX MA8

(4)

(5) 30°

(6) 85°

(7) 60°

Make sure every cutter has the same length and edge angles as illustrated. (MA8)

(4) Cutter length

(5) Filing angle

(6) Side plate angle

(7) Top plate cutting angle

■ GEAR CASE

The reduction gears are lubricated by multipurpose, lithium-based grease in the gearcase.

Supply new grease every 25 hours of use or more often depending on the job condition.

When adding lubricant, use a grease gun to insert lubricant into the three grease nipples located on the gear case. (MA9)

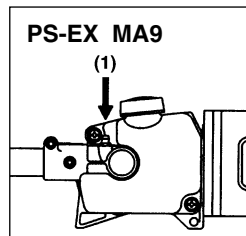

PS-EX MA9

(1)

(1) Grease fitting

9. Maintenance

(HE-EX2 only)

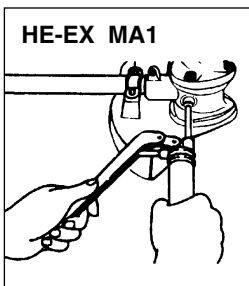

■ GEAR CASE

- The reduction gears are lubricated by multipurpose, lithium-based grease in the gear case. At every 20 hours of use, supply the gear case with new grease.
- Remove the cutter holders before installing new grease to arrange for old grease to exit.



NOTE

- When removing and installing the cutter holder(a), use care not to allow any dirt and dust entering in to the gear case.

(RMS-EX only)

■ GEARCASE LUBRICATION

With the exception of oil leaks or contamination, the RedMax Sweeper's oil filled gearcase is designed to last the life of the machine under normal use:

- It is not necessary to add oil or to "top off" the gearcase under normal operating conditions.
- For continuous heavy-duty applications, (such as where the machine will be stopped only during refueling), RedMax recommends replacing RedMax Sweeper gearcase oil every 40 hours of operation.

■ REPLACING THE GEARCASE OIL (MA1)

Warm the gearcase oil by running the RedMax Sweeper at varying speeds for approximately 8-10 minutes, and then switch the engine to "OFF" and disconnect the spark plug wire at the engine. Use the following procedure to remove and replace all gearcase oil.

1. Remove the drum and axle assemblies (see page 12), and then remove the four end cap bolts and the end cap (the gearcase need not be removed from the RedMax Sweeper).
2. Allow all used gearcase oil to drain into a small container.



WARNING

BURN DANGER! The gearcase and oil will be extremely hot after use!

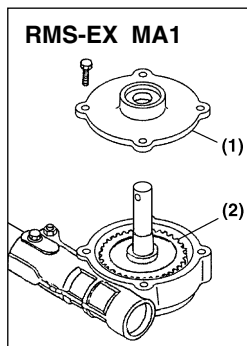

3. Place the RedMax Sweeper main gear flat. Refill the gearcase with Mobil SHC 634 Synthetic Gear Oil to the top of the main gear (60ml – 1.80zs), as shown. **DO NOT OVERFILL! (MA1)**

- (1) End cap
(2) Main gear

4. Apply a continuous bead of loctite ultra grey around the pilot diameter of the end cap. Install the end cap, and then install and firmly tighten the four end cap bolts.
5. Install the drum and axle assemblies, and then reconnect the spark plug wire.



IMPORTANT

- Use only Mobil SHC 634 Synthetic Gear Oil.
- Do not mix other oils or additives with the RedMax Sweeper Gearcase Oil.
- Do not disturb the sealed end plug or bolt on the gearcase (leakage may occur).
- Do not use the RedMax Sweeper if oil is leaking from the gearcase. Return the machine to the dealer for repairs.



WARNING

Make sure that the engine has stopped and is cool before performing any service to the machine. Contact with moving sweeping head or hot muffler may result in a personal injury.

10. Storage

- Aged fuel is one of major causes of engine starting failure. Before storing the unit, empty the fuel tank and run the engine until it uses all the fuel left in the fuel line and the carburetor. Store the unit indoor taking necessary measures for rust prevention.

11. Disposal

- When disposing your machine, fuel or oil for the machine, be sure to allow your local regulations.

12. Troubleshooting guide

Case 1. Starting failure

CHECK	PROBABLE CAUSES	ACTION
fuel tank	→ incorrect fuel	→ drain it and with correct fuel
fuel filter	→ fuel filter is clogged	→ clean
carburetor adjustment screw	→ out of normal range	→ adjust to normal range
sparkign (no spark)	→ spark plug is fouled/wet	→ clean/dry
	→ plug gap is incorrect	→ correct (GAP: 0.6 – 0.7 mm)
spark plug	→ disconnected	→ retighten

Case 2. Engine starts but does not keep running/Hard re-starting.

CHECK	PROBABLE CAUSES	ACTION
fuel tank	→ incorrect fuel or staled fuel	→ drain it and with correct fuel
carburetor adjustment screw	→ out of normal range	→ adjust to normal range
muffler,cylinder (exhaust port)	→ carbon is built-up	→ wipe away
air cleaner	→ clogged with dust	→ replace
cylinder fin, fan cover	→ clogged with dust	→ clean

When your unit seems to need further service, please consult with our service shop in your area.

FEDERAL AND CALIFORNIA EMISSIONS CONTROL WARRANTY
STATEMENT YOUR WARRANTY RIGHTS AND OBLIGATIONS

The EPA (U.S. Environmental Protection Agency), CARB (California Air Resources Board), Environment Canada and RedMax are pleased to explain the emissions control system's warranty on your 2009 and later small off-road engine. In U.S. and Canada, new equipment that use small off-road engines must be designed, built, and equipped to meet the applicable Federal or Californian stringent anti-smog standards. RedMax must warrant the emissions control system on your small off-road engine for the period listed below provided there has been no abuse, neglect or improper maintenance of your equipment. Your emissions control system may include parts such as carburetor, ignition system, catalytic converter, fuel tank, filters and other associated components. Also, included may be hoses, belts, connectors, sensors, and other emission-related assemblies. Where a warrantable condition exists, RedMax will repair your small off-road engine at no cost to you including diagnosis, parts and labor.

MANUFACTURER'S WARRANTY COVERAGE

This emissions control system is warranted for two years or if the product qualifies for a longer warranty period resulting from the type of use, that period shall prevail. If any emissions-related part on your equipment is defective, the part will be repaired or replaced by RedMax.

OWNER'S WARRANTY RESPONSIBILITIES

As the small off-road engine owner, you are responsible for performance of the required maintenance listed in your Owner's Manual. RedMax recommends that you retain all receipts covering maintenance on your small off-road engine, but RedMax cannot deny warranty solely for the lack of receipts or your failure to ensure the performance of all scheduled maintenance. As the small off-road engine owner, you should however be aware that the RedMax may deny you warranty coverage if your small off-road engine or a part has failed due to abuse, neglect, or improper maintenance or unapproved modifications.

You are responsible for presenting your small off-road engine to a RedMax distribution center or service center as soon as the problem exists. The warranty repairs should be completed in a reasonable amount of time, not to exceed 30 days. If you have any questions regarding your warranty coverage, you should contact RedMax at 1-800-291-8251 or via e-mail at service@redmax.com.

WARRANTY COMMENCEMENT DATE

The warranty period begins on the date the engine or equipment is delivered to an ultimate purchaser.

LENGTH OF COVERAGE

RedMax warrants to the ultimate purchaser and each subsequent owner that the engine or equipment is designed, built, and equipped so as to conform with all applicable regulations adopted by EPA and CARB, and is free from defects in materials and workmanship that causes the failure of a warranted part for a period of two years.

WHAT IS COVERED

REPAIR OR REPLACEMENT OF PARTS Repair or replacement of any warranted part under the warranty must be performed at no charge to the owner at a warranty station. Warranty services or repairs will be provided at all RedMax distribution centers that are franchised to service the subject engines. Throughout the emissions warranty period of two years, RedMax must maintain a supply of warranted parts sufficient to meet the expected demand for such parts.

WARRANTY PERIOD Any warranted part that is scheduled for replacement as required in the maintenance schedule, is warranted for the period of time prior to the first scheduled replacement point for that part. If the part fails prior to the first scheduled replacement, the part will be repaired or replaced by RedMax at no cost. Any such part repaired or replaced under warranty is warranted for the remainder of the period prior to the first scheduled replacement point for the part. Any warranted part that is not scheduled for replacement as required in the maintenance schedule, is warranted for two years or if the product qualifies for a longer warranty period resulting from the type of use, that period shall prevail. If any such part fails during the period of warranty coverage, it will be repaired and replaced by RedMax at no cost. Any such part repaired or replaced under the

warranty is warranted for the remaining warranty period. Any warranted part that is scheduled only for regular inspection in the maintenance schedule will be warranted for a period of two years. A statement in such written instructions to the effect of "repair or replace as necessary" will not reduce the period of warranty coverage. Any such part repaired or replaced under warranty will be warranted for the remaining warranty period.

DIAGNOSIS The owner must not be charged for diagnostic labor that leads to the determination that a warranted part is in fact defective, provided that such diagnostic work is performed at a warranty station.

CONSEQUENTIAL DAMAGES RedMax is liable for damages to other engine components proximately caused by a failure under warranty of any warranted part.

EMISSION WARRANTY PARTS LIST

1. Air-induction system*
2. Fuel system*
3. Ignition system*
4. Fuel tank, cap and lines as applicable*

*some components only covered up to point specified by maintenance schedule

WHAT IS NOT COVERED

All failures caused by abuse, neglect or improper maintenance are not covered.

ADD-ON OR MODIFIED PARTS

Add-on or modified parts that are not exempted by CARB or EPA may not be used. The use of any non-exempted add-on or modified parts will be grounds for disallowing a warranty claim. RedMax will not be liable to warrant failures of warranted parts caused by the use of a non-exempted add-on or modified part.

HOW TO FILE A CLAIM

If you have any questions regarding your warranty rights and responsibilities, you should contact your nearest authorized servicing dealer or contact RedMax at 1-800-291-8251 or via e-mail at service@redmax.com.

WHERE TO GET WARRANTY SERVICE

Warranty services or repairs are provided through all RedMax authorized servicing dealers.

MAINTENANCE, REPLACEMENT AND REPAIR OF EMISSION-RELATED PARTS

Any replacement part may be used in the performance of any warranty maintenance or repairs and must be provided without charge to the owner. Such use will not reduce the warranty obligations of the manufacturer.

MAINTENANCE STATEMENT

The owner is responsible for the performance of all required maintenance, as defined in the operator's manual.

Free Manuals Download Website

<http://myh66.com>

<http://usermanuals.us>

<http://www.somanuals.com>

<http://www.4manuals.cc>

<http://www.manual-lib.com>

<http://www.404manual.com>

<http://www.luxmanual.com>

<http://aubethermostatmanual.com>

Golf course search by state

<http://golfingnear.com>

Email search by domain

<http://emailbydomain.com>

Auto manuals search

<http://auto.somanuals.com>

TV manuals search

<http://tv.somanuals.com>