

M30620T-CPE

Compact Emulator for M16C/62 Group M16C/62A

User's Manual

Keep safety first in your circuit designs!

- Renesas Technology Corporation and Renesas Solutions Corporation put the maximum effort into making semiconductor products better and more reliable, but there is always the possibility that trouble may occur with them. Trouble with semiconductors may lead to personal injury, fire or property damage. Remember to give due consideration to safety when making your circuit designs, with appropriate measures such as (i) placement of substitutive, auxiliary circuits, (ii) use of nonflammable material or (iii) prevention against any malfunction or mishap.

Notes regarding these materials

- These materials are intended as a reference to assist our customers in the selection of the Renesas Technology product best suited to the customer's application; they do not convey any license under any intellectual property rights, or any other rights, belonging to Renesas Technology Corporation, Renesas Solutions Corporation or a third party.
- Renesas Technology Corporation and Renesas Solutions Corporation assume no responsibility for any damage, or infringement of any third-party's rights, originating in the use of any product data, diagrams, charts, programs, algorithms, or circuit application examples contained in these materials.
- All information contained in these materials, including product data, diagrams, charts, programs and algorithms represents information on products at the time of publication of these materials, and are subject to change by Renesas Technology Corporation and Renesas Solutions Corporation without notice due to product improvements or other reasons. It is therefore recommended that customers contact Renesas Technology Corporation, Renesas Solutions Corporation or an authorized Renesas Technology product distributor for the latest product information before purchasing a product listed herein. The information described here may contain technical inaccuracies or typographical errors. Renesas Technology Corporation and Renesas Solutions Corporation assume no responsibility for any damage, liability, or other loss rising from these inaccuracies or errors. Please also pay attention to information published by Renesas Technology Corporation and Renesas Solutions Corporation by various means, including the Renesas home page (<http://www.renesas.com>).
- When using any or all of the information contained in these materials, including product data, diagrams, charts, programs, and algorithms, please be sure to evaluate all information as a total system before making a final decision on the applicability of the information and products. Renesas Technology Corporation and Renesas Solutions Corporation assume no responsibility for any damage, liability or other loss resulting from the information contained herein.
- Renesas Technology semiconductors are not designed or manufactured for use in a device or system that is used under circumstances in which human life is potentially at stake. Please contact Renesas Technology Corporation, Renesas Solutions Corporation or an authorized Renesas Technology product distributor when considering the use of a product contained herein for any specific purposes, such as apparatus or systems for transportation, vehicular, medical, aerospace, nuclear, or undersea repeater use.
- The prior written approval of Renesas Technology Corporation and Renesas Solutions Corporation is necessary to reprint or reproduce in whole or in part these materials.
- If these products or technologies are subject to the Japanese export control restrictions, they must be exported under a license from the Japanese government and cannot be imported into a country other than the approved destination. Any diversion or reexport contrary to the export control laws and regulations of Japan and/or the country of destination is prohibited.
- Please contact Renesas Technology Corporation or Renesas Solutions Corporation for further details on these materials or the products contained therein.

Precautions to be taken when using this product

- This product is a development supporting unit for use in your program development and evaluation stages. In mass-producing your program you have finished developing, be sure to make a judgment on your own risk that it can be put to practical use by performing integration test, evaluation, or some experiment else.
- In no event shall Renesas Solutions Corporation be liable for any consequence arising from the use of this product.
- Renesas Solutions Corporation strives to renovate or provide a workaround for product malfunction at some charge or without charge. However, this does not necessarily mean that Renesas Solutions Corporation guarantees the renovation or the provision under any circumstances.
- This product has been developed by assuming its use for program development and evaluation in laboratories. Therefore, it does not fall under the application of Electrical Appliance and Material Safety Law and protection against electromagnetic interference when used in Japan.

For inquiries about the contents of this document or product, fill in the text file the installer of the emulator debugger generates in the following directory and email to your local distributor.

\\SUPPORT\Product-name\SUPPORT.TXT

Renesas Tools Homepage <http://www.renesas.com/en/tools>

Preface

The M30620T-CPE is a compact emulator for the M16C/62 Group M16C/62A of 16-bit microcomputers, which is operated only in the single-chip mode with the real-time trace function.

This user's manual mainly describes specifications of the M30620T-CPE and how to set up and operate it. For details on the following products, which are used with the M30620T-CPE, refer to each product's online manual.

- Emulator debugger: M3T-PD30M
- C compiler: M3T-NC30WA (entry version)
- Integrated development environment: TM

If there is any question or doubt about this product, contact your local distributor.

To use the product properly

Precautions for Safety



- In both this User's Manual and on the product itself, several icons are used to insure proper handling of this product and also to prevent injuries to you or other persons, or damage to your properties.
- The icons' graphic images and meanings are given in "Chapter 1. Precautions for Safety". Be sure to read this chapter before using the product.

Terminology

Some specific words used in this user's manual are defined as follows:

- **Emulator**

This means the M30620T-CPE (this product).

- **Emulator system**

This means an emulator system built around the M30620T-CPE emulator. The M30620T-CPE emulator system is configured with an emulator, host machine and emulator debugger.

- **Host machine**

This means a personal computer used to control the emulator.

- **Emulator debugger**

This means a software tool, M3T-PD30M to control the emulator from the host machine through an communications interface.

In this user's manual, the emulator debugger "M3T-PD30M" is represented as "PD30M". Please read "M3T-PD30M" for "PD30M".

- **Evaluation MCU**

This means the microcomputer mounted on the emulator which is operated in the specific mode for tools.

- **Target MCU**

This means the microcomputer you are going to debug.

- **Target system**

This means a user's application system using the microcomputer to be debugged.

- *

In this user's manual, this symbol is used to show active LOW. (e.g. RESET*: Reset signal)

Contents

Chapter 1. Precautions for Safety	7
1.1 Safety Symbols and Meanings	8
1.2 Declaration Concerning EMC Directive	14
Chapter 2. Usage	15
2.1 Name of Each Part	16
(1) System Configuration	16
(2) Name of Each Part of Emulator	17
2.2 Starting Up the Emulator	19
2.3 Emulator Initial Setup	20
(1) MCU Power Supply Selection Jumper	20
(2) P87/X _{CIN} Selection Switch	20
2.4 Connecting the Emulator System	21
(1) Connecting the Serial Interface Cable	21
(2) Connecting the Power Cable	21
2.5 Connecting the Target system (as occasion demands)	22
2.6 Turning On the Power	23
(1) Checking the Connection of the Emulator System	23
(2) Turning On the Power	23
(3) LED Display When the Emulator Starts Up Normally	24
2.7 Starting Up Emulator Debugger PD30M	25
2.8 Setting the Operating Environment of Emulator Debugger PD30M	25
2.9 When Emulator Debugger PD30M Starts Up Normally	26
Chapter 3. Changing the Settings	27
3.1 Using the Emulator without the Target System	28
3.2 Using the Emulator with the Target System	28
3.3 Using the P87/X _{CIN} Pin as a Port	28
3.4 Using the P87/X _{CIN} Pin as Sub-Clock Input	28
3.5 Selecting Clock Supply	29
(1) Selecting Clock Supply	29
(2) Using the Oscillator Circuit on the Target System	30
(3) Changing the Internal Oscillator Circuit of Emulator	31
Chapter 4. Specifications	33
4.1 Specifications	34
4.2 Memory Map	35
4.3 Electrical Characteristics	36
4.4 Connection Diagram	37
4.5 External Dimensions of the Emulator	38

Chapter 5. Troubleshooting	39
5.1 Troubleshooting Until the Emulator Starts Up	40
(1) Troubleshooting When the Emulator Starts Up	41
(2) Troubleshooting When Emulator Debugger PD30M Starts Up	42
5.2 Troubleshooting When Using Emulator Debugger PD30M	43
5.3 When the Operation of the Emulator is Abnormal	44
(1) Self-check Procedure in the Self-check Mode	44
(2) If an Error is Detected in Self-checks	45
Chapter 6. Maintenance and Guarantee	47
6.1 Maintenance	48
6.2 Guarantee	48
6.3 Repair Provisions	48
6.4 How to Request for Repair	49

Chapter 1. Precautions for Safety

This chapter describes precautions for using this product safely and properly. For precautions for the emulator debugger, refer to user's manual included with your product.



1.1 Safety Symbols and Meanings	8
WARNING Warning for Installation	9
Warning for Use Environment	9
CAUTION Caution to Be Taken for Modifying This Product	9
Cautions to Be Taken for This Product	9
IMPORTANT Note on Malfunctions in the System	9
Notes on Differences between the Actual MCU and Emulator	10
Note on MCU Functions That Cannot Be Used with This Emulator	11
Notes on Using this Product for Debugging Other than M16C/62A	12
Note on Restrictions in Using the Emulator (1/2)	12
Note on Restrictions in Using the Emulator (2/2)	13
Note on Controlling MCU Pins	13
Notes on the Target System (power supply, order of powering on)	13
1.2 Declaration Concerning EMC Directive	14

Chapter 1. Precautions for Safety

In both the user's manual and on the product itself, several icons are used to insure proper handling of this product and also to prevent injuries to you or other persons, or damage to your properties.

This chapter describes the precautions which should be taken in order to use this product safely and properly. Be sure to read this chapter before using this product.

1.1 Safety Symbols and Meanings

	WARNING	If the requirements shown in the "WARNING" sentences are ignored, the equipment may cause serious personal injury or death.
	CAUTION	If the requirements shown in the "CAUTION" sentences are ignored, the equipment may malfunction.
	IMPORTANT	It means important information on using this product.

In addition to the three above, the following are also used as appropriate.

△ means WARNING or CAUTION.
Example:  **CAUTION AGAINST AN ELECTRIC SHOCK**

⊘ means PROHIBITION.
Example:  **DISASSEMBLY PROHIBITED**

● means A FORCIBLE ACTION.
Example:  **UNPLUG THE POWER CABLE FROM THE RECEPTACLE.**

The following pages describe the symbols "WARNING", "CAUTION", and "IMPORTANT".

WARNING

Warning for Installation:



- Do not set this product in water or areas of high humidity. Spilling water or some other liquid into the main unit can cause an unreparable damage.

Warning for Use Environment:



- This equipment is to be used in an environment with a maximum ambient temperature of 35°C. Care should be taken that this temperature is not exceeded.

CAUTION

Caution to Be Taken for Modifying This Product:



- Do not disassemble or modify this product. Disassembling and modifying the product will void your warranty.

Cautions to Be Taken for This Product:



- Use caution when handling the main unit. Be careful not to apply a mechanical shock.
- Do not touch the connector pins of the emulator main unit and the target MCU connector pins directly. Static electricity may damage the internal circuits.
- Do not pull the compact emulator main unit by the serial cable for connecting to the target system. The cable may cause a break.
- Do not use inch-size screws for this equipment. The screws used in this equipment are all ISO (meter-size) type screws. When replacing screws, use same type screws as equipped before.
- The part around the power connector J1 (especially, the IC6 regulator) may get hot. Do not touch it to prevent burn injuries. And, do not apply a voltage other than the specified voltage of the product (4.5 to 7.0 V), because it may cause burn injuries and the failure of internal circuits.

IMPORTANT

Note on Malfunctions in the System

- If the emulator malfunctions because of interference like external noise, shut OFF power to the emulator once and then reactivate it.

IMPORTANT

Notes on Differences between the Actual MCU and Emulator:

- Operations of the emulator differs from those of mask MCUs as listed below.

(1) Reset condition

Set the time for starting up (0.2 to 0.8 Vcc) 1 μ s or less.

(2) Data values of RAM and ROM areas at power-on

When power is turned on, the RAM and ROM areas of the emulator are defaulted to 04H.

(3) Register values when power is turned on

When power is turned on, the emulator's register values are defaulted to 0. However, the program counter is defaulted to the reset vector value (C0000₁₆) initially set by the emulator.

(4) Internal memory (RAM and ROM) capacity, etc.

Because the internal memories (RAM and ROM) are emulated by the emulation memory, the capacity and assignment of the emulator's internal memories differ from those of the actual MCU. For memory mapping, see "4.2 Memory Map" (page 35).

(5) Characteristics of ports P0₀ to P5₇

As ports P0₀ to P5₇ are connected via emulation circuits, the electric characteristics etc. differ from those of actual MCU. The device used for the port emulation circuit is;

Device: M60081L-0142FP

(6) MCU function

Some MCU functions cannot be used in the emulator system. For details, refer to "Note on MCU Functions That Cannot Be Used with This Emulator" (page 11).

(7) Pullup control register

Operations of the pullup control registers are different from those of actual MCUs.

Pullup control register		State of ports P1 ₅ - P1 ₇	
PU03 (P1 ₄ - P1 ₇)	PU11 (P4 ₄ - P4 ₇)	This product	Actual MCU
0	0	Not pulled up	Not pulled up
1	0	Pulled up	Pulled up
0	1	Pulled up*	Not pulled up
1	1	Pulled up	Pulled up

* Not pulled up in actual MCUs.

When pull-up control register 1 for port pins P4₄ - P4₇ (bit 1 of address 3FDh: PU11) is set to "1" (pulled up), port pins P1₅ - P1₇ are also pulled up regardless of the setting of pullup control register 0 for port pins P1₄ - P1₇ (bit 3 of address 3FCh: PU03).

However, this problem arises only in the compact emulator and does not arise in actual MCUs.

- As a pitch converter board and other devices are used between the evaluation MCU and the target system, some characteristics are slightly different from those of the actual MCU. Therefore, be sure to evaluate your system with an evaluation MCU. Before starting mask production, evaluate your system and make final confirmation with an ES (Engineering Sample) version MCU.

IMPORTANT

Note on MCU Functions That Cannot Be Used with This Emulator:

- The following MCU features cannot be used with this emulator.
 - (1) Debugging cannot be done with this emulator in the memory expansion mode or microprocessor mode.

This emulator is specifically designed for use in the single-chip mode. For this reason, debugging is not possible in the memory expansion mode or microprocessor mode.

 - When using this emulator, normally set the processor mode bit in the processor mode register to the "single-chip mode".
 - When using this emulator, set the CNVSS and BYTE pins to "L" level.
 - (2) Oscillation circuits that use a resonator cannot be used.

Because a control gate array is situated between the evaluation MCU and the target system, oscillation circuits that connect a resonator between the X_{IN} and X_{OUT} pins will not oscillate. The same applies to the sub-clock oscillation circuit (X_{CIN}, X_{COUT}): oscillation circuits with a resonator cannot be used. See "3.5 Selecting Clock Supply" (page 29).
 - (3) Watchdog timers cannot be used.

MCU watchdog timers can only be used during program execution (free running). Disable watchdog timers in all other program operations (break, dump, forced stop, etc.).

Also, if the target system has a watchdog timer in its reset circuit, disable it, too, when using the emulator.
 - (4) The BRK command cannot be used.

The BRK command cannot be used. The vector address of the BRK interrupt is normally indicated in the emulator work area, and the vector address value cannot be changed.
 - (5) Single step interrupts cannot be used.

Single step interrupts cannot be used. The vector address of a single step interrupt is normally indicated in the emulator work area, and the vector address value cannot be changed.
 - (6) The DBC* interrupt (debug interrupt) cannot be used.

The DBC* interrupt cannot be used. The vector address of the DBC* interrupt is normally indicated in the emulator work area, and the vector address value cannot be changed.
 - (7) Software resets cannot be used.

Do not use software resets.
 - (8) A-D input group select function is unusable.

The A-D input group select function (M16C/62T Group-only function) cannot be used.
 - (9) Flash memory and EPROM modes are not emulated.

This emulator does not emulate the flash memory and EPROM modes. Also, the emulator does not emulate the CPU rewrite mode in the flash memory mode.

IMPORTANT

Notes on Using this Product for Debugging Other than M16C/62A:

- This emulator is equipped with M30622SAFP (M16C/62A Group) as an evaluation MCU and emulates M16C/62A Group MCUs. In some functions of there are differences between the MCUs of M16C/62A Group and the MCUs of other than M16C/62A Group.

Therefore when you use this emulator for debugging an MCU of other than M16C/62A Group, be careful about the differences of functions of each MCU.

For details on the functions of each MCU, see datasheets and user's manuals of each MCU.

- This product cannot be used in the operating frequency and the operating power voltage exceeding the guaranteed range.

Note on Restrictions in Using the Emulator (1/2):

- The following restrictions apply to this emulator.
 - (1) Debug command execution when the BCLK is stopped
When the BCLK is stopped, debug commands (break, dump, single-step, forced stop, etc.) cannot be executed. The BCLK can stop in the following cases.
 - When the target clock is not oscillating
 - When the target MCU is on hold
 - When the target MCU is in the stop mode
 - (2) MCU status during program hold
With this emulator, the program can be stopped by putting the MCU on hold. Note that, in this case, peripheral circuits are still operating.
 - (3) Interrupts during single step execution
Interrupts are disabled during single step execution. Accordingly, interrupt processing is not performed even if an interrupt request is sent.
 - (4) Address matched interrupt
Do not set software breaks for an address for which an address matched interrupt is set. In step execution, do not execute addresses that generate address matched interrupts.
 - (5) Stop and wait modes
Do not use a single step for the command that shifts to the stop mode. Operation does not shift to the wait mode when the command that shifts to the wait mode is executed as a single step.
 - (6) Stack area
With this emulator, user stacks specified by ISP consume 4 bytes. If there isn't enough user stack area, using other areas not designed for use as stacks (SFR area, RAM area that stored data or ROM area) can damage the user program or destabilize emulator control. Therefore, ensure a maximum +4 bytes of the area used by the user program as user stack area.
 - (7) Trace results for addresses that set software breaks
Software breaks replace the original command with the BRK command that generates the BRK interrupt. When trace results are viewed in the bus display, "00₁₆" is displayed by fetching (by command) the address that sets the software break, however in the reverse assembly display, the "BRK" command is displayed.
 - (8) Protect register (PRC2)
When the protect register (PCR2) that enables writing in the port P9 direction register and the SI/O3 and 4 control registers is changed in the following way, the protect is not cancelled.
 - 1) When the "command that sets PRC2 to '1' is executed (step execution)"
 - 2) When the program is executed with a break point set between the "command that sets PRC2 to '1'" and "when the register to be protected is set"
 - 3) When "PRC2 is set to '1'" in the Dump or Script windows

IMPORTANT

Note on Restrictions in Using the Emulator (2/2):

- The following restrictions apply to this emulator.
 - (9) Debug command execution during user program execution
The real-time aspect of the user program is not guaranteed when debug commands such as dump are executed during user program execution.
 - (10) DMA transfer
With this product, the program is stopped by putting the MCU on hold. Therefore, if a DMA request is generated by a timer or other source while the program is stopped, DMA transfer is executed. However, make note of the fact that DMA transfer while the program is stopped may not be performed correctly. Also note that the below registers have been changed to generate DMA transfer as explained here even when the program is stopped.
 - DMA0 transfer counter TCR0
 - DMA1 transfer counter TCR1

Note on Controlling MCU Pins:

- Some MCU pins are controlled by the emulator.
 - (1) RESET* input
The RESET* input from the target system is accepted only while a user program is being executed (only while the RUN status LED of the emulator is lit).
 - (2) NMI* input
The NMI* input from the target system is accepted only while a user program is being executed (only while the RUN status LED of the emulator is lit).

Notes on the Target System (power supply, order of powering on):

- When the target system is connected, be sure to set the JP1 of the emulator to "EXT".
 - This emulator cannot supply the power to the target system. Therefore design your system so that the target system is powered separately.
 - This emulator consumes max. 500 mA of electric current from the target system.
 - The voltage of the target system should be within the range of 3.0 to 5.0 V.
 - Before powering on your emulator system, check that the host machine, the emulator, the converter board and target system are all connected correctly. Next, turn on the power to each equipment following the procedure below.
 - (1) Turn ON/OFF the target system and the emulator as simultaneously as possible.
 - (2) When the emulator debugger starts up, check the target status LEDs on the emulator to see if this product is ready to operate.

Is the power supplied?	: Check that target status LED (POWER) is ON.* ¹
Is the clock supplied?	: Check that target status LED (CLOCK) is ON.
- *¹ When the target system is not connected, the target status LED (POWER) is not lit.

1.2 Declaration Concerning EMC Directive



RENESAS TECHNOLOGY EUROPE LTD
DUKES MEADOW, MILLBOARD ROAD, BOURNE END
BUCKINGHAMSHIRE, SL8 5FH, UNITED KINGDOM

Declaration concerning EMC Directive and UK EMC regulations No. SI 2372 including amendments SI 3080 & SI 3180

The **M30620T-CPE** is only intended for use in a laboratory or classroom environment. It does however meet the emission requirements of EN 55022:1995 Class A.

Its use outside the classroom, laboratory, study area or similar such area invalidates conformity with the protection requirements of the Electromagnetic Compatibility Directive (89/336/EEC) and could lead to prosecution (ref SI2080).

Everywhere you imagine.

Page 1 of 1

Chapter 2. Usage

This chapter describes how to operate this product.

2.1 Name of Each Part	16
(1) System Configuration	16
(2) Name of Each Part of Emulator	17
2.2 Starting Up the Emulator	19
2.3 Emulator Initial Setup	20
(1) MCU Power Supply Selection Jumper	20
(2) P87/XCIN Selection Switch	20
2.4 Connecting the Emulator System	21
(1) Connecting the Serial Interface Cable	21
(2) Connecting the Power Cable	21
2.5 Connecting the Target system (as occasion demands)	22
2.6 Turning On the Power	23
(1) Checking the Connection of the Emulator System	23
(2) Turning On the Power	23
(3) LED Display When the Emulator Starts Up Normally	24
2.7 Starting Up Emulator Debugger PD30M	25
2.8 Setting the Operating Environment of Emulator Debugger PD30M	25
2.9 When Emulator Debugger PD30M Starts Up Normally	26

Chapter 2. Usage

2.1 Name of Each Part

(1) System Configuration

Figure 2.1 shows the system configuration for this emulator.

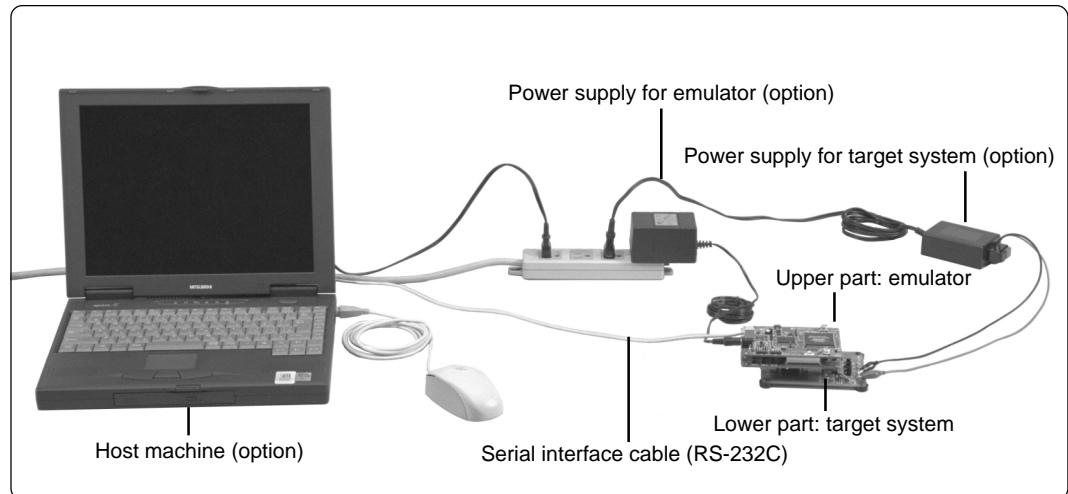

Figure 2.1 System configuration

(1) Emulator M30620T-CPE (included)

This is a compact emulator for the M16C/62 Group M16C/62A of 16-bit microcomputers which is operated only in the single-chip mode with the real-time trace function (hereafter, emulator).

(2) Serial interface cable (included)

This is an interface cable for the host machine and the emulator.

(3) Power supply for emulator (option)

This is a power supply for the emulator. Supply 4.5 to 7.0 V (DC).

Prepare the power supply separately. The power cable is included with this product.

(4) Target system

This is your application system. This emulator can be used without the target system.

(5) Power supply for the target system

This is a power supply for the target system. As this emulator cannot supply the power to the target system, supply the power to the target system separately from the emulator.

(6) Host machine (option)

This is a personal computer for controlling the emulator.

(2) Name of Each Part of Emulator

Figure 2.2 shows the name of each part of the emulator.

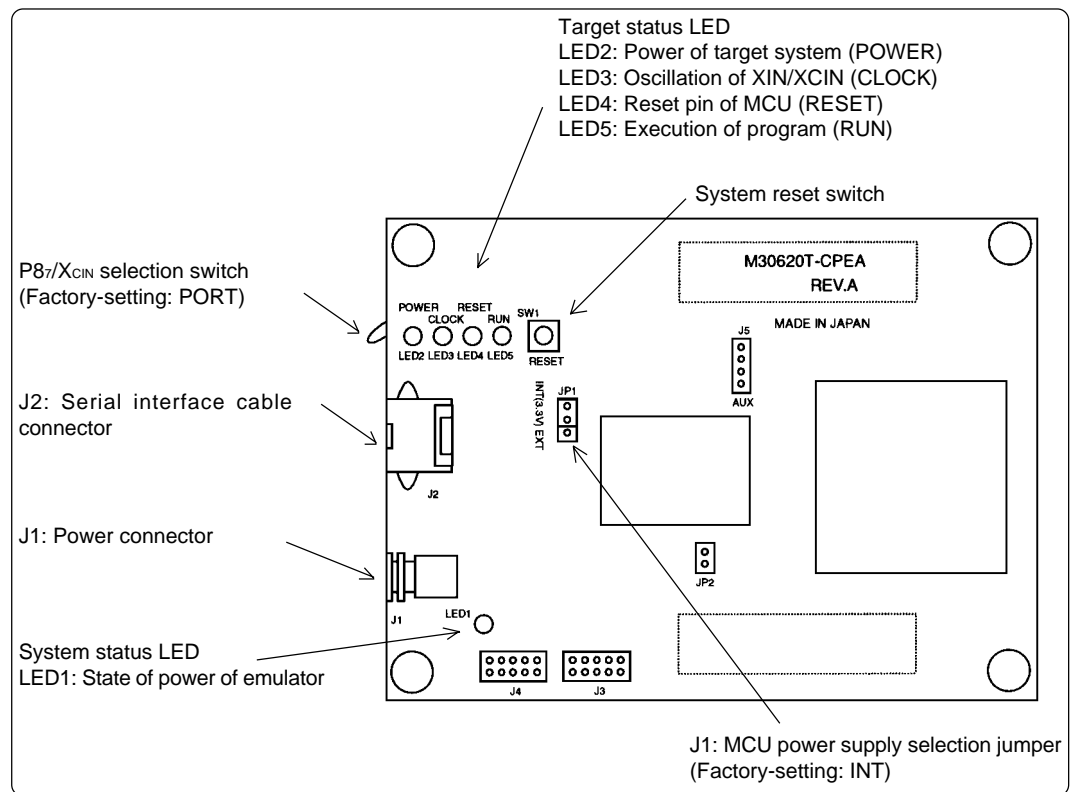

Figure 2.2 Name of each part of emulator (upper side of M30620T-CPE)

(1) System status LED

The system status LED indicates the emulator main unit's power supply. Table 2.1 lists the definition of system status LED.

Table 2.1 Definition of system status LED

Name	Number	Color	Status	Function
POWER	LED1	Orange	ON	Emulator power supply is turned on.
			OFF	Emulator power supply is turned off.

(2) Target status LED

The target status LEDs indicate the target MCU's power supply and operating status. Table 2.2 lists the definition of each target status LED.

Table 2.2 Definition of target status LEDs

Name	Number	Color	Status	Function
POWER	LED2	Orange	ON	Power is supplied from the target MCU.
			OFF	Power is not supplied from the target MCU.
CLOCK	LED3	Green	ON	Clock X _{IN} or X _{CIN} is supplied to the target MCU.
			OFF	Clock is not supplied to the target MCU.
RESET	LED4	Red	ON	Target MCU is reset.
			OFF	Target MCU is not reset.
RUN	LED5	Green	ON	User program is being executed.
			OFF	User program has been halted.

(3) System reset switch

By pressing the system reset switch, you can initialize the emulator system. Table 2.3 shows the functions of the system reset switch depending on the state of emulator.

Table 2.3 Functions of system reset switch

State of Emulator	Function
When the user's program is halted	Initializes the emulator and waits for commands from the emulator debugger.
When the user's program is executed	Stops the user's program, initializes the emulator, and waits for commands from the emulator debugger.

CAUTION

Note on System Reset Switch:

- After pressing the system reset switch, reboot the emulator debugger PD30M. Otherwise the display of emulator debugger and the actual value (in the emulator) may not match.
- When the emulator debugger does not start up normally even after rebooting, turn off the emulator and then turn on again.

2.2 Starting Up the Emulator

The procedure for starting up the emulator is shown in Figure 2.3. For details, refer to each section hereafter. And, when the emulator does not start up normally, refer to "Chapter 5. Troubleshooting" (page 40).

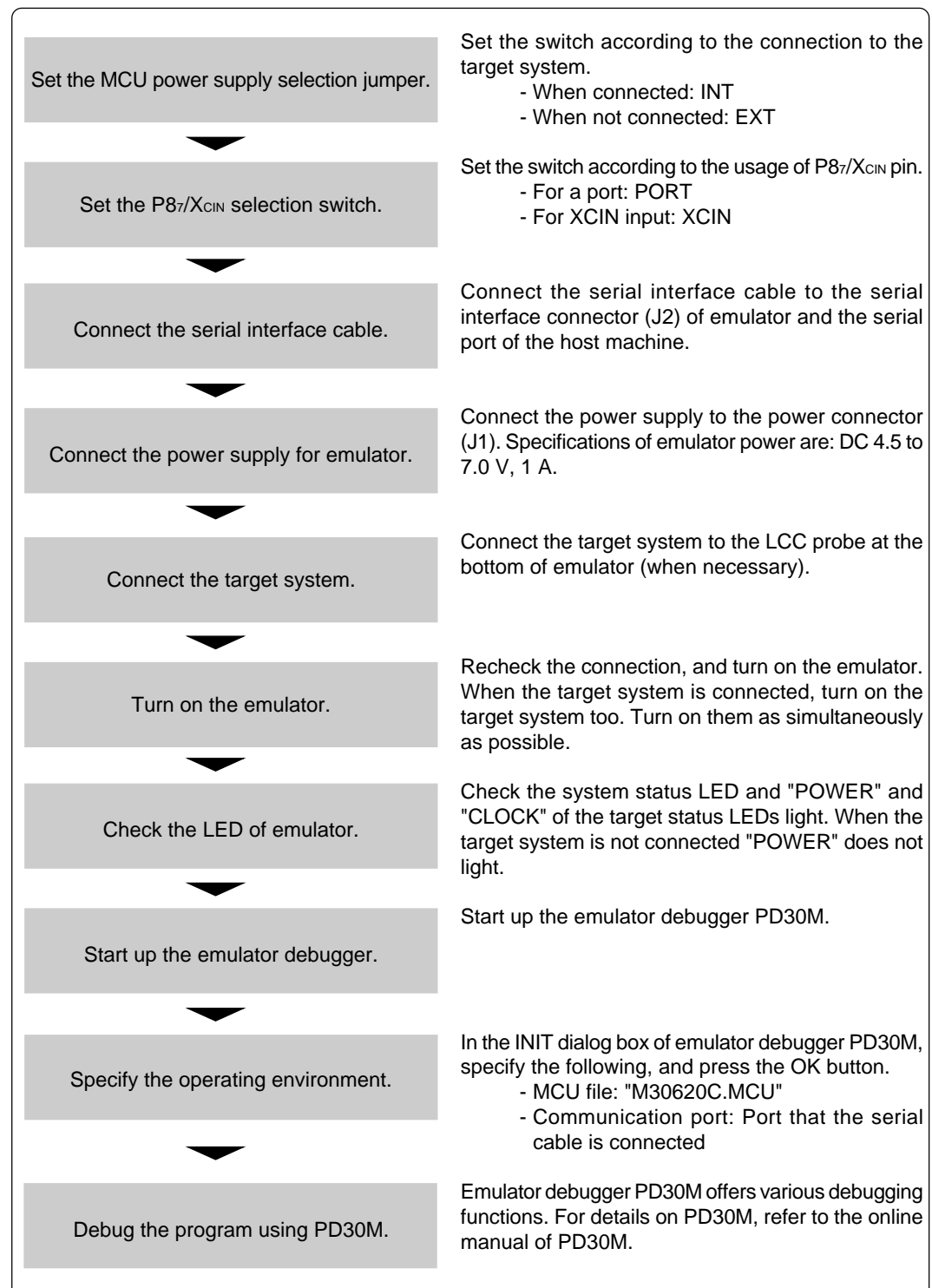

Figure 2.3 Procedure for starting up the emulator

2.3 Emulator Initial Setup

Set the MCU power supply selection jumper and the P87/XCIN selection switch of the emulator according to conditions of use.

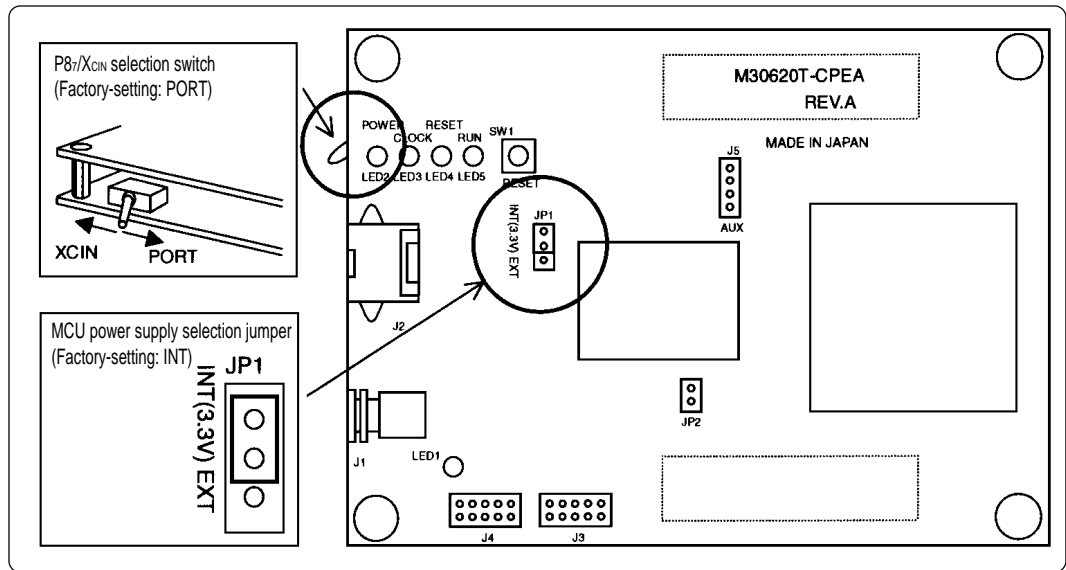

Figure 2.4 Emulator initial setup

(1) MCU Power Supply Selection Jumper

This is the jumper switch to select power supply to the MCU. As shown in Table 2.4 below, set the switch according to the connection to the target system. Any settings not listed in Table 2.4 are not allowed.

Table 2.4 Setting MCU power supply selection jumper

Connection to target system	MCU power supply selection jumper	Description
Not connected	Set to "INT" (Do not set to "EXT")	Power of MCU is supplied from the emulator. Operating voltage: 3.3 V
Connected	Set to "EXT" (Do not set to "INT")	Power of MCU is supplied from the target system. This emulator consumes max. 500 mA of electrical current from the target system.

(2) P87/XCIN Selection Switch

This is the switch to select the function of P87/XCIN pin. As shown in Table 2.5 below, set the switch according to the usage of P87/XCIN pin.

Table 2.5 Setting P87/XCIN selection switch

Usage	P87/XCIN selection switch
Using as a port	Set to "PORT"
Using as XCIN input	Set to "XCIN"

CAUTION

Note on Setting Switches and Jumper Switches:

- Always shut OFF when changing the setting of the switches and jumper switches, and connecting the cable.

2.4 Connecting the Emulator System

How to connect the emulator system is shown in Figure 2.5 below.

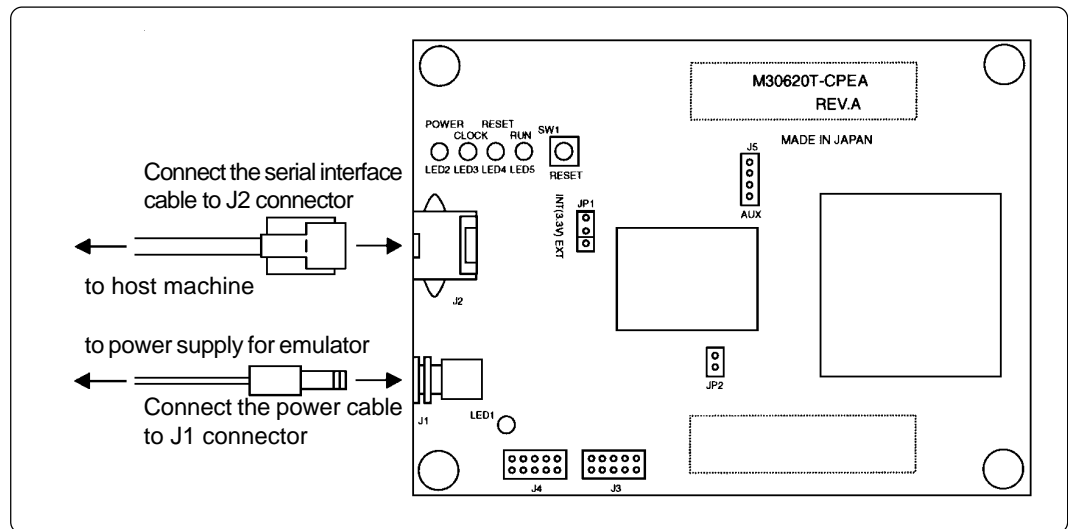

Figure 2.5 Connecting the emulator system

(1) Connecting the Serial Interface Cable

Connect the serial interface cable (included) to the serial interface connector (J2) and the serial port of the host machine (see Figure 2.5).

(2) Connecting the Power Cable

Connect the power supply for the emulator to the power connector (J1). The specifications of the power supply for the emulator are listed in Table 2.6.

Table 2.6 Specification of power supply of emulator

Power supply voltage	DC 4.5 to 7.0 V, 1 A
----------------------	----------------------

Figures 2.6 and 2.7 show the specifications of the power connector and the applicable plug, respectively.

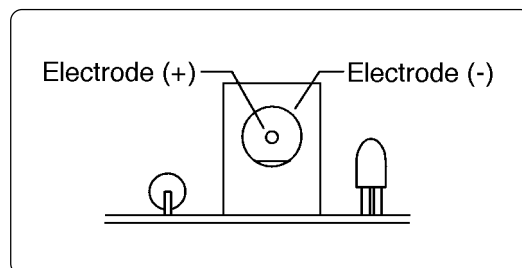

Figure 2.6 Specification of power connector

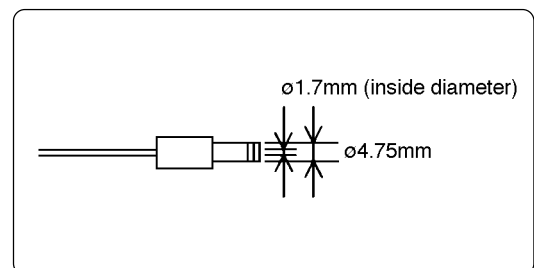

Figure 2.7 Specification of applicable plug

CAUTION

Note on Connecting the Power Supply of Emulator:

- Be careful about the polarity of the power supply. Connecting to the wrong electrode could destroy internal circuits.
- The power cable included in this product package is colored red (+) and black (-).
- Do not apply a voltage other than the specified voltage of the product (4.5 to 7.0 V), because it may cause burn injuries and the failure of internal circuits.

2.5 Connecting the Target System (as occasion demands)

Connect the LCC probe on the lower board of the emulator to the LCC socket (option) or the pitch converter board (option).

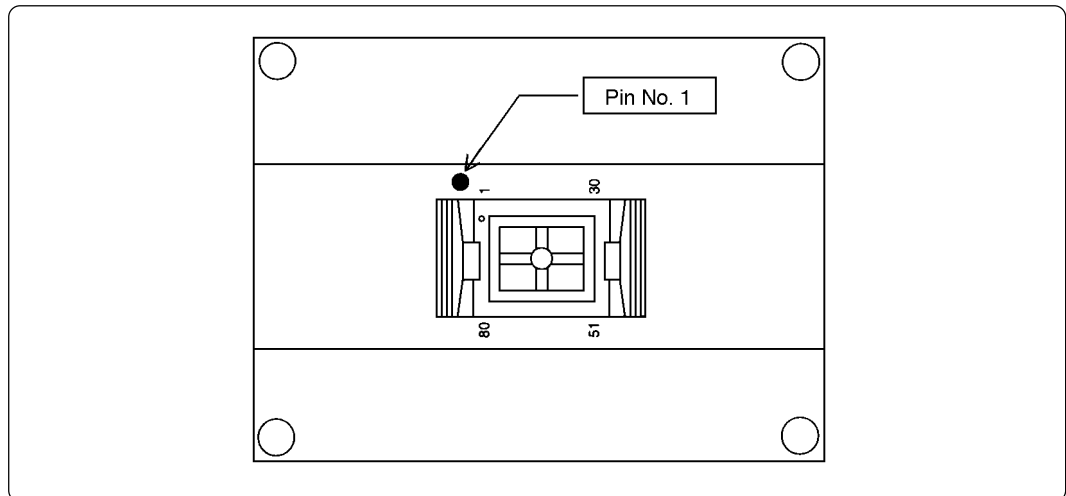

Figure 2.8 LCC probe on the lower board of the emulator

Some MCU packages need the pitch converter board (option) shown in Figure 2.9. When connecting it, be sure to check the position of No. 1 pin.

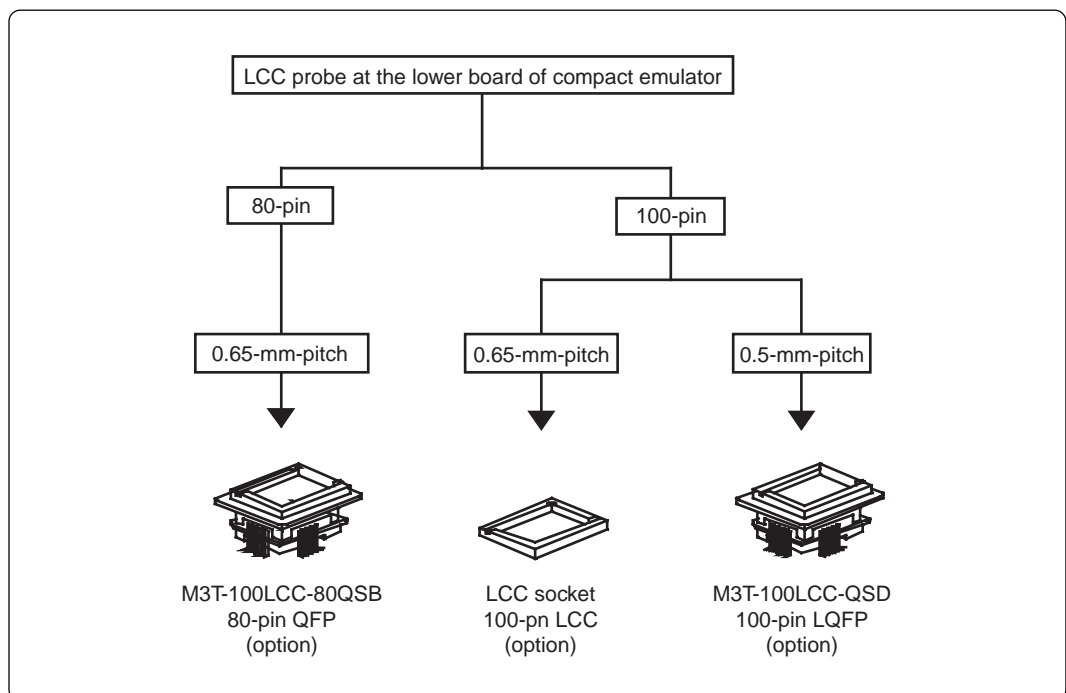

Figure 2.9 Connecting target system

CAUTION

Notes on Connecting Target Systems:

- Take care not to attach the converter board in a wrong direction. It may cause a fatal damage to the compact emulator.
- Always shut OFF power of the emulator and the target system when connecting and disconnecting the target system.

2.6 Turning On the Power

(1) Checking the Connection of the Emulator System

Before turning the power ON, check the connection of the host machine and the emulator main unit.

(2) Turning On the Power

Power ON the target system and the emulator main unit as simultaneously as possible.

CAUTION

Notes on Power Supply:

- As this emulator cannot supply power to the target system, provide the target system with a separate power supply from that of the emulator.
- This emulator consumes max. 500 mA of electrical current from target system. Therefore, set the power supply of the target system considering this consumption.
- Keep target system power supply voltage within the range of 3.0 to 5.0 V.
- Do not change target system power supply voltage after power has been activated.

(3) LED Display When the Emulator Starts Up Normally

After the emulator starts up, check the status of the LEDs to see whether the emulator operation is enabled or not.

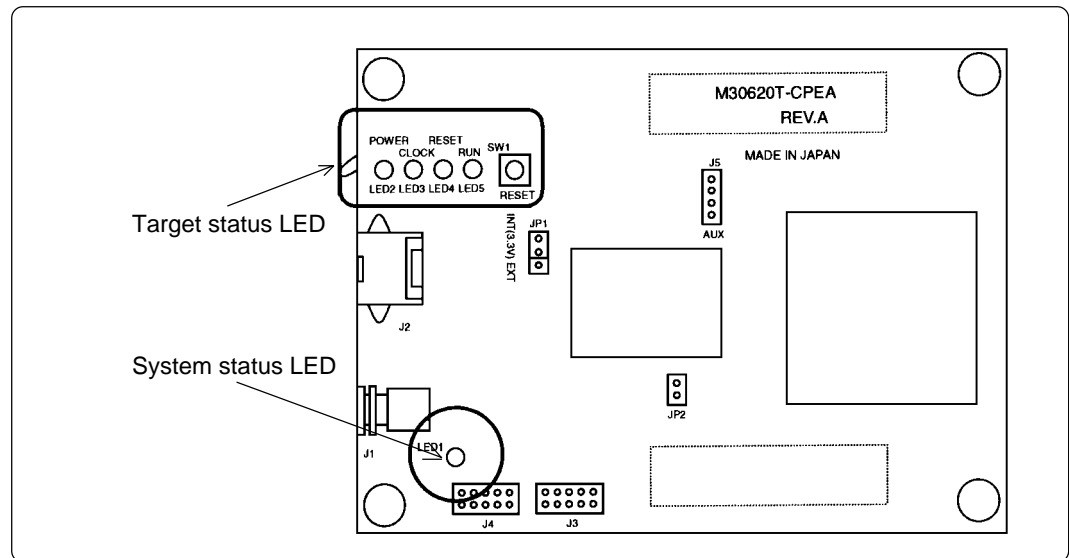

Figure 2.10 Positions of system status LED and target status LEDs

(1) System status LED

Check the LED1 of the system status LED is lit immediately after the power is activated. If it is not lit, shut off the power for the emulator and check the power supply for the emulator is properly connected.

(2) Target status LEDs

Target status LEDs light as shown in Figure 2.11 when the target system is not connected and as shown in Figure 2.12 when a target system is connected. For approximately the first 7 seconds after power is turned on, all target status LEDs light. After that, check the LEDs light up as shown in the figures.

If the target status LEDs do not light as shown in Figures 2.11 and 2.12, see "5.1 Troubleshooting Until the Emulator Starts Up" (page 40).

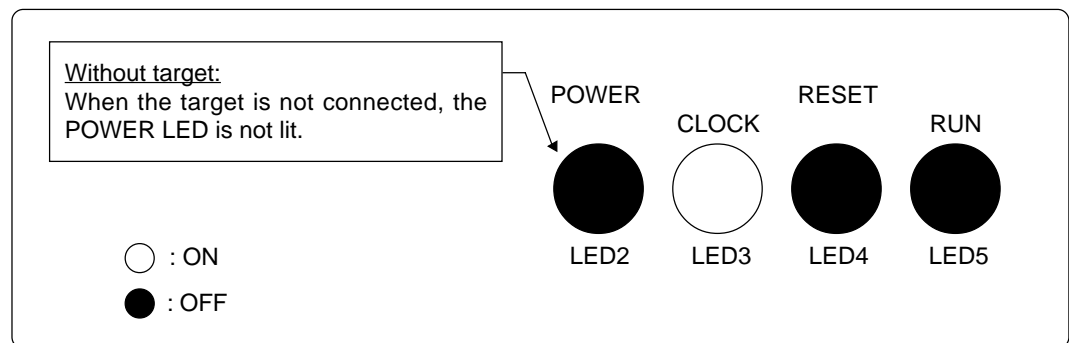

Figure 2.11 LED display when the emulator starts up normally (target system is not connected)

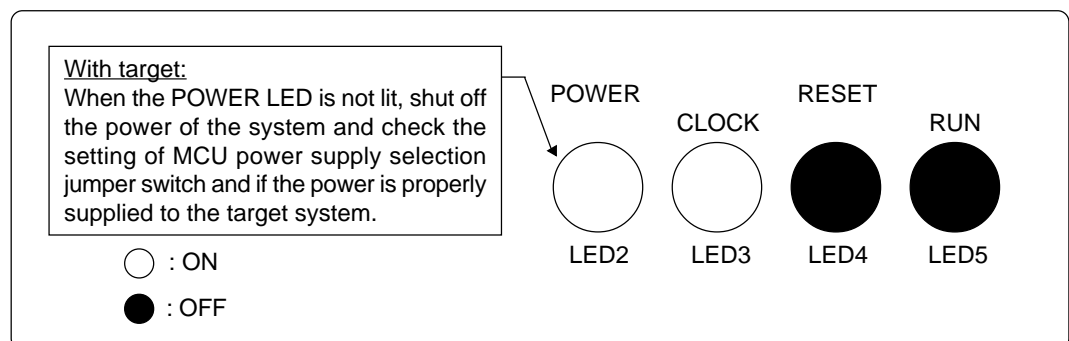

Figure 2.12 LED display when the emulator does not start up normally (target system is connected)

2.7 Starting Up Emulator Debugger PD30M

After checking the emulator has started up normally, start up emulator debugger PD30M.

For starting up emulator debugger, follow the steps below.

Click the start button of Windows.

And select Program (P) -> [RENESAS-TOOL] -> [PD30M V.1.10 Release 1*] -> [PD30M].

* Varies depending on the version of the emulator debugger.



2.8 Setting the Operating Environment of Emulator Debugger PD30M

After starting up PD30M, as the Init dialog box will open, set as shown in Figure 2.13. For details on Init dialog box, refer to user's manual of PD30M.

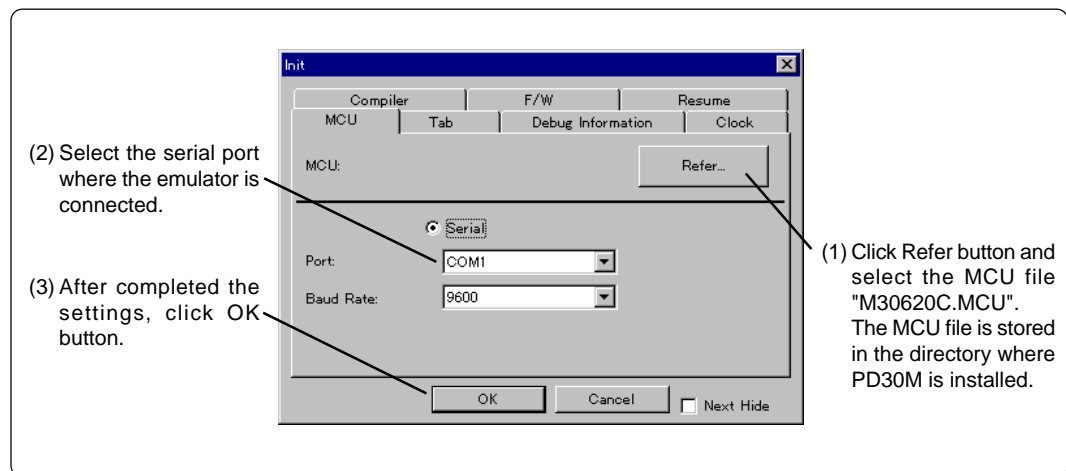

Figure 2.13 Setting Init dialog box

2.9 When Emulator Debugger PD30M Starts Up Normally

Figure 2.14 shows the window display when PD30M starts up normally.

If an error has been detected and PD30M has not started up, refer to "5.1 Troubleshooting Until the Emulator Starts Up" (page 40).

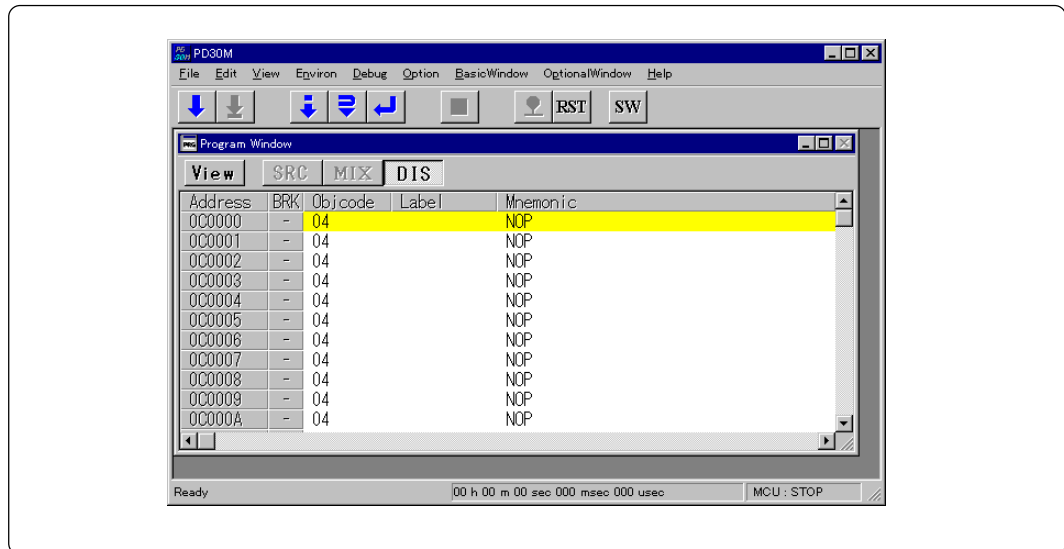

Figure 2.14 Window display of PD30M when it has started up normally

Chapter 3. Changing the Settings

This chapter describes how to change the setting of this product.

3.1 Using the Emulator without the Target System	28
3.2 Using the Emulator with the Target System.....	28
3.3 Using the P87/X _{CIN} Pin as a Port	28
3.4 Using the P87/X _{CIN} Pin as Sub-Clock Input	28
3.5 Selecting Clock Supply	29
(1) Selecting Clock Supply	29
(2) Using the Oscillator Circuit on the Target System	30
(3) Changing the Internal Oscillator Circuit of Emulator	31

Chapter 3. Changing the Settings

3.1 Using the Emulator without the Target System

How to use the emulator without the target system is shown below.

- (1) Set the "MCU power supply selection jumper" to INT side (see page 20).

When using the emulator without the target system, set the "MCU power supply selection jumper" to INT side. The target MCU operates with 3.3 V of power supply voltage supplied from the emulator.

3.2 Using the Emulator with the Target System

How to use the emulator with the target system is shown below.

- (1) Set the "MCU power supply selection jumper" to EXT side (see page 20).

When using the emulator with the target system, set the "MCU power supply selection jumper" to EXT side.

- (2) Connect the target system (see page 22).

Connect the LCC probe on the lower board of the emulator to the LCC socket (option) or the pitch converter board (option).

- (3) Connect the power supply for the emulator (see page 23).

As the emulator cannot supply power to the target system, provide the target system with a separate power supply from that of the emulator.

3.3 Using the P87/XCIN Pin as a Port

How to use the emulator when using the P87/XCIN pin as a port is shown below.

- (1) Set the "P87/XCIN selection switch" to PORT side (see page 20).

When using the P87/XCIN pin as a port, set the "P87/XCIN selection switch" to PORT side.

3.4 Using the P87/XCIN Pin as Sub-Clock Input

How to use the emulator when using the P87/XCIN pin as sub-clock input is shown below.

- (1) Set the "P87/XCIN selection switch" to XCIN side (see page 20).

When using the P87/XCIN pin as sub-clock input, set the "P87/XCIN selection switch" to XCIN side.

3.5 Selecting Clock Supply

There are two ways to supply a clock to the MCU, using the oscillator circuit of the emulator or using the oscillator circuit on the target system. Table 3.1 lists the factory-settings of each clock supply.

Table 3.1 Clock supply to the MCU

Clock	Description	Display of emulator debugger	Default setting
X _{IN} -X _{OUT} (main clock)	Internal oscillator circuit of emulator (10 MHz)	Internal	Yes
	Target System	External	-
X _{CIN} -X _{COU} T (sub-clock)	Internal oscillator circuit of emulator (32.768 kHz)	Internal	-
	Target System	External	Yes

IMPORTANT

Note on Changing the Clock Supply:

- For using X_{CIN}-X_{COU}T pins, it is necessary to set "P87/X_{CIN} selection switch" of the emulator to X_{CIN} side. For how to set it, refer to "2.3 (2) P87/X_{CIN} selection switch" (page 20).

(1) Selecting Clock Supply

To select the clock supply, change the clock by the Clock tab of the Init dialog box when starting up the emulator debugger or the CLK command input on the Script Window. For details, refer to user's manual of the emulator debugger.

(1) Selecting by Init dialog box

- Select main clock supply

- Select sub-clock supply

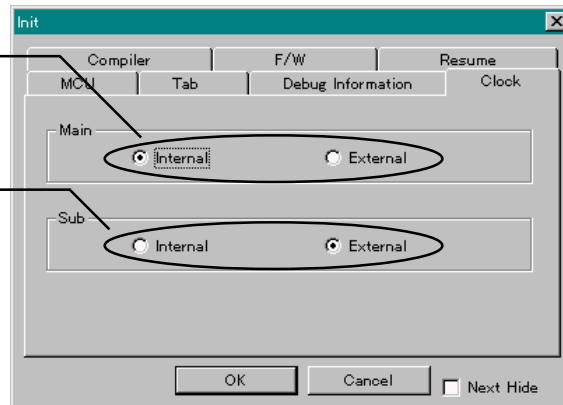

(2) Selecting by CLK command

An example of CLK command input by the script window is shown below.

example 1) When X_{IN}-X_{OUT} (main clock) is supplied from internal (INT) and X_{CIN}-X_{COU}T (sub-clock) is supplied from external (EXT)

CLK INT, EXT

example 2) When X_{IN}-X_{OUT} (main clock) is supplied from external (EXT) and X_{CIN}-X_{COU}T (sub-clock) is supplied from internal (INT)

CLK EXT, INT

(2) Using the Oscillator Circuit on the Target System

To operate the compact emulator with the oscillator circuit on the target system, construct the oscillator circuit as shown in Figure 3.1 in the target system and input the oscillator output at 50% duty (within the operating range of the evaluation MCU) into the X_{IN} pin. And the X_{OUT} pin should be open. It is same for sub-clock oscillator (X_{CIN} and X_{COUT}).

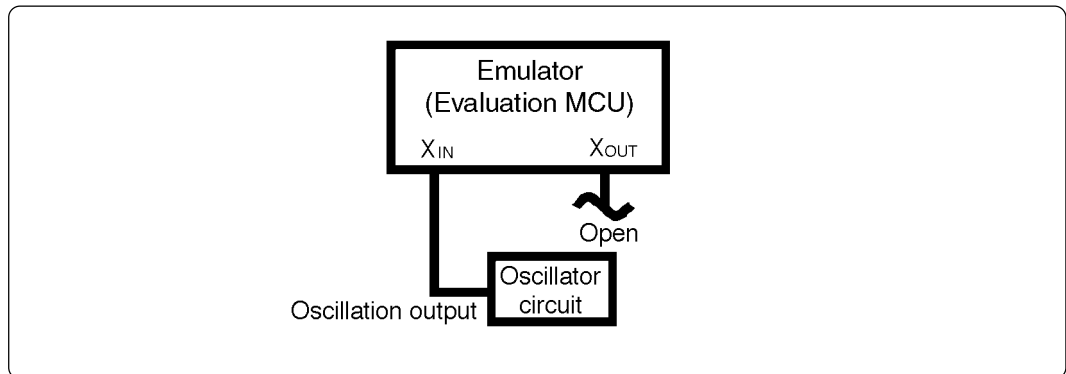

Figure 3.1 External oscillator circuit

Make note of the fact that in the oscillator circuit shown in Figure 3.2 where a resonator is connected between the X_{IN} and X_{OUT} pins, oscillation does not occur because an emulation circuit is used between the evaluation MCU and the target system. It is same for sub-clock oscillator circuits (X_{CIN} and X_{COUT}).

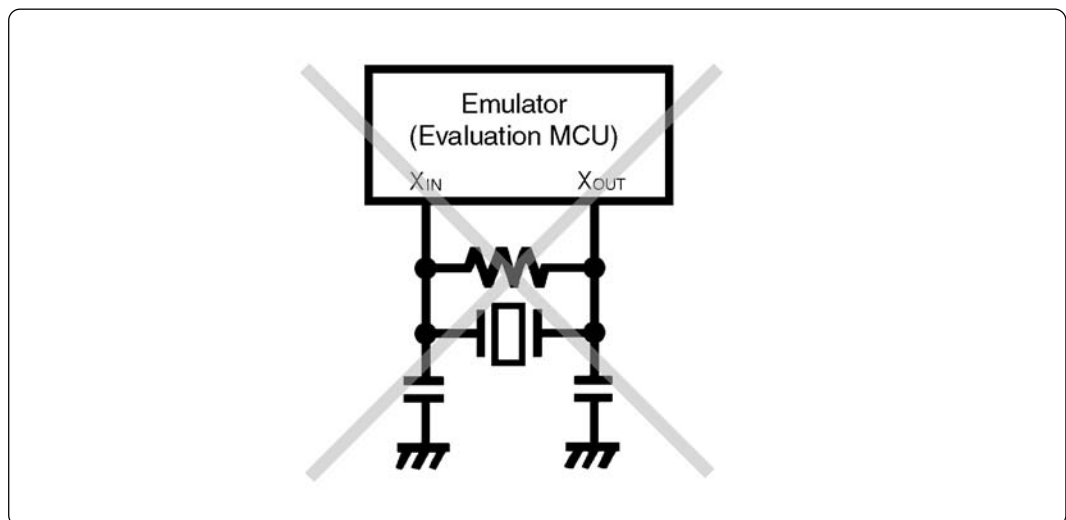

Figure 3.2 Circuit in which oscillation does not occur (same for X_{CIN} - X_{COUT})

(3) Changing the Internal Oscillator Circuit of Emulator

A ceramic oscillator circuit for 10 MHz is mounted on this product as a oscillator of a main clock oscillator circuit when shipped from factory. It is possible to change it to the oscillator circuit board for 16 MHz (included). How to replace it is shown below. Be sure to read IMPORTANT below before replacing it.

IMPORTANT

Notes on Replacing Internal Oscillator Circuit of Emulator:

- Soldering is required to replace the emulator's internal oscillation circuit. If you are inexperienced at soldering, it is recommended to supply a clock of arbitrary frequency from an external source.
- The included 16MHz oscillator is the only oscillator that can be used as a replacement. Other oscillators may not oscillate properly, therefore supply a clock of arbitrary frequency from an external source.
- Emulator standalone operation is not guaranteed when a 16MHz oscillator is installed. During standalone operation, the emulator operates at 3.3 V, which exceeds the guaranteed operating frequency of the MCU.
- Generally, the oscillator can be replaced only twice (removal and installation count as one time). Any more than this will effect board pattern durability, it is not recommended.
- Be careful not to damage other devices when replacing the oscillator. Servicing for damage incurred during oscillator replacement can be subject to billing even in the warranty period.

(1) Check the operation of the system

Check that the emulator system has no fault by executing the self-check referring "5.3 When the Operation of the Emulator is Abnormal" (page 44).

(2) Remove the target connection board

Remove the target connection board on the lower board of the emulator as shown in Figure 3.3.

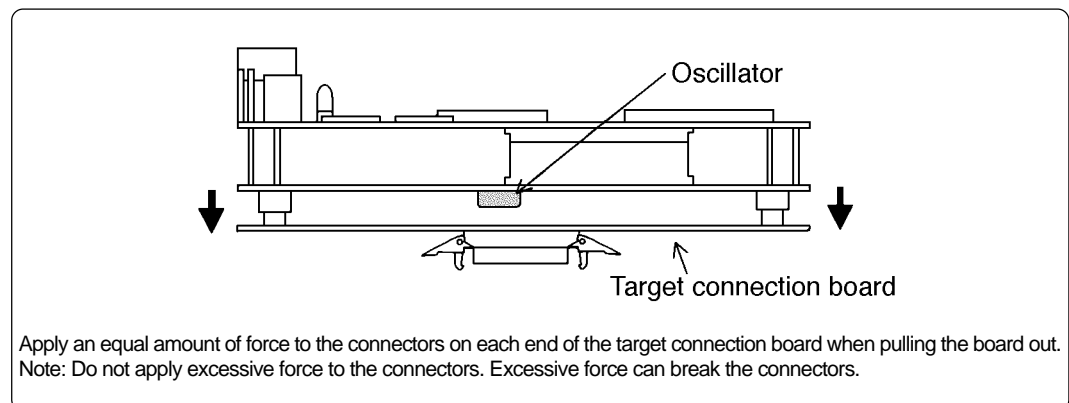

Figure 3.3 Removing the target connection board (side view)

(3) Remove the oscillator

Figure 3.4 shows the position of the oscillator for the main clock. Remove the oscillator using a soldering iron. Be careful not to break the other part.

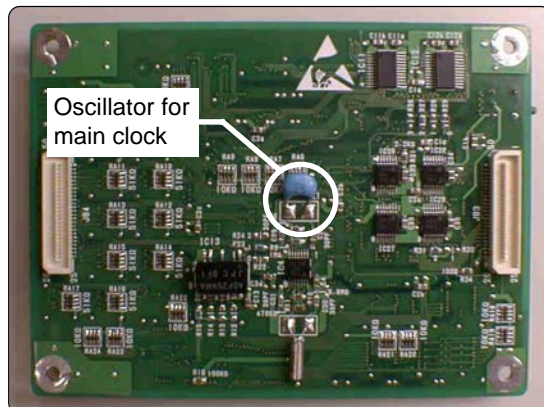

Figure 3.4 Position of oscillator for main clock (bottom view after removing target connection board)

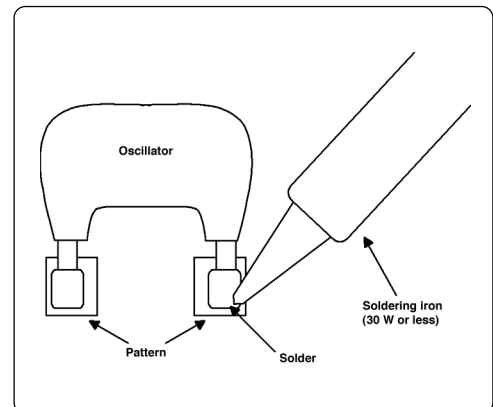

Figure 3.5 Removing an oscillator

(4) Connecting the Oscillator

Solder the included 16MHz oscillator in the place of the older oscillator (see Figure 3.4). Solder the oscillator so that the label can be read.

(5) Connecting the target connection board

Check the oscillator is properly connected. If it is, connect the target connection board to the emulator. The connectors are designed so that they cannot be inserted in the opposite direction, therefore check orientation before inserting the oscillator. Also, insert the oscillator without applying excessive force.

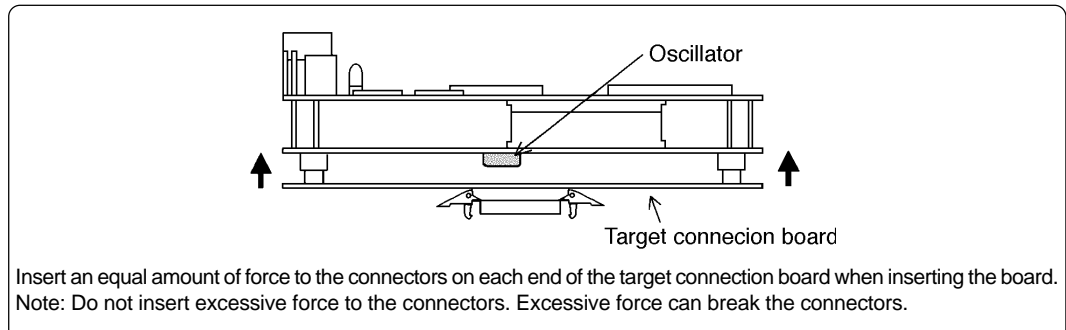

Insert an equal amount of force to the connectors on each end of the target connection board when inserting the board. Note: Do not insert excessive force to the connectors. Excessive force can break the connectors.

Figure 3.6 Connecting the target connection board (side view)

(6) Check the operation of the system

After connecting the target system, start up the emulator system. If the emulator starts up normally, the replacement is completed.

IMPORTANT

Notes on Replacing Internal Oscillator Circuit of Emulator:

- When a 16MHz oscillator is installed, the self-check cannot be executed, because it must be done with the target system not connected. During standalone operation, the emulator operates at 3.3 V, which exceeds the guaranteed operating frequency of the MCU.

Chapter 4. Specifications

This chapter describes specifications of this product.

4.1 Specifications	34
4.2 Memory Map	35
4.3 Electrical Characteristics	36
4.4 Connection Diagram	37
4.5 External Dimensions of the Emulator	38

Chapter 4. Specifications

4.1 Specifications

Table 4.1 lists the specifications of M30620T-CPE.

Table 4.1 Specifications of M30620T-CPE

Applicable MCUs*	M16C/62 Group M16C/62A	
Usable mode	Single-chip mode	
Evaluation MCU	M30622SAFP	
Internal emulation memory	For internal RAM area: 20 KB For internal ROM area: 256 KB	
Clock supply	Main clock (X _{IN})	Clock mounted on emulator (10 MHz: pre-mounted) Switchable to external oscillator input.
	Sub clock (X _{CIN})	Clock mounted on emulator (32.768 kHz) Switchable to external oscillator input.
Maximum operating frequency	With the target	See the charts below
	Without the target	3.3 V: 10 MHz 0-wait
Minimum operating frequency	32.768 kHz	
Power voltage for MCU and power supply	With the target (set JP1 = EXT)	3.0 to 5.0 V (supplied through the LCC probe on the back of the emulator board from the target)
	Without the target (set JP1 = INT)	Fixed to 3.3 V (supplied from the emulator)
Basic debugging functions	Download, S/W break (64 points), Program execution/stop (allows free-run execution supporting S/W breaks), Memory reference/setting (reference/setting C-variables, run-time execution), Register reference/setting, Disassemble display, C-level debugging, etc.	
Real-time tracing function	<ul style="list-style-type: none"> • 32K-cycle bus information is recordable (Address: 20 bits, Data: 16 bits, MCU status: 12 bits) • 2 trace modes are supported (Before Break mode/After Go mode) 	
Execution time measurement function	Time between program start to stop is measurable	
Operating temperature	5 to 35°C (no dew)	
Storage temperature	-10 to 60°C (no dew)	
Connection to target system	Connect the LCC probe on the back of the emulator board with the LCC socket mounted on the target.	
Power supply for emulator	DC 4.5 to 7.0 V supplied from external (prepare the power supply separately)	
Host machine interface	RS-232C serial interface (Max. 115.2 kbps)	

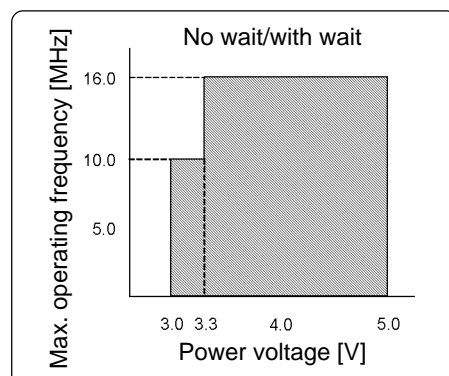

* This emulator is equipped with M30622SAFP (M16C/62A Group) as an evaluation MCU and emulates M16C/62A Group MCUs. In some functions there are differences between the MCUs of M16C/62A Group and the MCUs of other than M16C/62A Group. Therefore when you use this emulator for debugging an MCU of other than M16C/62A Group, be careful about the differences of functions of each MCU. For details on the functions of each MCU, see datasheets and user's manuals of each MCU.

This product cannot be used in the operating frequency and the operating power voltage exceeding the guaranteed range.

4.2 Memory Map

Figure 4.1 shows memory maps when using the emulator. For the memory map of the actual MCU, refer to the user's manual of your MCU.

Make note of the fact that the memory map of the actual MCU differ from that of emulator. Do not access to the area noted "Do Not Access" in the memory map when using the emulator. Otherwise, the emulator may malfunction.

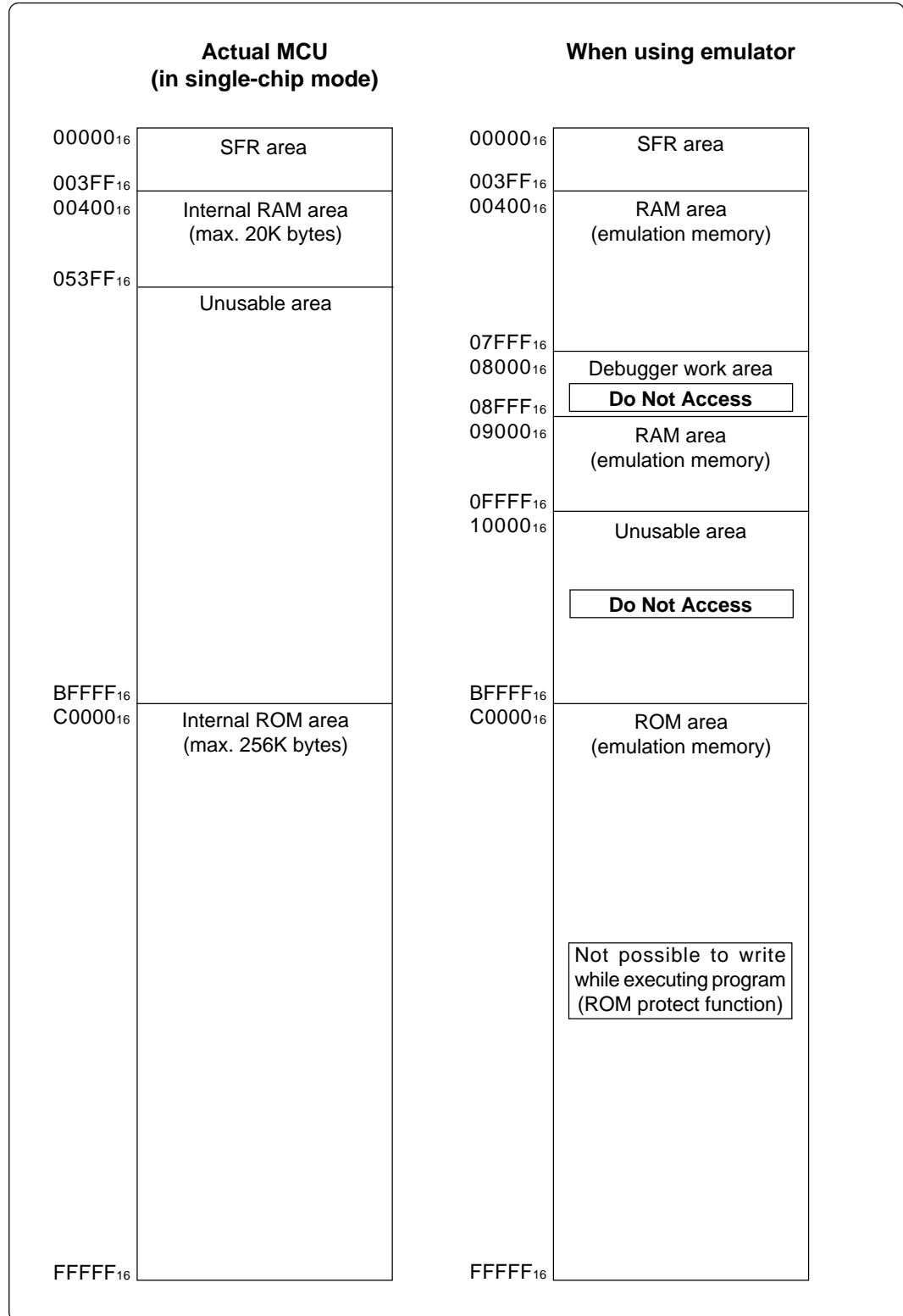

Figure 4.1 Memory map when using emulator

4.3 Electrical Characteristics

Tables 4.2 lists IC electrical characteristics of the user interface.

Table 4.2 Electrical characteristics of M60081L-0142FP (P0₀ to P5₇)

Symbol	Parameter	Condition	Standard values			Unit
			Min.	Standard	Max.	
V _{IL}	Input voltage	V _{CC} = 4.5 V	0		1.35	V
V _{IH}		V _{CC} = 5.5 V	3.85		5.5	
V _{OH}	Output voltage	V _{CC} = 5.0 V			0.05	V
V _{OL}		I _o < 1 μA	4.95			V
I _{OL}	Output current	V _{CC} = 4.5 V V _{OL} = 0.4 V	8			mA
I _{OH}		V _{CC} = 4.5 V V _{OH} = 4.1 V			-8	mA
I _{IL}	Input leak current	V _{CC} = 5.5 V V _I = 0 V	-1		+1	μA
I _{IH}		V _{CC} = 5.5 V V _I = 5.5 V	-1		+1	μA
I _{oZL}	OFF state output leak current	V _{CC} = 5.5 V V _O = 0 V	-1		+1	μA
I _{oZH}		V _{CC} = 5.5 V V _O = 5.5 V	-1		+1	μA
C _{IO}	I/O pin capacity	f = 1 MHz V _{CC} = 0 V		7	15	pF

4.4 Connection Diagram

Figure 4.2 shows the connection diagram of M30620T-CPE. This connection diagram mainly shows the interface section, and the circuits which are not connected to the target system such as the emulator's control system are omitted.

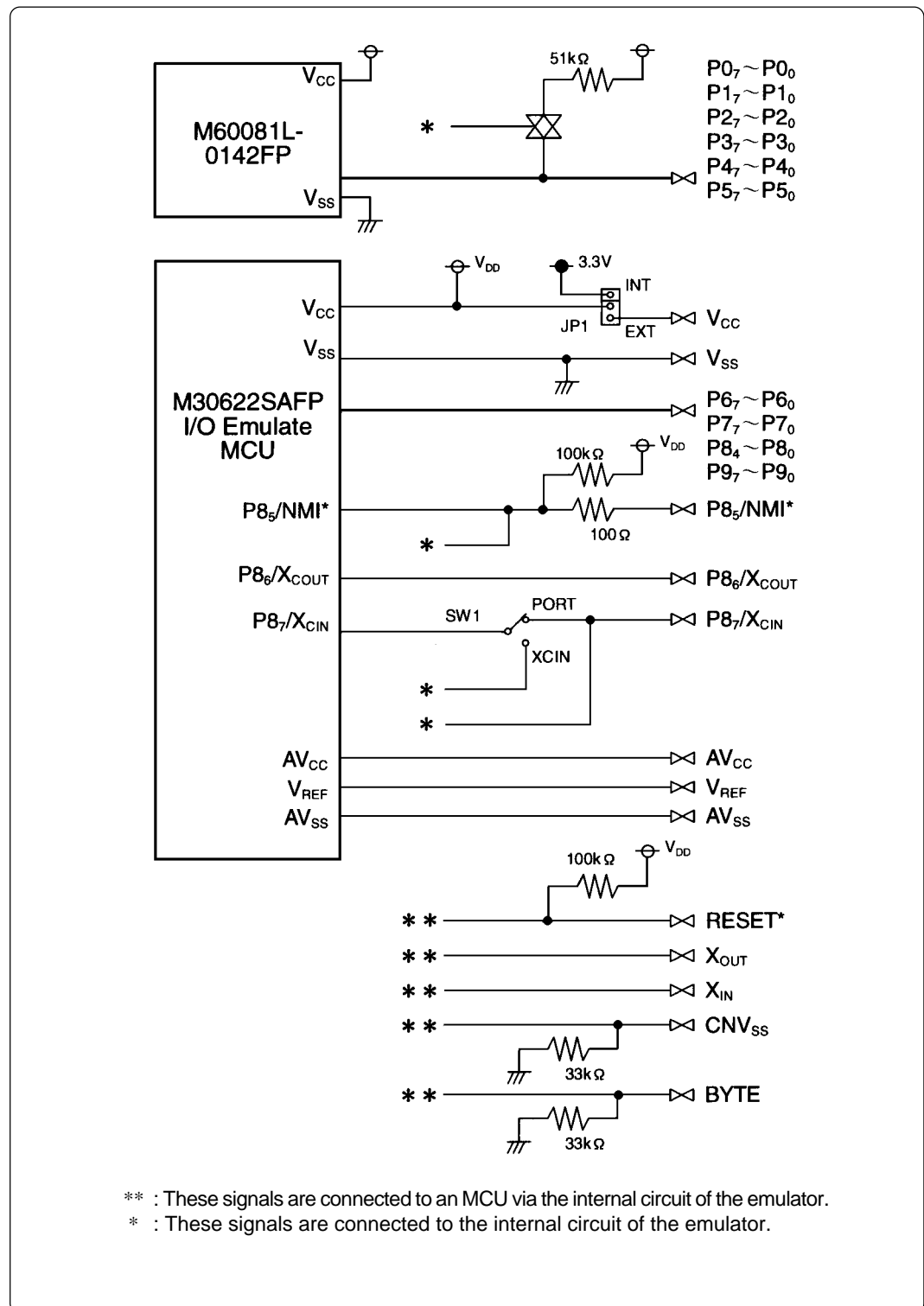

Figure 4.2 Connection diagram (emulation circuits)

4.5 External Dimensions of the Emulator

Figure 4.3 shows external dimensions of the emulator.

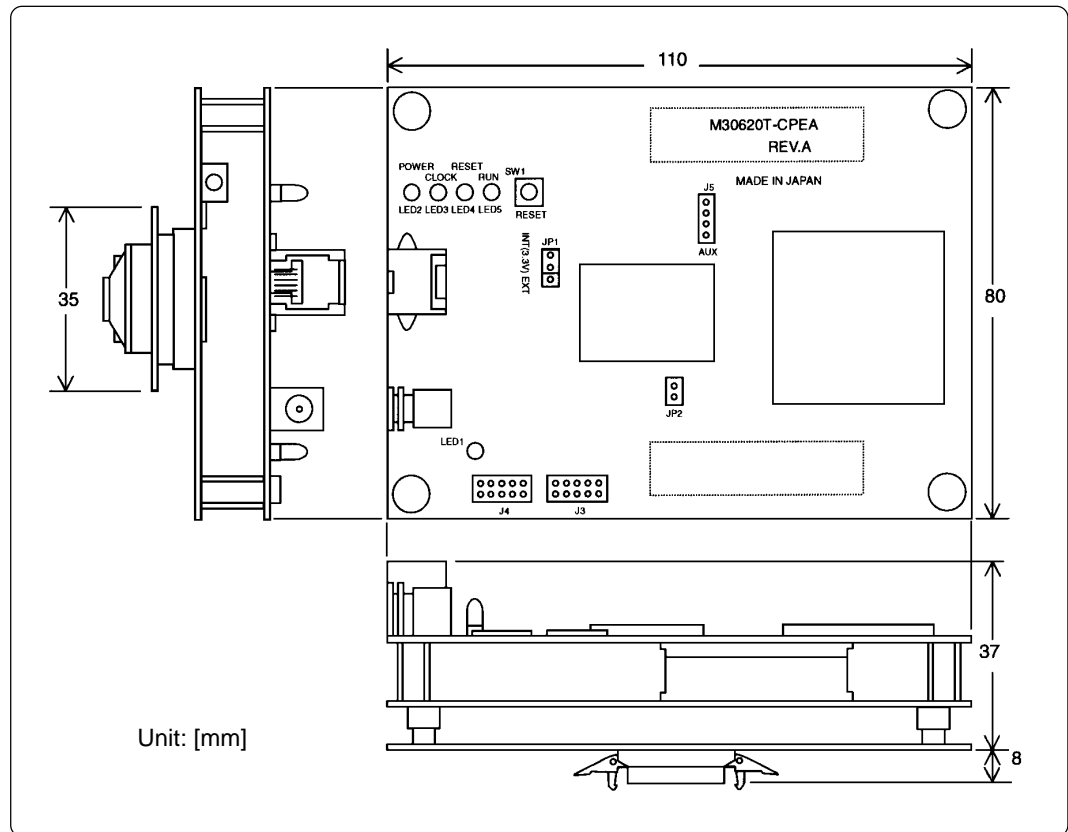

Figure 4.3 External dimensions of emulator

Chapter 5. Troubleshooting

This chapter describes how to troubleshoot when this product does not work properly.

5.1 Troubleshooting Until the Emulator Starts Up	40
(1) Troubleshooting When the Emulator Starts Up	41
(2) Troubleshooting When Emulator Debugger PD30M Starts Up	42
5.2 Troubleshooting When Using Emulator Debugger PD30M	43
5.3 When the Operation of the Emulator is Abnormal	44
(1) Self-check Procedure in the Self-check Mode	44
(2) If an Error is Detected in Self-checks	45

Chapter 5. Troubleshooting

5.1 Troubleshooting Until the Emulator Starts Up

Figure 5.1 shows the flowchart to remedy the troubles from when power to the emulator is activated until the emulator debugger starts up.

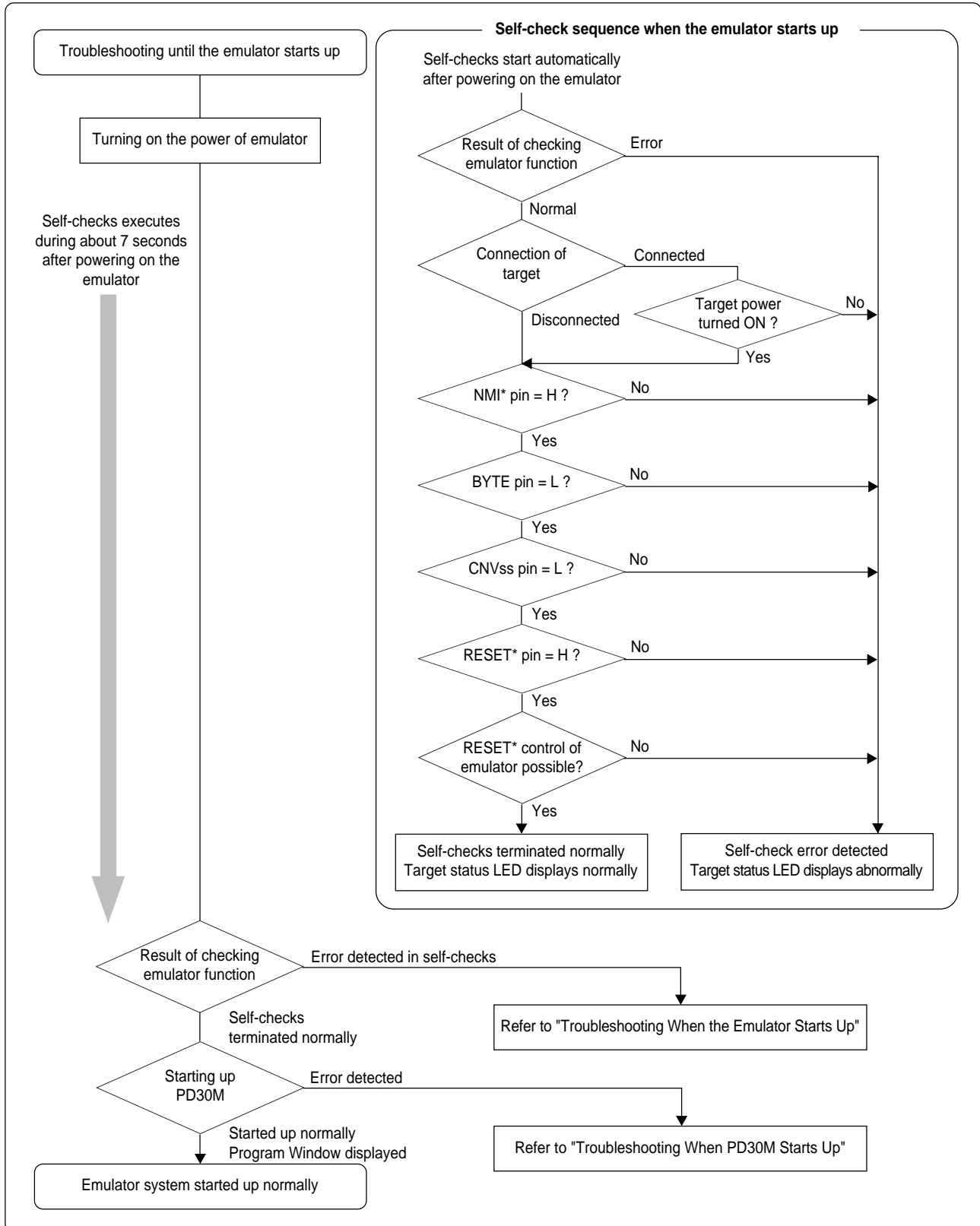

Figure 5.1 Flowchart to remedy the troubles

(1) Troubleshooting When the Emulator Starts Up

Tables 5.1 and 5.2 list how to remedy the troubles when the target LED of the emulator display is abnormal after powering on the emulator.

When the error is detected, shut off the power of the emulator and the target system and follow the steps in tables 5.1 and 5.2. Then, reactivate the power of the emulator and the target system.

Table 5.1 Error display and how to remedy it when starting up the emulator (1/2)

LED display ● : OFF ☉ : Blinking	Connection to the target system	Checkpoint
POWER CLOCK RESET RUN ● ● ● ☉	-	Emulator does not work properly. - Check power is being supplied to the emulator. - The emulator may be damaged. Contact your local distributor.
POWER CLOCK RESET RUN ● ● ☉ ☉	Connected	Emulator does not work properly because power is not being supplied to the target system or the NMI* pin is "L" level. - Check power is being supplied to the target system. - Check the NMI pin is "H" level.
	Not connected	Emulator does not work properly. - Check power is being supplied to the emulator. - Check JP1 (MCU power supply selection jumper) is set to the INT side.
POWER CLOCK RESET RUN ● ☉ ● ●	Connected	Emulator does not work properly because the BYTE pin is "H" level. - This emulator is specifically designed for use in the single-chip mode. Check the BYTE pin is "L" level.
	Not connected	Emulator does not work properly. - The emulator may be damaged. Contact your local distributor.
POWER CLOCK RESET RUN ● ☉ ● ☉	Connected	Emulator does not work properly because the CNV _{SS} pin is "H" level. - This emulator is specifically designed for use in the single-chip mode. Check the CNV _{SS} pin is "L" level.
	Not connected	Emulator does not work properly. - The emulator may be damaged. Contact your local distributor.
POWER CLOCK RESET RUN ☉ ● ☉ ☉	Connected	Emulator does not work properly because the RESET* pin is "L" level or the reset was not effectuated after the reset request was sent from the emulator. - Check the RESET* pin is "H" level.
	Not connected	Emulator does not work properly. - The emulator may be damaged. Contact your local distributor.

Table 5.2 Error display and how to remedy it when starting up the emulator (2/2)

LED display ● : OFF ○ : Blinking	Connection to the target system	Checkpoint																																																																
<table border="0"> <tr><td>POWER</td><td>CLOCK</td><td>RESET</td><td>RUN</td></tr> <tr><td>●</td><td>●</td><td>○</td><td>●</td></tr> <tr><td>POWER</td><td>CLOCK</td><td>RESET</td><td>RUN</td></tr> <tr><td>●</td><td>○</td><td>○</td><td>●</td></tr> <tr><td>POWER</td><td>CLOCK</td><td>RESET</td><td>RUN</td></tr> <tr><td>●</td><td>○</td><td>○</td><td>○</td></tr> <tr><td>POWER</td><td>CLOCK</td><td>RESET</td><td>RUN</td></tr> <tr><td>○</td><td>●</td><td>●</td><td>●</td></tr> <tr><td>POWER</td><td>CLOCK</td><td>RESET</td><td>RUN</td></tr> <tr><td>○</td><td>●</td><td>●</td><td>○</td></tr> <tr><td>POWER</td><td>CLOCK</td><td>RESET</td><td>RUN</td></tr> <tr><td>○</td><td>○</td><td>●</td><td>●</td></tr> <tr><td>POWER</td><td>CLOCK</td><td>RESET</td><td>RUN</td></tr> <tr><td>○</td><td>○</td><td>○</td><td>○</td></tr> <tr><td>POWER</td><td>CLOCK</td><td>RESET</td><td>RUN</td></tr> <tr><td>○</td><td>○</td><td>○</td><td>○</td></tr> </table>	POWER	CLOCK	RESET	RUN	●	●	○	●	POWER	CLOCK	RESET	RUN	●	○	○	●	POWER	CLOCK	RESET	RUN	●	○	○	○	POWER	CLOCK	RESET	RUN	○	●	●	●	POWER	CLOCK	RESET	RUN	○	●	●	○	POWER	CLOCK	RESET	RUN	○	○	●	●	POWER	CLOCK	RESET	RUN	○	○	○	○	POWER	CLOCK	RESET	RUN	○	○	○	○	-	Emulator does not work properly. - The emulator may be damaged. Report LED status to your local distributor.
POWER	CLOCK	RESET	RUN																																																															
●	●	○	●																																																															
POWER	CLOCK	RESET	RUN																																																															
●	○	○	●																																																															
POWER	CLOCK	RESET	RUN																																																															
●	○	○	○																																																															
POWER	CLOCK	RESET	RUN																																																															
○	●	●	●																																																															
POWER	CLOCK	RESET	RUN																																																															
○	●	●	○																																																															
POWER	CLOCK	RESET	RUN																																																															
○	○	●	●																																																															
POWER	CLOCK	RESET	RUN																																																															
○	○	○	○																																																															
POWER	CLOCK	RESET	RUN																																																															
○	○	○	○																																																															

(2) Troubleshooting When Emulator Debugger PD30M Starts Up

Table 5.3 lists error messages and how to remedy them when starting up PD30M.

Table 5.3 Error message and how to remedy it when starting up PD30M

Error message	Connection to the target system	Checkpoint
Communication ERROR. Can't accept data.	-	- Check the emulator's target status LEDs. If flashing, the emulator is not working properly. Check settings as explained in "(1) Troubleshooting When the Emulator Starts Up". - Check the connected serial port and the serial port settings in the Init dialog box match. - Try lowering the baud rate in the Init dialog box.
Not Compact Emulator.	-	- Check the connected serial port and the serial port settings in the Init dialog box match. - Check an emulator (such as PC4701M, PC4701HS or PC4701L) is not connected.
Target MCU is not given clock. Please reset target systems.	Connected	- Check the target system's oscillation circuit works properly when the Clock tab in the Init dialog box is set to External.
	Not connected	- If the Clock tab in the Init dialog box is set to External, change it to Internal.
Target MCU is unable to reset. Please reset target systems.	Connected	- Check the target system's oscillation circuit works properly when the Clock tab in the Init dialog box is set to External.
	Not connected	- If the Clock tab in the Init dialog box is set to External, change it to Internal.
The version of PD30M and the firmware on the target are not same.	-	- Contact your local distributor.
Please download the firmware to target.	-	- Contact your local distributor.

5.2 Troubleshooting When Using Emulator Debugger PD30M

When PD30M has started up normally, however, errors occurred while using it, remedy the troubles referring Table 5.4.

Table 5.4 Error message and how to remedy it when using PD30M

Error message	Connection to the target system	Checkpoint
Target MCU is not given clock. Please reset target systems.	Connected	- If an external clock is being supplied, check the target system's oscillation circuit works properly. Also, if using the sub-clock, see "3.4 Using the P87/X _{CIN} Pin as Sub-Clock Input" (page 28).
	Not connected	- If the external clock supply is set, change to internal supply. Also, if using the sub-clock, see "3.4 Using the P87/X _{CIN} Pin as Sub-Clock Input" (page 28).
Target MCU is unable to reset. Please reset target systems.	Connected	- If an external clock is being supplied, check the target system's oscillation circuit works properly. Also, if using the sub-clock, see "3.4 Using the P87/X _{CIN} Pin as Sub-Clock Input" (page 28).
	Not connected	- If the external clock supply is set, change to internal supply. Also, if using the sub-clock, see "3.4 Using the P87/X _{CIN} Pin as Sub-Clock Input" (page 28).
Target MCU is reset state. Please reset target systems.	Connected	- The target MCU has been reset. Cancel the reset.
Target MCU is HOLD state. Please reset target systems.	Connected	- If an external clock is being supplied, check the target system's oscillation circuit works properly. Also, if using the sub-clock, see "3.4 Using the P87/X _{CIN} Pin as Sub-Clock Input" (page 28). - The MCU may be in the stop or wait modes. Either reset the MCU or cancel the mode with an interrupt.
	Not connected	- If an external clock is being supplied, check the target system's oscillation circuit works properly. Also, if using the sub-clock, see "3.4 Using the P87/X _{CIN} Pin as Sub-Clock Input" (page 28). - The MCU may be in the stop or wait modes. Either reset the MCU or cancel the mode with an interrupt.
Target MCU is not given power. Please reset target systems.	Connected	- Check the power supply and GND are properly connected to the target system.

5.3 When the Operation of the Emulator is Abnormal

Self-check is a function to check the memory etc. mounted in the emulator. Self-check is executed when the emulator starts up, and detailed check is executed by following the procedure below.

For this self-check, be sure to disconnect the target system.

(1) Self-check Procedure in the Self-check Mode

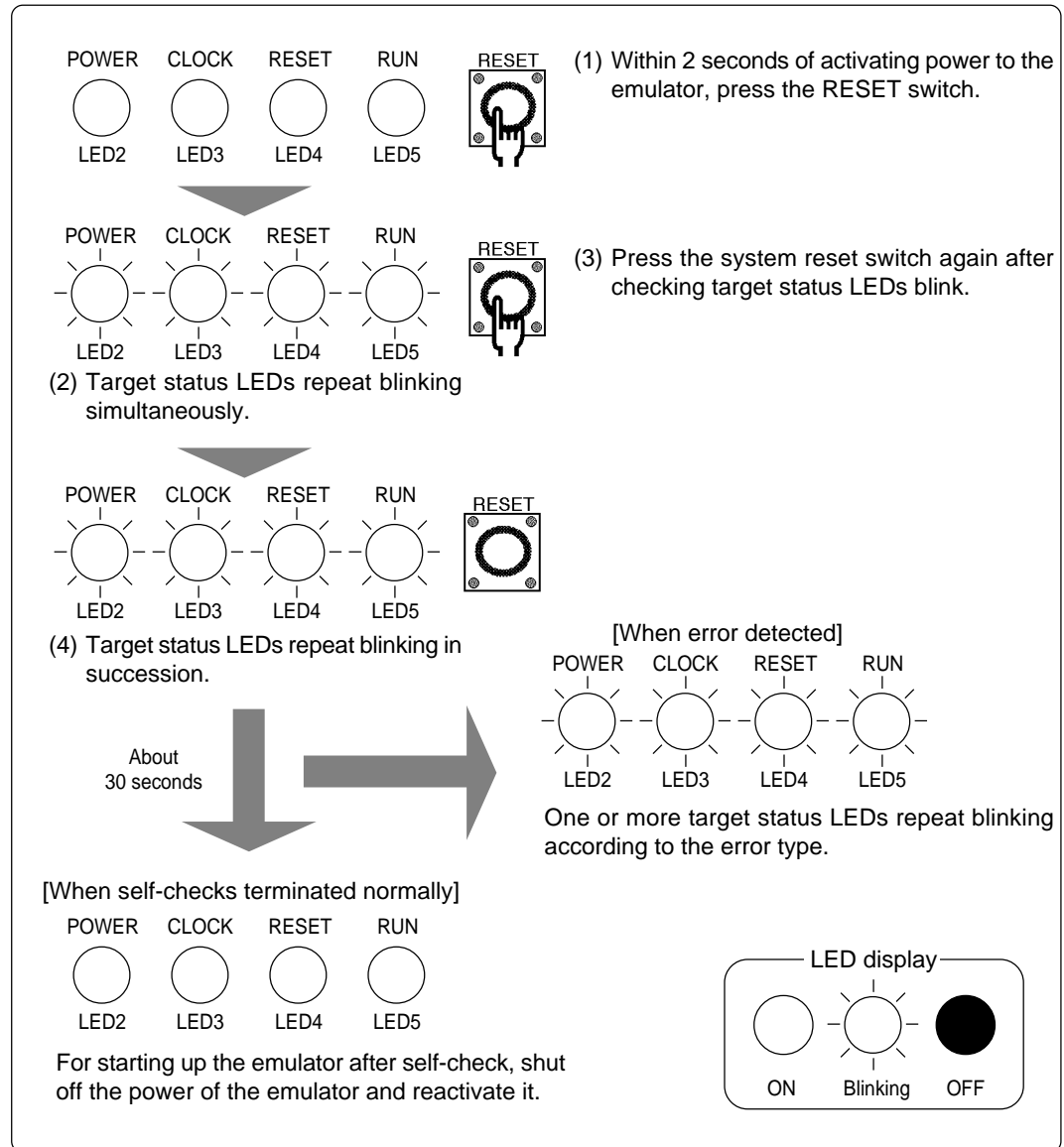



































































Figure 5.2 Self-check procedure

(2) If an Error is Detected in Self-checks

Table 5.5 lists how to remedy the troubles if the target status LED display is abnormal in self-checks.

When an error is detected, shut off the power of the emulator and the target system and follow the steps in the Table 5.5. Then, reactivate the power of the emulator and the target system.

Table 5.5 Error display in self-checks and how to remedy it

LED display  : OFF  : Blinking	Checkpoint
POWER CLOCK RESET RUN    	Emulator does not work properly. - Check power is being supplied to the emulator. - If power is being supplied to the emulator, the emulator may be damaged. Report the LED status to your local distributor.
POWER CLOCK RESET RUN    	Emulator does not work properly. - Check JP1 (MCU power supply selection jumper) is set to INT side. - If JP1 is set to INT side, the emulator may be damaged. Report the LED status to your local distributor.
POWER CLOCK RESET RUN                                                        	Emulator does not work properly. - The emulator may be damaged. Report the LED status to your local distributor.

CAUTION

Notes on Self-checks:

- Be sure to disconnect the target system before executing self-checks.
- If self-checks do not result normally, the emulator may be damaged. Then, contact your local distributor.
- When an oscillator installed in the emulator is changed to the oscillator of 16 MHz, self-checks may not terminate normally. Use the oscillator of 10 MHz when executing self-checks.

MEMO

Chapter 6. Maintenance and Guarantee

This chapter describes how to maintenance, repair provisions and how to request for repair.

6.1 Maintenance	48
6.2 Guarantee	48
6.3 Repair Provisions.....	48
6.4 How to Request for Repair	49

Chapter 6. Maintenance and Guarantee

6.1 Maintenance

If dust or dirt collects on any equipment of your emulation system, wipe it off with a dry soft cloth. Do not use thinner or other solvents because these chemicals can cause the equipment's surface coating to separate.

6.2 Guarantee

If your product becomes faulty within twelve months after its purchase while being used under good conditions by observing "Precautions for Safety" described in Chapter 1 of this user's manual, we will repair or replace your faulty product free of charge. Note, however, that if your product's fault is raised by any one of the following causes, we will repair it or replace it with new one with extra-charge:

- Misuse, abuse, or use under extraordinary conditions
- Unauthorized repair, remodeling, maintenance, and so on
- Inadequate user's system or misuse of it
- Fires, earthquakes, and other unexpected disasters

In the above cases, contact your local distributor. If your product is being leased, consult the leasing company or the owner.

6.3 Repair Provisions

(1) Repair with extra-charge

The products elapsed more than twelve months after purchase can be repaired with extra-charge.

(2) Replacement with extra-charge

If your product's fault falls in any of the following categories, the fault will be corrected by replacing the entire product instead of repair, or you will be advised to purchase new one, depending on the severity of the fault.

- Faulty or broken mechanical portions
- Flaw, separation, or rust in coated or plated portions
- Flaw or cracks in plastic portions
- Faults or breakage caused by improper use or unauthorized repair or modification
- Heavily damaged electric circuits due to overvoltage, overcurrent or shorting of power supply
- Cracks in the printed circuit board or burnt-down patterns
- Wide range of faults that makes replacement less expensive than repair
- Unlocatable or unidentified faults

(3) Expiration of the repair period

When a period of twelve months elapses after the model was dropped from production, repairing products of the model may become impossible.

(4) Transportation fees at sending your product for repair

Please send your product to us for repair at your expense.

6.4 How to Request for Repair

If your product is found faulty, follow the procedure below to send your product for repair.

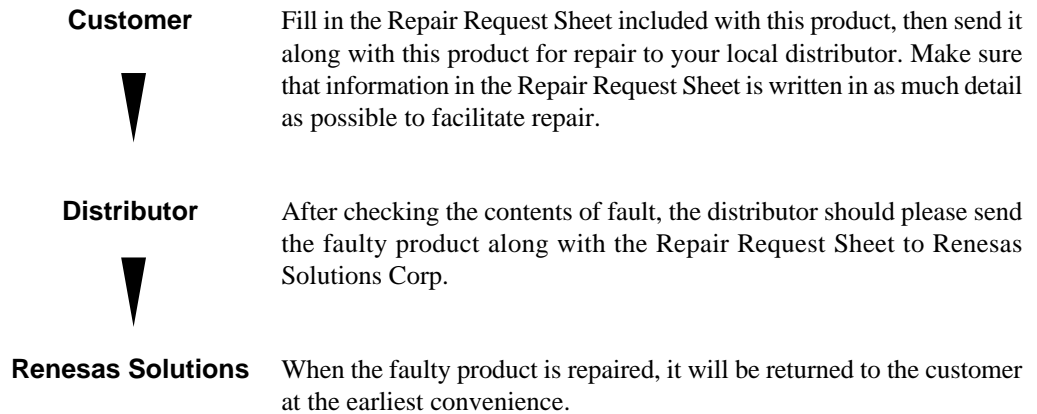

CAUTION

Note on Transporting the Product:



- When sending your product for repair, use the packing box and cushion material supplied with this product when delivered to you and specify handling caution for it to be handled as precision equipment. If packing of your product is not complete, it may be damaged during transportation. When you pack your product in a bag, make sure to use conductive polyvinyl supplied with this product (usually a blue bag). When you use other bags, they may cause a trouble on your product because of static electricity.

MEMO

M30620T-CPE User's Manual

Rev.1.00
November 16, 2003
REJ10J0270-0100Z

**COPYRIGHT ©2003 RENESAS TECHNOLOGY CORPORATION
AND RENESAS SOLUTIONS CORPORATION ALL RIGHTS RESERVED**



Renesas Technology Corp.

2-6-2, Ote-machi, Chiyoda-ku, Tokyo, 100-0004, Japan

Free Manuals Download Website

<http://myh66.com>

<http://usermanuals.us>

<http://www.somanuals.com>

<http://www.4manuals.cc>

<http://www.manual-lib.com>

<http://www.404manual.com>

<http://www.luxmanual.com>

<http://aubethermostatmanual.com>

Golf course search by state

<http://golfingnear.com>

Email search by domain

<http://emailbydomain.com>

Auto manuals search

<http://auto.somanuals.com>

TV manuals search

<http://tv.somanuals.com>