

# M30880T-EPB

User's Manual

Emulation Probe for M32C/88 Group

User's Manual

Rev.1.00  
Jan. 16, 2005

Renesas Technology  
[www.renesas.com](http://www.renesas.com)

Keep safety first in your circuit designs!

1. Renesas Technology Corp. puts the maximum effort into making semiconductor products better and more reliable, but there is always the possibility that trouble may occur with them. Trouble with semiconductors may lead to personal injury, fire or property damage. Remember to give due consideration to safety when making your circuit designs, with appropriate measures such as (i) placement of substitutive, auxiliary circuits, (ii) use of non-flammable material or (iii) prevention against any malfunction or mishap.

Notes regarding these materials

1. These materials are intended as a reference to assist our customers in the selection of the Renesas Technology Corp. product best suited to the customer's application; they do not convey any license under any intellectual property rights, or any other rights, belonging to Renesas Technology Corp. or a third party.
2. Renesas Technology Corp. assumes no responsibility for any damage, or infringement of any third-party's rights, originating in the use of any product data, diagrams, charts, programs, algorithms, or circuit application examples contained in these materials.
3. All information contained in these materials, including product data, diagrams, charts, programs and algorithms represents information on products at the time of publication of these materials, and are subject to change by Renesas Technology Corp. without notice due to product improvements or other reasons. It is therefore recommended that customers contact Renesas Technology Corp. or an authorized Renesas Technology Corp. product distributor for the latest product information before purchasing a product listed herein.  
The information described here may contain technical inaccuracies or typographical errors. Renesas Technology Corp. assumes no responsibility for any damage, liability, or other loss rising from these inaccuracies or errors.  
Please also pay attention to information published by Renesas Technology Corp. by various means, including the Renesas Technology Corp. Semiconductor home page (<http://www.renesas.com>).
4. When using any or all of the information contained in these materials, including product data, diagrams, charts, programs, and algorithms, please be sure to evaluate all information as a total system before making a final decision on the applicability of the information and products. Renesas Technology Corp. assumes no responsibility for any damage, liability or other loss resulting from the information contained herein.
5. Renesas Technology Corp. semiconductors are not designed or manufactured for use in a device or system that is used under circumstances in which human life is potentially at stake. Please contact Renesas Technology Corp. or an authorized Renesas Technology Corp. product distributor when considering the use of a product contained herein for any specific purposes, such as apparatus or systems for transportation, vehicular, medical, aerospace, nuclear, or undersea repeater use.
6. The prior written approval of Renesas Technology Corp. is necessary to reprint or reproduce in whole or in part these materials.
7. If these products or technologies are subject to the Japanese export control restrictions, they must be exported under a license from the Japanese government and cannot be imported into a country other than the approved destination.  
Any diversion or reexport contrary to the export control laws and regulations of Japan and/ or the country of destination is prohibited.
8. Please contact Renesas Technology Corp. for further details on these materials or the products contained therein.

## Preface

The M30880T-EPB is an emulation probe for the M32C/88 Group MCUs. The M30880T-EPB is used by connecting to the PC7501 emulator main unit.

This user's manual mainly describes specifications of the M30880T-EPB emulation probe and how to setup it. For details on the following products, which are used with the M30880T-EPB, refer to each product's user's manual.

All the components of this product are shown in "1.1 Package components" (page 13). If there is any question or doubt about this product, contact your local distributor.

The related manuals for using this product are listed below. You can download the latest manuals from the Renesas Tools homepage (<http://www.renesas.com/en/tools>).

### Related manuals

Item	Manual
Accessory tools	M3T-100LCC-DMS User's Manual
	M3T-DUMMY100S User's Manual
	M3T-DIRECT100S User's Manual
	M3T-FLX-100NRB User's Manual
	M3T-100LCC-QSD User's Manual
	M3T-FLX-100NSD User's Manual
	M3T-F160-100NSD User's Manual
	M3T-FLX-144NSD User's Manual
Emulator main unit	PC7501 User's Manual
Emulator debugger	M3T-PD308F User's Manual
C compiler	NC308 User's Manual
Assembler	AS308 User's Manual
Integrated development environment	TM User's Manual

## Important

Before using this product, be sure to read this user's manual carefully.

Keep this user's manual, and refer to this when you have questions about this product.

### Emulator:

The emulator in this document refers to the following products that are manufactured by Renesas Technology Corp.:

- (1) PC7501 main unit
- (2) Emulation probe
- (3) Package converter board for connecting the user system

The emulator herein does not include the customer's user system and host machine.

### Purpose of use of the emulator:

This emulator is a device to support the development of a system that uses the M16C Family M32C/80 Series M32C/88 Group of Renesas 16/32-bit single-chip MCUs. It provides support for system development in both software and hardware.

Be sure to use this emulator correctly according to said purpose of use. Please avoid using this emulator for other than its intended purpose of use.

### For those who use this emulator:

This emulator can only be used by those who have carefully read the user's manual and know how to use it.

Use of this emulator requires the basic knowledge of electric circuits, logical circuits, and MCUs.

### When using the emulator:

- (1) This product is a development supporting unit for use in your program development and evaluation stages. In mass-producing your program you have finished developing, be sure to make a judgment on your own risk that it can be put to practical use by performing integration test, evaluation, or some experiment else.
- (2) In no event shall Renesas Solutions Corp. be liable for any consequence arising from the use of this product.
- (3) Renesas Solutions Corp. strives to renovate or provide a workaround for product malfunction at some charge or without charge. However, this does not necessarily mean that Renesas Solutions Corp. guarantees the renovation or the provision under any circumstances.
- (4) This product has been developed by assuming its use for program development and evaluation in laboratories. Therefore, it does not fall under the application of Electrical Appliance and Material Safety Law and protection against electromagnetic interference when used in Japan.
- (5) Renesas Solutions Corp. cannot predict all possible situations or possible cases of misuse where a potential danger exists. Therefore, the warnings written in this user's manual and the warning labels attached to this emulator do not necessarily cover all of such possible situations or cases. Please be sure to use this emulator correctly and safely on your own responsibility.
- (6) This product is not qualified under UL or other safety standards and IEC or other industry standards. This fact must be taken into account when taking this product from Japan to some other country.

**Usage restrictions:**

This emulator has been developed as a means of supporting system development by users. Therefore, do not use it as a device used for equipment-embedded applications. Also, do not use it for developing the systems or equipment used for the following purposes either:

- (1) Transportation and vehicular
- (2) Medical (equipment where human life is concerned)
- (3) Aerospace
- (4) Nuclear power control
- (5) Undersea repeater

If you are considering the use of this emulator for one of the above purposes, please be sure to consult your local distributor.

**About product changes:**

We are constantly making efforts to improve the design and performance of this emulator. Therefore, the specification or design of this emulator or its user's manual may be changed without prior notice.

**About the rights:**

- (1) We assume no responsibility for any damage or infringement on patent rights or any other rights arising from the use of any information, products or circuits presented in this user's manual.
- (2) The information or data in this user's manual does not implicitly or otherwise grant a license for patent rights or any other rights belonging to us or third parties.
- (3) This user's manual and this emulator are copyrighted, with all rights reserved by us. This user's manual may not be copied, duplicated or reproduced, in whole or part, without prior written consent of us.

**About diagrams:**

The diagrams in this user's manual may not all represent exactly the actual object.

# Precautions for Safety

## Definitions of Signal Words

In both the user's manual and on the product itself, several icons are used to insure proper handling of this product and also to prevent injuries to you or other persons, or damage to your properties.

This chapter describes the precautions which should be taken in order to use this product safely and properly. Be sure to read this chapter before using this product.



This symbol represents a warning about safety. It is used to arouse caution about a potential danger that will possibly inflict an injury on persons. To avoid a possible injury or death, please be sure to observe the safety message that follows this symbol.



**DANGER** indicates an imminently dangerous situation that will cause death or heavy wound unless it is avoided. However, there are no instances of such danger for the product presented in this user's manual.



**WARNING** indicates a potentially dangerous situation that will cause death or heavy wound unless it is avoided.



**CAUTION** indicates a potentially dangerous situation that will cause a slight injury or a medium-degree injury unless it is avoided.

**CAUTION**

**CAUTION** with no safety warning symbols attached indicates a potentially dangerous situation that will cause property damage unless it is avoided.

**IMPORTANT**

This is used in operation procedures or explanatory descriptions to convey exceptional conditions or cautions to the user.

In addition to the five above, the following are also used as appropriate.

△ means WARNING or CAUTION.

Example:



**CAUTION AGAINST AN ELECTRIC SHOCK**

⊘ means PROHIBITION.

Example:



**DISASSEMBLY PROHIBITED**

● means A FORCIBLE ACTION.

Example:



**UNPLUG THE POWER CABLE FROM THE RECEPTACLE.**

## ⚠ WARNING

### Warnings for AC Power Supply:



- If the attached AC power cable does not fit the receptacle, do not alter the AC power cable and do not plug it forcibly. Failure to comply may cause electric shock and/or fire.

- Use an AC power cable which complies with the safety standard of the country.

- Do not touch the plug of the AC power cable when your hands are wet. This may cause electric shock.

- This product is connected signal ground with frame ground. If your developing product is transformless (not having isolation transformer of AC power), this may cause electric shock. Also, this may give an unreparable damage to this product and your developing one.

While developing, connect AC power of the product to commercial power through isolation transformer in order to avoid these dangers.

- If other equipment is connected to the same branch circuit, care should be taken not to overload the circuit.



- When installing this equipment, insure that a reliable ground connection is maintained.



- If you smell a strange odor, hear an unusual sound, or see smoke coming from this product, then disconnect power immediately by unplugging the AC power cable from the outlet.

Do not use this as it is because of the danger of electric shock and/or fire. In this case, contact your local distributor.

- Before setting up this emulator and connecting it to other devices, turn off power or remove a power cable to prevent injury or product damage.

### Warnings to Be Taken for This Product:



- Do not disassemble or modify this product. Personal injury due to electric shock may occur if this product is disassembled and modified. Disassembling and modifying the product will void your warranty.

- Make sure nothing falls into the cooling fan on the top panel, especially liquids, metal objects, or anything combustible.

### Warning for Installation:



- Do not set this product in water or areas of high humidity. Make sure that the product does not get wet. Spilling water or some other liquid into the product may cause unreparable damage.

### Warning for Use Environment:



- This equipment is to be used in an environment with a maximum ambient temperature of 35°C. Care should be taken that this temperature is not exceeded.

 **CAUTION****Cautions to Be Taken for Turning On the Power:**

- Turn ON the power of the emulator and user system as simultaneously as possible. Turn OFF the power of the emulator and user system as simultaneously as possible.
- Do not leave either the emulator or user system powered on, because of leakage current the internal circuits may be damaged.
- When turning ON the power again after shutting OFF the power, wait about 10 seconds.

**Cautions to Be Taken for Handling This Product:**

- Use caution when handling the main unit. Be careful not to apply a mechanical shock.
- Do not touch the connector pins of the emulator main unit and the target MCU connector pins. Static electricity may damage the internal circuits.
- Do not pull this product by the flexible cable for connecting to the emulator main unit and emulation probe. The cable may cause a break.
- Do not flex the flexible cable for connecting to the emulator main unit and emulation probe excessively. The cable may cause a break.
- Do not use inch-size screws for this equipment. The screws used in this equipment are all ISO (meter-size) type screws. When replacing screws, use same type screws as equipped before.

**Caution to Be Taken for System Malfunctions:**

- If the emulator malfunctions because of interference like external noise, do the following to remedy the trouble.
  - (1) Press the RESET switch on the front panel of the PC7501.
  - (2) If normal operation is not restored after step (1), shut OFF power to the emulator once and then reactivate it.



# Contents

Preface.....	3
Important.....	4
Precautions for Safety .....	6
User Registration .....	11
Terminology .....	12
1. Outline .....	13
1.1 Package Components.....	13
1.2 Other Tool Products Required for Development.....	13
1.3 System Configuration.....	14
1.3.1 System Configuration.....	14
1.3.2 Names and Functions of the PC7501 Upper Panel LEDs.....	15
1.4 Specifications .....	17
1.5 Operating Environment .....	18
2. Setup .....	19
2.1 Flowchart of Starting Up the Emulator.....	19
2.2 Installing the Emulator Debugger.....	20
2.3 Connecting the Host Machine.....	21
2.4 Connecting the PC7501.....	22
2.5 Connecting the Power Supply for the Emulator.....	23
2.6 Turning ON the Power .....	24
2.6.1 Checking Connections of the Emulator System .....	24
2.6.2 Turning ON/OFF the Power .....	24
2.6.3 Power Supply to the User System .....	24
2.6.4 LED Display When the Emulator Starts Up Normally.....	25
2.7 Downloading Firmware .....	26
2.7.1 When It is Necessary to Download Firmware.....	26
2.7.2 Downloading Firmware in Maintenance Mode.....	26
2.8 Self-check .....	27
2.8.1 Self-check Procedure.....	27
2.8.2 If an Error is Detected in the Self-check .....	28
2.9 Connecting the User System .....	29
2.9.1 Connecting to a 100-pin LCC Socket .....	30
2.9.2 Connecting to a 100-pin 0.65-mm-pitch Foot Pattern (Part 1).....	31
2.9.3 Connecting to a 100-pin 0.65-mm-pitch Foot Pattern (Part 2).....	32
2.9.4 Connecting to a 100-pin 0.65-mm-pitch Foot Pattern (Part 3).....	33
2.9.5 Connecting to a 100-pin 0.5-mm-pitch Foot Pattern (Part 1).....	34
2.9.6 Connecting to a 100-pin 0.5-mm-pitch Foot Pattern (Part 2).....	35
2.9.7 Connecting to a 100-pin 0.5-mm-pitch Foot Pattern (Part 1).....	36
2.9.8 Connecting to a 144-pin 0.5-mm-pitch Foot Pattern.....	37
2.10 Setting Switches.....	38
2.10.1 Setting Switches of Emulation Probe .....	38
2.10.2 Selecting Clock Supply .....	42
2.10.3 A/D Conversion Bypass Capacitors.....	47
3. Usage (Emulator Debugger) .....	48
3.1 Starting Up the Emulator Debugger (Init Dialog Box).....	48
3.2 Starting Up the Emulator Debugger (EMEM Dialog Box).....	55
3.3 Program Window.....	60
3.4 Hardware Breakpoint Setting Window .....	64
3.5 Trace Window .....	69
3.6 RAM Monitor Window .....	74

4. Hardware Specifications .....	77
4.1 Target MCU Specifications .....	77
4.2 Differences between the Actual MCU and Emulator .....	78
Note on Differences between the Actual MCU and Emulator .....	78
Note on RESET* Input .....	78
Note on RDY* Input .....	78
Note on HOLD* Input .....	78
Note on NMI* Input .....	78
Notes on Reset Vector Area .....	79
Notes on Stack Area .....	79
Notes on Maskable Interrupts .....	79
Notes on Access Prohibited Area .....	79
Note on DMA Transfer .....	79
Note on DMAC II Transfer Completion Interrupts .....	80
Note on Final Evaluation .....	80
4.3 Connection Diagrams .....	81
4.4 External Dimensions .....	83
4.4.1 External Dimensions of the Emulation Probe .....	83
4.4.2 External Dimensions of the M30800T-PTC .....	84
4.4.3 External Dimensions of the M3T-F160-100NSD .....	85
4.4.4 External Dimensions of the M3T-FLX-144NSD .....	85
4.5 Notes on Using This Product .....	86
Notes on Downloading Firmware .....	86
Note on Quitting the Emulator Debugger .....	86
Notes on Power Supply to the User System .....	86
Notes on Clock Supply to an MCU .....	87
Notes on Using the CPU Clock at Less than 10 MHz .....	87
Notes on Address-Match Interrupt .....	87
Notes on EMEM Dialog Box .....	88
Notes on Watchdog Function .....	88
Notes on Debugging in CPU Rewrite Mode .....	89
Note on Software Break .....	89
Note on Downloading Programs .....	89
Notes on Service-Life of the MCU's Internal Flash ROM .....	89
Note on Voltage Detect Circuit .....	89
Note on Protect Resistor .....	90
Note on Memory Access .....	90
Notes on A/D Conversion .....	91
5. Troubleshooting .....	92
5.1 Flowchart to Remedy the Troubles .....	92
5.2 When the Emulator Debugger Does Not Startup Properly .....	93
5.3 How to Request for Support .....	96
6. Maintenance and Guarantee .....	97
6.1 User Registration .....	97
6.2 Maintenance .....	97
6.3 Guarantee .....	97
6.4 Repair Provisions .....	97
6.5 How to Make Request for Repair .....	98

## User Registration

When you have purchased the emulator presented in this user's manual, please be sure to register it. As the hardware tool user registration FAX sheet is included with this manual, fill it in and FAX it to your local distributor or email the same contents to the following address. Your registered information is used for only after-sale services, and not for any other purposes. Without user registration, you will not be able to receive maintenance services such as a notification of field changes or trouble information. So be sure to carry out the user registration.

For more information about user registration, please email to the following address.

[regist\\_tool@renesas.com](mailto:regist_tool@renesas.com)

## Terminology

Some specific words used in this user's manual are defined as follows:

### **Emulator system**

This means an emulator system built around the PC7501 emulator. The PC7501 emulator system is configured with an emulator main unit, emulation probe, host machine and emulator debugger.

### **Emulator main unit (Hereafter PC7501)**

This means an emulator main unit for M16C Family MCUs.

### **Emulation probe**

This means the emulation probe (this product) for the M32C/88 Group MCUs.

### **Emulator debugger**

This means a software tool M3T-PD308F V.3.20 Release 1 to control the emulator from a host machine through an interface.

### **Firmware**

Program that analyzes contents of communication with the emulator debugger and controls the emulator hardware. This program is installed in the flash memory in the emulator main unit. This program is downloadable from the emulator debugger to upgrade the firmware or to support other MCUs.

### **Host machine**

This means a personal computer used to control the emulator main unit and emulation probe.

### **Software break**

A software break is a function to break the program before the system executes an instruction at the specified address. The instruction at the preset address will not be executed.

### **Hardware break**

A hardware break is a function to break the program when the system detects a write/read of data to/from memory or a leading/trailing edge of the signal entered from the external trace cable. The former break function is called address break; and the latter break function is called trigger break. While the instruction at the address where the software break is set is not executed, a hardware break is performed after the specified instruction is executed.

### **Target MCU**

This means the MCU you are going to debug.

### **User system**

This means a user's application system using the microcomputer to be debugged.

### **Target program**

This means the program you are going to debug.

### **Evaluation MCU**

This means the MCU mounted on the emulation probe which is operated in the specific mode for tools.

\*

In this user's manual, this symbol is used to show active Low. (e.g. RESET\*: Reset signal)

## 1. Outline

This chapter describes the package components, the system configuration and the preparation for using this product for the first time.

### 1.1 Package Components

The M30880T-EPB package consists of the following items. When unpacking it, check to see if your M30880T-EPB contains all of these items.

Table 1.1 Package components

Item	Quantity
M30880T-EPB emulation probe	1
M30800T-PTC (pre-mounted) converter board for 100-pin LCC	1
IC61-1004-051 100-pin LCC socket made by Yamaichi Electronics Co., Ltd.	1
OSC-3 (32MHz) oscillator circuit board	1
OSC-2 oscillator circuit bare board	1
Hardware tool user registration FAX sheet (English)	1
Hardware tool user registration FAX sheet (Japanese)	1
M30880T-EPB Supplementary Document (English)	1
M30880T-EPB Supplementary Document (Japanese)	1
M30880T-EPB User's Manual (this manual)	1
M30880T-EPB User's Manual (Japanese)	1

- \* Please keep the M30880T-EPB's packing box and cushion material in your place for reuse at a later time when sending your product for repair or other purposes. Always use these packing box and cushion material when transporting this product.
- \* If there is any question or doubt about the packaged product, contact your local distributor.
- \* For purchasing the IC61-1004-051 or for technical information, contact Yamaichi Electronics Co., Ltd.  
<http://www.yamaichi.co.jp/e/index.shtml>

### 1.2 Other Tool Products Required for Development

To bring forward programs development on the M32C/88 Group MCUs, the products listed below are necessary in addition to those contained package above. Get them separately.

Table 1.2 Other tool products required for development

Product	Product name	Notes	
Emulator main unit	PC7501	Required	
Emulator debugger	M3T-PD308F V.3.20 Release 1	Required	
Converter board	144-pin 0.5-mm-pitch LQFP (144P6Q-A)	M3T-FLX-144NSD	Required according to the foot pattern of the user system (see "2.9 Connecting the User System" on page 29)
	100-pin 0.5-mm-pitch LQFP (100P6Q-A)	M3T-100LCC-QSD	
		M3T-100LCC-DMS + M3T-FLX-100NSD	
		M3T-F160-100NSD	
	100-pin 0.65-mm-pitch QFP (100P6S-A)	M3T-100LCC-DMS + M3T-DUMMY100S	
		M3T-100LCC-DMS + M3T-DIRECT100S	
M3T-100LCC-DMS + M3T-FLX-100NRB			

- \* To purchase these products, contact your local distributor.

## 1.3 System Configuration

### 1.3.1 System Configuration

Figure 1.1 shows a configuration of the M30880T-EPB system.

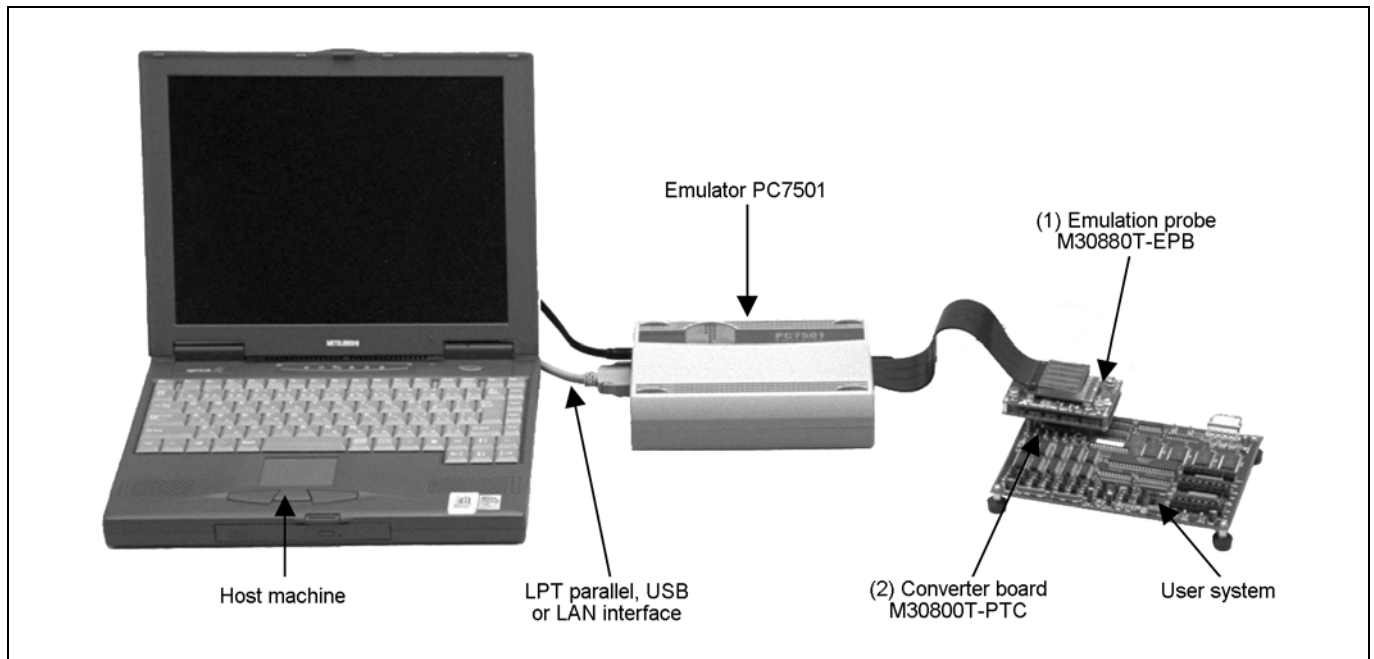

Figure 1.1 System configuration

- (1) Emulation probe M30880T-EPB (this product)  
This emulation probe contains an evaluation MCU.
- (2) Converter board M30800T-PTC (included)  
This is a converter board for connecting to the user system (for 100-pin 0.65-mm-pitch LCC socket). For details, refer to "2.9 Connecting the User System" (page 29)

1.3.2 Names and Functions of the PC7501 Upper Panel LEDs

Figure 1.2 shows the names of the LEDs on the upper panel of the emulator.

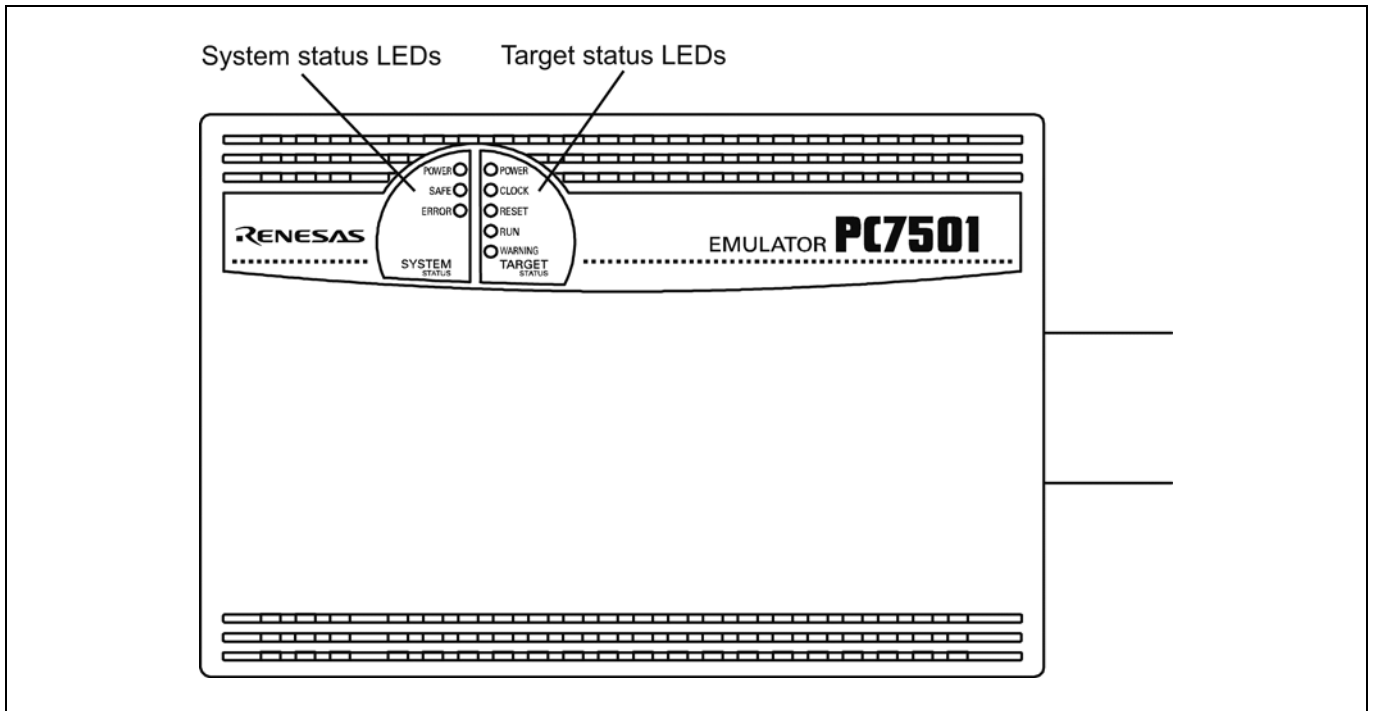

Figure 1.2 Names of the LEDs on the upper panel of the PC7501

(1) System Status LEDs

The system status LEDs indicate the emulator PC7501's power supply, firmware operating status, etc. Table 1.3 lists the definition of each system status LED.

Table 1.3 Definitions of the system status LEDs

Name	Status	Meaning
POWER	ON	Emulator system power supply is turned ON.
	OFF	Emulator system power supply is turned OFF.
SAFE	ON	Emulator system is operating normally.
	Flashing	Special mode (maintenance mode) for downloading firmware. The emulator system does not operate except for downloading firmware and the self-check.
	OFF	Emulator system is not operating normally.
ERROR	ON	Emulator is not operating normally.
	Flashing	Downloading firmware.
	OFF	Emulator is operating normally.

## (2) Target Status LEDs

The target status LEDs indicate the target MCU's operating status and target board's power supply. Table 1.4 lists the definition of each target status LED.

Table 1.4 Definitions of the target status LEDs

Name	Status	Meaning
POWER	ON	Power is supplied to the target MCU.
	OFF	Power is not supplied to the target MCU.
CLOCK	ON	Target MCU internal clock is oscillating.
	OFF	Target MCU internal clock is not oscillating.
RESET	ON	Target MCU is being reset.
	OFF	Target MCU is not being reset.
RUN	ON	User program is being executed.
	OFF	User program has been halted.
WARNING	ON	Target MCU internal clock is not oscillating.
	OFF	Target MCU internal clock is oscillating.

### CAUTION

Caution for Target Status POWER LED:



- If your MCU has two or more power supply terminals (VCC), you need to supply power to all the terminals.



## 1.4 Specifications

Tables 1.5 and 1.6 list the specifications of the M30880T-EPB.

Table 1.5 M30880T-EPB specifications (1/2)

Applicable MCUs	M32C/88 Group
Evaluation MCU	M30882FJVGP ROM size: 512 KB + 4 KB, RAM size: 18 KB
Usable mode	Single-chip mode
Maximum operating frequency	VCC1 = VCC2 = 4.2 to 5.5 V: 32 MHz
Applicable power supply	4.2--5.5 V
Basic debugging functions	<ul style="list-style-type: none"> <li>- Download</li> <li>- Software break (max. 64 points)</li> <li>- Program execution/stop (allows free-run execution supporting software breaks)</li> <li>- Memory reference/setting (reference/setting C-variables, run-time execution)</li> <li>- Register reference/setting</li> <li>- Disassemble display</li> <li>- C-level debugging, etc.</li> </ul>
Real-time trace function	<ul style="list-style-type: none"> <li>- 256K-cycle bus information recordable (Bus, external trigger, time stamp)</li> <li>- 5 trace modes supported (Break/Before/About/After/Full)</li> <li>- Can be recorded ON/OFF by events</li> </ul>
Real-time RAM monitor function	<ul style="list-style-type: none"> <li>- 4,096 bytes (256 bytes x16)</li> <li>- Data/last access result</li> </ul>
Hardware break function	8 points (Execution address, bus detection, interrupt, external trigger signal)
Execution time measurement function	Time between program start and stop Maximum/minimum/average execution time and pass count of specified four zones. Count clock: Equal to MCU Clock or 16 MHz
C0 coverage	8,192 KB (256 KB x 32 blocks)
External trigger input/event output	External trigger input (MCU-dependent-voltage CMOS level x8) or event output (break x1, event x7)

Table 1.6 M30880T-EPB specifications (2/2)

Host machine interface	- LPT parallel (ECP, EPP, Byte/compatibility and Nibble/compatibility modes) - USB (USB 1.1, full-speed) - LAN (10BASE-T)
Power supply to emulator	Supplied from included AC adapter (power supply voltage: 100--240 V, 50/60 Hz)
Connection to user system (see "2.9 Connecting the User System" on page 29)	For 144-pin 0.5-mm-pitch LQFP (144P6Q-A): M3T-FLX-144NSD (not included) For 100-pin 0.5-mm-pitch LQFP (100P6Q-A): (1) M30800T-PTC (included) + M3T-100LCC-QSD (not included) (2) M30800T-PTC (included) + M3T-100LCC-DMS (not included) + M3T-FLX-100NSD (not included) (3) M3T-F160-100NSD (not included) For 100-pin 0.65-mm-pitch QFP (100P6S-A): (1) M30800T-PTC (included) + M3T-100LCC-DMS (not included) + M3T-FLX-100NRB (not included) (2) M30800T-PTC (included) + M3T-100LCC-DMS (not included) + M3T-DUMMY100S (not included) (3) M30800T-PTC (included) + M3T-100LCC-DMS (not included) + M3T-DIRECT100S (not included) For 100-pin LCC socket: M30800T-PTC (included) + IC61-1004-051 (included)

## 1.5 Operating Environment

Be sure to use this emulator with the operating environmental of the emulator and host machine listed in Tables 1.7 and 1.8.

Table 1.7 Operating environmental conditions

Item	Description
Operating temperature	5 to 35°C (no dew)
Storage temperature	-10 to 60°C (no dew)

Table 1.8 Operating environment of the host machine

Item	Description
Host machine	IBM PC/AT compatibles
OS	Windows Me Windows 98 Windows XP Windows 2000
CPU	Pentium III 600 MHz or more recommended
Memory	128 MB or more recommended
Pointing device such as mouse	Mouse or any other pointing device usable with the above OS that can be connected to the main body of the host machine.

\* Windows and Windows NT are either registered trademarks or trademarks of Microsoft Corporation in the United States and other countries.

## 2. Setup

This chapter describes the preparation for using this product, the procedure for starting up the emulator and how to change settings.

### 2.1 Flowchart of Starting Up the Emulator

The procedure for starting up the emulator is shown in Figure 2.1. For details, refer to each section hereafter. And, when the emulator does not start up normally, refer to “5. Troubleshooting” (page 92).

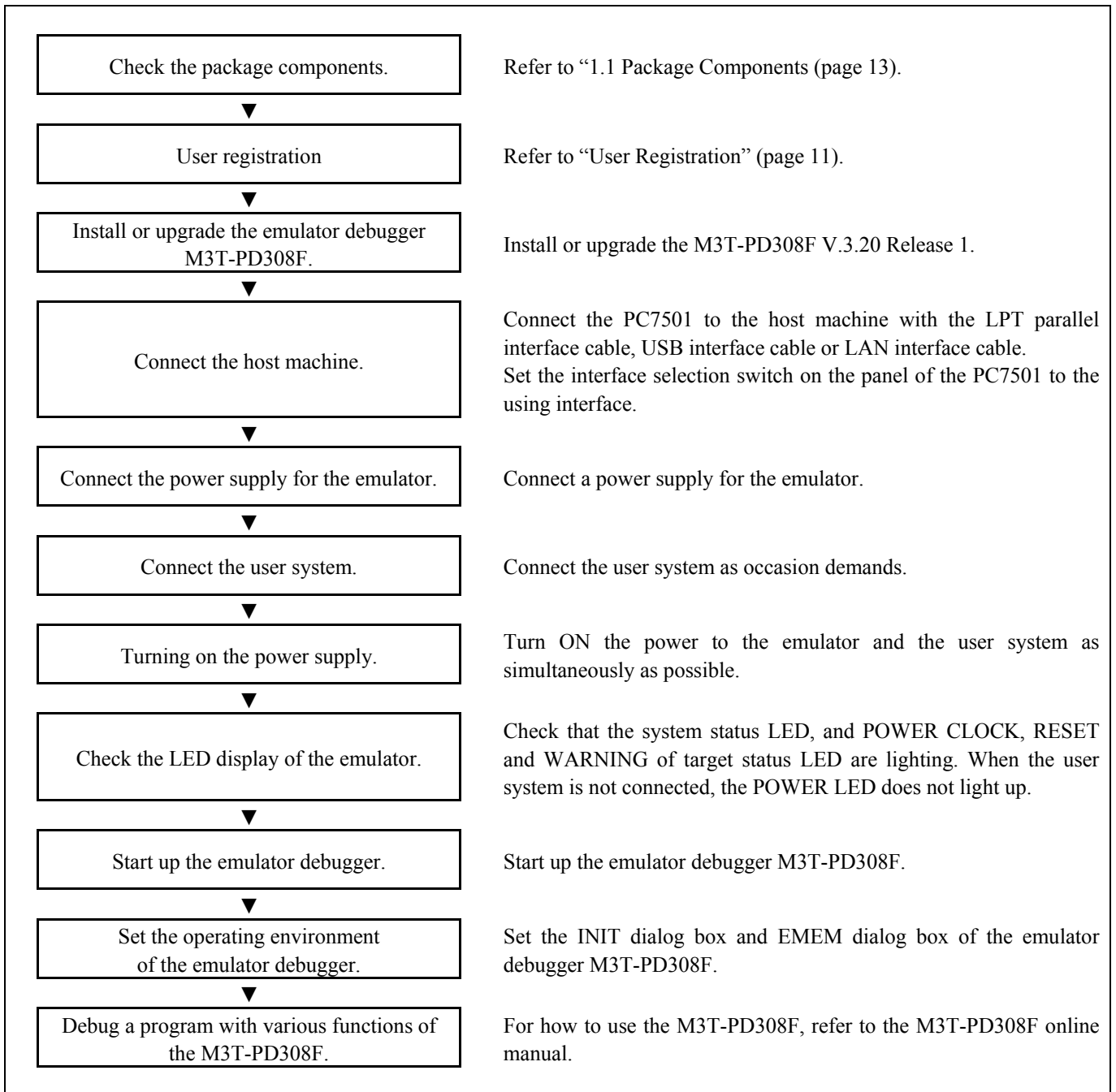

Figure 2.1 Flowchart of starting up the emulator

## 2.2 Installing the Emulator Debugger

If the OS used in your host machine is Windows XP or 2000, this installation must be executed by a user with administrator rights. Be aware that users without administrator rights cannot complete the installation.

Install the emulator debugger M3T-PD308F following the procedure described below.

(1) Downloading the M3T-PD308F V.3.20 Release 1

Download the M3T-PD308F V.3.20 Release 1 from the URL below.

[http://www.renesas.com/eng/mpumcu/upgrades/in\\_circuit\\_emulators/pc7501/index.html](http://www.renesas.com/eng/mpumcu/upgrades/in_circuit_emulators/pc7501/index.html)

(2) Launching the installer

Start the "setup.exe" program.

(3) Entering the user information

In the "user information" dialog box, enter the user information (contractor, section, contact address, and host machine). The supplied information will be turned into a format by which technical support will be provided by e-mail.

(4) Selecting components

In the "component selection" dialog box, select the components you want to install. In this dialog box you can change the directory in which to install.

(5) Completing the installation

A dialog box will be displayed indicating that setup has been completed. It means that the installation you made is completed.

### 2.3 Connecting the Host Machine

When connecting the emulator PC7501 to a host machine, you can choose your desired interface from LPT parallel interface, USB interface and LAN interface. Use the interface selection switch on the emulator PC7501's rear panel to specify your desired interface. Figure 2.2 shows the outline to connect each interface cable.

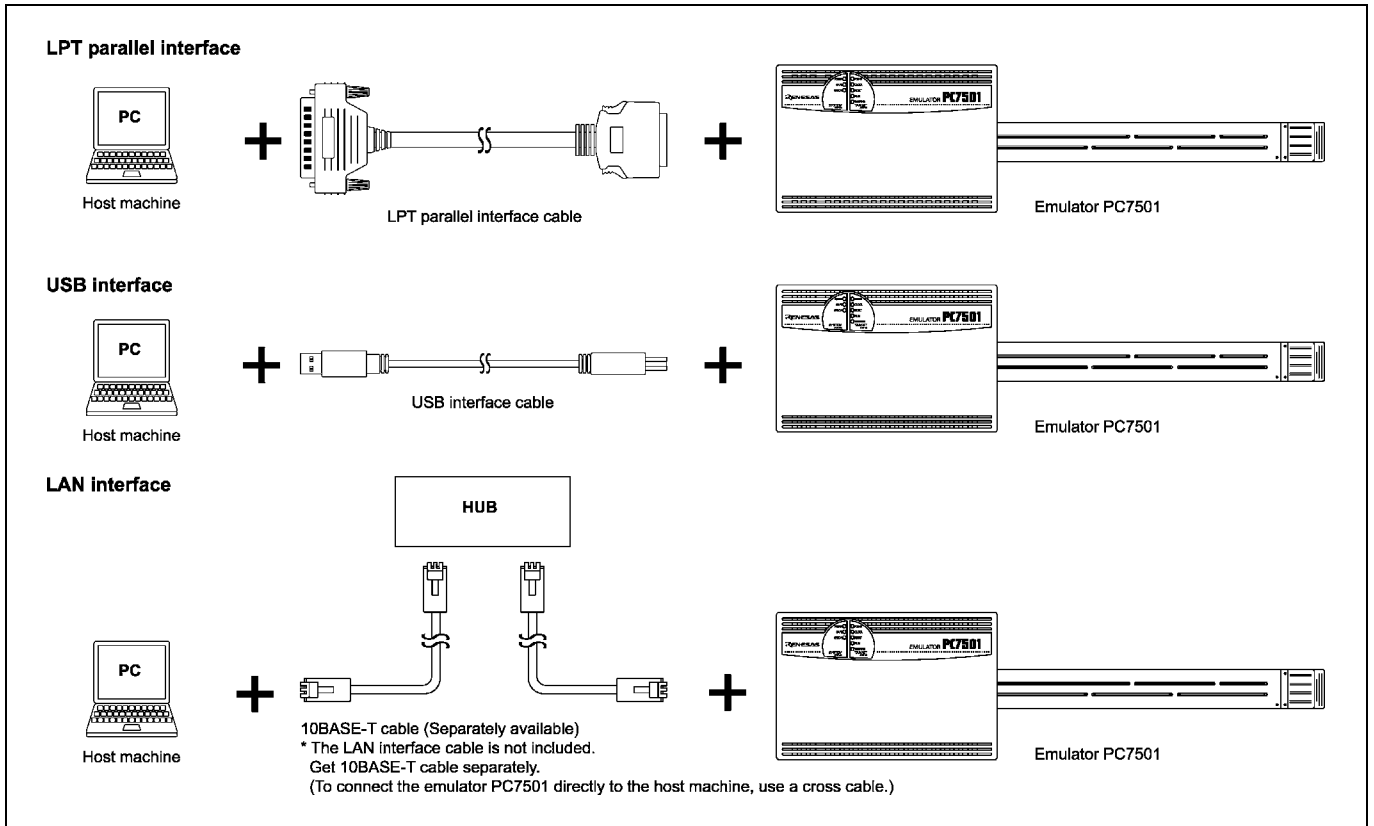

Figure 2.2 Outline for interface cable connections

## 2.4 Connecting the PC7501

Figure 2.3 shows how to connect the PC7501 and the emulation probe.

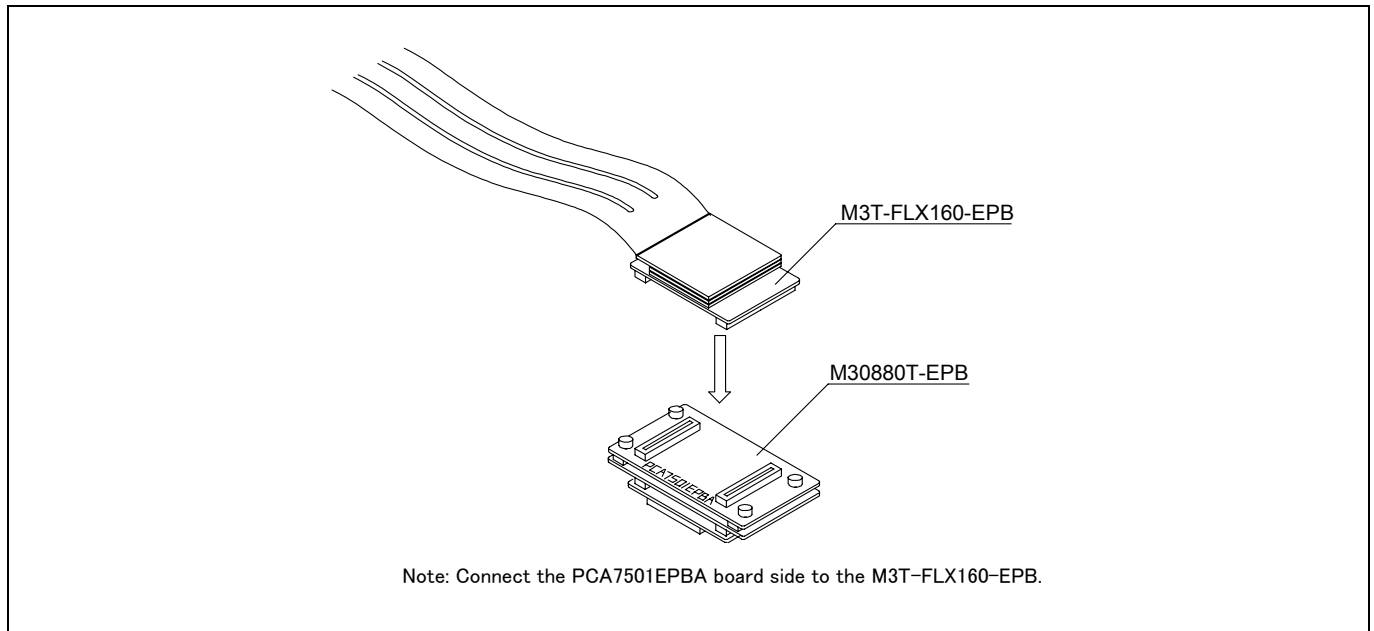

Figure 2.3 Connecting the PC7501 and emulation probe

### CAUTION

#### Cautions for Connecting the PC7501:



- When connecting the emulation probe, be sure to hold the both sides of the emulation probe horizontally and insert it directly.
- Connect the PCA7501EPBA board to the M3T-FLX160-EPB.
- Always shut OFF power before connecting the emulation probe. Otherwise, internal circuits may be damaged.

## 2.5 Connecting the Power Supply for the Emulator

The power is supplied from AC adapter to the emulator PC7501. Here following explains how to connect the AC adapter.

- (1) Turn OFF the power to the PC7501.
- (2) Connect the DC cable of AC adapter to the PC7501.
- (3) Connect the AC power cable to the AC adapter.
- (4) Connect the AC power cable to the receptacle.

### CAUTION

#### Cautions for AC Adapter:



- Use only the AC adapter included in PC7501 package.
- The included AC adapter is for PC7501. Do not use it for other product.
- Before installing this equipment or connecting it to other equipment, disconnect the AC power cable from its outlet to prevent injury or accident.
- The DC plug on the included AC adapter has the below polarity.



- The included AC adapter has no power supply switch. The AC adapter is always active while connecting the AC power cable. Check if the power is supplied by the LED of AC adapter.

## 2.6 Turning ON the Power

### 2.6.1 Checking the Connections of the Emulator System

Before turning the power ON, check the connection of the interface cable with host machine, PC7501, emulation probe, and user system.

### 2.6.2 Turning ON/OFF the Power

- Turn ON the power of the emulator and user system as simultaneously as possible.
- Turn OFF the power of the emulator and user system as simultaneously as possible.
- Do not leave either the emulator or user system powered on, because of leakage current the internal circuits may be damaged.
- When turning ON the power again after shutting OFF the power, wait for about 10 seconds.

## IMPORTANT

### Notes on Power Supply:

- The emulator's pin Vcc is connected to the user system in order to monitor user system voltage. For this reason, the emulator cannot supply power to the user system. Therefore, provide the user system with a separate power supply from that of the emulator.
- Keep user system power supply voltage within the MCU's specified range (4.2 to 5.5 V).
- Do not change user system power supply voltage after power has been activated.

### 2.6.3 Power Supply to the User System

This emulator cannot supply the power to the user system, therefore design your system so that the user system is powered separately.

The voltage of the user system should be within the following. And do not change the voltage after activating the system.

$$4.2 \text{ V} \leq \text{VCC1} = \text{VCC2} \leq 5.5 \text{ V}$$



### 2.6.4 LED Display When the Emulator Starts Up Normally

Figure 2.4 shows upper panel LED lighting status when the emulator started up properly. Check it when starting up the emulator system.

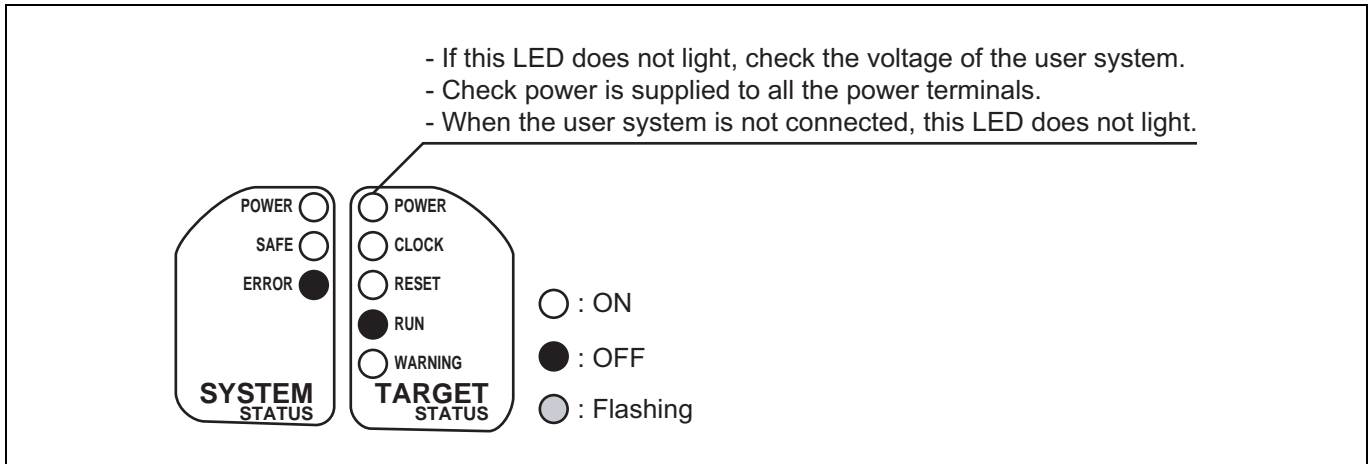

Figure 2.4 LED display when the power turned on PC7501

## IMPORTANT

### Note on CLOCK LED:

- If CLOCK LED does not turn on, check the following:
  - (1) Immediately after starting PC7501 (before starting the emulator debugger)  
 Check if the oscillation circuit within the PC7501 emulator main unit oscillates normally.
  - (2) After starting the emulator debugger (after setting the Init dialog box)  
 Check the oscillation circuit set in the Init dialog box oscillates normally.

## 2.7 Downloading Firmware

### 2.7.1 When It is Necessary to Download Firmware

It is necessary to download the firmware in the cases listed below. Normally, the following are automatically detected when the emulator debugger is started up, and the firmware is downloaded.

- (1) When you use this product for the first time
- (2) When the firmware has been upgraded
- (3) When the emulator debugger has been upgraded
- (4) When you use this product with a PC7501 which was used with other emulation probe before

If downloading firmware is not completed in the cases below, redownload the firmware.

- When the power is unexpectedly shut down during a download from the emulator debugger
- When a communications interface cable is unexpectedly pulled out

### 2.7.2 Downloading Firmware in Maintenance Mode

Download the firmware in maintenance mode as explained here following. **The user system must not be connected when downloading the firmware.**

- (1) Set the interface select switch on the rear panel of the PC7501 to the LPT side and connect the LPT parallel interface cable to the PC7501 and the host machine.
- (2) Within 2 seconds of activating power to the emulator, press the RESET switch on the PC7501 front panel to switch to maintenance mode.

Switched to maintenance mode, the SAFE SYSTEM STATUS LED begins to flash.

- (3) Start up the emulator debugger. When the Init dialog box setup is complete, the dialog which urges to download the firmware will appear. Download the firmware following messages. Required time for downloading the firmware is about 60 seconds.

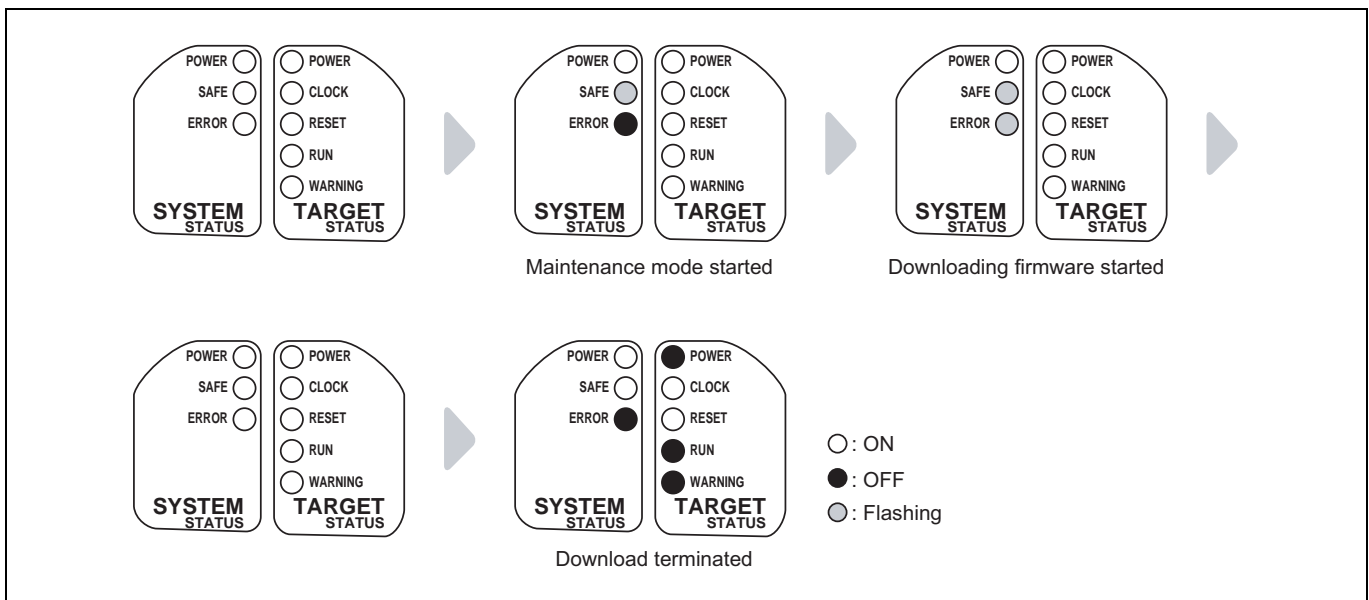

Figure 2.5 Downloading firmware in maintenance mode

## IMPORTANT

### Note on Downloading Firmware:

- Do not shut OFF power while the firmware is being downloaded. Doing so, the emulator will not start up properly. If power is shut OFF by mistake, redownload the firmware in maintenance mode.

## 2.8 Self-check

### 2.8.1 Self-check Procedure

To run the emulator self-check, do so as explained here below. While the self-check is in progress, LEDs will change as shown in Figure 2.6.

- (1) If the user system is connected, disconnect it.
- (2) Set the switches as the factory-settings to execute the self-check (see Table 2.1).
- (3) Within 2 seconds of activating power to the emulator, press the system reset switch on the emulator front panel to switch the emulator to maintenance mode.
- (4) Check the "SAFE" LED starts flashing and then press the system reset switch again.
- (5) The self-check will start. If the normal result is displayed in about 20 seconds, the self-check terminated normally.

Table 2.1 Switch settings at self-check

Switch	Setting
AVCC/AVSS switch (SW1)	EXT side
P87 switch (SW2)	P87 side
P86 switch (SW3)	P86 side
XOUT switch (SW4)	NC side
A/D conversion bit selection switch (SW5)	All upper side

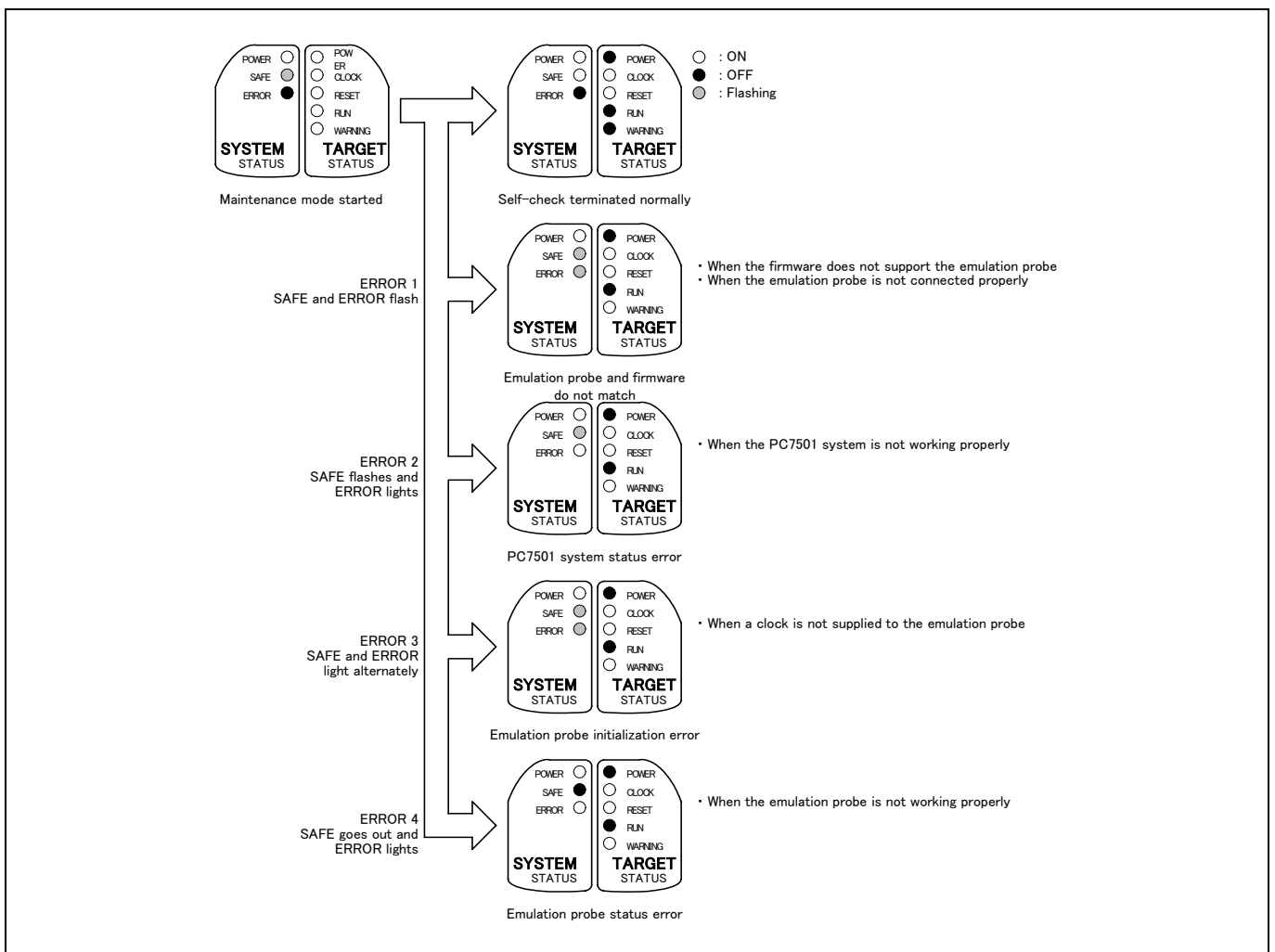

Figure 2.6 Self-check procedure

### 2.8.2 If an Error is Detected in the Self-check

If the self-check does not result normally (ERROR 1 to ERROR 4 in Figure 2.6), check the following.

- (1) Recheck the connection of the emulation probe and PC7501.
- (2) Redownload the proper firmware.

## IMPORTANT

### Note on the Self-check:

- If the self-check does not result normally (excluding user system errors), the emulation probe may be damaged. Then contact your local distributor.

### 2.9 Connecting the User System

There are eight ways available to connect the emulation probe to user systems as shown in Figure 2.7.

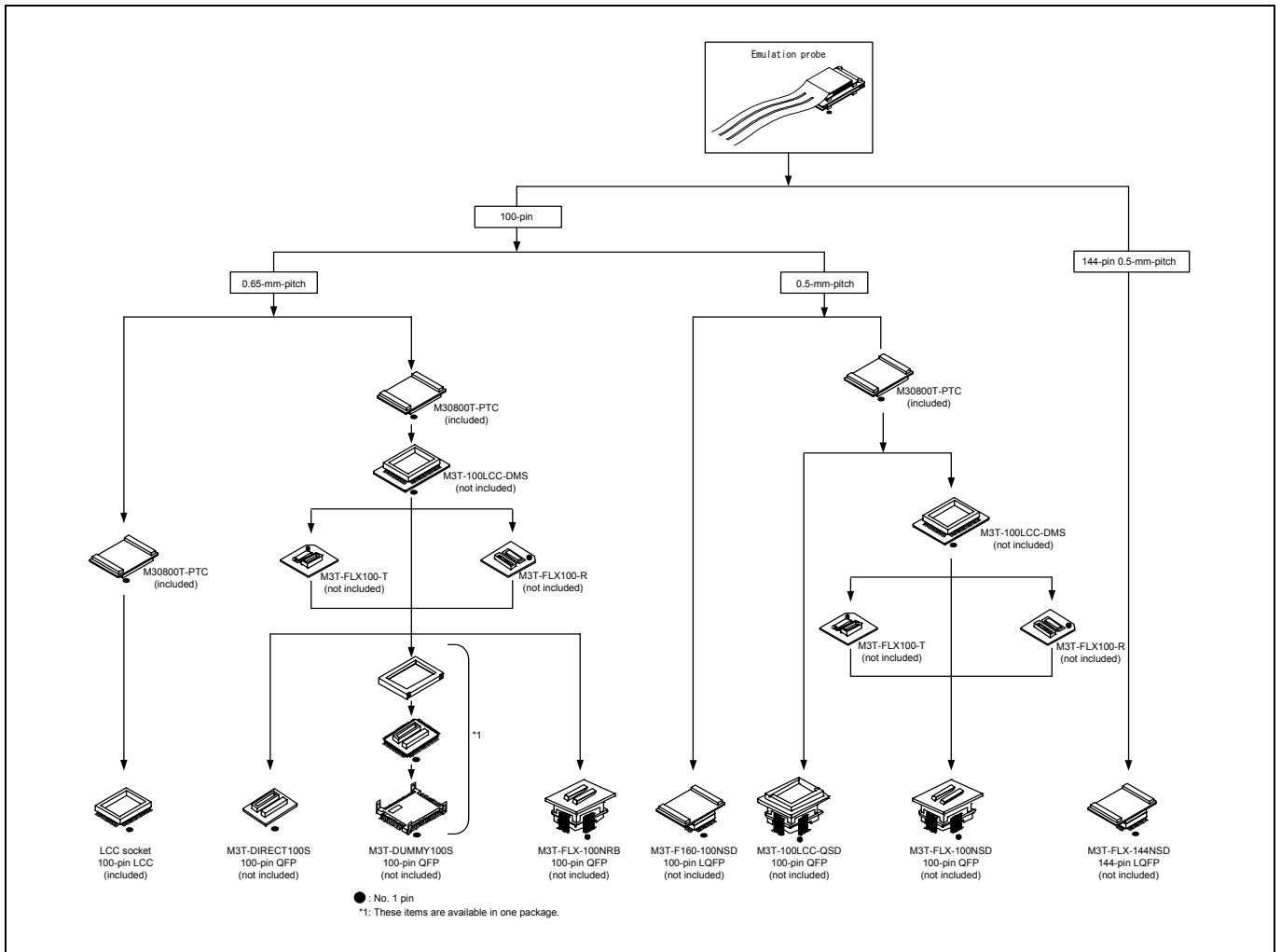

Figure 2.7 Connection of the M30880T-EPB and user system

**⚠ CAUTION**

**Note on Connecting the User System:**

- Take care not to attach the converter board in a wrong direction. It may cause a fatal damage to the emulator.

### 2.9.1 Connecting to a 100-pin LCC Socket

When connecting the emulation probe to a 100-pin LCC socket (Yamaichi Electronics Co., Ltd.: IC61-1004-051 etc.) on the user system, following the procedure below.

- (1) Attach the CN2 side of the M30880T-EPB to the CN2 side of the M30800T-PTC.
- (2) Attach the M30800T-PTC to the 100-pin LCC socket.

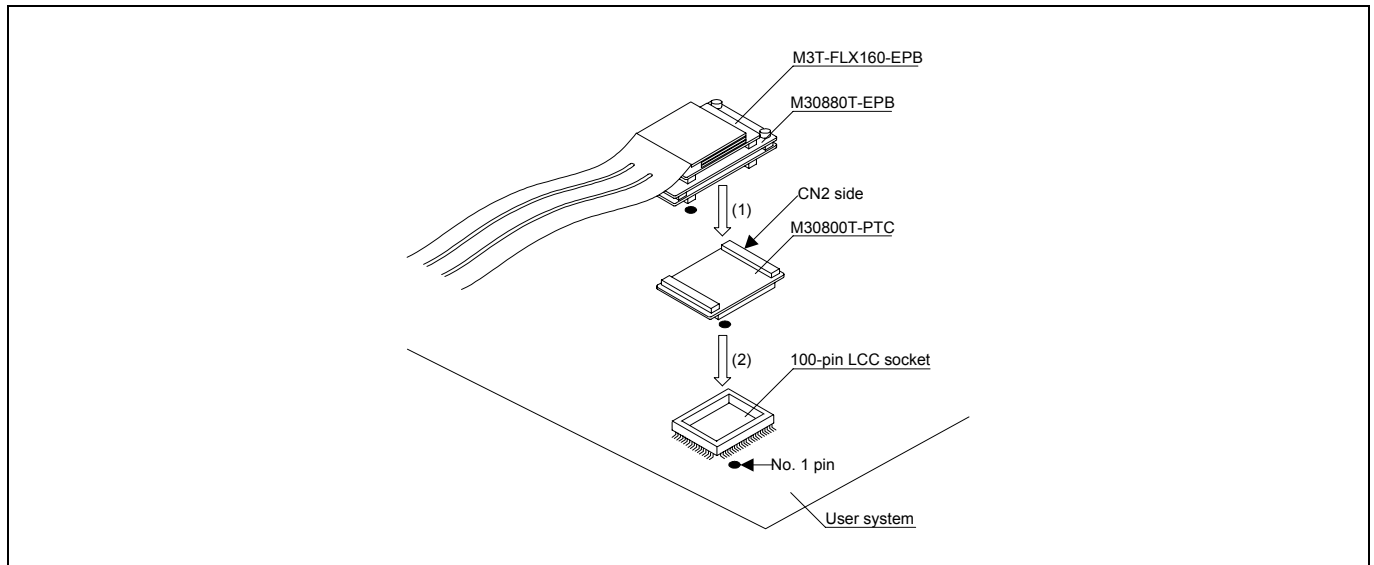

Figure 2.8 Connecting to a 100-pin LCC socket

## ⚠ CAUTION

### Notes on Connecting the User System:



- Take care not to attach the converter board in a wrong direction. It may cause a fatal damage to the emulator.
- The small connectors of the M30880T-EPB and M30800T-PTC are guaranteed for only 50 insertion/removal iterations.
- For purchasing the IC61-1004-051 or for technical information, contact Yamaichi Electronics Co., Ltd.  
<http://www.yamaichi.co.jp/e/index.shtml>

### 2.9.2 Connecting to a 100-pin 0.65-mm-pitch Foot Pattern (Part 1)

Figure 2.9 shows how to connect the emulation probe to a 100-pin 0.65-mm-pitch foot pattern on the user system with the M3T-DUMMY100S (not included), and here following is its procedure.

For details on the M3T-100LCC-DMS and M3T-DUMMY100S, refer to each user's manual.

- (1) Attach the M3T-DUMMY100S to the user system.
- (2) Attach the M3T-100LCC-DMS to the M3T-DUMMY100S.
- (3) Attach the M30800T-PTC to the M30880T-EPB.
- (4) Attach the M30800T-PTC to the M3T-100LCC-DMS.

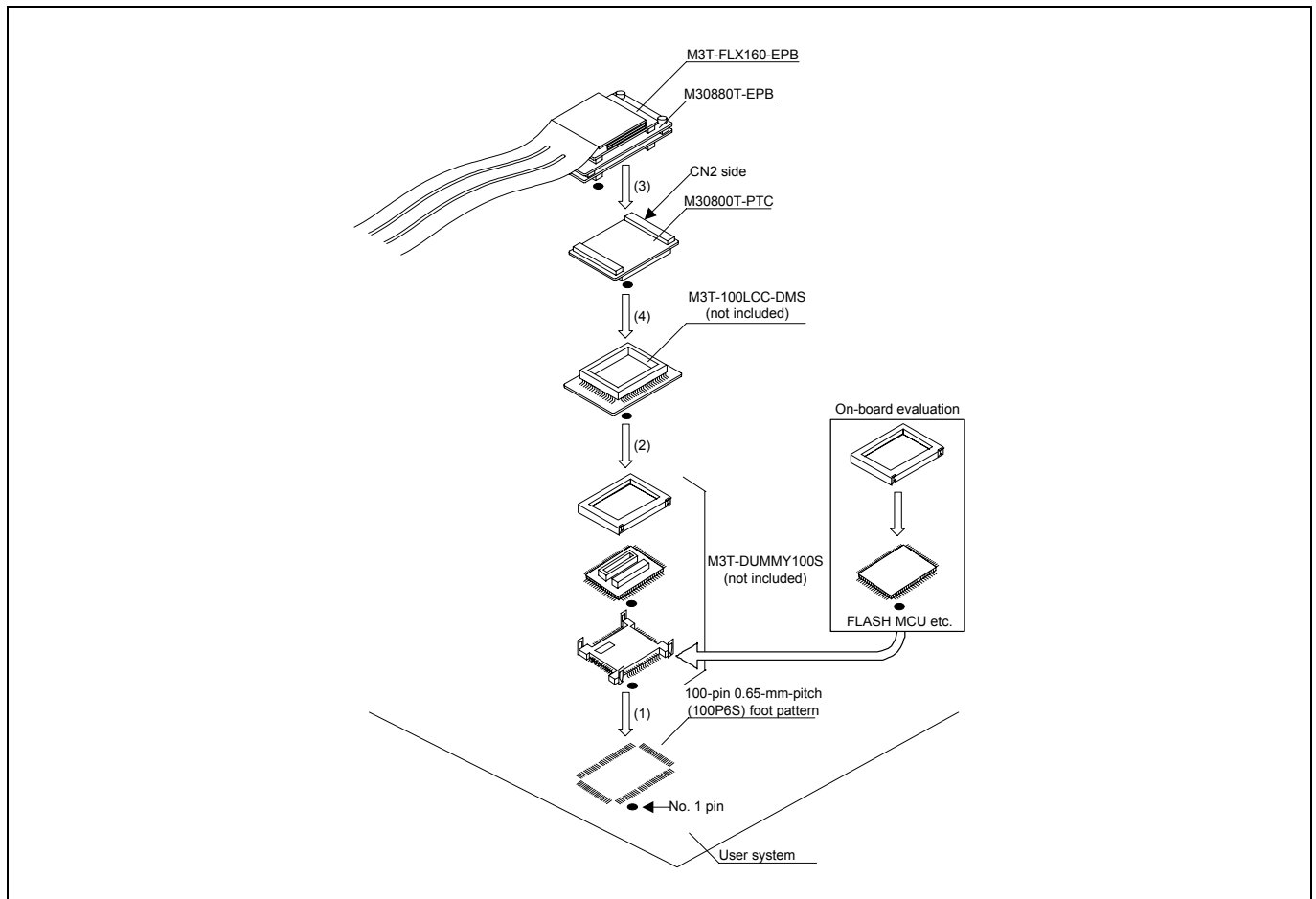

Figure 2.9 Connecting to a 100-pin 0.65-mm-pitch foot pattern (1/3)

## CAUTION

### Notes on Connecting the User System:



- Take care not to attach the converter board in a wrong direction. It may cause a fatal damage to the emulator.
- The small connectors of the M3T-100LCC-DMS and M3T-DUMMY100S are guaranteed for only 20 insertion/removal iterations.
- The small connectors of the M30880T-EPB and M30800T-PTC are guaranteed for only 50 insertion/removal iterations.

### 2.9.3 Connecting to a 100-pin 0.65-mm-pitch Foot Pattern (Part 2)

Figure 2.10 shows how to connect the emulation probe to a 100-pin 0.65-mm-pitch foot pattern on the user system with the M3T-DIRECT100S (not included), and here following is its procedure. For details on the M3T-100LCC-DMS and M3T-DIRECT100S, refer to each user's manual.

- (1) Attach the M3T-DIRECT100S to the user system.
- (2) Attach the M3T-100LCC-DMS to the M3T-DIRECT100S.
- (3) Attach the M30800T-PTC to the M30880T-EPB.
- (4) Attach the M30800T-PTC to the M3T-100LCC-DMS.

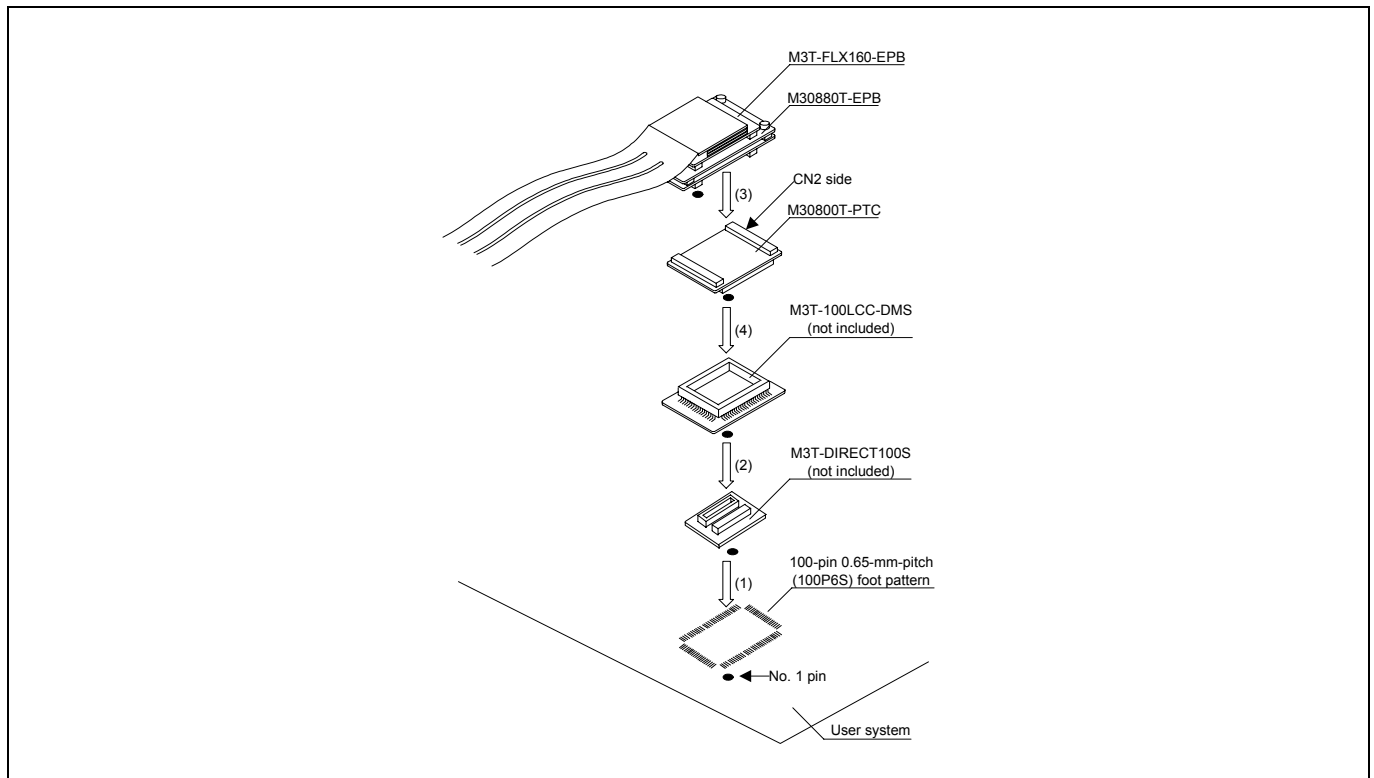

Figure 2.10 Connecting to a 100-pin 0.65-mm-pitch foot pattern (2/3)

## CAUTION

### Notes on Connecting the User System:



- Take care not to attach the converter board in a wrong direction. It may cause a fatal damage to the emulator.
- The small connectors of the M3T-100LCC-DMS and M3T-DIRECT100S are guaranteed for only 20 insertion/removal iterations.
- The small connectors of the M30880T-EPB and M30800T-PTC are guaranteed for only 50 insertion/removal iterations.



### 2.9.4 Connecting to a 100-pin 0.65-mm-pitch Foot Pattern (Part 3)

Figure 2.11 shows how to connect the emulation probe to a 100-pin 0.65-mm-pitch foot pattern on the user system with the M3T-FLX-100NRB (not included), and here following is its procedure. For details on the M3T-100LCC-DMS and M3T-FLX-100NRB, refer to each user's manual.

- (1) Attach the M3T-FLX-100NRB to the user system.
- (2) Attach the M3T-100LCC-DMS to the M3T-FLX-100NRB.
- (3) Attach the M30800T-PTC to the M30880T-EPB.
- (4) Attach the M30800T-PTC to the M3T-100LCC-DMS.

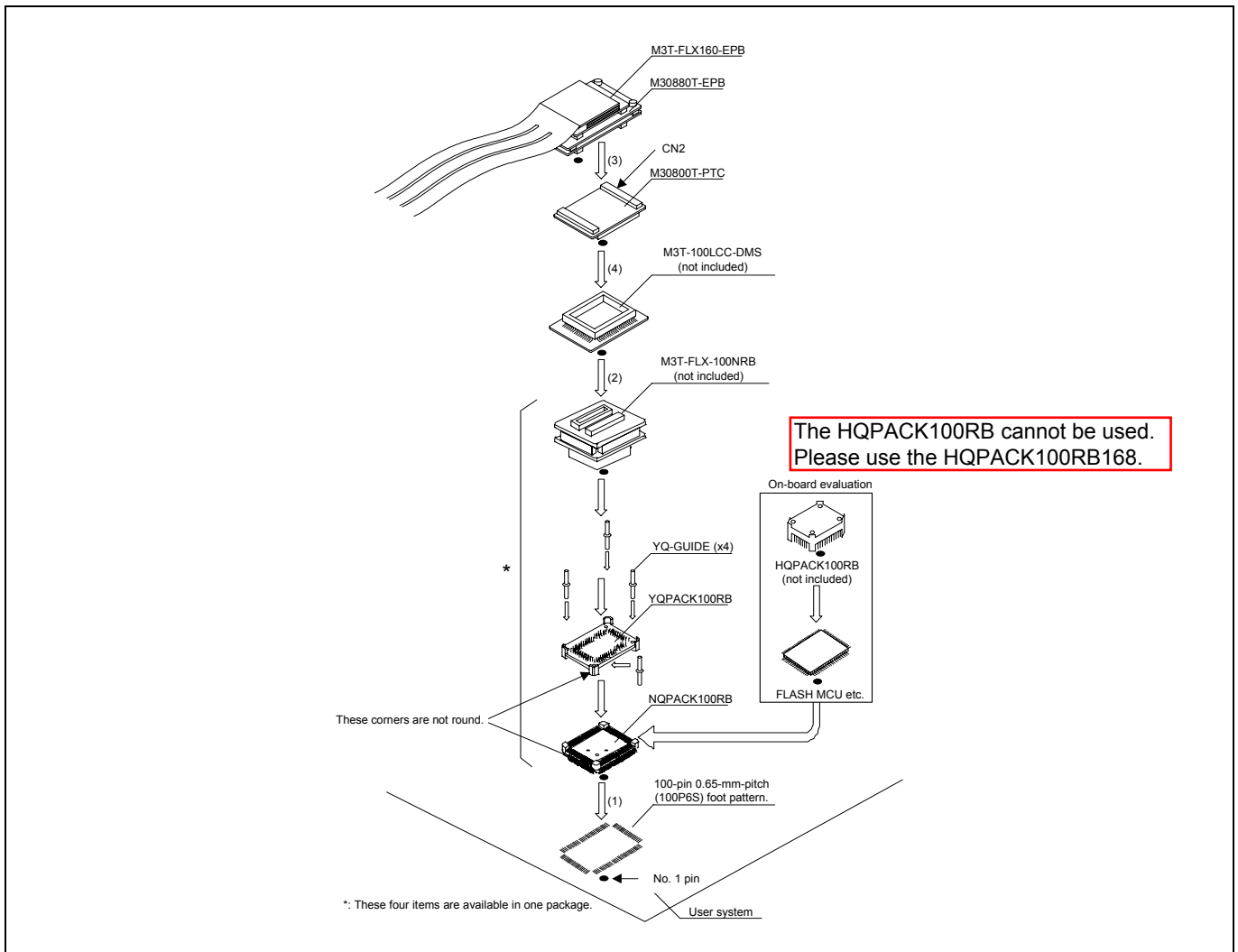

Figure 2.11 Connecting to a 100-pin 0.65-mm-pitch foot pattern (3/3)

## CAUTION

### Notes on Connecting the User System:



- Take care not to attach the converter board in a wrong direction. It may cause a fatal damage to the emulator.
- The small connectors of the M3T-100LCC-DMS and M3T-FLX-100NRB are guaranteed for only 20 insertion/removal iterations.
- The small connectors of the M30880T-EPB and M30800T-PTC are guaranteed for only 50 insertion/removal iterations.

\* NQPACK, YQPACK, YQSOCKET, YQ-GUIDE, HQPACK, TQPACK and TQSOCKET are trademarks of Tokyo Eletech Corporation.

### 2.9.5 Connecting to a 100-pin 0.5-mm-pitch Foot Pattern (Part 1)

Figure 2.12 shows how to connect the emulation probe to a 100-pin 0.5-mm-pitch foot pattern on the user system with the M3T-100LCC-QSD (not included), and here following is its procedure. For details on the M3T-100LCC-QSD, refer to its user's manual.

- (1) Attach the M3T-100LCC-QSD to the user system.
- (2) Attach the M30800T-PTC to the M30880T-EPB.
- (3) Attach the M30800T-PTC to the M3T-100LCC-QSD.

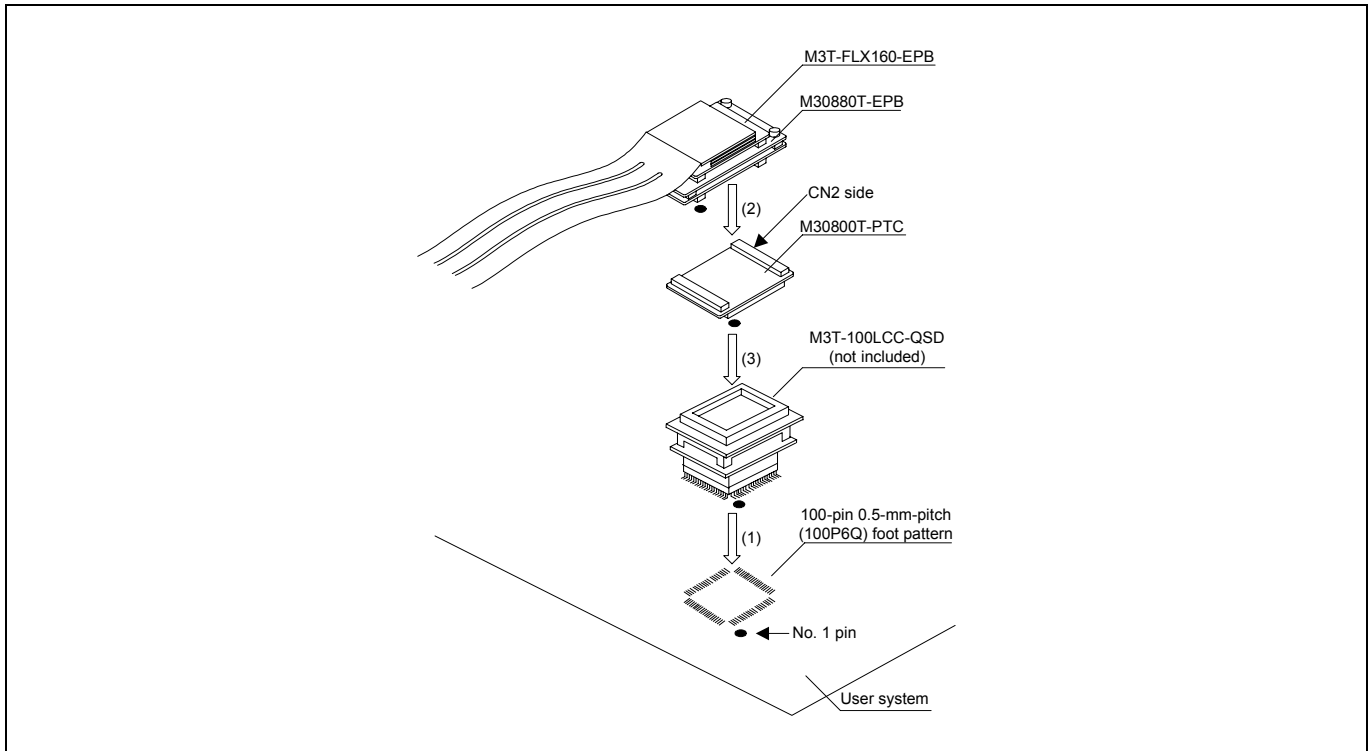

Figure 2.12 Connecting to a 100-pin 0.5-mm-pitch foot pattern (1/3)

## CAUTION

### Notes on Connecting the User System:



- Take care not to attach the converter board in a wrong direction. It may cause a fatal damage to the emulator.
- The small connectors of the M30880T-EPB and M30800T-PTC are guaranteed for only 50 insertion/removal iterations.

2.9.6 Connecting to a 100-pin 0.5-mm-pitch Foot Pattern (Part 2)

Figure 2.13 shows how to connect the emulation probe to a 100-pin 0.5-mm-pitch foot pattern on the user system with the M3T-FLX-100NSD (not included), and here following is its procedure. For details on the M3T-100LCC-DMS and M3T-FLX-100NSD, refer to each user's manual.

- (1) Attach the M3T-FLX-100NSD to the user system.
- (2) Attach the M3T-100LCC-DMS to the M3T-FLX-100NSD.
- (3) Attach the M30800T-PTC to the M30880T-EPB.
- (4) Attach the M30800T-PTC to the M3T-100LCC-DMS.

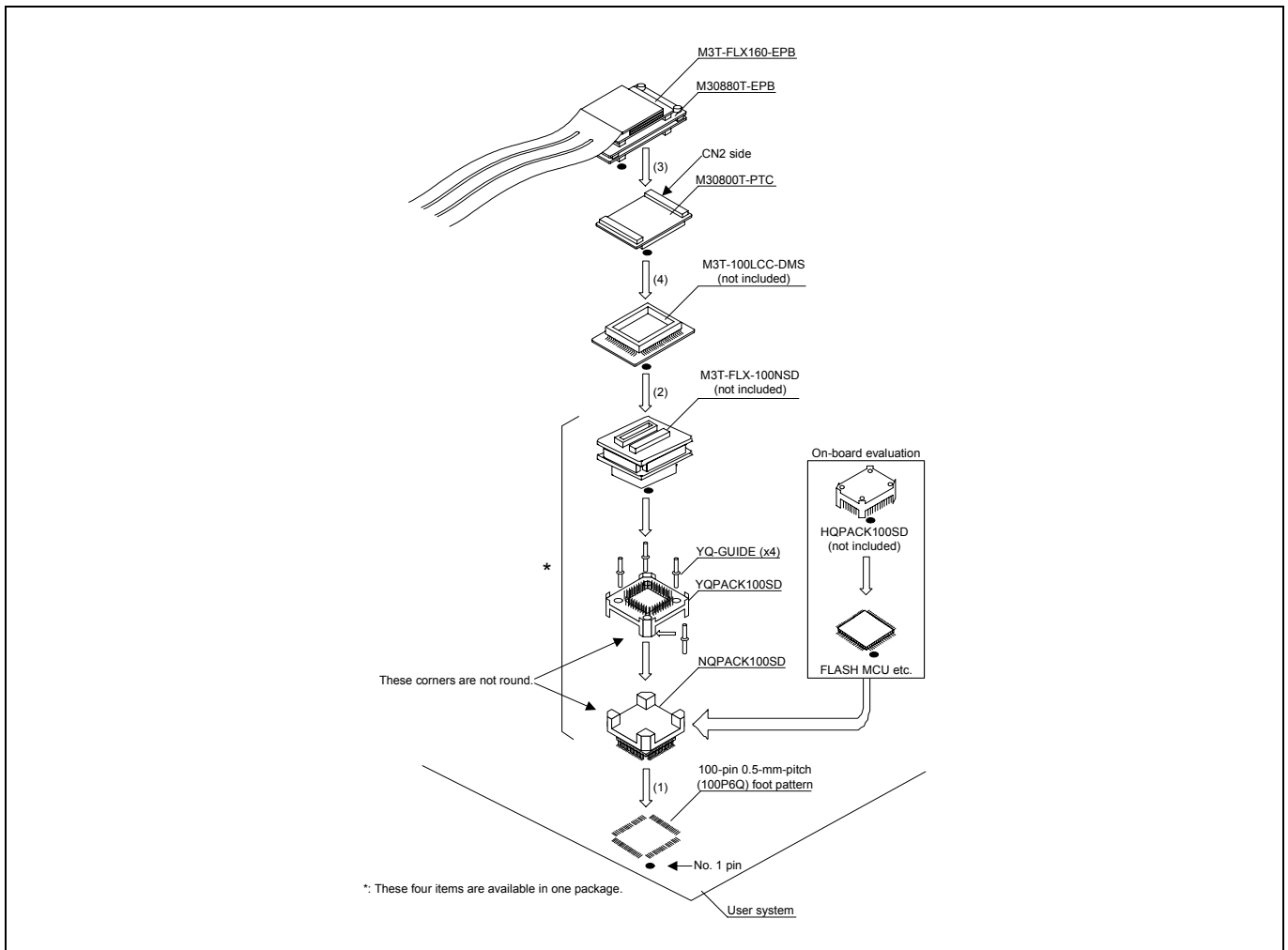

Figure 2.13 Connecting to a 100-pin 0.5-mm-pitch foot pattern (2/3)

**CAUTION**

Notes on Connecting the User System:



- Take care not to attach the converter board in a wrong direction. It may cause a fatal damage to the emulator.
- The small connectors of the M3T-100LCC-DMS and M3T-FLX-100NSD are guaranteed for only 20 insertion/removal iterations.
- The small connectors of the M30880T-EPB and M30800T-PTC are guaranteed for only 50 insertion/removal iterations.

2.9.7 Connecting to a 100-pin 0.5-mm-pitch Foot Pattern (Part 3)

Figure 2.14 shows how to connect the emulation probe to a 100-pin 0.5-mm-pitch foot pattern on the user system with the M3T-F160-100NSD (not included), and here following is its procedure. For details on the M3T-F160-100NSD, refer to its user's manual.

- (1) Mount the NQPACK100SD included with the M3T-F160-100NSD to the user system.
- (2) Attach the YQPACK100SD included with the M3T-F160-100NSD to the NQPACK100SD.
- (3) Insert the YQ-GUIDE's included with the YQPACK100SD to the YQPACK100SD.
- (4) Attach the M3T-F160-100NSD to the YQPACK100SD.
- (5) Attach the M30880T-EPB to the M3T-F160-100NSD.

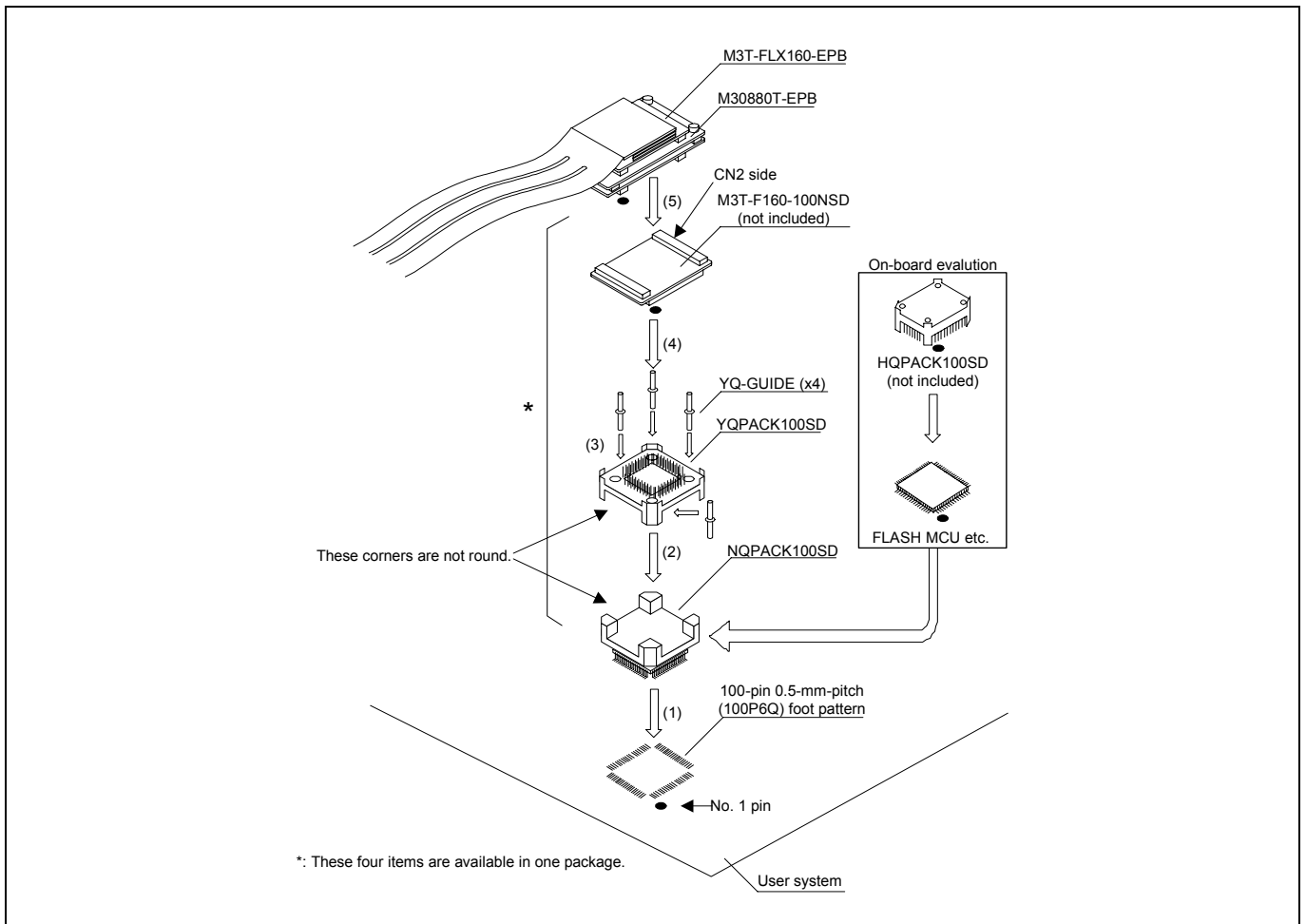

Figure 2.14 Connecting to a 100-pin 0.5-mm-pitch foot pattern (3/3)

**CAUTION**

Notes on Connecting the User System:



- Take care not to attach the converter board in a wrong direction. It may cause a fatal damage to the emulator.
- The small connectors of the M30880T-EPB and M3T-F160-100NSD are guaranteed for only 50 insertion/removal iterations.

2.9.8 Connecting to a 144-pin 0.5-mm-pitch Foot Pattern

Figure 2.15 shows how to connect the emulation probe to a 144-pin 0.5-mm-pitch foot pattern on the user system with the M3T-FLX-144NSD (not included), and here following is its procedure. For details on the M3T-FLX-144NSD, refer to its user's manual.

- (1) Attach the NQPACK144SD included with the M3T-FLX-144NSD to the user system.
- (2) Attach the YQPACK144SD included with the M3T-FLX-144NSD to the NQPACK144SD.
- (3) Insert the YQ-GUIDE's included with the YQPACK144SD to the YQPACK144SD.
- (4) Attach the M3T-FLX-144NSD to the YQPACK144SD.
- (5) Attach the M30880T-EPB to the M3T-FLX-144NSD.

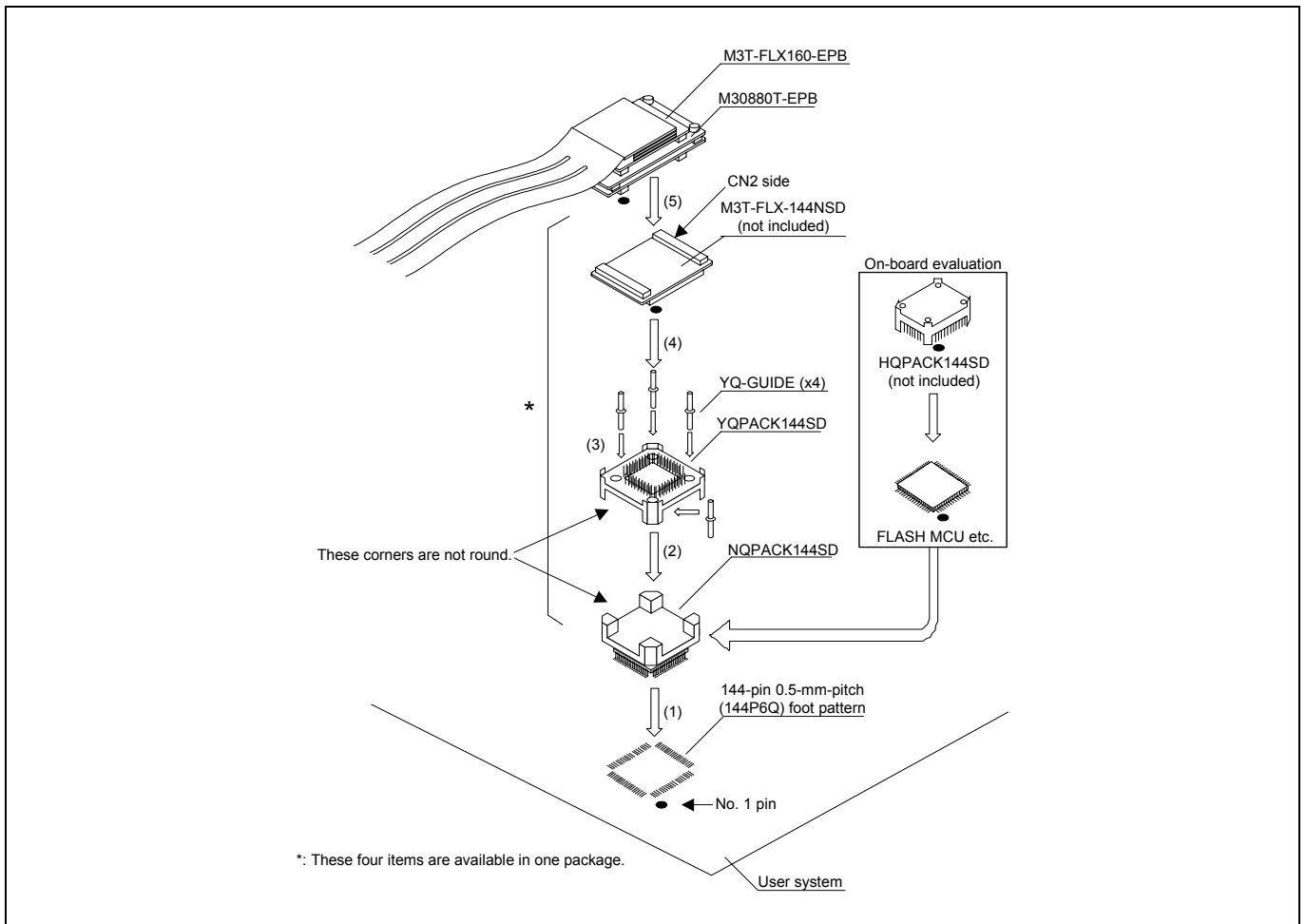

Figure 2.15 Connecting to a 144-pin 0.5-mm-pitch foot pattern

**CAUTION**

Notes on Connecting the User System:



- Take care not to attach the converter board in a wrong direction. It may cause a fatal damage to the emulator.
- The small connectors of the M30880T-EPB and M3T-FLX-144NSD are guaranteed for only 50 insertion/removal iterations.

## 2.10 Setting Switches

### 2.10.1 Setting Switches of Emulation Probe

Set the switches of the emulation probe according to the condition. Figure 2.16 shows the positions of the switches of the M30880T-EPBM.

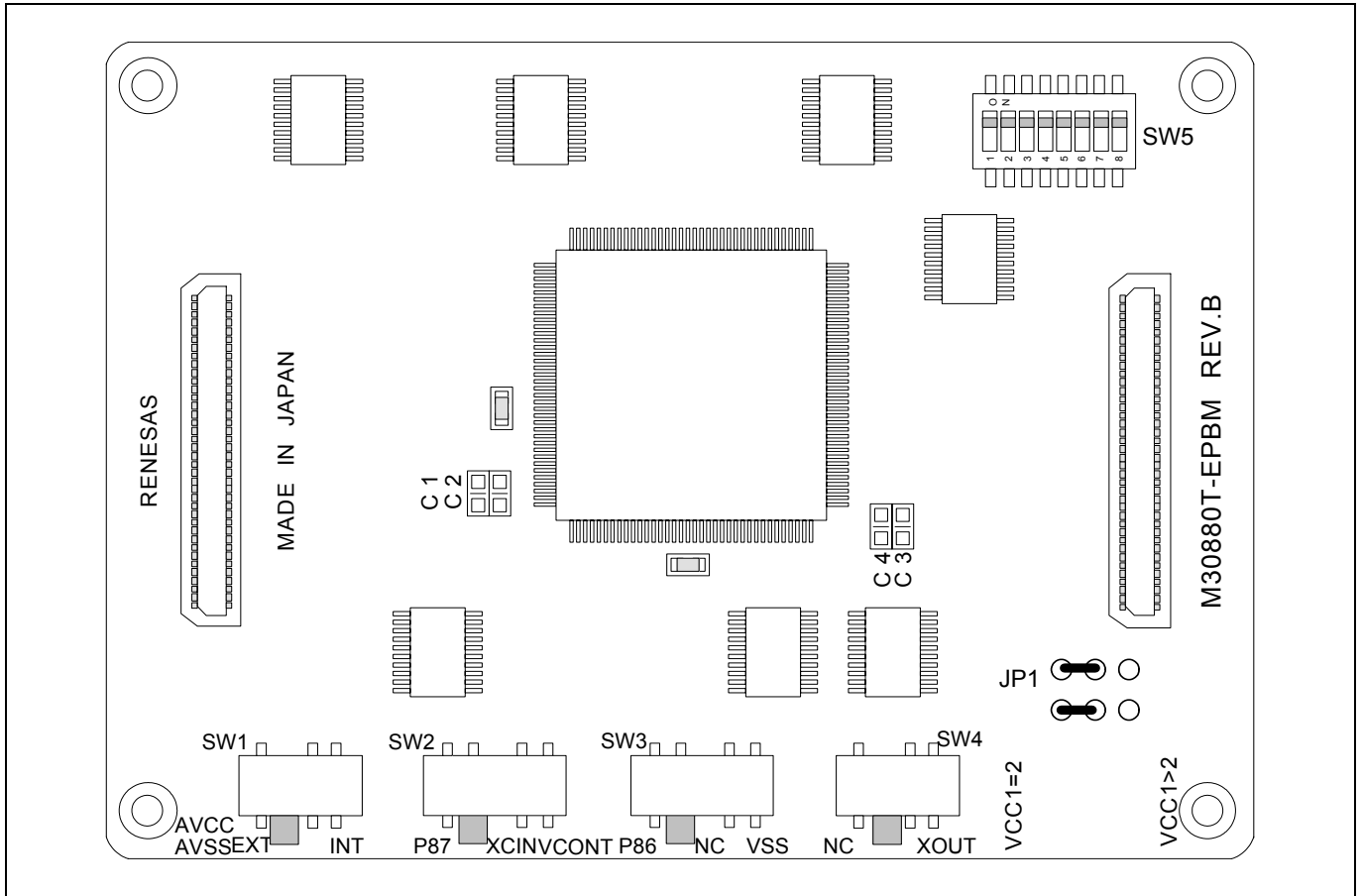
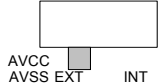

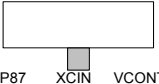
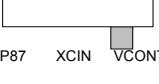
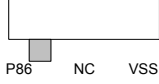
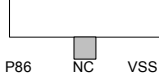
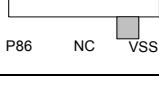
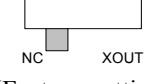
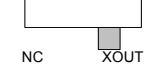

Figure 2.16 Positions of the switches

(1) Setting SW1 to SW4 on the M30880T-EPBM

Table 2.2 shows the settings of SW1 to SW4 on the M30880T-EPBM.

Table 2.2 Switch settings of the M30880T-EPBM (SW1 to SW4)

Switch	Switch name	Setting	Description
SW1	AVCC AVSS	 <p>(Factory-setting)</p>	Connects pins AVCC and AVSS of the MCU to the user system.
			Connects pin AVCC of the MCU to the internal power supply of the emulator, and connects pin AVSS to the GND in the emulator.
SW2	P87	 <p>(Factory-setting)</p>	Connects pin P87 of the MCU to the user system.
			Connects pin P87 of the MCU to the sub-clock oscillator circuit (32.768 kHz).
			Do not set to VCONT. Pin P87 is disconnected.
SW3	P86	 <p>(Factory-setting)</p>	Connects pin P86 of the MCU to the user system.
			Does not connect pin P86 of the MCU.
			Do not set to VSS. Connects pin P86 of the MCU to the VSS in the emulation probe.
SW4	XOUT	 <p>(Factory-setting)</p>	Does not connect pin XOUT of the MCU.
			Connects pin XOUT of the MCU to the user system.

(2) Setting SW5 on the M30880T-EPBM

Table 2.3 lists the examples of setting the switch SW5. It is necessary to change the setting if using the analog input port selection function of the A/D converter.

Setting the SW5 enables to set each analog input pin for selecting an analog input port. When selecting AN00 to AN07 or AN20 to AN27 for the analog input port select bits (bit 2 and bit 1 of 0394h), set the pins used for A/D conversion to ON, the pins not used to OFF.

Table 2.3 Switch settings of the M30880T-EPBM (SW5)

Analog input port	Setting	Description
When not using the analog input port selection function		<p>This is the setting when not using the analog input port selection function. When using this product with the conditions below, use this setting.</p> <ul style="list-style-type: none"> <li>- When using the multi-port sweep mode</li> <li>- When selecting AN0 to AN7 for analog input port select bits</li> <li>- When selecting AN150 to AN157 for analog input port select bits</li> </ul>
When using AN23 to AN27		<p>This is a setting when using the analog input port selection function and using AN23 to AN27 for analog input pins. Set the analog input pins to ON. With this setting, set the direction registers of ports P153 to P157 to input. Pins P150 to P152 can be used for I/O port, ISTxD0, ISCLK0 and ISRxD0.</p>
When using AN20 to AN27		<p>This is a setting when using the analog input port selection function and using AN20 to AN27 for analog input pins. Set the analog input pins to ON. With this setting, set the direction registers of ports P150 to P157 to input. <b>Pins P150 to P157 cannot be used for I/O port, ISTxD0, ISCLK0 and ISRxD0.</b></p>
When using AN04 to AN07		<p>This is a setting when using the analog input port selection function and using AN04 to AN07 for analog input pins. Set the analog input pins to ON. With this setting, set the direction registers of ports P154 to P157 to input. Pins P150 to P153 can be used for I/O port, ISTxD0, ISCLK0 and ISRxD0.</p>
When using AN03 to AN05 and AN25 to AN27		<p>This is a setting when using the analog input port selection function and using AN03 to AN05 and AN25 to AN27 for analog input pins. Set the analog input pins to ON. With this setting, set the direction registers of ports P153 to P157 to input. Pins P150 to P152 can be used for I/O port, ISTxD0, ISCLK0 and ISRxD0.</p>



## IMPORTANT

### Notes on Switch SW5:

- When setting the register below to use the analog input port selection function, you need to set the direction register of port P15 for a pin that performs A/D conversion to "input".

And you need to set the function selection register of port P15 for a pin that performs A/D conversion to "I/O port".

A/D0 control register 2 (address 394h)

b2, b1

1, 0 : AN00 to AN07

1, 1 : AN20 to AN27

Also, when the P0 group and P2 group are selected for A/D input, port P15 cannot be used as an I/O port. When setting the register above, port P15 cannot be used as an I/O port even if A/D conversion is halting.

- When using the A/D converter in multi-port sweep mode, be sure to set the all SW5 to ON. When setting the register below to use multi-port sweep mode, you need to set the direction register of port P15 for a pin that performs A/D conversion to "input".

And you need to set the function selection register of port P15 for a pin that performs A/D conversion to "I/O port".

A/D0 control register 4 (address 392h)

b3, b2

1, 0 : AN0 to AN7, AN00 to AN07

1, 1 : AN0 to AN7, AN20 to AN27

Also, when the P0 group and P2 group are used for multi-port sweep mode, port P15 cannot be used as an I/O port. When setting the register above, port P15 cannot be used as an I/O port even if A/D conversion is halting.

Because a converter board and other devices are used between the evaluation MCU and the user system, the A/D converter operates differently from an actual MCU. Make the final evaluation of the A/D converter using an actual MCU.

### 2.10.2 Selecting Clock Supply

With this product, a clock supply can be set in Init dialog box of Emulator tab of the emulator debugger. Table 2.4 lists the factory-settings of each clock supply.

Table 2.4 Clock supply to the MCU and default settings

Clock	Display of emulator debugger	Description	Default setting
Main $X_{IN}$ - $X_{OUT}$	Internal	Internal oscillator circuit (OSC-3 or OSC-2)	Yes
	External	Oscillator of user system	-
	Generated	Internal generator circuit (1.0 to 32.0 MHz)	-
Sub $X_{CIN}$ - $X_{COUT}$	Internal	Internal oscillator circuit (32.768 kHz)	-
	External	Oscillator of user system	Yes

## IMPORTANT

### Notes on Changing the Clock Supply:

- The clock supply can be set by the Init dialog box when starting up the emulator debugger or inputting CLK command on the script window.
- For  $X_{CIN}$ - $X_{COUT}$ , it is necessary to set switches in the emulator. For details, refer to "2.10.1 Setting Switches of Emulation Probe" (page 38).

### (1) Using an Internal Oscillator Circuit Board

#### 1) Kinds of Oscillator Circuit Boards

The PC7501 comes with an oscillator circuit board OSC-3 (30 MHz). And an oscillator circuit board OSC-3 (32 MHz) and an oscillator circuit board OSC-2 (bare board) are included with this product. If you use the internal oscillator circuit board OSC-3 (32 MHz) or OSC-2 of the PC7501 as a main clock, choose "Internal" in the emulator debugger after replacing oscillator circuit boards to change a clock supplied to an MCU.

## 2) Replacing an Oscillator Circuit Board

Remove the four screws of both sides of this product and lift off the upper cover (see Figure 2.17).

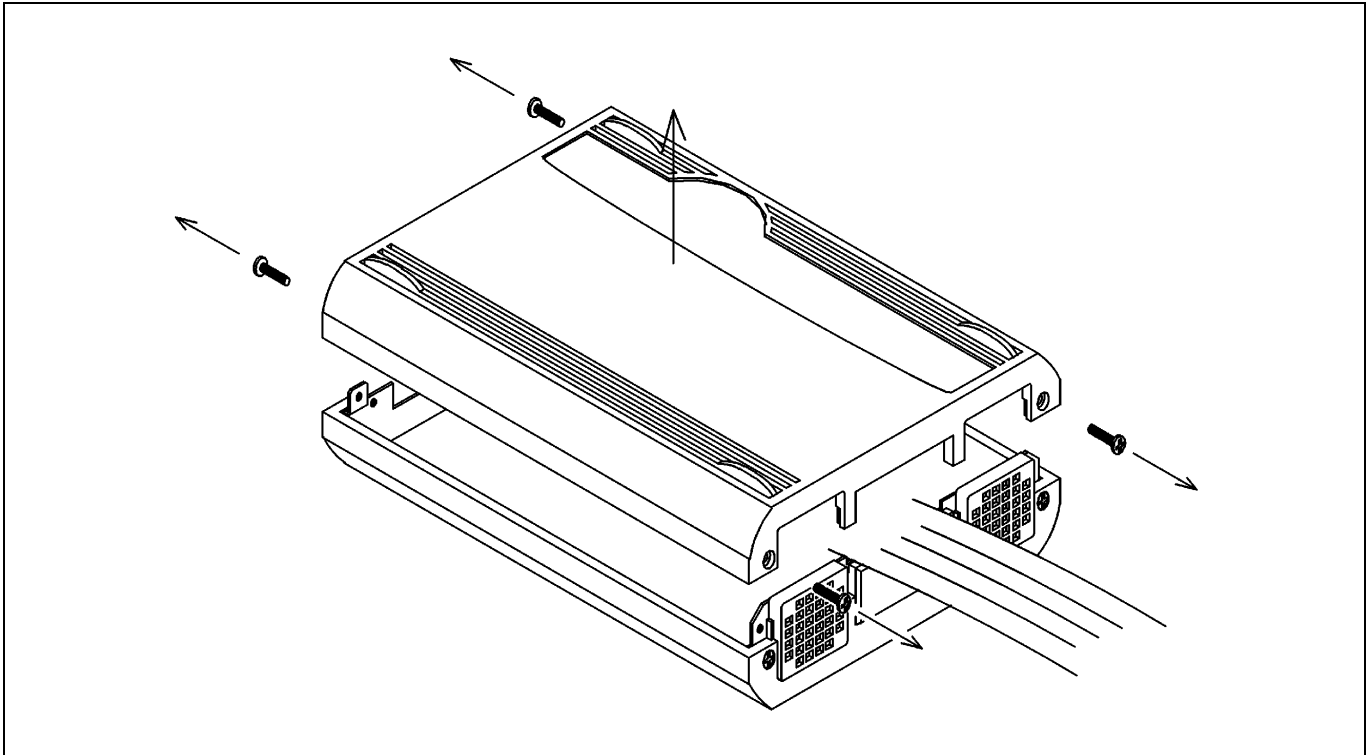

Figure 2.17 Removing the upper cover

Unscrew the screw of the oscillator circuit board of the PC7501 and replace it (see Figure 2.18).

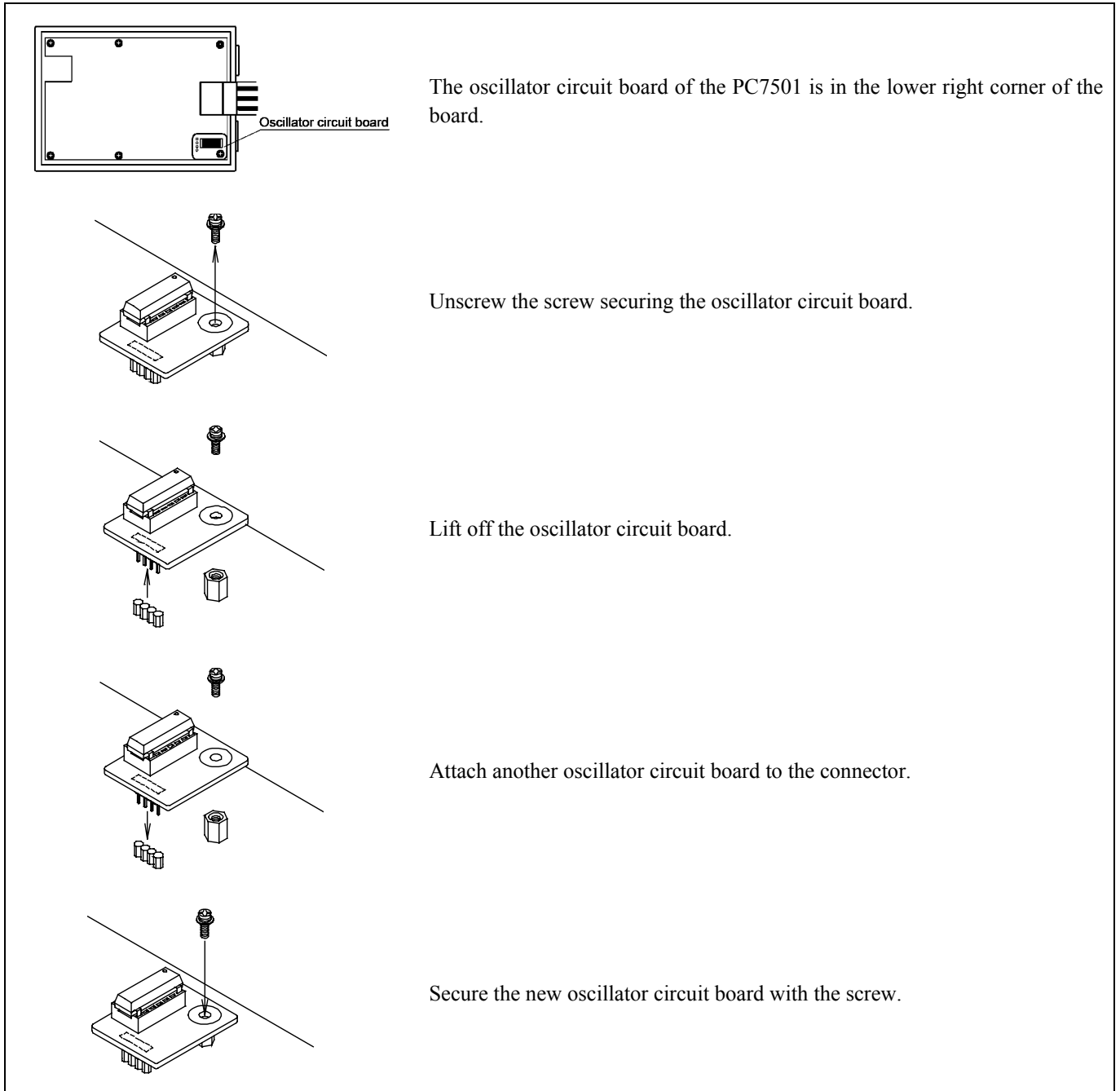

Figure 2.18 Replacing oscillator circuit boards

Reinstall the upper cover once removed and secure the four screws of the PC7501.

**CAUTION**

When Removing the Upper Cover:



- Always shut OFF power when removing the upper cover or changing the oscillator circuit board. Otherwise the internal circuit may be damaged.

3) Using the Oscillator Circuit Bare Board

To use this product at a frequency you like, build a desired oscillator circuit on the included OSC-2 oscillator circuit bare board. Figure 2.19 shows an external view of the OSC-2 oscillator circuit bare board and the connector pin locations. Figure 2.20 shows the circuitry of the oscillator circuit bare board OSC-2. Use the number of oscillator circuits recommended by the oscillator manufacturer.

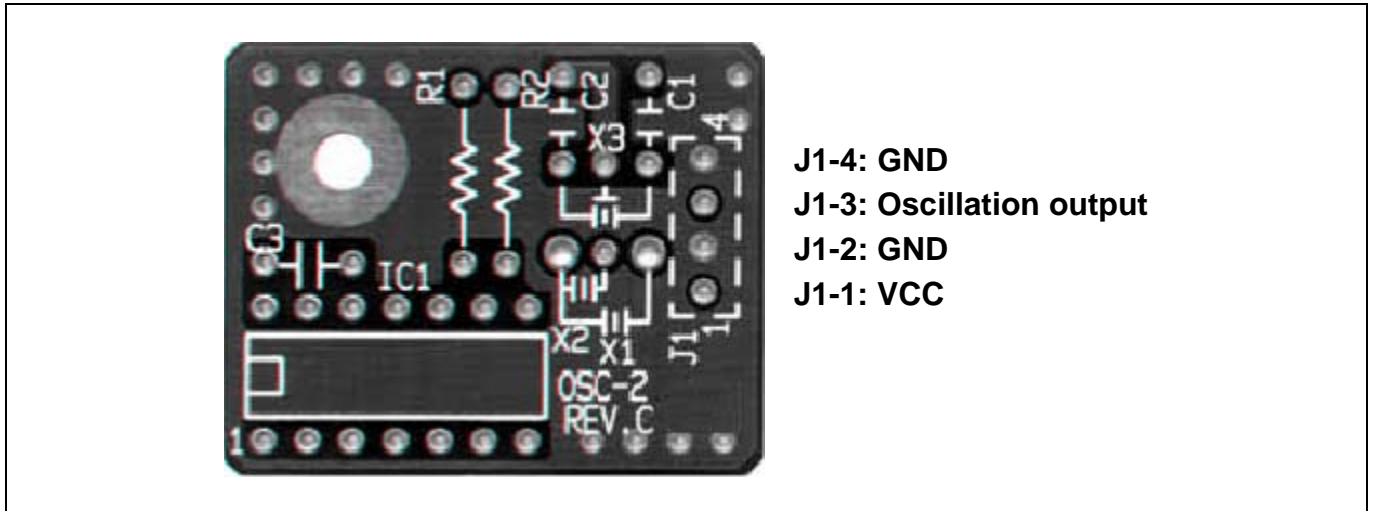

Figure 2.19 External view of the oscillator board OSC-2 (bare board) and connector pin assignments

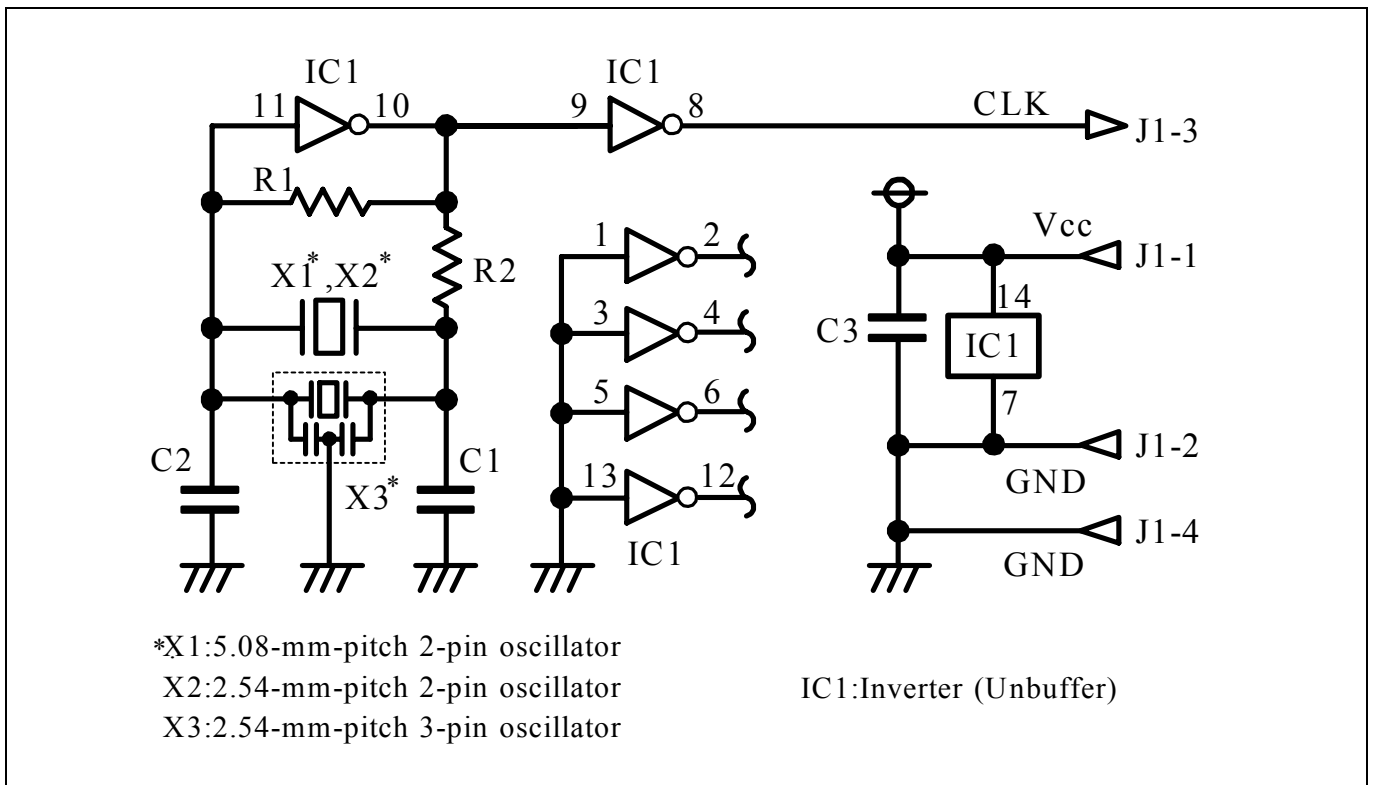

Figure 2.20 Circuit of the oscillator board OSC-2 (bare board)

### (2) Using the Oscillator Circuit on the User System

To operate this product with an oscillator circuit of the user system, input the oscillator output at 50% duty (within the operating range of the evaluation MCU) into pin  $X_{IN}$  as shown in Figure 2.21. Pin  $X_{OUT}$  should be open. Choose "External" in the emulator debugger to use this clock.

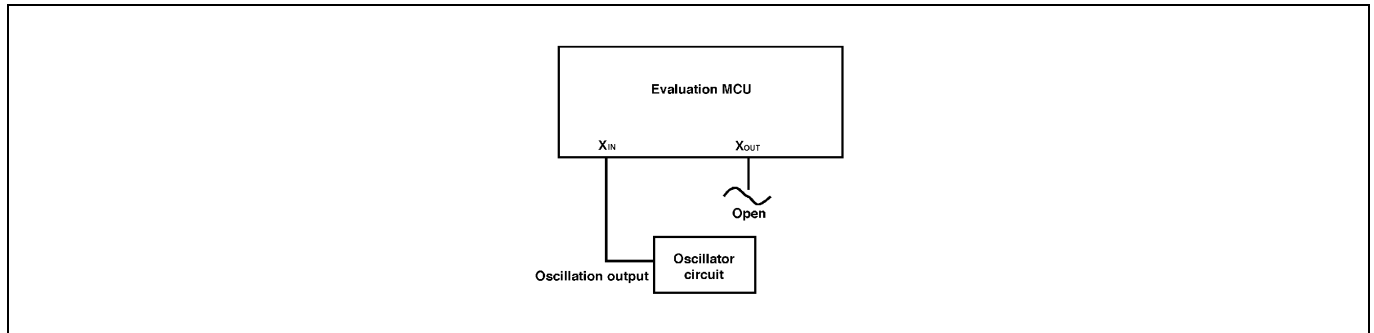

Figure 2.21 External oscillator circuit

In the oscillator circuit shown in Figure 2.22 where a resonator is connected between pins  $X_{IN}$  and  $X_{OUT}$ , oscillation does not occur because a converter board is used between the evaluation MCU and the user system. It is same for  $X_{CIN}$  and  $X_{COUT}$ .

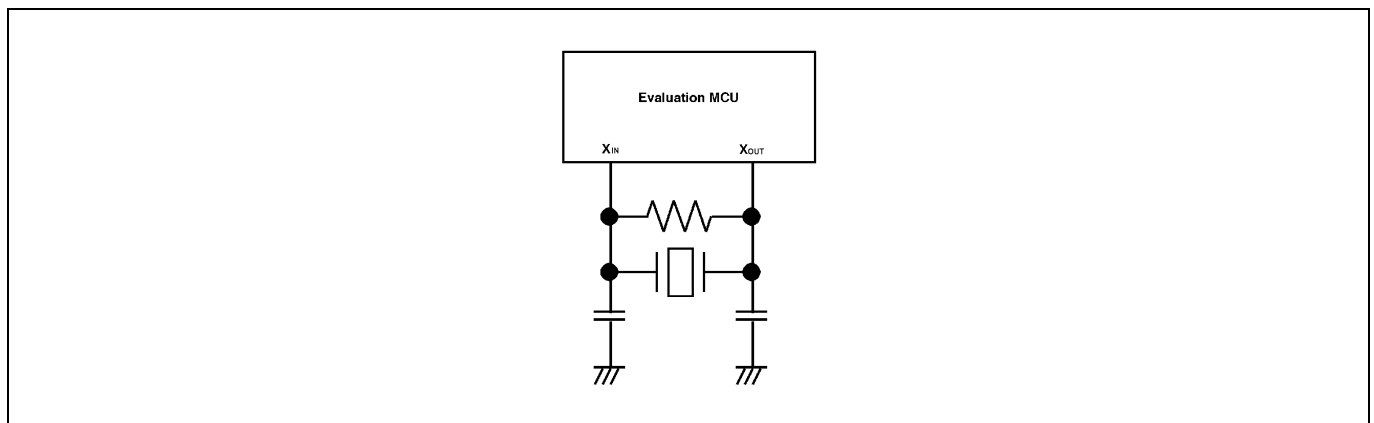

Figure 2.22 Circuit in which oscillation does not occur

### (3) Using the Internal Oscillator Circuit

The dedicated circuit in the PC7501 can generate any arbitrary frequency specified by the emulator debugger, and it is supplied as a main clock. It does not depend on either the oscillator circuit board in the PC7501 or the oscillator circuit on the user system. If you want to debug programs without the user system or change a frequency temporarily, you can check its operation before preparing an oscillator. If you want to use the internal oscillator circuit of the PC7501 as a main clock, choose "Generated" in the emulator debugger and specify a frequency you like to use for this clock supplied to an MCU.

Although you can change a frequency between 1.0 and 99.9 MHz by 0.1 MHz for the PC7501, do not specify a value exceeding the maximum input frequency of the  $X_{IN}$  of the MCU.

## IMPORTANT

### Notes on Internal Oscillator Circuit:

- The internal generator circuit is equipped for temporary debugging purposes. Temperature characteristics of frequencies are not guaranteed.
- Be sure to evaluate your system with an oscillator or oscillator module whose frequency is same as that of the internal oscillator circuit (internal clock) for final evaluation purposes.

2.10.3 A/D Conversion Bypass Capacitors

There is a foot pattern on the M30880T-EPBM board for mounting bypass capacitors for the A/D conversion circuit. Mount applicable bypass capacitors as occasion demands. Figure 2.23 shows where they are installed.

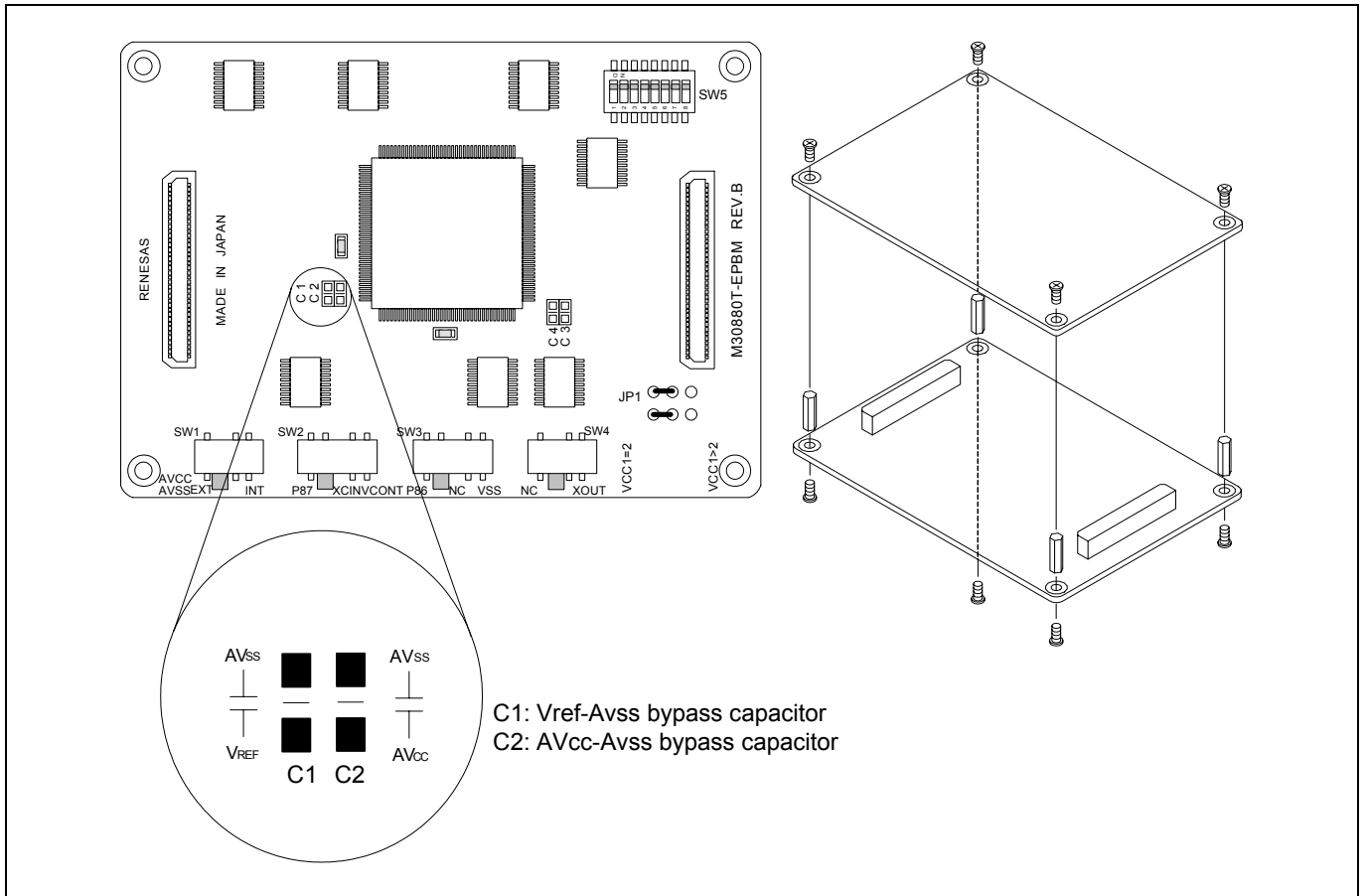

Figure 2.23 Foot pattern for the A/D conversion bypass capacitor

**IMPORTANT**

Note on the A/D Converter:

- Because a converter board and other devices are used between the evaluation MCU and the user system, the A/D converter operates differently from an actual MCU. Make the final evaluation of the A/D converter using an actual MCU.

### 3. Usage (Emulator Debugger)

This chapter describes how to start up the emulator debugger and how to use the major windows.

#### 3.1 Starting Up the Emulator Debugger (Init Dialog Box)

To launch the emulator debugger, click the Start menu of Windows and then select

Program (P) >> [RENESAS-TOOLS] >> [PD308F V.xx.xx Release x] >> [PD308F].

When the emulator debugger started up, the Init dialog box appears.

##### (1) MCU tab

##### 1. Specifying the MCU file

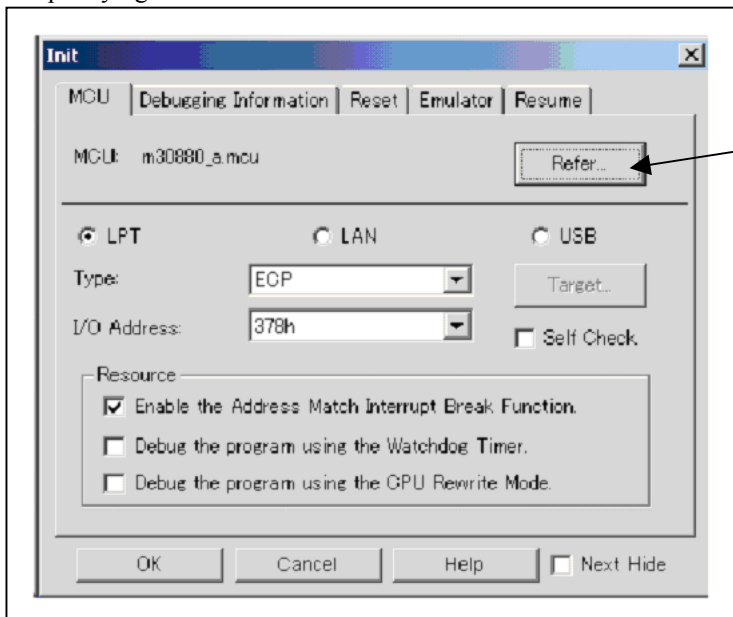

**Specifying the MCU file**

Click the “Refer...” button.

A file selection dialog box will be displayed, so select the desired MCU file. The MCU file is stored in the directory in which you installed the M3T-PD308F.

(Example: c:\mtool\PD308F\mcufiles)

- The MCU file contains the information specific to the target MCU.
- The MCU file you have selected is displayed in the MCU section of the MCU tab.

##### 2. Specifying the communication interface (LPT communication)

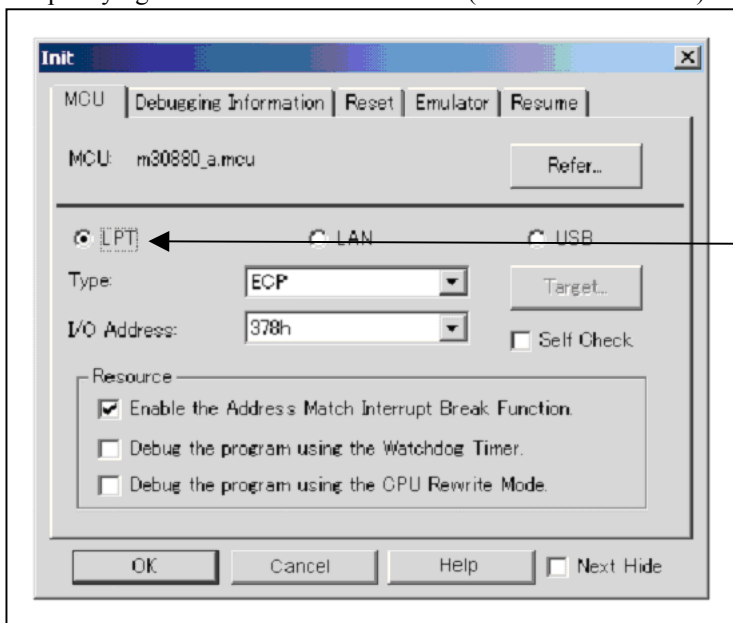

**Specifying the communication interface (LPT communication)**

For selecting the LPT communication, click the radio button “LPT” of the MCU tab. Specify the using LPT communication mode at the Type area. Specify the I/O address of the parallel port at the I/O address area. For BIOS setup, the following addresses are available.

- 378h
- 278h



3. Specifying the communication interface (LAN communication)

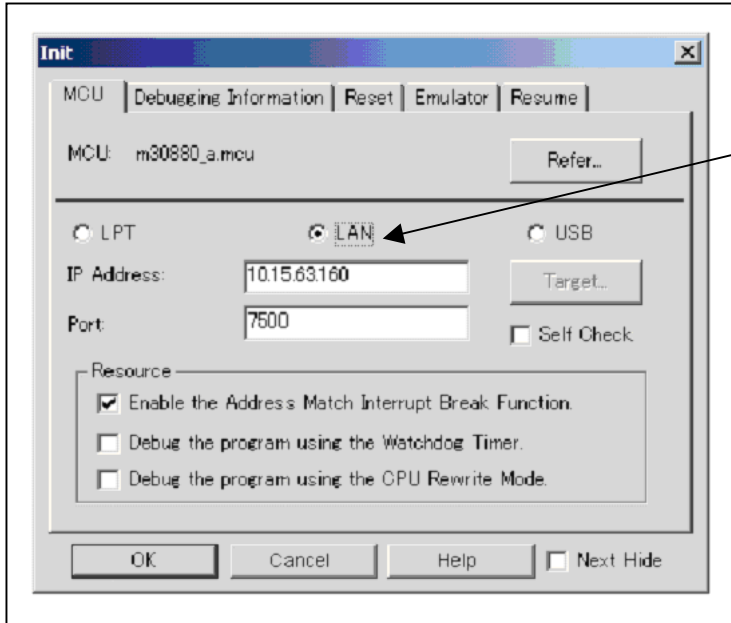

**Specifying the communication interface (LAN communication)**  
For selecting the LAN communication, click the radio button "LAN" of the MCU tab. Specify the IP address of the emulator at the IP address area. Specify the IP address by one byte of decimal number separating each four bytes with a period. Specify the port number at the Port area.

4. Specifying the communication interface (USB communication)

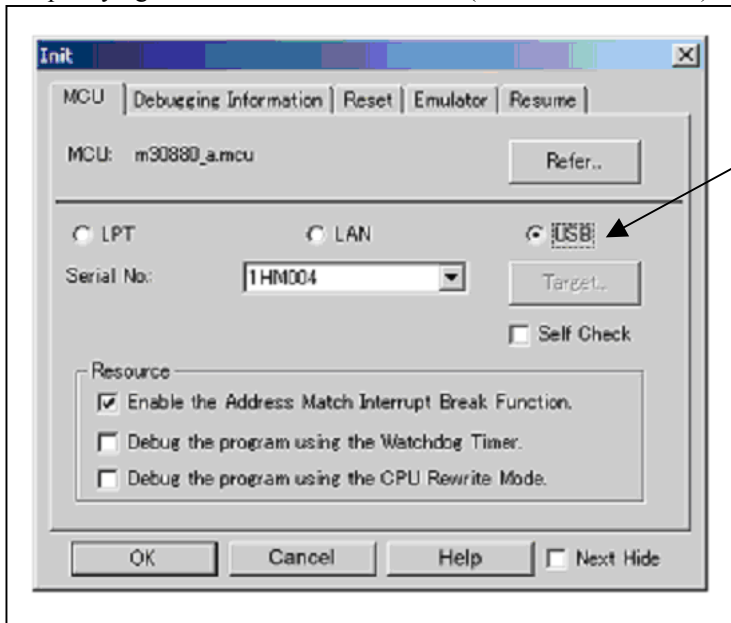

**Specifying the communication interface (USB communication)**  
For selecting the USB communication, click the radio button "USB" of the MCU tab. The emulators connected by USB cable are shown at Serial No. area. Select the serial No. of the emulator you are going to connect.

5. Using or not using the address match break function

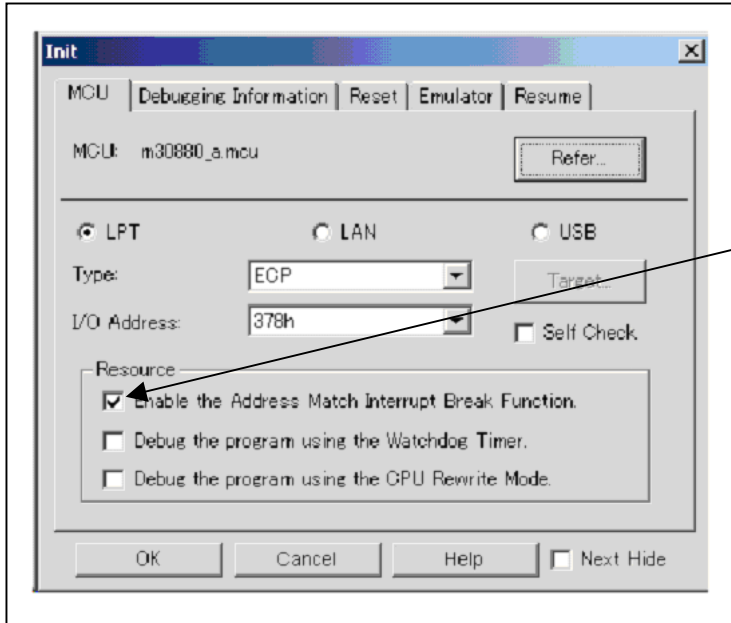

**Using or not using the address match break function**

Specify whether or not to use the address match break function.

- To use the address match break function (default), select the check box (marked by a check mark when selected). In this case, the address match interrupt is used by the emulator, and cannot be used in the user program.
- When not using the address match break function, deselect the check box (check mark cleared). In this case, the address match interrupt can be used in the user program.

This option can be selected or deselected only when you are starting up the emulator debugger.

6. Using or not using the watchdog function

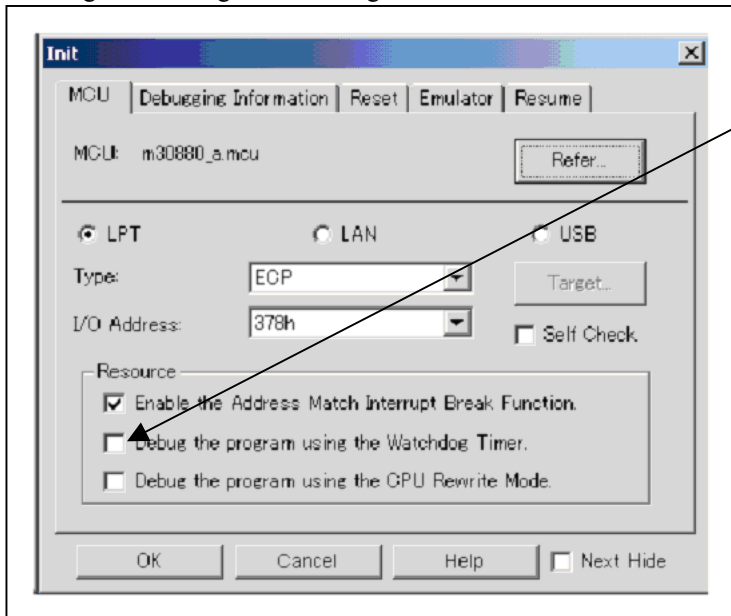

**Using or not using the watchdog function**

Specify whether or not to debug the program which uses the watchdog function. When debugging the user system which uses the watchdog function, select the check box.

## 7. Using or not using the CPU rewrite mode

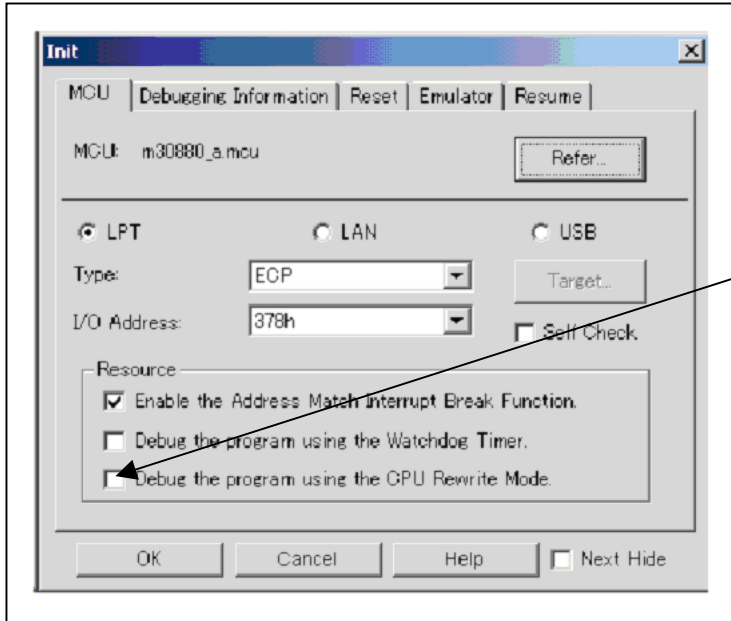
Using or not using CPU rewrite mode

Specify whether or not to debug in CPU rewrite mode. To debug the user system that uses CPU rewrite mode, select the check box. This option can be selected or deselected only when you are starting up the emulator debugger.

[Supplementary explanation]

When debugging in CPU rewrite mode is enabled, the following functions cannot be used:

- Setting the address match breakpoint
- Software breakpoint setting in the internal ROM area
- Execution of COME in the internal ROM area

## 8. Executing the self-check

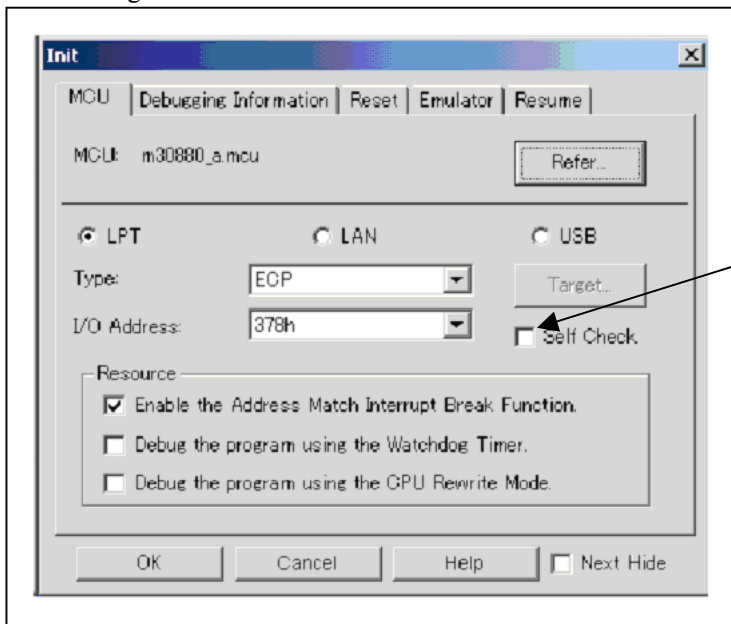
Executing the self-check

Enable this function when you want the emulator to be self-checked at startup. Be sure to select the check box only when you want the emulator to be self-checked at startup.

This function may be enabled in the following cases:

- When you are using the emulator you have just purchased
- When you fail to download the firmware
- When you successfully download the firmware, but fail to start up the emulator
- When you want to confirm whether the emulator is operating normally because, for example, the MCU runs out of control or something is wrong with the trace results

This function can be enabled only when you are starting up the emulator debugger.

(2) Debugging Information tab

1. Specifying the compiler used and the object format

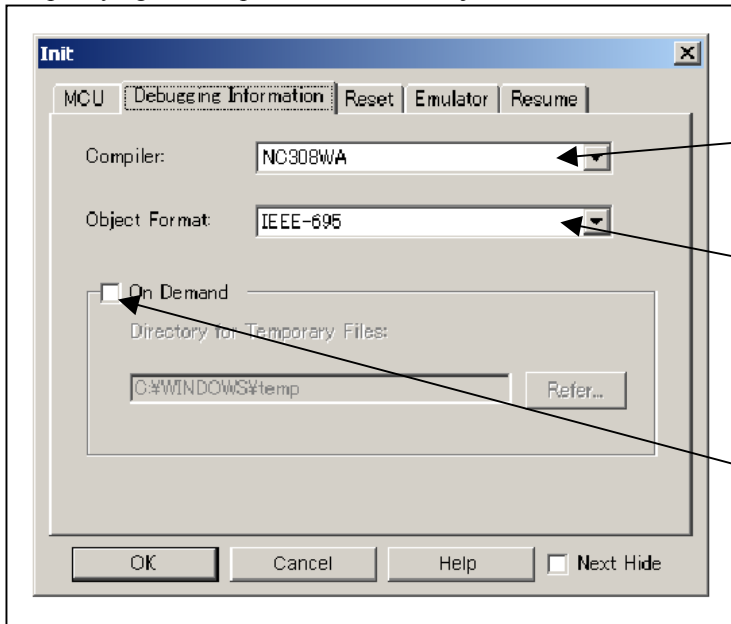

Specifying the compiler used and the object format

Specify the compiler you are using and the format of the object file output by the compiler.

- Compiler  
Select the compiler you are using.  
(By default, the C compiler from Renesas is selected.)
- Object Format  
Select the format of the object file that is output by the compiler you are using.

Specifying the method for storing debug information

There are two methods for storing debug information: on-memory method where data is held in memory and an on-demand method where data is held in a temporary file.

- On Memory  
This method helps to speed up processing if your computer has sufficient memory.
- On Demand  
This method helps to reduce the amount of memory needed. To use this method, select the "On Demand" check box.

(3) Reset tab

1. Resetting the target after downloading

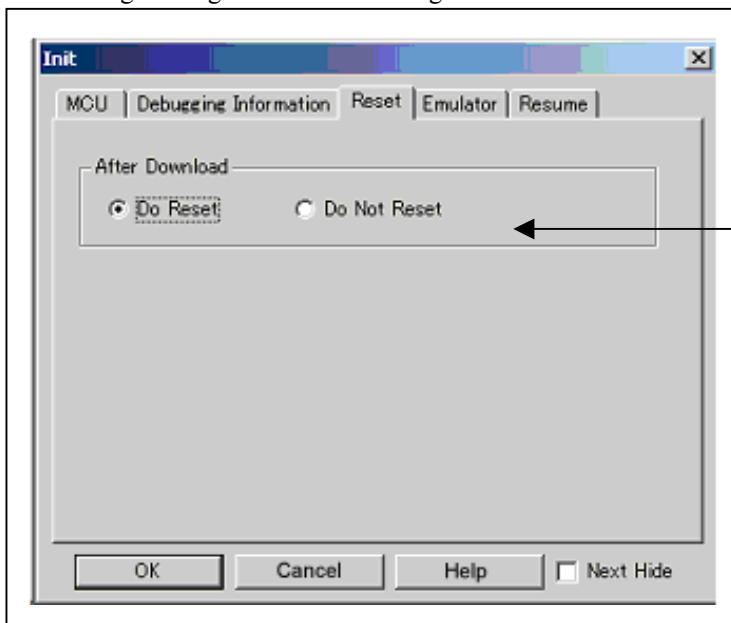

Resetting the target after downloading

Specify whether or not to reset the target immediately after downloading the user program.

- Do Reset  
Resets the target (default).
- Do Not Reset  
Does not reset the target.

The option you have specified here remains effective the next time you start up.

## (4) Emulator tab

## 1. Specifying the target clock

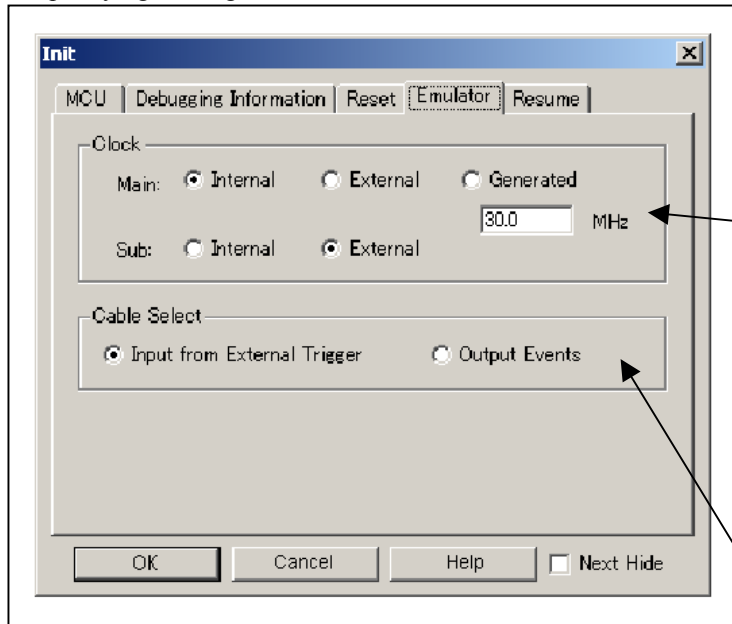
**Specifying the target clock**

Specify the clock sources supplied to the MCU (main clock and sub clock). Select the appropriate clock sources according to the clock used by your target MCU.

- Internal (default)  
Emulator PC7501's internal clock
- External  
User system clock
- Generated  
Clock created in PC7501

The option you have specified here remains effective the next time you start up.

**Selecting the event output/trigger input cable**

Select input/output of the event output/trigger input cable of the PC7501.

- Input from External Trigger (default)  
Inputs the external trigger from the cable
- Output Events  
Outputs events from the cable

The option you have specified here is reflected at only startup. However, if you reset the option in the Init dialog box after starting up, it is not effective (reboot the PD308F). "Input from External Trigger" is set at startup (the previous setting becomes null).

(5) Resume tab

1. Automatically executing a script command

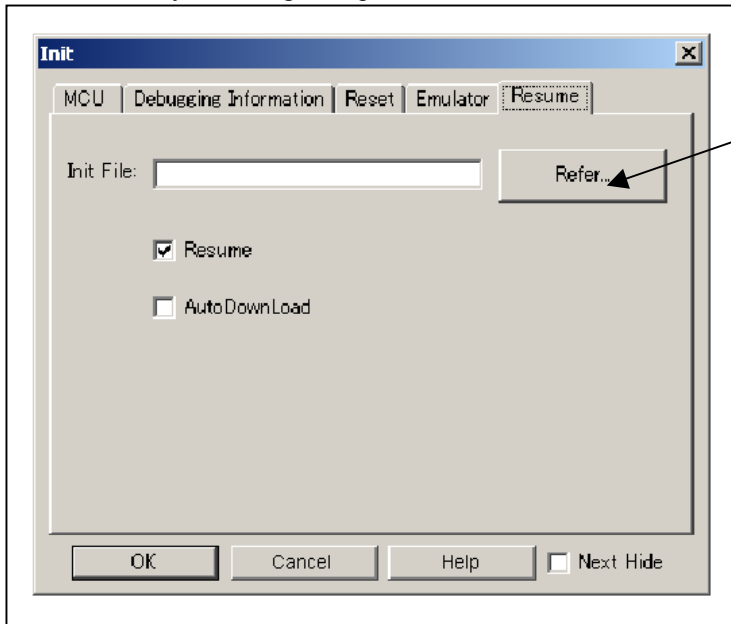

**Automatically executing a script command**  
To automatically execute a script command when starting up the debugger, click the “Refer...” button and specify the script file to be executed.  
  
Clicking the “Refer...” button brings up a file selection dialog box. The script file you have selected is displayed in the Init File: section of the dialog box shown here. If you do not want to automatically execute a script command, delete the character string displayed in the Init File: section of the dialog box.  
  
What you specify here is reflected at only startup. If you specify back again in the Init dialog box after startup, whatever you specified has no effect. (Be sure to restart the emulator debugger.)

2. Restoring the last window state

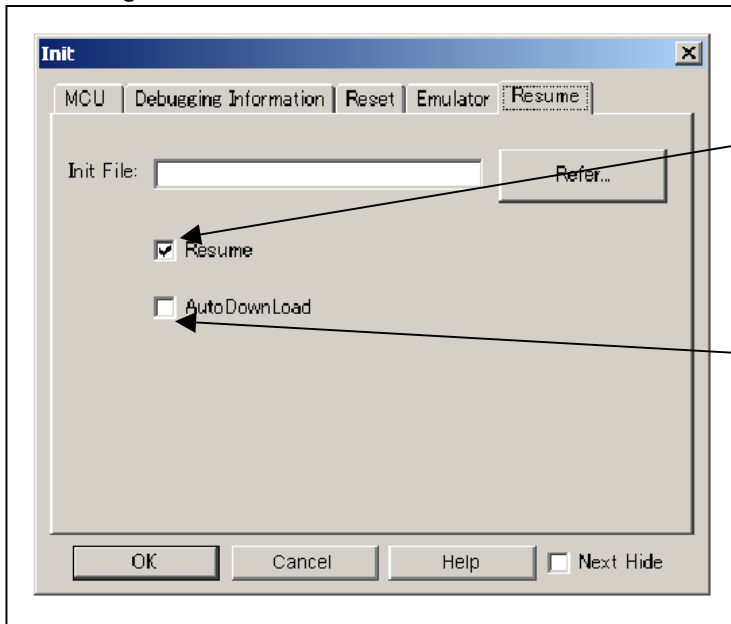

**Restoring the last window state**  
To restore the window state (window position and window size) in which you last closed the debugger, select the “Resume” check box. (This check box is by default selected.)

**Downloading the load module again**  
To download the load module (user program) again, select the “AutoDownLoad” check box. (This check box is by default deselected.)

## 3.2 Starting Up the Emulator Debugger (EMEM Dialog Box)

### (1) Status tab

#### 1. Specifying the processor mode

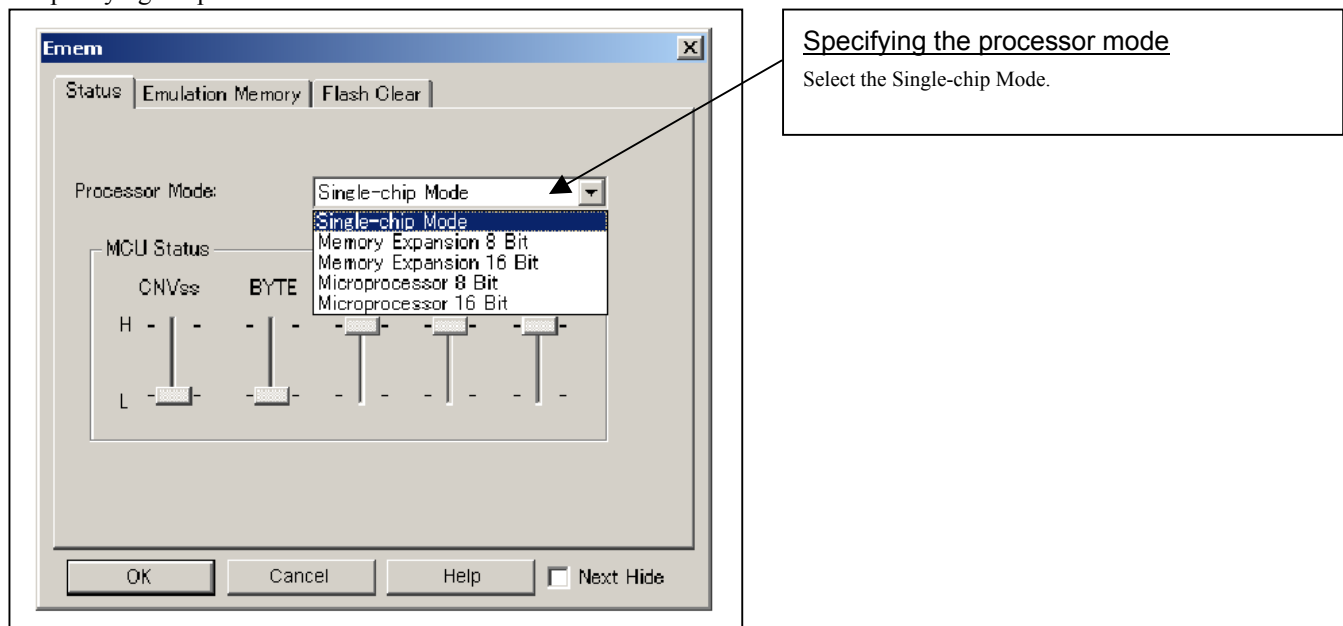

## IMPORTANT

### Notes on Selecting a Processor Mode:

- An available processor mode is single-chip mode only. Therefore, do not select any other processor mode.
- When setting single-chip mode, the level of pin CNVSS of the MCU status should be "L". The MCU status shows the pin level of the user system.

## 2. Referring to the MCU Status

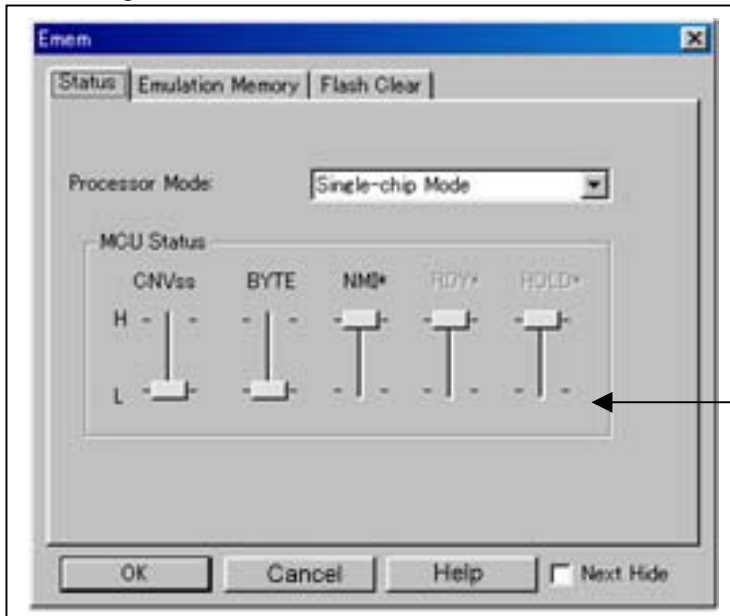
**Referring to the MCU Status**

It shows the status of each MCU pin. Check it to see if the MCU status matches the selected processor mode. If a slider of any pin is at the center, it means that the pin status is indeterminate.

**IMPORTANT****Notes on Selecting a Processor Mode:**

- The MCU status is shown in "MCU Status" of the EMEM dialog box. Check that the level of pin CNVSS of the MCU status is "L".



## (2) Emulation Memory tab

## 1. Setting the Bank Address of the Debug Monitor

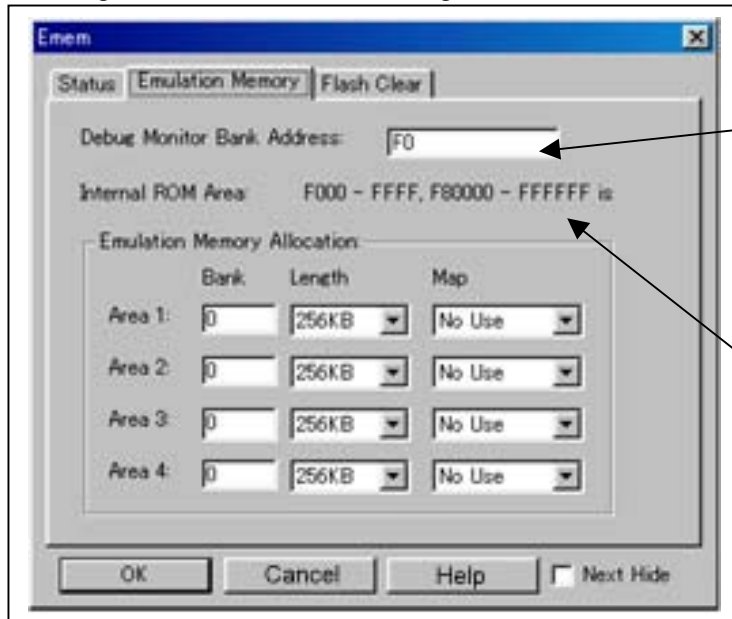
**Setting the Bank Address of the Debug Monitor**

The debug monitor uses contiguous 64 KB as a work area of the emulator. Specify the bank address of the debug monitor.

(e.g.: If F0 is specified, 64 KB area from F00000H address is used by the debug monitor)

**Automatically Allocating the Emulation Memory of the Internal ROM**

When selecting the single-chip mode, an emulation memory is automatically allocated to an internal ROM area. The automatically allocated addresses of the internal ROM are shown here.

**IMPORTANT****Notes on Setting a Debug Monitor Bank Address:**

- It is not possible to view or set the content of the specified area. Even on the memory window or in the reverse assemble area of the program/source windows, the content of this area is not displayed correctly though it can be displayed.
- The below bank addresses cannot be set for the debug monitor.
  - (1) MCU internal resources (ROM, RAM and SFR areas)
  - (2) Interrupt vector area

## 2. Emulation Memory Allocation as Expansion Area

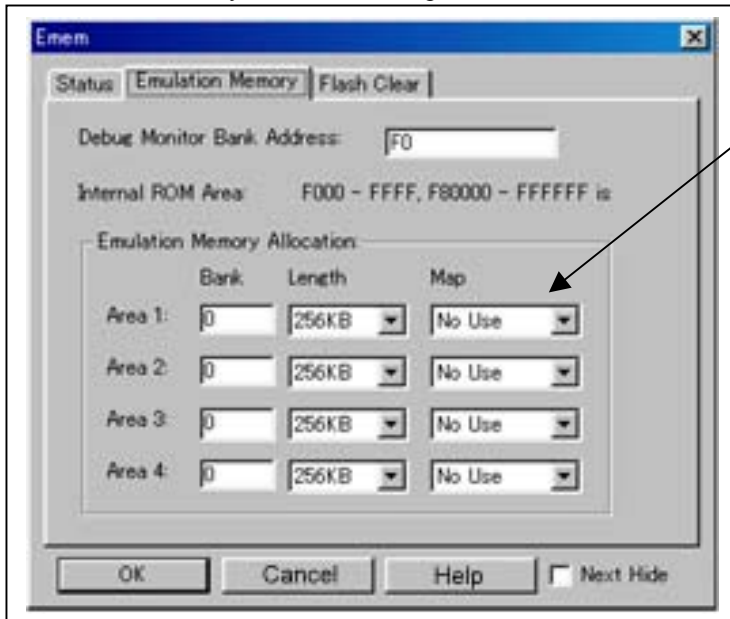
**Emulation Memory Allocation as Expansion Area**

Because the available processor mode is the single-chip mode only, select "No Use" in "Map".

## (3) Flash Clear tab

## 1. Setting to clear the MCU's internal flash ROM

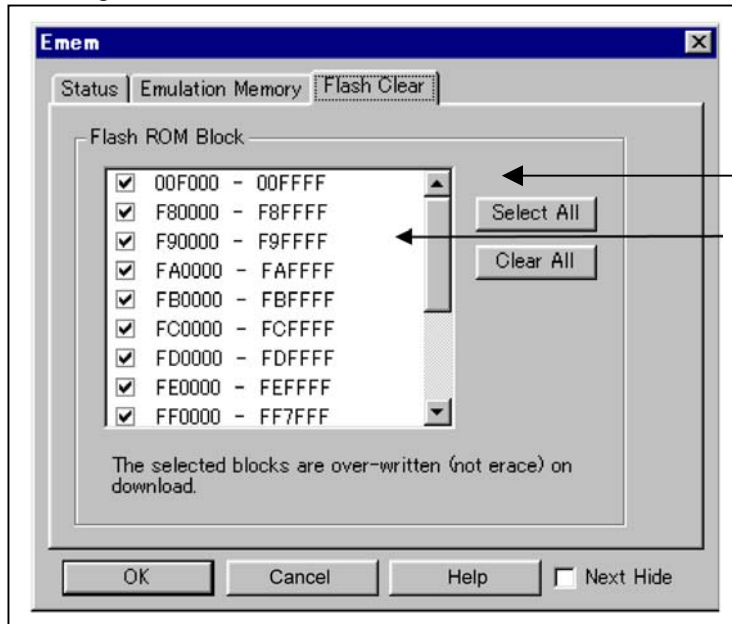
Setting to clear the MCU's internal flash ROM

Specify whether or not you want the MCU's internal flash ROM to be cleared when downloading the user program or data. (When cleared, the content of the flash ROM is initialized to 0xFF.) The MCU's internal flash ROM is listed in block units.

- Any block which has had its check box selected is not cleared when downloading. The memory content of this block remains intact unless overwritten by downloading.
- Any block which has had its check box deselected is cleared when downloading.
- Click the Select All button, and all blocks will be selected (marked by a check mark, so that none of the blocks is cleared when downloading).
- Click the Clear All button, and all blocks will be deselected (check marks removed, so that all of them are cleared when downloading).

The option you have specified here remains effective the next time you start up.

### 3.3 Program Window

#### (1) Downloading the program

##### 1. Initial screen of the program window

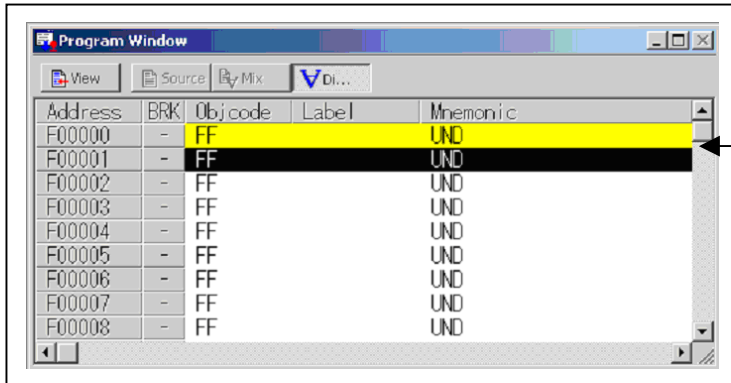

**Initial screen of the program window**  
 The program window is a window that always shows the content of the source file corresponding to the current position of the program counter. It automatically opens when the emulator starts up. The program counter position is identified by the yellow background color. Here, you can execute the program up to the cursor position, set or clear software breakpoints, and line-assemble the source file.  
 Because the present emulator uses the MCU's internal flash ROM, the initial value for the ROM area data at the time of purchase is "FFh."

##### 2. Downloading the program

Menu	Menu item	Function
File	Download	Downloads the user program.
	Load Module...	Downloads machine language data and debug information.
	Memory Image...	Downloads only machine language data.
	Symbol...	Downloads only debug information.
	Rom Data...	Downloads machine language data additionally.
	Reload...	Reloads the user program.
	Upload...	Uploads the user program.
	Save Disasm...	Saves the disassembled result.

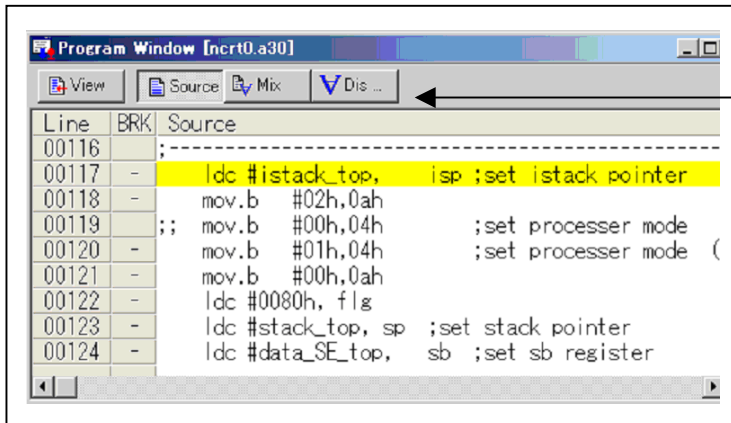

**Display after downloading the program**  
 The program window has the following three display modes.

- Source display mode  
 Displays the source file of the user program. The source file can be edited.
- Disassemble display mode  
 Displays the disassembled result of the user program.
- MIX display mode  
 Displays the source file of the user program along with the disassembled result for that part of the program.

(2) Program execution

1. Resetting the user program

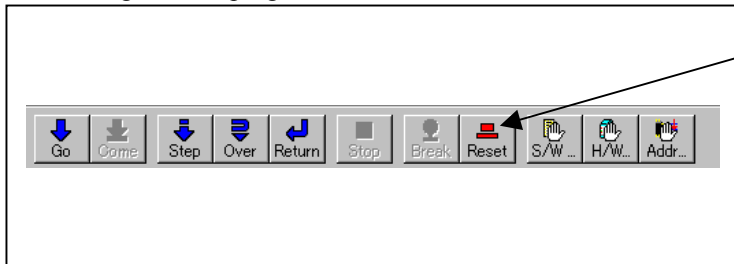

**RESET**  
Resets the program.

2. Executing the user program

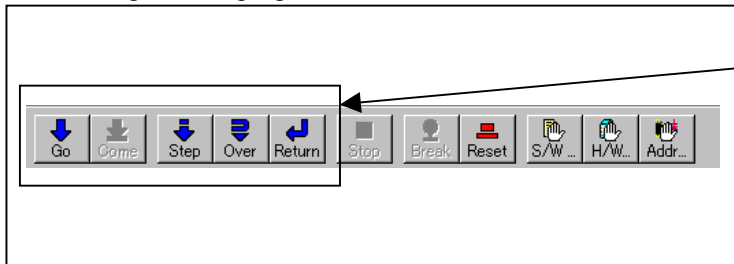

**GO**  
Executes the program from the current PC position.  
**STEP**  
Single-steps the program, stepping subroutines.  
**OVER**  
Single-steps the program, skipping over subroutines.  
**RETURN**  
Executes the program up to the high-order subroutine.

3. Stopping the user program

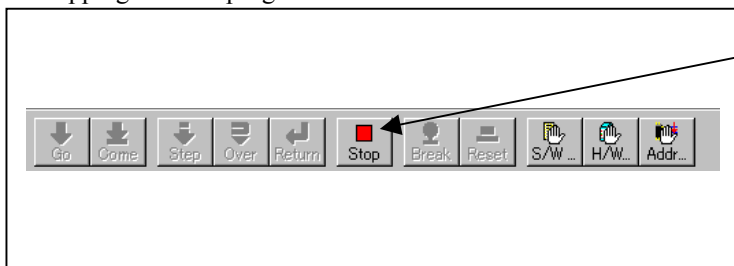

**STOP**  
Stops the program.

4. Program window screen after the user program has stopped

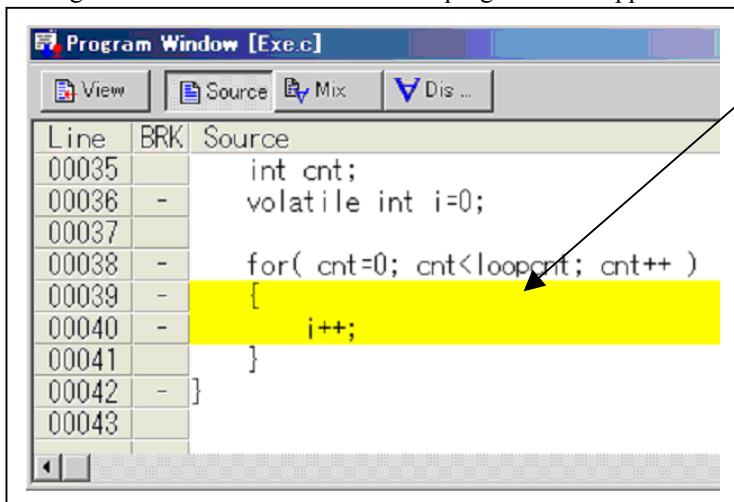

**Program window screen**  
The program position at which the program has stopped is identified by the yellow background color.

## (3) Setting breakpoints

## 1. Screen after breakpoint setup

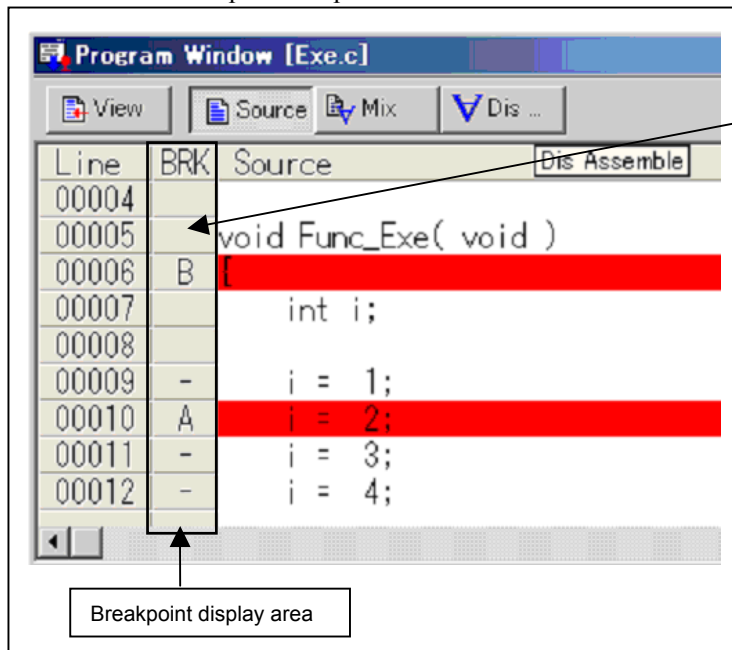
**Breakpoint setup screen**

There are three types of breakpoints as described below.

## - Address match breakpoint (A)

This breakpoint can be set only when you chose to use the address match break function on the MCU tab of the Init dialog box.

A breakpoint can be set or cleared by double-clicking in the breakpoint display area.

Up to eight breakpoints can be set. When this limit is exceeded, software breakpoints are set.

The address match break causes the program to stop before executing the address at which a breakpoint is set.

## - Software breakpoint (B)

A software breakpoint can be set or cleared by double-clicking the breakpoint display area.

This is rewritten to a break instruction, therefore, because of rewriting flash ROM, program execution starts with a delay of several seconds after setting ROM area.

If the breakpoint you set is a software breakpoint, the program stops before executing the instruction at the set breakpoint.

## - Hardware breakpoint (H)

A hardware breakpoint can be set or cleared by right-clicking the breakpoint display area.

If the breakpoint you set is a hardware breakpoint, the program stops after executing the instruction at the set breakpoint (after several cycles).

(4) Executing up to the cursor position (Come command)

1. Specifying the Come command

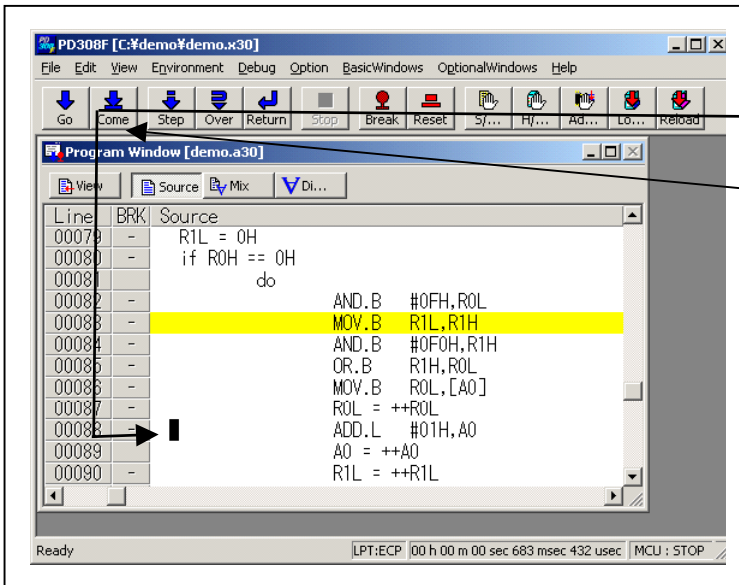

Setup procedure for executing COME command

- (1) Click the line in the program display area at which you want the program to execute.
- (2) Click the Come button.

2. After the Come command has finished

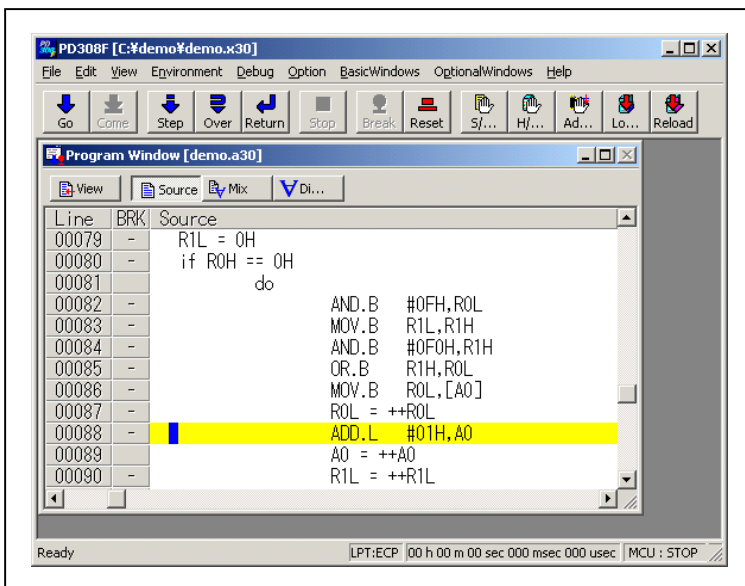

### 3.4 Hardware Breakpoint Setting Window

#### (1) Breakpoint setup dialog box

##### 1. Opening the hardware breakpoint setup dialog box

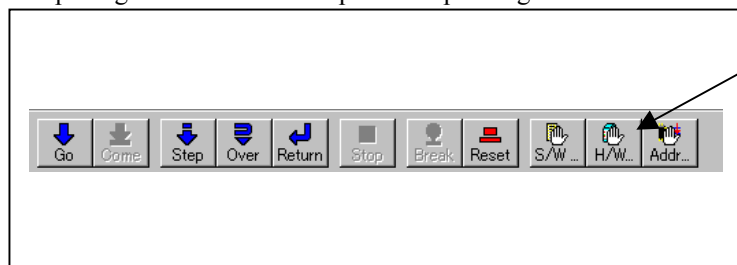

**Hardware Break Point**  
 Clicking this button opens the hardware breakpoint setup dialog box.

##### 2. Hardware Break Point Setting Window in initial state

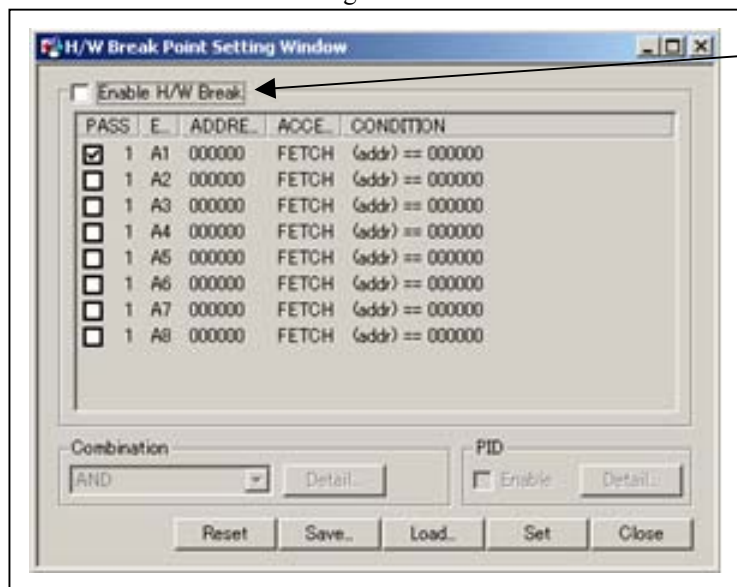

**H/W breakpoint Setting Window in initial state**  
 Select the "Enable H/W Break" check box, and this break function will be enabled, allowing you to set hardware breakpoints.

##### 3. Opening the break event setting dialog box

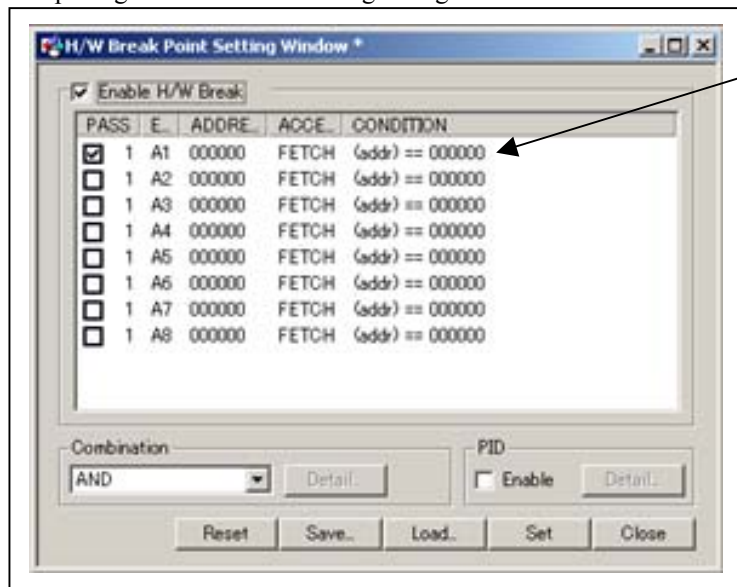

**Setting Break Event**  
 Click the event line at which you want set a break event.



4. Opening the break event setting dialog box

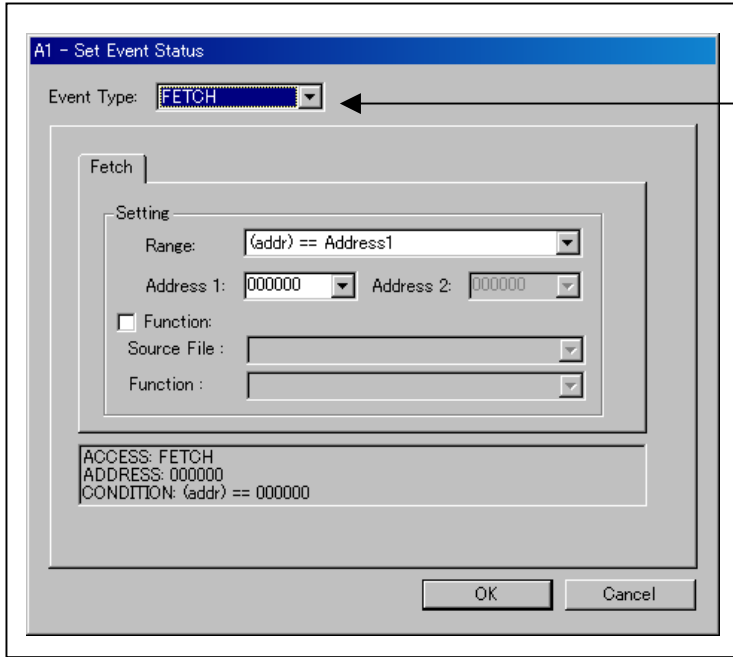

**Specifying the event type**

Click to select the event type you want to set.

- FETCH  
Detects an instruction prefetch.
- DATA ACCESS  
Detects a memory access.
- BIT SYMBOL  
Detects a bit access.
- INTERRUPT  
Detects an interrupt occurrence or interrupt termination.
- TRIGGER  
Detects a signal from the external trace signal input cable.

(2) When FETCH is selected

1. Window for setting addresses

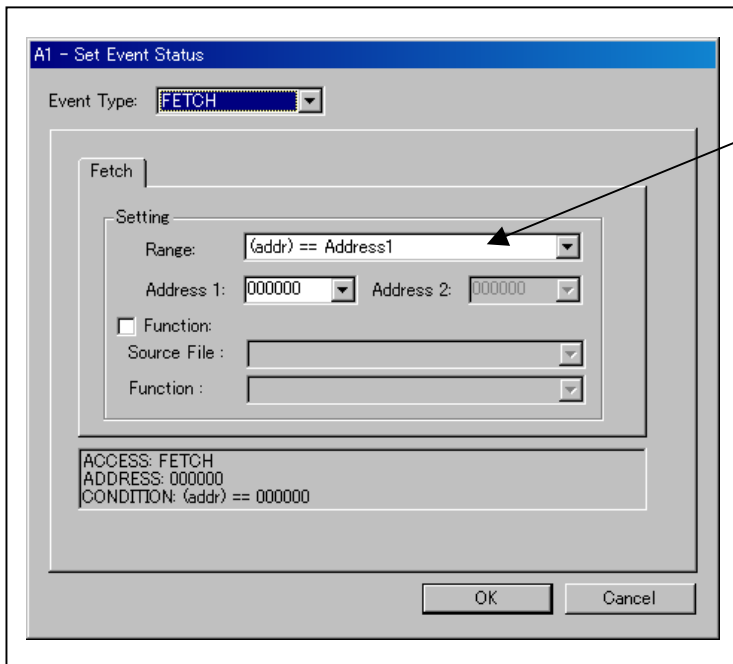

**Setting the address**

You can set eight conditions, e.g., a specified address, a specified address range, etc. When you have finished setting the address, click OK.

(3) When DATA ACCESS is selected

1. Window for setting the address

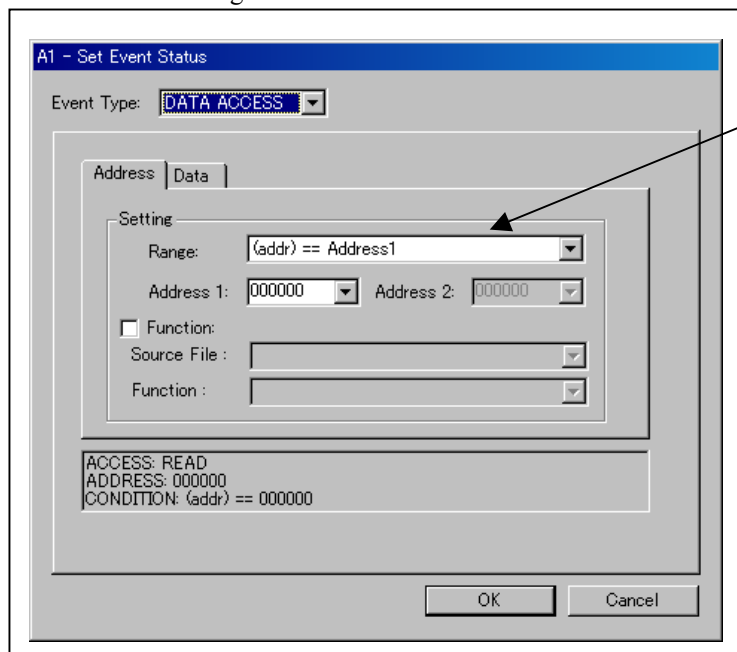

**Setting the address**  
 You can set eight conditions, e.g., a specified address, a specified address range, etc.

2. Window for setting data

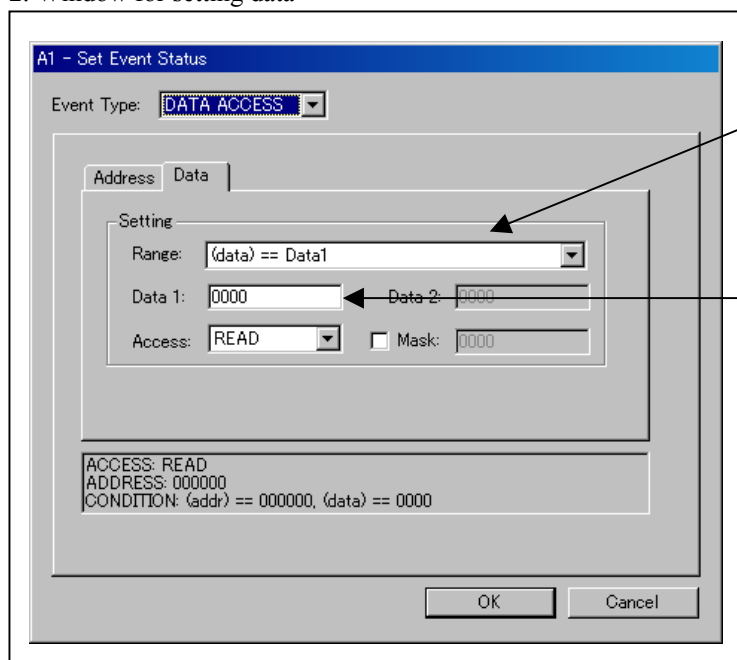

**Setting data**  
 You can set eight conditions, e.g., a specified data, a specified data range, etc.

**Setting the access condition**  
 You can set three conditions, e.g., read, write, and read/write. When you have finished setting the data and access condition, click OK.

3. Example Data Settings

Event setting for even-address word access

MOV.W R0,512h(R0=0203h)

Cycle	Label	Address	Data	BUS	BHE	BIU	R/W	RWT	CPU
-00059		000512	0203	16b	0	DW	W	0	RW

High-order and low-order data effective

Event setting for odd-address word access

MOV.W R0,519h(R0=0203h)

Cycle	Label	Address	Data	BUS	BHE	BIU	R/W	RWT	CPU
-00026		000519	0302	16b	0	DW	W	0	CW
-00025		00051A	0302	16b	1	DW	W	0	--

Odd-address high-order data effective

Even-address low-order data effective

Event setting for even-address byte access

MOV.B R0L,516h(R0L=03h)

Cycle	Label	Address	Data	BUS	BHE	BIU	R/W	RWT	CPU
-00033		000516	0503	8b	1	DB	W	0	RW

Low-order data effective

Event setting for odd-address byte access

MOV.B R0L,515h(R0L=03h)

Cycle	Label	Address	Data	BUS	BHE	BIU	R/W	RWT	CPU
-00046		000515	0315	8b	0	DB	W	0	RW

High-order data effective

Setting a break event

**A1**

Address 1 : 000512

Data 1 : 0203

MASK : FFFF

Access : WRITE

Setting a break event (using 2 events)

**A1**

**A2**

Address 1 : 000519      Address 1 : 00051A

Data 1 : 0300      Data 1 : 0002

MASK : FF00      MASK : 00FF

Access : WRITE      Access : WRITE

Set the combinatorial events to AND.

Setting a break event

**A1**

Address 1 : 000516

Data 1 : 0003

MASK : 00FF

Access : WRITE

Setting a break event

**A1**

Address 1 : 000515

Data 1 : 0300

MASK : FF00

Access : WRITE

(4) Setting the combinatorial event condition

1. Window for setting the combinatorial event condition

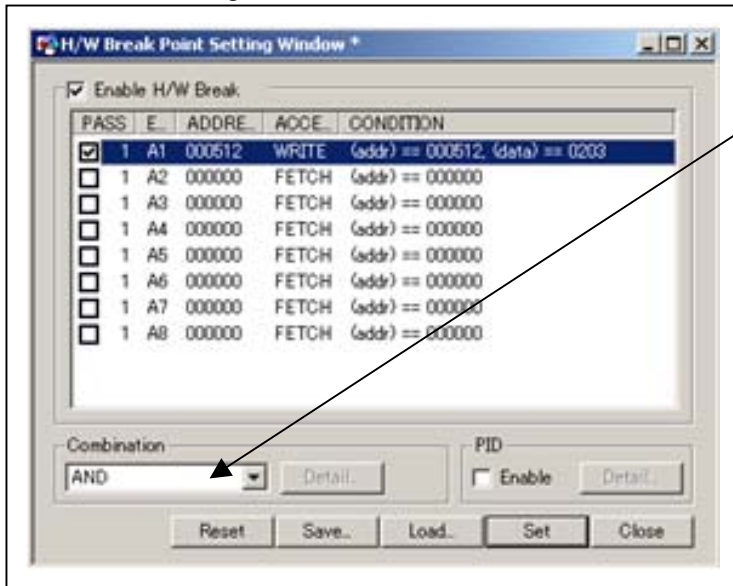

Setting the combinatorial event condition

There are following four conditions that you can choose for the combinatorial events.

- AND  
The program breaks when all of the specified events occur.
- AND (Same Time)  
The program breaks when the specified events occur at the same time.
- OR  
The program breaks when one of the specified events occurs.
- STATE TRANSITION  
The program breaks when the state transition diagram goes into the break state.

For each event, a pass count (number of passing) is specifiable (1--255). When "AND" (same time) is specified for Combination, you can not specify the pass count (fixed to one).

When you have finished setting the combinatorial event condition, click the "Set" button.

### 3.5 Trace Window

#### (1) Trace window

##### 1. Trace window

Menu	Menu item	Function
OptionalWindows	Trace Window	Opens the trace window.

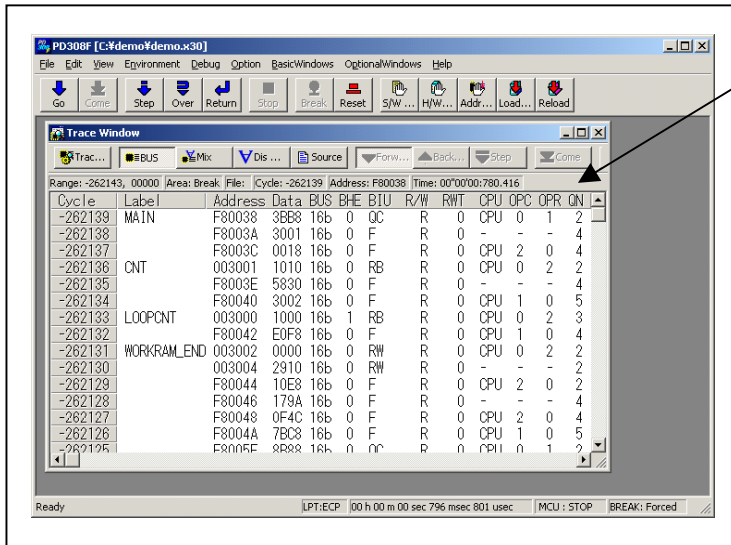

#### Trace window

The trace window is used to show the results of real-time trace measurements. It has the following four display modes:

- Bus mode  
Bus information per cycle can be inspected. The contents are displayed in order of execution paths.
- Disassemble + data access mixed mode  
The executed instruction and the content of the accessed data can be inspected together. Contents are displayed in order of the execution paths.
- Disassemble mode  
The execution paths of the executed instructions can be inspected. The contents are displayed in order of execution paths.
- Source mode  
The execution paths of the source program can be inspected.

These modes can be switched over using the respective toolbar buttons.

The trace window shows the measurement result when a real-time trace measurement has finished. The trace window remains blank until the real-time trace measurement in progress finishes.

2. Trace window (bus display)

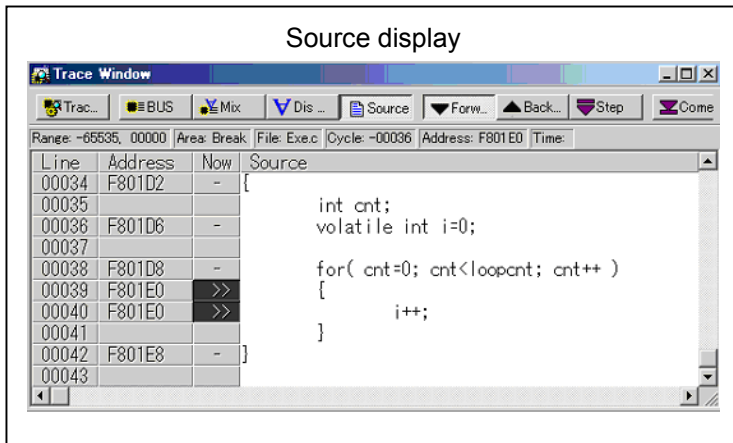
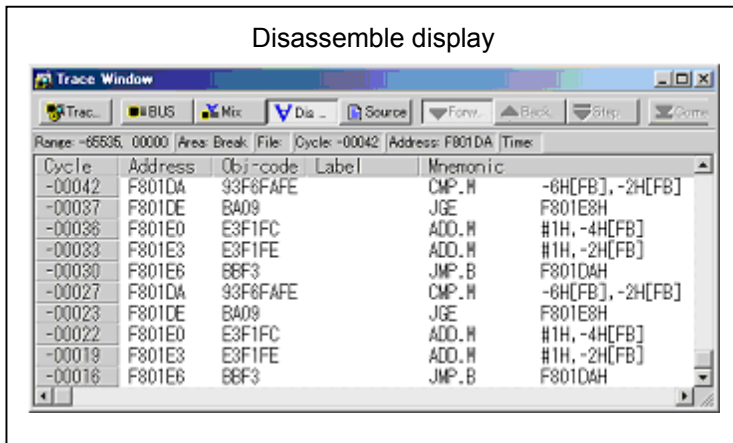
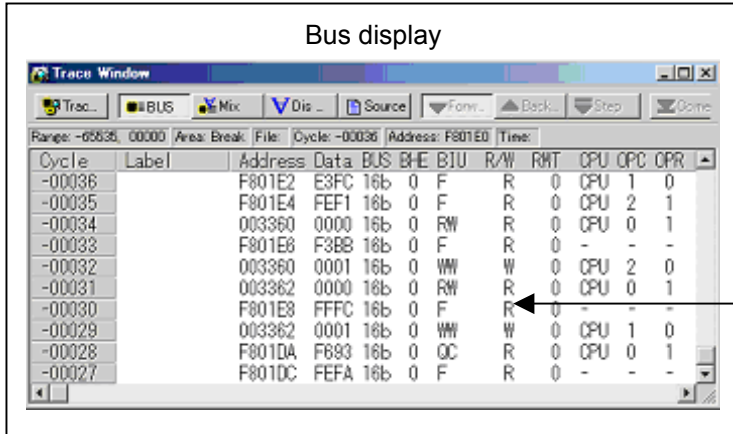

Explanation of the trace window (bus display)

The following explains the displayed contents, from left to right.

- Address  
Shows the status of the address bus.
- Data  
Shows the status of the data bus.
- BUS  
Shows the width of the external data bus. In the present emulator, only "16b" for 16 bits wide bus is displayed.
- BHE\*  
Shows the status (0 or 1) of the BHE (Byte High Enable) signal. If this signal = 0, the odd-address data is valid.
- BIU  
Shows the status between the BIU (Bus Interface Unit) and memory or I/O.  
Symbol Status  
- No change  
WAIT Executing the wait instruction  
RBML Read (bytes) ML on  
F Fetch  
QC Discontinuous fetch  
RWML Read (words) ML on  
INT Interrupt acknowledge cycle  
RB Read (bytes)  
WB Write (bytes)  
DRB Read (bytes) by DMA  
DWB Write (bytes) by DMA  
RW Read (words)  
WW Write (words)  
DRW Read (words) by DMA  
DWW Write (words) by DMA
- R/W  
Shows the status of the data bus.  
Displayed as "R" for Read, "W" for Write, and "-" for no access.
- RWT  
This is the signal to indicate a valid bus cycle. When valid, RWT = 0. The Address, Data, and the BIU signals are effective when this signal is 0.
- CPU  
Shows the status between the CPU and BIU (Bus Interface Unit).  
OPC  
Shows the op-code size in the read data.
- OPR  
Shows the code size except op-code.
- QN  
Shows the byte count stored in the instruction queue buffer. The display range is 0 to 8.
- B-T  
Shows the level of the trigger signal for break event (EXTIN7 pin of external trace signal input cable, purple).
- Q-T  
Shows the level of the trigger signal for trace event (EXTIN6 pin of external trace signal input cable, blue).
- 76543210  
Shows the level of external trace signal input cable EXTIN0 to EXTIN7.
- h" m' s:  
Shows the elapsed time after starting the user program.

(2) Suspending and resuming trace measurement

1. Suspending trace measurement

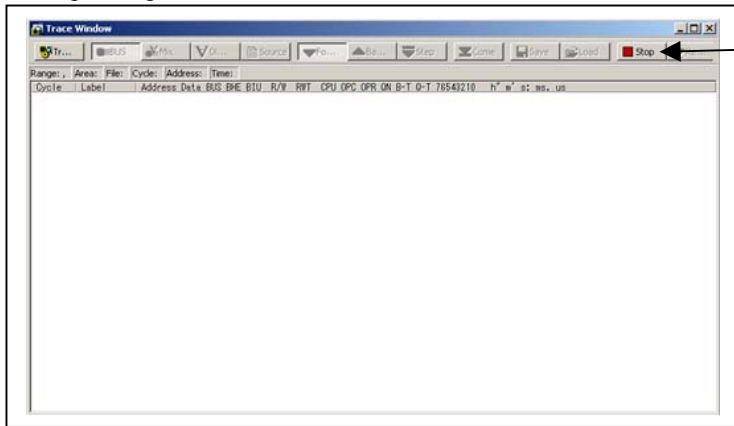

**Stop**  
Click this toolbar button to suspend the trace measurement in progress.

2. Resuming trace measurement

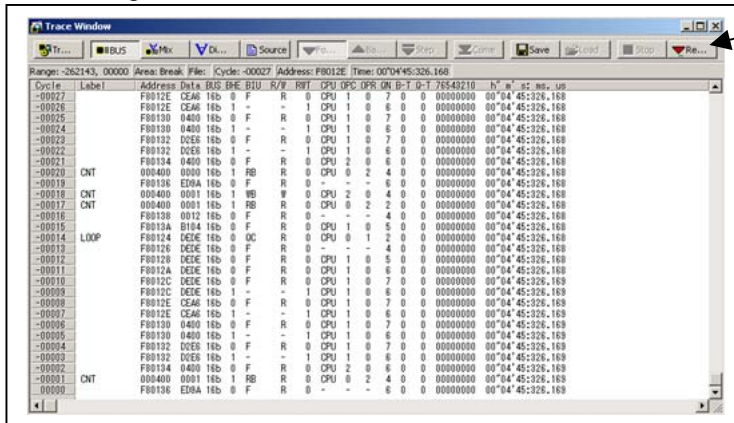

**Re-Start**  
Click this toolbar button to resume the trace measurement in progress.

## (3) Trace point setup dialog box

## 1. Opening the trace point setup dialog box

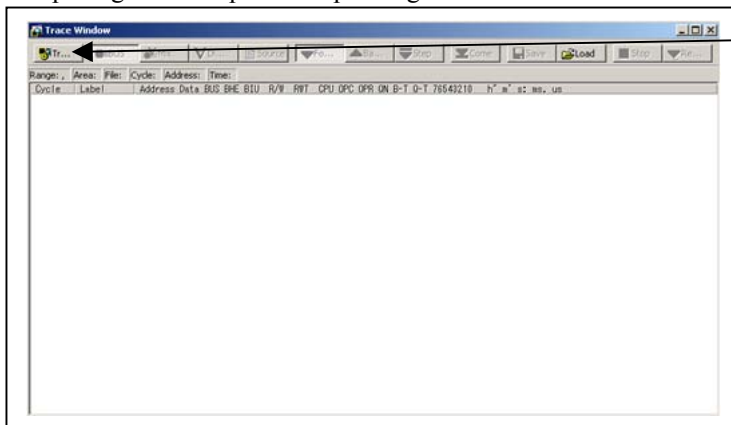
**Trace Point**

Clicking this toolbar button opens the trace point setting window.

## 2. Trace Point Setting Window in initial state

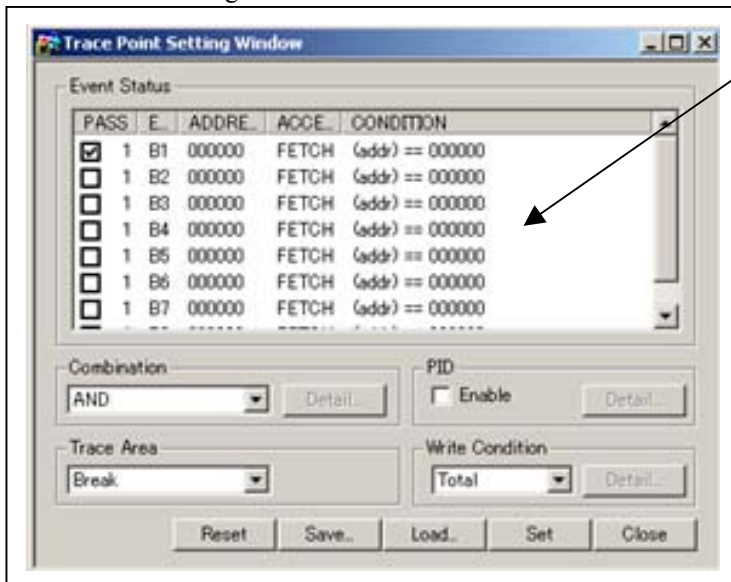
**Trace Point Setting Window in initial state**

Be sure to enable the trace point function in the Init dialog box before you set up in this window. Here, you can set events in the same way as for the hardware breakpoints.



3. Specifying a trace range

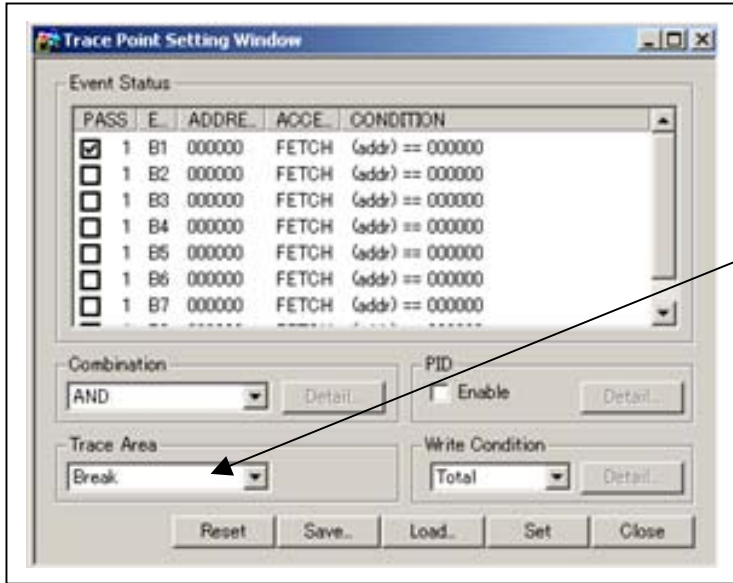

**Specifying a trace range**

You can specify a trace range for the trace event.

- Break  
256K cycles of instruction execution before the user program stopped is recorded.
- Before  
256K cycles of instruction execution before a trace point condition was met is recorded.
- About  
128K cycles of instruction execution before and after a trace point condition was met is recorded.
- After  
256K cycles of instruction execution after a trace point condition was met is recorded.
- Full  
256K cycles of instruction execution after a trace began is recorded.

4. Setting the trace write condition

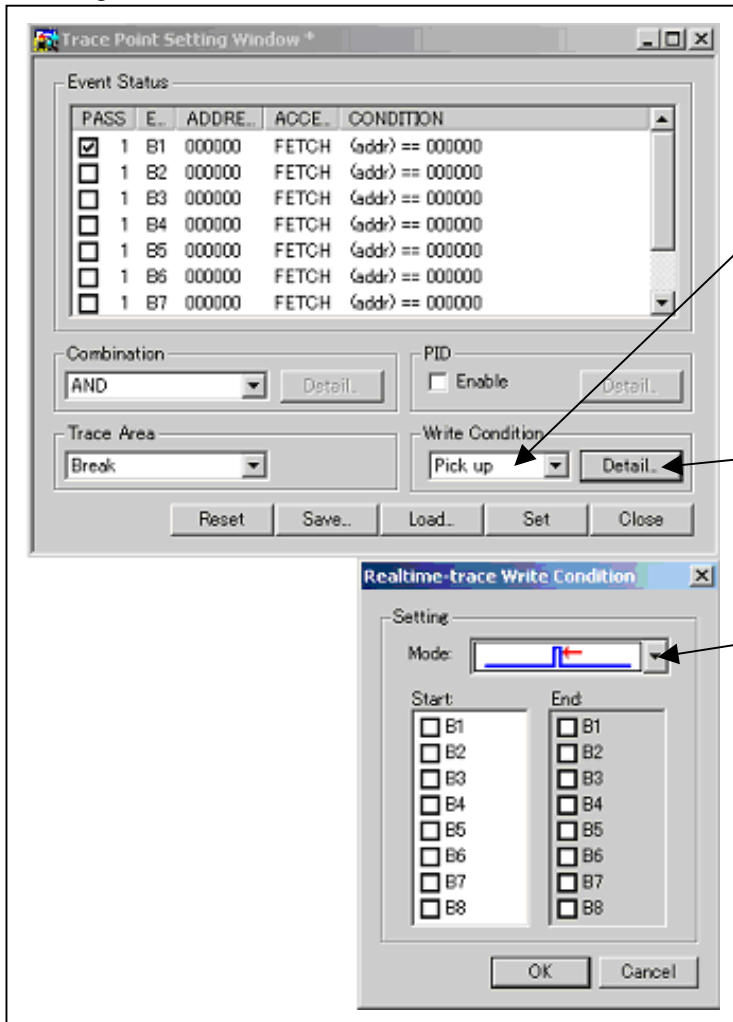

**Setting the trace write condition**

You can specify a condition for the cycles to be written into the trace memory.

- Total  
All cycles are written into memory.
- Pick up  
Only the cycles in which the specified condition was met are written into memory.
- Exclude  
Only the cycles in which the specified condition was not met are written into memory.

When you have finished setting the trace write condition, click this button. The Realtime-trace Write Condition dialog box shown below will appear.

**Write mode**



Only the cycle in which the specified Start event occurred



A range of cycles from when the specified Start event occurred to when the specified Start event became nonexistent



A range of cycles from when the specified Start event occurred to when the specified End event occurred

## 3.6 RAM Monitor Window

### (1) RAM monitor window

#### 1. RAM monitor window

Menu	Menu item	Function
<u>BasicWindows</u>	RAM Monitor Window	Opening the RAM monitor window

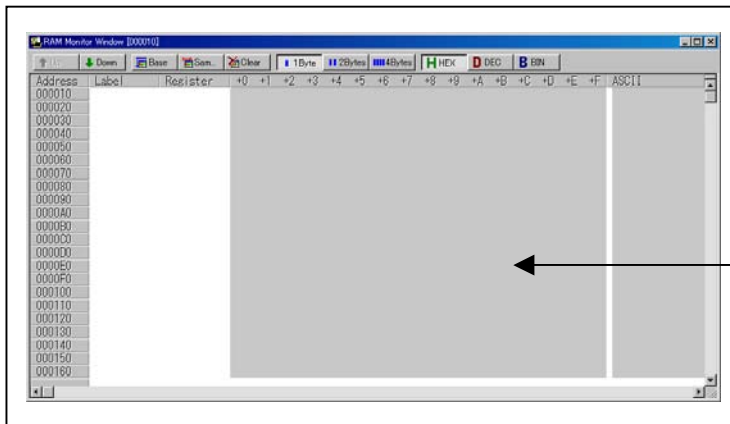

#### RAM monitor window

This window shows changes of memory contents while the user program is executed. This is accomplished by using the real-time RAM monitor function, and the memory contents corresponding to the RAM monitor area are displayed in dump form. The memory contents displayed here are updated at given intervals (by default, every 100 ms) during user program execution.

(2) RAM monitor area setting window

1. Opening RAM monitor area setting window

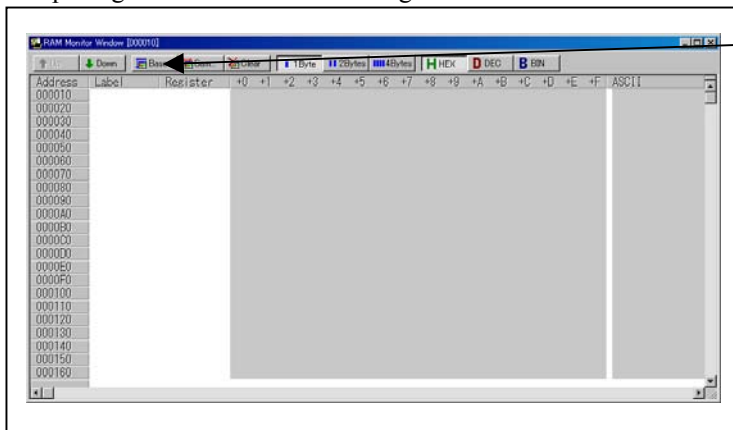

**Base**  
 Clicking this toolbar button opens the RAM monitor area setting window.

2. RAM monitor area setting window in initial state

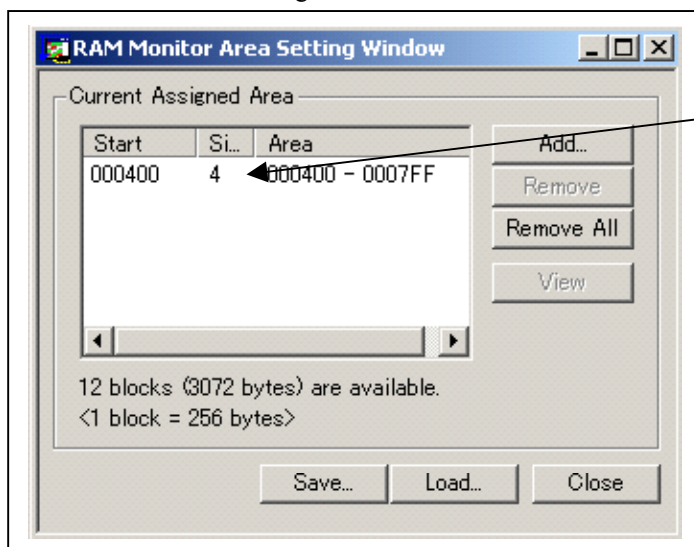

**RAM Monitor Area Setting Window in initial state**  
 By default, the monitor area is set to 000400h through 0007FFh. To change it, click the line you want to set.

3. RAM monitor area setting dialog box

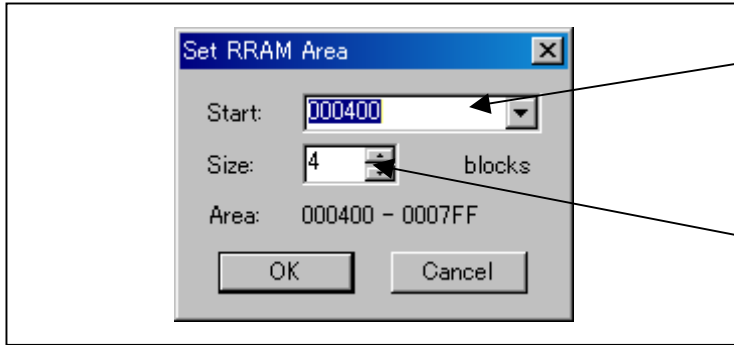

**Specifying the start address**  
 You can set the start address of the RAM area to be monitored.

**Specifying the size**  
 You can set the size to be monitored by specifying the number of blocks from the start address. One block is 256 bytes in size.

4. RAM monitor area setting dialog box when RAM monitor area is changed from 400h to 1 block

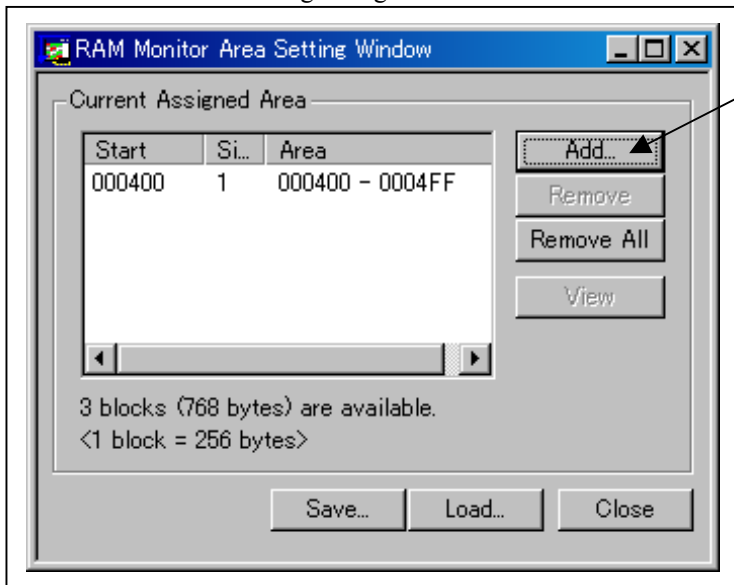

**Specifying the start address**  
 You can set the start address of the RAM area to be monitored. To add a RAM monitor area, click the "Add..." button. The RAM Monitor Area Setting Window will be displayed.

5. RAM monitor area setting dialog box

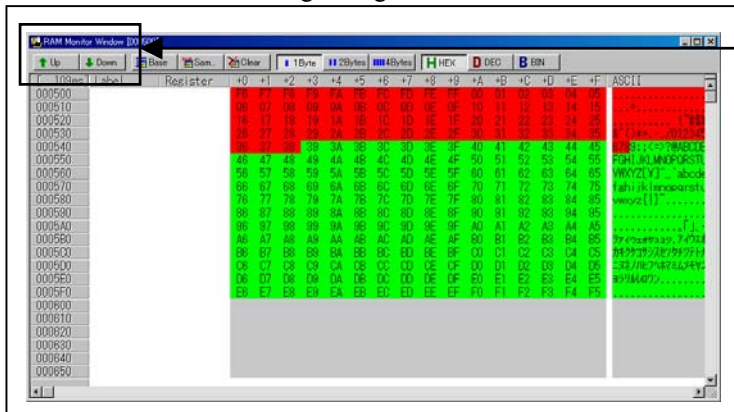

**Changing the RAM monitor display area**  
 You can change the manner in which the RAM monitor area you have set in the above dialog box is displayed.

- Up : Shows the blocks at the preceding addresses.
- Down : Shows the blocks at the following addresses.

The background colors of the data display and the code display sections change with the access attribute as described below.

- Green : Addresses accessed for read
- Red : Addresses accessed for write
- White : Addresses not accessed

The background colors can be changed as necessary.

## 4. Hardware Specifications

This chapter describes specifications of this product.

### 4.1 Target MCU Specifications

Table 4.1 lists the specifications of target MCUs which can be debugged with this product.

Table 4.1 Specifications of target MCUs for the M30880T-EPB

Item	Description
Applicable MCU	M32C/88 Group
Applicable MCU mode	Single-chip mode
Maxi. ROM/RAM capacity	1. Internal flash ROM: 516 KB 0F000h--0FFFFh, F80000h--FFFFFFh 2. Internal RAM: 18 KB 00400h--04BFFh
Operating voltage/frequency	VCC1=VCC2=4.2--5.5 V: 32 MHz

## 4.2 Differences between the Actual MCU and Emulator

Differences between the actual MCU and emulator are shown below. When debugging the MCU using this product, be careful about the following precautions.

### IMPORTANT

#### Note on Differences between the Actual MCU and Emulator:

- Operations of the emulator system differ from those of actual MCUs as listed below.
  - (1) Reset condition
  - (2) Initial values of internal resource data of an MCU at power-on
  - (3) Interrupt stack pointer (ISP) after a reset is released
  - (4) Capacities of the internal memories (ROM and RAM)
 

The MCU whose RAM size is 18 KB (400h--4BFF) is mounted on this product. The internal flash memory is automatically allocated to F000h--FFFFh and F80000h--FFFFFFh in the single-chip mode.
  - (5) Oscillator circuit
    - Make note of the fact that in the oscillator circuit where a resonator is connected between pins  $X_{IN}$  and  $X_{OUT}$ , oscillation does not occur because a converter board and other devices are used between the evaluation MCU and the user system. It is same for a sub-clock oscillator ( $X_{CIN}$  and  $X_{COUT}$ ).
    - For notes on when using the oscillator circuit on the user system, refer to "(2) Using the Oscillator Circuit on the User System" (page 46).
  - (6) A/D conversion
 

As a converter board and other devices are used between the evaluation MCU and the user system, some characteristics are slightly different from those of an actual MCU.
  - (7) Port P15
 

As one of I/O ports (P15) is connected to the user system through the analog switch circuit, electric characteristics slightly differ from those of an actual MCU.
  - (8) When the SW4 is set to XOUT in stop mode, a clock is output from the XOUT pin.

#### Note on RESET\* Input:

- A low input to pin RESET\* from the user system is accepted only when a user program is being executed (only while the RUN status LED on the emulator's upper panel is lit).

#### Note on NMI\* Input:

- A low input to pin NMI\* from the user system is accepted only when a user program is being executed (only while the RUN status LED on the emulator's upper panel is lit).

## IMPORTANT

### Notes on Reset Vector Area:

- For a reset vector area, memory of the emulator is always selected regardless of the setting of the EMEM dialog box.
- A reset vector area can be changed only when a program is stopped.

### Notes on Stack Area:

- With this product, a maximum 20 bytes of the user stack is consumed as a work area. Therefore, ensure the +20 byte maximum capacity used by the user program as the user stack area. If the user stack does not have enough area, do not use areas which cannot be used as stack (SFR area, RAM area which stores data, or ROM area) as work area. Using areas like this is a cause of user program crashes and destabilized emulator control.
- With this product, the interrupt stack pointer (ISP) is set to 00500h and used as stack area after the reset is released.

### Notes on Maskable Interrupts:

- Even if a user program is not being executed (including when run-time debugging is being performed), the evaluation MCU keeps running so as to control the emulation probe. Therefore, timers and other components do not stop running. If a maskable interrupt is requested when the user program is not being executed (including when run-time debugging is being performed), the maskable interrupt request cannot be accepted, because the emulator disables interrupts. The interrupt request is accepted immediately after the user program execution is started.
- Take note that when the user program is not being executed (including when run-time debugging is being performed), a peripheral I/O interruption is not accepted.

### Notes on Access Prohibited Area:

- The emulator control register (000020h--00003Fh) in the SFR is read- and write-protected. When this register is accessed, emulator control cannot be utilized.
- With this product, address FFFFFFFh cannot be read or written in correctly.

### Note on DMA Transfer:

- With this product, the user program is stopped with a loop program to a specific address. Therefore, if a DMA request is generated by a timer or other source while the user program is stopped, DMA transfer is executed. However, make note of the fact that DMA transfer while the program is stopped may not be performed correctly. Also note that the below registers have been changed to generate DMA transfer as explained here even when the user program is stopped.
  - (1) DMA0 transfer count register DCT0
  - (2) DMA1 transfer count register DCT1
  - (3) DMA0 memory address register DMA0
  - (4) DMA1 memory address register DMA1
  - (5) DMA2 transfer count register DCT2 (R0)
  - (6) DMA3 transfer count register DCT3 (R1)
  - (7) DMA2 memory address register DMA2 (A0)
  - (8) DMA3 memory address register DMA3 (A1)

## IMPORTANT

### Note on DMAC II Transfer Completion Interrupts:

- You can use DMAC II transfer completion interrupts during program execution only. Do not generate DMAC II transfer completion interrupts when you use any function but program execution.

### Note on Final Evaluation:

- Be sure to evaluate your system with an evaluation MCU. Before starting mask production, evaluate your system and make final confirmation with a CS (Commercial Sample) version MCU.



### 4.3 Connection Diagrams

Figures 4.1 and 4.2 show the connection diagrams of the M30880T-EPB. These connection diagrams mainly show the interface section. The signals not shown in Figures 4.1 and 4.2 connect the evaluation MCU and the user system directly. The circuits not connected to the user system such as the emulator's control system are omitted. Table 4.2 shows IC electric characteristics of this product for reference purposes.

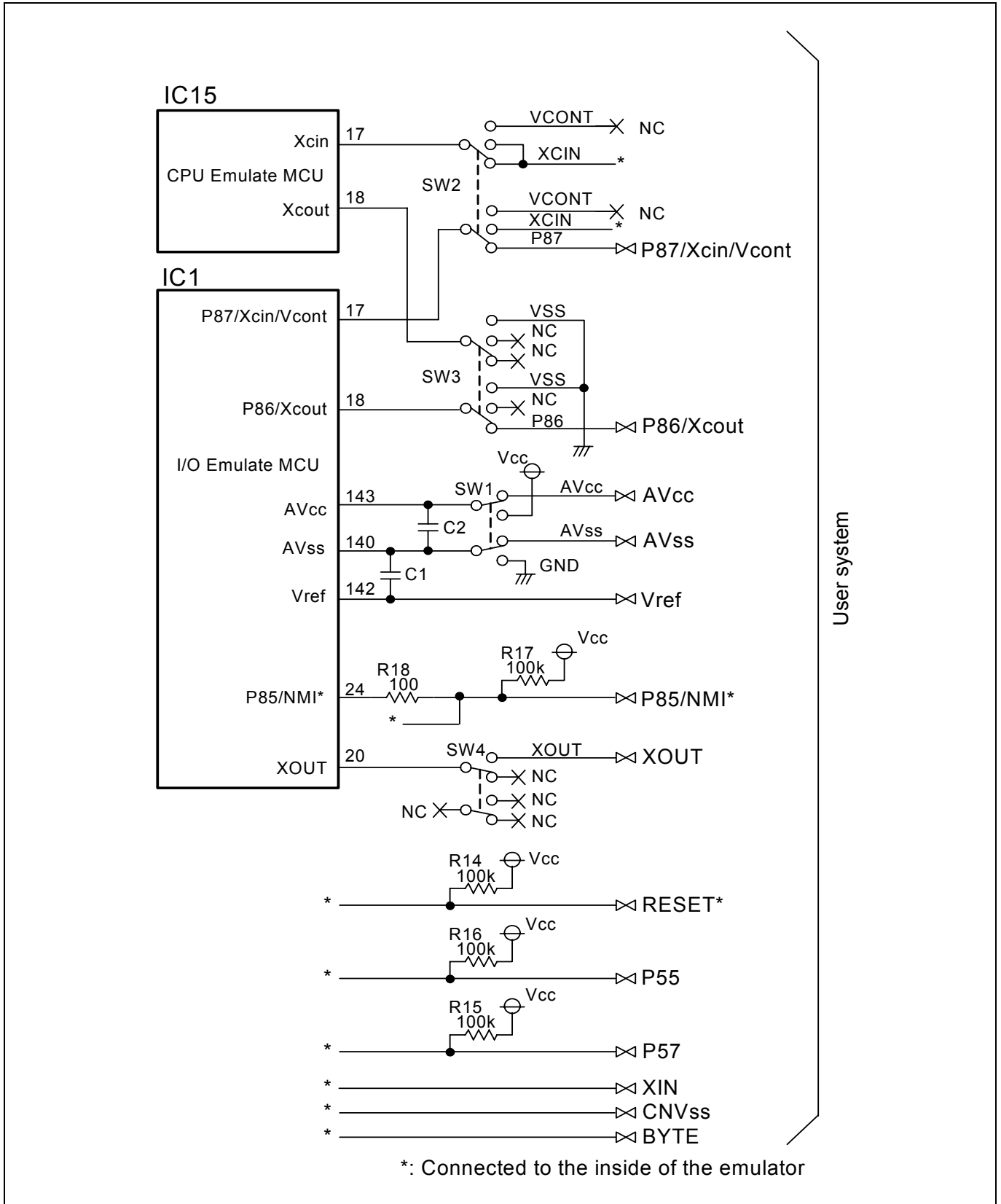

Figure 4.1 Connection diagram (1/2)

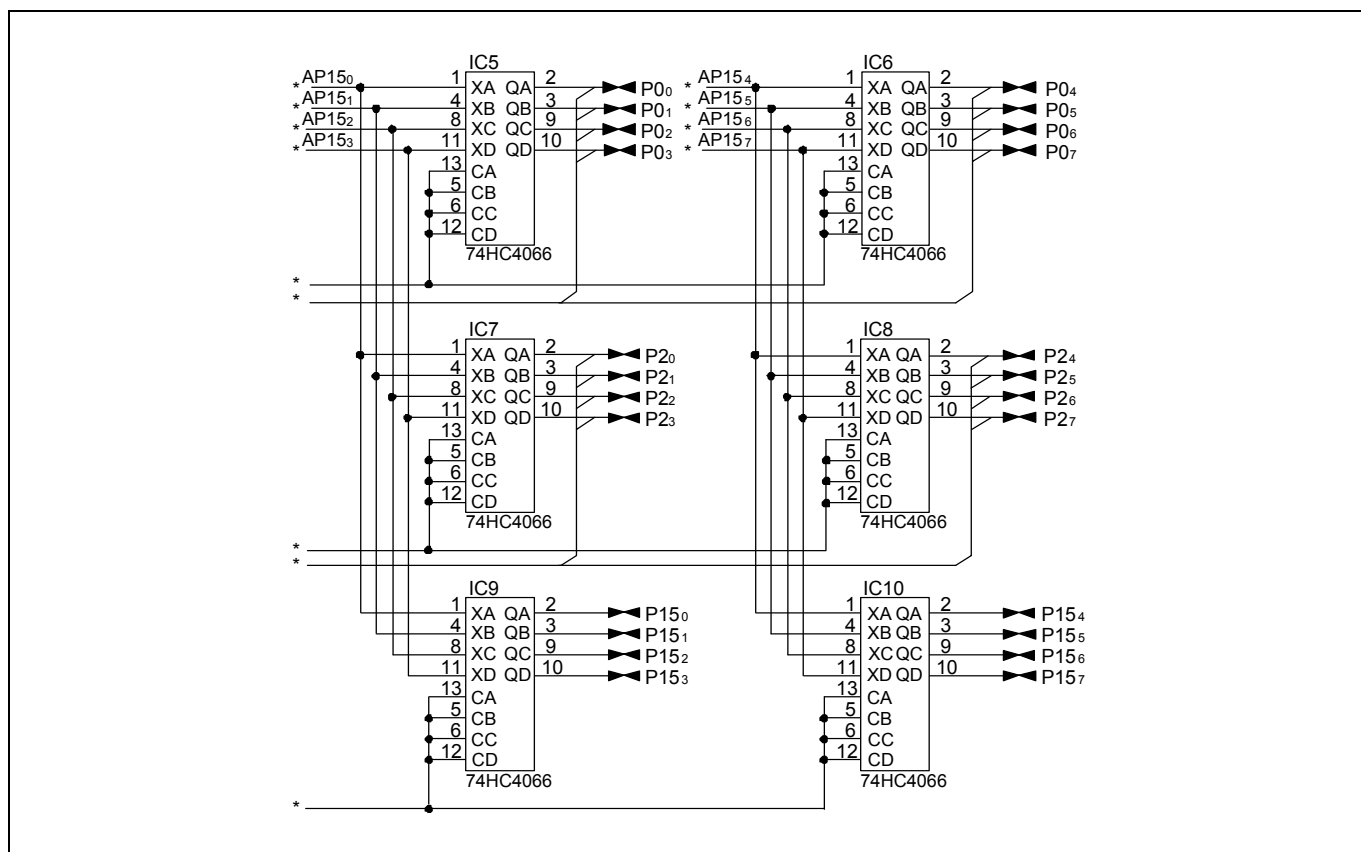

Figure 4.2 Connection diagram (2/2)

Table 4.2 Electrical characteristics of the 74HC4066

Symbol	Item	Condition	Standard values			Unit
			Vcc	Min.	Standard	
RON	ON resistor	2.0	-	160	-	Ω
		4.5	-	70	100	
ΔRON	ON resistor difference	4.5	-	10	-	
IN	Switch input leak current	12.0	-	-	±100	nA

### 4.4 External Dimensions

#### 4.4.1 External Dimensions of the Emulation Probe

Figure 4.3 shows external dimensions of the M30880T-EPB connected with the M30800T-PTC and LCC socket.

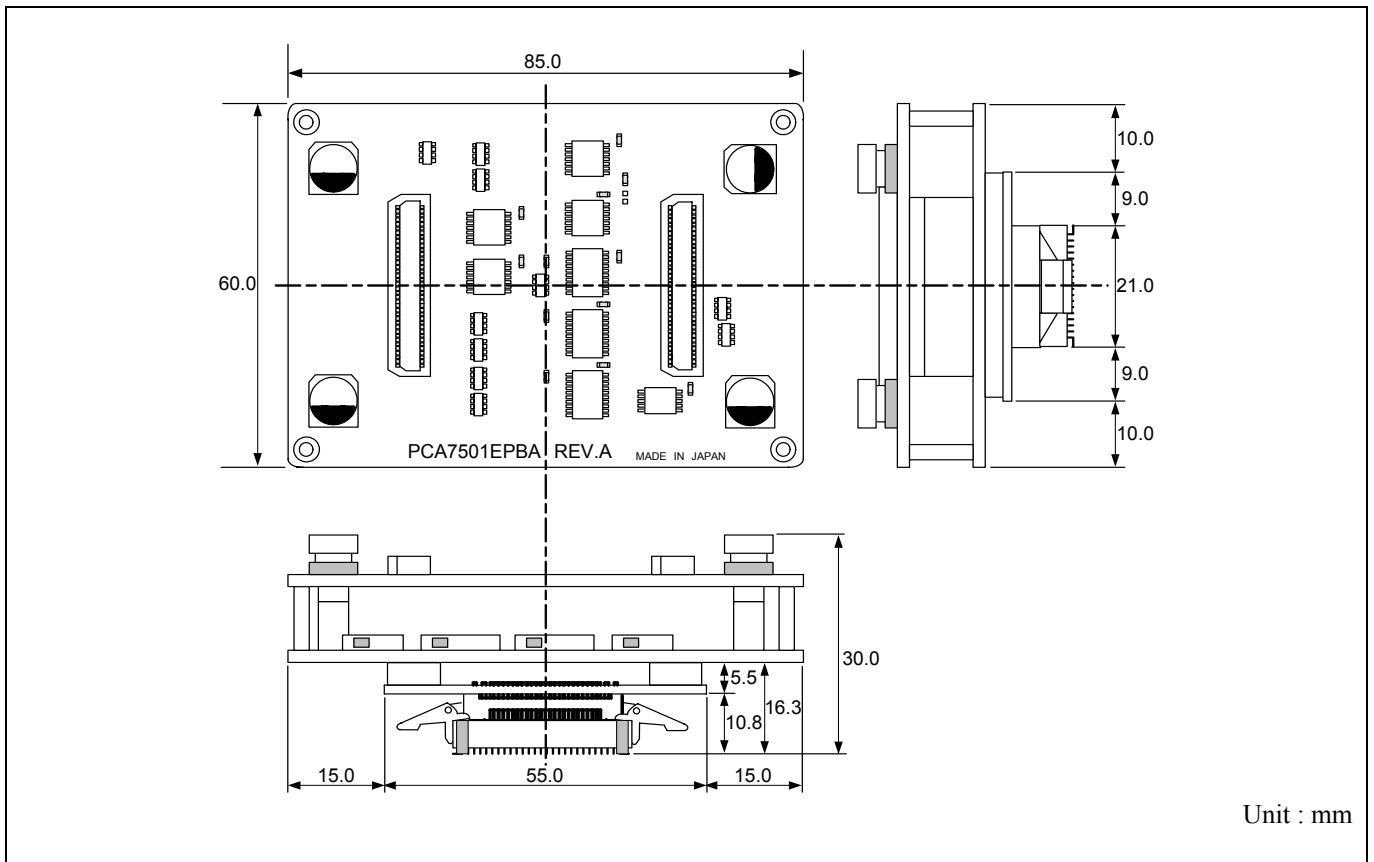

Figure 4.3 External dimensions of the emulation probe

## 4.4.2 External Dimensions of the M30800T-PTC

Figure 4.4 shows external dimensions of the converter board M30800T-PTC for a 100-pin QFP (100P6S).

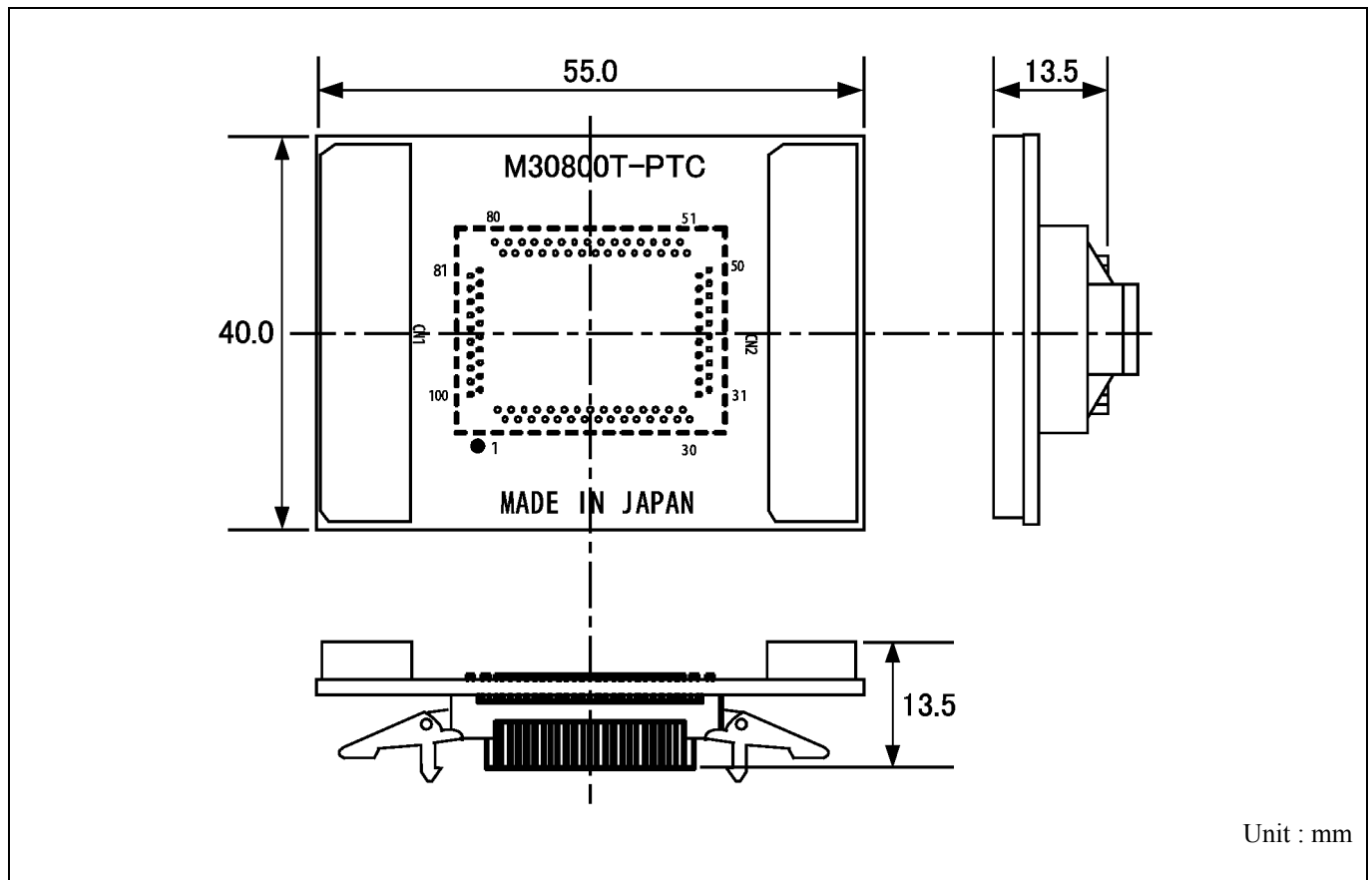

Figure 4.4 External dimensions of the M30800T-PTC

### 4.4.3 External Dimensions of the M3T-F160-100NSD

Figure 4.5 shows external dimensions of the converter board M3T-F160-100NSD for a 100-pin LQFP (100P6Q).

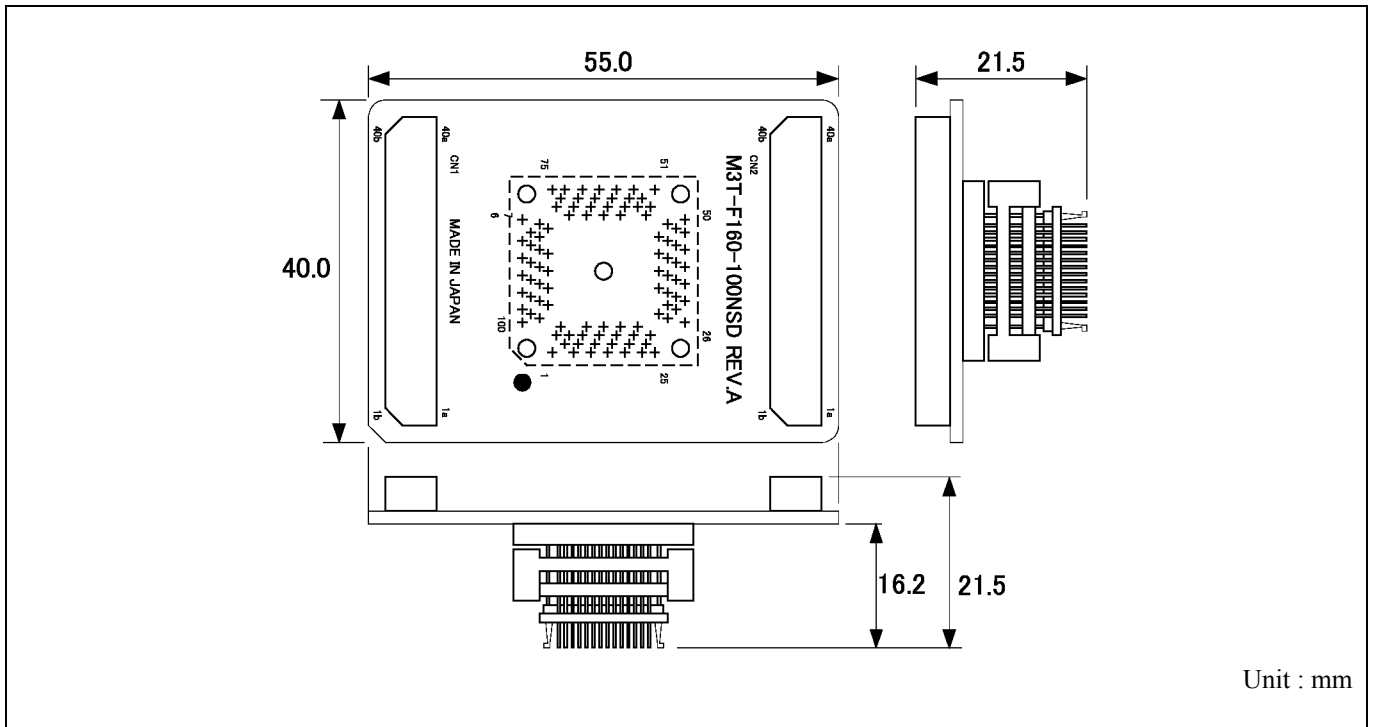

Figure 4.5 External dimensions of the M3T-F160-100NSD

### 4.4.4 External Dimensions of the M3T-FLX-144NSD

Figure 4.6 shows external dimensions of the converter board M3T-FLX-144NSD for a 144-pin LQFP (144P6Q).

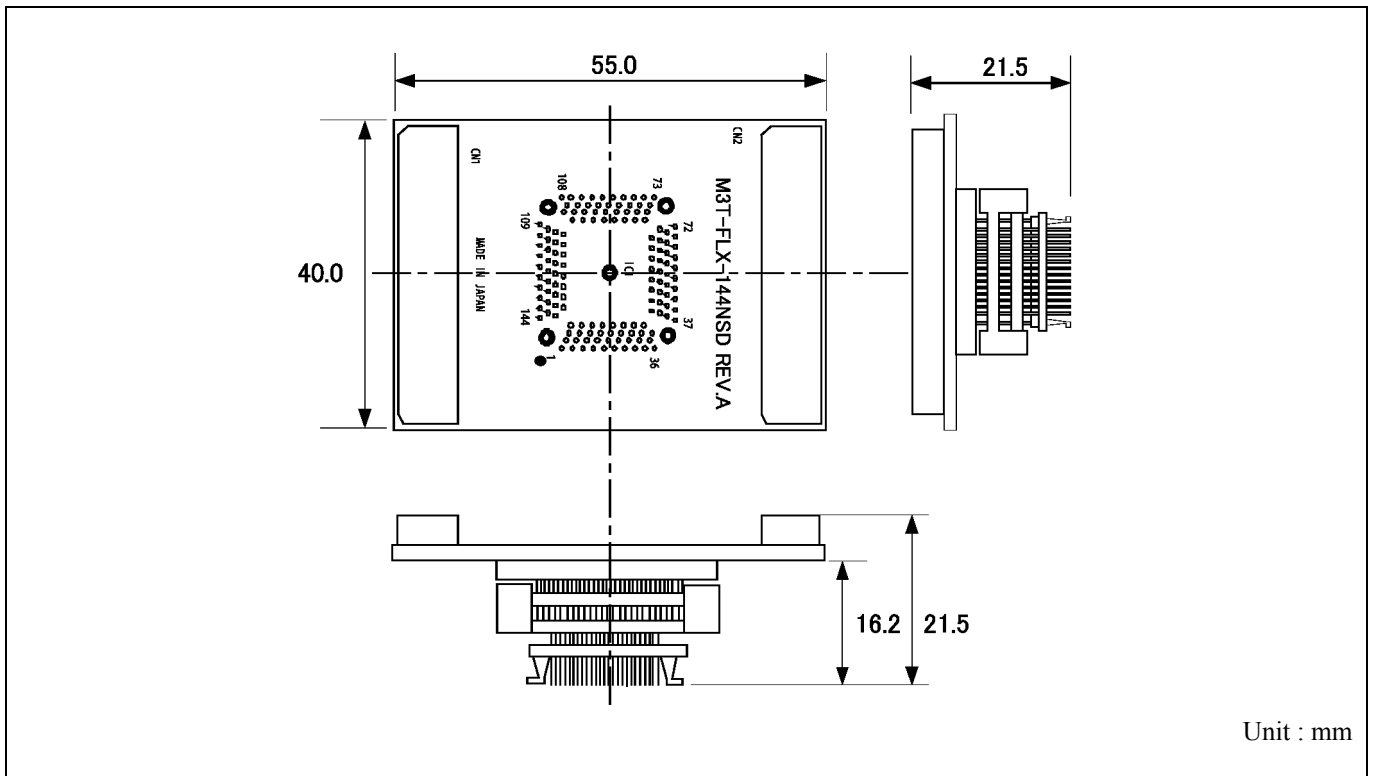

Figure 4.6 External dimensions of the M3T-FLX-144NSD

## 4.5 Notes on Using This Product

Notes on using this product are listed below. Be sure to read these notes before using this product.

### IMPORTANT

#### Notes on Downloading Firmware:

- Before using this product for the first time, it is necessary to download the dedicated firmware (control software built into the PC7501). Please note that, to do this, it is necessary to start up the PC7501 in maintenance mode. For firmware download procedures, see "2.7 Downloading Firmware" (page 26). Once the firmware has been downloaded, the product can be used by simply turning on the power.
- Do not shut off the power while downloading the firmware. If this happens, the product will not start up properly. If power is shut off unexpectedly, redownload the firmware.
- Except when a target status error occurs, if the self-check is not completed successfully, there may be trouble with the product. In such case, contact your sales representative.
- Perform the self-check while not connecting the user system.

#### Note on Quitting the Emulator Debugger:

- To restart the emulator debugger after it ends, always shut power to the emulator module off once and then on again.

#### Notes on Power Supply to the User System:

- Pin Vcc of the emulator is connected to the user system to observe the voltage of the user system. Therefore design your system so that the user system is powered separately.
- The voltage of the user system should be within the following.  
 $4.2\text{ V} \leq \text{VCC1} = \text{VCC2} \leq 5.5\text{ V}$
- Do not change the voltage of the user system after turning on the power.

## IMPORTANT

### Notes on Clock Supply to an MCU:

- Clock can be supplied to the evaluation MCU in one of the following three ways. This is determined by emulator debugger clock selection.
  - (1) When Internal is selected:

The clock generated by the oscillation circuit in the PC7501 is supplied to the evaluation MCU. The clock is continually supplied to the evaluation MCU regardless of "user system clock status" and "user program execution status".
  - (2) When External is selected:

The clock oscillating on the user system is supplied to the evaluation MCU. Clock supply to the evaluation MCU depends on oscillation status (oscillate/off) of the user system.
  - (3) When Generate is selected:

A clock generated by the dedicated circuit in the PC7501 is supplied to the evaluation MCU. The clock is continually supplied to the evaluation MCU regardless of "user system clock status" and "user program execution status".
- When operating this product with a sub clock, be sure to set the SW2 and SW3 to XCIN and NC, respectively.

### Notes on Using the CPU Clock at Less than 10 MHz:

- To use the CPU clock at less than 10 MHz, execute the command shown below in the Script Window after starting the emulator debugger M3T-PD308F.

```
[Command]
    _settimeout ,600
```

Once this command is executed, it remains effective the next time you start the emulator debugger M3T-PD308F. Therefore, you do not need to execute this command again.
- When you use the CPU clock at less than 1 MHz, contact your local distributor.

### Notes on Address-Match Interrupt:

- Do not single-step an address where an address-match interrupt occurs.
- When using an address-match interrupt, do not select the check box of "Enable the Address Match Interrupt Break Function" in the MCU tab of the Init dialog box. When not using an address-match interrupt, select the check box.
- When you use address-match breaks, if a low reset is input during a user program execution, a debug monitor program (about 100 cycles) is executed after a reset is released. Take note that it has effects on the user program execution time and the result of a trace.

## IMPORTANT

### Notes on EMEM Dialog Box:

Observe the following when setting up EMEM dialog box of the emulator debugger.

#### (1) Debug Monitor Bank Address

- The default value of Debug Monitor Bank Address is "F0". To set single-chip mode, internal flash memory is automatically allocated in F000h--FFFFh and F80000h--FFFFFFh.

The specified value becomes effective after restarting the system.

- When "F0" is specified, 64 KB of area starting from F00000h are allocated for use by the debug monitor.
- The 64 KB allocated for the debug monitor cannot be used.
- The below areas cannot be set for the debug monitor.
  - 1) MCU internal resources (ROM/RAM/SFR area)
  - 2) Interrupt vector area
- It is not possible to view or set the content of the specified area. Even on the memory window or in the reverse assemble area of the program/source windows, the content of this area is not displayed correctly though it can be displayed.

#### (2) Processor Mode

- Set a single-chip mode for the target MCU.
- To set single-chip mode, pin CNVSS used with MCU status must be "L". MCU status indicates pin level of the user system.

#### (3) Emulation Memory Allocation

- Because the available processor mode is the single-chip mode only, select the "No Use" in "Map".
- When single-chip mode is set as a processor mode, ROM area is automatically allocated to the internal Flash ROM of an MCU.
- MCU internal resources are automatically selected for SFR, RAM and ROM areas regardless of settings.
- Emulator main unit's memory is automatically selected as a reset vector area regardless of settings.

### Notes on Watchdog Function:

- When using the watchdog function, select the check box of "Debug the program using the Watchdog Timer" in the MCU tab of the Init dialog box. When not using the watchdog function, clear the check box.
- If the reset circuit of the user system has a watchdog timer, disable it when using the emulator.



## IMPORTANT

### Notes on Debugging in CPU Rewrite Mode:

- To debug a program in CPU rewrite mode, select the check box "Debug the program using the CPU Rewrite Mode" in the MCU tab of the Init dialog box. When you do not debug a program in CPU rewrite mode, clear the check box.
- When you debug a program in CPU rewrite mode, the block 0 area (FFF000h--FFFFFFh) must not be rewritten. Otherwise, the emulator will be out of control.
- When debugging in CPU rewrite mode is enabled, you cannot use the following functions.
  - (1) Setting an address match breakpoint
  - (2) Setting a software breakpoint to the internal ROM area
  - (3) Executing COME to the internal ROM area
- Do not use the following functions to the rewrite control program area (from setting CPU rewrite mode select bit to releasing it). If any of these are used, malfunctions may occur (e.g. The emulator cannot shift to CPU rewrite mode or contents of ROM cannot be read out properly.).
  - (1) Single stepping
  - (2) Setting a software breakpoint
  - (3) Setting a hardware breakpoint
  - (4) Executing COME

### Note on Software Break:

- A software break generates a break interruption by forcibly inserting a BRK instruction "08h" instead of an instruction code. Therefore, when referencing the result of a trace in bus mode, "08h" is displayed for the instruction fetch address where a software break is set.

### Note on Downloading Programs:

- When you download a program to an internal ROM area and set software breaks, the main clock operates in divide-by-8 mode. Keep it in mind when you specify a watchdog timer refresh interval.

### Notes on Service-Life of the MCU's Internal Flash ROM:

- With the M30880T-EPB, programs are downloaded to the MCU's flash ROM when debugging in single-chip mode. Because the number of write/erase cycles of this ROM is limited, the ROM must be replaced when at the end of its service-life.
- If the following errors occur frequently during program download, replace the emulation probe or request for repair.
  - (1) Flash ROM erase error occurred ERROR (16258)
  - (2) Flash ROM verify error occurred ERROR (16259)To purchase the product for replacement or request for repair, contact your local distributor.

## IMPORTANT

### Note on Protect Resistor:

- A protect is not canceled when protect register bit 2 (PRC2), which enables writing in the port P9 direction register and the function select register A3, is changed with the below procedure.
  - (1) Step execution of an instruction setting ("1") PRC2
  - (2) Setting a break point from an instruction setting ("1") PRC2 to where the port P9 direction register or the function select register A3 is set
  - (3) Setting ("1") PRC2 from the dump window or script window during user program execution

### Note on Voltage Detect Circuit:

- As the power voltage cannot be changed after powering on the user system, the voltage detect circuit (voltage down detect interrupt and hardware reset 2) cannot be used with this product.

## IMPORTANT

### Notes on A/D Conversion:

- When setting the register below to use the analog input port selection function, you need to set the direction register of port P15 for a pin that performs A/D conversion to "input".

And you need to set the function selection register of port P15 for a pin that performs A/D conversion to "I/O port".

A/D0 control register 2 (address 394h)

b2,	b1	
1,	0	: AN00 to AN07
1,	0	: AN20 to AN27

Also, when the P0 and P2 groups are selected for A/D input, port P15 cannot be used as an I/O port. When setting the register above, port P15 cannot be used as an I/O port even if A/D conversion is halting.

For the switch SW5, refer to "2.10.1 Setting Switches of Emulation Probe" (page 38).

- When setting the register below to use multi-port sweep mode, you need to set the direction register of port P15 for a pin that performs A/D conversion to "input".

And you need to set the function selection register of port P15 for a pin that performs A/D conversion to "I/O port".

A/D0 control register 4 (address 392h)

b3,	b2	
1,	0	: AN0 to AN7, AN00 to AN07
1,	0	: AN0 to AN7, AN20 to AN27

Also, when the P0 and P2 groups are used for multi-port sweep mode, port P15 cannot be used as an I/O port. When setting the register above, port P15 cannot be used as an I/O port even if A/D conversion is halting.

- Because a converter board and other devices are used between the evaluation MCU and the user system, the A/D converter operates differently from an actual MCU. Make the final evaluation of the A/D converter using an actual MCU.

## 5. Troubleshooting

This chapter describes how to troubleshoot when this product does not work properly.

### 5.1 Flowchart to Remedy the Troubles

Figure 5.1 shows the flowchart to remedy the troubles from when power to the emulator is activated until the emulator debugger starts up. Check this while the user system is disconnected. For the latest FAQs visit the Renesas Tools Homepage.

<http://www.renesas.com/en/tools>

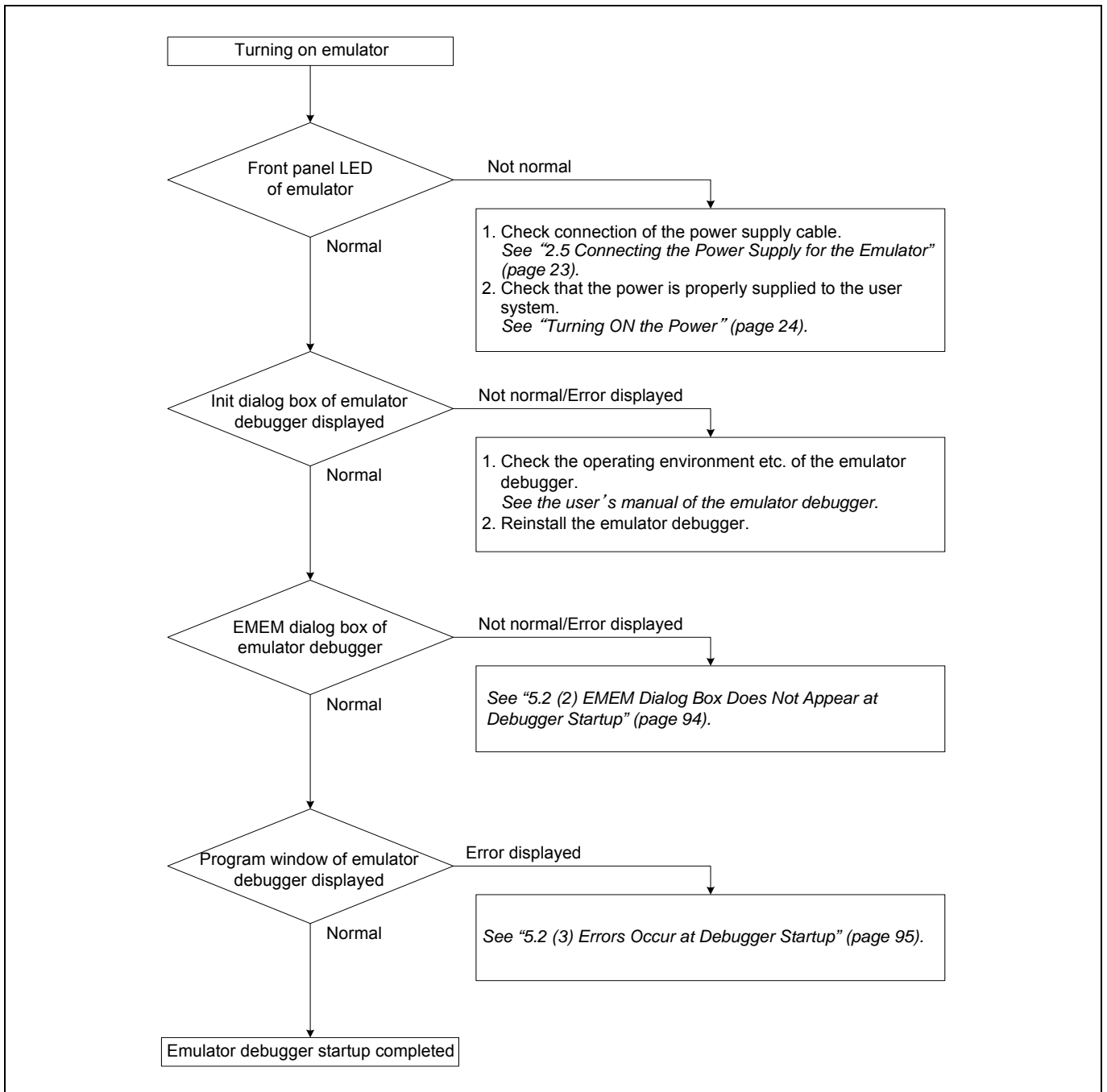

Figure 5.1 Flowchart to remedy the troubles

## 5.2 When the Emulator Debugger Does Not Start Up Properly

### (1) When the LEDs of the PC7501 Do Not Display Normally

Table 5.1 Errors LEDs show and their checkpoints

Error	Connection to the user system	Checkpoint
LEDs do not light up.	-	Check that the power cable is connected. <i>See "2.5 Connecting the Power Supply for the Emulator" (page 23) and the user's manual of the PC7501.</i>
All LEDs remain lit.	-	Recheck the connection between the PC7501 and this product. <i>See "2.4 Connecting the PC7501" (page 22).</i>
The POWER LED of "STATUS OF TARGET" does not light up.	Connected	Check that power (Vcc) is properly supplied to the user system and that the user system is properly grounded.
The CLOCK LED of "STATUS OF TARGET" does not light up.	Not connected	(1) Check that both the main and sub clocks of the emulator debugger are not set to "EXT". <i>See the CLK command of the emulator debugger.</i> (2) Check the oscillation circuit in the emulator is oscillating. <i>See "2.10.2 Selecting Clock Supply" (page 42).</i>
	Connected	(1) When the clock is supplied from an external oscillator, check that the oscillator circuit in the user system is oscillating properly. (2) Check the switches in the emulation probe is properly set. <i>See "2.10.1 Setting Switches of Emulation Probe" (page 38).</i>
The RESET LED of "STATUS OF TARGET" does not go out.	Connected	Check that the reset pin of the user system is pulled up.

## (2) EMEM Dialog Box Does Not Appear at Debugger Startup

Table 5.2 Checkpoints of errors at debugger startup

Error	Checkpoint
Communication error occurred. Data was not sent to the target.	Check all emulator debugger settings, interface cable settings and switches on the rear of the PC7501 match. <i>See the user's manuals of PC7501 and emulator debugger.</i>
User system cannot be properly built.	(1) Download the proper firmware. <i>See "2.7 Downloading Firmware" (page 26).</i> (2) Recheck the connection between the PC7501 and this product. <i>See "2.4 Connecting the PC7501" (page 22).</i>
M3T-PD308F version is not the same version as the firmware in the target.	Download the proper firmware. <i>See "2.7 Downloading Firmware" (page 26).</i>
Target MCU is in the reset state.	(1) Check the reset pin of the user system is pulled up. (2) Check the reset pin of the user system has changed from "L" to "H" level.
Target MCU cannot be reset.	(1) Check pin NMI* is held high. (2) If the reset circuit of the user system has a watchdog timer, disable the watchdog timer. (3) Check that power is properly supplied to the user system and that the user system is properly grounded. (4) The program may be uncontrollable in areas where memory is not allocated.
Target is in "HOLD" state.	(1) The MCU is either in stop mode or wait mode. Either reset the MCU or cancel the mode with an interrupt. <i>See MCU specifications.</i> (2) The program may be uncontrollable in areas where memory is not allocated. Recheck the map setting.
Target clock is stopped.	(1) When the clock is supplied from an external oscillator, check that the oscillator circuit in the user system is oscillating properly. (2) Check the switches in the emulation probe are correctly set. <i>See "2.10.1 Setting Switches of Emulation Probe" (page 38).</i>
Target MCU is not receiving power.	Check that power is properly supplied to the user system and that the user system is properly grounded.

## (3) Errors Occur at Debugger Startup

Table 5.3 Checkpoints of errors at debugger startup

Error	Checkpoint
Target MCU is uncontrollable.	<ul style="list-style-type: none"><li>(1) Check that the NQPACK etc. mounted on the user system is soldered properly.</li><li>(2) Check that the connector is installed properly to the user system.</li><li>(3) Check pin NMI* is held high.</li><li>(4) The program may be uncontrollable in areas where memory is not allocated.</li></ul>

### 5.3 How to Request for Support

After checking the items in "5 Troubleshooting", fill in the text file the installer of the emulator debugger generates in the following directory and email to your local distributor.

\\SUPPORT\product-name\SUPPORT.TXT

For prompt response, please specify the following information:

(1) Operating environment

- Operating voltage: \_\_\_\_\_ [V]
- Operating frequency: \_\_\_\_\_ [MHz]
- Clock supply to the MCU: Internal oscillator/External oscillator

(2) Condition

- The emulator debugger starts up/does not start up
- The error is detected/not detected in the self-check
- Frequency of errors: always/frequency ( \_\_\_\_\_ )

(3) Problem



## 6. Maintenance and Guarantee

This chapter describes how to maintenance, repair provisions and how to request for repair.

### 6.1 User Registration

When you purchase our product, be sure register as a user. For user registration, refer to "User registration" (page 11) of this user's manual.

### 6.2 Maintenance

- (1) If dust or dirt collects on any equipment of your emulation system, wipe it off with a dry soft cloth. Do not use thinner or other solvents because these chemicals can cause the equipment's surface coating to separate.
- (2) When you do not use this product for a long period, for safety purposes, disconnect the power cable from the power supply.

### 6.3 Guarantee

If your product becomes faulty within one year after its purchase while being used under good conditions by observing "IMPORTANT" and "Precautions for Safety" described in this user's manual, we will repair or replace your faulty product free of charge. Note, however, that if your product's fault is raised by any one of the following causes, we will repair it or replace it with new one with extra-charge:

- Misuse, abuse, or use under extraordinary conditions
- Unauthorized repair, remodeling, maintenance, and so on
- Inadequate user's system or misuse of it
- Fires, earthquakes, and other unexpected disasters

In the above cases, contact your local distributor. If your product is being leased, consult the leasing company or the owner.

### 6.4 Repair Provisions

#### (1) Repair with extra-charge

The products elapsed more than one year after purchase can be repaired with extra-charge.

#### (2) Replacement with extra-charge

If your product's fault falls in any of the following categories, the fault will be corrected by replacing the entire product instead of repair, or you will be advised to purchase new one, depending on the severity of the fault.

- Faulty or broken mechanical portions
- Flaw, separation, or rust in coated or plated portions
- Flaw or cracks in plastic portions
- Faults or breakage caused by improper use or unauthorized repair or modification
- Heavily damaged electric circuits due to overvoltage, overcurrent or shorting of power supply
- Cracks in the printed circuit board or burnt-down patterns
- Wide range of faults that makes replacement less expensive than repair
- Unlocatable or unidentified faults

(3) Expiration of the repair period

When a period of one year elapses after the model was dropped from production, repairing products of the model may become impossible.

(4) Transportation fees at sending your product for repair

Please send your product to us for repair at your expense.

## 6.5 How to Make Request for Repair

If your product is found faulty, follow the procedure below to send your product for repair.

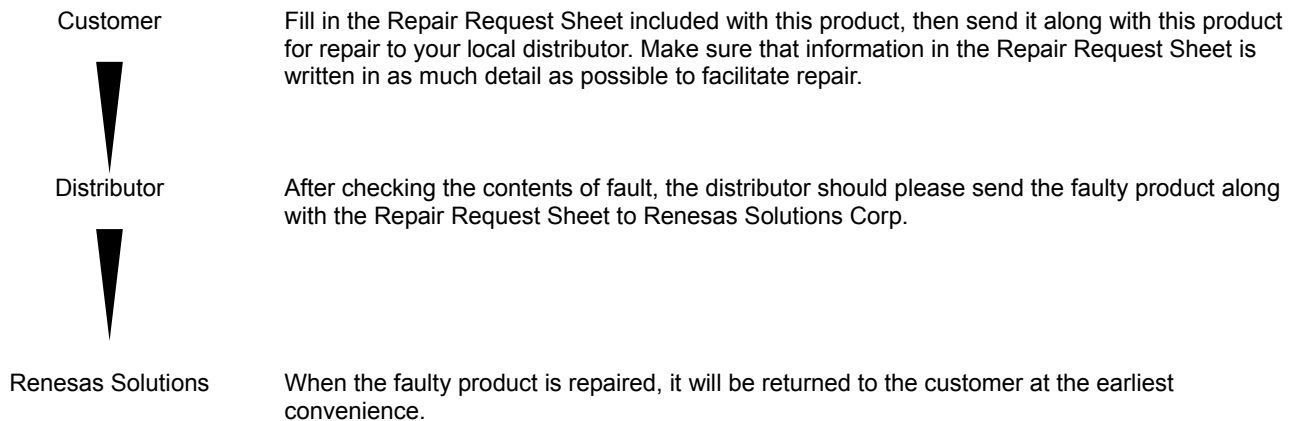

### CAUTION

#### Note on Transporting the Product:

- When sending your product for repair, use the packing box and cushion material supplied with this product when delivered to you and specify handling caution for it to be handled as precision equipment. If packing of your product is not complete, it may be damaged during transportation. When you pack your product in a bag, make sure to use conductive polyvinyl supplied with this product (usually a blue bag). When you use other bags, they may cause a trouble on your product because of static electricity.

---

Emulation Probe for M32C/88 Group  
M30880T-EPB User's Manual

Publication Date: Jan. 16, 2005                      Rev.1.00

Published by:                      Sales Strategic Planning Div.  
    Renesas Technology Corp.

Edited by:                              Microcomputer Tool Development Department  
    Renesas Solutions Corp.

---

© 2005. Renesas Technology Corp. and Renesas Solutions Corp., All rights reserved. Printed in Japan.

M30880T-EPB  
User's Manual

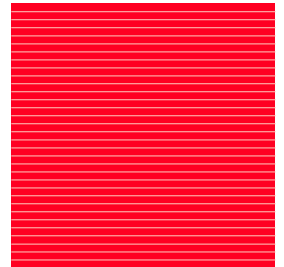

**Renesas Technology Corp.**

2-6-2, Ote-machi, Chiyoda-ku, Tokyo, 100-0004, Japan

Download from [www.somanuals.com](http://www.somanuals.com). All Manuals Search And Download.

## Free Manuals Download Website

<http://myh66.com>

<http://usermanuals.us>

<http://www.somanuals.com>

<http://www.4manuals.cc>

<http://www.manual-lib.com>

<http://www.404manual.com>

<http://www.luxmanual.com>

<http://aubethermostatmanual.com>

Golf course search by state

<http://golfingnear.com>

Email search by domain

<http://emailbydomain.com>

Auto manuals search

<http://auto.somanuals.com>

TV manuals search

<http://tv.somanuals.com>