

Applications Engineering



ZigBee Demo Kit (ZDK) RZB-ZMD16C-ZDK

User's Manual

Version 1.2
August 2006

Table of Contents

1.0 Introduction	4
2.0 Contents of Product Package	5
2.1. RZB-ZMD16C-ZDK ZigBee Demonstration Kit Item List.....	5
2.2. CD-ROM	5
3.0 Limited Guarantee and Support	6
4.0 System Connectivity	7
4.1. Host Computer Requirements	8
4.2. RZB-ZMD16C-ZDK Boards	8
4.3. RF Sniffer Board	8
4.4. RF Sniffer Interface (RFSI).....	9
4.5. RF Sniffer Software and USB Driver	9
4.6. In-Circuit Debugger and Programmer (ICD).....	9
4.7. Software Development Tools	9
4.7.1. HEW (High-performance Embedded Workshop).....	9
4.7.2. NC30WA Evaluation Version C Compiler	9
4.7.3. HEW Debug Interface	9
4.7.4. FoUSB (Flash-over-USB™) Programmer	10
5.0 Hardware	11
5.1. ZDK Board (RZB-ZMD16C-ZDK)	11
5.2. RZB-ZMD16C-ZDK Board Block Diagram	12
5.3. M16C/28 Group of MCUs	12
5.4. RZB-ZMD16C-ZDK Board Jumper Configuration	12
5.4.1. JP1: MCU (U4) Power.....	12
5.4.2. JP2: Power LED (D4) and RS232 (U7) Transceiver Power.....	13
5.4.3. Default Jumper Settings	13
5.5. LCD (Liquid Crystal Display)	13
5.6. ZigBee RF.....	13
6.0 Limitations of the ZbRom System.....	13
6.1. Timers	13
6.2. System Clock	14
6.3. Interrupts.....	14
6.4. Flash and RAM Usage	14
6.5. Stack RAM Usage	14
6.6. Global Variable RAM Usage.....	15
6.7. MAC Address Area	15
6.8. ZbROM Flash Size	15
6.9. ZbROM RAM Size	15
6.10. ZigBee Stack Table Sizes	15
6.11. Customization of Demo Program Settings	16
6.12. Other Limitations.....	16
7.0 System Operation & Limitations	17
7.1. Kernel (ROM Monitor) Introduction.....	17
7.2. Pin and Peripheral Limitations	17
7.3. Memory Map	17
7.4. Register Operation Limitations	18
7.5. Limitations on Interrupts - Vectors that Reside in the Hardware Vector Table	18
7.6. Stop or Wait Mode Limitations.....	19
7.7. User Program's Real-Time Capability	19
7.8. Performing Debug Using Symbols	19
8.0 RZB-ZMD16C-ZDK Board Specifications	20
8.1. Hardware Specifications	20
8.2. Power Supply Requirements	20

8.3. Operating Environment.....	20
Appendix A. Troubleshooting Guide.....	21
A.1 Manual Installation	21
A.2 USB Driver Problems	21
A.3 Debugging Problems.....	22
A.3.1 Erratic Debug Behavior.....	22
A.3.2 Cannot Connect to Target.....	22
A.3.3 Issues that May Arise During Debug Operations	23
Appendix B. Reference Manuals	25
Appendix C. Expansion Headers.....	26
Appendix D. Board Schematic & BOM.....	28
Appendix E. RZB-ZMD16C-ZDK Printed Circuit Board.....	31
Appendix F. Other Resources	33

1.0 Introduction

The RZB-ZMD16C-ZDK kit is a low-cost ZigBee demonstration kit for evaluating wireless ZigBee connectivity solutions based on the Renesas M16C/28 group of microcontrollers (MCU).

A small ZigBee Personal Area Network (PAN) can be set up, monitored and analyzed with the included hardware and software.

The kit contains one RF Sniffer board that connects to a PC's USB port via an RTA-FoUSB-MON unit, which comes pre-programmed to function as the RF Sniffer Interface (RFSI). RF Sniffer software installed on the PC allows you to record and analyze ZigBee data packets. The software can also display the network topology of a ZigBee network. For more information on the RF Sniffer software and hardware, see the RF Sniffer User's Manual, accessible via Start > (All) Programs > Renesas > RF SnifferV.x.xx

A second RTA-FoUSB-MON unit included in the kit comes pre-programmed to function as a Flash Programmer and In-Circuit-Debugger (ICD). Three ZigBee Demonstration Kit (ZDK) boards come pre-programmed with demo software that allows you to quickly set up a small ZigBee PAN comprised of a ZigBee network Coordinator and two ZigBee network Routers.

The kit comes with a complete software development tool chain for Renesas MCUs, including High-performance Embedded Workshop (HEW), which includes Integrated Development Environment (IDE), Graphical User Interface (GUI) and Software Debugger; NC30WA C-compiler, assembler and linker; and Flash-over-USB™ (FoUSB) Programming software.

A real-time, source-level debug environment is implemented using the HEW debugging interface with the RTA-FoUSB-MON Flash Programmer/ICD. The Flash-over-USB™ (FoUSB) Programmer software, in combination with the ICD, allows in-system programming of the M16C/28 Flash MCUs on the ZDK and RF Sniffer target boards.

The ICD and firmware provide a convenient Universal Serial Bus (USB) interface between the ZDK boards and the host PC. This interface reduces resource requirements on the M16C/28 MCU and allows faster code downloads. It also can be used with many other Renesas Flash MCUs, starter kits, and your own Renesas MCU-based target boards.

This ZDK provides a ZigBee stack and a real-time operating system (RTOS) for the stack in binary form. Your own application code can interface to the ZigBee stack via documented Application Programming Interface (API) function calls. Two binary files are provided in the directory `C:\Renesas\RZB_ZMD16C_ZDK\ZbRom:`

`ZbRom_ZMD28_FFD_Vxx.mot` contains the ZigBee stack and RTOS for Full Function Devices (FFD), i.e. ZigBee Routers or Coordinators. The module also contains all necessary MCU initialization routines.

`ZbRom_ZMD28_RFD_Vxx.mot` contains the ZigBee stack and RTOS for Reduced Function Devices (RFD), i.e. ZigBee End Devices. It has a smaller memory footprint than the FFD binary, leaving more memory available for your own application code. The module also contains all necessary MCU initialization routines.

Sample projects for the Renesas High-performance Embedded Workshop (HEW) allow you to quickly create your own ZigBee coordinator, router or end device.

2.0 Contents of Product Package

This section describes the contents of the RZB-ZMD16C-ZDK product package. When unpacking your RZB-ZMD16C-ZDK, please check to see that all items listed below are included.

2.1. RZB-ZMD16C-ZDK ZigBee Demonstration Kit Item List

Table 2-1 lists the items included in the RZB-ZMD16C-ZDK.

Table 2-1 RZB-ZMD16C-ZDK Item List

Item Name	Quantity	Remarks
RZB-ZMD16C-ZDK Board	3	ZigBee Demo Kit (ZDK) Boards, pre-programmed with demo software
RF Sniffer Board	1	RF Sniffer Board, pre-programmed with Sniffer firmware
RTA-FoUSB-MON (ICD)	1	In-Circuit Debugger and Flash Programmer Interface
RTA-FoUSB-MON (RFSI)	1	RF Sniffer Interface
6" 10-Pin Target Cable	2	Connects ICD and RFSI units to ZDK and RF Sniffer boards
6' Mini USB Cable	2	Connects ICD and RFSI units to Host PC
Battery Pack with 3 AA batteries	3	Powers the three ZDK boards
CD-ROM		Auto-install program RF Sniffer software HEW (IDE & debugger) NC30WA (C-compiler, assembler, and linker) FoUSB Programmer USB drivers Manuals Tutorials Sample programs

2.2. CD-ROM

The CD-ROM contains the electronic manuals and software necessary for developing programs. Your computer must have a web browser — like Mozilla Firefox, Netscape® Browser or Microsoft® Internet Explorer — to view the help files, and Adobe® Acrobat® Reader® to view the manuals.

Insert the enclosed CD into your computer and the installer will auto-start. The installer program will create C:\Renesas and C:\Workspace folders on your machine. NC30WA, FoUSB Programmer, Documentation, sample code, and other ZDK-related files are in the C:\Renesas folder. HEW is installed in the C:\Program Files folder by default.

If the installer program does not start, browse to the CD's root folder and double-click on ZDK_Installer.exe to start the installation.

3.0 Limited Guarantee and Support

Renesas Technology America, Inc., warrants the RZB-ZMD16C-ZDK to be free from component or assembly defects for a period of 180 days from the date of purchase. Settlement is limited to repair or replacement of the product only. Renesas Technology America, Inc., does not assume any liability arising out of the application or use of any product, circuit or procedure described herein. No other liability or warranty applies, expressed or implied. Software warranty is limited to replacement of the CD only. While every attempt has been made to ensure accurate documentation, Renesas Technology America, Inc., cannot be held responsible for errors or omissions, and reserves the right to make changes without prior notice.

“Flash-Over-USB” is a trademark of Renesas Technology America, Inc. All other trademarks are the properties of their respective owners.

4.0 System Connectivity

The following lists the hardware and software products required for using the RZB-ZMD16C-ZDK ZigBee Demonstration Kit.

- Host Computer (supplied by user)
- Three RZB-ZMD16C-ZDK Boards
- Three battery packs with AA batteries
- RF Sniffer Board
- RF Sniffer Interface (RFSI)
- Mini USB cable for RFSI
- 2×5 header target cable for RFSI
- RF Sniffer software and USB driver

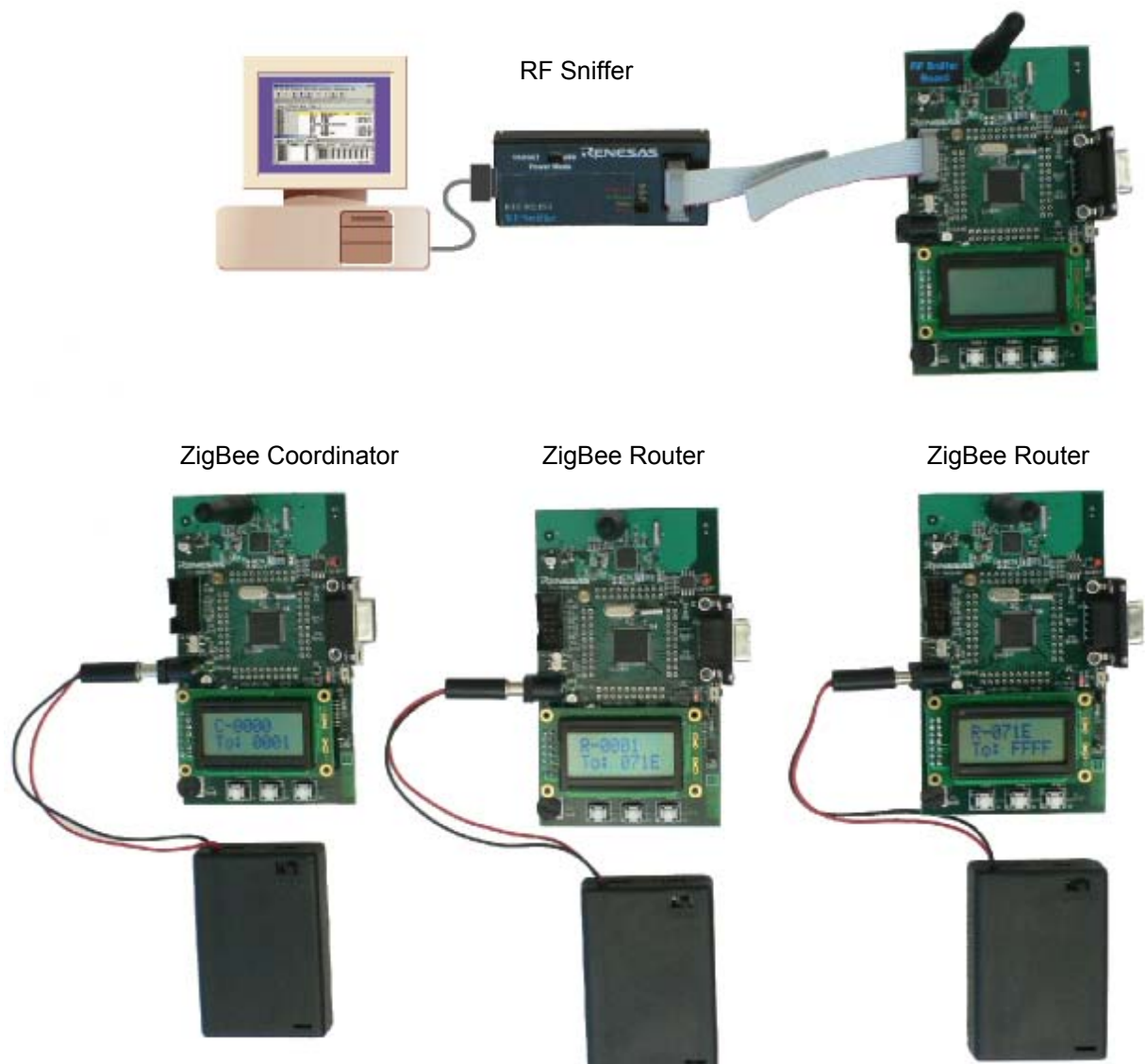

Figure 4.1: ZigBee Demo Kit Setup

Optional (only required if you want to update firmware and/or develop code).

- In-Circuit Debugger and Programmer (ICD)
- Mini USB cable for ICD
- 2×5 header target cable for ICD
- Software Tools (HEW IDE, NC30 Compiler/Linker, FoUSB Programmer)

Figure 4-2 shows an ICD unit connected to a PC via USB and to a ZDK board via 2×5-pin ribbon cable.

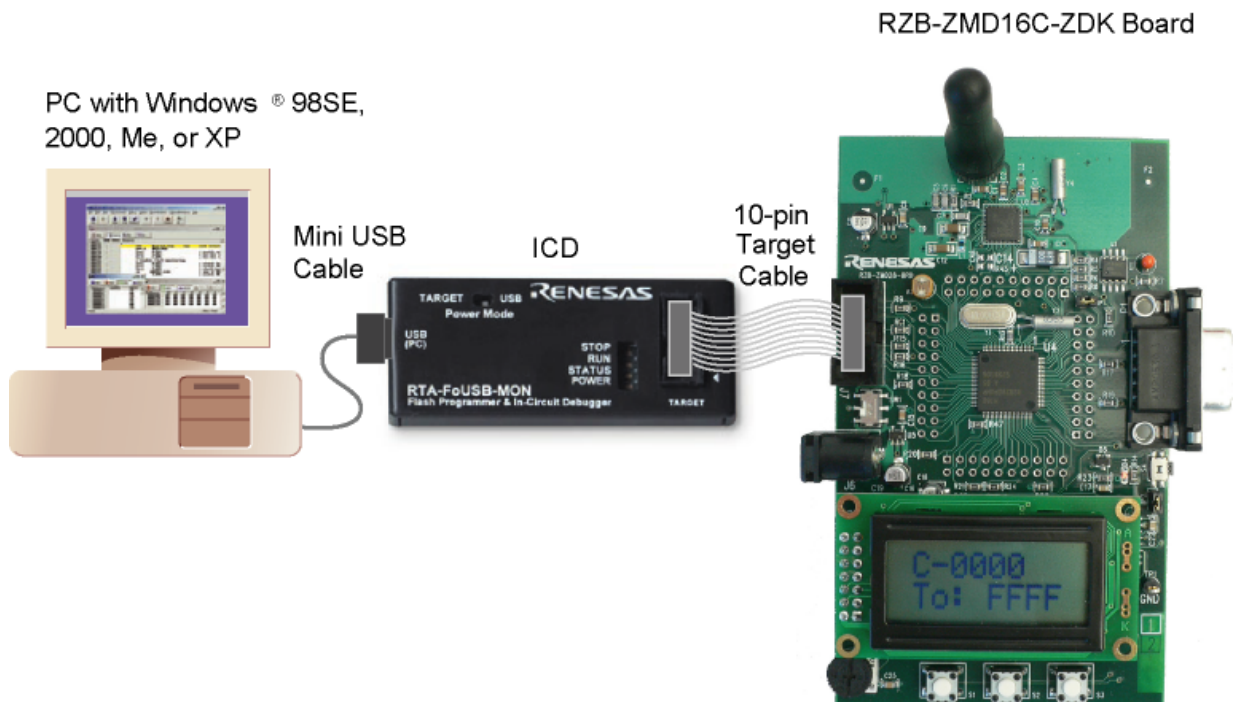

Figure 4-2 ZDK Development System Connectivity

4.1. Host Computer Requirements

The minimum requirement to be able to use the software that comes with the RZB-ZMD16C-ZDK is a PC with a USB port and Microsoft Windows 98, ME, 2000, or XP.

4.2. RZB-ZMD16C-ZDK Boards

The three RZB-ZMD16C-ZDK boards are pre-programmed with ZigBee demo firmware to provide a demo and evaluation environment for wireless ZigBee connectivity based on Renesas MCUs. See section “5.0 Hardware” for more details.

4.3. RF Sniffer Board

The RF Sniffer board is based on the same hardware as the ZDK demo boards, but is pre-programmed with a different firmware to function as a ZigBee RF Sniffer. See section “5.0 Hardware” for more details.

on the board hardware, and the RF Sniffer User's Manual for more information on RF Sniffer usage and features.

4.4. RF Sniffer Interface (RFSI)

The RF Sniffer interface is an RTA-FoUSB-MON unit that comes pre-programmed with firmware to allow the RF Sniffer software running on the Host PC to take control of the RF Sniffer board. The RFSI connects to the PC's USB port via the included mini USB cable, and to the RF Sniffer board via the included 2×5-header ribbon cable. The USB port also provides power to the RF Sniffer board and RFSI, thereby eliminating the need for an external power supply.

4.5. RF Sniffer Software and USB Driver

The installer program offers you the option to install the ZDK demo software tools and the RF Sniffer software. For details on installation, see the QuickStart Guide or instructions in the Appendix A of this manual.

4.6. In-Circuit Debugger and Programmer (ICD)

The ICD provides a plug-and-play debugging and programming interface to the ZDK board via the host computer's Universal Serial Bus (USB). The USB port also provides power to the ZDK boards and ICD, thereby eliminating the need for an external power supply. Use of the ICD is required only if you need to update the firmware of the kit's boards, or if you intend to develop and debug your own software. If not powered by the ICD, the kit's ZDK boards can be powered by the included battery packs.

4.7. Software Development Tools

The installer program offers you the option to install all the development tools. For details on installation, see the QuickStart Guide or instructions in Appendix A of this manual. A brief description of all the included tools follows. Please refer to the individual tool manuals for detailed information.

4.7.1. HEW (High-performance Embedded Workshop)

HEW provides a Graphical User Interface (GUI) that integrates the software development tools and includes the C-compiler, assembler, linker, debugger and editor.

4.7.2. NC30WA Evaluation Version C Compiler

The evaluation version of the M3T-NC30WA C-compiler is provided with the same functionality as the commercial version except that link size will be restricted to 64 Kbytes after 60 days from when you begin using the compiler. Contact your local sales representative if you wish to purchase a full license.

4.7.3. HEW Debug Interface

HEW communicates with a kernel (i.e. a ROM monitor program) on the target MCU through the ICD. This debug interface provides a highly efficient evaluation environment. Features include:

- Source-level debugging for assembly and C language
- Single-step command (unlimited breakpoints)
- Run command with 6 breakpoints* for the M16C/28
- RAM monitor function
- C variable "watch" window

*Note: The number of breakpoints will vary depending on the M16C flash MCU used.

4.7.4. FoUSB (Flash-over-USB™) Programmer

The Flash Over USB Programmer application provides In-System Programming capability for the starter kit or any target board using an M16C family flash MCU (e.g. R8C, M16C, M32C). Please see the RTA-FoUSB-MON User's Manual for more details.

5.0 Hardware

5.1. ZDK Board (RZB-ZMD16C-ZDK)

Note: The RZB-ZMD16C-ZDK board is referred to as RZB-ZMD28-BRD on the board's silkscreen and schematic drawing.

Figure 5-1 shows the RZB-ZMD16C-ZDK Board with major components identified.

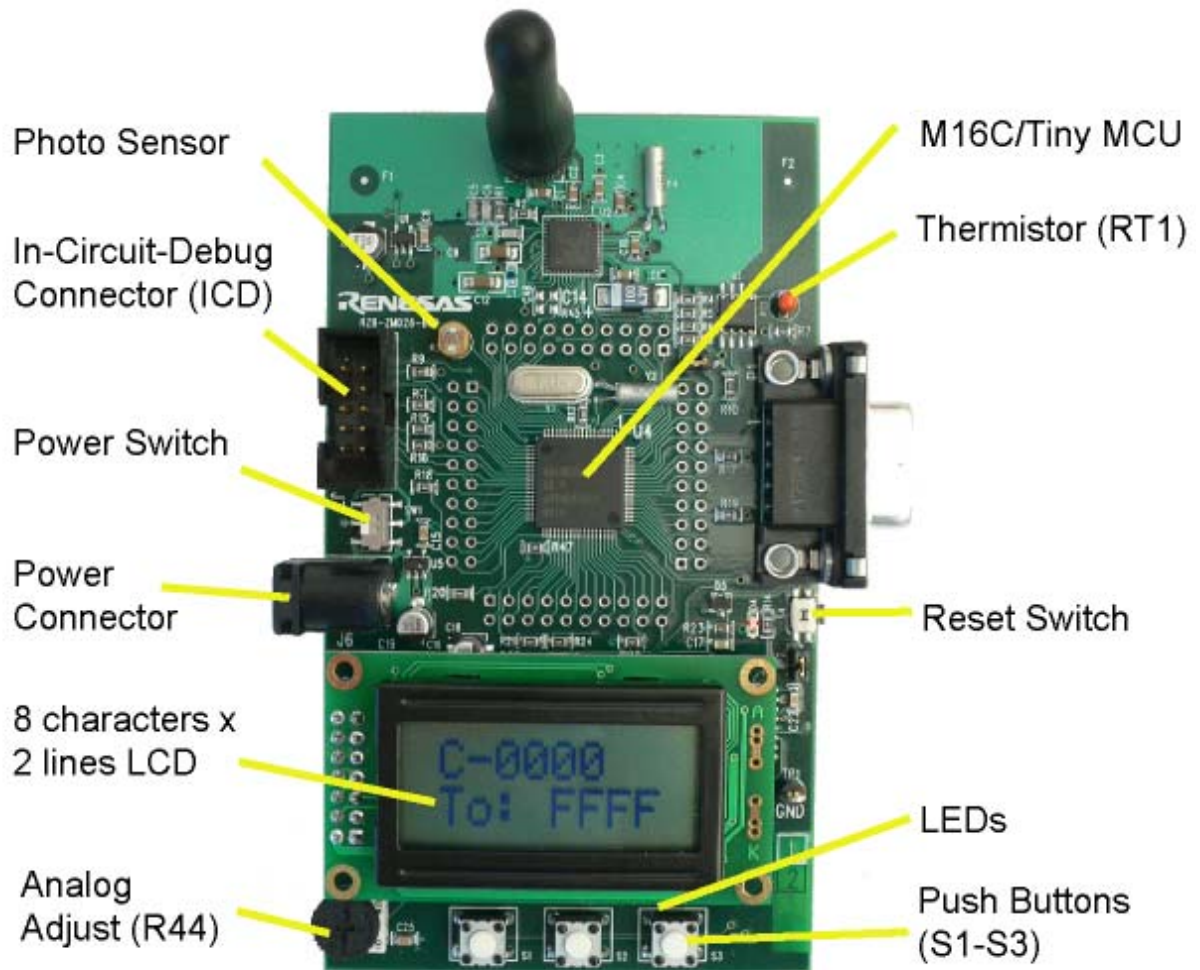

Figure 5.1: RZB-ZMD16C-ZDK Board

5.2. RZB-ZMD16C-ZDK Board Block Diagram

The RZB-ZMD16C-ZDK board incorporates an M30280FAHP (80-pin QFP) from the M16C/28 group of microcontrollers designated as U4. Figure 5-2 shows the RZB-ZMD16C-ZDK block diagram.

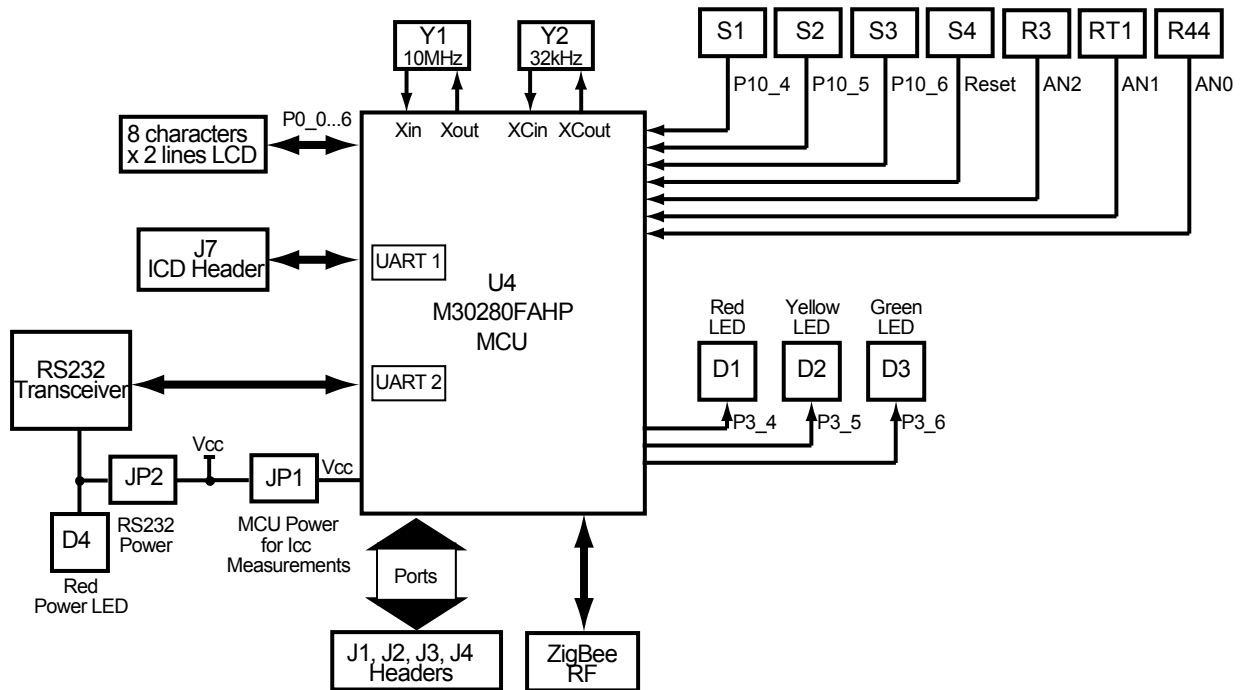

Figure 5-2: RZB-ZMD16C-ZDK Block Diagram

5.3. M16C/28 Group of MCUs

The M3028x group of 16-bit single-chip, flash microcontrollers (MCU) is part of the M16C/60 series CPU core. The hardware and software manuals for the M16C/28 group of microcontrollers can be found under C:\Renesas\RZB_ZMD16C_ZDK\Docs folder on your PC or from the Start menu (Start > Programs > Renesas > RZB_ZMD16C_ZDK > All Manuals and Documents) after ZDK software installation.

5.4. RZB-ZMD16C-ZDK Board Jumper Configuration

5.4.1. JP1: MCU (U4) Power

JP1 is used to connect the Vcc pins of the M16C/28 MCU to the 3.3V supply of the board. It can be used to measure current/power consumption of the MCU during various modes of operation. For normal operations, JP1 must be shorted.

JP1 is shorted by default.

5.4.2. JP2: Power LED (D4) and RS232 (U7) Transceiver Power

JP2 is used to connect the Vcc pin of the RS232 transceiver chip (U7) to the 3.3V supply of the board. It also connects the red Power LED (D4) to the board's supply. It can be used to reduce the board's power consumption by disconnecting the RS232 transceiver and Power LED. For normal operations, JP2 must be shorted.

JP2 is shorted by default.

5.4.3. Default Jumper Settings

Table 5-1: Default Jumper Settings

Jumper	Default Setting
JP1: MCU Power	Shorted
JP2: Power LED and RS232 Power	Shorted

5.5. LCD (Liquid Crystal Display)

The LCD is a 2-line by 8-character display with a KS0066 controller IC.

5.6. ZigBee RF

The ZigBee RF circuit utilizes a ZMD 44102, 900MHz, IEEE 802.15.4 compliant transceiver IC.

6.0 Limitations of the ZbRom System

The following is a list of limitations for the ZbRom system. Due to the nature of this evaluation system, the MCU resources that you can use for your own application development are restricted. In addition, many of the configurations and customizations offered by the ZigBee protocol stack are unavailable to you with the ZbRom.

Please do not modify or disrupt any of the MCU resources used by the ZigBee stack:

6.1. Timers

Table 6-1: MCU Timer Usage

TA0	available
TA1	Used by ZigBee stack
TA2	Used by ZigBee stack
TA3	Used by ZigBee stack
TA4	Used by RTOS
TB0	Used by ZigBee stack
TB1	available
TB2	Used by ZigBee stack

6.2. System Clock

After reset, the main system clock (denoted in the spec as f1) is set up to run at 20MHz. The ZigBee stack assumes that the MCU is running at this operating frequency. Please do not make any changes to the clock.

6.3. Interrupts

The interrupt vector table is located in the ZigBee stack and real-time operating system (RTOS) program memory area (ZbROM). Therefore, you cannot implement any interrupt sub-routines other than the ones listed below. To implement your own sub-routines for those interrupts, you need to re-direct their respective interrupt vectors to the location of your interrupt service routines by calling the pre-defined functions `SetxxxInt()`.

Available User Interrupts	Interrupt Routine Vector Set Function
Timer A0	<code>void SetTimerA0Int(long funct_addr);</code>
Timer B1	<code>void SetTB1Int(long funct_addr);</code>
UART 2 Rx	<code>void SetUart2RxInt(long funct_addr);</code>
INT2	<code>void SetInt2Int(long funct_addr);</code>
INT3	<code>void SetInt3Int(long funct_addr);</code>
DMA 0	<code>void SetDma0Int(long funct_addr);</code>
DMA 1	<code>void SetDma1Int(long funct_addr);</code>

6.4. Flash and RAM Usage

The memory areas shaded in turquoise are available for your use.

Table 6-2: Flash Memory Usage

Flash Address Range	Usage
0xFF800-0xFFFFF	FoUSB Monitor Area (2KB)
0xE8000-0xFF7FF	User code/const space (30KB)
0xC0000-0xE7FFF	ZbROM Area (stack and RTOS) (64KB)
0x0F7FF-0x0FFFF	User Data Flash Area (2KB)
0x0F000-0x0F007	MAC Address (Don't Erase Block)

Table 6-3: RAM Memory Usage

RAM Address Range	Usage
0x2380-0x23FF	FoUSB Monitor Area
0x2000-0x237F	User global variable space (896 bytes)
0x0400-0x1FFF	ZbROM area, user task stack <100 bytes
0x0000-0x03FF	MCU Register Area

6.5. Stack RAM Usage

Try to minimize the allocation of local variables that use stack space inside of functions. Remember that your user application is running as a task in an RTOS with a limited amount of stack space allocated for it. For this ZbRom system, that value is fixed and cannot be changed. You must limit the RAM space used by your local variables and function calls to less than 100 bytes.

6.6. Global Variable RAM Usage

You may create as many global variables for your user program as RAM space is available (896 bytes). A virtual RAM section at the start of the debugger's RAM has been created to warn you if you try to allocate too much global RAM. Below is an example of the linker warning you will receive if you exceed the available RAM space:

```
Phase M16C Linker starting

C:\Workspace\test\test\sect30_zdk28.inc(186) : Warning (ln30):
C:\Workspace\test\test\Coord_Router\ncrt0_zdk28.r30 :
'DATA' section 'debugger_NE' is overlapped on the 'bss_NE' from 2380H to
2380H
```

6.7. MAC Address Area

Every 802.15.4 radio needs a globally unique 64-bit MAC address. Therefore, your ZDK boards have been pre-programmed with such an address. **Please do not erase the Flash block that contains this address.** If you accidentally do erase the MAC address, you can find .mot files with replacement addresses in the C:\Renesas\RZB_ZMD16C_ZDK\Demos\Replacement MAC Addresses directory. Program one of those addresses into your board using the FoUSB programming software. Please make sure that the address you pick is unique and different from any address used by your other ZDK boards.

6.8. ZbROM Flash Size

The ZbROM area contains the ZigBee protocol stack and the RTOS used by the stack. The ZbROM image occupies the two lower 32kBytes MCU Flash memory blocks for a total of 64kBytes. This allocation was done to prevent the code from being erased by the debugger when downloading your user code. The actual Flash memory size used by the ZigBee stack and RTOS will be less depending on ZigBee stack configuration settings when using the full development environment.

6.9. ZbROM RAM Size

The RAM allocated for use by the ZigBee stack and RTOS is the maximum amount that would be used if the device were to function as a ZigBee coordinator. The actual RAM size used by the ZigBee stack and RTOS will be less for other ZigBee stack configurations when using the full development environment.

6.10. ZigBee Stack Table Sizes

Table 6-4: ZigBee Stack Table Sizes

	ZigBee Coordinator & Router Number of Entries	ZigBee End Device Number of Entries
Neighbor Table	15	4
Router Table	15	0
Router Discovery Table	15	0
Broadcast Transmission Table	20	20

6.11. Customization of Demo Program Settings

The following definitions can be changed at the top of the `ZDK_Demo.c` file to fit your requirements.

```
/* ZigBee Configuration */
#define DEMO_CHANNEL 1
#define SCAN_CHANNELS ((DWORD)0x1 << DEMO_CHANNEL) /* Only scan our demo
                                                    channel */
// #define SCAN_CHANNELS 0x7FFF800 /* Scan every channel */
ZbPANId s_LocalPanId = 0x1ACE; /* MUST BE A VALUE LOWER THAN 0x3FFF */

/* ASCII Input */
#define MAX_SERIAL_INPUT 20

/* Address Book */
// This array holds the addresses of all the nodes currently
// on the network. It is updated only by the coordinator.
#define MAX_BOOK_ENTRIES 32

/* RECEIVE BUFFER */
#define RX_BUFF_SIZE 256 /* Circular buffer size for data payload (all
                        data is held in this one buffer) */
#define RX_BUFF_ENTRIES 16 /* Number of buffered packet that can be
                           queued up */
```

6.12. Other Limitations

The RZB-ZMD16C-ZDK provides sophisticated debugging features at a low cost, but it does have some limitations when used with the HEW software debugger and ICD. Those limitations are described in more detail in the RZB-ZMD16C-ZDK User manual (Start > (All) Programs > Renesas > RZB_ZMD16C_ZDK > All Manuals and Documents).

7.0 System Operation & Limitations

The RZB-ZMD16C-ZDK provides sophisticated debugging features at a low cost, but it does have some limitations when used with the debugger and ICD. Section 6.1 introduces the kernel (ROM monitor) program and its purpose. The limitations when this kernel is running with the user program are listed in Table 7-1.

Table 7-1: System Limitations when Debugging

Item	Please Refer To
User Limitations	7.2 Pin and Peripheral Limitations
	7.3 Memory Map
	7.4 Register Operation Limitations
	7.5 Limitations on Interrupts - Vectors that Reside in the Hardware Vector Table
Debugger Limitations	7.6 Stop or Wait Mode Limitations
	7.7 User Program's Real-Time Capability

7.1. Kernel (ROM Monitor) Introduction

During debug, a small program called a kernel is uploaded to the M16C/28. The kernel communicates with HEW through the ICD regarding MCU status during user code debugging operations.

There are no special steps required in the user program to make use of the ICD. The operation of the kernel is transparent to the user, but there are some limitations. These are discussed from section 7.2 onward.

After starting a HEW debug session, the ICD uploads the kernel to the M16C/28 if it does not exist (e.g. a blank device or a device that was programmed with the FoUSB Programmer). After downloading the kernel, the M16C/28 is ready to download user code.

Connecting the ICD without starting HEW will not affect the signal lines connected between the ICD and the M16C/28; the ICD keeps the signal lines in high-impedance state. The ICD only drives the pins after HEW or the FoUSB Programmer attempts to connect.

After completing program debug and verification with HEW, you can create an image of your code in Intel (.hex) or Motorola (.mot) file formats. This image can be programmed into the M16C/28 using the FoUSB Programmer. This procedure erases the kernel and leaves only the user program.

7.2. Pin and Peripheral Limitations

SIO/UART1 pins are used for communication between the M16C/28 kernel on the RZB-ZMD16C-ZDK board and HEW through the ICD. Do not connect these pins to any other circuit, as UART1 cannot be used in the user program while using the Debugger. For details, please see the RTA-FoUSB-MON (ICD) User's Manual on Target M16C ROM Monitor Resources or related ICD application notes.

7.3. Memory Map

The amount and locations of memory used by the kernel on the RZB-ZMD16C-ZDK board's M16C/28 MCU are shown in Figure 7-1.

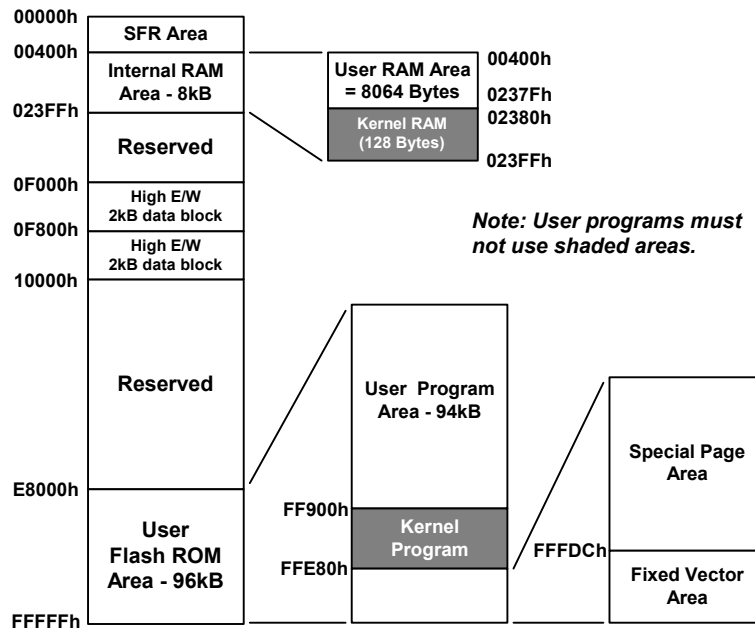

Figure 7-1: M30280FAHP Memory Map with the Kernel Program

Note: The kernel occupies memory associated with special-page vector numbers 18-19 and 192-255. The user reset vector is re-mapped to address FFFD8h by the kernel.

7.4. Register Operation Limitations

Table 6-2 lists the limitations on register operation. The registers are inhibited from any modification. If register contents are modified in any way, kernel operation cannot be guaranteed.

Table 7-2: Limitations on Register Operation

Register Name	Restriction
User and Interrupt Stack Pointers	RAM memory range 02380H – 023FFH is used by the kernel. Do not set stacks in this area.
UART1 Transmit/Receive Mode Register UART1 Transmit/Receive Control Register 0 UART1 Transmit/Receive Control Register 1	Do not change.
UART1 Interrupt Control Register 0	Do not change.
UART Transmit/Receive Control Register 2	Do not change bits 0 and 2.
UART1 Transmit Buffer Register	Do not write to this register.
UART1 Receive Buffer Register	Do not read this register.
Port 6 and Port 6 DDR	To prevent changes on P6_4 data and direction, use read-modify-write only instructions (BSET, BCLR, AND, OR, etc.).

7.5. Limitations on Interrupts - Vectors that Reside in the Hardware Vector Table

Table 7-3 lists the limitations on hardware interrupt (i.e. fixed) vector addresses.

Table 7-3: Interrupt Vector Addresses

Interrupt Cause	M16C/28 Vector Address	Kit Specification
Undefined	FFFDCh ~ FFFDFh	User available
Overflow	FFFE0h ~ FFFE3h	User available
BRK Instruction	FFFE4h ~ FFFE7h	User inhibited
Address Match	FFFE8h ~ FFFEBh	User inhibited
Single-step	FFFECh ~ FFFEfh	User inhibited
Watchdog Timer	FFFF0h ~ FFFF3h	User available (Note 1)
DBC	FFFF4h ~ FFFF7h	User inhibited
NMI	FFFF8h ~ FFFFBh	User available
RESET	FFFFCh ~ FFFFFh	Reset vector (Note 2)

NOTES:

(1) The Watchdog Timer vector is shared with the oscillation stop and voltage detection interrupts. The vector is available for oscillation stop and voltage detection interrupts, but you must avoid using the vector for watchdog timer interrupts.

(2) The kernel transparently relocates the Reset vector to FFFD8H.

7.6. Stop or Wait Mode Limitations

While running the kernel with an application that uses “STOP” or “WAIT” modes, care must be taken not to communicate with the MCU while “STOP” or “WAIT” is active (avoid RAM monitor or memory window refreshes, for example). Breakpoints (if used) should be set at points in the code where it is known that the BCLK is running at a frequency greater than 250 kHz.

7.7. User Program’s Real-Time Capability

Please be aware that while the kernel is in a “STOP” state, the hardware peripherals will continue to run. Therefore, interrupts may not be serviced properly. In addition, the watchdog timer will not be serviced and will likely time out if active.

While the kernel is in a “RUN” state, there is no overhead on the application code **unless** a RAM monitor window is open. This window requires periodic communication with the MCU. This communication suspends normal application operation while servicing the request (approximately 2000 BCLK cycles for each 16 bytes of data displayed in the window are used per window update). The user must determine whether this behavior is acceptable.

7.8. Performing Debug Using Symbols

Normally when a new project is created using HEW, debugging symbols are enabled. If you are unable to view the source properly during debug, add the debug option [-g] in HEW before compiling the programs. To enable the [-g] option, perform the following:

- Open the workspace and project in HEW.
- Select [Renesas M16C Standard Toolchain] from the Options pull-down menu.
- Click on the [Link] tab.
- Select [Output] under the [Category] list box.
- Click on the checkbox for [-g] ‘Outputs source debug information...’
- Click on the [OK] button

For more information, see the HEW user’s manual.

8.0 RZB-ZMD16C-ZDK Board Specifications

8.1. Hardware Specifications

Table 8-1 lists the specifications of the RZB-ZMD16C-ZDK Board.

Table 8-1: RZB-ZMD16C-ZDK Board Specifications

Item	Specification
MCU	M30280FAHP
Clocks	Main Clock: crystal 10 MHz, PLL, or ring oscillator Sub Clock: 32.768 kHz crystal
Memory (ICD)	RAM: 8kB (8064 Bytes user available due to kernel) High E/W Data Block: 2kB × 2 (4096 Bytes) Flash ROM: 96kB (94kB user available due to kernel)
Connectors	[J1-J4]: Four 2×10-pin measurement test points connected to the MCU pins. Can also be used to connect your own expansion boards via 2×10 headers. [J7]: In-Circuit Debug connector (UART1 for FoUSB-ICD) [P1]: 9-Sub-D RS232 connected via RS232 transceiver to UART2
Jumpers	[JP1]: MCU Power for Icc Measurements [JP2]: Power LED and RS232 Power connect
Switches	[S1]: pushbutton (connected to P10_4) [S2]: pushbutton (connected to P10_5) [S3]: pushbutton (connected to P10_6) [S4]: pushbutton (connected to Reset) [SW1]: Power source select switch. If set toward the ICD connector: power provided by ICD. If set toward the power connector: power provided via power connector.
LEDs	[D1] (Red): User output (connected to P3_4) [D2] (Yellow): User output (connected to P3_5) [D3] (Green): User output (connected to P3_6) [D4] (Red): Power On (if jumper JP2 shorted)
LCD	2-line × 8-character LCD with KS0066 controller IC

8.2. Power Supply Requirements

The RZB-ZMD16C-ZDK Board will draw about 35mA with no LEDs on. With the ICD powered from the board, the current draw will be about 85mA.

The board has a 3.3V low dropout voltage regulator with an input voltage range from 3.4V to 16V.

8.3. Operating Environment

Table 8-2 lists the environmental conditions for using and storing the RZB-ZMD16C-ZDK board. Store the board in a conductive bag inside the original factory packaging box.

Table 8-2: Operating Environment

Environmental Condition	Ambient Temperature	Ambient Humidity
Operating	0 - 55°C (No corrosive gas allowed)	30 to 80% (non-condensing)
Storage	-30 to 75°C (No corrosive gas allowed)	30 to 80% (non-condensing)

Appendix A. Troubleshooting Guide

This section discusses possible problems you may encounter while installing the development tool software, USB drivers, or running the HEW debugger and FoUSB Programmer applications. This section also discusses the countermeasures and solutions to resolve these problems.

For troubleshooting information on the RF Sniffer Interface and RF Sniffer board, see the RF Sniffer User's Manual.

If, for any reason, you cannot resolve the problem, please contact your Renesas representative for assistance.

A.1 Manual Installation

Before connecting the In-Circuit Debugger to your PC, the driver files (.inf and .sys) and executables must be copied to the `C:\Renesas\FoUSB` directory.

To do this, run `FoUSB_Vx.xx.exe` in the `\Tools\FoUSB` directory of the CD. After the FoUSB Programmer install, assuming the default directory was used, a `C:\Renesas\FoUSB` subfolder should have been created. The Windows USB drivers can be found under the `USB Drivers` folder, i.e. `fousb.inf`, `fousb.sys` (driver files to run FoUSB Programmer), `usbmon.inf`, and `usbmon.sys` (driver files to run HEW).

A.2 USB Driver Problems

This part discusses how to fix common problems that may occur with USB driver installation. The most common problem is that Windows did not properly install the USB drivers, so that the ICD is not recognized. An indication of this problem is the faster blink rate of the ICD's yellow Status LED of about 2-3 times per second. When the driver is installed properly, the yellow Status LED only blinks every second.

Before trying the following steps, try re-starting your PC to see if this resolves the problem. You can check the USB Driver status using the Windows Device Manager (Start > Control Panel > System Properties > Hardware > Device Manager > Universal Serial Bus controllers). If the "Renesas FoUSB ICD" appears under the Universal Serial Bus controllers with **no** red X or yellow exclamation point, the driver was installed properly.

NOTE: If you are using Windows 2000 or XP, you will need Administrator privileges to be able to install the drivers.

For cases where "Renesas FoUSB ICD" appears with a red X or yellow exclamation point in the Windows Device Manager, please try the following:

1. Open the Windows Device Manager (Start > Control Panel > System Properties > Hardware > Device Manager > Universal Serial Bus controllers).
2. Double-click on 'Renesas FoUSB ICD'. A Renesas FoUSB ICD Properties dialog box appears.
3. Click on the 'Driver' tab and click the 'Update Driver' button.
4. Select 'Display a list...' and click on the 'Have Disk' button.
5. Browse to the `C:\Renesas\FoUSB\USB Drivers` directory and install the `usbmon.sys` driver.
6. If this process does not work, please follow the instructions below.

If you encounter problems on installing the drivers, you can try the following:

Windows 2000

- a. Copy the `fousb.inf` and `usbmon.inf` files from the `C:\Renesas\FoUSB\USB Drivers` folder to the `\WINNT\INF` folder.
- b. Copy the `fousb.sys` and `usbmon.sys` files from the `C:\Renesas\FoUSB\USB Drivers` folder to the `\WINNT\SYSTEM32\drivers` folder.

Windows 98 or XP

- a. Copy the `fousb.inf` and `usbmon.inf` files from the `C:\Renesas\FoUSB\USB Drivers` folder to the `\WINDOWS\INF` folder.
- b. Copy the `fousb.sys` and `usbmon.sys` files from the `C:\Renesas\FoUSB\USB Drivers` folder to the `\WINDOWS\SYSTEM32\drivers` folder.

A.3 Debugging Problems

This section discusses the cause of the problem and countermeasures to resolve it. The common problems encountered with debugging are:

- Erratic debug behavior
- Cannot connect to target
- Issues that may come up during debug operations

A.3.1 Erratic Debug Behavior

HEW allows you to launch multiple instances of itself. However, if more than one instance of HEW is open during a debug session, erratic behavior can result. Running the FoUSB Programmer at the same time as HEW can also result in erratic debug behavior. Lastly, having more than one ICD installed can also cause erratic problems or cause HEW to crash.

A.3.2 Cannot Connect to Target

When the message “Can’t connect with the target” is displayed when attempting to connect, there are several reasons that may have caused this message to appear. Each cause and its corresponding countermeasure is discussed below.

- The ZDK board or the ICD are not connected correctly.

Unplug the ICD from the USB cable. First connect the ZDK target board to the ICD via the supplied 2×5-header ribbon cable, then connect the ICD back to your PC’s USB port via the supplied mini USB cable. Please see section “4.0 System Connectivity”.

- The ICD has no power (Power LED of the ICD is off).

Please ensure that the Power Mode switch on the ICD is set to ‘USB’, and that the power switch on the ZDK board is set toward the ICD connector, if you want to power the board from the ICD unit. If you want to power the ICD from the ZDK target board, the ICD power mode switch must be in the ‘Target’ position. The target board then must be provided with its own power supply and the target board’s power switch must be on in the correct position (toward the power connector).

- USB was not selected on the HEW Init dialog box.

Please select 'USB' from the Init dialog box that is displayed right after you start a debug session.

- The selected MCU on the ICD board and the actual target MCU (M16C/28) do not match.

Close the error message by clicking on the 'OK' button, then click on the 'Cancel' button of the Init window. Make sure you select 'M30280FA.mcu'. If the MCU loaded on the ICD is different, HEW will re-program the ICD to match it.

- The target MCU is damaged.

Try a different target board and see if the HEW will connect. You may have a damaged board or MCU.

A.3.3 Issues that May Arise During Debug Operations

While debugging user code, some issues may come up because the limitations discussed in section "7.0 System Operation & Limitations" were not satisfied. The common issues are listed in Table A.3, including the countermeasures.

Table A.3

Problem	Possible Cause/s and Solution
After stepping a few instructions, HEW cannot "stop"	<ul style="list-style-type: none"> • Changes were made to the UART1 Special Function Registers (SFRs). Do not change UART1 SFRs in your code.
Breakpoints do not seem to work	<ul style="list-style-type: none"> • System is in "FreeRun" mode. Change the RUN mode to "Sampling" from the "Init" window (Emulator System icon).
HEW locks up (cannot stop program) or Communication error message is displayed.	<ul style="list-style-type: none"> • Changes were made to the UART1 SFRs. Do not change UART1 SFRs in your code. • Ensure that no limitations in Section 6 were violated. • Re-initialize the system without closing debug session. See note below. • Do a hardware reset. User-program runaway may be corrupting the kernel (RAM, interrupt vectors, flags, etc.). Close the debug session, hit the reset button on the ZDK board to reset the board, then restart.
Download problems	<ul style="list-style-type: none"> • Filenames or directory names contain spaces or special characters. • HEW project was not properly set up (startup files missing or out of order, files added to wrong member, etc.). Try creating a new project and adding your source files to it. For details, please see the HEW User's Manual.

To re-initialize the system without closing a debug session, try the following:

- Click the [OK] button on the error dialog box to close it.
- When an Exit dialog box appears, click the [Cancel] button to close it.

- Press the reset button on the ZDK board.
- Click the HEW Reset icon.

After initialization, debugging can resume. However, it is recommended that you download your program again before debugging.

Appendix B. Reference Manuals

Item	Title	Description
1.	Renesas ZigBee Demonstration Kit (ZDK) Quick Start Guide	Document that will help you get started on using the ZigBee Demonstration Kit.
2.	RZB-ZMD16C-ZDK User's Manual	This document.
3.	RF Sniffer User's Manual	Document describing the ZigBee RF Sniffer hardware and software in more detail.
4.	ZDK Board Schematic	Schematic diagram for the RF Sniffer and ZDK boards.
5.	ZDK Board BOM	Bill of materials for the ZDK board.
6.	M16C/20/60 Series C-Language Programming Manual	ANSI C-language programming guide for the M16C/20/60 series MCU.
7.	M16C/20/60 Series Assembler Language Programming Manual	Assembly language programming guide for the M16C/20/60 series MCUs.
8.	HEW User's Manual	This document describes installation and operation of this Integrated Development Environment for Renesas' Tools.
9.	AS30 User's Manual	Guide for AS30 assembler.
10.	NC30 User's Manual	Guide for NC30WA C-compiler.
11.	RTA-FoUSB-MON User's Manual	In-Circuit Debugger and Programmer User's Manual.

NOTE:

The installer will copy all these manuals during installation. They can be accessed using the Document Descriptions file by clicking on Start > Programs > Renesas > RZB_ZMD16C_ZDK > Document Descriptions.

Appendix C. Expansion Headers

The M30280FA MCU on the RZB-ZMD16C-ZDK target board is housed in an 80-pin QFP package. Pin 1 of the package is identified by a little white circle on the board's top silkscreen. Connectors J1 to J4, located around the MCU, provide access to almost all of the MCU's pins. You can use J1-J4 as test points to check MCU signals or, by mounting your own headers, connect your own expansion board. The silkscreen identifying the connectors is at the bottom of the ZDK board. The following table shows the mapping of J1-J4 pins to MCU pins and signal names.

J1 Pin	MCU Pin	MCU Function
1	1	P9 ₅ /AN ₂₅ /CLK ₄
2	2	P9 ₃ /AN ₂₄
3	3	P9 ₂ /TB _{2in}
4	4	P9 ₁ /TB _{1in}
5	5	P9 ₀ /TB _{0in}
6		
7		
8		
9		
10		
11	11	Vss
12		
13	13	Vcc
14	14	P8 ₅ / $\overline{\text{NMI}}$ / $\overline{\text{SD}}$
15	15	P8 ₄ /INT ₂ / $\overline{\text{Zphase}}$
16	16	P8 ₃ / $\overline{\text{INT}}_1$
17	17	P8 ₂ / $\overline{\text{INT}}_0$
18	18	P8 ₁ /TA _{4in} / $\overline{\text{U}}$
19	19	P8 ₀ /TA _{4out} /U
20	20	P7 ₇ /TA _{3in}

J2 Pin	MCU Pin	MCU Function
1	21	P7 ₆ /TA _{3out}
2	22	P7 ₅ /TA _{2in} / $\overline{\text{W}}$
3	23	P7 ₄ /TA _{2out} / $\overline{\text{W}}$
4	24	P7 ₃ / $\overline{\text{CTS}}_2$ / $\overline{\text{RTS}}_2$ /TA _{1in} / $\overline{\text{V}}$ /TXD ₁
5	25	P7 ₂ /CLK ₂ /TA _{1out} / $\overline{\text{V}}$ /RXD ₁
6	26	P7 ₁ /RxD ₂ /SCL/TA _{0in} /CLK ₁
7	27	P7 ₀ /TxD ₂ /SDA/TA _{0out}
8	28	P6 ₇ /TxD ₁
9	29	P6 ₆ /RxD ₁
10	30	P6 ₅ /CLK ₁
11	31	P6 ₄ / $\overline{\text{CTS}}_1$ / $\overline{\text{RTS}}_1$ / $\overline{\text{CTS}}_0$ /CLKS ₁
12	32	P3 ₇
13	33	P3 ₆
14	34	P3 ₅
15	35	P3 ₄
16	36	P3 ₃
17	37	P3 ₂ /S _{OUT3}
18	38	P3 ₁ /S _{IN3}
19	39	P3 ₀ /CLK ₃
20	40	P6 ₃ /TxD ₀

J3 Pin	MCU Pin	MCU Function
1	41	P6 ₂ /RxD ₀
2	42	P6 ₁ /CLK ₀
3	43	P6 ₀ / $\overline{\text{CTS}}_0$ / $\overline{\text{RTS}}_0$
4	44	P2 ₇ /OUTC1 ₇ /INPC1 ₇
5	45	P2 ₆ /OUTC1 ₆ /INPC1 ₆
6	46	P2 ₅ /OUTC1 ₅ /INPC1 ₅
7	47	P2 ₄ /OUTC1 ₄ /INPC1 ₄
8	48	P2 ₃ /OUTC1 ₃ /INPC1 ₃
9	49	P2 ₂ /OUTC1 ₂ /INPC1 ₂
10	50	P2 ₁ /OUTC1 ₁ /INPC1 ₁ /SCL _{MM}
11	51	P2 ₀ /OUTC1 ₀ /INPC1 ₀ /SDA _{MM}
12	52	P1 ₇ / $\overline{\text{INT}}_5$ /INPC1 ₇ /IDU
13	53	P1 ₆ / $\overline{\text{INT}}_4$ /IDW
14	54	P1 ₅ / $\overline{\text{INT}}_3$ / $\overline{\text{AD}}_{\text{TRG}}$ /IDV
15	55	P1 ₄
16	56	P1 ₃ /AN ₂₃
17	57	P1 ₂ /AN ₂₂
18	58	P1 ₁ /AN ₂₁
19	59	P1 ₀ /AN ₂₀
20	60	P0 ₇ /AN ₀₇

J4 Pin	MCU Pin	MCU Function
1	61	P0 ₆ /AN ₀₆
2	62	P0 ₅ /AN ₀₅
3	63	P0 ₄ /AN ₀₄
4	64	P0 ₃ /AN ₀₃
5	65	P0 ₂ /AN ₀₂
6	66	P0 ₁ /AN ₀₁
7	67	P0 ₀ /AN ₀₀
8	68	P10 ₇ /AN ₇ / $\overline{\text{KI}}_3$
9	69	P10 ₆ /AN ₆ / $\overline{\text{KI}}_2$
10	70	P10 ₅ /AN ₅ / $\overline{\text{KI}}_1$
11	71	P10 ₄ /AN ₄ / $\overline{\text{KI}}_0$
12	72	P10 ₃ /AN ₃
13	73	P10 ₂ /AN ₂
14	74	P10 ₁ /AN ₁
15	75	AVss
16	76	P10 ₀ /AN ₀
17		
18	78	AVcc
19	79	P9 ₇ /AN ₂₇ /S _{IN4}
20	80	P9 ₆ /AN ₂₆ /S _{OUT4}

Appendix D. Board Schematic & BOM

Note: The RZB-ZMD16C-ZDK board is referred to as RZB-ZMD28-BRD on the board's silkscreen and schematic drawing.

The circuit board schematic and Bill-Of-Materials (BOM) are available as separate PDF documents. They can be accessed through Start > Programs > Renesas > RZB_ZMD16C_ZDK > Board Hardware, or by browsing to the folder

C:\Renesas\RZB_ZMD16C_ZDK\Docs\ZDK_Manuals and opening the files:

RZB_ZMD28_BRD_BOM.pdf

RZB_ZMD28_BRD_Schematic.pdf

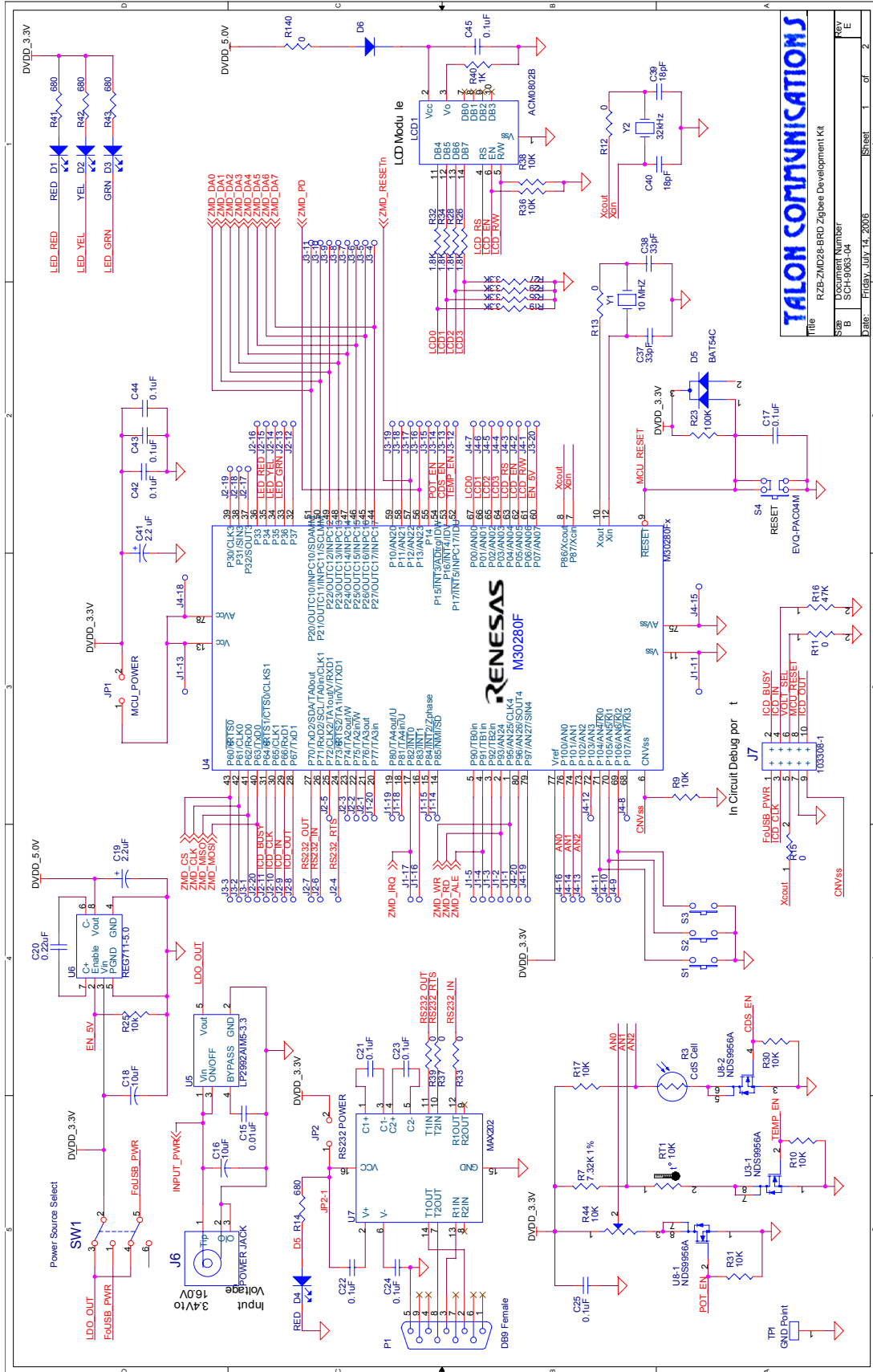

TALON COMMUNICATIONS
 Title: RZB-ZMD28-BRD Zigbee Development Kit
 Sys: 1
 B: 1
 SCH: 0063-04
 Date: Friday, July 14, 2006
 Sheet: 1 of 2

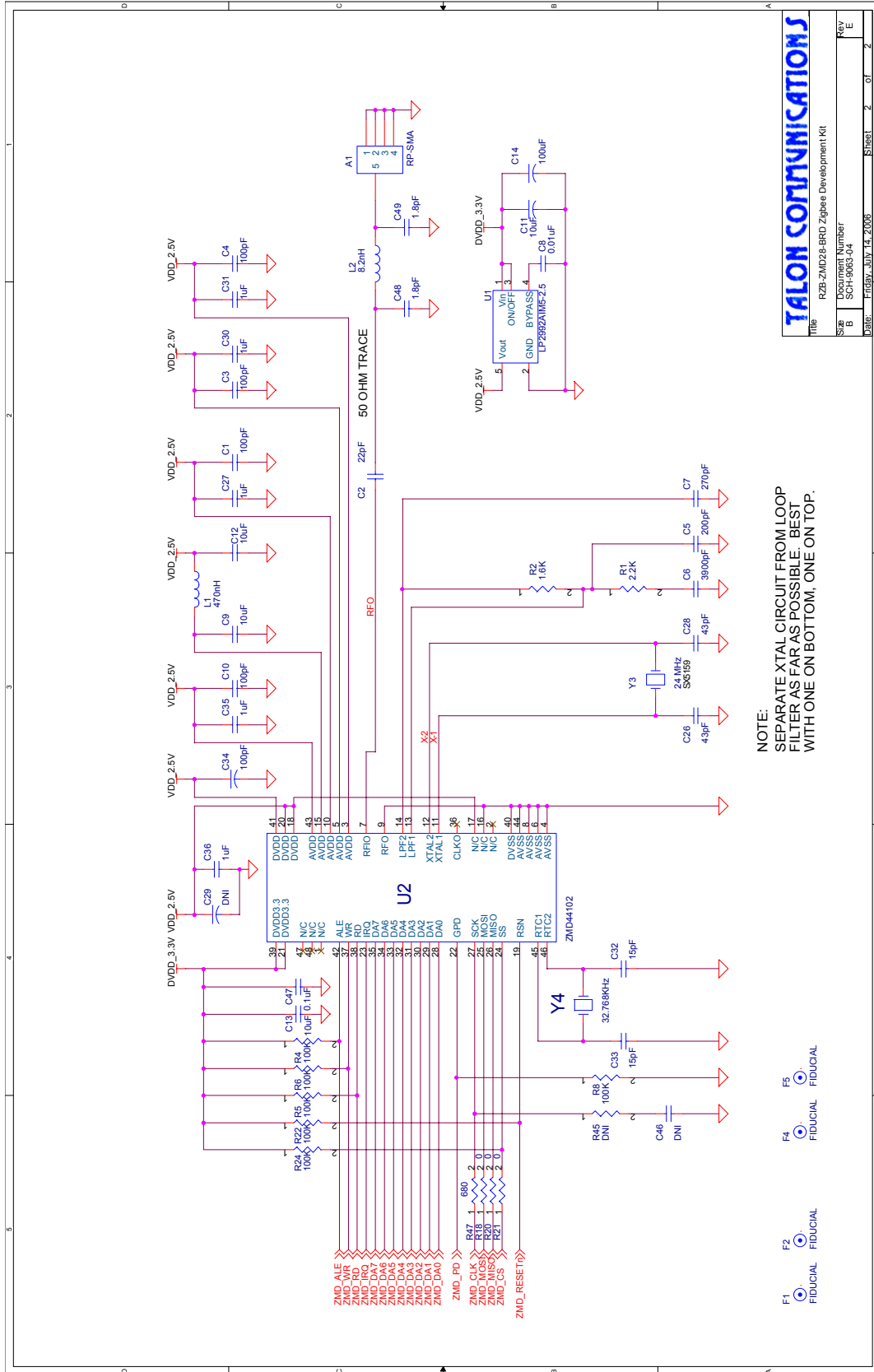

Appendix E. RZB-ZMD16C-ZDK Printed Circuit Board

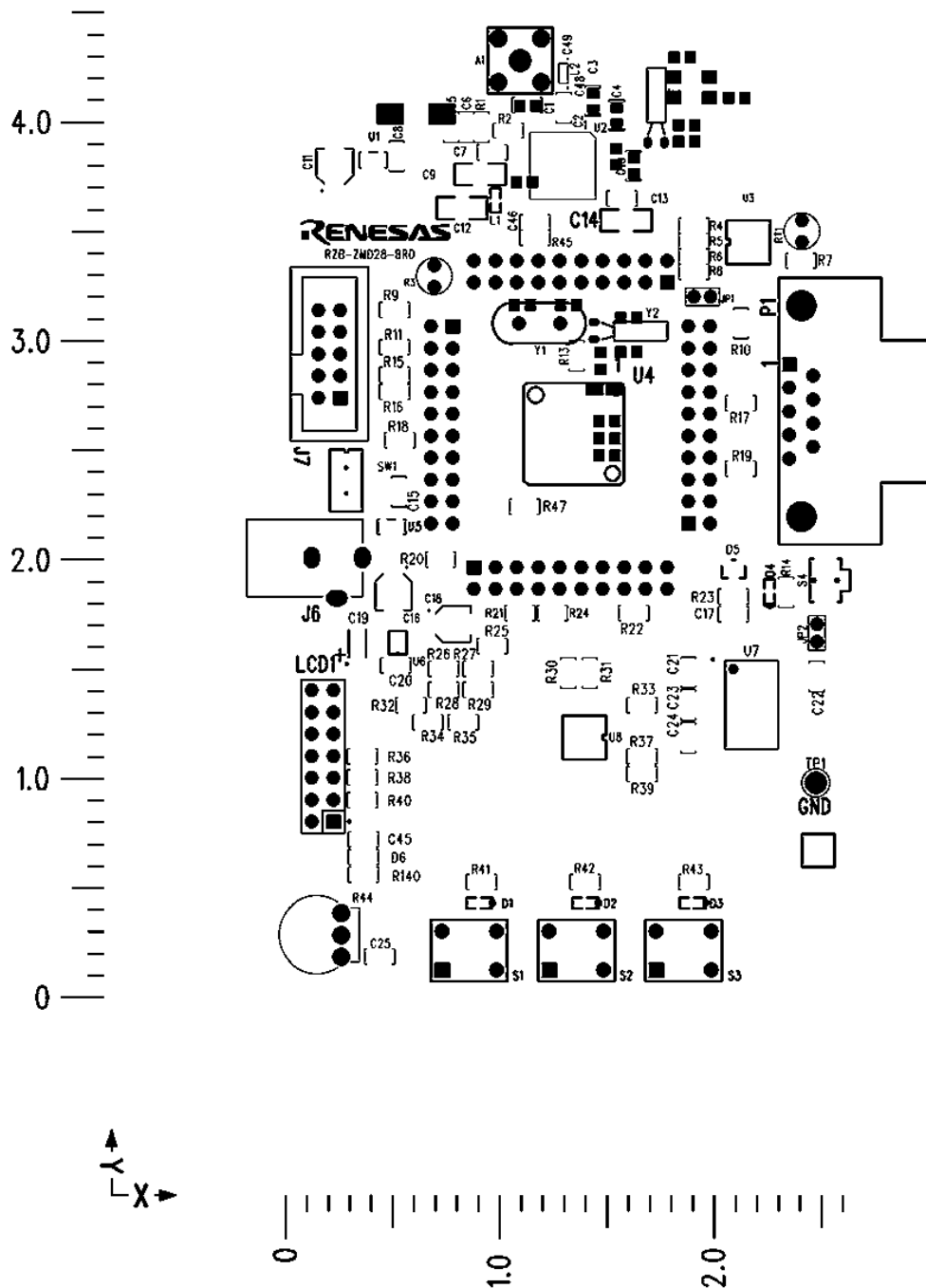

Figure E-1: PCB Top View

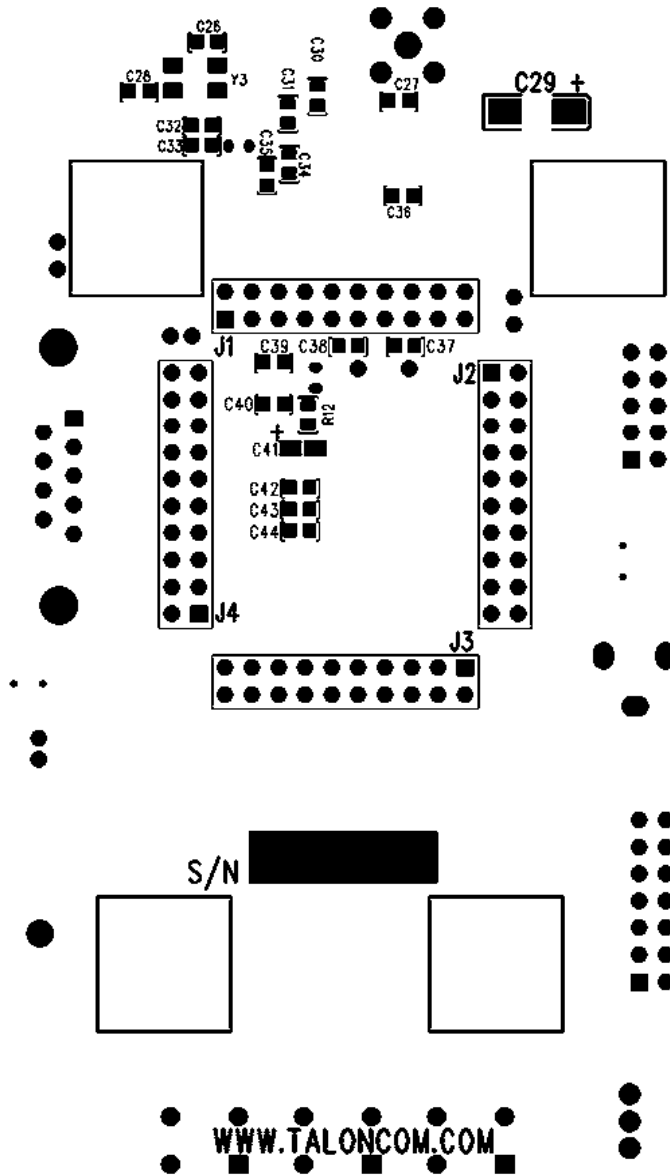

Figure E-2: PCB Bottom View

Appendix F. Other Resources

1. For details on how to use the In-Circuit Debugger and Programmer, please see the RTA-FoUSB-MON User's Manual (Start > (All) Programs > Renesas > RZB_ZMD16C_ZDK > RTA-FoUSB-Mon Manual).
2. For updates and other evaluation tools and sample programs for the RZB-ZMD16C-ZDK Kit, see: <http://america.renesas.com/zigbee>.

Free Manuals Download Website

<http://myh66.com>

<http://usermanuals.us>

<http://www.somanuals.com>

<http://www.4manuals.cc>

<http://www.manual-lib.com>

<http://www.404manual.com>

<http://www.luxmanual.com>

<http://aubethermostatmanual.com>

Golf course search by state

<http://golfingnear.com>

Email search by domain

<http://emailbydomain.com>

Auto manuals search

<http://auto.somanuals.com>

TV manuals search

<http://tv.somanuals.com>