

REVOLABS FLX2™

Wireless Conference System for analog phone lines

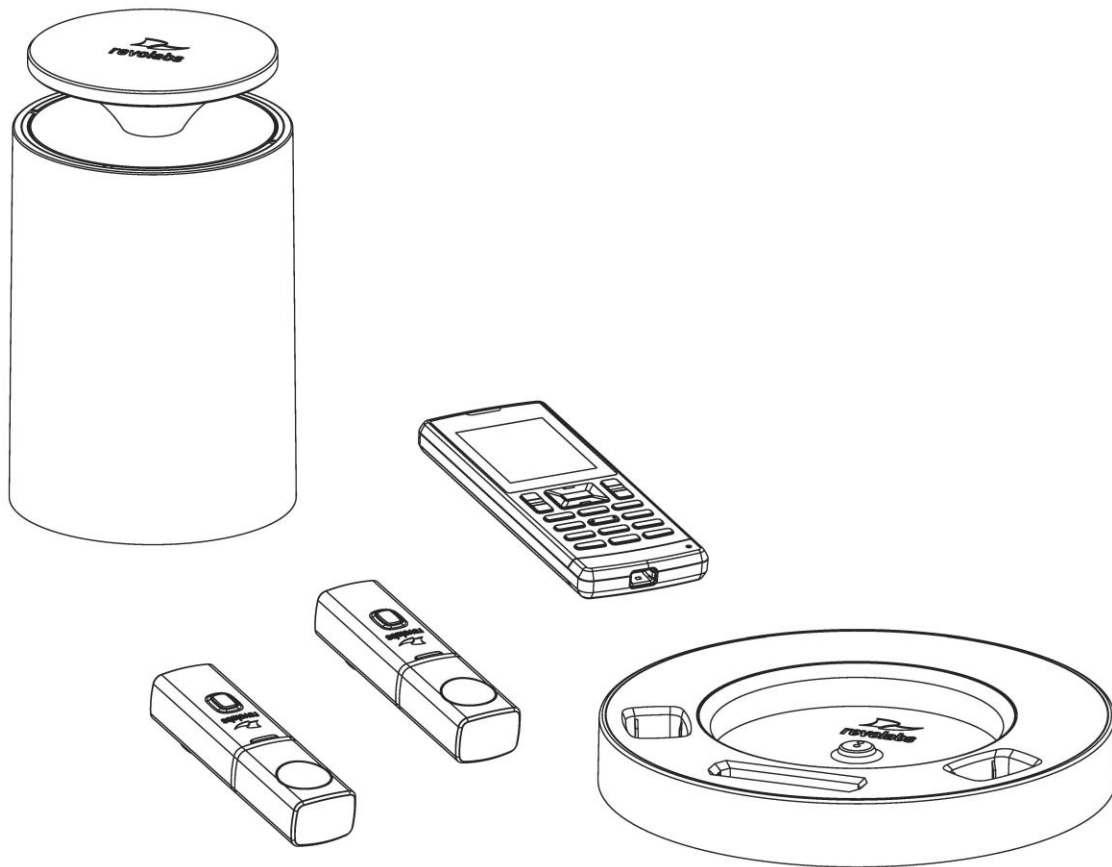

System Guide

Models:

10-FLX2-200-POTS 10-FLX2-020-POTS 10-FLX2-002-POTS 10-FLX2-101-POTS



© 2011 REVOLABS, INC. All rights reserved. No part of this document may be reproduced in any form or by any means without express written permission from Revolabs, Inc. Product specifications are subject to change without notice.

Revolabs FLX2 System Guide – Analog
10-FLX2SYSGUIDE-EN
May 2011 (Rev 1.1)



Introduction

Congratulations on your purchase of the Revolabs FLX2™ Wireless Conference Phone. This system utilizes state of the art technology providing high band-width audio and enabling clear, reliable, un-tethered communications with your telephone, PC, mobile device, and video conferencing system.

The Revolabs FLX2 Conferencing Phone allows enhanced freedom for telephone and video conferences by allowing independent locations of the microphones and the speaker used during the call.

The FLX2 Conference Phone utilizes encrypted digital communication for its wireless transport, ensuring highest security for your conversations. The FLX2 Conference Phone is a flexible solution for all your communication needs, allowing it to be used in your telephone network, for your video conferences, and with your Bluetooth enabled cell phone or computer.

Welcome to the 21st century Unified Communications Technology!

Please read this documentation carefully and follow the instructions before using your FLX2 Wireless Conference phone.

Safety Warnings

- Do not expose any of the FLX2 components to water, moisture, or high humidity.
- Do not expose any of the FL2X components to extreme high or low temperatures.
- Do not expose any of the FLX2 components to lit candles, cigarettes, cigars, or to open flames, etc.
- Do not drop, throw, or try to bend any of the components, as rough treatment could damage them.
- Do not open the casings of any of the components of the FLX2 Conference Phone
- Do not use any other accessories than Revolabs' originals intended for use with this product. Use of non-original accessories may result in loss of performance, damage to the product, fire, electric shock or injury. The warranty does not cover product failures which have been caused by use of non-original accessories.
- Only use the power adapters provided to connect the components to the electric mains.
- Please note the two different power supplies delivered with the Conference Phone. Ensure that you connect the right power supply with the FLX2 Base Station and the FLX2 Charging Tray, respectively.
- Do not open or try to modify any of the batteries delivered with the FLX2 Conference Phone components. Replace batteries only with Revolabs approved batteries.
- Extreme heat, short circuits, or any attempt to open or modify the batteries might cause them to ignite or explode.

Contents

Introduction.....	3
Safety Warnings.....	3
Contents.....	4
General Information	6
Quick setup for Telephone Conference Calls.....	7
Description.....	9
Unpacking.....	9
Installing FLX2 Components	10
FLX2 Base Station	10
FLX2 Charger Base.....	11
FLX Dialer	12
FLX Speaker	13
FLX Microphones	14
Initial Setup.....	15
Managing A Call.....	15
Calling Configurations.....	15
Placing a Telephone Call	17
Answering an Incoming Telephone Call	17
Ignoring an Incoming Telephone Call	18
Ending a Telephone call	18
Calling a Directory Contact.....	18
Active Call Management	19
Charging Components during a Call.....	21
Bluetooth.....	21
Activating Bluetooth	21
Managing the Device Registry	22
Making a call via Bluetooth	24
Answering a call via Bluetooth	24
Video Conference Collaboration	24
Connecting a Video Conference System.....	24
Configuring the Analog Audio	24
Making a Video Call.....	24
FLX2 System Configuration.....	25
Menu Hierarchy.....	25
Menu Navigation	25
Recent Calls	26
Contacts	28
Audio Control	31
Device Status	33
System Information	33
Bluetooth	33

Home	33
Call.....	34
Setup.....	34
Power On/Off the System Components	39
Troubleshooting.....	40
Warning Messages.....	40
Microphone, Speaker, or Dialer not connecting to Base Station	40
Microphone, Speaker, or Dialer not paired with Base Station	41
LED Indicators.....	42
Reset to Factory Defaults	43
Technical Specifications	44
Models.....	44
Regulatory Information	46
FCC Notice to Users.....	46
Industry Canada Notice to Users	46
Restricted use with certain medical devices.....	47
Export Law Assurance.....	47
North American UPCS Usage Restriction.....	47
European Union Usage Restriction	47
WEEE Notification.....	47
Warranty	50
Technical Support.....	51

General Information

The Revolabs FLX2 Conference Phone includes several components which, in the sum, make up the conferencing phone. The components are the Charge Base, Speaker, Microphones and Dialer (handset).

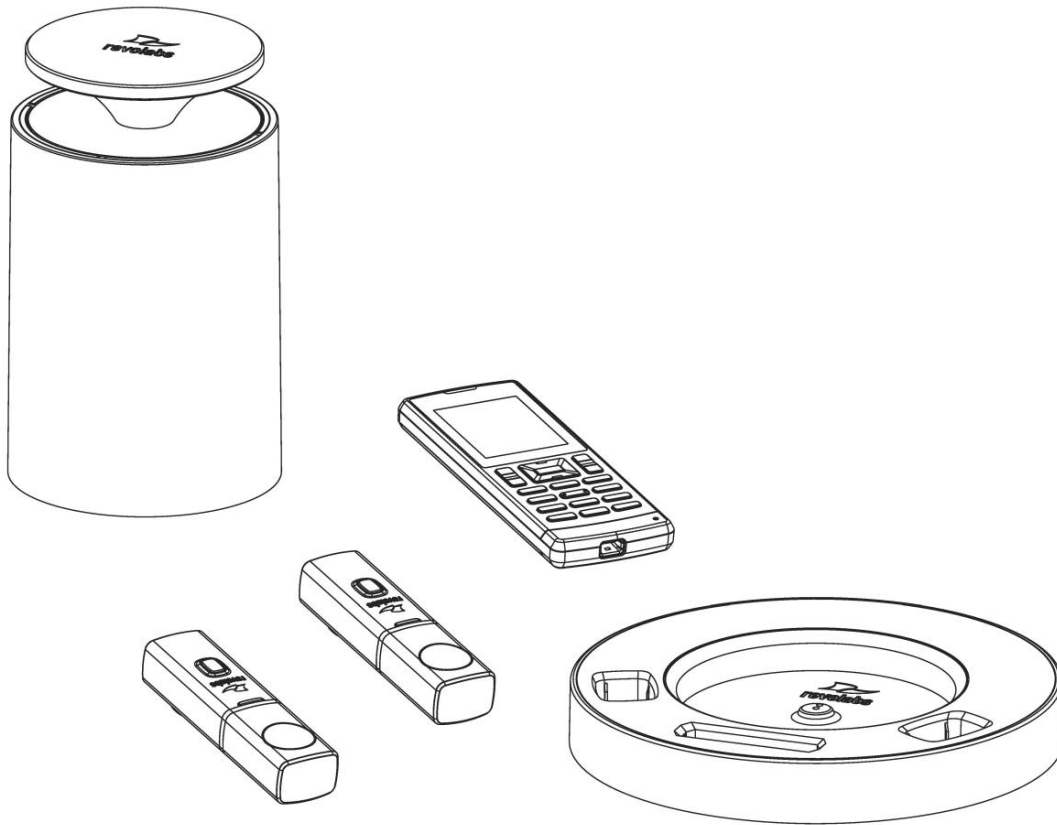

In addition, the Base Station receives the wireless signals from those components and connects into your telephone network for conference calls, with your video conferencing unit to provide outstanding audio for your video calls, or to your Bluetooth enabled device such as a cell phone or computer.

Quick setup for Telephone Conference Calls

While all components delivered with the Revolabs FLX2 Conference Phone are partially charged, we recommend charging the Speaker, the Microphones, and the Dialer for at least 8 hours or overnight before starting to use the system.

Please note that the Revolabs FLX2 Conference Phone comes with two different power supplies. Please ensure that you are using the correct power supply when connecting the Base Station and the Charger Base.

Connecting the Base Station

Place the Base Station close to the analog telephone outlet you want to use for the conference phone. Connect the Base Station to the telephone network using the provided RJ 11 Telephone cable. Use the 5 Volt power supply to connect the Base Station to mains power.

The Base Station will power up.

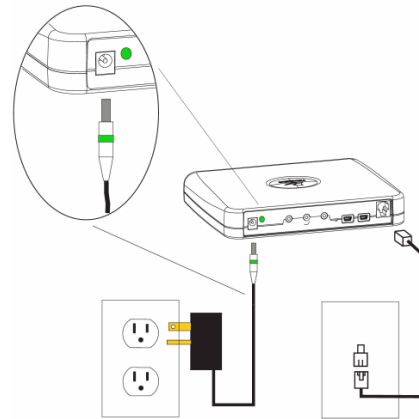

Connecting the Charger Base

Place the Charger Base at a location where you can easily access the Microphones and the Speaker for your conference calls, e.g. on a side board, a desk, or the conference table. Connect the Charger Base to the mains power using the provided 12-15V power supply. Place the Speaker, the Microphones, and the Dialer in the respective openings of the Charger Base to charge them.

The Microphones, Dialer and Speaker will automatically connect to the Base Station after a short time if it is powered up. You will hear a confirmation chime from the Speaker once the system is ready for use. If any of the Microphones, the Speaker, or the Dialer is not powered up, take them out of the Charger

Base for a few seconds and put them back in. This will switch on each of the components.

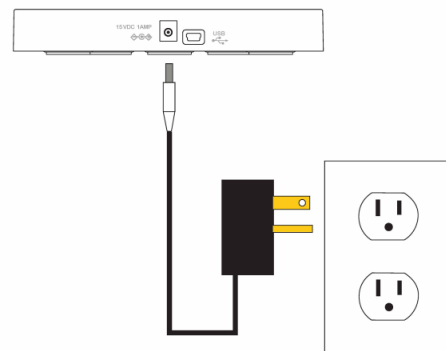

Making a call

To make a conference call, take at least one of the Microphones out of the Charger Base, and take the Dialer out of the Charger Base. You can remove all Microphones and the Speaker if you wish, but this is not required. Use the Dialer to enter the number you want to call, including any leading digits your telephone connection might require. The Speaker and any Microphone that is not in the Charger Base will be active during the call. To finish a conference call, either press the red hang-up button on the Dialer, or return all Microphones to the Charger Base.

To make a call using the Dialer as a handset, do not remove any Microphone from the Charger Base before starting to dial the number. At this point, only the Dialer will be used for the call. To end the call, press the red hang-up button on the Dialer.

With a Microphone out of the Charger Tray, you can toggle between handset and conference phone mode using the buttons on the Dialer.

To answer a call using the conference phone, simply remove one or more Microphones from the Charger Base when the Speaker rings. If a microphone is already out of the charger base when an incoming call comes in, pressing the button on the microphone will answer the call in conference phone mode. You can also use the Dialer to answer the call by pressing the green call button on the handset. If all microphones are in the charger at this time, the call will be answered using the handset mode. If at least one microphone is switched on and not in the charger base, this will answer the call in Conference phone mode.

Description

The Revolabs FLX2™ Wireless Conference Phone is a unique marriage of innovative technology and ergonomic design, allowing for an unparalleled experience when making telephone calls, video conference calls, or using it with your Bluetooth enabled cell phone or computer to make speaker phone calls.

The technology used allows the Microphones, the Dialer, and the Speaker to co-exist with other wireless products such as wireless LANs (802.11b&g) without interference.

The Revolabs FLX2 Conference Phone includes digital encryption technology to ensure secure wireless communications between the Microphones, Speaker and the Base Station.

Unpacking

Your Revolabs FLX2™ Conference Phone package contains the following items. When unpacking the system be sure to take inventory of all parts to ensure that nothing is missing. If parts are missing, please contact your retailer.

- FLX2 Base Station
- FLX2 Charger Base
- FLX Speaker
- FLX Dialer
- 2 FLX Microphones
- 1 12-15V AC adapter for the Charger Base
- 1 5 V AC adapter for the Base Station
- RJ11 Telephone Cable
- System Guide

Installing FLX2 Components

The Revolabs FLX2™ System is comprised of several components that work together to provide you with a great wireless conferencing system. These components must be setup correctly for optimal performance of the system.

FLX2 Base Station

The Base Station is the wireless receiver and sender of the audio stream from the Microphones and to the Speaker, as well as to the Dialer. It features the ability to connect two Revolabs FLX Microphones and one Speaker wirelessly.

The Base Station is designed to optimize audio and video conferencing by providing consistent audio input from all participants.

The FLX2 Base Station is shown in rear panel view below. It is equipped with a telephone connection to connect to an analog telephone output, a DC power connection, two mini-USB ports for firmware updates, and analog audio input/output connections for video conferencing collaboration or for recording.

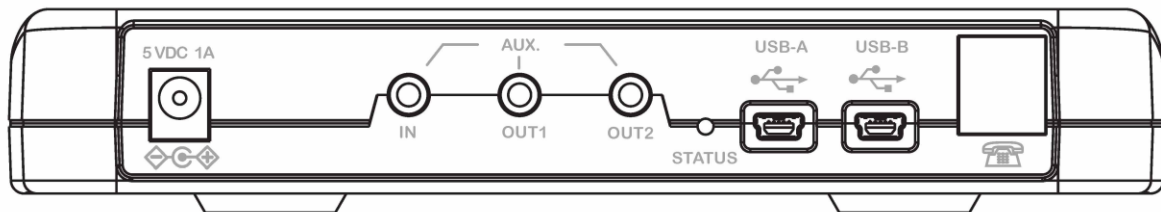

NOTE: The Base Station comes equipped with the necessary cables and power supplies to perform an analog telephone conference call. Other types of conference calls performed with FLX2 may require additional cables that are not part of the delivery.

FLX2 Charger Base

The FLX2 Charger Base, shown below, provides charging capabilities for all battery operated system components, including the Dialer, the Speaker, and the Microphones, by allowing them to charge in one simple and organized location.

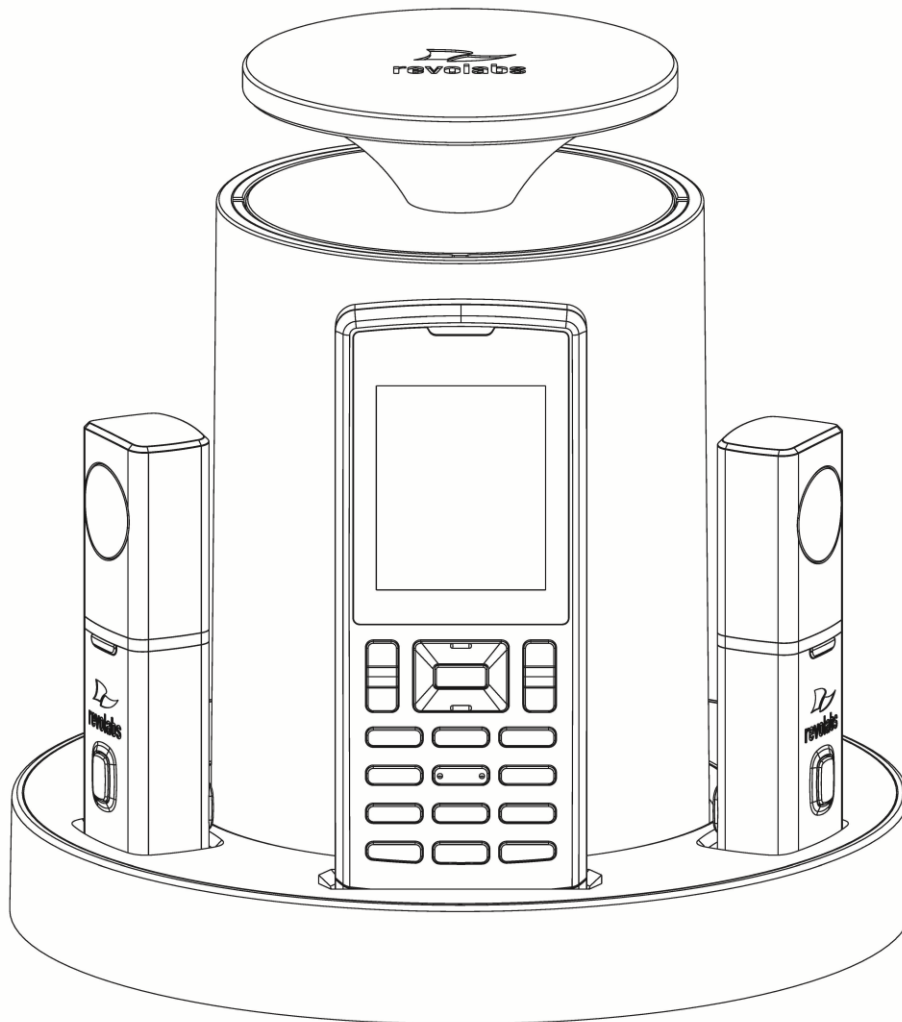

The FLX2 Charger Base is not required while in a conference call, however it can maintain the charge of the FLX Speaker and FLX Dialer while a call is in progress. Microphones must be removed from the Charger Base while a call is in progress in order to use 'speaker mode'. The Charger Base is equipped with a DC power connection and a mini-USB connection for firmware updates to the Dialer.

FLX Dialer

The FLX Dialer equips the user with an intuitive and interactive tool for configuring and operating the FLX System.

The Dialer is not only used to make and answer conference calls, but it is also used for configuring the system settings, answering a call using the handset, and monitoring the system components.

The FLX Dialer, shown below, is composed of several parts such as a color LCD screen, a compilation of buttons, and a microphone and handset speaker.

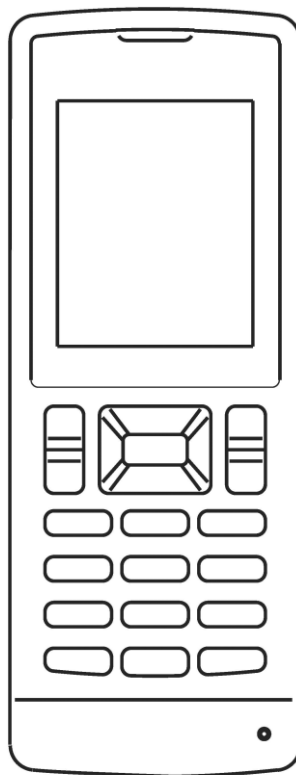

FLX Speaker

The FLX Speaker, shown below, is a wireless active omnidirectional speaker that has been designed and optimized specifically for use with the FLX Conferencing System. The Speaker is equipped with a pairing button on the bottom and 4 LED indicators on the top to display the activity of the Speaker and the mute status of the system. The Speaker can operate in or out of the Charger Base during conference calls.

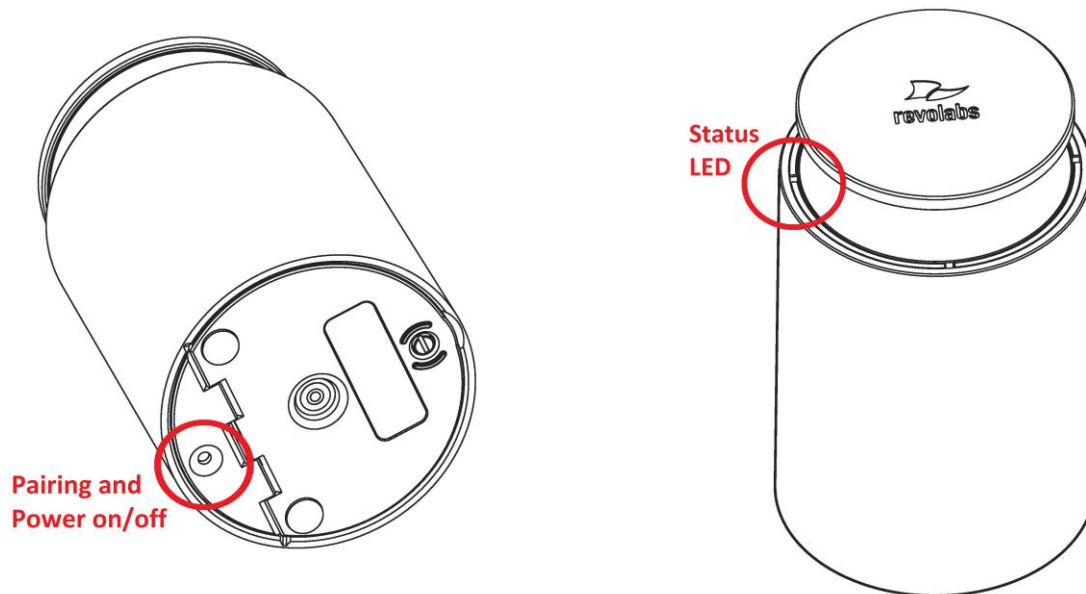

FLX Microphones

The FLX Microphones provide a sleek and unobtrusive form factor allowing for closer proximity to the participants and creating the best audio available to the far end. They are equipped with a button for pairing and muting, an LED indicator to display mute status and battery charge level, and an internal buzzer to warn if the Microphones have lost connection to the Base Station.

The FLX Microphones, shown below, come in three different versions to provide a flexible solution to meet all applications of conferencing spaces. Microphone types include an omnidirectional tabletop Microphone, a directional tabletop Microphone, or a wearable lapel style Microphone. Any combination of FLX Microphone can be used with a FLX System as they are mix and match.

FLX Microphones will not operate while in the Charger Base as they will automatically go into standby mode.

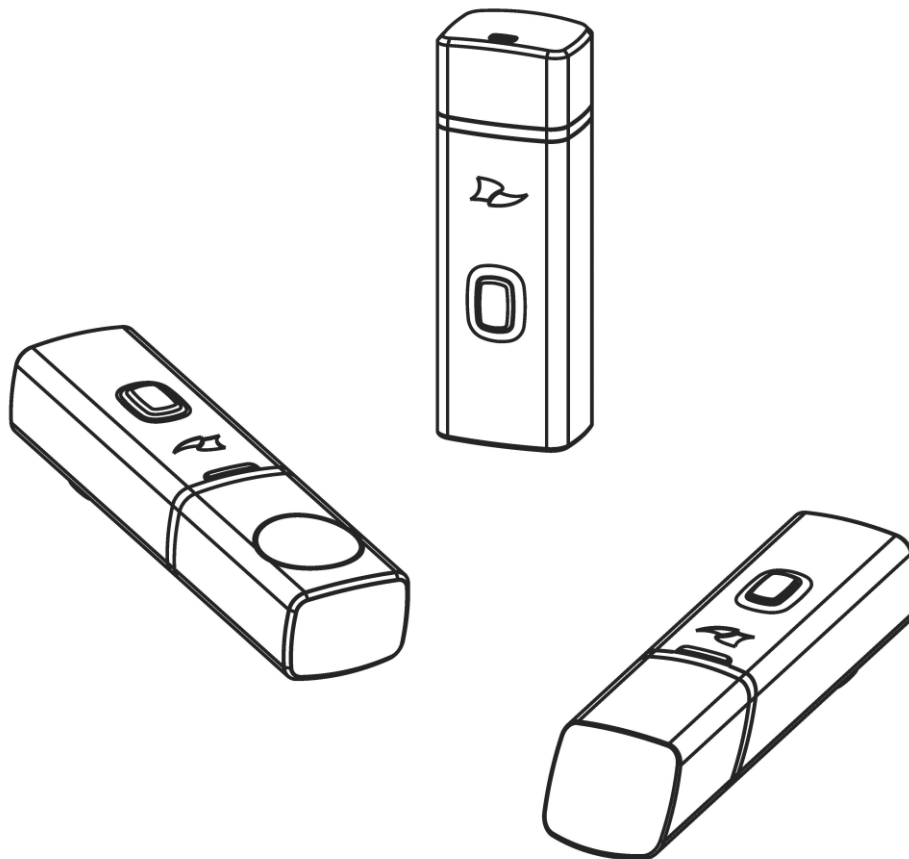

Initial Setup

After unpacking the FLX2 Conferencing System, there are a few initial setup tasks that must be performed before a call can take place or any system configuration can be changed.

Connecting System Cables

The FLX2 Base Station and Charger Base each have a power supply that needs to be connected, as shown below. In addition, the Base Station needs to be connected to the telephone network using the provided RJ11 telephone cable before a conference call can be made. The Base Station offers additional optional connections that are only being used when the FLX2 System is connected to a video conferencing unit or a recording device. The cables required for these connections are not included with the FLX2 system and need to be purchased separately.

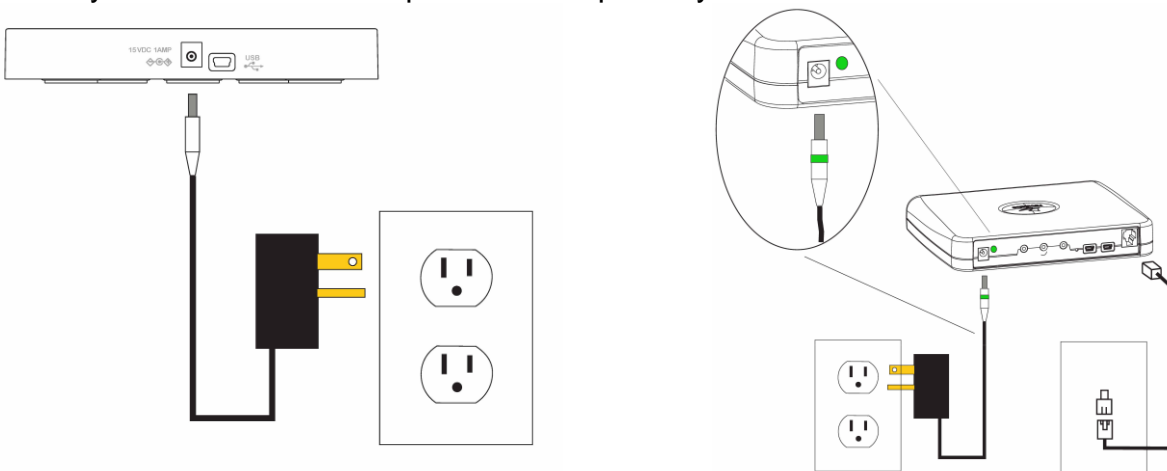

Managing A Call

The FLX2 Wireless Conferencing system is equipped with a telephone interface that allows the system to make telephone conference calls. The following are the basic operational instructions for making and receiving telephone conference calls.

Calling Configurations

The FLX2 Wireless Conferencing system has the ability to make and receive calls in many different ways. This provides the caller the ability to choose what mode or call type best suits the needs of each individual call.

Speaker Mode

Speaker mode allows the call to take place using the Speaker and Microphones provided with the FLX2 System. This allows multiple users, within the conference room, to participate in the call. It also provides the ability for the Microphones and Speaker to be located anywhere in the conference room to meet the needs of each meeting. The call, as well as the Speaker and Microphones, are controlled by the FLX Dialer. The user can switch between 'speaker mode' and 'handset mode' while in a call.

Handset Mode

Handset mode allows a telephone call to take place through the handset speaker and microphone located in the FLX Dialer. This allows a single user to make and receive a private call. It also provides the ability for the FLX2 System to act as a personal desk phone. The Microphones and Speaker are not used during a handset call. The user can switch between 'speaker mode' and 'handset mode' while actively in a call by using the key marked "Handset" or 'Speaker'.

Note: To switch from a handset call to a speaker call at least one Microphone must be out of the Charger Base and switched on, and the Speaker must be switched on.

Telephone Call

The FLX2 Conference Phone allows making conference calls using an analog telephone connection. A telephone call can be made using either 'speaker mode' or 'handset mode'. A telephone call can be made at the same time as a video call. Telephone calls are controlled via the FLX Dialer.

Bluetooth Call

The FLX2 System is equipped with a Bluetooth interface that allows a call to be made through a cell phone, a computer, or other device via a Bluetooth connection. A Bluetooth call can be made using 'speaker mode' only. A Bluetooth call is controlled by the connected Bluetooth device. A Bluetooth call can be made at the same time as a video call.

Video Conference Call

The FLX2 System can be connected to a 3rd party video or PC conferencing system via the Analog I/O ports located on the FLX2 Base Station. This allows the Microphones and Speaker to be used as the audio interface for the video conference call. Video Conference calls are controlled primarily by the video conference system. However, audio properties can be controlled via the FLX Dialer. While the FLX2 Conference Phone is connected to a video conferencing device, it might still make and accept calls over the analog telephone connection or via a Bluetooth device.

Placing a Telephone Call

1. From the home screen on the FLX Dialer enter the phone number to be called.
2. Once the number is entered completely, press the green 'call' button to initiate the phone call.
3. If any Microphones are out of the Charger Base and active, the call will default to 'speaker mode' and will be identified by the ring tone being played out of the Speaker.
4. If no Microphones are available then the call will default to 'handset mode' and the call will take place on the FLX Dialer.

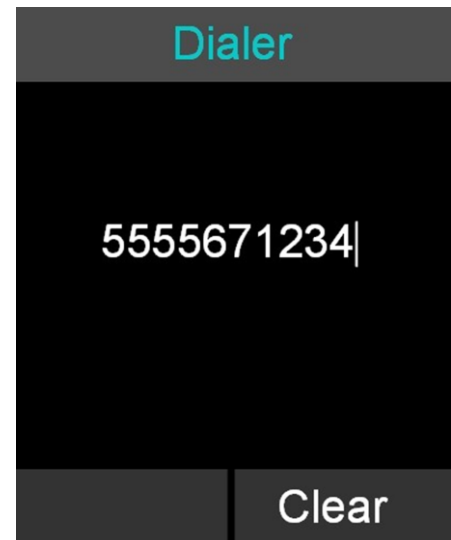

Answering an Incoming Telephone Call

1. When the FLX2 System identifies an incoming call, it will play the ring tone through the FLX Speaker. If the Dialer is not in the Charger Base it will also play a ring tone.
2. If your phone line supports caller ID, and the caller has not suppressed their caller ID information, the FLX Dialer will display the caller ID information for the incoming call.
3. A call can be answered in one of three fashions.
 - a. Press the Green 'Call' button or the 'Answer' key on the FLX Dialer.
 - b. Remove a Microphone from the charger.
 - c. Press the mute/unmute button on a Microphone that is already out of the charger.

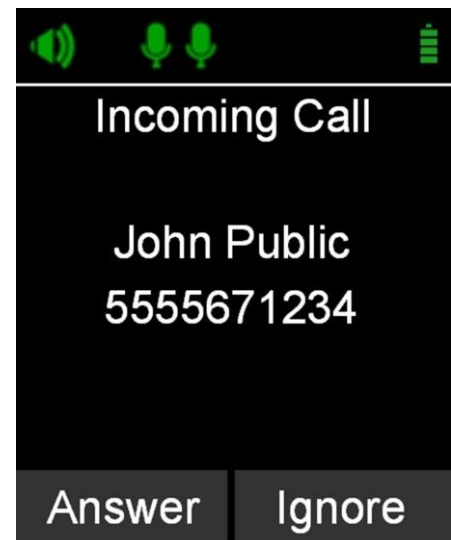

Note: If there is either no Speaker or no Microphones active and available when the incoming call is answered from the FLX Dialer, the call will default to 'handset mode' and will remain in 'handset mode'. The call can only be switched to 'speaker mode' on the FLX Dialer if at least one Microphone is out of the Charger Base and switched on and the Speaker is switched on.

Ignoring an Incoming Telephone Call

1. When the FLX2 System identifies an incoming call, it will play the ring tone through the FLX Speaker.
2. The FLX Dialer will display the caller ID information for the incoming call.
3. A call can be ignored in one of two fashions.
 - a. Press the Red 'End Call' button on the FLX Dialer.
 - b. Press the 'Ignore' key on the FLX Dialer.

Note: Once the user ignores the call, the system will cease to ring, but the option to answer is available until the caller disconnects.

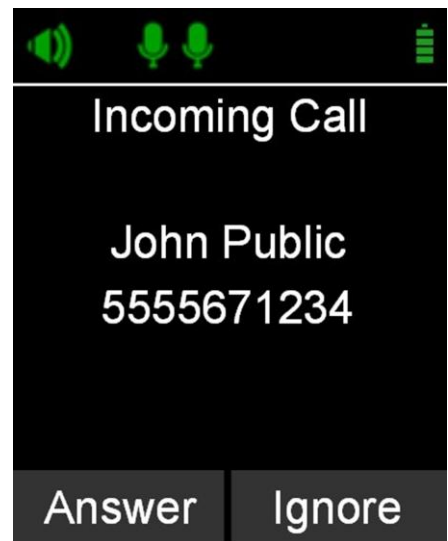

Ending a Telephone call

1. A call can be ended in one of three fashions.
 - a. Press the Red 'End Call' button on the FLX Dialer during a call.
 - b. Place the Dialer in the charger. ('handset mode' Only)
 - c. Place all the Microphones in the charger. ('speaker mode' Only)
2. When a call is ended the FLX Dialer will display the phone number and the call duration for 2 seconds.
3. After 2 seconds, the home screen is shown, and system is idle/ready for call.
4. Microphones not in the Charger Base will maintain their mute states (muted / unmuted) when a call is ended, and will start in this state when another call is made.

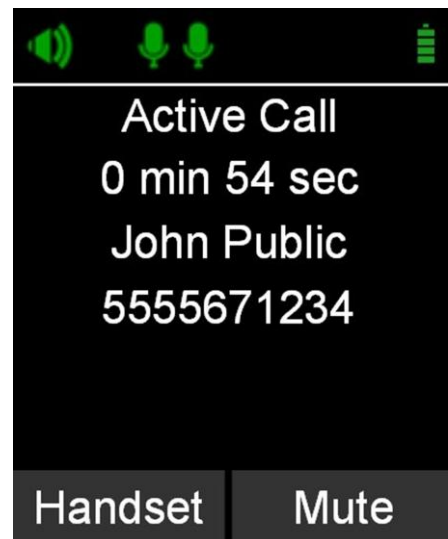

Calling a Directory Contact

1. A directory contact can be called in one of two fashions.
 - a. Browse to contact menu: Menu → Contacts. Select the contact, and press the green 'Call' key.
 - b. Browse to contact menu: Menu → Contacts. Select the contact, and press the 'Enter' key or the 'View' key. From the contact view screen, press the green 'Call' key.

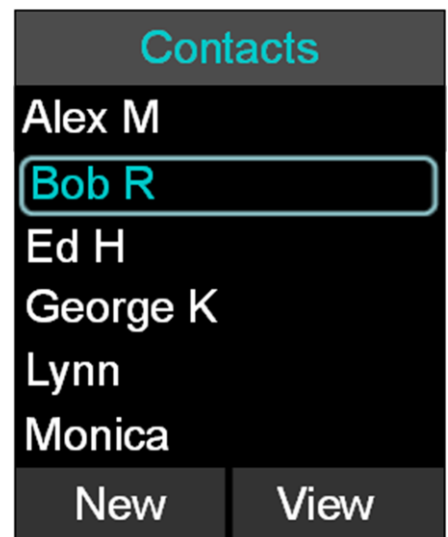

Active Call Management

The FLX2 System has many call features that can be used when receiving or making phone calls. These features can be controlled via the FLX Dialer during the call.

Caller ID

1. If the incoming caller is in the Contact List, Caller ID will display both name and number of the incoming contact.
2. If the incoming caller is not in the Contact List, Caller ID will display the incoming information from the network, which might include the telephone number and Caller ID.

Note: An incoming Bluetooth call will display caller ID information as well.

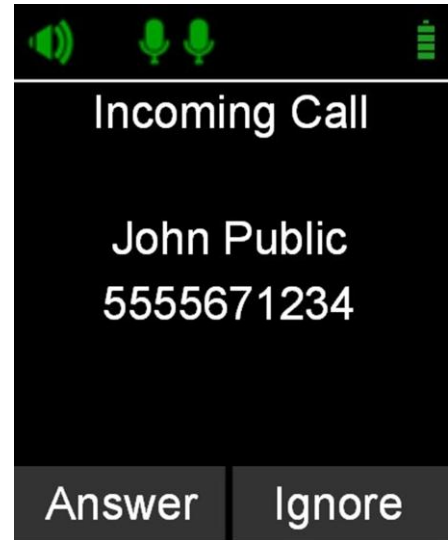

Muting a Call

1. In handset mode, the 'Mute' and 'UnMute' key will mute/unmute the FLX Dialer microphone, not the wireless Microphones.
2. In speaker mode, the 'Mute' and 'UnMute' key will mute/unmute all wireless Microphones.

Notes: The Microphone mute buttons will be locked while the Master Mute is active. The Master Mute can only be deactivated via the FLX Dialer. Once deactivated, the Microphones will return to their previous mute state.

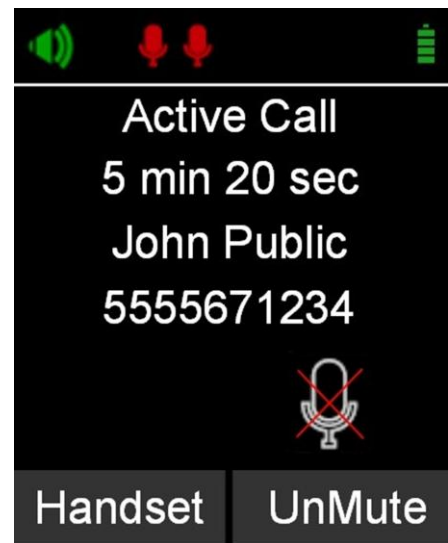

Placing a Call on Hold

1. Access Active Call Menu by pressing the 'Enter' key during a call. Select menu item 'Hold'.
2. To resume the call press the 'Resume' key.

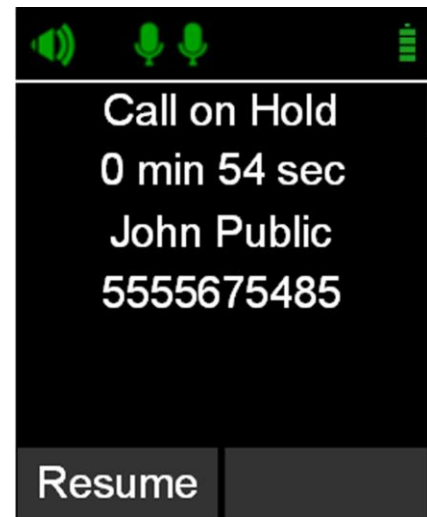

3-Way Calling

1. Press the 'Enter' key and select 'Conference'.
2. Create the second call by selecting Dialer, Contacts, or Recent.
3. Merge the two calls by pressing green 'Call' button again.

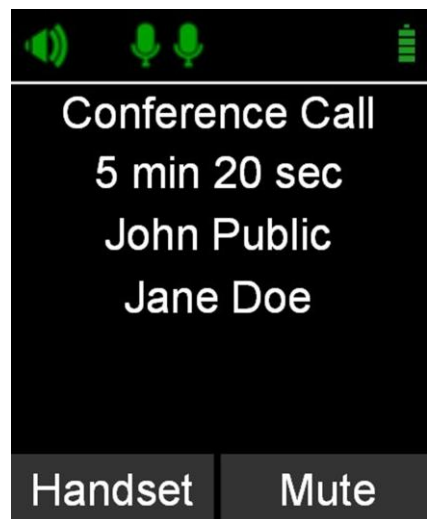

Call Waiting

1. While a call is active and the FLX2 System receives a second call, the Speaker or Dialer will play the call waiting indication tone.
2. If available, the FLX Dialer displays the incoming caller number and name.
3. The FLX Dialer presents the user with the option to 'Answer' the call.
4. If no action is taken and the second call aborts, the FLX Dialer will show the previous Active call screen again.
5. When answering the second call, the first call is put on hold. Use the green 'Call' button to resume the first call, ending the second.

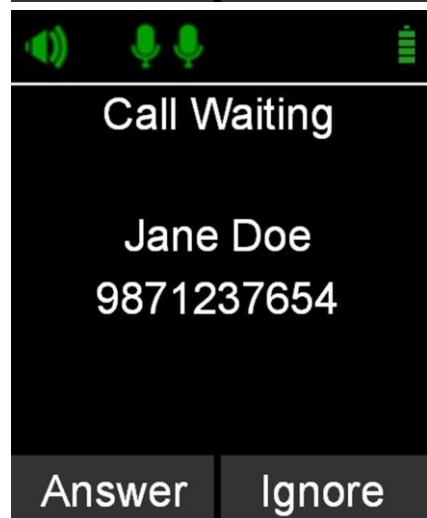

Note: When using the red 'End Call' button while another caller is on hold, that caller will remain on-hold in the telephone network. The FLX2 Conference Phone will not be able to retrieve that call.

Charging Components during a Call

Each system component will respond differently when placed in or out of the charger during an active telephone call. The following is a description of what can be expected.

Dialer

When the Dialer is placed into the Charger Base during a call in 'speaker mode', the call will not be affected and the Dialer will enter its charging mode.

When the Dialer is placed into the Charger Base during a 'handset mode' call, the call will end and the Dialer will enter its charging mode.

When the Dialer is removed from the Charger Base no change to call activity will take place. If there is no active call, the Dialer will revert to the home screen.

Speaker

When the Speaker is placed into the charger during a call the Speaker will reboot and enter its charging mode. During the reboot the incoming audio from the conference call will mute until the reboot is complete (Approximately 6 seconds). Once the Speaker reconnects the audio will resume.

When the Speaker is removed from the charger no change to call activity will take place.

Microphones

When a Microphone is placed into the charger during a call it will automatically mute and enter its charging mode. If all Microphones are placed into the charger at the same time while in speaker mode, the telephone call will be terminated.

When a Microphone is removed from the charger, it will automatically power on and if "Start Unmute" is ON, unmute itself. If there is an incoming call when a Microphone is removed from the charger the call will automatically be answered.

Bluetooth

The FLX2 System is equipped with a Bluetooth interface allowing a call to be placed through a cell phone, computer, or 3rd party Bluetooth device. The FLX Microphones and Speaker then act as the Microphone and Speaker for that call.

Activating Bluetooth

1. Go to the Menu → Bluetooth. Select 'Turn On' to activate Bluetooth.
2. Select 'Yes' when prompted 'Enable Bluetooth Radio?'

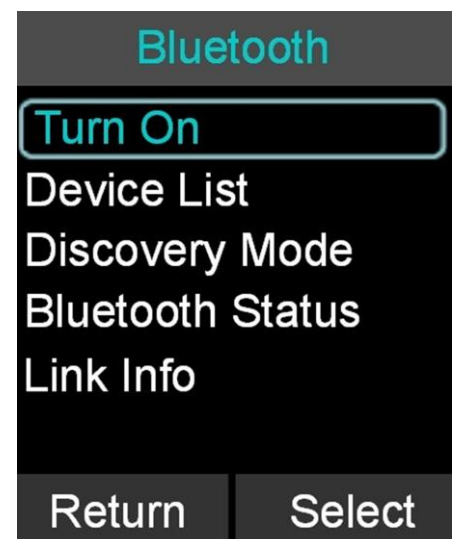

Managing the Device Registry

The FLX2 Bluetooth interface has a device registry where it activates, stores and recalls 3rd party Bluetooth devices being used by FLX2 for Bluetooth Calls.

Device List

1. Go to the Menu → Bluetooth. Select 'Device List'.

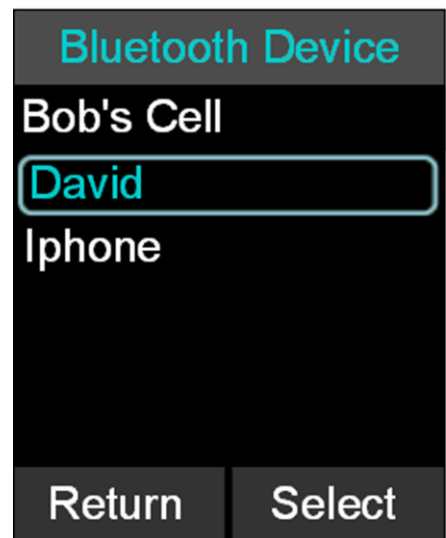

Adding a Device

1. Go to the Menu → Bluetooth. Select 'Discovery Mode' to activate Bluetooth and accept Bluetooth Request from other devices.
2. The FLX Dialer displays "This device is visible to other devices in range for 3 minutes"
3. Scan for devices from the Bluetooth device you want to connect to the FLX2 System.
4. When the FLX2 System's name shows up on the Bluetooth device, select the FLX2 System, and connect to it.
5. If prompted for confirmation, select 'yes'. If prompted for pin, type '0000' (default).
6. Press the 'Stop' key in order to abort pairing processes.

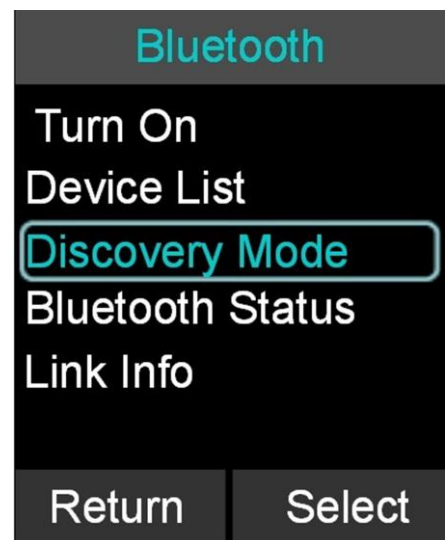

Removing a Device

1. Go to the Menu → Bluetooth. Select 'Device List'.
2. Select desired device and press the 'Option' key.
3. Select 'Unpair' in the Device Options menu.

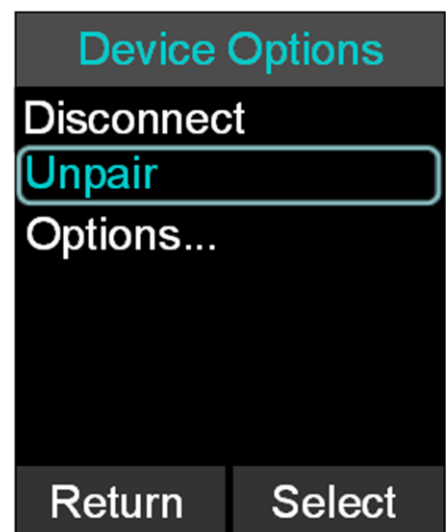

Viewing Device Details

1. Go to the Menu→ Bluetooth. Select 'Device List'.
2. Select desired device and press the 'Enter' key or the 'Select' key to view device details
3. Device Information screen is shown with device name, address, BT version, and date/time the device was first connected.

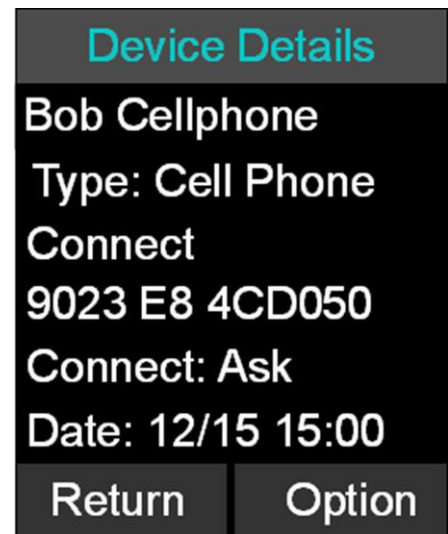

Accepting Device Connection Request

If the trust setting for a previously paired Bluetooth device is set to 'Ask' and that device comes into range with the FLX2 System, a message will appear on the FLX Dialer.

1. Select 'Yes' to have the FLX2 System pair with the Bluetooth device and be ready for use.
2. Select 'No' to have the FLX2 System ignore the Bluetooth device until the next time it comes into proximity of the FLX2 System.

Setting Device Trust Level

1. Go to the Menu→ Bluetooth. Select 'Device List'.
2. Select the desired device and press the 'Enter' key or the 'Select' key to view the device details.
3. Press the 'Option' key and then select 'Options...'
4. Choose either 'Auto-Connect' or 'Ask' depending on the trust level you want to set for the Bluetooth Device.

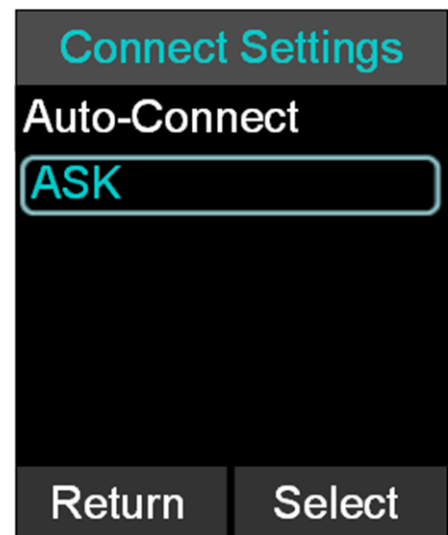

Making a call via Bluetooth

1. With the Bluetooth connection enabled, dial a number from the Bluetooth device. The call will be conducted using the FLX Speaker and Microphones.

Answering a call via Bluetooth

1. You can answer a Bluetooth call either directly from your FLX system only if at least one microphone is out of the charging bay, and switched on. If answering the call with the FLX system it will automatically be in speaker mode.
2. If you answer the call using your Bluetooth device, settings on that device will determine whether the call will be answered as a speaker call using the FLX Conference Phone, or as a call using other audio devices. If you want to have a private call not using the FLX as the Speaker of the call, ensure that you select the correct audio output device in your Bluetooth enabled device.

Video Conference Collaboration

The FLX2 System is equipped with balanced analog audio input and output to be connected to 3rd party video or PC conferencing system. This allows the FLX Microphones and Speaker to be used as Microphones and Speaker for the video call. It also provides Acoustic Echo Cancellation and Noise Control to the video call.

Connecting a Video Conference System

In the advanced audio setting (see page 35), change the Aux Audio setting for Aux Out to MIC. Then connect one of the AUX OUT on the FLX2 Base Station via an appropriate mono balanced or unbalanced cable with 3.5mm plugs to the 'Mic Input' on the video conference system.

The line level audio AUX IN on the FLX2 Base Station should be connected, via the appropriate mono balanced or unbalanced 3.5mm cable, to the 'line output' of the video conference system.

Configuring the Analog Audio

See page 32 on how to set the level for the AUX IN connector. This can be either microphone level or line level.

See page 35 on setting the volume for the AUX OUT connector.

Making a Video Call

The FLX2 System acts as a wireless Microphone, Speaker and mixer for the video conference call. Once configured, a video call can be made using the 3rd party user interface supplied with the video conference system. Simply remove the Microphones from the charger to activate the analog audio input.

FLX2 System Configuration

There are many features to the FLX2 System that can be modified and configured using the FLX Dialer. The following is a list of those features and their options.

Menu Hierarchy

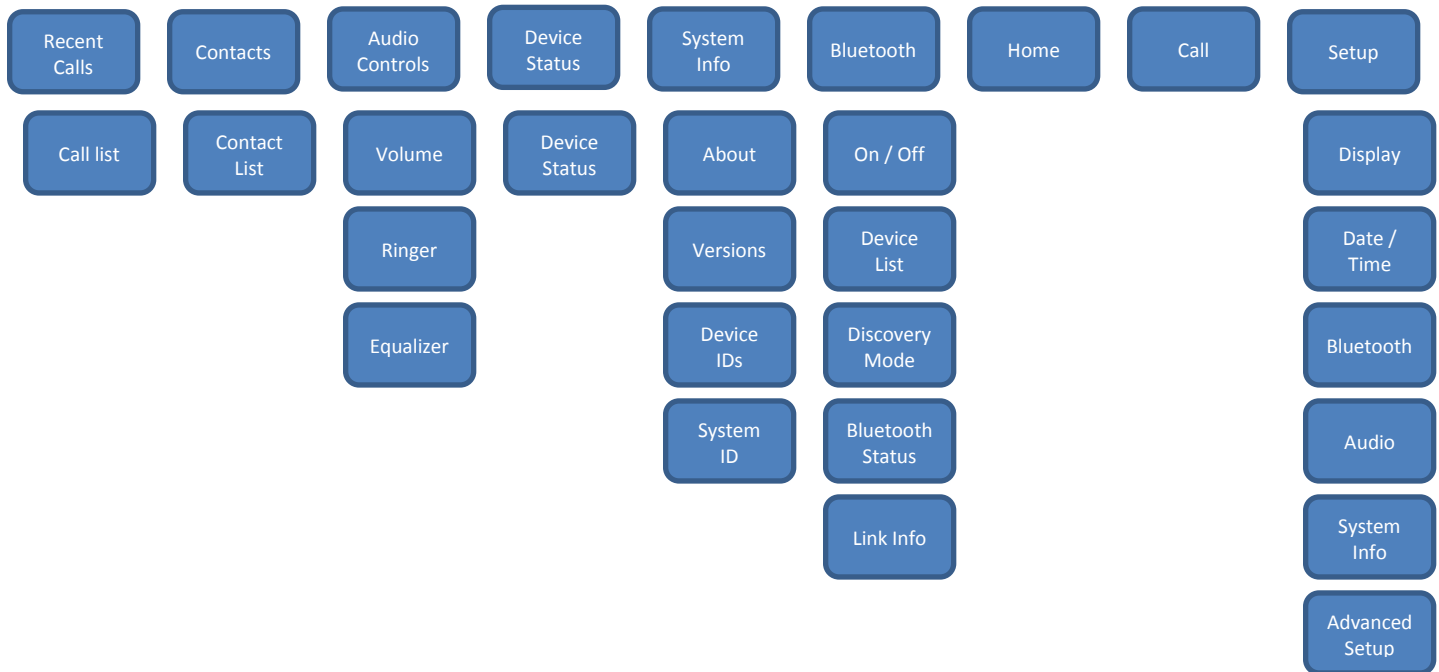

Menu Navigation

1. The left, right, up and down navigation keys are used to highlight an icon and the Enter key is used to make a selection.
2. Up and Down navigation keys are used to scroll through the menu. The Left navigation key will return to the previous menu.
3. When setting levels, such as Volume, in the menus, the Up and Down keys are used to change these values.

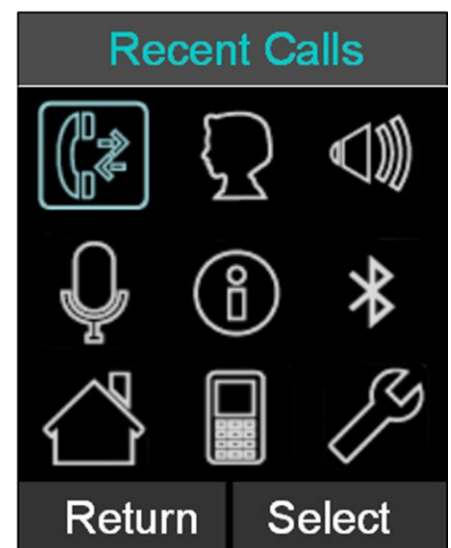

Recent Calls

The Recent Calls call log stores the contact information from calls placed or received, allowing the user to review recent calls, redial a recent call, or store a recent call in the system directory.

Recent Call Log

1. Access recent call log by browsing: Menu → Recent Calls
2. The recent call list is sorted chronologically with most recent call at top
3. If a recent call was made by a number stored in the Contact list, the contact name is shown in this menu, otherwise the caller ID is shown.
4. The recent call log can be accessed directly from the home screen by pressing green 'Call' button in idle state.
5. The recent call log is limited to 20 entries.

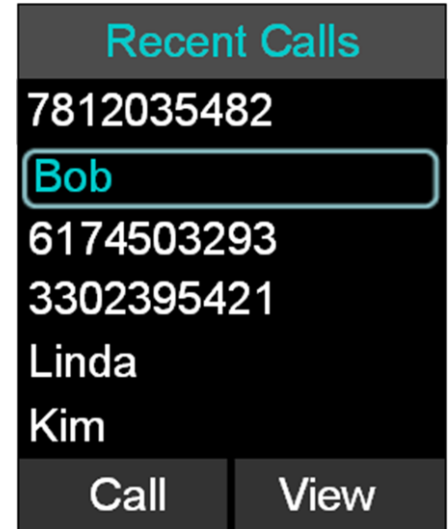

Call Recent Caller

1. Access the recent call log by browsing: Menu → Recent Calls or pressing the green 'Call' button while no call is in progress.
2. You can call an entry in the recent caller list in one of three fashions
 - a. In the recent call list, select the entry you want to call using the up and down buttons, and press 'Call'
 - b. Pressing the green 'Call' key will also call the entry currently highlighted in the recent call list.
 - c. In the recent call list, select the entry you want to call, and press 'View'. This displays more information. From that screen, you can press the green 'Call' key to call the entry you are viewing.

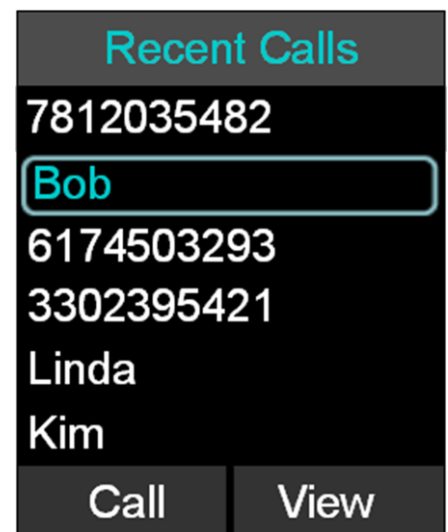

View Recent Call Information

1. Access the recent call log by browsing: Menu → Recent Calls or pressing the green 'Call' button while no call is in progress.
2. You can view a recent call one of two ways:
 - a. In the recent call list, select the entry you want to view, and press the 'View' key. This displays more information for the recent call you selected.
 - b. In the recent call list, press enter to bring up the Options menu. Select 'View Recent Call' to display more information for the recent call you selected.

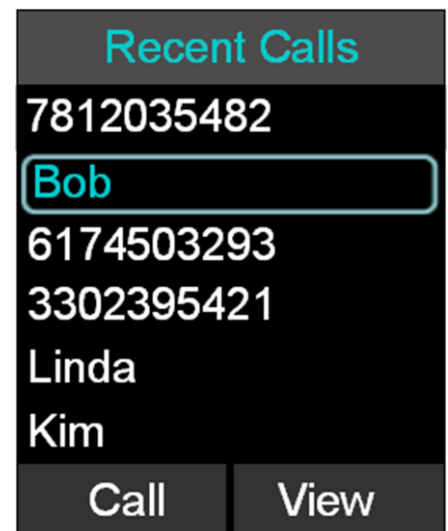

Save Recent Caller as Contact

1. Access the recent call log by browsing: Menu → Recent Calls or pressing the green 'Call' button while no call is in progress.
2. In the recent call list, select the entry you want to add to the contacts, and press 'View'. This displays more information for the recent call you selected.
3. Press the 'Save' key to save the recent call as a Contact. If a caller name was provided as part of the Caller ID it will be provided as the contact name. Enter or edit the contact name when prompted and press 'Done'. Verify and edit if necessary the recent contact number and press 'Done' again.

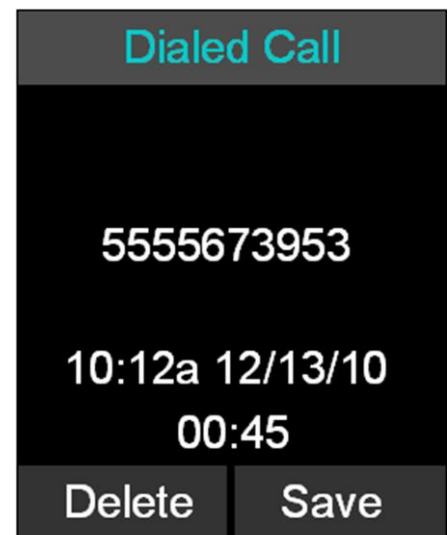

Delete Recent Call Entry

1. Access the recent call log by browsing: Menu → Recent Calls or pressing the green 'Call' button while no call is in progress.
2. In the recent call list, select the contact you want to delete, and press the 'View' key. This displays more information for the call you selected.
3. Press the 'Delete' key to delete the recent call. Press 'Yes' when prompted for confirmation.

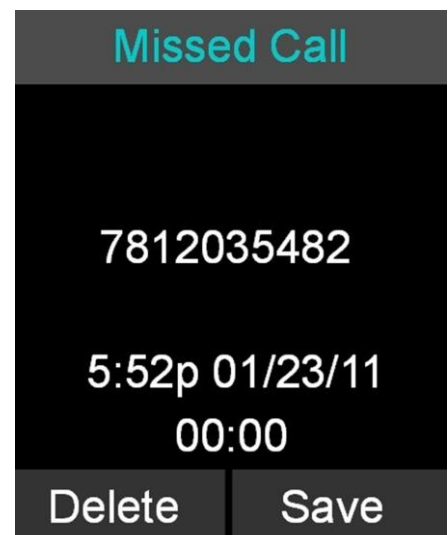

Delete Call History

1. Access the recent call log by browsing: Menu → Recent Calls or pressing the green 'Call' button while no call is in progress.
2. In the Recent Call menu, press 'Enter' to open the Options Menu.
3. In the Options Menu select 'Delete Redundant' to delete redundant call history information, or select 'Delete All Calls' to delete all call history information.
4. Press 'Yes' to delete the information when prompted for confirmation.

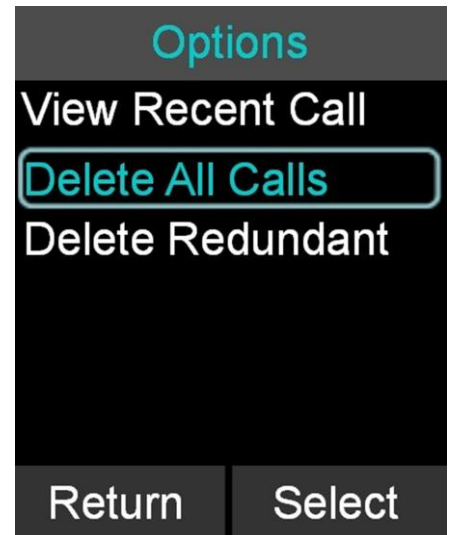

Contacts

The FLX Dialer can store 99 entries in a contact directory (phone book). The following is a list of features and menus that allow managing the contact directory.

View Contact List

1. The contact list can be viewed in one of two fashions
 - a. Browse to the Contacts menu: Menu → Contacts, or
 - b. From the home screen, in idle/ready state, press the right arrow key.

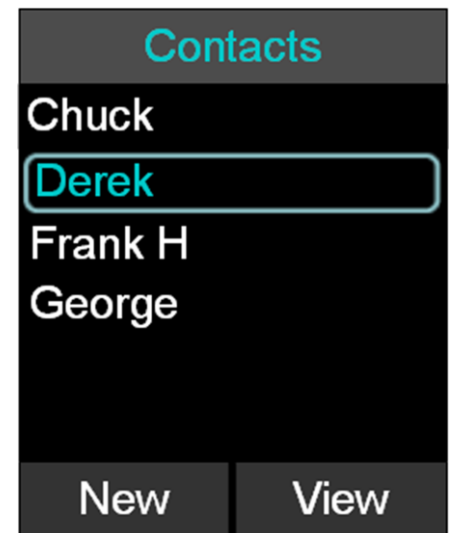

Add a Contact

1. Browse to the Contacts menu: Menu → Contacts.
2. Press the 'New' key to create a new contact.
3. Edit the name in alphanumeric mode. Pressing 'Clear' while editing the name will delete the character left of the cursor. Press 'Done' when finished editing the name. This will bring you to the number editing screen.
4. Edit the phone number. The key 'Clear' will delete the character to the left of the cursor. Pressing 'Done' will store the new contact in memory.
5. Once the editing is finished, the menu will return to the previous menu/screen.

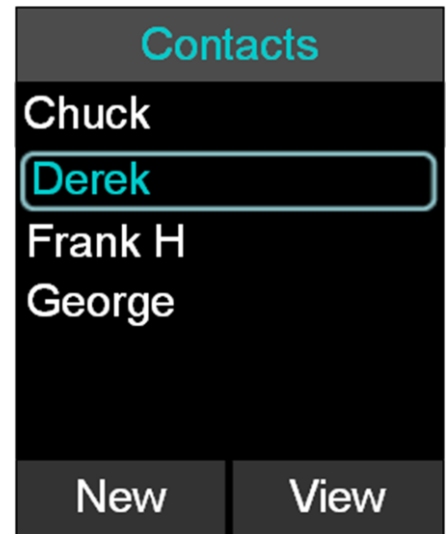

Edit a Contact

1. Browse to the Contacts menu: Menu → Contacts, scroll to the desired contact, and select 'View' to access the contact.
2. The contact screen shows the current name and number. Pressing the 'Edit' key will open the Edit Contact menu.
3. In the Edit Contact menu, select 'Edit Info' to edit the selected contact.
4. Edit the name in alphanumeric mode. Pressing 'Clear' will delete a character to the left of the cursor. The key 'Done' will finish editing the name and go on to the number editing screen.
5. Edit the phone number. The key 'Clear' will clear/delete the number to left of cursor. When finished, press the 'Done' key to store the edited contact in memory.
6. The contact list menu is shown once editing is completed.

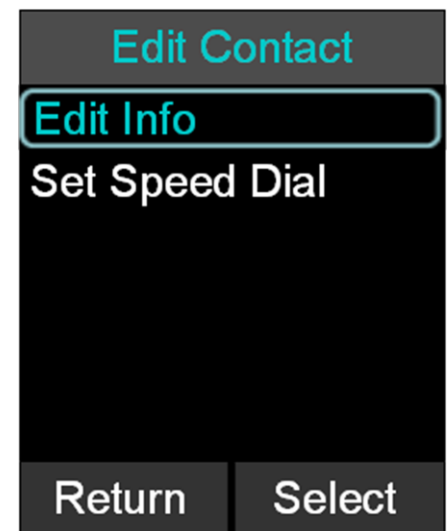

Delete a Contact

1. Browse to the Contacts menu: Menu → Contacts and press 'View' to access a contact.
2. The contact view screen shows the contact name and number. Pressing the 'Delete' key will delete the selected contact.
3. Press 'Yes' when prompted for confirmation.

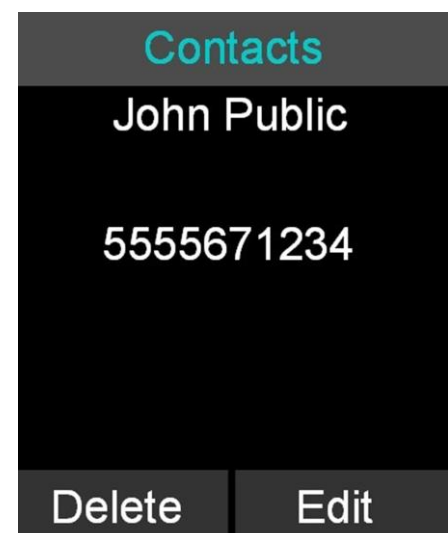

Search for Contact

1. Browse to the Contacts menu: Menu → Contacts.
2. Use the keys (0-9) to apply a filter
 - a. Once a key is pressed the title line will read 'Contact()' and display the characters being typed.
 - b. The search string can be up to 5 characters long.
 - c. In this mode the 'Clear' key will delete the last character in the filter field.
3. Only contact items that satisfy the filter will be shown in the contact screen. For example, if 'C' is entered, any contact name starting with 'C' will be shown. The user can scroll through the filtered list using the up and down buttons.

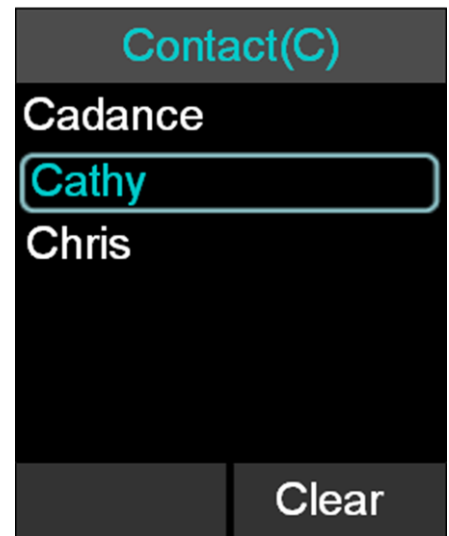

View Contact Information

1. Browse to the Contacts menu: Menu → Contacts.
2. Select the contact by using the 'up' and 'down' keys
3. Press 'Enter' or 'View' when the contact is selected
4. Information for the selected contact is displayed

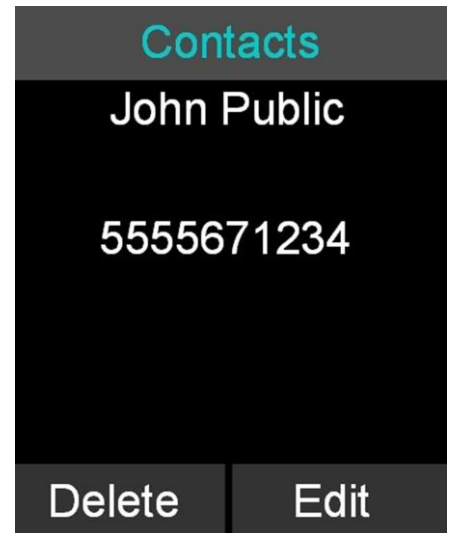

Call Contact

1. Browse to the Contacts menu: Menu → Contacts.
2. Select the contact by using the 'up' and 'down' keys
3. Press the green 'Call' key to call the contact currently highlighted on the contact menu.
4. Pressing the green 'Call' key from the contact view screen will also initiate a call.

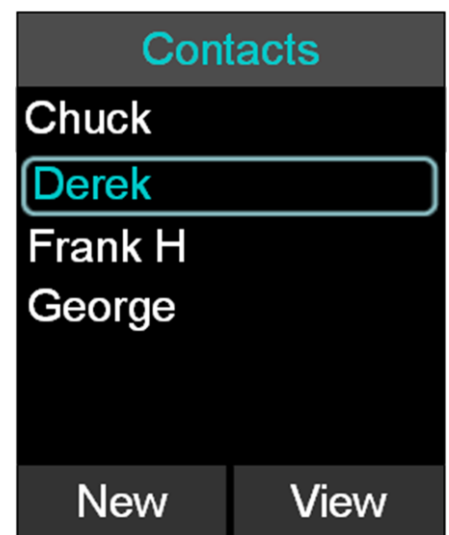

Set Speed Dial

1. Browse to the Contacts menu: Menu → Contacts, scroll to the desired contact, and select the 'View' key to access the contact.
2. The contact view screen shows the current name and number. Pressing the 'Edit' key will open the Edit Contact menu.
3. In the Edit Contact menu select 'Set Speed Dial'.
4. Scroll to the desired speed dial number and press the 'Set' key.
5. If this speed dial number is already set, an overlay will appear asking 'Overwrite Speed Dial X?'

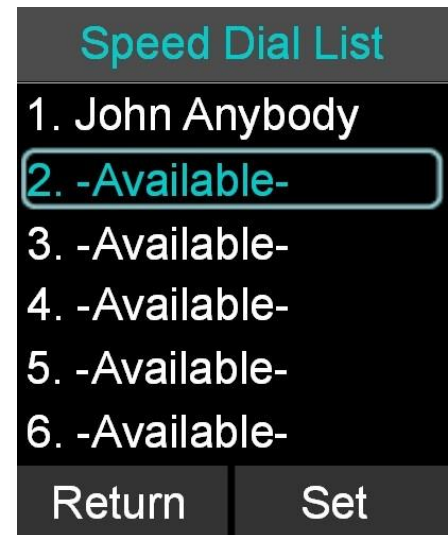

Audio Control

The following is a list of FLX Dialer menus that adjust the system attributes related to speaker audio, Analog audio inputs/outputs, and telephony audio configurations.

Speaker Volume

1. Browse to the Speaker Volume menu: Menu → Audio Controls → Volume → Speaker Volume.
2. The Speaker Volume screen is shown with graph and numerical value of the current volume level.
3. Press the up and down buttons to increase or decrease the volume.
4. During an active call you can also set the volume by pressing the up and down buttons. In speaker mode the speaker volume is set from this command. In handset mode the volume on the Dialer is adjusted.



Ringer

1. Browse to the Ringer menu: Menu → Audio Controls → Ringer.
2. Choose 'Ringer Volume' in the Ringer Settings menu to adjust the Ringer Volume.
3. Press the up and down buttons to increase and decrease the volume.
4. Choose 'Ring Tone' in the Ringer Settings menu to select a ring tone.
5. Use the up and down buttons to select a ring tone, and press enter to set the selected ring tone.

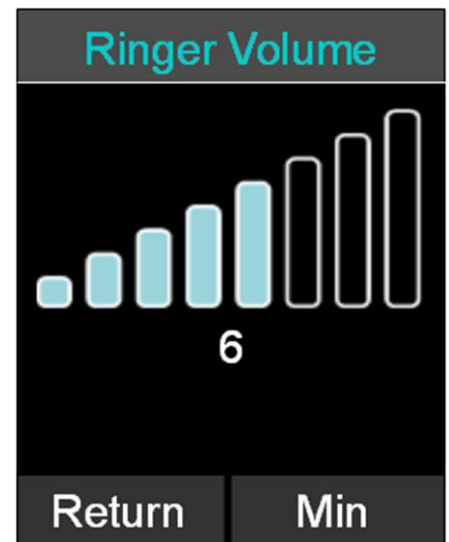

Equalizer (EQ)

1. Browse to the Equalizer Settings menu: Menu → Audio Controls → EQ.
2. Use the up and down buttons to select a preset EQ, and press enter to set the selected EQ.
3. The selected equalizer will be listed in upper case letters, while the others are listed in lower case letters. In the example to the right, FLAT is currently the selected EQ Setting.

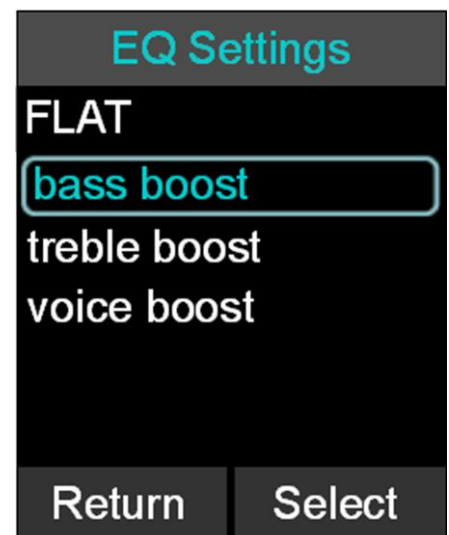

Aux In Level

1. Browse to the Aux In Volume menu: Menu → Audio Controls → Volume → Aux In Level.
2. Press the up and down buttons to increase and decrease the level.



Device Status

1. Browse to Device Status: Menu → Device Status.
2. The Device Status screen shows status for the Microphones and the Speaker.

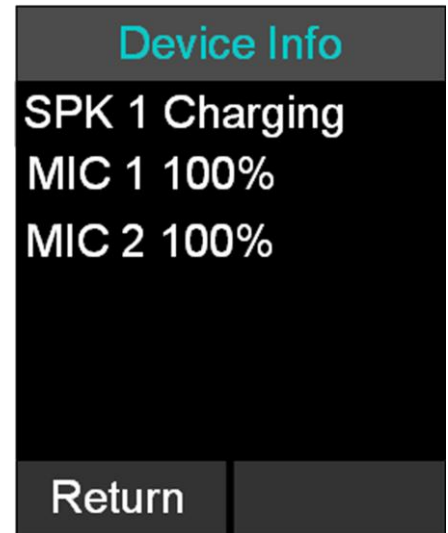

System Information

The following is a list of FLX Dialer menus that allow the user to retrieve system information.

System Info

1. Browse to System Info: Menu → System Info.
2. About System shows the firmware (FW) bundle version, the System Name, and phone type information.
3. Device Versions shows firmware version for the Speaker (SPK) and Microphones (MIC1, MIC2).
4. System Versions shows the firmware versions for the Application (APP), Baseband (BB), Bluetooth Dialer (BTH), and Bluetooth Base (BTB) software.
5. Device IDs shows the ID of the Speaker (S1) and the Microphones (M1, M2).
6. System ID shows the ID of the base.



Bluetooth

The 'Bluetooth' menu has been explained earlier in this manual on page 21.

Home

When selecting the 'Home' menu item, the Dialer will go back to displaying the home screen. The same effect can be achieved by pressing the 'Return' key, or the red 'End Call' button.

Call

When selecting 'Call' in the menu, the Dialer will open the Dialer menu, allowing dialing a number.

Setup

Setup is divided into a generic area of features that are not password protected and Advanced Setup, which requires a password.

Display

1. Browse to the Display menu: Menu → Setup → Display.
2. The Display menu offers three options: Contrast, Brightness, and Backlight time.
3. Use the up and down buttons to highlight the setting you want to change, and press either 'Enter' or 'Select' to open that setting.
4. Use the up and down buttons to increase or decrease the respective values.

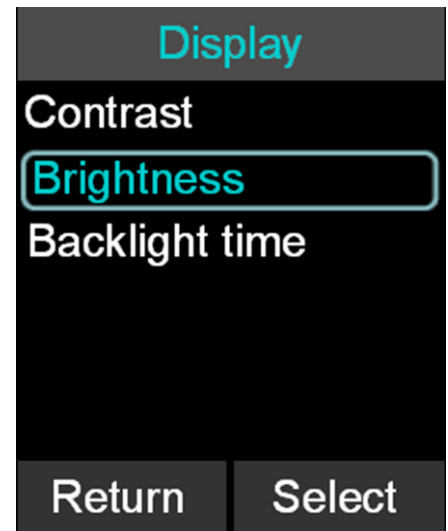

Date/Time

1. Browse to the Date/Time menu: Menu → Setup → Set Date/Time.
2. To set the date or time, select either the Set Date, or Set Time option, and press either 'Enter' or 'Select'.
3. Edit time and date (month/day/year) using the numeric keys and the left and right buttons. The 'Done' key will store the value.
4. To change the use of the network time, select the 'Netwrk Time ON/OFF' option. You change the setting by pressing the 'Select' key. If you select 'Netwrk Time ON' the FLX2 Conference Phone will attempt to derive the date and time from the telephone network.

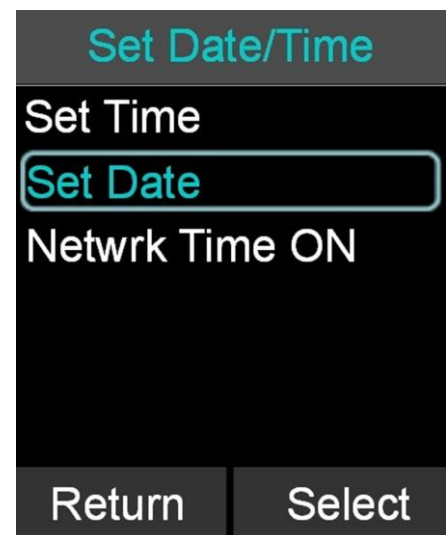

Advanced Setup

The following is a list of advanced configuration settings that are protected by a 4 digit password for administrator access only. The default password is 7386 (revo). This password should be changed by the system administrator.

Advanced Audio

1. Browse to Advanced Audio menu: Menu→ Setup→ Advanced Setup→ Advanced Audio.
2. The Advanced Audio menu includes options for: 'All Mic Mute (ON/OFF)', 'Start Unmute (ON/OFF)', 'Aux Audio', 'Auto Gain', and 'AEC'.
3. If 'All Mic Mute' is ON, all Microphones are muted or unmuted when a mute button is pressed on any one of the Microphones. The factory default is OFF.
4. The 'Start Unmute' feature allows the Microphones to come out unmuted when taken out of charger. The factory default is ON.
5. 'Aux Audio' is to control the AUX In and AUX Out connections on the base. It allows switching these on or off. It also allows adjusting the levels on the AUX In and AUX Out connectors, and the Aux Out type (LINE or MIC).
6. 'Auto Gain', when ON, allows to control the Target Loudness, Response Time, and the Noise Threshold. When OFF, none of these values can be changed.
7. 'AEC' is to control the Acoustic Echo Cancellation Level of the different Microphones (Omni, Directional, or Lapel).

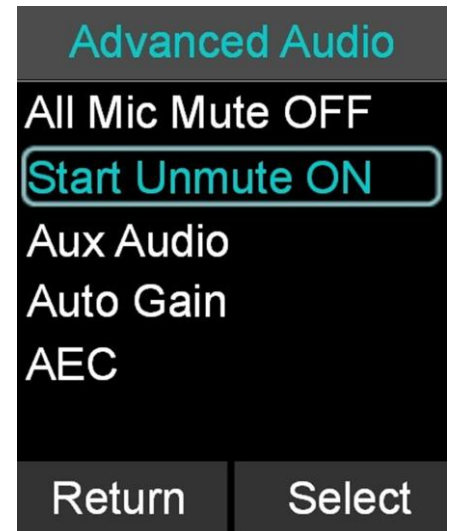

RF Power

1. Browse to the RF Power menu: Setup → Advanced Setup→ RF Power.
2. The user can adjust the RF Power from 0 to 4.

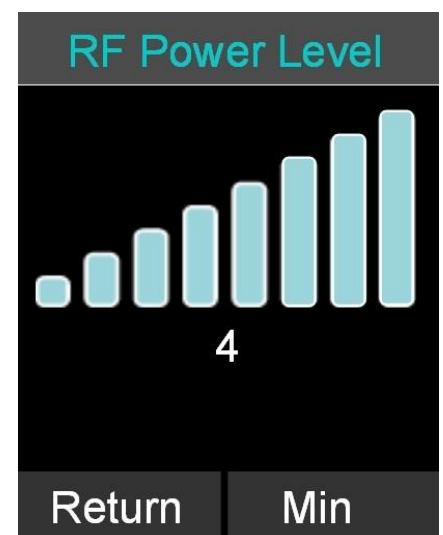

Setting System Name

1. Go to Menu → Setup → Advanced Setup → Admin Settings → Set System Name.
2. Change the current System Name to the new name, and press Enter.

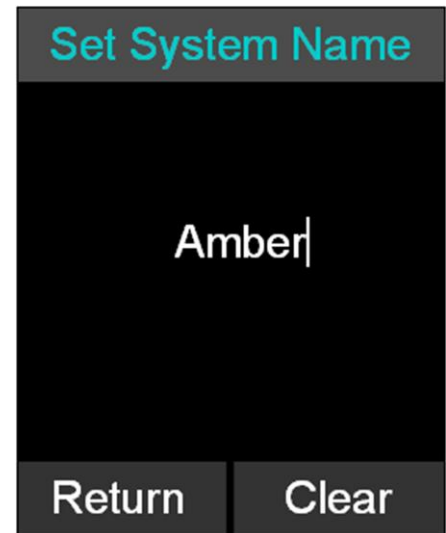

Reset Defaults

1. Go to Menu → Setup → Advanced Setup → Admin Settings → Reset Defaults.
2. Resetting defaults will revert back to factory defaults. Pairing of devices, recent calls, the contacts, and the system name are not affected by this.

Set Password

1. Browse to the Set Password menu: Menu → Setup → Advanced Setup → Admin Settings → Set Password.
2. Set the password to an admin specified password. Note that setting this password will override the default password, so do not lose the new password.

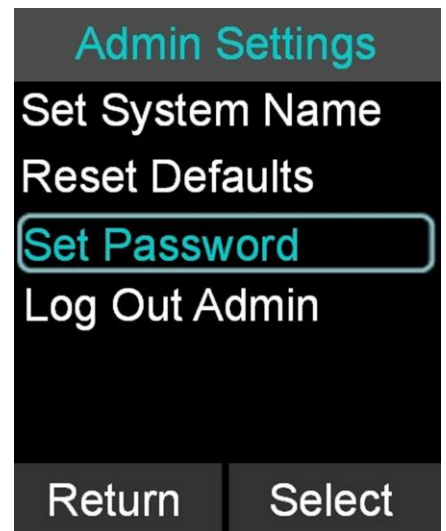

Log Out Admin

1. Browse to Log Out Admin: Menu → Setup → Advanced Setup → Admin Settings → Log Out Admin.
2. Once logged out, the user will have to retype the admin password to enter the administrative menus again. If the user leaves the administrative menus without logging out, an automatic log-out will happen after about 15 minutes.

Pairing

All FLX2 wireless components are paired before the system is shipped, providing much of the system setup already completed. While pairing should not be required for the system to work, sometimes components can require pairing if a part is shipped separately. The following are instructions on how to pair the wireless components of the system to the FLX2 Conference Phone.

To pair the FLX Dialer, follow this procedure. Please note that Microphones and Speakers require a Dialer to be paired with the Base Station before you can pair them.

Dialer

1. If the Dialer is turned on, turn it off by pressing and holding the red 'end call' button until an overlay appears asking whether you want to shut the Dialer down. Press 'Yes'.
2. Plug in the FLX2 Base Station.
3. Turn the Dialer back on (press the red 'end call' key). The screen should read "Scanning for new base". If the screen reads "scanning for paired base", press the 'Stop' button, press the 'Menu', and select 'Re-Pair'. When asked whether to 'Scan for New Base', select 'Yes'.
4. After some time scanning for available bases, an overlay will appear asking 'Pair with <System Name>?' Select 'Yes'.
5. An overlay, 'Pairing with base <System Name>', should appear followed by a 'Connecting...' and then an 'Initializing...' screen. Shortly after that the Dialer home screen will appear. Your Dialer is now paired.
6. If the Dialer does not automatically pair, repeat steps 1-5. If this still does not resolve the problem, select "Reset Factory Defaults" as this will force a scan for a new base.

Speaker

1. To pair a Speaker, if the Speaker is turned on, turn it off by pressing and holding the button on the bottom of the Speaker until you hear the Speaker shut-off or the LEDs turn off.
2. Ensure that the Base Station is plugged in and powered up.
3. On the Dialer, browse to the Pairing menu: Menu → Setup → Advanced Setup → Pairing.
4. Select SPK 1 (Speaker 1) and press the 'Enter' or 'Pair' key to enter pairing state.
5. The screen will display 'Pairing Speaker 1'.
6. Press and hold the button on the bottom of the Speaker until the LED turns solid red.
7. An overlay will appear on the Dialer "Pairing Successful", after that the screen should read 'SPK 1 Linked'.
8. If pairing was unsuccessful, the Speaker will show an alternating red-green slow blinking sequence indicating

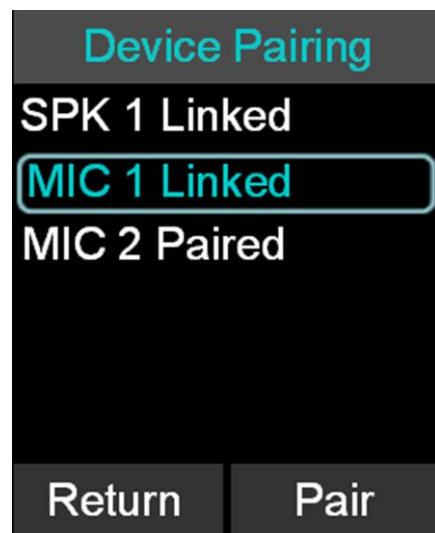

that the pairing failed. The Dialer will display a 'Pairing Timeout' message. In that case the pairing procedure should be repeated.

Microphone

1. To pair a Microphone, turn off the Microphone by holding the mute button until the LED turns red if it is not already turned off.
2. Ensure that the Base Station is plugged in and powered up.
3. On the Dialer, browse to the Pairing menu: Menu → Setup → Advanced Setup → Pairing.
4. Select MIC 1 (Microphone 1) or MIC 2 (Microphone 2) and press the 'Enter' key to enter pairing state.
5. The screen will display 'Pairing Mic 1' or 'Pairing Mic 2' depending on which Microphone you are pairing.
6. Press the mute button on the Microphone and hold it until the LED turns solid red.
7. An overlay will appear on the Dialer 'Pairing Successful', after that the screen should read 'MIC 1 Linked' or 'MIC 2 Linked', based on which one you were linking.
9. If pairing was unsuccessful, the Microphone will show an alternating red - green slow blink sequence, indicating that the pairing failed. The Dialer will display a 'Pairing Timeout' message. In that case the pairing procedure should be repeated.

LED Pairing Indicators:

Speaker Indicator	Status
Steady Red	Speaker is in Pairing Mode, either waiting or pairing in progress
Slow red- green flash	Pairing failed or timed out
Green flash	Pairing successful
Microphone Indicator	Status
Steady Red	Pairing Mode, either waiting or pairing in progress
Slow red – green flash	Pairing failed or timed out
Green flash	Pairing successful

Phone Settings

1. Browse to the Phone Settings menu: Menu → Setup → Advanced Setup → Phone Settings.
2. The Phone Settings menu includes settings for Dialing: (Tone/Pulse) and Phone Number.
3. You can change the dialing method by selecting the entry, and then pressing the 'Select' key. The factory preset is TONE.
4. You can set the telephone number of the FLX2 System using the Phone Number setting. Select this entry, type in the number, and press 'Enter' to capture the telephone number.

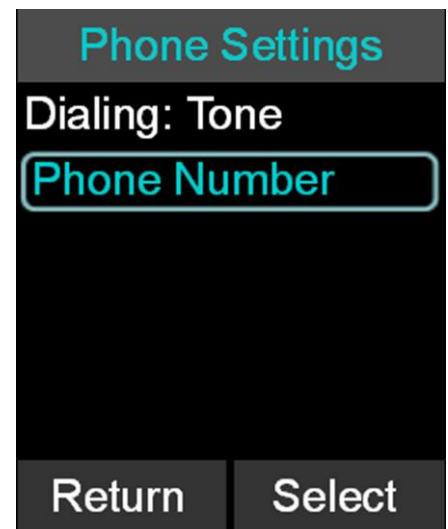

Power On/Off the System Components

During normal use and operation of the FLX2 System, there is no need to turn off any part of the system. However, if the system is going to be stored without the Charger Base powered on, then each component should be powered off until further use.

Dialer On/Off

To power off the FLX Dialer, hold down the red 'end call' soft key until the device powers off.

To turn the Dialer back on, either:

1. Hold down the red 'end call' soft key until the Dialer powers on. OR
2. Simply return the Dialer to an active Charger Base and it will power on automatically.

Speaker On/Off

To power off the FLX Speaker, hold down the button located on the bottom of the Speaker until the LED indicators on the top of the Speaker turn solid red. Once the LED indicators are solid red, release the button and the Speaker will power off.

To power the Speaker back on, either:

1. Hold down the button on the bottom of the Speaker until the LED indicators on the top of the Speaker turn green. Once the LED indicators turn green, release the button and the Speaker will power on and connect to the system.

OR

2. Simply return the Speaker to an active Charger Base and it will power on automatically.

Microphones On/Off

To power off a FLX Microphone, hold down the button located on the Microphone until the LED indicator turns solid red. Once the LED indicator is solid red, release the button and the Microphone will power off.

To power a Microphone back on, either:

1. Hold down the button on the Microphone until the LED indicator on the Microphone turns green. Once the LED indicator turns green, release the button and the Microphone will power on and connect to the system.

OR

2. Simply return the Microphone to an active Charger Base and it will power on automatically.

Troubleshooting

Warning Messages

Speaker/Microphone Link Lost

If a FLX Microphone or FLX Speaker loses connection to the FLX2 Base Station, the LED indicator will begin flashing a sequence of red – yellow - green - yellow and start emitting a beeping notification. To reconnect the Microphone or Speaker move it back into range of the Base Station.

Speaker/Microphone Low Battery

If a FLX Microphone or FLX Speaker begins to experience a low battery, the LED indicator will begin to flash a green - yellow (unmuted) or red - yellow (muted) sequence. It will also start to emit an audio signal. When this LED and sound sequence begins, the battery has roughly 5% battery power remaining and should be returned to the Charger Base.

Speaker/Microphone Off

If the FLX Microphone or FLX Speaker suddenly turn off, it is the result of two possible causes.

1. The battery has completely depleted and should be returned to the charger until it is fully charged again.
2. The Microphone or Speaker lost connection with the Base Station for more than 5 minutes and therefore shut down. It should be returned into reach of the Base Station and switched on again to be reactivated.

Dialer Low Battery

When the Dialer experiences a low battery it will display a 'low battery' notification on the screen. The Dialer should be returned to the charger until the battery status on the home screen shows a full charge.

Dialer Link Lost

If the FLX Dialer loses connection to the FLX2 Base Station it will display a 'connection lost' notification on the screen. The Dialer should be moved back into range of the Base Station at which point it will reconnect automatically.

Base Power Lost

If the FLX2 Base Station loses power, it will disconnect all telephone calls, analog audio inputs/outputs and will disconnect from the FLX Dialer, Speaker, and Microphones. Check to make sure that the power adapter is still connected to the FLX2 Base Station. Once the FLX2 Base Station is powered back on, the Dialer, Speaker and Microphones will reconnect automatically.

Microphone, Speaker, or Dialer not connecting to Base Station

If any of the components of the FLX2 Conference Phone indicate that they are searching for the Base Station, or lost the connection to the Base Station, please follow these steps:

1. Is the Base Station powered up – the Status LED on the back of the Base Station should have green double flashes about every second. If not, please power up the Base Station. All components should automatically connect to the Base Station after a few seconds.

2. The Base Station is powered up, but the Status LED indicates a fault by missing every fifth green double flash. Power down and power up the Base Station. All components should reconnect to the Base Station after a few seconds. If the fault in the Base Station continues (every fifth double flash is skipped) please contact Revolabs support.
3. Are the Dialer, Microphone, and Speaker out of reach of the Base Station? Please bring the components closer to the Base Station to see whether this resolves the issue.
4. Power down the Base Station, the Microphones, the Dialer, and the Speaker. Now power up the Base Station. Once the Base Station is powered up (double green flashes of the Status LED), power up the Dialer, and then the Microphones and the Speaker. The components should now connect to the Base Station.
5. If the components still do not connect to the Base Station, please re-pair the components that have not connected to the Base Station, beginning with the Dialer. How to pair the components is explained on page 37.
6. If the components still do not connect to the Base Station, please contact Revolabs support.

Microphone, Speaker, or Dialer not paired with Base Station

Please follow the descriptions on page 37 on how to pair the different components with the Base Station.

LED Indicators

Device LED Indicator	Status
Microphone in Charger Base	
Steady Red	Charging
Steady Green	Fully charged
Off	Microphone is powered off: <ul style="list-style-type: none"> ○ Microphone is not seated properly ○ Charger tray is powered off
Microphone not in Charger Base	
Off	Microphone is powered off
Single green flash every second	On, connected, battery charged, un-muted
Two Red flashes every second	On, connected, battery charged, individually muted
Red flash every second	On, connected, battery charged, Master Mute or "All Mic Mute" is ON, microphones muted
Alternating Yellow - Green flash	On, connected, battery low, un-muted
Alternating Yellow - Double-Red flash	On, connected, battery low, individually muted
Alternating long Red - Yellow flash	On, connected, battery low, Master Mute or "All Mic Mute" is ON, microphones muted
Flashing Yellow – Red – Yellow – Green	Searching for a connection to the base. <i>The microphone will try to re-establish the link for about 5 minutes, then power off.</i>
Alternating slow Red - Green flash	Microphone is not paired to a Base Station <i>The microphone will power off after two minutes.</i>
Steady Red	<ul style="list-style-type: none"> ○ Microphone is being powered down ○ Microphone is in pairing mode.
Rapid Red flashes continuing for more than a few seconds	Radio congestion due to too many users or heavy radio interference.
Groups of five rapid Red flashes	Microphone is in a fault condition.
Device LED Indicator	Status
Speaker in Charger Base	
Steady Green	<ul style="list-style-type: none"> ○ Connected, battery charging, microphones in charger ○ Connected, battery charging, Master Mute and "All Mic Mute" are OFF ○ Connected, battery charging, "All Mic Mute" is ON, microphones unmuted
Steady Red	Connected, battery charging, Master Mute or "All Mic Mute" is ON, all microphones muted
Green flash every second	<ul style="list-style-type: none"> ○ Connected, battery fully charged, microphones in charger ○ Connected, battery fully charged, Master Mute and "All Mic Mute" are OFF ○ Connected, battery fully charged, "All Mic Mute" is ON, microphones unmuted
Red flash every second	Connected, battery fully charged, Master Mute or

Device LED Indicator	Status
	"All Mic Mute" is ON, all microphones muted
Flashing Yellow* – Red – Yellow* – Green	Searching for a connection to the Base Station
Alternating slow Red - Green flash	Speaker is not paired to a Base Station
Off	Speaker is powered off: <ul style="list-style-type: none"> ○ Speaker is not seated properly ○ Charger tray is powered off
Speaker not in Charger Base	
Off	Speaker is powered off
Green flash every second	<ul style="list-style-type: none"> ○ Connected, battery charged, microphones in charger ○ Connected, battery charged, Master Mute and "All Mic Mute" are OFF ○ Connected, battery charged, "All Mic Mute" is ON, microphones unmuted
Red flash every second	Connected, battery charged, Master Mute or "All Mic Mute" is ON, all microphones muted
Alternating Green – Yellow* flash	<ul style="list-style-type: none"> ○ Connected, battery low, microphones in charger ○ Connected, battery low, Master Mute and "All Mic Mute" are OFF ○ Connected, battery low, "All Mic Mute" is ON, microphones unmuted
Alternating long Red – Yellow* flash	Connected, battery low, Master Mute or "All Mic Mute" is ON, all microphones muted
Flashing Yellow* – Red – Yellow* – Green	Searching for a connection to the base <i>The speaker will try to re-establish the link for about 5 minutes, then power off.</i>
Alternating slow Red - Green flash	Speaker is not paired to a Base Station <i>The speaker will power down after two minutes.</i>
Steady Red	<ul style="list-style-type: none"> ○ Speaker is being powered down ○ Speaker is in pairing mode.
Rapid Red flashes continuing for more than a few seconds	Radio congestion due to too many users or heavy radio interference.
Groups of five rapid Red flashes	Speaker is in a fault condition.
Device LED Indicator	Status
Base Station	
Long solid on, then a long solid off	Power On Boot Process
Double flashes every second	Operating Mode indicating that Base Station is functional.
Skip every fifth double flash	Fault indication
Continuous Fast Flashing	Updating non-volatile memory as part of software update
Off	No Power

* In some Speakers the LED Indicator color Yellow might look like Red.

Reset to Factory Defaults

See page 36 for a description on how to reset the FLX2 Conference Phone back to its factory defaults.

Technical Specifications

Models

The Revolabs FLX2 System is available with a variety of configurations to provide the best audio capture in the industry. The following is a list of the available models. All of these models work with analog telephone lines.

10-FLX2-200-POTS	FLX2 System w/ 2 Omni Microphones
10-FLX2-101-POTS	FLX2 System w/ 1 Omni & 1 Wearable Microphone
10-FLX2-002-POTS	FLX2 System w/ 2 Wearable Microphones
10-FLX2-020-POTS	FLX2 System w/ 2 Directional Microphones

FLX	
Wireless Technology	
DECT	DECT 6.0 for US, ETSI ETS 300 175 for other countries
Bluetooth	BT 2.1 + EDR
Wireless Range	
DECT	65 feet, 20 meters
Bluetooth	Class II, 33 feet, 10 meters
Security (DECT / Bluetooth)	DECT: 128 bit encryption
Noise Cancelation	Noise cancellation on the Microphone
Echo Cancelation	Acoustic echo canceller for Speaker/Microphone Line echo canceller for analog telephone line.
RF Shield	No cell phone interference due to RF Armor™ technology
Language versions	System messages and menus in English; Documentation in English
Certifications / Regulatory Compliance	
Electrical Safety	UL/CSA, EN 60950
Radio / Telephone	Part 68, IC-CS03, TBR 21, A-Tick
Environmental Requirements	0°C - 40°C; 20% - 80% non-condensing humidity
Warranty	1 year
Speaker	
Dimensions Speaker	157mm x 93mm diameter
Weight	600.3g
Bandwidth	120-11,000 Hz from Analog IN. This is reduced for telephone calls based on the bandwidth supported by the phone transport.
Battery life (talk time)	8 hours.
Charge time	3 hours

Microphones	
Dimensions Microphones	94.2 x 24.6mm x 18.5mm (omnidirectional Microphone)
Weight	28.6g (omnidirectional Microphone)
Bandwidth	80-11,000 Hz from Microphone to Analog OUT. This is reduced for telephone calls based on the bandwidth supported by the phone transport.
Battery life (talk time)	8 hours
Charge time	2 hours
Base Station	
Power	5V 1A
Dimensions Base Station	180 x 153 x 32mm
Weight	302g
Connections	
Telephone	RJ11
USB	2 Mini-USB connectors
Analog IN OUT AUX OUT	Line level input, 2 outputs, line level or mic level
Indicators (LED)	1 indicating system status
Charger Base	
Power	15V 1A
Dimensions Charger Base	170 diameter x 22mm
Weight	252g
Dialer	
Dimensions Dialer	125 x 48 x 11mm
Weight	67.5g
Microphone and Speaker bandwidth	300 – 3300Hz
Battery life	8 hours
Charge time	3 hours
Display	High resolution color LCD display
Caller ID	Support for multiple Caller ID standards
Phonebook	Up to 99 entries
Keypad	12 key telephone keypad 2 context sensitive soft keys answer / hang-up keys, 5 key cursor and control panel

Regulatory Information

FCC Notice to Users

Users are not permitted to make changes or modify the equipment in any way. Changes or modifications not expressly approved by Revolabs, Inc. could void the user's authority to operate the equipment.

This device complies with Part 15 of the FCC Rules. Operation is subject to the following two conditions: (1) this device may not cause harmful interference, and (2) this device must accept any interference received, including interference that may cause undesired operation.

This equipment complies with FCC radiation exposure limits for an uncontrolled environment.

Model Number	FCC Identification
10-FLXBASE-POTS	T5V10FLX
10-FLXSPEAKER-01	T5V10FLXSPKR
10-FLXMIC-OM	T5V10FLXMIC
10-FLXMIC-DR	T5V10FLXMIC
10-FLXMIC-WB	T5V10FLXMIC
10-FLXHDDIALER-01	T5V10FLXDIAL

Industry Canada Notice to Users

Operation is subject to the following two conditions:

- (1) This device may not cause interference and
- (2) This device must accept any interference, including interference that may cause undesired operation of the device

Model Number	Industry Canada Identification
10-FLXBASE-POTS	6455A-10FLX
10-FLXSPEAKER-01	6455A-10FLXSPKR
10-FLXMIC-OM	6455A-10FLXMIC
10-FLXMIC-DR	6455A-10FLXMIC
10-FLXMIC-WB	6455A-10FLXMIC
10-FLXHDDIALER-01	6455A-10FLXDIAL

Restricted use with certain medical devices

Hearing Aids

Some devices may interfere with some hearing aids. In the event of such interference, you may want to consult with your hearing aid manufacturer to discuss alternatives.

Other Medical Devices

If you use any other personal medical device, consult the manufacturer of your device to determine if it is adequately shielded from RF energy. Your physician may be able to assist you in obtaining this information.

Export Law Assurance

This product is controlled under the export regulations of the United States of America and Canada. The Governments of the United States of America and Canada may restrict the exportation or re-exportation of this product to certain destinations. For further information contact the U.S. Department of Commerce or the Canadian Department of Foreign Affairs and International Trade. The use of wireless devices and their accessories may be prohibited or restricted in certain areas. Always obey the laws and regulations on the use of these products.

North American UPCS Usage Restriction

This product is licensed for operation in the United States of America and Canada

The radio has been found to be compliant to the requirements set forth in CFR 47 Sections 2.1091, and 15.247 (b) (4) addressing RF Exposure from radio frequency devices as defined in Evaluating Compliance with FCC Guidelines for Human Exposure to Radio Frequency Electromagnetic Fields. The equipment should be installed more than 20 cm (7.9 in.) from your body or nearby persons.

European Union Usage Restriction

This product is licensed for operation in the European Union countries.

The products referenced herein are in compliance with the EU directive 2003/11/EC and EU directive 2002/95/EC.

WEEE Notification

The Waste Electrical and Electronic Equipment (WEEE) directive (2002/96/EC) is intended to promote recycling of electrical and electronic equipment and their components at end of life.





E C Declaration of Conformity

Manufacturer's Name: Revolabs
 Manufacturer's Address: 144 North Road, Suite 3250
 Sudbury, MA 01776
 U.S.A.

Model:	Model Numbers
Base	10-FLXBASEEU-POTS
Charger Base	10-FLXCHGEU-01
Speaker	10-FLXSPEAKEREU-01
Microphone Omni	10-FLXMICEU-OM
Microphone Directional	10-FLXMICEU-DR
Microphone lapel	10-FLXMICEU-WB
Dialer	10-FLXHDDIALEREU-01

Declares that the products listed above conform to the following Council Directives:

1999/5/EC	(Radio equipment and Telecommunications Terminal Equipment (R&TTE) Directive).
89/336/EEC	Electromagnetic Compatibility (EMC) Directive".
73/23/EEC	Low Voltage Directive (LVD)".

Product Standard(s) to which Conformity of the Council Directive(s) is declared:

- EN 301 489-17 ElectroMagnetic Compatibility and Radio Spectrum Matters (ERM); ElectroMagnetic Compatibility (EMC) Standard for Radio Equipment and Services; Part 17: Specific Conditions for 2,4 GHz Wideband Transmission Systems and 5 GHz High Performance RLAN Equipment
- EN 300 328 Electromagnetic compatibility and Radio spectrum Matters (ERM); Wideband transmission systems; Data transmission equipment operating in the 2,4 GHz ISM band and using wide band modulation techniques; Harmonized EN covering essential requirements under article 3.2 of the R&TTE Directive
- EN 301 489-6 ElectroMagnetic Compatibility and Radio Spectrum Matters (ERM); ElectroMagnetic Compatibility (EMC) Standard for Radio Equipment and Services; Part 6: Specific Conditions for Digital Enhanced Cordless Telecommunications (DECT) Equipment
- EN 301 406 Digital Enhanced Cordless Telecommunications (DECT); Harmonized EN for Digital Enhanced Cordless Telecommunications (DECT) covering essential requirements under article 3.2 of the R&TTE Directive; Generic radio
- EN 55022: 2006 (Emissions) Information technology equipment - Radio disturbance characteristics
- EN 55024: 1998 (Immunity) +A1+A2 Information technology equipment - Immunity characteristics
- IEC 60950-1: 2001 Safety of Information Technology Equipment, Including Electrical Business Equipment.

We, the undersigned, hereby declare that the equipment specified above conforms to the above directives and standards.

 <name and title of signatory>

ACTA Part 68 information

- This equipment complies with Part 68 of the FCC rules and the requirements adopted by the ACTA. On the base of this equipment is a label that contains, among other information, a product identifier in the format US:AAAEQ##TXXXX. If requested, this number must be provided to the telephone company.
- This equipment uses RJ11C USOC jack, FIC is 02LS2, SOC is 09Y
- A plug and jack used to connect this equipment to the premises wiring and telephone network must comply with the applicable FCC Part 68 rules and requirements adopted by the ACTA. A compliant telephone cord and modular plug should be used with this product. It is designed to be connected to a compatible modular jack that is also compliant. See installation instructions for details.
- The REN is used to determine the number of devices that may be connected to a telephone line. Excessive RENs on a telephone line may result in the devices not ringing in response to an incoming call. In most but not all areas, the sum of RENs should not exceed five (5.0). To be certain of the number of devices that may be connected to a line, as determined by the total RENs, contact the local telephone company. The REN for this product is part of the product identifier that has the format US:AAAEQ##TXXXX. The digits represented by ## are the REN without a decimal point (e.g., 03 is a REN of 0.3).
- If this equipment, Model 10-FLXBASE-POTS, causes harm to the telephone network, the telephone company will notify you in advance that temporary discontinuance of service may be required. But if advance notice isn't practical, the telephone company will notify the customer as soon as possible. Also, you will be advised of your right to file a complaint with the FCC if you believe it is necessary.
- The telephone company may make changes in its facilities, equipment, operations or procedures that could affect the operation of the equipment. If this happens the telephone company will provide advance notice in order for you to make necessary modifications to maintain uninterrupted service.
- If trouble is experienced with this equipment, Model 10-FLXBASE-POTS, for repair or warranty information, please contact Revolabs Customer Service at 1-800-326-1088 or on the web at www.revolabs.com. If the equipment is causing harm to the telephone network, the telephone company may request that you disconnect the equipment until the problem is resolved.
- If you experience trouble with this equipment, Model 10-FLXBASE-POTS, do not try to repair the equipment yourself. The equipment cannot be repaired in the field and must be returned to the manufacturer. Repairs to certified equipment should be coordinated by a representative, and designated by the supplier.
- Connection to party line service is subject to state tariffs. Contact the state public utility commission, public service commission or corporation commission for information.
- If your home has specially wired alarm equipment connected to the telephone line, ensure the installation of the Model 10-FLXBASE-POTS does not disable your alarm equipment. If you have questions about what will disable alarm equipment, consult your telephone company or a qualified installer.
- This equipment is hearing aid compatible.

Warranty

Limited Warranty

Revolabs warrants to the end user ("Customer") that this product will be free from significant defects in workmanship and materials, under normal use and service, for one year from the date of purchase from Revolabs or its authorized reseller. Revolabs's sole obligation under this express warranty shall be, at Revolabs's option and expense, to repair the defective product or part, deliver to Customer an equivalent product or part to replace the defective item, or if neither of the two foregoing options is reasonably available, Revolabs may, in its sole discretion, refund to Customer the purchase price paid for the defective product upon Customer's return of the defective product. All products that are replaced will become the property of Revolabs. Replacement products or parts may be new or reconditioned. Revolabs warrants any replaced or

repaired product or part for ninety (90) days from shipment, or the remainder of the initial warranty period, whichever is longer. Products returned to Revolabs must be sent prepaid and packaged appropriately for safe shipment, and it is recommended that they be insured or sent by a method that provides for tracking of the package. Responsibility for loss or damage does not transfer to Revolabs until the returned item is received by Revolabs. The repaired or replaced item will be shipped to Customer, at Revolabs's expense, not later than thirty (30) days after Revolabs receives the defective product, and Revolabs will retain risk of loss or damage until the item is delivered to Customer.

Exclusions and Remedies

Revolabs will not be liable under this limited warranty if its testing and examination disclose that the alleged defect or malfunction in the product does not exist or results from:

- ▶ Failure to follow Revolabs's installation, operation, or maintenance instructions;
- ▶ Product modification or alteration;
- ▶ Use of common carrier communication services accessed through the product;
- ▶ Abuse, misuse, negligent acts or omissions of Customer and persons under Customer's control; or
- ▶ Acts of third parties, acts of God, accident, fire, lightning, power surges, outages, or other hazards, or any other cause outside of Revolabs's reasonable control.

WARRANTY EXCLUSIVE. IF A REVOLABS PRODUCT DOES NOT OPERATE AS WARRANTED ABOVE, CUSTOMER'S SOLE

REMEDY FOR BREACH OF THAT WARRANTY SHALL BE REPAIR, REPLACEMENT, OR REFUND OF THE PURCHASE PRICES PAID, AT REVOLABS'S OPTION. TO THE FULL EXTENT ALLOWED BY LAW, THE FOREGOING WARRANTIES AND REMEDIES ARE EXCLUSIVE AND ARE IN LIEU OF ALL OTHER WARRANTIES, TERMS OR CONDITIONS, EXPRESS OR IMPLIED, EITHER IN FACT OR BY OPERATION OF LAW, STATUTORY OR OTHERWISE, INCLUDING WARRANTIES, TERMS OR CONDITIONS OF MERCHANTABILITY, FITNESS FOR A PARTICULAR PURPOSE, SATISFACTORY QUALITY, CORRESPONDENCE WITH DESCRIPTION, AND NON-INFRINGEMENT, ALL OF WHICH ARE EXPRESSLY DISCLAIMED. REVOLABS NEITHER ASSUMES NOR AUTHORIZES ANY OTHER PERSON TO ASSUME FOR IT ANY OTHER LIABILITY IN CONNECTION WITH THE SALE, INSTALLATION, MAINTENANCE OR USE OF ITS PRODUCTS.

Limitation of Liability

TO THE FULL EXTENT ALLOWED BY LAW, REVOLABS EXCLUDES FOR ITSELF AND ITS SUPPLIERS ANY LIABILITY, WHETHER BASED IN CONTRACT OR TORT (INCLUDING NEGLIGENCE), FOR INCIDENTAL, CONSEQUENTIAL, INDIRECT, SPECIAL, OR PUNITIVE DAMAGES OF ANY KIND, OR FOR LOSS OF REVENUE OR PROFITS, LOSS OF BUSINESS, LOSS OF INFORMATION OR DATA, OR OTHER FINANCIAL LOSS ARISING OUT OF OR IN CONNECTION WITH THE SALE, INSTALLATION, MAINTENANCE, USE, PERFORMANCE, FAILURE, OR INTERRUPTION OF ITS PRODUCTS, EVEN IF REVOLABS OR ITS AUTHORIZED RESELLER HAS BEEN ADVISED OF THE POSSIBILITY OF SUCH DAMAGES, AND LIMITS ITS LIABILITY TO REPAIR, REPLACEMENT, OR REFUND OF THE PURCHASE PRICE PAID, AT REVOLABS'S OPTION. THIS DISCLAIMER OF LIABILITY FOR DAMAGES WILL NOT BE AFFECTED IF ANY REMEDY PROVIDED HEREIN SHALL FAIL OF ITS ESSENTIAL PURPOSE.

Disclaimer

Some countries, states, or provinces do not allow the exclusion or limitation of implied warranties or the limitation of incidental or consequential damages for certain products supplied to consumers, or the limitation of liability for personal injury, so the above limitations and exclusions may be limited in their application to you. When the

implied warranties are not allowed to be excluded in their entirety, they will be limited to the duration of the applicable written warranty. This warranty gives you specific legal rights which may vary depending on local law.

Governing Laws

This Limited Warranty and Limitation of Liability shall be governed by the laws of the State of Massachusetts, USA, and by the laws of the United States, excluding their conflicts of laws principles.

The United Nations Convention on Contracts for the International Sale of Goods is hereby excluded in its entirety from application to this Limited Warranty and Limitation of Liability.

Technical Support

If you are experiencing technical problems or if you have questions about the operation, configuration or troubleshooting of any Revolabs product, please email support@revolabs.com or call 1-800-326-1088

Free Manuals Download Website

<http://myh66.com>

<http://usermanuals.us>

<http://www.somanuals.com>

<http://www.4manuals.cc>

<http://www.manual-lib.com>

<http://www.404manual.com>

<http://www.luxmanual.com>

<http://aubethermostatmanual.com>

Golf course search by state

<http://golfingnear.com>

Email search by domain

<http://emailbydomain.com>

Auto manuals search

<http://auto.somanuals.com>

TV manuals search

<http://tv.somanuals.com>