



# GK6072

60" & 72" Rear Discharge  
Finishing Mowers

Published 08/01

P/N 00767471C

## OPERATOR'S MANUAL



This Operator's Manual is an integral part of the safe operation of this machine and must be maintained with the unit at all times. **READ, UNDERSTAND, and FOLLOW** the Safety and Operation Instructions contained in this manual before operating the equipment.

### ATENCIÓN!

LEA EL INSTRUCTIVO

Si No Lee Ingles, Pida Ayuda a Alguien  
Que Si Lo Lea Para Que le Traduzca las  
Medidas de Seguridad.

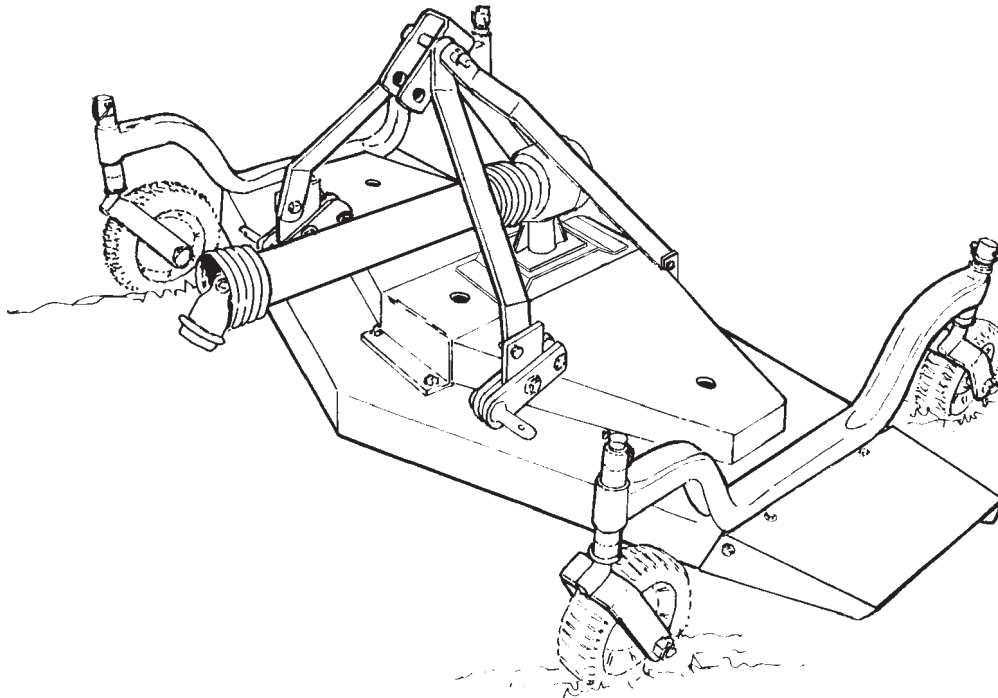

RHINO®

1020 S. Sangamon Ave.  
Gibson City, IL 60936  
800-446-5158

Email: [parts@servis-rhino.com](mailto:parts@servis-rhino.com)

© 2004 Alamo Group Inc.



\$0.00

# TO THE OWNER/OPERATOR/DEALER

All implements with moving parts are potentially hazardous. There is no substitute for a cautious, safe-minded operator who recognizes the potential hazards and follows reasonable safety practices. The manufacturer has designed this implement to be used with all its safety equipment properly attached to minimize the chance of accidents.

**BEFORE YOU START!!** Read the safety messages on the implement and shown in your manual.  
Observe the rules of safety and common sense!

# DANGER

**FAILING TO FOLLOW SAFETY MESSAGES AND OPERATING INSTRUCTIONS CAN CAUSE SERIOUS BODILY INJURY OR EVEN DEATH TO OPERATOR AND OTHERS IN THE AREA.**

1.

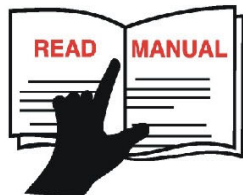

2. **NO RIDERS.  
NO CHILDREN OPERATORS.**



3. **USE SAFETY SHOES,  
HARD HAT, SAFETY  
GLASSES, SEAT  
BELTS, & ROPS**



4. **BLOCK UP SECURELY  
BEFORE WORKING  
UNDER.**



1. Study and understand operator's manual, safety signs, and Instructional decals for tractor and Implement to prevent misuse, abuse, and accidents.
  - Learn how to stop engine suddenly in an emergency. Be alert for passerby and especially children.
2. Allow no children on or near Implement or tractor. Allow no riders on tractor and implement. Falling off may cause serious injury or death from being run over by tractor or cutter or contact with rotating blades.
3. Operate only with tractor having Roll-Over Protective Structure (ROPS) and with seatbelt fastened securely and snugly to prevent injury and possible death from falling off or tractor overturn. Personal Protective Equipment such as Hard Hat, Safety Glasses, Safety Shoes, and Ear Plugs are Recommended.
4. Block up or support raised machine and all lifted components securely before putting hands or feet under or working underneath any lifted components to prevent crushing injury or death from sudden dropping or inadvertent operation of controls. Make certain area is clear before lowering or folding.
5. Before transporting, put Lift Lever in detent or full-lift position. Secure the implement for transport by installing Cylinder Stops or Transport Pin on Pull-type implement center axle and Wing Transport Locks on folding implements.
  - Attach Safety Chain to cutter and towing unit securely. See Operator's Manual.
6. Make certain that the SMV sign, Warning Lights, and Reflectors are clearly visible. Follow local traffic codes.
7. Never operate with Cutting Head raised if passerby, bystanders, or traffic are in the area to reduce possibility of injury or death from Objects thrown by Blades under Guard or cutter structure.
8. Before dismounting, secure implement in transport position or lower to ground.
  - Put tractor in park or set the brake, disengage PTO, stop engine, and remove key, and wait until noise of rotation has ceased to prevent entanglement in rotating parts which can cause injury or death.
  - Never mount or dismount a moving vehicle. Crushing from runover may cause injury or death.

5. **TRANSPORT SAFELY,  
LOCK UP.**



6. **USE SMV, LIGHTS, &  
REFLECTORS.**

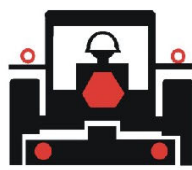

7. **DO NOT OPERATE  
WITH CUTTER OR  
WING RAISED.**

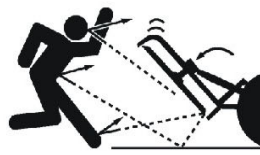

8. **DO NOT MOUNT OR  
DISMOUNT WHILE  
MOVING.**



00749117

## WARRANTY INFORMATION:

Read and understand the complete Warranty Statement found in this Manual. Fill out the Warranty Registration Form in full and return it within 30 Days. Make certain the Serial Number of the Machine is recorded on the Warranty Card and on the Warranty Form that you retain. The use of "will-fit" parts will void your warranty and can cause catastrophic failure with possible injury or death.

➤ **BE SAFE!**

➤ **BE ALERT!**

➤ **BE ALIVE!**

➤ **BE TRAINED  
before operating  
the Mower!**

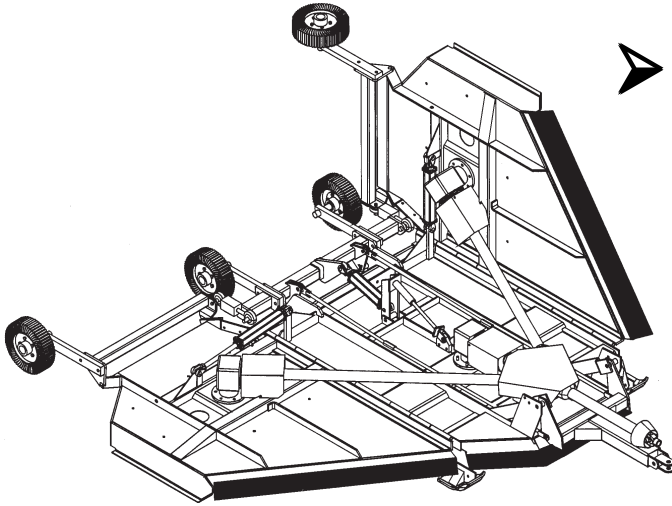

**M&W**



*Safety Training  
Makes the Difference*

In order to reduce accidents and enhance the safe operation of mowers, *Alamo Group Ag Division*, in cooperation with other industry manufacturers has developed the AEM/FEMA Industrial and Agricultural Mower Safety Practices video and guide book.

The video will familiarize and instruct mower-tractor operators in safe practices when using industrial and agricultural mowing equipment. It is important that Every Mower Operator be educated in the operation of their mowing equipment and be able to recognize the potential hazards that can occur while operating a mower. This video, along with the mower operator's manual and the warning messages on the mower, will significantly assist in this important education.

Your Authorized *Alamo Ag Dealer* may have shown this video and presented you a DVD Video when you purchased your mower. If you or any mower operator have not seen this video, **Watch the Video, Read this Operator's Manual, and Complete the Video Guidebook** before operating your new mower. If you do not understand any of the instructions included in the video or operator's manual or if you have any questions concerning safety of operation, contact your supervisor, dealer or *Alamo Group Ag*.

If you would like a VHS video tape of the video, please email [AEMVideo@alamo-group.com](mailto:AEMVideo@alamo-group.com) or Fax AEM VHS Video at (830) 372-9529 or mail in a completed copy of the form on the back of this page to AEM VHS Video 1502 E Walnut Street, Seguin, TX 78155. and request the VHS video version. Please include your name, mailing address, mower model and serial number.

Every operator should be trained for each piece of equipment (Tractor and Mower), understand the intended use, and the potential hazards before operating the equipment.

# Alamo Group Ag. Division is willing to provide one (1) AEM Mower Safety Practices Video

- Please Send Me:  VHS Format – AEM/FEMA Mower Operator Safety Video
- DVD Format – AEM/FEMA Mower Operator Safety Video
- Mower Operator’s Manual
- AEM Mower Operator’s Safety Manual

Requester Name: \_\_\_\_\_ Phone: \_\_\_\_\_

Requester Address: \_\_\_\_\_

\_\_\_\_\_

City \_\_\_\_\_

State \_\_\_\_\_

Zip Code \_\_\_\_\_

Mower Model: \_\_\_\_\_ Serial Number: \_\_\_\_\_

Date Purchased: \_\_\_\_\_ Dealer Salesperson: \_\_\_\_\_

Dealership Name: \_\_\_\_\_ Dealership Location: \_\_\_\_\_

Mail to:

AEM Video Services  
1502 E Walnut street  
Seguin, TX 78155

Or Fax to:

(830) 372-9529

Or Email to:

AEMVideo@alamo-group.com

# TABLE OF CONTENTS

<b>SAFETY SECTION .....</b>	<b>1-1</b>
Safety Information .....	1-2
Decal Location .....	1-11
Safety Decals .....	1-12
Federal Laws & Regulations .....	1-14
<b>INTRODUCTION SECTION .....</b>	<b>2-1</b>
<b>ASSEMBLY SECTION .....</b>	<b>3-1</b>
A-Frame Attachment .....	3-2
Caster Wheel Attachments .....	3-3
<b>OPERATION SECTION .....</b>	<b>4-1</b>
<b>MAINTENANCE SECTION .....</b>	<b>5-1</b>
Lubrication Information .....	5-2
Gearbox .....	5-3
Gauge Wheel Assemblies .....	5-3
Driveline Lubrication .....	5-4
Blade Spindle Lubrication .....	5-4
Blade Servicing .....	5-5
Blade Sharpening .....	5-5
Blade Removal and Installation .....	5-5
Belt Adjustment Procedure .....	5-6
Belt Removal/Installation .....	5-6
Storage .....	5-7
Torque Settings .....	5-7
Blade Spindle Service Instructions .....	5-8
Driveline Shield Service Instructions .....	5-9



# **SAFETY SECTION**

# SAFETY

## SAFETY

A safe and careful operator is the best operator. Safety is of primary importance to the manufacturer and should be to the owner/operator. Most accidents can be avoided by being aware of your equipment, your surroundings, and observing certain precautions. The first section of this manual includes a list of Safety Messages that, if followed, will help protect the operator and bystanders from injury or death. Read and understand these Safety Messages before assembling, operating or servicing this implement. This equipment should only be operated by those persons who have read the Manual, who are responsible and trained, and who know how to do so safely and responsibly.

The Safety Alert Symbol combined with a Signal Word, as seen below, is used throughout this manual and on decals which are attached to the equipment. The Safety Alert Symbol means: **“ATTENTION! BECOME ALERT! YOUR SAFETY IS INVOLVED!”** The Symbol and Signal Word are intended to warn the owner/operator of impending hazards and the degree of possible injury faced when operating this equipment..

**Practice all usual and customary safe working precautions and above all---remember safety is up to YOU. Only YOU can prevent serious injury or death from unsafe practices.**

### CAUTION!

The lowest level of Safety Message; warns of possible injury. Decals located on the Equipment with this Signal Word are Black and Yellow.



### WARNING!

Serious injury or possible death! Decals are Black and Orange.



### DANGER!

Imminent death/critical injury. Decals are Red and White. (SG-1)



**READ, UNDERSTAND, and FOLLOW the following Safety Messages. Serious injury or death may occur unless care is taken to follow the warnings and instructions stated in the Safety Messages. Always use good common sense to avoid hazards.**

(SG-2)

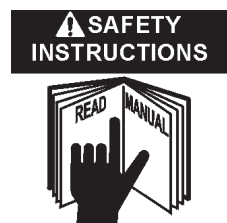



# SAFETY

SAFETY

**PELIGRO!**



Si no lee Ingles, pida ayuda a alguien que si lo lea para que le traduzca las medidas de seguridad. (SG-3)

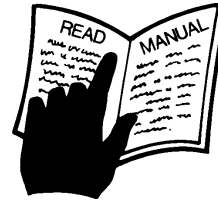

**¡LEA EL INSTRUCTIVO!**

**DANGER!**



Never operate the Tractor or Implement until you have read and completely understand this Manual, the Tractor Operator's Manual, and each of the Safety Messages found in the Manual or on the Tractor and Implement. Learn how to stop the tractor engine suddenly in an emergency. Never allow inexperienced or untrained personnel to operate the Tractor and Implement without supervision. Make sure the operator has fully read and understood the manuals prior to operation. (SG-4)

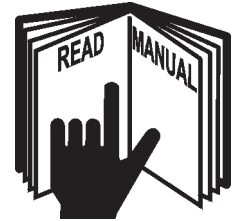

**WARNING!**



Always maintain the safety decals in good readable condition. If the decals are missing, damaged, or unreadable, obtain and install replacement decals immediately. (SG-5)

**WARNING!**



Make certain that the "Slow Moving Vehicle" (SMV) sign is installed in such a way as to be clearly visible and legible. When transporting the Equipment use the Tractor flashing warning lights and follow all local traffic regulations. (SG-6)



**WARNING!**



Operate this Equipment only with a Tractor equipped with an approved roll-over-protective system (ROPS). Always wear seat belts. Serious injury or even death could result from falling off the tractor--particularly during a turnover when the operator could be pinned under the ROPS. (SG-7)



**WARNING!**



Do not modify or alter this Implement. Do not permit anyone to modify or alter this Implement, any of its components or any Implement function. (SG-8)

**DANGER!**



BEFORE leaving the tractor seat, always engage the brake and/or set the tractor transmission in parking gear, disengage the PTO, stop the engine, remove the key, and wait for all moving parts to stop. Place the tractor shift lever into a low range or parking gear to prevent the tractor from rolling. Never dismount a Tractor that is moving or while the engine is running. Operate the Tractor controls from the tractor seat only. (SG-9)

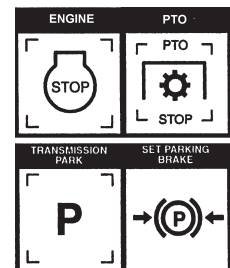

# SAFETY

SAFETY

**DANGER!**



Never allow children or other persons to ride on the Tractor or Implement. Falling off can result in serious injury or death.

(SG-10)



**DANGER!**



Never allow children to operate or ride on the Tractor or Implement.

(SGM-11)



**WARNING!**



Do not mount the Tractor while the tractor is moving. Mount the Tractor only when the Tractor and all moving parts are completely stopped.

(SG-12)



**DANGER!**



Start tractor only when properly seated in the Tractor seat. Starting a tractor in gear can result in injury or death. Read the Tractor operators manual for proper starting instructions.

(SG-13)



**DANGER!**



Never work under the Implement, the framework, or any lifted component unless the Implement is securely supported or blocked up to prevent sudden or inadvertent falling which could cause serious injury or even death.

(SG-14)



**DANGER!**



Do not operate this Equipment with hydraulic oil leaking. Oil is expensive and its presence could present a hazard. Do not check for leaks with your hand! Use a piece of heavy paper or cardboard. High-pressure oil streams from breaks in the line could penetrate the skin and cause tissue damage including gangrene. If oil does penetrate the skin, have the injury treated immediately by a physician knowledgeable and skilled in this procedure.

(SG-15)



**WARNING!**



The operator and all support personnel should wear hard hats, safety shoes, safety glasses, and proper hearing protection at all times for protection from injury including injury from items thrown by the equipment.

(SG-16)

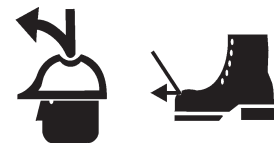

**CAUTION!**



**PROLONGED EXPOSURE TO LOUD NOISE MAY CAUSE PERMANENT HEARING LOSS!** Tractors with or without an Implement attached can often be noisy enough to cause permanent hearing loss. We recommend that you always wear hearing protection if the noise in the Operator's position exceeds 80db. Noise over 85db over an extended period of time will cause severe hearing loss. Noise over 90db adjacent to the Operator over an extended period of time will cause permanent or total hearing loss. *Note:* Hearing loss from loud noise [from tractors, chain saws, radios, and other such sources close to the ear] is cumulative over a lifetime without hope of natural recovery.

(SG-17)



# SAFETY

## WARNING!



Transport only at safe speeds. Serious accidents and injuries can result from operating this equipment at unsafe speeds. Understand the Tractor and Implement and how it handles before transporting on streets and highways. Make sure the Tractor steering and brakes are in good condition and operate properly.



Before transporting the Tractor and Implement, determine the safe transport speeds for you and the equipment. Make sure you abide by the following rules:

1. Test the tractor at a slow speed and increase the speed slowly. Apply the Brakes smoothly to determine the stopping characteristics of the Tractor and Implement. As you increase the speed of the Tractor the stopping distance increases. Determine the maximum safe transport speed for you and this Equipment.
2. Test the equipment at a slow speed in turns. Increase the speed through the turn only after you determine that it is safe to operate at a higher speed. Use extreme care and reduce your speed when turning sharply to prevent the tractor and implement from turning over. Determine the maximum safe turning speed for you and this equipment before operating on roads or uneven ground.
3. Only transport the Tractor and Implement at the speeds that you have determined are safe and which allow you to properly control the equipment.

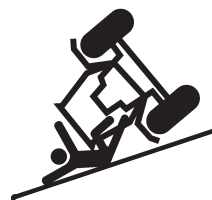

Be aware of the operating conditions. Do not operate the Tractor with weak or faulty brakes. When operating down a hill or on wet or rain slick roads, the braking distance increases: use extreme care and reduce your speed. When operating in traffic always use the Tractor's flashing warning lights and reduce your speed. Be aware of traffic around you and watch out for the other guy. (SG-19)

## WARNING!



Never attempt to lubricate, adjust, or remove material from the Implement while it is in motion or while tractor engine is running. Make sure the tractor engine is off before working on the Implement.

(SG-20)



## WARNING!



Periodically inspect all moving parts for wear and replace when necessary with authorized service parts. Look for loose fasteners, worn or broken parts, and leaky or loose fittings. Make sure all pins have cotter pins and washers. Serious injury may occur from not maintaining this machine in good working order. (SG-21)



## WARNING!



Always read carefully and comply fully with the manufacturers instructions when handling oil, solvents, cleansers, and any other chemical agent. (SG-22)



## DANGER!



Never run the tractor engine in a closed building or without adequate ventilation. The exhaust fumes can be hazardous to your health.

(SG-23)

# SAFETY

SAFETY

## DANGER!



KEEP AWAY FROM ROTATING ELEMENTS to prevent entanglement and possible serious injury or death. (SG-24)



## DANGER!



Never allow children to play on or around Tractor or Implement. Children can slip or fall off the Equipment and be injured or killed. Children can cause the Implement to shift or fall crushing themselves or others. (SG-25)

## WARNING!



Do not exceed the rated PTO speed for the Implement. Excessive PTO speeds can cause Implement driveline or blade failures resulting in serious injury or death. (SG-26)

## DANGER!



**NEVER use drugs or alcohol** immediately before or while operating the Tractor and Implement. Drugs and alcohol will affect an operator's alertness and coordination and therefore affect the operator's ability to operate the equipment safely. Before operating the Tractor or Implement, an operator on prescription or over-the-counter medication must consult a medical professional regarding any side effects of the medication that would hinder their ability to operate the Equipment safely. **NEVER** knowingly allow anyone to operate this equipment when their alertness or coordination is impaired. Serious injury or death to the operator or others could result if the operator is under the influence of drugs or alcohol. (SG-27)

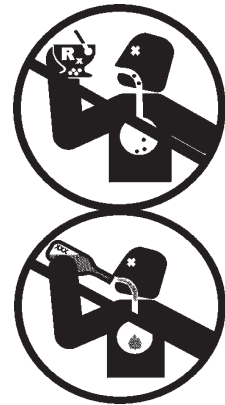

## DANGER!



Operate the Tractor and/or Implement controls only while properly seated in the Tractor seat with the seat belt securely fastened around you. Inadvertent movement of the Tractor or Implement may cause serious injury or death. (SG-29)

## WARNING!



Mow only in conditions where you have clear visibility in daylight or with adequate artificial lighting. Never mow in darkness or foggy conditions where you cannot clearly see at least 100 yards in front and to the sides of the tractor and mower. Make sure that you can clearly see and identify passersby, steep slopes, ditches, drop-offs, overhead obstructions, power lines, debris and foreign objects. If you are unable to clearly see this type of items discontinue mowing. (SGM-1)

## DANGER!



There are obvious and hidden potential hazards in the operation of this Mower. **REMEMBER!** This machine is often operated in heavy brush and in heavy weeds. The Blades of this Mower can throw objects if shields are not properly installed and maintained. Serious injury or even death may occur unless care is taken to insure the safety of the operator, bystanders, or passersby in the area. Do not operate this machine with anyone in the immediate area. Stop mowing if anyone is within 100 yards of mower. (SGM-2)



# SAFETY

**DANGER!**



All Safety Shields, Guards and Safety devices including (but not limited to) - the Deflectors, Chain Guards, Steel Guards, Gearbox Shields, Hydraulic Tank Shields, and Retractable Door Shields should be used and maintained in good working condition. All safety devices should be inspected carefully at least daily for missing or broken components. Missing, broken, or worn items must be replaced at once to reduce the possibility of injury or death from thrown objects, entanglement, or blade contact. (SGM-3)

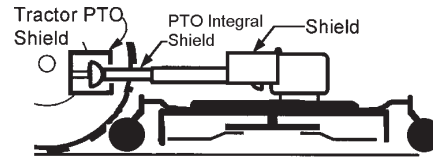

**DANGER!**



The rotating parts of this machine have been designed and tested for rugged use. However, they could fail upon impact with heavy, solid objects such as steel guard rails and concrete abutments. Such impact could cause the broken objects to be thrown outward at very high velocities. To reduce the possibility of property damage, serious injury, or even death, never allow the cutting blades to contact such obstacles. (SGM-4)

**WARNING!**



Extreme care should be taken when operating near loose objects such as gravel, rocks, wire, and other debris. Inspect the area before mowing. Foreign objects should be removed from the site to prevent machine damage and/or bodily injury or even death. Any objects that cannot be removed must be clearly marked and carefully avoided by the operator. Stop mowing immediately if blades strike a foreign object. Repair all damage and make certain rotor or blade carrier is balanced before resuming mowing. (SGM-5)



**WARNING!**



Many varied objects, such as wire, cable, rope, or chains, can become entangled in the operating parts of the mower head. These items could then swing outside the housing at greater velocities than the blades. Such a situation is extremely hazardous and could result in serious injury or even death. Inspect the cutting area for such objects before mowing. Remove any like object from the site. Never allow the cutting blades to contact such items. (SGM-6)

**WARNING!**



Mow at the speed that you can safely operate and control the tractor and mower. Safe mowing speed depends on terrain condition and grass type, density, and height of cut. Normal ground speed range is from 0 to 5 mph. Use slow mowing speeds when operating on or near steep slopes, ditches, drop-offs, overhead obstructions, power lines, or when debris and foreign objects are to be avoided. (SGM-7)

**WARNING!**



Avoid mowing in reverse direction when possible. Check to make sure there are no persons are behind the mower and use extreme care when mowing in reverse. Mow only at a slow ground speed where you can safely operate and control the tractor and mower. Never mow an area in the reverse direction that you have not inspected and removed debris or foreign material. (SGM-8)

**WARNING!**



Do not put hands or feet under mower decks. Blade Contact can result serious injury or even death. (SGM-9)



# SAFETY

SAFETY

## DANGER!



Replace bent or broken blade with new blades. NEVER ATTEMPT TO STRAIGHTEN BLADES SINCE THIS WILL LIKELY CRACK OR OTHERWISE DAMAGE THE BLADE WITH SUBSEQUENT FAILURE AND POSSIBLE SERIOUS INJURY FROM THROWN BLADES. (SGM-10)

## WARNING!



Do not mow with two machines in the same area except with Cab tractors with the windows closed. (SGM-11)

## DANGER!



Always disconnect the main PTO Driveline from the Tractor before performing service on the Mower. Never work on the Mower with the tractor PTO driveline connected and running. Blades or Drivelines could turn without warning and cause immediate entanglement, injury or death. (SRM-3)

## WARNING!



Do not let the Blades turn when the Mower Deck is raised for any reason, including clearance or for turning. Raising the Mower deck exposes the Cutting Blades which creates a potentially serious hazard and could cause serious injury or even death from objects thrown from the Blades. (SRM-7)



## WARNING!



Never leave Tractor and Implemented unattended while the implement is in the lifted position. Accidental operation of lifting lever or a hydraulic failure may cause sudden drop of unit with injury or death by crushing. To properly park the implement when disconnecting it from the tractor, lower the stand and put the retaining pin securely in place, or put a secure support under the A-Frame. Lower the implement carefully to the ground. Do not put hands or feet under lifted components. (S3PT-1)

## WARNING!



Be particularly careful when transporting the Implement with the Tractor. Turn curves or go up hills only at a low speed and using a gradual steering angle. Rear mounted implements move the center of gravity to the rear and remove weight from the front wheels. Make certain, by adding front ballast, that at least 20% of the tractor's weight is on the front wheels to prevent rearing up, loss of steering control or Tractor tip-over. Slow down on rough or uneven surfaces to prevent loss of steering control which could result in property damage or possible injury. Do not transport unless 3-Point lift lever is fully raised and in the latched transport position. Dropping implement in transport can cause serious damage to the tractor and/or Implement and possibly cause the operator or others to be injured or killed. (S3PT-2)

## DANGER!



Make sure the PTO shield is installed when using PTO-driven equipment. Always replace the PTO shield if it is damaged or missing. (S3PT-8)



## WARNING!



Relieve hydraulic pressure prior to doing any maintenance or repair work on the Implement. Place the Implement on the ground or securely blocked up, disengage the PTO, and turn off the tractor engine. Push and pull the Remote Cylinder lever in and out several times prior to starting any maintenance or repair work. (S3PT-9)



## WARNING!



The rotating parts of this machine continue to rotate even after the PTO has been turned off. The operator should remain in his seat for 60 seconds after the brake has been set, the PTO disengaged, the tractor turned off, and all evidence of rotation has ceased. (S3PT-10)

**“Wait a minute...Save a life!”**

# SAFETY

**DANGER!**



There are obvious and hidden potential hazards in the operation of this Mower. **REMEMBER!** This machine is often operated in weeds and in heavy grass. The Blades of this Mower can throw objects if shields are not properly installed and maintained. Serious injury or even death may occur unless care is taken to insure the safety of the operator, bystanders, or passersby in the area. Do not operate this machine with anyone in the immediate area. Stop mowing if anyone is within 100 yards of mower. (SFM-1)



**DANGER!**



All Safety Shields, Guards and Safety devices including (but not limited to) - the Discharge Deflectors, Steel Guards, Gearbox Shields, Belt Shields, and PTO Shields should be used and maintained in good working condition. All safety devices should be inspected carefully at least daily for missing or broken components. Missing, broken, or worn items must be replaced at once to reduce the possibility of injury or death from thrown objects, entanglement, or blade contact. (SFM-2)

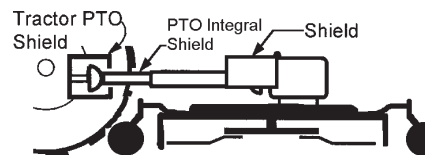

**DANGER!**



Rotary Mowers are capable under adverse conditions of throwing objects for great distances (100 yards or more) and causing serious injury or death. Follow safety messages carefully



**STOP MOWING IF PASSERSBY ARE WITHIN 100 YARDS UNLESS:**

- Mower Deck Shielding, and Discharge Deflector are installed and in good, working condition;
- Mower section is running close to and parallel with the ground without exposed Blades;
- Passersby are outside the existing thrown-object zone;
- All areas have been thoroughly inspected and all foreign material such as rocks, cans, glass, and general debris has been removed.

NOTE: Where there are grass and weeds high enough to hide debris that could be struck by the blades, the area should be: inspected and large debris removed, mowed at an intermediate height, inspected closely with any remaining debris being removed, and mowed again at desired final height. (This will also reduce power required to mow, reduce wear and tear on the Mower drivetrain, spread cut material better, eliminate streaking, and make the final cut more uniform.) (SFM-3)

# SAFETY

SAFETY

## DANGER!



Replace bent or broken blade with new blades. NEVER ATTEMPT TO STRAIGHTEN OR WELD ON BLADES SINCE THIS WILL LIKELY CRACK OR OTHERWISE DAMAGE THE BLADE WITH SUBSEQUENT FAILURE AND POSSIBLE SERIOUS INJURY FROM THROWN BLADES.

(SGM-10)

In addition to the design and configuration of this Implement, including Safety Signs and Safety Equipment, hazard control and accident prevention are dependent upon the awareness, concern, prudence, and proper training of personnel involved in the operation, transport, maintenance, and storage of the machine. Refer also to Safety Messages and operation instruction in each of the appropriate sections of the Tractor and Equipment Manuals. Pay close attention to the Safety Signs affixed to the Tractor and Equipment. (SG-18)

### PARTS INFORMATION

Servis-Rhino mowers use balanced and matched system components for blade carriers, blades, cuttershafts, knives, knife hangers, rollers, drivetrain components, and bearings. These parts are made and tested to Servis-Rhino specifications. Non-genuine "will fit" parts do not consistently meet these specifications. The use of "will fit" parts may reduce mower performance, void mower warranties, and present a safety hazard. Use genuine Servis-Rhino mower parts for economy and safety. (SPRM-1)

**SEE YOUR SERVIS-RHINO DEALER**



# SAFETY

SAFETY

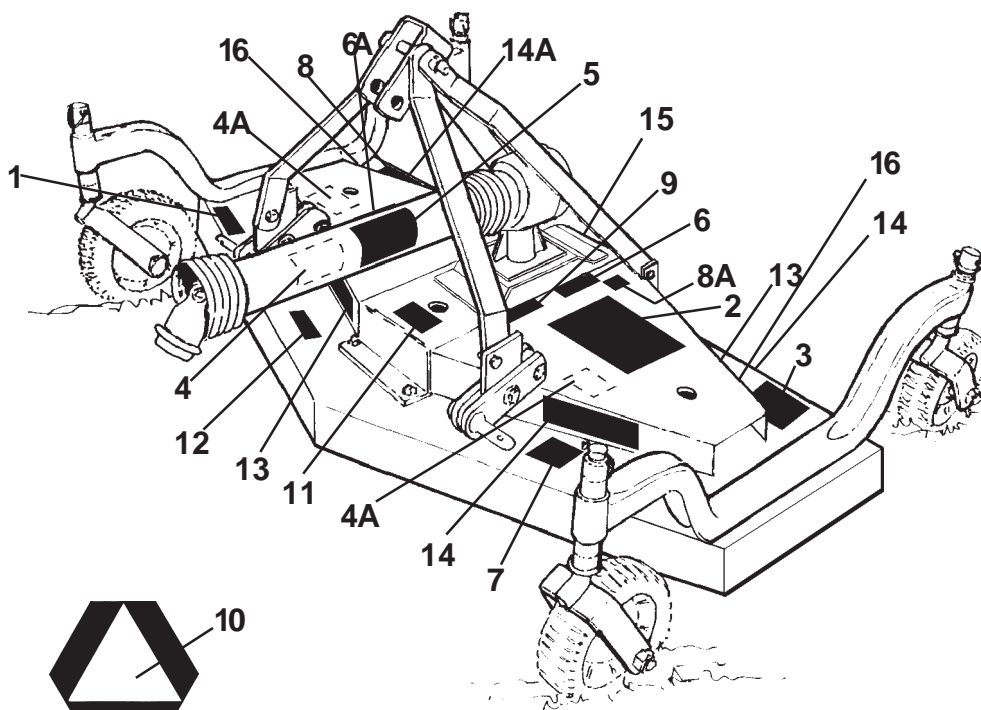

**NOTE:** Rhino supplies safety decals on this product to promote safe operation. Damage to the decals may occur while in shipping, use, or reconditioning. Rhino cares about the safety of its customers, operators, and bystanders, and will replace the safety decals on this product in the field, free of charge (Some shipping and handling charges may apply). Contact your Rhino dealer to order replacement decals.

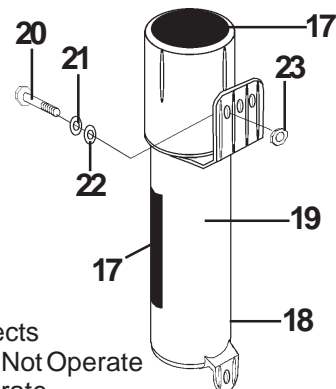

ITEM	PART NO.	QTY	LEVEL	DESCRIPTION
1	00725746	1	PELIGRO	Translate Safety Material
2	00749117	1	DANGER	Multi-Hazard
3	00755742	1	DANGER	Cutting Blades/Thrown Objects
4	00756004	((1))	DANGER	Driveline Shield Missing-Do Not Operate
4A	00775933	2	WARNING	Shield Missing. Do Not Operate
5	00756005	((1))	DANGER	Rotating Driveline/Entanglement
6	00756494	1	DANGER	Driveline Hazards
6A	00769737	1	DANGER	Blades/ Thrown Objects
7	00758194	2	WARNING	V-Belt Pinch Point
8	00760657	1	IMPORTANT	Genuine Rhino Parts
8A	00773723	1	PELIGRO	Rotating Driveline Translation
9	D103	1	WARNING	540 RPM
10	03200347	*	REFLECTOR	SMV
11	00755691	1	INSTRUC	Lube, Blade Bolt
12	00763977	1	INSTRUC	Notice to Owner
13	99101	6	LOGO NAME	Rhino Name (2 x 7-3/8)
14	00771819	2	NAME	GROUNDKEEPER
14A	00767476	1	NAME	GK60
	00767477	1	NAME	GK72
15	nfs	1	SERIAL PLATE	FM Serial Plate
16	2738332	2	REFLECT	Red Reflectors
17	00776481	1	INSTRUCT	Operators Manual Inside
18	00776031	1	-----	Canister, Operators Manual
19	00767471C	1	-----	Operators Manual
20	10058000	3	-----	Bolt
21	00017000	3	-----	Lockwasher
22	00024100	3	-----	Flatwasher
23	02959924	3	-----	Locknut

\* Furnished by Tractor Manufacturer

(( )) Installed by D/L Manufacturer

# SAFETY

SAFETY

## PELIGRO

Si No Lee Ingles, Pida Ayuda a Alguien Que Si Lo Lea Para Que le Traduzca las Medidas de Seguridad.

LEA EL INSTRUCTIVO



00725746

1 - 00725746

## DANGER



### KEEP AWAY!

THROWN OBJECTS OR  
BLADE CONTACT  
CAN CAUSE SERIOUS  
INJURY OR DEATH.  
KEEP DISCHARGE CHUTE  
AND SHIELDS IN PLACE.

Part No.  
00755742

3 - 00755742

## DANGER



GUARD MISSING  
DO NOT OPERATE

00756004

## DANGER



GUARD MISSING  
DO NOT OPERATE

00756004

## DANGER

4 - 00756004

## DANGER



ROTATING DRIVELINE-  
CONTACT CAN CAUSE DEATH  
**KEEP AWAY!**

DO NOT OPERATE WITHOUT-

- All driveline guards, tractor and equipment shields in place
- Drivelines securely attached at both ends
- Driveline guards that turn freely on driveline

00756005

5 - 00756005

2 - 00749117 - Not Shown  
(See Inside Front Cover of Manual)

## DANGER

1. MAKE CERTAIN DRIVELINES ARE OF THE CORRECT LENGTH AND SECURELY ATTACHED. DRIVELINE SEPARATION AND/OR PTO SHAFT FAILURE CAN CAUSE INJURY OR DEATH. (See Operator's Manual for procedure.)

\* SEE MANUAL FOR MINIMUM OVERLAP & MINIMUM/MAXIMUM LENGTHS

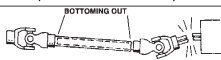

2. MAKE CERTAIN THAT DRIVELINE SHIELDS ARE INSTALLED CORRECTLY AND TURN FREELY TO PREVENT INJURY OR DEATH FROM ENTANGLEMENT



3. MAKE CERTAIN THAT DRIVELINE IS INSTALLED CORRECTLY ON TRACTOR PTO SHAFT. MOVE YOKE BACK AND FORTH UNTIL LOCKING COLLAR CLICKS FORWARD AND LOCKS YOKE IN PLACE

4. 540 PTO RPM UNLESS SPECIFICALLY MARKED OTHERWISE.

00756494

6 - 00756494

## WARNING

OPERATE THIS MACHINE AT  
**540 RPM**  
TRACTOR PTO SPEED ONLY

Overspeeding PTO may cause component failure with resulting injury. D103

9 - D103

## WARNING

DO NOT OPERATE WITH BELT SHIELD REMOVED. FINGER(S) MAY BE PINCHED OFF IF CAUGHT BETWEEN V-BELT AND PULLEY.



00758194

7 - 00758194

## IMPORTANT

For your safety and to guarantee optimum product reliability, always use Genuine RHINO replacement parts. The use of inferior "will-fit" parts will void Warranty of your RHINO implement and may cause premature or catastrophic failure which can result in serious injury or death. If you have any questions concerning the repair parts you are using, contact Servis-Rhino, 1502 E. Walnut Seguin, TX 78155 (830) 372-3080.



8 - 00760657

<b>LUBRICATE</b>  <b>Every 10 Hours</b>	<b>Driveline—3 Places</b> <b>Caster Wheel—2 Places on each</b> <b>Blade Shaft Housing—1 Place on each</b>
	<b>Use Clean #2 Lithium-Based Bearing Grease</b>
<b>NOTICE: Blade Bolts Have Left Hand Threads</b>	

00755691

11 - 00755691

## NOTICE TO OWNER

An OPERATOR'S MANUAL (with Repair Parts Listing) and a WARRANTY REGISTRATION CARD were attached to this implement during final inspection at the factory. If they were not attached at the time of purchase, please contact your selling dealer at once.

1. Read and understand Manual before operating the implement.
2. Complete, sign, and mail the Warranty Registration Card in today.

00763977

12 - 00763977



4A - 00775933

# RHINO

13 - 99101

# GROUNDSKEEPER

14 - 00771819

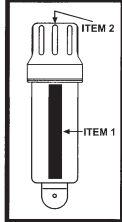
<b>OPERATOR'S MANUAL INSIDE</b> <b>READ AND UNDERSTAND Before Operating Tractor &amp; Implement</b> <small>If Manual is missing, obtain one before operating from Dealer or Alamo Group (800) 221-2855</small>	
 <small>ITEM 2</small>	 <small>ITEM 1</small>
<small>00776481 Decal Canister Sheet</small>	

17 - 00776481

**PELIGRO**



**LÍNEA DE CONDUCCIÓN GIRATORIA-**  
**EL CONTACTO PUEDE CAUSAR LA MUERTE**  
**¡MANTENERSE LEJOS!**  
**NO FUNCIONE SIN QUE-**

Un manual de la seguridad de la línea de conducción n/p 00773776 está disponible en español. Llame el número enumerado para una copia gratis.

- Todos los protectores de la línea de Conducción, alimentador y blindajes del Equipo estén en su lugar
- Las líneas de conducción estén conectadas con seguridad en ambos extremos
- Los protectores de la línea de conducción den vuelta libremente en la línea de Conducción

00773723

8A - 00773723

# SAFETY

## FEDERAL LAWS AND REGULATIONS

This section is intended to explain in broad terms the concept and effect of federal laws and regulations concerning employer and employee equipment operators. This section is not intended as a legal interpretation of the law and should not be considered as such.

### Employer-Employee Operator Regulations

U.S. Public Law 91-596 (The Williams-Steiger Occupational and Health Act of 1970) OSHA

#### This Act Seeks:

"...to assure so far as possible every working man and woman in the nation safe and healthful working conditions and to preserve our human resources..."

#### DUTIES

Sec. 5 (a) Each employer-

(1) shall furnish to each of his employees employment and a place of employment which are free from recognized hazards that are causing or are likely to cause death or serious physical harm to his employees;

(2) shall comply with occupational safety and health standards promulgated under this Act.

(b) Each employee shall comply with occupational safety and health standards and all rules, regulations and orders issued pursuant to this Act which are applicable to his own actions and conduct.

#### OSHA Regulations

OSHA regulations state in part: "At the time of initial assignment and at least annually thereafter, the employer shall instruct every employee in the safe operation and servicing of all equipment with which the employee is, or will be involved."

#### Employer Responsibilities:

To ensure employee safety during Tractor and Implement operation, it is the employer's responsibility to:

1. Train the employee in the proper and safe operation of the Tractor and Implement.
2. Require that the employee read and fully understand the Tractor and Implement Operator's manual.
3. Permit only qualified and properly trained employees to operate the Tractor and Implement.
4. Maintain the Tractor and Implement in a safe operational condition and maintain all shields and guards on the equipment.
5. Ensure the Tractor is equipped with a functional ROPS and seat belt and require that the employee operator securely fasten the safety belt and operate with the ROPS in the raised position at all times.
6. Forbid the employee operator to carry additional riders on the Tractor or Implement.
7. Provide the required tools to maintain the Tractor and Implement in a good safe working condition and provide the necessary support devices to secure the equipment safely while performing repairs and service.
8. Require that the employee operator stop mowing if bystanders or passerbys come within 100 yards.

#### Child Labor Under 16 Years of Age

Some regulations specify that no one under the age of 16 may operate power machinery. It is your responsibility to know what these regulations are in your own area or situation. (Refer to U.S. Dept. of Labor, Employment Standard Administration, Wage & Home Division, Child Labor Bulletin #102.)



# Safety Manual

*For Operators  
and Mechanics*

# Industrial/ Agricultural Mower

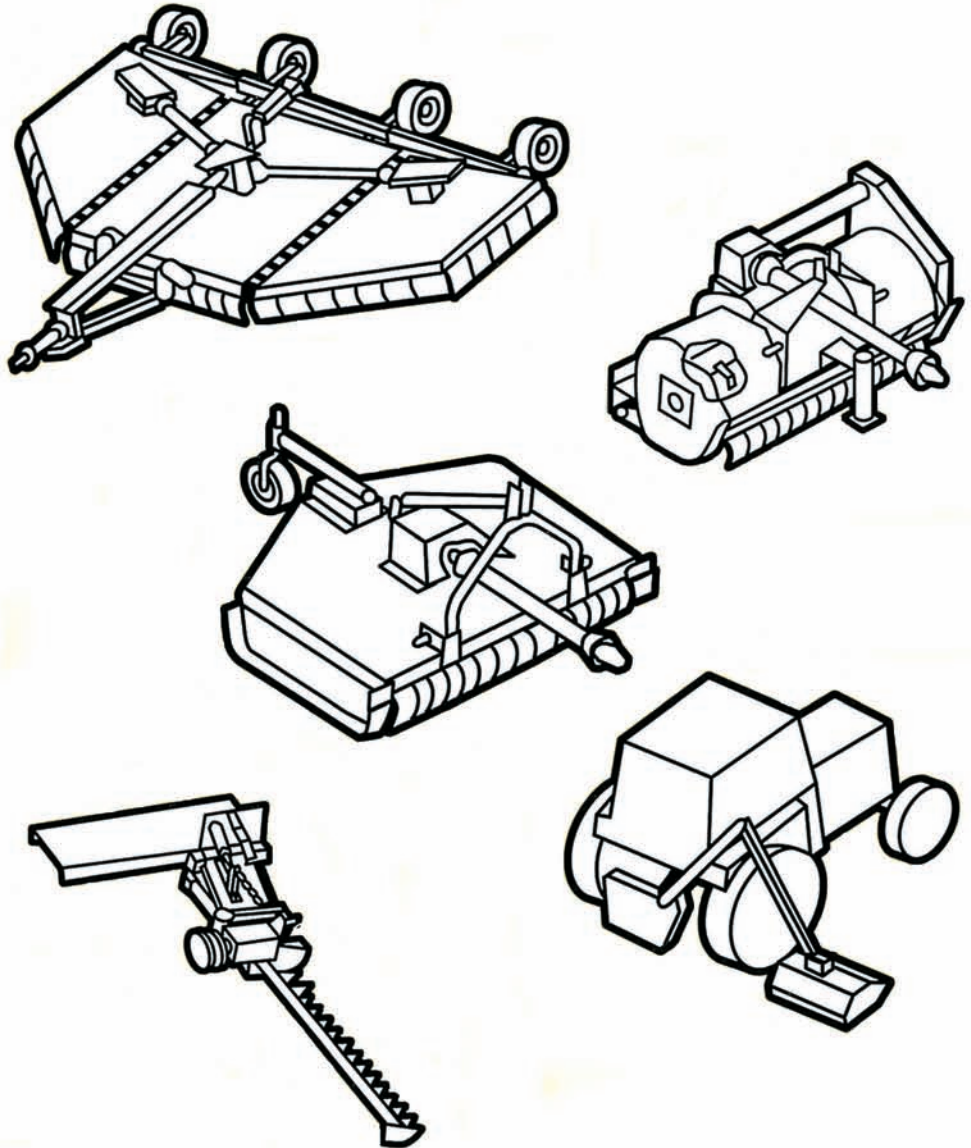

111 E. Wisconsin Avenue • Milwaukee, Wisconsin 53202 U.S.A.  
[www.aem.org](http://www.aem.org)

# Contents

---

<b>Acknowledgement</b> .....	2
<b>Forward</b> .....	3
<b>A Word to the User</b> .....	3
<b>Safety Alert Symbol</b> .....	4
<b>Industrial/Agricultural Mower Types</b> .....	4
<b>Be a Responsible Operator</b> .....	5
<b>Safety Management of Hazards and Risks</b> .....	6
<b>Follow a Safety Program</b> .....	11
<b>Safety-Before Operation</b> .....	11
<b>Safety-Starting and Testing</b> .....	13
<b>Safety-During Operation</b> .....	14
<b>Safety-During Shutdown</b> .....	18
<b>Safety-During Maintenance</b> .....	19
<b>One Final Word</b> .....	21

# Acknowledgement

---

We wish to acknowledge the contributions of the members of the Association of Equipment Manufacturers to the preparation of this Safety Manual.

**Copyright**  
© 2000 AEM (formerly Equipment Manufacturers Institute). Revised 08.2003. All rights reserved.

## Forward

---

This Safety Manual is intended to point out some of the basic safety situations which may be encountered during the normal operation and maintenance of your machine and to suggest possible ways of dealing with these conditions. This manual is NOT a substitute for the manufacturer's manual(s).

Additional precautions may be necessary, or some instructions may not be applicable, depending on the equipment, attachment devices, and conditions at the worksite or in the service area. The manufacturer has no direct control over machine application, operation, inspection, lubrication, or maintenance. Therefore, it is **YOUR** responsibility to use good safety practices in these areas.

The information provided in this manual supplements the specific information about your machine that is contained in the manufacturer's manual(s). Other information which may affect the safe operation of your machine may be contained on safety signs or in insurance requirements, employer's safety and training programs, safety codes, local, state/provincial and national laws, rules and regulations.

**IMPORTANT:** *If you do not have the manufacturer's manual(s) for your particular machine, get a replacement manual from your employer, equipment dealer, or the manufacturer of your machine. Keep this safety manual and the manufacturer's manual(s) with your machine.*

## A Word to the User

---

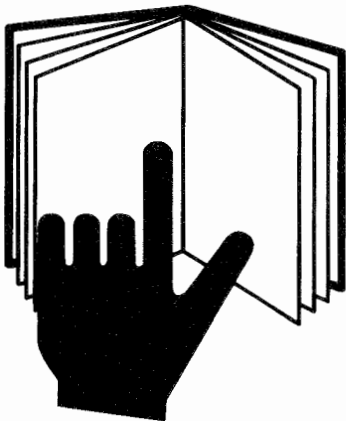

It is your responsibility to read and understand this safety manual and the manufacturer's manual(s) before operating this machine. This safety manual takes you step-by-step through your working day. The safety manual, manufacturer's manual(s), safety signs (decals) and safety precautions must be explained to those users or operators who cannot read the material.

In addition to equipment design and configuration, **HAZARD CONTROL** and **ACCIDENT PREVENTION** are dependent upon the owner's and operator's awareness, concern, prudence, and proper training in the operation, transport, maintenance and storage of equipment.

Remember that **YOU** are the key to safety. Good safety practices not only protect you but also protect the people around you. Study this manual and the manufacturer's manual(s) for your specific machine. Make them a working part of your safety program. Keep in mind that this safety manual is written only for industrial and agricultural mowers.

**Practice all usual and customary safe working precautions and above all – remember safety is up to YOU. Only YOU can prevent serious injury or death from unsafe practices.**

# Safety Alerts

## Symbol

This Safety Alert Symbol means:

**“ATTENTION! BECOME ALERT!  
YOUR SAFETY IS INVOLVED!”**



The Safety Alert Symbol identifies important safety messages on equipment, safety signs, in manuals or elsewhere. When you see this symbol, be alert to the possibility of death or personal injury. Follow the instructions in the safety message.

## Signal Words

Signal words are distinctive words that will typically be found on safety decals on this equipment or other equipment on the worksite. These words are intended to alert the viewer to the existence and relative degree of a hazard.



This signal word indicates an imminently hazardous situation which, not avoided, will result in death or serious injury.



This signal word indicates a potentially hazardous situation which, if not avoided, could result in death or serious injury.



This signal word indicates a potentially hazardous situation exists which, if not avoided, may result in minor or moderate injury.

- ACCIDENTS DISABLE AND KILL.
- ACCIDENTS COST.
- ACCIDENTS CAN BE AVOIDED.

# Industrial/Agricultural Mowers

A mower for pasture clipping, crop residue shredding, heavy brush cutting for land clearing, waterways, right-of-ways, road side or highway mowing.

## INDUSTRIAL/AGRICULTURAL MOWER TYPES:

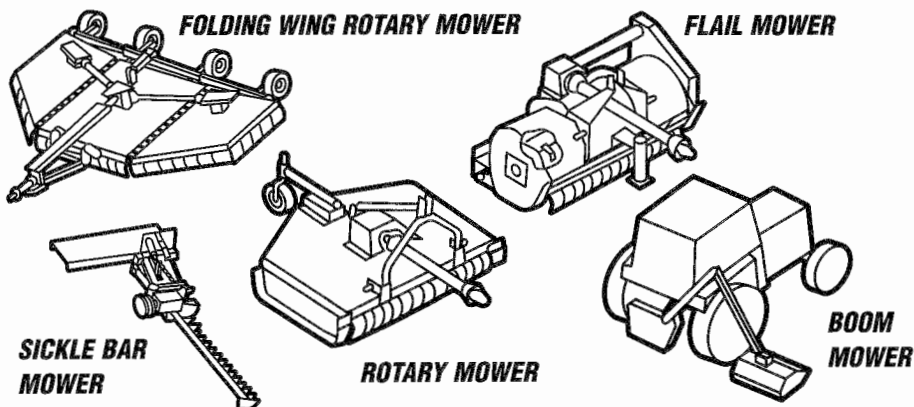



# Be a Responsible Operator



**DON'T**  
Drink & Drive



**DON'T**  
Take  
Drugs & Drive

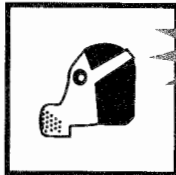
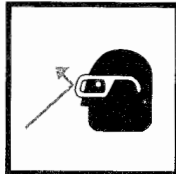
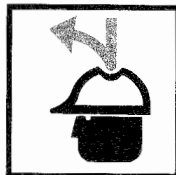

**PROTECT**  
Yourself



**CALL**  
For Assistance

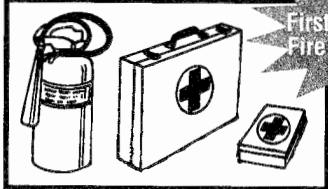

**LOCATE**  
First Aid Kits and  
Fire Extinguisher

For safe operation of your equipment, you must be a responsible operator. A responsible operator must clearly understand the written instructions supplied by the manufacturer, be trained—including actual operation of the equipment and know the safety rules and regulations for the worksite.

Drugs and alcohol will affect an operator's alertness and coordination and therefore affect the operator's ability to operate the equipment safely. An operator should **NEVER** use drugs which affect alertness, judgement and coordination or alcohol while operating motorized equipment, including tractors and mowers. An operator on prescription or over-the-counter medication must consult a medical professional regarding any side effects of the medication that would hinder his or her ability to operate this equipment safely. **NEVER** knowingly allow anyone to operate this equipment when their alertness, judgement or coordination is impaired.

## Protect Yourself

Wear all the protective clothing and personal safety devices issued to you or called for by job conditions.

### You may need:

- Hard hat
- Safety shoes
- Safety glasses with side shields, goggles or face shield
- Heavy gloves
- Hearing protection
- Reflective clothing
- Wet weather gear
- Respirator or filter mask

Wear adequate clothing for the job conditions.

Always know where to get assistance in the case of an emergency. Know where to find and how to use a first aid kit and fire extinguisher/fire suppression system.

**Stay alert. Avoid accidents.  
Don't learn safety the hard way.**

# Safety Management of Hazards and Risks

In addition to equipment design and configuration, **HAZARD CONTROL** and **ACCIDENT PREVENTION** are dependent upon the owner's and operator's awareness, concern, prudence, and proper training in the operation, transport, maintenance and storage of equipment.

**SAFETY MANAGEMENT OF HAZARDS AND RISKS IS ESSENTIAL TO RESPONSIBLE OWNERS AND OPERATORS OF TRACTORS AND MOWERS.**

**REVIEW THE FOLLOWING SAFETY MANAGEMENT OF LISTED HAZARDS AND RISKS:**

## ***Thrown Object Hazard***

**POSSIBLE THROWN OBJECT INJURY RISKS EXIST FOR MOWER OPERATORS AND BYSTANDERS DURING MOWER OPERATIONS FROM THE FOLLOWING:**

**DISCHARGED OBJECTS (ROCKS, DEBRIS, BROKEN MOWER BLADES, BLADE BOLTS, CABLES, CHAINS, WIRE, ETC....) FROM THE MOWER.**

## ***Equipment Protective Devices And Recommended Safety Practices***

The mower deck and protective devices cannot prevent all objects or debris from escaping the blade enclosure area in every mowing condition. It is possible for objects to escape and travel several hundred (300) feet.

### **RECOMMENDED SAFETY PRACTICES**

Read manufacturer's operator manual(s) for recommended operating safety practices. Explain the practices to users or operators who cannot read.

**TO HELP PREVENT SERIOUS INJURY OR DEATH FROM OBJECTS STRIKING OPERATOR OR OTHER PERSONS DO THE FOLLOWING:**

#### **BYSTANDERS SAFETY**

- Keep bystanders several hundred (300) feet from mowing area.

#### **EQUIPMENT PROTECTIVE DEVICES SAFETY**

**To contain, deflect or reduce thrown objects from blade enclosure area:**

- Keep chain, flexible or solid deflector shields in place on the front and rear of the mower deck and in good repair.
- Do not operate with damaged or missing thrown object shielding.

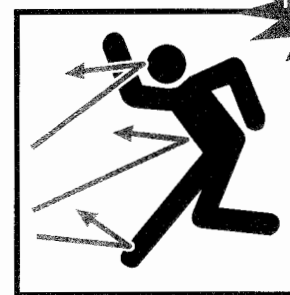
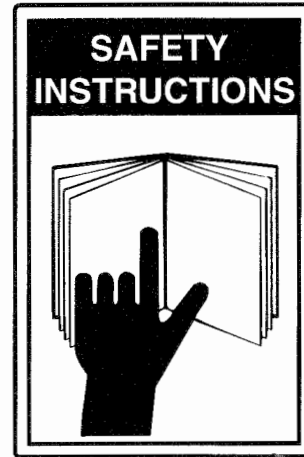

**THROWN Object Hazard**

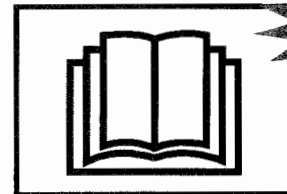

**READ Manuals**

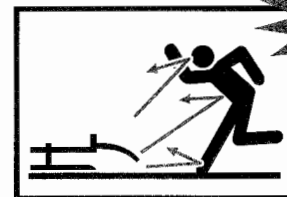

**KEEP Bystanders Away**

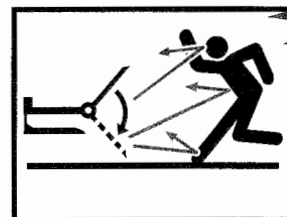

**THROWN Object Hazard**

**USE ROPS  
Enclosed Cabs  
or Protective  
Enclosures**

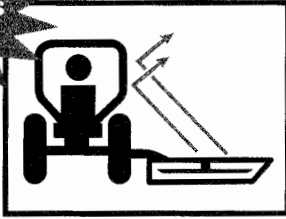

**USE Proper  
PTO Speed**

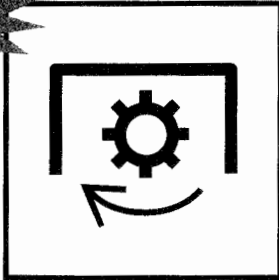

**MAINTAIN  
Equipment**



## **OPERATOR SAFETY**

Raised wings, side mount and boom type mower operations may reduce the mower's thrown object shielding effectiveness for the mower operator's protection.

**Do the following to increase operator protection from thrown objects during these mowing operations:**

- Use enclosed ROPS cabs, special protective enclosures, screens or other operator shielding devices when performing these operations.

## **EXCEEDING RECOMMENDED PTO SPEEDS**

Do not exceed manufacturer's recommended PTO speeds.

**Excessive PTO speeds may cause:**

- Blade failures
- Higher velocity objects escaping or broken blades being thrown from mower blade enclosures.
- Potential 540 rpm driveline failures operating at 750 to 1000 rpm speeds.

## **OTHER SAFETY PRACTICES:**

- Never operate mower with broken, bent, missing, or severely worn blades.
- Before mowing, remove debris and foreign objects to avoid them being picked up and thrown out by the mower.
- \* Do not operate the mower in transport or in raised wing positions.

## **RECOMMENDED MAINTENANCE PRACTICES**

Read manufacturer's operator manual(s) inspection and maintenance instructions for chain guards, flexible or solid deflector shielding:

- Replace worn or damaged guards and other shielding before mowing.
- Use only manufacturer's replacement guards and shielding. Other guarding or shielding sources may not fit or have inadequate materials to meet the strength requirements of the equipment.
- Replace worn or damaged decals and warning instructions.
- Explain the inspection and maintenance instructions to those users or operators who cannot read.

# Rotating Blades and Driveline Hazards and Risks

A POSSIBLE INJURY RISK EXISTS TO MOWER OPERATORS AND BYSTANDERS DURING MOWING OPERATIONS FROM THE FOLLOWING:

- BODY CONTACT WITH ROTATING BLADES.
- BODY ENTANGLEMENT WITH ROTATING DRIVELINES AND PARTS.

## Equipment Protective Devices and Recommended Safety Practices

### RECOMMENDED SAFETY PRACTICES

Read manufacturer's operator manual(s) for recommended operating safety practices. Explain the practices to those users or operators who cannot read. To help prevent serious injury or death from moving blade contact, driveline or parts entanglement of operators or other persons do the following:

#### BYSTANDERS SAFETY

- Do not operate near bystanders.
- Keep other persons several hundred (300) feet from the mowing area.

#### OPERATOR SAFETY PRACTICES

- Do not allow riders on tractor or mower. Securely fasten seat belt when mowing.
- Use proper equipment shutdown practice before servicing, adjusting, cleaning or unclogging the mower.
- Keep clear of rotating blades, parts, and drivelines.
- Never start tractor engine while standing beside equipment.
- Only start tractor engine while sitting in operator's seat with seat belt fastened.

#### RECOMMENDED GUARDS, DRIVELINE GUARDS AND SHIELDING SAFETY PRACTICES

- Keep guards, driveline and other shielding in place and in good repair.
- Do not operate mower with missing or damaged guards, driveline guards or other shielding.

#### RECOMMENDED MAINTENANCE PRACTICES

Read manufacturer's operator manual(s) inspection and maintenance instructions for guards, driveline guards and other shielding:

- Replace worn or damaged guards, driveline guards and other shielding before mowing.
- Use only manufacturer's replacement guards and shielding. Other guarding or shielding sources may not fit or have inadequate materials to meet the strength requirements of the equipment.
- Replace worn or damaged decals and warning instructions.
- Explain the inspection and maintenance instructions to those users or operators who cannot read.

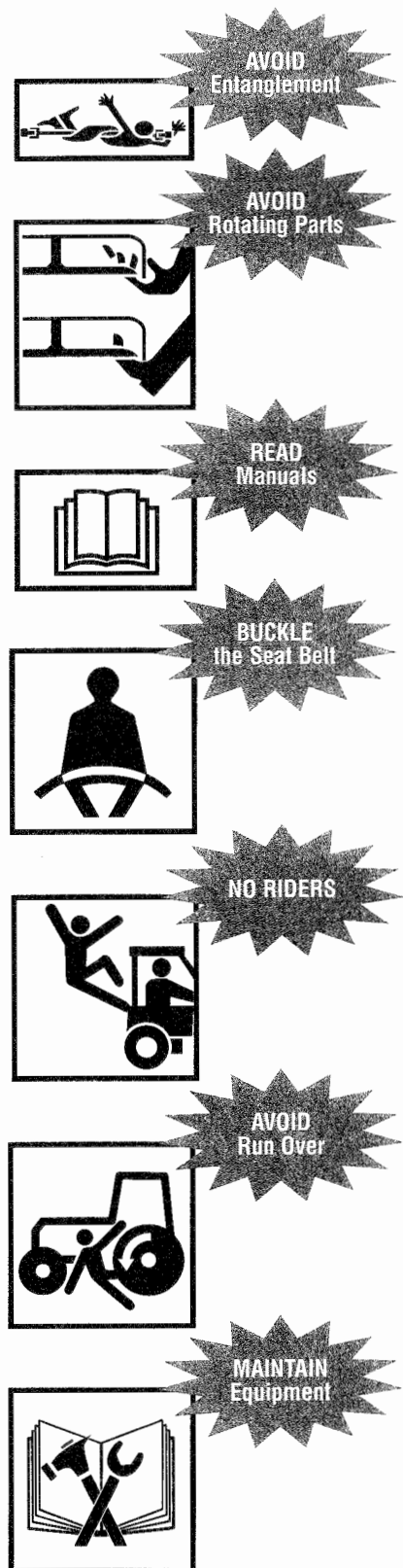

## ***Tractor and Mower Rollover or Overturn Hazards and Risks***

A POSSIBLE ROLLOVER OR OVERTURN INJURY RISK EXISTS TO MOWER OPERATORS DURING MOWING OPERATIONS FROM THE FOLLOWING:

- ROUGH TERRAIN, STEEP SLOPES, HOLES, BUMPS, RUTS, ROCKS, STUMPS OR OTHER OBSTRUCTIONS THAT COULD OVERTURN TRACTOR AND MOWER.
- EXCESSIVE GROUND SPEEDS FOR THESE TERRAIN CONDITIONS.

### ***Equipment Protective Devices and Recommended Safety Practices***

When possible remove stumps, stones, etc.. or mark them and other obstructions clearly to avoid upsets, breakdowns, and dangerous driving conditions. Use extreme care to maintain control over the equipment when operating in these terrain conditions.

#### **RECOMMENDED-TRACTOR ROPS**

A tractor equipped with ROPS or enclosed ROPS cab and seat belt for operator safety is essential for additional operator protection when operating mower in these terrain conditions.

#### **RECOMMENDED-TRACTOR STABILITY ADJUSTMENTS**

Read the tractor operator's manual for adjustments to increase tractor stability:

- Adding front and rear wheel weights or ballast.
- Adjusting wheel spacing to maximum width .
- Adding off-side counter ballast to side-mounted and boom mowers.
- Explain adjustments to those users or operators who cannot read.

### **RECOMMENDED SAFETY PRACTICES**

Read manufacturer's operator manual(s) for recommended operating safety practices. Explain the practices to those users or operators who cannot read. **To help prevent serious injury or death to the operator from tractor and mower overturns, do the following:**

- Securely fasten seat belt when mowing with ROPS equipped tractors.
- Avoid excessive ground speed for terrain conditions.
- Avoid sudden starts, stops and turns when operating up, down or across slopes.
- Avoid slippery ground conditions.
- Make wide and gradual turns.
- Plan to mow down hill on steep slopes to avoid overturning.

### ***Falling Mower or Parts Crushing Hazards and Risks***

A POSSIBLE CRUSHING INJURY RISK EXISTS FOR MOWER OPERATORS AND OTHERS DURING MOWING OPERATIONS FROM THE FOLLOWING:

- FALLING MOWER OR EQUIPMENT FROM HYDRAULIC SYSTEM FAILURE.
- FAILURE TO SECURELY SUPPORT, BLOCK-UP OR LOCK-UP LIFTED MOWER OR EQUIPMENT PARTS.

**AVOID  
Rollover**

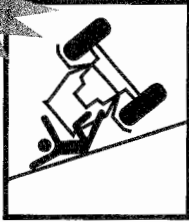

**USE  
Tractor ROPS**



**READ  
Manuals**

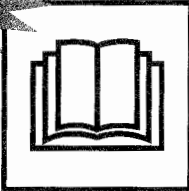

**ADD  
Ballast**



**WIDEN  
Wheel Spacing  
and ADD Off-Side  
Ballast**



**BUCKLE  
the Seat Belt**



**AVOID  
CRUSHING  
Lock-Up Wing**



## Equipment Protective Devices and Recommended Safety Practices

Read manufacturer's operator manual(s) for recommended operating safety practices. Explain the practices to those users or operators who cannot read. **To help prevent serious injury or death to operators and other from alling mower or equipment parts, do the following:**

### **RECOMMENDED SAFETY PRACTICES**

Before working near or underneath lifted mower or equipment parts:

- Use proper equipment shutdown practices before servicing, adjusting, cleaning or unclogging the mower.
- Securely support or block-up raised mower or equipment parts.
- Securely support, block-up or lock-up wings with locking devices on wing type mowers or lower mower or equipment parts to the ground.
- Use transport locks when transporting mower on public roads.

## High Pressure Hydraulic Fluid Leak Hazards and Risks

**A POSSIBLE HIGH PRESSURE FLUID SKIN INJECTION INJURY AND GANGRENE RISK EXISTS FOR MOWER OPERATORS AND OTHERS FROM HIGH PRESSURE HYDRAULIC OR DIESEL OIL LEAK INJECTION INTO THE SKIN.**

**TO AVOID GANGRENE, INJECTED FLUID MUST BE SURGICALLY REMOVED WITHIN A FEW HOURS BY A DOCTOR FAMILIAR WITH THIS TYPE OF INJURY.**

### **RECOMMENDED SAFETY PRACTICES**

Read manufacturer's operator manual(s) for recommended operating safety practices. Explain the practices to those users or operators who cannot read. High pressure fluid pinhole leaks can be almost invisible.

**To help prevent serious injury or death, do the following:**

- Search for leaks with cardboard or wood.
- Do not use hands to check for leaks.
- Relieve system pressure before disconnecting lines.
- Before applying system pressure:
  - Check for damaged lines, pipes, and hoses.
  - Check to insure tight connections.
- Before operating pressurized systems:
  - Purge air from system.
  - Refer to the manufacturer's operator manual(s) for instructions.
  - Explain the procedures to those users or operators who cannot read.

## Tractor Refueling Hazards and Risks

**To avoid serious injury or death from fire during refueling:**

- Shut off engine and ignition.
- Never fill fuel tank near open flames.
- Never smoke while refueling.
- Avoid static electricity sparks by grounding fuel nozzle against tank filler neck.
- Avoid overfilling tank or spilling fuel.
- Clean up any spilled fuel immediately.
- Always replace fuel cap.

**To avoid serious injury or death from engine exhaust fumes:**

- Adequately ventilate enclosed spaces before starting the engine.

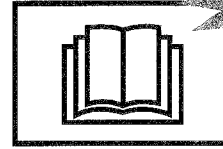

**READ  
Manuals**

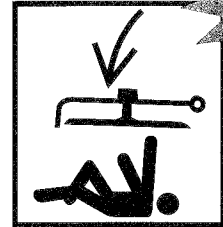

**AVOID  
CRUSHING  
Block-Up or  
Securely Support  
Mower**

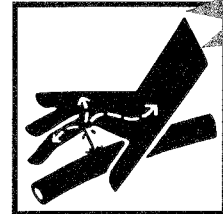

**HIGH  
PRESSURE FLUID  
Can Inject  
into the Body**



**READ  
Manuals**

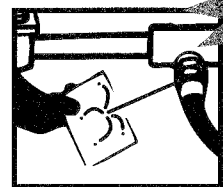

**AVOID  
INJECTION  
Use Cardboard  
Not Hands**



**AVOID  
Fires and  
Explosions**

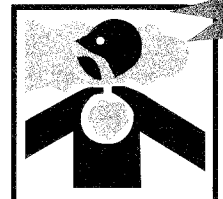

**AVOID  
Exhaust Fumes**

## Follow A Safety Program

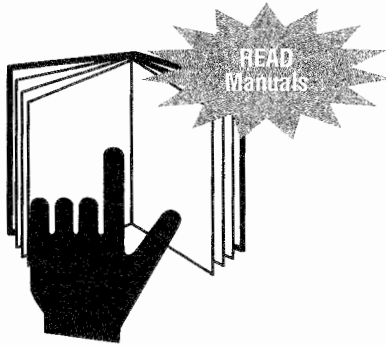

**SAFETY IS IMPORTANT TO RESPONSIBLE OWNERS AND OPERATORS OF TRACTORS AND MOWERS. DO THE FOLLOWING FOR YOUR SAFE MOWING OPERATION:**

### **BE A QUALIFIED OPERATOR BY:**

- Reading, understanding and obeying the manufacturer's written instructions in operator manual(s) and safety signs on mower and tractor.
- Receiving operational training with mower and tractor.
- Asking your equipment dealer or supervisor to explain things you do not understand.
- Explaining the written instructions in the operator manual(s) and safety signs (decals) on the mower and tractor to those users or operators who cannot read.

## Safety Before Operation

### **Know Job Site Safety Rules And Regulations**

Ask your supervisor about equipment operation safety rules you will be expected to obey.

#### **Some basic rules for your's and others' safety:**

- A ROPS and seat belt equipped tractor is required for operator protection during mowing operations.
- Know mower and tractor operating capacity and characteristics.
- Never alter or remove safety equipment.
- Never allow children or unqualified persons to operate mower or tractor.
- Never allow riders on mower or tractor.
- Keep others away from mowing operation.
- Use proper equipment shutdown practice before dismounting tractor.
- Allow all moving parts to stop before making equipment inspections, repairs, or adjustments.
- Securely support or block-up mower before working beneath mower or lifted components.
- Wear personal protective clothing and safety devices issued to you or recommended by the equipment manufacturer.



### **Know Tractor And Mower Controls**

#### **Know the following about your tractor and mower:**

- Function, purpose and use of controls.
- Safe operating speeds.
- Safe slope and uneven terrain capabilities.
- Braking and steering characteristics.
- Tractor and mower operating clearances.
- How to stop equipment quickly in an emergency.

## Use All Available Equipment Safety Devices

To help keep you and others around you safe:

- Make certain manufacturer's recommended guards, shields and safety signs are installed on equipment and in good condition.
- Keep all protective devices in place and securely fastened.
- **NEVER** operate your equipment with missing, disconnected or damaged safety devices.
- Use ballast and weight required for equipment operational stability.

## Check The Mower And Tractor Equipment

**Before beginning your work day:**

- Check for loose, broken, missing or damaged tractor and mower parts.
- Repair or replace these parts when needed.
- Check for proper tractor and mower attachments.
- Check for proper tractor and mower PTO rpm rating match.
- Check mower blades condition. Sharpen or replace per manufacturer's recommendation. Blade modifications, such as welding or hard surfacing cutting edges by welding or straightening bent blades, can reduce blade strength and adversely affect blade properties and safety.
- Check that all guards and shields are in place and that all equipment is in good operating condition. This includes PTO driveline, gearbox and implement guards and shields that are used for operator protection.
- Check for properly latched driveline yoke end locking devices.
- Check for damaged or leaky tractor and mower hydraulic systems.
- Check and read safety signs and warning instructions.
- Explain the safety signs and warning instructions to those users or operators who cannot read.

## Check The Work Area

**Inspect, identify and avoid hazardous conditions in the work area:**

- Rough terrain, drop-offs, ditches, potholes steep slopes, stumps, standing water, mud soft soil, slippery conditions, debris and foreign objects.
- Inspect mowing area and remove or mark all foreign objects and debris to be avoided by mower.

**Analyze mowing area to determine:**

- Best and safest mowing procedure.
- Material type and height to be mowed.
- Operating terrain conditions.
- Using forward travel mowing pattern when possible.

## Look Out For The Safety of Others

**Before starting equipment:**

- Walk around the equipment.
- Check for anyone under, on or near the equipment.
- Clear everyone from these areas.
- Sound a warning.



USE ROPS  
and Seatbelt

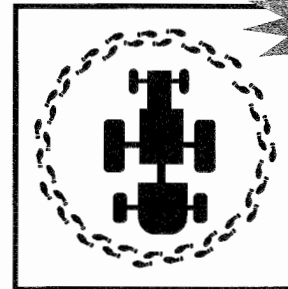

WALK AROUND  
Inspection

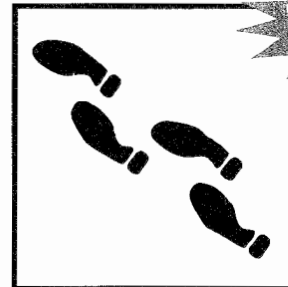

WALK AROUND  
the Worksite

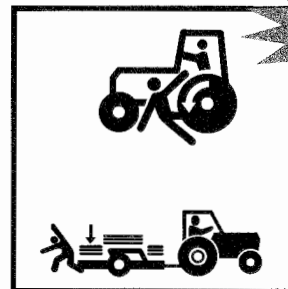

LOOK OUT  
For Others



# Safety – Starting & Testing

USE Three Point Contact



USE ROPS and Seatbelt



USE Proper PTO speed

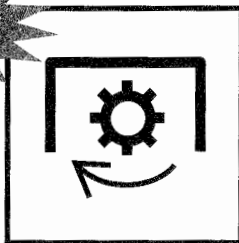

## Mounting Tractor Safety

### Before mounting:

- Clean shoes and wipe hands.

### During mounting and dismounting:

- Use handholds and step plates.
- Never grab steering wheels or controls for handholds.
- Never mount or dismount from a moving tractor.

## Tractor And Mower Controls Safety Test

### Before starting:

- Fasten and adjust seat belt on your ROPS-equipped tractor.
- Check parking brake for engagement.
- Check PTO disengagement.
- Check all controls for Neutral or Park position.
- Warn others in area before starting tractor.
- Follow tractor manufacturer's recommended starting procedures.

### After starting:

- Check all instruments, gauges and indicator lights for normal operation.
- Check all tractor controls, steering and brakes for proper function.
- Repair improperly functioning tractor before using.
- Raise and lower mower for driveline bottoming out or engagement problems.
- Check your equipment for excessive vibration and unusual noises.
- Use proper equipment shutdown practices before inspecting equipment.

## Power Takeoff System And Mower Safety

Tractors with dual-speed (540 or 1000 rpm) shiftable PTO systems.

To avoid serious injury or death from failed parts due to mower over speed:

- Be sure to position PTO selector to mower's rated PTO rpm speed.

Tractors with transmission-driven PTO systems.

A rotary mower will have a significant flywheel effect which may continue to propel a tractor with a transmission-driven PTO system.

The tractor should be equipped and operated as follows:

- Install an over-running clutch.
- Give yourself sufficient maneuvering room and time by anticipating turns, stops and speed reductions.

# Safety – During Operation

## Hitching Mower To Tractor Safety

### Three-point hitch-mounted mower safety:

- Refer to mower and tractor manufacturers' manuals.
- Place tractor's hydraulic power lift (rockshaft) selector lever in down position to avoid unexpected movement.
- Explain the hitching procedures to those users or operators who cannot read.

### Pull-type hitch-mounted mower safety:

- Refer to mower and tractor manufacturers' manuals.
- Attach only to drawbar hitch.
- Do not attach to tractor's rear axle or three-point hitch arms.
- Adjust tractor drawbar length for 540 or 1000 rpm PTO operation.

## Make The Right Start In Mower Safety

Mow only in daylight or good artificial light conditions.

### To avoid serious injury or death from mower thrown objects or blade contact:

- Keep chain shields, flexible or solid deflector shields or discharge chutes in place and in good repair.
- Keep everyone several hundred (300) feet from mowing operation.
- Never direct mower discharge toward anyone.
- Keep hands, feet and other body parts away from rotating parts, blades and discharge openings.
- Do not operate mower in transport position.

### Mower PTO drive engagement:

- Raise mower to maximum cutting height.
- Engage PTO at low engine rpm.
- Increase engine rpm to mower rated rpm PTO speed.
- Lower mower to desired cutting height.
- Stop and shut down immediately if the mower strikes an obstruction.
- Inspect and repair any mower damage before resuming mowing.
- Do not operate mower with severe vibrations or with unusual noise.

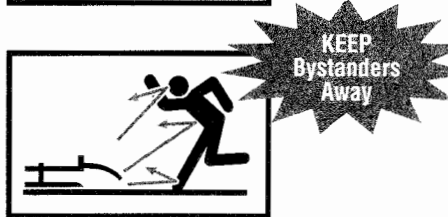
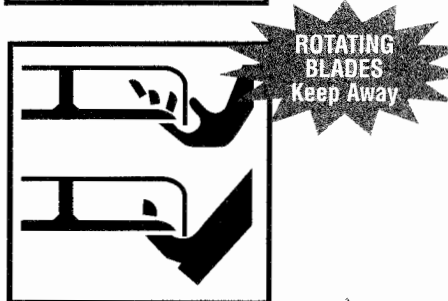
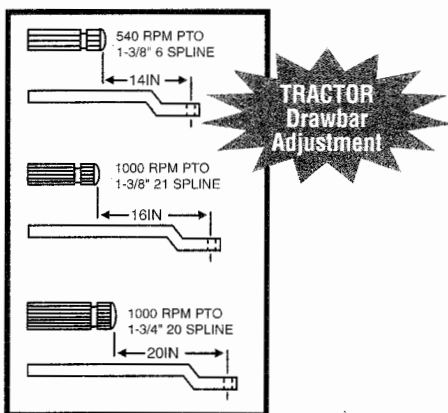
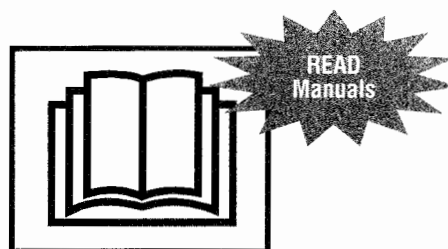

LOOK OUT  
For Others

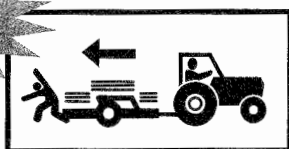

## Mowing In Reverse Safety

Avoid mowing in reverse direction when possible.

Do the following when mowing in reverse direction:

- Check for any persons behind mower before reversing direction.
- Use extreme care when reverse direction mowing.
- Maintain rotary mower front and rear safety shields and flail front shields and rear rollers.

MAINTAIN  
FLAIL  
Rear Roller

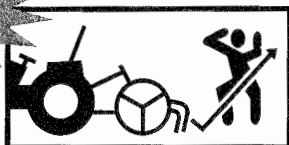

## Mowing Ground Speed

Proper ground speed depends on terrain conditions and grass type, density and height to be cut:

- Normal ground speed range is 2 to 5 mph.
- Slower ground speed for mowing tall, dense grass.
- Faster ground speed for mowing medium height, thin grass and under smooth terrain conditions.
- Use slower ground speed for mowing in rough, sloping or unfamiliar terrain.

USE PROPER  
Ground Speeds

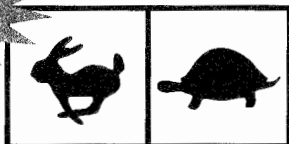

STOP BLADE  
Before  
Unclogging



## Extremely tall grass mowing

- You may need to mow extremely tall grass twice.

First mowing pass:

- Cut grass higher (10-15 inches) to avoid hidden objects.

PROVIDE  
Adequate  
Clearance for  
Mower Swing

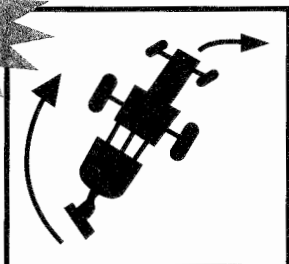

Second mowing pass:

- Remove debris and objects.
- Cut grass at desired height and 90 degree to the first mowing pass when possible.
- Use proper equipment shutdown practice for your safety before dismounting tractor.

Watch equipment clearances

Three-point hitch and side mounted mowers have a larger turning arc than pull-type mowers. Allow sufficient clearance for safe turning.

NEVER STAND  
On Mower  
Keep Away

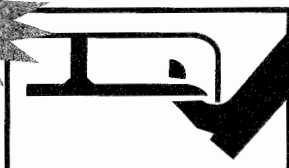

## Under Mount Mower Safety

When mowing with an under mount mower:

- Keep removable discharge chute in place and over discharge opening.
- Never stand on an operating mower housing.
- Distribute grass clipping with discharge chute facing mowed area.
- Use proper equipment shutdown practice before clearing clogged mower or discharge chute.

KEEP CHUTE  
In Place

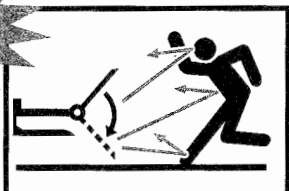

## ***Wing Or Boom Type Mower Overhead Obstruction Hazards and Risks***

Check for overhead obstructions with raised wings or boom-type mowers to avoid serious injury or death by contact with:

- Electrical power lines.
- Low tree limbs.
- Other overhead obstructions.

## ***Wing And Side Mount Mowers Safety***

**When mowing with wing and side-mount mowers:**

Raised wing positions reduces shielding protection and increases the thrown object and blade contact hazard risks.

**To avoid serious injury or death by thrown objects or blade contact from raising and lowering wings during mowing operations:**

- Do not mow with bystanders in mowing area.
- Be sure no one is near mower while raising or lowering wings.
- Keep the exposed rotating wing blade time to a practical minimum during a raised wing mowing operations.
- Stop mowing if persons enter into mowing area.
- Only raise wing to clear objects in the mowing path or to match ground slope.
- Disengage wing drive for extended periods of mowing with raised wings.
- Lower raised wing to ground after clearing object or ground slope conditions.
- Allow all mower blades to stop rotating before raising wing sections during other operations.

## ***Ditch Bank Mowing Safety***

Use extreme care when mowing ditch banks. Watch for washouts, eroded areas and mowing obstructions along the ditch banks. Hitting obstructions with side-mount or boom mowers may swerve the tractor's front end toward the ditch.

Raised wing and boom-type mower ditch bank operations may reduce the mower's thrown object shielding effectiveness for the mower operator's protection.

**To increase operator protection from thrown objects during ditch bank operations:**

- Use enclosed ROPS cabs, special protective enclosures and other operator shielding when performing these operations.
- Inspect mowing area and remove or mark all foreign objects and debris to be avoided by mower.



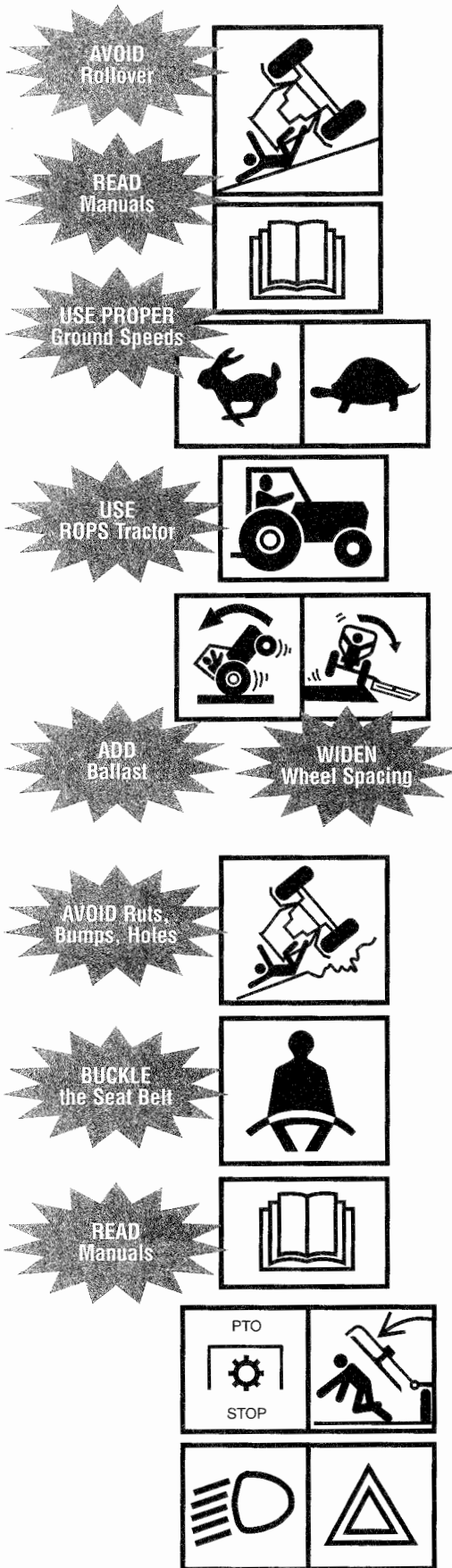

## Mowing Uneven Terrain Safely

The tractor and mower stability is reduced on slopes and uneven terrain.

You can prevent tractor and mower overturns and maintain equipment stability control by:

- Reviewing tractor and mower operator's manuals for operating safety practices on slopes and uneven terrain conditions. Explain the practices to those users and operators who cannot read.
- Avoiding extremely steep slope operations.
- Using extreme care to maintain control over your equipment when operating in these conditions.
- Increasing tractor stability by adding wheel weights and increasing wheel spacing (Refer to tractor operator's manual for recommendations)
- Using ROPS and seat-belt-equipped tractor for operator safety during mowing operations.
- Maintaining minimum ground speed.
- Making wide and gradual turns.
- Avoiding sudden starts, stops, and turns when operating up, down, or across slopes.
- Not raising rear-mount or side-mount mowers or mower wings from the ground during these operations .
- Keeping alert for holes, bumps, ruts, rocks, stumps or other obstructions that could overturn tractor and mower.
- Avoiding slippery ground conditions that could overturn tractor and mower.
- Avoiding tractor and mower "hang up" by diagonal passing through sharp dips and drops.

**Use extreme care in maintaining equipment stability during all uneven terrain and slope mowing operations. You are the final judge as to any slope that can be safely negotiated.**

## Equipment Road Transporting Safety

If equipment is to be driven on public roads:

- Refer to tractor and mower manufacturers' operator's manuals for instructions.
- Explain the instructions to those users or operators who cannot read.
- Check local regulations for required equipment markings, lights, flashers, etc., while traveling on public roads. Lights are required on mowers that obscure tractor taillights and/or warning lights.

**Before transporting on public roads:**

- Disengage PTO to mower.
- Raise mower into transport position.
- Lock wings up into transport position with locking devices on wing-type and side-mounted mowers.
- Attach safety chain between pull-type mower and tractor.
- Make sure lights, flashers, reflectors and SMV are in place and visible.
- Check SMV (Slow-Moving Vehicle) emblem for visibility to any rear approaching vehicle.

### While transporting on public roads:

- Obey all local traffic regulations.
- Approach intersections with caution.
- Observe speed and traffic control signs.
- Avoid panic stops and sharp turns.

### Parking Safety

#### Park equipment at:

- Designated or out-of-traffic areas.
- Preferably level ground locations.

#### Sloping ground parking locations:

- Position equipment across slope.
- Set parking brakes.
- Lower mower to ground.
- Block tractor wheels.

#### Before temporarily parking and leaving disabled equipment near traffic areas:

- Remove equipment from public roads.
- Set out warning flags
- Use tractor flashers.

## Safety – During Shutdown

### Use Proper Equipment Shutdown Practices For Your Safety

Refer to tractor and mower manufacturer's operator manual(s) for recommend shutdown procedures. Explain the procedures to those users or operators who cannot read.

#### Make proper equipment shutdown procedures an important habit to practice. Follow these safety practices before dismantling tractor:

- Disengage PTO clutch and transmission drive.
- Idle engine for gradual cooling.
- Place the controls in PARK or NEUTRAL.
- Set the parking brake.
- Lower mower to ground.
- Lower wings of wing-type mowers to ground.
- Shut off engine.
- Wait for all moving parts to stop before equipment inspections, adjustments or repairs.
- Relieve hydraulic pressure by moving hydraulic controls several times in all directions.
- Lock ignition and remove key when equipment is to be inspected, repaired, adjusted or unattended.
- Lock anti-vandalism covers and closures when equipment is unattended.
- Dismount carefully maintaining three-point contact.

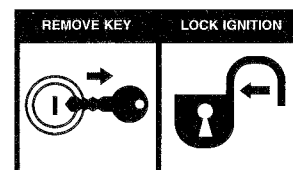
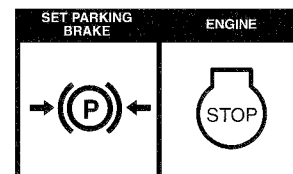
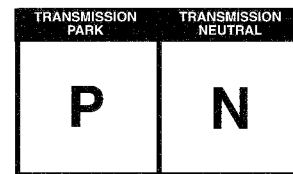
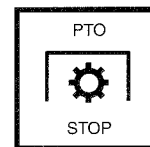
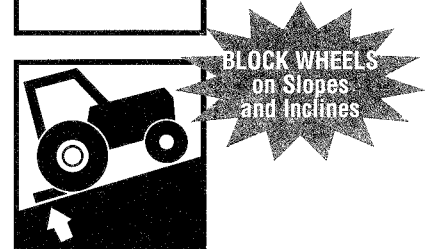
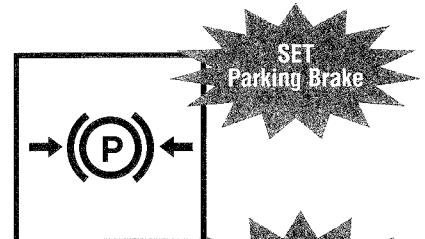
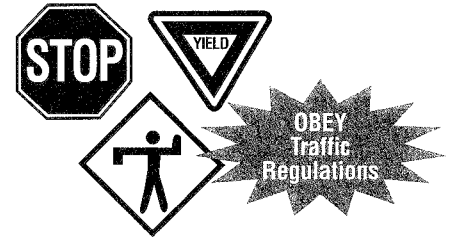

**WAIT For  
Moving Parts to  
Stop Before  
Dismount**



**USE Three  
Point Contact**



**MAINTAIN  
Equipment**

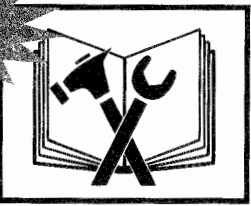

**FOLLOW**

**Maintenance  
Schedule**



## ***Dismounting Tractor Safely***

### **Before dismounting tractor:**

- Use proper equipment shutdown practice for your safety.
- Lower implement to the ground, stop engine and PTO, set brakes, allow all moving parts to stop, and remove key before dismounting from tractor.
- Never dismount from moving equipment.
- Never jump from machines.
- Dismount carefully.
- Check for slippery steps
- Keep feet and hands away from controls.
- Use handholds and steps during dismount.
- Face machine and use 3 point contact (2 hands, 1 foot or 2 feet, 1 hand).

## ***Safety – During Maintenance***

### ***Maintenance Safety***

**Do the following for your safety before performing any maintenance, repairs or service procedures:**

- Follow proper equipment shutdown practice.
- Wear all the protective clothing and personal safety devices necessary to safely perform the job.
- Refer to your manufacturer's manuals for proper maintenance, repair and service procedures. Explain the procedures to those users and operators who cannot read.

Stored energy sources (electrical, mechanical, hydraulic, pneumatic, chemical, thermal, etc..) must be either locked, blocked, relieved, disconnected, stopped, secured, neutralized, controlled or reduced to a practical minimum before any maintenance, repair or service procedures can be done safely.

**Some basic safety practices to prevent potential injuries from energy releasing sources:**

- Disengage PTO before shutting off engine.
- Place controls in PARK or NEUTRAL before shutting off engine.
- Set parking brake or block wheels.
- Allow all moving parts to stop.
- Lower mower to ground.
- Lower wings to ground on wing-type mowers.
- Shut off tractor engine.
- Lock ignition and remove key.
- Look and listen for evidence of moving parts before opening shields.
- Securely support or block-up mower before working underneath mower or other lifted components.
- Securely support, block-up, or lock-up mower wings with locking devices before working near or underneath a wing-type mower.
- Relieve hydraulic system pressure by moving controls several times in all directions.
- Relieve pressure before disconnecting or disassembling any pressurized system.
- Block or relieve spring pressure before disassembling any spring-loaded mechanism.
- Securely support or block up any elevated machine component before working on it.
- Avoid flames, sparks, or smoking near any fuels.

***Mower Manufacturer Parts and Your Safety***

Most mower manufacturers use special fasteners and specially designed parts to meet mowing operations requirements.

Critical safety-related parts (Self-locking blade bolts, blades, pins, shields or other special items) have specific strength, design and fit requirements for the make and model mower you are using.

**Modifications or repair parts not approved by the mower manufacturer can cause serious safety hazard exposure risk to you and others.**

**TO AVOID SERIOUS INJURY OR DEATH FROM UNAPPROVED PARTS OR MODIFICATIONS:**

- Do not substitute common hardware for self-locking blade bolts or other special part items.
- Do not substitute blades, pins, shields or other critical safety-related parts.
- Do not use grade 5 or 8 bolts to replace grade 2 shear bolts.

***FOLLOW THE SAFETY PRACTICE OF ALWAYS CHECKING THE MOWER FOR PROPER FUNCTION AFTER ALL ADJUSTMENTS REPAIRS OR SERVICE.***

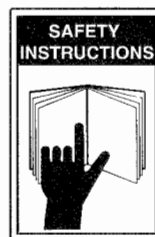
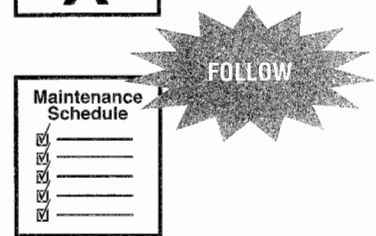
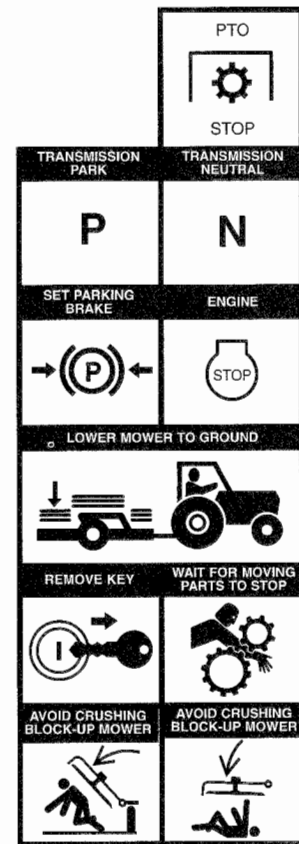



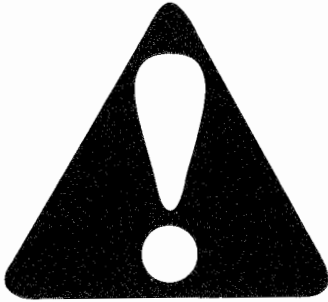

## ***One Final Word***



You have just finished reading the Mower Safety Manual. It is impossible for this manual to cover every potentially hazardous situation you may encounter. But, your knowledge of these safety precautions and your adherence to the basic rules of safety will help build good judgment in all situations. Our objective is to help you develop good safety habits and make you a better mower operator. The mower safety manual, safety precautions and basic rules of safety must be explained to those users or operators who cannot read.

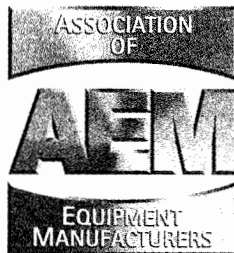

111 E. Wisconsin Avenue • Milwaukee, Wisconsin 53202 U.S.A.  
[www.aem.org](http://www.aem.org)

For information on additional copies of this and  
other safety manuals, call 800-369-2310



# Segadora industrial y agrícola

manual de seguridad

*para operadores y mecánicos*

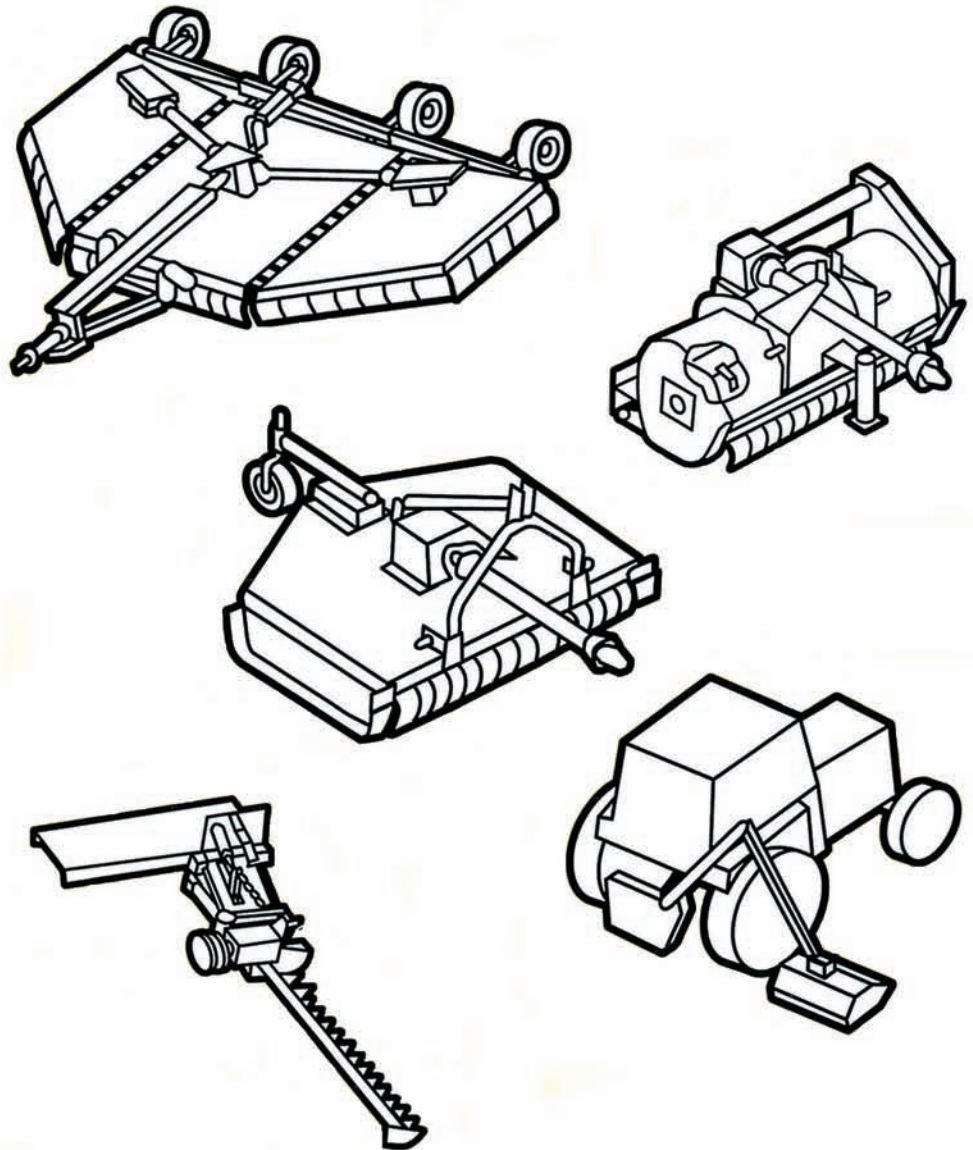

111 E. Wisconsin Avenue • Milwaukee, Wisconsin 53202 U.S.A.  
[www.aem.org](http://www.aem.org)

# Contenido

---

<b>Reconocimiento</b> .....	2
<b>Introducción</b> .....	3
<b>Palabras para el usuario</b> .....	3
<b>Alerta de seguridad</b> .....	4
<b>Segadoras industriales y agrícolas</b> .....	4
<b>Sea un operador responsable</b> .....	5
<b>Manejo seguro de riesgos y peligros</b> .....	6
<b>Cumpla con un programa de seguridad</b> .....	11
<b>Seguridad previa a la operación</b> .....	11
<b>Seguridad durante el arranque y prueba</b> .....	13
<b>Seguridad durante la operación</b> .....	14
<b>Seguridad durante la parada</b> .....	18
<b>Seguridad durante el mantenimiento</b> .....	19
<b>Palabra final</b> .....	21

## Reconocimiento

---

Deseamos extender nuestro reconocimiento a los miembros de del Association of Equipment Manufacturers por sus contribuciones para la preparación de este manual de seguridad.

### Derechos de autor

© 2000 Equipment Manufacturers Institute. Todos los derechos reservados. Revisado 08.2003

# Introducción

El propósito de este manual de seguridad es señalar algunas de las situaciones básicas de seguridad que pueden ocurrir durante la operación y mantenimiento de su máquina y sugerir los métodos posibles para tratar estas situaciones. Este manual NO es un sustituto de el (los) manual(es) del fabricante.

Pueden ser necesarias algunas precauciones adicionales, o algunas instrucciones no pueden aplicar, dependiendo del equipo, dispositivos de fijación, y las condiciones del lugar de trabajo o del área en que se realiza el servicio. El fabricante no tiene control directo sobre las aplicaciones, operación, inspección, lubricación o mantenimiento de la máquina. Por lo tanto, es **SU** responsabilidad practicar buenas medidas de seguridad en estas áreas.

La información proporcionada en este manual sirve como complemento de los detalles de información específicos de su máquina que están incluidos en el (los) manual(es) del fabricante. La información adicional que pueda afectar la operación segura de su máquina puede estar incluida en las etiquetas de seguridad o en los requisitos del seguro, programas de seguridad del empleador, códigos de seguridad, leyes locales del estado/provincia y leyes nacionales, reglas y reglamentos.

**IMPORTANTE:** si usted no tiene el (los) manual(es) del fabricante de su máquina específica, obtenga un manual de reemplazo con su empleador, distribuidor de equipo o el fabricante de su máquina. Mantenga este manual de seguridad y el (los) manual(es) del fabricante con su máquina.

## Palabras para el usuario

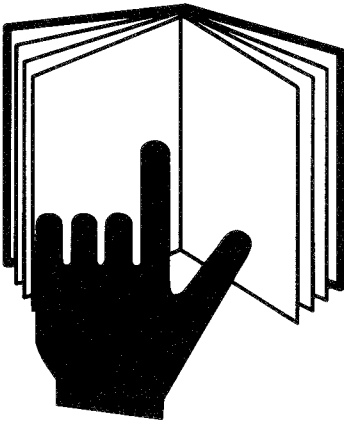

Usted tiene la responsabilidad de leer y comprender este manual de seguridad y el (los) manual(es) del fabricante, antes de operar esta máquina. Este manual de seguridad lo guía paso a paso a lo largo de su día de trabajo. El manual de seguridad, el (los) manual(es) del fabricante, avisos de seguridad (calcomanías) y precauciones de seguridad, deben explicarse a los usuarios u operadores que no puedan leer el material.

Adicionalmente al diseño y configuración del equipo el **CONTROL DEL PELIGRO** y la **PREVENCIÓN DE ACCIDENTES** dependen de la conciencia, preocupación, prudencia y capacitación adecuada de los propietarios y operadores durante la operación, transporte, mantenimiento y almacenamiento del equipo.

Recuerde que **USTED** es la clave para mantener la seguridad. Las buenas prácticas de seguridad no lo protegen solamente a usted sino que también a las personas que lo rodean. Estudie este manual y el (los) manual(es) del fabricante para su máquina específica. Hágalos una parte integral de su programa de seguridad. Recuerde que este manual de seguridad está escrito únicamente para segadoras industriales y agrícolas.

**Practique todas las precauciones de seguridad usuales y acostumbradas en el trabajo y más que todo – recuerde que la seguridad depende de USTED. Solamente USTED puede evitar las lesiones graves o la muerte debidas a prácticas inseguras.**

# Advertencia de seguridad

## Símbolo

Este símbolo de alerta de seguridad significa:

**“¡ATENCIÓN! ¡MANTÉNGASE ALERTA! ¡SU SEGURIDAD ESTÁ INVOLUCRADA!”**



El símbolo de alerta de seguridad identifica los mensajes de seguridad importantes en el equipo, en los avisos de seguridad, en los manuales y en otros lugares. Cuando usted vea este símbolo, esté alerta a la posibilidad de muerte o lesiones. Siga las instrucciones en el aviso de seguridad.

## Palabras de señales

Las palabras de señales son palabras específicas que regularmente se encontrarán en las calcomanías de seguridad en este equipo o en otros equipos en el lugar de trabajo. Estas palabras tienen el objetivo de alertar a la persona que las vea de la presencia y el grado relativo de un riesgo.



Esta palabra de señal indica una situación de riesgo inminente que si no es evitado podrá resultar en la muerte o lesiones graves.



Esta palabra de señal indica una situación potencialmente riesgosa que si no se evita podría resultar en la muerte o lesiones graves.



Esta palabra de señal indica una situación potencialmente riesgosa que si no se evita podría resultar en lesiones menores o moderadas.

- LOS ACCIDENTES PUEDEN LISIAR Y CAUSAR LA MUERTE.
- LOS ACCIDENTES SON COSTOSOS.
- LOS ACCIDENTES PUEDEN EVITARSE.

# Segadoras industriales y agrícolas

Es una segadora para cortar pasto, triturar residuos de cultivos, cortar maleza para la limpieza de terrenos, vías navegables, derechos de paso, cortes en los bordes de los caminos o carreteras.

## TIPOS DE SEGADORAS INDUSTRIALES Y AGRÍCOLAS:

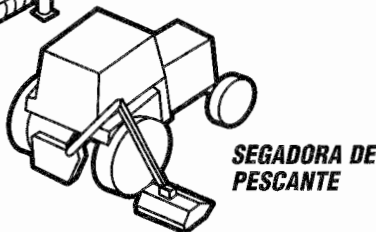
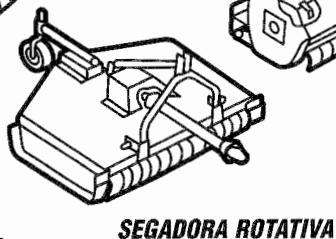
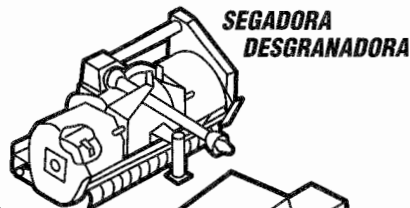

# Sea un operador responsable



Para la operación segura de su equipo usted debe ser un operador responsable. Un operador responsable debe comprender claramente las instrucciones escritas proporcionadas por el fabricante ser capacitado – incluyendo la operación real del equipo y el conocimiento de las reglas y reglamentos de seguridad del lugar de trabajo.

Las medicinas y el alcohol pueden y afectarán el estado de alerta y coordinación del operador, por lo tanto, afectarán la habilidad del operador para operar el equipo en forma segura. Un operador **NUNCA** debe usar medicinas que puedan afectar su estado de alerta, juicio y coordinación; ni beber alcohol mientras opera equipo motorizado incluyendo tractores y segadoras. Un operador que use medicamentos por prescripción médica o de venta libre debe consultar con un médico profesional para conocer sobre cualquier efecto secundario que podría limitar su habilidad para operar este equipo en forma segura. **NUNCA** permita que alguien opere este equipo cuando estén afectados su estado de juicio alerta o de coordinación.

## Protéjase usted mismo

Use toda la ropa protectora y los dispositivos de seguridad personal que se le proporcionen o que sean los indicados para las condiciones de trabajo.

### Usted puede necesitar:

- Casco protector
- Zapatos de seguridad
- Anteojos de seguridad con protección lateral, gafas protectoras o protector facial
- Guantes extrafuertes
- Protección auditiva
- Ropa reflectora
- Equipo para clima húmedo
- Respirador o máscara filtrante

Use ropa apropiada para las condiciones del trabajo.

Siempre conozca cómo obtener ayuda en caso de una emergencia. Conozca donde encontrar y cómo usar los equipos de primeros auxilios y el extintor de incendios/sistema de supresión de incendios.



**Manténgase alerta. Evite los accidentes.  
No conozca la seguridad en la forma más difícil.**

# Manejo seguro de riesgos y peligros

Adicionalmente al diseño y configuración del equipo, el **CONTROL DEL PELIGRO** y la **PREVENCIÓN DE ACCIDENTES** dependen de la conciencia, preocupación, prudencia y capacitación adecuada de los propietarios y operadores durante la operación, transporte, mantenimiento y almacenamiento del equipo.

**EL MANEJO SEGURO DE RIESGOS Y PELIGROS ES UN ELEMENTO ESENCIAL PARA LOS PROPIETARIOS Y OPERADORES RESPONSABLES DE TRACTORES Y SEGADORAS.**

**REVISE EL MANEJO SEGURO DE LOS PELIGROS Y RIESGOS ENUMERADOS A CONTINUACIÓN.**

## ***Peligro de objetos despididos***

EXISTE LA POSIBILIDAD DEL RIESGO DE LESIONES A LOS OPERADORES Y TRANSEÚNTES CAUSADAS POR OBJETOS DESPEDIDOS DURANTE LA OPERACIÓN DE LA SEGADORA POR LOS SIGUIENTES:

OBJETOS (PIEDRAS, ESCOMBROS, HOJAS ROTAS DE LA SEGADORA, PERNOS DE LA HOJA, CABLES, CADENAS, ALAMBRE, ETC.) DESPEDIDOS POR LA SEGADORA.

## ***Dispositivos protectores del equipo y prácticas de seguridad recomendadas***

La cubierta de la segadora y los dispositivos protectores no pueden evitar que escapen todos los objetos o desechos del área cerrada de la hoja en todas las condiciones de segado. Es posible que los objetos escapen y se desplacen cientos de pies (300 [100 m]).

### **PRÁCTICAS DE SEGURIDAD RECOMENDADAS**

Lea los manuales del operador del fabricante para conocer las prácticas de seguridad recomendadas durante la operación. Explique las prácticas a los usuarios u operadores que no puedan leer.

**PARA AYUDAR A EVITAR LESIONES GRAVES O LA MUERTE CAUSADAS POR OBJETOS QUE GOLPEEN AL OPERADOR U OTRAS PERSONAS HAGA LO SIGUIENTE:**

#### **SEGURIDAD DE TRANSEÚNTES**

- Mantenga a los transeúntes a varios cientos de pies (300 [100 m]) del área segada.

#### **SEGURIDAD PROPORCIONADA POR LOS DISPOSITIVOS PROTECTORES DEL EQUIPO**

Para contener, desviar o reducir los objetos despididos del área cerrada de la hoja:

- Mantenga la cadena, blindajes deflectores flexibles o sólidos colocados en la parte delantera y trasera de la cubierta de la segadora, en su lugar y en buen estado de funcionamiento.
- No opere el equipo con los blindajes para objetos despididos dañados o sin que estén colocados en su lugar.

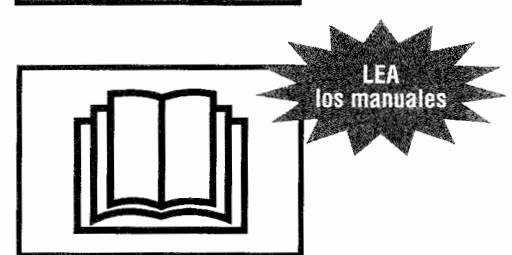



## SEGURIDAD DEL OPERADOR

La operación de las segadoras con las alas levantadas, de montaje lateral y pescante, pueden reducir la efectividad del blindaje para proteger al operador contra los objetos despedidos de la segadora.

**Haga lo indicado a continuación para aumentar la protección del operador contra los objetos despedidos durante las operaciones de segado:**

- Use cabinas cerradas con una estructura de protección contra vuelcos (ROPS), cubiertas protectoras especiales, mallas u otros dispositivos para proteger al operador cuando efectúa estas operaciones.

### **SOBREPASAR LAS VELOCIDADES RECOMENDADAS PARA LA TOMA DE FUERZA (PTO)**

No sobrepase las velocidades recomendadas por el fabricante para la toma de fuerza (PTO).

**Las velocidades excesivas de la toma de fuerza (PTO) pueden causar:**

- Fallo de la hoja
- Escape de objetos a velocidad alta u hojas rotas despedidas del área cerrada de la hoja de la segadora.
- Fallos potenciales de la línea de transmisión de 540 rpm cuando se opera a velocidades de 750 a 1000 rpm.

### **OTRAS PRÁCTICAS DE SEGURIDAD:**

- Nunca debe operar la segadora con hojas rotas, dobladas, faltantes o que estén extremadamente desgastadas.
- Antes de segar retire los desechos y objetos extraños para evitar que sean recogidos y despedidos por la segadora.
- No debe operar la segadora durante el transporte o en posición de ala levantada.

### **PRÁCTICAS DE MANTENIMIENTO RECOMENDADAS**

Lea los manuales del operador del fabricante para conocer sobre la inspección y mantenimiento de las defensas de la cadena y blindaje deflector flexible o sólido:

- Reemplace las defensas desgastadas o dañadas y los demás blindajes antes de segar.
- Use solamente las defensas y blindajes de reemplazo del fabricante. Otras defensas o blindajes pueden no encajar, o los materiales pueden no ser adecuados para cumplir con los requisitos de resistencia del equipo.
- Reemplace las calcomanías desgastadas o dañadas y las instrucciones de advertencia.
- Explique las instrucciones de inspección y mantenimiento a los usuarios u operadores que no puedan leer.

USE cabinas cerradas con una estructura protectora contra vuelcos (ROPS) o cubiertas protectoras

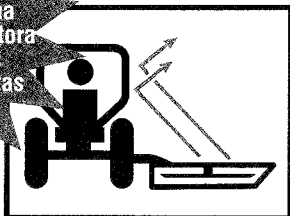

USE la velocidad apropiada de la toma de fuerza (PTO)

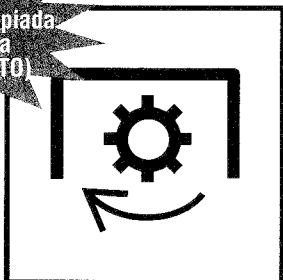

DÉ MANTENIMIENTO a su equipo

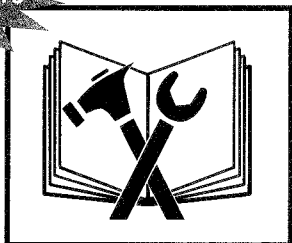

## ***Peligros y riesgos de las hojas rotativas y línea de transmisión***

EXISTE EL RIESGO DE POSIBLES LESIONES A LOS OPERADORES DE LA SEGADORA Y TRANSEÚNTES DURANTE LAS OPERACIONES DE SEGADO CAUSADAS POR LO SIGUIENTE:

- CONTACTO DEL CUERPO CON LAS HOJAS ROTATIVAS.
- ENREDO DEL CUERPO CON LAS LÍNEAS DE TRANSMISIÓN Y PIEZAS ROTATIVAS.

### ***Dispositivos protectores del equipo y prácticas de seguridad recomendadas***

#### **PRÁCTICAS DE SEGURIDAD RECOMENDADAS**

Lea los manuales del operador del fabricante para conocer las prácticas de seguridad recomendadas. Explique las prácticas a los usuarios u operadores que no puedan leer. Para evitar el riesgo de lesiones graves o la muerte causadas por el contacto con la hoja en movimiento, línea de transmisión o enredo de los operadores u otras personas haga lo siguiente:

#### **SEGURIDAD DE TRANSEÚNTES**

- No debe operar cerca de transeúntes.
- Mantenga a otras personas a varios cientos de pies (300 [100 m]) del área de segado.

#### **PRÁCTICAS DE SEGURIDAD DEL OPERADOR**

- No permita pasajeros en el tractor o segadora. Asegúrese el cinturón de seguridad durante el segado.
- Use la práctica de parada del equipo apropiada antes de dar servicio, ajustar, limpiar o eliminar las obstrucciones de la segadora.
- Manténgase alejado de las hojas rotativas, piezas y líneas de transmisión.
- Nunca arranque el motor del tractor mientras esté de pie al lado del equipo.
- Solamente arranque el motor del tractor cuando esté sentado en el asiento del operador con el cinturón de seguridad abrochado.

#### **PRÁCTICAS DE SEGURIDAD RECOMENDADAS PARA DEFENSAS Y BLINDAJES DE LA LÍNEA DE TRANSMISIÓN**

- Mantenga las líneas de transmisión y otros blindajes colocados y en buen estado.
- No debe operar la segadora cuando las defensas, defensas de la línea de transmisión u otros blindajes hagan falta o estén dañados.

#### **PRÁCTICAS DE SEGURIDAD RECOMENDADAS**

Lea los manuales del operador del fabricante para conocer las instrucciones sobre defensas, defensas de la línea de transmisión y otros blindajes:

- Reemplace las defensas, defensas de la línea de transmisión y otros blindajes desgastados o dañados antes de segar.
- Use solamente defensas y blindajes de reemplazo hechas por el fabricante. Otras defensas o blindajes pueden no encajar o ser de materiales inadecuados que no cumplan con los requisitos de resistencia del equipo.
- Reemplace las calcomanías e instrucciones de advertencia desgastadas o dañadas.
- Explique las instrucciones de inspección y mantenimiento a los usuarios u operadores que no puedan leer.



EVITE enredarse

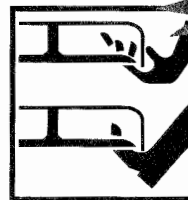

EVITE las piezas rotativas



LEA los manuales



ASEGÚRESE el cinturón de seguridad



NO LLEVE PASAJEROS



EVITE el ser atropellado



DÉ MANTENIMIENTO a su equipo

**EVITE vuelcos**

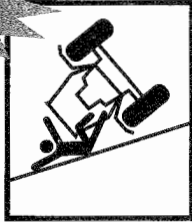

**USE la estructura contra vuelcos (ROPS) del tractor**



**LEA los manuales**



**AGREGUE balasto**



**AUMENTE el espacio entre las ruedas y AGREGUE balasto en el lado contrario**



**ASEGURESE el cinturón de seguridad**



**EVITE EL APLASTAMIENTO asegure el ala**



## ***Peligros y riesgos de rodamiento o vuelco del tractor y segadora***

EXISTE UN RIESGO DE LESIONES POSIBLES AL OPERADOR POR RODAMIENTO O VUELCO DE LA SEGADORA DURANTE LAS OPERACIONES DE SEGADO POR LO SIGUIENTE:

- TERRENO ACCIDENTADO, PENDIENTES INCLINADAS, AGUJEROS, BACHES, SURCOS, PIEDRAS, TRONCOS U OTRAS OBSTRUCCIONES QUE PODRÍAN VOLCAR EL TRACTOR Y SEGADORA.
- VELOCIDADES ABSOLUTAS EXCESIVAS PARA ESTAS CONDICIONES DE TERRENO.

### ***Dispositivos protectores del equipo y prácticas de seguridad recomendadas***

Cuando sea posible, retire los troncos, piedras, etc., o márkuelos claramente con las demás obstrucciones para evitar vuelcos, averías y condiciones de conducción peligrosas. Tenga extremo cuidado para mantener el control sobre el equipo cuando opere en terrenos con estas condiciones.

#### **ESTRUCTURAS CONTRA VUELCO (ROPS) RECOMENDADAS PARA TRACTORES**

Un tractor equipado con una estructura contra vuelcos (ROPS) o cabina ROPS cerrada y cinturón de seguridad para la seguridad del operador, es esencial para la protección adicional del operador, cuando opera en terrenos con estas condiciones

#### **AJUSTES RECOMENDADOS PARA LA ESTABILIDAD DEL TRACTOR**

Lea el manual del operador del tractor para conocer los ajustes para aumentar la estabilidad del tractor:

- Agregue pesas o balasto a las ruedas delanteras y traseras.
- Ajuste el espacio entre las ruedas al ancho máximo.
- Agregue contra balasto en el lado contrario a las segadoras de montaje lateral y de pescante.
- Explique los ajustes a los usuarios u operadores que no puedan leer.

### ***PRÁCTICAS DE SEGURIDAD RECOMENDADAS***

Lea los manuales del operador del fabricante para conocer las prácticas de seguridad de operación recomendadas. Explique las prácticas a los usuarios u operadores que no puedan leer. **Para evitar lesiones graves o la muerte del operador por el vuelco del tractor y segadora, haga lo siguiente:**

- Abroche firmemente el cinturón de seguridad cuando seque con tractores equipados con una estructura contra vuelcos (ROPS).
- Evite la velocidad absoluta excesiva de acuerdo con las condiciones del terreno.
- Evite los arranques, paradas y virajes repentinos cuando opere subiendo, bajando o atravesando pendientes.
- Evite las condiciones de terreno resbaloso.
- Haga virajes anchos y graduales.
- Planifique segar cuesta abajo en pendientes inclinadas para evitar los vuelcos.

## ***Peligros y riesgos de aplastamiento por una segadora o piezas desprendidas***

EXISTE EL RIESGO DE UNA LESIÓN POR APLASTAMIENTO PARA LOS OPERADORES Y OTRAS PERSONAS DURANTE LAS OPERACIONES DE SEGADO DEBIDO A LO SIGUIENTE:

- SEGADORA O EQUIPO DESPRENDIDO DEBIDO A FALLO DEL SISTEMA HIDRÁULICO.
- FALLO EN DAR SOPORTE, BLOQUEAR O ASEGURAR COMPLETAMENTE LA SEGADORA O PIEZAS DEL EQUIPO.

## Dispositivos protectores del equipo y prácticas de seguridad recomendadas

Lea los manuales del operador del fabricante para conocer las prácticas de seguridad de operación recomendadas. Explique las prácticas a los usuarios u operadores que no puedan leer. **Para ayudar a evitar lesiones serias o la muerte de los operadores y otras personas causadas por la caída de la segadora o piezas de equipo, haga lo siguiente:**

### **PRÁCTICAS DE SEGURIDAD RECOMENDADAS**

Antes de trabajar cerca o debajo de la segadora o piezas de equipo en posición levantada:

- Use la práctica de parada del equipo apropiada antes de dar servicio, ajustar, limpiar o eliminar las obstrucciones de la segadora.
- Soporte o coloque bloques firmemente debajo de la segadora o piezas de equipo.
- En las segadoras de tipo ala coloque bloques o asegure firmemente las alas con los seguros o baje al suelo la segadora o piezas del equipo.
- Use los seguros de transporte cuando transporte la segadora en caminos públicos.

### **Peligros y riesgos por la fuga de fluido hidráulico a presión alta**

EXISTE UN RIESGO PARA LOS OPERADORES DE SEGADORAS Y OTRAS PERSONAS DE UNA POSIBLE INYECCIÓN DE FLUIDO A PRESIÓN ALTA O GANGRENA CAUSADA POR LA INYECCIÓN EN LA PIEL DE ACEITE HIDRÁULICO O DIESEL.

PARA EVITAR LA GANGRENA, EL FLUIDO INYECTADO DEBE SER ELIMINADO QUIRÚRGICAMENTE EN POCAS HORAS, POR UN MÉDICO FAMILIARIZADO CON ESTE TIPO DE LESIÓN.

### **PRÁCTICAS DE SEGURIDAD RECOMENDADAS**

Lea los manuales del operador del fabricante para conocer las prácticas de seguridad recomendadas. Explique las prácticas a los usuarios u operadores que no puedan leer. Las fugas de fluido a presión alta por agujeros minúsculos pueden ser casi invisibles.

**Para ayudar a evitar lesiones serias o la muerte haga lo siguiente:**

- Busque las fugas con pedazos de cartón o madera.
- No use las manos para verificar la presencia de fugas.
- Descargue la presión del sistema antes de desconectar los conductos.
- Antes de aplicar presión al sistema:
  - Revise que los conductos, tuberías y mangueras no estén dañados.
  - Revise que las conexiones estén apretadas.
- Antes de operar los sistemas presurizados:
  - Descargue el aire del sistema.
  - Haga referencia al (los) manual(es) del operador del fabricante para obtener instrucciones.
  - Explique los procedimientos a los usuarios u operadores que no puedan leer.

### **Peligros y riesgos durante el llenado de combustible del tractor**

Para evitar las lesiones serias o la muerte por incendio durante el llenado:

- Apague el motor y la ignición.
- Nunca llene el tanque de combustible cerca de llamas descubiertas.
- Nunca fume mientras llena combustible.
- Evite las chispas causadas por la electricidad estática poniendo a tierra la boquilla del combustible contra el cuello de llenado del tanque.
- Evite sobrellenar el tanque o derramar el combustible.
- Limpie inmediatamente el combustible derramado.
- Siempre vuelva a colocar la tapa del combustible.

**Para evitar lesiones serias o la muerte causadas por las emanaciones del escape del motor:**

- Ventile adecuadamente los espacios cerrados antes de arrancar el motor.



LEA los manuales

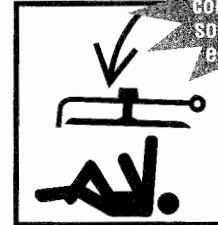

EVITE EL APLASTAMIENTO coloque bloques o soportes seguros en la segadora

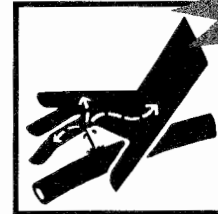

FLUIDO A PRESIÓN ALTA puede inyectarse en el cuerpo

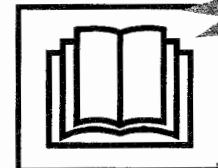

LEA los manuales

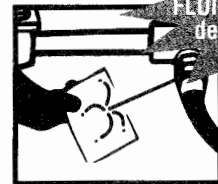

EVITE LA INYECCIÓN DE FLUIDO use un pedazo de cartón, no use las manos

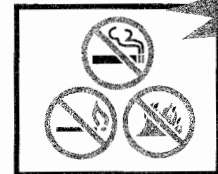

EVITE los incendios y las explosiones

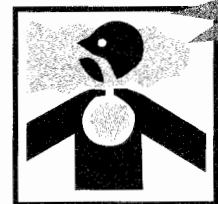

EVITE las emanaciones del escape

## Cumpla con un programa de seguridad



LA SEGURIDAD ES IMPORTANTE PARA LOS PROPIETARIOS Y OPERADORES RESPONSABLES DE TRACTORES Y SEGADORAS. HAGA LO SIGUIENTE PARA SU SEGURIDAD DURANTE LA OPERACIÓN DE SEGADO:

### SEA UN OPERADOR CAPACITADO HACIENDO LO SIGUIENTE:

- Leyendo, comprendiendo y obedeciendo las instrucciones escritas del fabricante en el (los) manual(es) del operador y avisos de seguridad en la segadora y tractor.
- Recibiendo capacitación operativa para la segadora y tractor.
- Solicitando a su distribuidor de equipo o supervisor que le explique lo que usted no comprende.
- Explicando las instrucciones escritas en el (los) manual(es) del operador y avisos de seguridad (calcomanías) en la segadora y tractor a los usuarios u operadores que no puedan leer.

## Seguridad previa a la operación

### Conozca las reglas y reglamentaciones de seguridad del lugar de trabajo

Pregunte a su supervisor sobre las reglas de seguridad de operación del equipo que usted deberá obedecer.

#### Algunas reglas para su seguridad y la de los demás:

- Un tractor equipado con una estructura contra vuelcos (ROPS) es necesario para la protección del operador durante las operaciones de segado.
- Conozca la capacidad y características de operación de la segadora y tractor.
- Nunca altere o desmonte el equipo de seguridad.
- Nunca permita que niños o personas no capacitadas operen una segadora o tractor.
- Nunca permita pasajeros en la segadora o tractor.
- Mantenga a otras personas alejadas de la operación de segado.
- Use la práctica apropiada para parar el equipo antes de bajarse del tractor.
- Permita que se detengan todas las piezas móviles antes de efectuar inspecciones, reparaciones o ajustes al equipo.
- Soporte o coloque bloques firmemente debajo de la segadora antes de trabajar debajo de la segadora o componentes elevados.
- Use la ropa protectora y dispositivos de seguridad personal que le han sido asignados o recomendados por el fabricante del equipo.



### Conozca los controles del tractor y segadora

#### Conozca lo siguiente sobre su tractor y segadora:

- Función, propósito y uso de los controles.
- Velocidades seguras de operación.
- Capacidad para operar en forma segura en pendientes y terreno accidentado.
- Características de frenado y dirección.
- Espacios libres necesarios para la operación del tractor y segadora.
- Cómo detener rápidamente el equipo cuando haya una emergencia.



## Use todos los dispositivos de seguridad del equipo disponibles

Para ayudar a mantener su seguridad y la de las personas que lo rodean:

- Asegúrese de que las defensas, blindajes y avisos de seguridad recomendados por el fabricante están instalados en el equipo y en buen estado.
- Mantenga todos los dispositivos protectores en su lugar y abrochados firmemente.
- **NUNCA** debe operar su equipo con los dispositivos de seguridad sin colocar, desconectados o dañados.
- Use el balasto y peso requerido para la estabilidad operativa del equipo.

## Inspeccione el equipo de la segadora y tractor

Antes de comenzar su día de trabajo:

- Revise que no haya piezas del tractor y segadora que estén sueltas, rotas, dañadas o que no estén colocadas en su lugar.
- Repare o reemplace estas piezas cuando sea necesario.
- Verifique que los implementos del tractor y segadora sean los apropiados.
- Verifique que sean iguales las rpm de régimen de la toma de fuerza (PTO) a las del tractor y de la segadora.
- Revise el estado de las hojas de la segadora. Afile o reemplace de acuerdo con las recomendaciones del fabricante. Las modificaciones a las hojas como soldadura o endurecimiento de los bordes cortantes con soldadura o enderezado de las hojas dobladas, pueden reducir la resistencia de las hojas y afectar adversamente las propiedades y seguridad de las hojas.
- Verifique que todas las defensas y blindajes estén colocados en su lugar y que todo el equipo esté en buen estado de funcionamiento. Esto incluye la línea de transmisión de la toma de fuerza (PTO), caja de engranajes, defensas y blindajes del implemento que sirven para la protección del operador.
- Verifique que la horqueta de la línea de transmisión y los dispositivos de seguro estén correctamente asegurados.
- Verifique que los sistemas hidráulicos del tractor y segadora no estén dañados ni tengan fugas.
- Revise y lea los avisos de seguridad y las instrucciones de advertencia.
- Explique los avisos de seguridad e instrucciones de advertencia a los usuarios u operadores que no puedan leer.

## Inspeccione el área de trabajo

Inspeccione, identifique y evite las condiciones peligrosas en el área de trabajo:

- Terreno accidentado, bajadas escarpadas, zanjas, agujeros, pendientes inclinadas, troncos, agua estancada, suelo de lodo suave, condiciones resbalosas, desechos y objetos extraños.
- Inspeccione el área de segado y elimine o marque todos los objetos extraños y desechos que debe evitar con la segadora.

Analice el área de segado para establecer:

- El mejor y más seguro procedimiento de segado.
- Tipo de material y altura de segado.
- Estado del terreno de operación.
- El uso de un patrón de segado de desplazamiento hacia delante siempre que sea posible.

## Verifique la seguridad de las demás personas

Antes de arrancar el equipo:

- Camine alrededor del equipo.
- Verifique que no haya nadie debajo, sobre o cerca del equipo.
- Aleje a todas las personas de estas áreas.
- Haga sonar una alarma.



USE UNA ESTRUCTURA CONTRA VUELCOS (ROPS) y el cinturón de seguridad

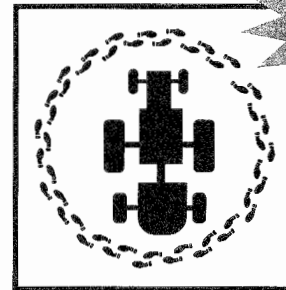

CAMINE ALREDEDOR para inspeccionar

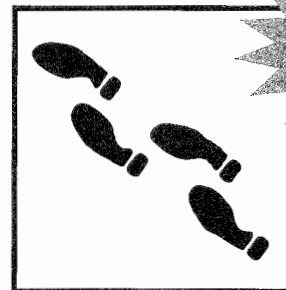

CAMINE ALREDEDOR del lugar de trabajo

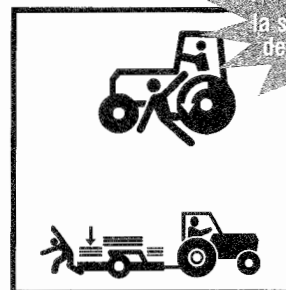

VERIFIQUE la seguridad de las demás personas

# Seguridad durante el arranque y prueba

USE  
el contacto de  
tres puntos

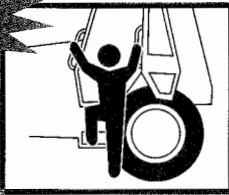

USE UNA  
ESTRUCTURA  
CONTRA VUELCOS  
(ROPS) y el  
cinturón de  
seguridad



USE la  
velocidad  
correcta de la  
toma de fuerza  
(PTO)



## Seguridad durante la subida al tractor

### Antes de subir:

- Límpiase los zapatos y las manos.

### Durante la subida y la bajada del tractor:

- Use las asas y placas de los escalones.
- Nunca utilice los volantes de dirección o controles como asas.
- Nunca suba ni baje de un tractor en movimiento.

## Prueba de seguridad de los controles del tractor y segadora

### Antes del arranque:

- Ajuste y abroche el cinturón de seguridad en su tractor equipado con una estructura contra vuelcos (ROPS).
- Verifique que el freno de estacionamiento esté enganchado.
- Verifique que desenganche la toma de fuerza (PTO).
- Verifique que todos los controles estén en la posición de punto muerto (N) o de estacionamiento (P).
- Advierta a las demás personas presentes en el área antes de arrancar el tractor.
- Cumpla con los procedimientos de arranque recomendados por el fabricante del tractor.

### Después del arranque:

- Revise que todos los instrumentos, indicadores y luces indicadoras funcionen normalmente.
- Revise que todos los controles, dirección y frenos del tractor funcionen apropiadamente.
- Repare un tractor que no esté funcionando apropiadamente antes de usarlo.
- Suba y baje la segadora cuando la línea de transmisión llegue al fondo o cuando existen problemas de enganche.
- Verifique que su equipo no vibre excesivamente y que no tenga ruidos anormales.
- Use prácticas apropiadas para detener el equipo antes de inspeccionarlo.

## Seguridad en el sistema de toma de fuerza y segadora

Tractores con sistemas de doble velocidad (540 ó 1000 rpm) toma de fuerza (PTO) de cambios.

### Para evitar las lesiones serias o la muerte por el fallo de piezas causado por la sobrevelocidad de la segadora:

- Asegúrese de colocar el selector de la toma de fuerza (PTO) a la velocidad de régimen de las rpm de la toma de fuerza (PTO).

### Tractores con sistemas con toma de fuerza (PTO) impulsados por la transmisión.

Una segadora rotativa tendrá un efecto significativo de volante, que puede continuar impulsando el tractor cuando tiene un sistema de toma de fuerza (PTO) impulsado por la transmisión.

### El tractor debe estar equipado y ser operado como se indica a continuación:

- Instale un embrague de sobremarcha.
- Permítase suficiente espacio y tiempo para maniobrar anticipando los virajes, paradas y reducciones de velocidad.

# Seguridad durante la operación

## Seguridad durante el enganche de la segadora al tractor

### Seguridad en el montaje de la segadora con un enganche de tres puntos:

- Haga referencia a los manuales de los fabricantes de la segadoras y el tractor.
- Coloque la palanca selectora del elevador de potencia hidráulica del tractor (eje de balancín) en posición baja para evitar el movimiento inesperado.
- Explique los procedimientos de enganche a los usuarios u operadores que no puedan leer.

### Seguridad en el montaje de la segadora con enganche de tipo tiro:

- Haga referencia a los manuales del fabricante de la segadora y tractor.
- Utilice solamente un enganche de barra de tiro.
- No la enganche al eje trasero del tractor ni a los brazos del enganche de tres puntos.
- Ajuste la longitud de la barra de tiro del tractor para la operación de la toma de fuerza (PTO) de 540 ó 1000 rpm.

## Comience el uso de la segadora en forma correcta para mayor seguridad

Segue solamente durante el día o cuando exista iluminación artificial adecuada.

### Para evitar las lesiones serias o la muerte causadas por objetos despedidos por la segadora o contacto con las hojas:

- Mantenga los blindajes de la cadena, blindajes deflectores flexibles o sólidos, conductos de descarga, colocados en su lugar y en buen estado.
- Mantenga a todas las personas a varios cientos de pies (300 [100 m]) de la operación de segado.
- Nunca dirija hacia ninguna persona la descarga de la segadora.
- Mantenga las manos, pies y otras partes del cuerpo alejadas de las piezas rotativas, hojas y agujeros de descarga.
- No debe operar la segadora en posición de transporte.

### Enganche de la transmisión, toma de fuerza (PTO) de la segadora:

- Suba la segadora a la altura máxima de corte.
- Enganche la toma de fuerza (PTO) con rpm bajas del motor.
- Aumente las rpm del motor a la velocidad de régimen de las rpm de la toma de fuerza (PTO).
- Baje la segadora a la altura de corte deseado.
- Deténgase y pare inmediatamente si la segadora golpea una obstrucción.
- Inspeccione y repare cualquier daño que tenga la segadora antes de reiniciar el segado.
- No debe operar la segadora cuando tenga vibración excesiva o ruidos anormales.

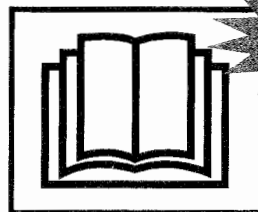

LEA los manuales

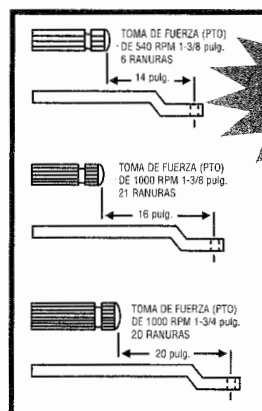

Ajuste de la barra de tiro del TRACTOR

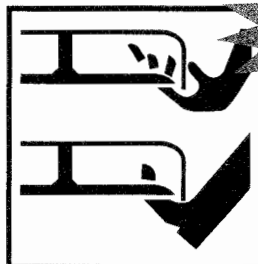

Mantenga la distancia de LAS HOJAS ROTATIVAS

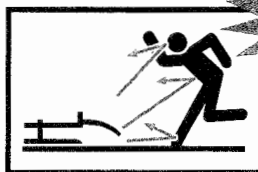

MANTENGA alejados a los transeúntes



**CUIDE**  
que no haya  
más personas

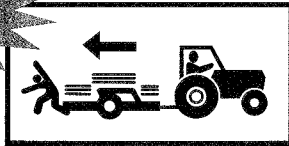

**MANTENGA**  
el rodillo  
trásero de la  
desgranadora

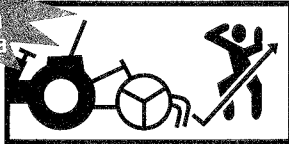

**USE** las  
velocidades  
absolutas  
apropiadas

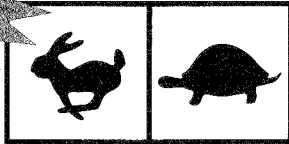

**DETENGA**  
LA HOJA  
antes de eliminar  
obstrucciones



**ESTABLEZCA**  
QUE el espacio  
libre sea adecuado  
para la oscilación  
de la segadora

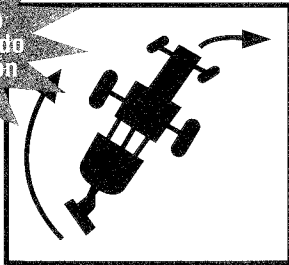

**NUNCA**  
PERMANEZCA  
DE PIE sobre  
la defensa de  
la segadora

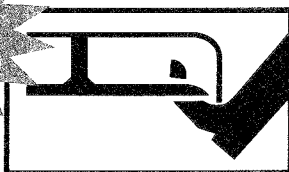

**MANTENGA**  
EL CONDUCTO  
colocado en  
su lugar

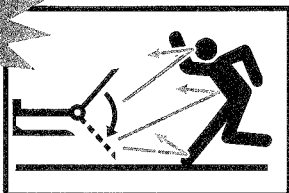

## **Seguridad durante el segado en marcha atrás**

Evite segar en marcha atrás siempre que sea posible.

Haga lo siguiente cuando segue en marcha atrás:

- Verifique que no haya personas atrás de la segadora antes de dar marcha atrás.
- Use extremo cuidado al invertir la dirección del segado.
- Mantenga los blindajes de seguridad delanteros y traseros y los blindajes delanteros de la desgranadora y los rodillos traseros de la segadora rotativa.

## **Velocidad absoluta de segado**

La velocidad absoluta depende de las condiciones del terreno, tipo de pasto, densidad y la altura de corte:

- El alcance normal de la velocidad absoluta es de 2 a 5 mph.
- La velocidad absoluta debe ser menor cuando segue pasto alto y denso.
- La velocidad absoluta puede ser mayor cuando segue pasto de altura mediana, delgado y cuando las condiciones del terreno sean uniformes.
- Use una velocidad absoluta menor cuando segue en pendientes accidentadas o terreno desconocido.

**Segado de pasto extremadamente alto**

- Puede ser necesario segar dos veces el pasto extremadamente alto.

**Primera pasada de segado:**

- Haga un corte alto al pasto (10-15 pulgadas [25-38 mm]) para evitar objetos escondidos.

**Segunda pasada de segado:**

- Retire los desechos y otros objetos.
- Corte el pasto a la altura deseada y a 90 grados de la primera pasada siempre que sea posible.
- Use las prácticas apropiadas de parada del equipo para su seguridad al bajar del tractor.

**Vigile los espacios libres del equipo**

Las segadoras con enganche de tres puntos y de montaje lateral tienen un arco de viraje mayor que las segadoras de tiro. Permita suficiente espacio libre para virar con seguridad.

## **Seguridad en el uso de las segadoras montadas en la parte inferior**

Cuando segue con una segadora montada en la parte inferior:

- Mantenga el conducto de descarga desmontable colocado en su lugar sobre el agujero de descarga.
- Nunca permanezca de pie sobre la cubierta de una segadora que esté en operación.
- Distribuya el pasto cortado con el conducto de descarga hacia el área ya segada.
- Use las prácticas apropiadas para la parada del equipo antes de eliminar las obstrucciones de la segadora o conducto de descarga.

## Riesgos y peligros de obstrucciones elevadas cuando se usan segadoras de ala o pescante

Verifique que no haya obstrucciones elevadas cuando use segadoras con alas levantadas o de tipo pescante, para evitar lesiones graves o la muerte causadas por el contacto con:

- Líneas de transmisión de energía eléctrica.
- Ramas bajas de árboles.
- Otras obstrucciones elevadas.

## Seguridad en el uso de las segadoras de ala y de montaje lateral

**Cuando utilice segadoras de ala y de montaje lateral:**

Las posiciones con el ala levantada reducen la protección del blindaje y aumentan los riesgos de objetos despedidos y de contacto con la hoja.

**Para evitar las lesiones serias o la muerte causadas por objetos despedidos o contacto con la hoja por la subida y bajada de las alas durante las operaciones de segado:**

- No segue cuando haya transeúntes en el área de segado.
- Asegúrese de que no haya personas cerca cuando suba o baje las alas.
- Mantenga el período de tiempo durante el que está expuesta la hoja rotativa del ala, a un mínimo práctico durante las operaciones de segado con el ala levantada.
- Detenga el segado si entran personas en el área de segado.
- Solamente suba el ala para pasar sobre objetos que se encuentren en el camino de segado o para seguir la inclinación del terreno.
- Desenganche la transmisión del ala durante los períodos prolongados de segado con las alas levantadas.
- Después de pasar sobre un objeto o sobre inclinaciones del terreno, baje el ala levantada, al suelo.
- Permita que todas las hojas de la segadora detengan su rotación antes de levantar las secciones del ala durante otras operaciones.

## Seguridad durante el segado de los bordes de las zanjas

Use cuidado extremo cuando sigue los bordes de las zanjas. Vigile para ver si hay derrumbes, áreas erosionadas y obstrucciones para el segado a lo largo del borde de la zanja. El extremo delantero del tractor puede desviarse hacia la zanja al golpear las obstrucciones con las segadoras de montaje lateral o de pescante.

Las operaciones con segadoras con alas levantadas y pescantes pueden reducir la efectividad del blindaje para objetos despedidos de la segadora que sirven para proteger al operador.

**Para aumentar la protección del operador de objetos despedidos durante las operaciones en los bordes de las zanjas:**

- Use cabinas cerradas con una estructura contra vuelcos (ROPS), cubiertas protectoras especiales y otros blindajes para el operador, cuando efectúe estas operaciones.
- Inspeccione el área de segado y retire o marque todos los objetos extraños y desechos que deben evitarse con la segadora.



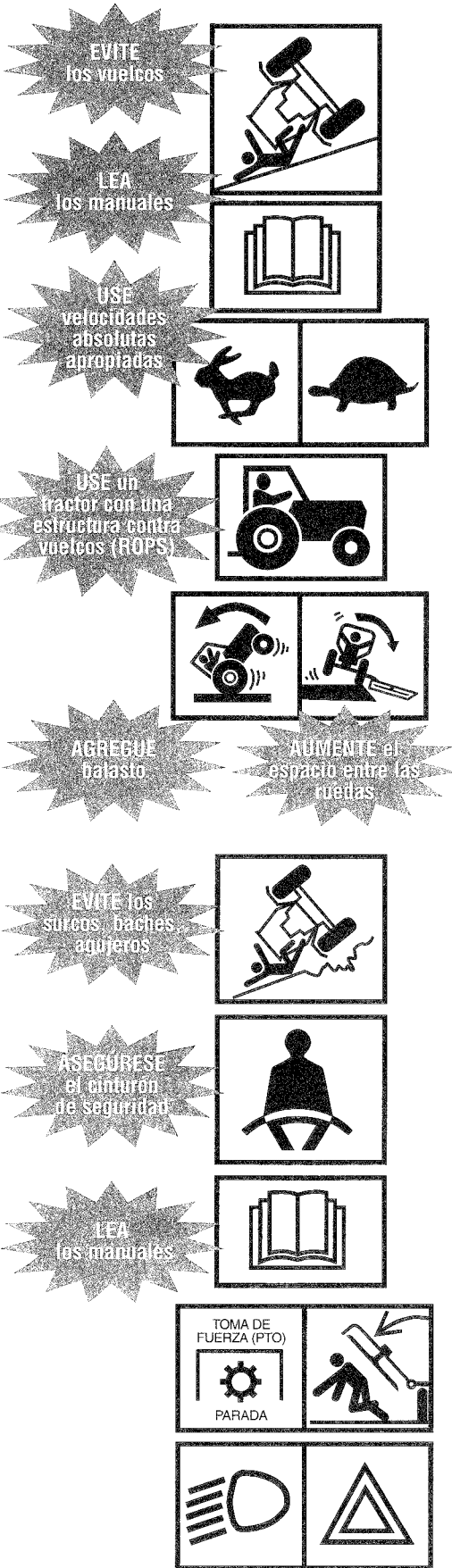

## Seguridad durante el segado de terreno accidentado

La estabilidad del tractor y segadora se reduce en las pendientes y terreno accidentado.

**Usted puede evitar el vuelco del tractor y segadora y mantener el control de la estabilidad del equipo haciendo lo siguiente:**

- Revisando los manuales del operador del tractor y segadora para conocer las prácticas de seguridad de operación en pendientes y terreno accidentado. Explique las prácticas a los usuarios u operadores que no puedan leer.
- Evitando operar en pendientes extremadamente inclinadas.
- Usando cuidado extremo para mantener el control sobre su equipo cuando opere en estas condiciones.
- Aumentando la estabilidad del tractor, agregando pesas a las ruedas y aumentando el espacio entre las mismas, (haga referencia al manual del operador del tractor para conocer las recomendaciones).
- Usando un tractor equipado con una estructura contra vuelcos (ROPS) y cinturón de seguridad para la seguridad del operador durante las operaciones de segado.
- Manteniendo una velocidad absoluta mínima.
- Haciendo virajes anchos y graduales.
- Evitando arranques, paradas y virajes repentinos cuando opere subiendo, bajando o atravesando las pendientes.
- No subiendo del suelo las segadoras montadas atrás o lateralmente ni las alas de segado durante estas operaciones.
- Manteniéndose alerta por si hubiera agujeros, baches, surcos, piedras, troncos u otras obstrucciones que podrían volcar el tractor y segadora.
- Evitando las condiciones de suelo resbaloso que podrían volcar el tractor y segadora.
- Evitando que el tractor y segadora queden atascados al pasar diagonalmente sobre declives y bajadas escarpadas pronunciadas.

**Use extremo cuidado para mantener la estabilidad del equipo durante todas las operaciones sobre terreno accidentado y pendientes. Usted tiene la palabra final referente a cualquier pendiente que pueda ser trabajada en forma segura.**

## Seguridad durante el transporte del equipo en caminos

**Si es necesario conducir el equipo sobre los caminos públicos:**

- Haga referencia al manual del operador del fabricante del tractor y segadora para conocer las instrucciones.
- Explique las instrucciones a los usuarios u operadores que no puedan leer.
- Verifique las reglamentaciones locales referentes a las marcas, luces, luces intermitentes, etc., requeridas del equipo para el desplazamiento sobre caminos públicos. Se requiere de luces para las segadoras que obstruyen las luces traseras del tractor y/o las luces de advertencia.

**Antes del transporte en caminos públicos:**

- Desenganche la toma de fuerza (PTO) conectada a la segadora.
- Suba la segadora a la posición de transporte.
- Asegure las alas en la posición de transporte con los seguros en las segadoras de tipo ala y de montaje lateral.
- Enganche la cadena de seguridad entre la segadora de tipo tiro y el tractor.
- Asegúrese de que las luces, luces intermitentes, reflectores y avisos de vehículo de movimiento lento (SMV) están colocados y visibles.
- Revise que el emblema de vehículo de movimiento lento (SMV) sea visible para cualquier vehículo que se acerque desde atrás.

### Cuando transporte en caminos públicos:

- Obedezca todas las reglamentaciones locales de tráfico.
- Acérquese a las intersecciones con precaución.
- Cumpla con los avisos de velocidad y de control de tráfico.
- Evite las paradas bruscas y doblar repentinamente.

### Seguridad durante el estacionamiento

#### Estacione el equipo en:

- Áreas designadas o alejadas del tráfico.
- Preferentemente utilice lugares en terreno nivelado.

#### Lugares de estacionamiento en terreno inclinado:

- Coloque el equipo en posición transversal en las pendientes.
- Aplique los frenos de estacionamiento.
- Baje la segadora al suelo.
- Coloque bloques en las ruedas del tractor.

#### Antes de estacionar temporalmente y abandonar el equipo incapacitado cerca de áreas con tráfico:

- Retire el equipo de los caminos públicos.
- Coloque las banderas de advertencia.
- Use las luces intermitentes del tractor.

## Seguridad durante la parada

### Para su seguridad use las prácticas apropiadas para la parada del equipo

Haga referencia al (los) manual(es) del operador del fabricante del tractor y segadora para conocer los procedimientos de parada recomendados. Explique los procedimientos a los usuarios u operadores que no puedan leer.

#### Haga que los procedimientos apropiados de parada del equipo sean una costumbre importante que se debe practicar. Siga estas prácticas de seguridad antes de bajarse del tractor:

- Desenganche el embrague y transmisión de la toma de fuerza (PTO).
- Para que el motor enfríe gradualmente permita que funcione al ralentí.
- Coloque los controles en estacionamiento (P) o en punto muerto (N).
- Coloque el freno de estacionamiento.
- Baje la segadora al suelo.
- Baje al suelo las alas de las segadoras de tipo ala.
- Apague el motor.
- Espere a que todas las piezas movibles se detengan antes de efectuar inspecciones, ajustes o reparaciones al equipo.
- Descargue la presión hidráulica moviendo los controles hidráulicos varias veces en todas las direcciones.
- Asegure la ignición y extraiga la llave cuando el equipo debe ser inspeccionado, reparado, ajustado o va a permanecer desatendido.
- Asegure las cubiertas contra el vandalismo cuando el equipo permanece desatendido.
- Baje cuidadosamente manteniendo un contacto de tres puntos.

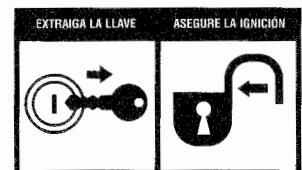
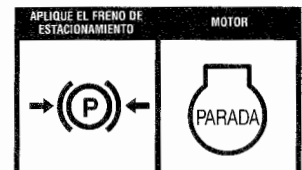
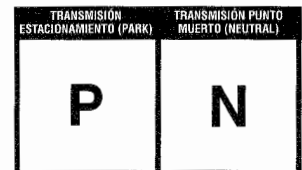
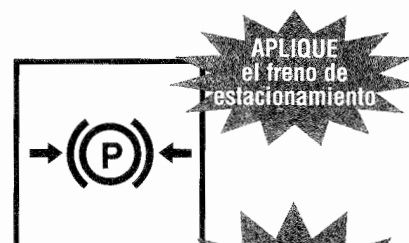

**ESPERE** que las piezas móviles se detengan antes de bajar

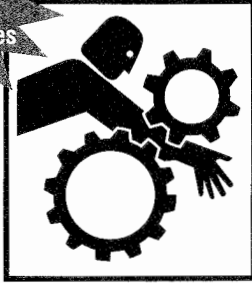

**USE** el contacto de tres puntos



**DE** MANTENIMIENTO a su equipo

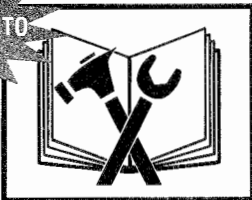

**CUMPLA**

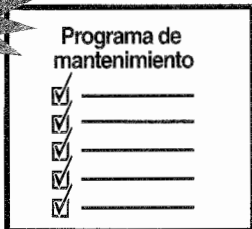

## **Seguridad durante la bajada del tractor**

**Antes de bajar del tractor haga lo siguiente:**

- Para su seguridad, use las prácticas apropiadas para la parada del equipo.
- Baje el implemento al suelo, apague el motor y la toma de fuerza (PTO), aplique los frenos, permita que se detengan todas las piezas móviles y extraiga la llave antes de bajar del tractor.
- Nunca baje del equipo cuando esté en movimiento.
- Nunca salte de las máquinas.
- Baje cuidadosamente.
- Verifique que los escalones no estén resbalosos.
- Mantenga los pies y manos alejados de los controles.
- Use las asas para las manos y los escalones para bajar.
- Vea hacia la máquina y use el contacto de 3 puntos (2 manos, 1 pie ó 2 pies, 1 mano).

## **Seguridad durante el mantenimiento**

### **Seguridad durante el mantenimiento**

**Para su seguridad haga lo siguiente antes de efectuar procedimientos de mantenimiento, reparación o servicio:**

- Cumpla con la práctica apropiada para la parada del equipo.
- Use toda la ropa protectora y equipo de seguridad personal necesarios para efectuar el trabajo en forma segura.
- Haga referencia a sus manuales del fabricante para conocer los procedimientos correctos de mantenimiento, reparación y servicio. Explique los procedimientos a los usuarios y operadores que no puedan leer.

Las fuentes de energía almacenada (eléctrica, mecánica, hidráulica, neumática, química, térmica etc.) deben estar aseguradas, bloqueadas, descargadas, desconectadas, apagadas, aseguradas, neutralizadas, controladas o reducidas a un mínimo práctico, antes de efectuar con seguridad cualquier procedimiento de mantenimiento, reparación o servicio.

**Algunas prácticas de seguridad básicas para evitar posibles lesiones causadas por las fuentes que emiten energía:**

- Desenganche la toma de fuerza (PTO) antes de apagar el motor.
- Coloque los controles en estacionamiento (P) o punto muerto (N) antes de apagar el motor.
- Aplique el freno de estacionamiento o coloque bloques en las ruedas.
- Permita que todas las piezas movibles se detengan.
- Baje la segadora al suelo.
- En las segadoras de tipo ala, baje las alas al suelo.
- Apague el motor del tractor.
- Asegure la ignición y extraiga la llave.
- Observe y escuche para establecer si hay piezas en movimiento antes de abrir los blindajes.
- Soporte o coloque bloques firmemente debajo de la segadora antes de trabajar debajo de la segadora u otros componentes elevados.
- Soporte, coloque bloques o asegure firmemente las alas de la segadora con los seguros antes de trabajar cerca o debajo de una segadora de tipo ala.
- Descargue la presión del sistema hidráulico moviendo los controles varias veces en todas direcciones.
- Descargue la presión antes de desconectar o desensamblar cualquier sistema presurizado.
- Coloque bloques o descargue la presión del resorte antes de desensamblar cualquier dispositivo a resorte.
- Soporte o bloquee firmemente cualquier componente de la máquina que esté elevado, antes de trabajar en ella.
- Evite las llamas, chispas o fumar cerca de cualquier combustible.



**Su seguridad y las piezas del fabricante para la segadora**

La mayoría de los fabricantes de segadoras usan sujetadores y piezas especialmente diseñadas para cumplir con los requerimientos de la operación de segado.

Seguridad crítica – piezas relacionadas (pernos de la hoja autoasegurados, hojas, pasadores, blindajes u otros artículos especiales) tienen requerimientos de fuerza, diseño y encaje específicos para el estilo y modelo de la segadora que usted utiliza.

Las modificaciones o piezas para reparación que no son aprobadas por el fabricante de la segadora pueden causar un riesgo significativo por exposición a su seguridad y la de los demás.

**PARA EVITAR LAS LESIONES SERIAS O LA MUERTE CAUSADAS POR PIEZAS O MODIFICACIONES NO APROBADAS:**

- No sustituya accesorios comunes por los pernos autoasegurados de las hojas u otras piezas especiales.
- No sustituya las hojas, pasadores, blindajes u otras piezas relacionadas con la seguridad crítica.
- No use pernos de grado 5 u 8 para reemplazar los pernos de resistencia limitada grado 2.

**CUMPLA LA PRÁCTICA SEGURA DE SIEMPRE VERIFICAR EL FUNCIONAMIENTO CORRECTO DE TODOS LOS AJUSTES, REPARACIONES O SERVICIO DE LA SEGADORA.**



## **Palabra final**

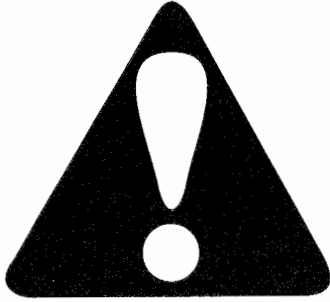

Usted ha terminado de leer el manual de seguridad de la segadora. Es imposible que este manual incluya toda situación peligrosa potencial que usted pueda encontrar. Sin embargo, su conocimiento de estas precauciones de seguridad y su cumplimiento de las reglas básicas de seguridad le ayudarán a crear buen juicio para todas las situaciones. Nuestro objetivo es ayudarle a desarrollar buenos hábitos de seguridad y hacerlo un mejor operador de segadora. El manual de seguridad de la segadora, precauciones de seguridad y reglas básicas de seguridad deben explicarse a los usuarios u operadores que no puedan leer.

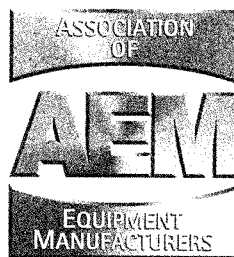

111 E. Wisconsin Avenue • Milwaukee, Wisconsin 53202 U.S.A.  
[www.aem.org](http://www.aem.org)

Para obtener información de reproducciones adicionales y  
otros manuales de seguridad, llame al 800-369-2310



# **INTRODUCTION SECTION**

# INTRODUCTION

This Rotary Mower is designed with care and built with quality materials by skilled workers. Proper assembly, maintenance, and operating practices, as described in this manual, will help the owner/operator get years of satisfactory service from the machine.

The purpose of this manual is to familiarize, and instruct. The Assembly Section instructs the owner/operator in the correct assembly of the Mower using standard and optional equipment. The Parts Listing section is designed to familiarize the owner/operator with replaceable parts on the Mower. This section provides exploded assembly drawings of each mower component illustrating each piece and the corresponding part number.

Careful use and timely service saves extensive repairs and costly downtime losses. The Operation and Maintenance Sections of the manual train the owner/operator how to work the Mower correctly and attend to appropriate maintenance. The Trouble Shooting Guide helps diagnose difficulties with mower and offers solution to the problems.

Safety is of primary importance to the owner/operator and to the manufacturer. The first section of this manual includes a list of Safety Messages, that, if followed, will help protect the operator and bystanders from injury or death. Many of the Safety Messages will be repeated throughout the manual. The owner/operator/dealer should know these Safety Messages before assembly and be aware of the hazards of operating this mower during assembly, use, and maintenance. The Safety Alert Symbol combined with a Signal Word, as seen below, is intended to warn the owner/operator of impending hazards and the degree of possible injury faced when operating this machine.

**CAUTION!** The lowest level of Safety Message; warns of possible minor injury. Decals located on the Mower with this Signal Word are Black and Yellow.



**WARNING!** Serious injury or possible death! Decals are Black and Orange.



**DANGER!** Imminent death/critical injury. Decals are Red and White.



# INTRODUCTION

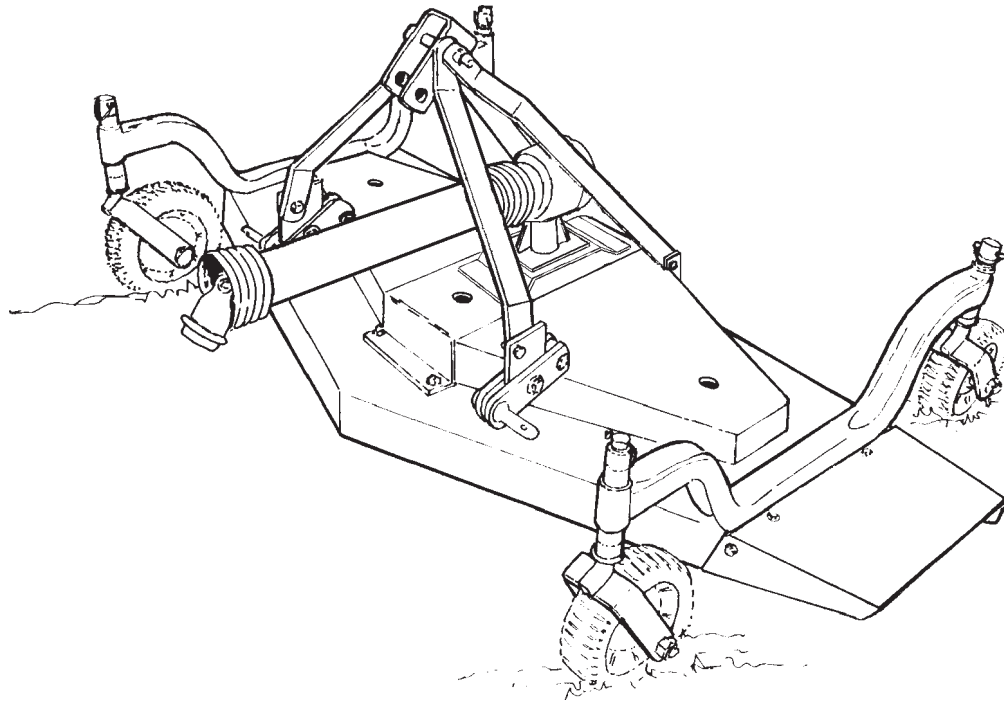

Your RHINO GK mower is designed for light-duty cutting such as lawn maintenance plus small weed and grass control. With a reasonable amount of preventive maintenance, your Mower will provide years of dependable service.

## **DANGER!**



**NEVER ALLOW CHILDREN TO OPERATE, RIDE ON, OR COME CLOSE TO MOWER OR TRACTOR.** Usually, 15-16 year-old children who are mature and responsible can operate the mower with reasonable safety if they have read Operator's Manual, been trained in safe operation of the machine, and are physically large and strong enough to reach and operate controls easily.

## **DANGER!**



For Non-Agricultural use, OSHA, ASAE, SAE, and ANSI standards require the use of Chain Guards, Deflectors, or Solid Skirts at all times. The Mower manufacturer strongly recommends the use of Chain Guards or Solid Skirts for Agricultural purposes as well, to reduce the risk of property damage, serious bodily injury, or even death from objects thrown out by or from contact with the Cutting Blades.

## **WARNING!**



At least 20% of the tractor's weight must be on the front tires with the Mower lifted to provide adequate traction for safe steering under good conditions. Slow down on hills, rough terrain, and curves.

Front and rear and left and right are determined by the normal direction of travel, the same as driving an automobile.

# INTRODUCTION

## ATTENTION OWNER/OPERATOR

BEFORE OPERATING THIS MACHINE:

1. Carefully read the Operator's Manual, completely understand the Safety Messages and instructions, and know how to operate correctly both the tractor and Mower.
2. Fill out the Warranty Card in full. Be sure to answer all questions, including the Serial Number of the Mower. Mail within 30 days of delivery date of this implement.

**NOTE:** *Warranties are honored only if completed "Owner Registration and Warranty" forms are received by Alamo Group within thirty days of delivery of the mower.*

3. Record the Mower Model and Serial Numbers on the Warranty page at the front of the Operator's Manual. Keep this as part of the permanent maintenance file for the Mower.

# IMPORTANT

**For your safety and to guarantee optimum product reliability, always use Genuine RHINO replacement parts. The use of inferior "will-fit" parts will void Warranty of your RHINO implement and may cause premature or catastrophic failure which can result in serious injury or death. If you have any questions concerning the repair parts you are using, contact Servis-Rhino, 1502 E. Walnut Seguin, TX 78155 (830) 372-3080.**



# ASSEMBLY SECTION

Assembly Section 3-1

# ASSEMBLY

The GK60 & 72 Mowers will attach to most tractors with Cat. I Three-Point hitch and a 540 RPM PTO. **DO NOT EXCEED HORSEPOWER RECOMMENDATIONS.**

**DANGER!**



Operating with PTO speed over 540 RPM can cause excessive vibration with subsequent machine failure which can cause serious injury or even death. Never exceed 600 RPM.

## DEALER SET-UP INSTRUCTIONS

Assembly of this mower is the responsibility of the Rhino dealer. The mower should be delivered to the owner completely assembled, lubricated, and adjusted for normal cutting conditions.

Set up mower as received from the factory with these instructions. Remove mower from carton. Open parts box and lay parts out to make location easy. Refer to parts lists and exploded view drawings for more detail.

This mower is shipped partially assembled. Assembly will be easier if components are aligned and loosely assembled before tightening hardware.

**CAUTION!**



Always use personal protection devices such as eye and ear protectors during assembly.

## A-FRAME ATTACHMENT

Attach the Rear Brace Bars (1) to the lugs on the rear of the deck with 1/2" x 1-1/4" bolts & 1/2" locknuts (2).

**NOTE:** Install rear braces in rear holes on deck if hitch pins are positioned in standard position. Install in front holes if hitch pins are in extended position. Attach the A-Frame Bars (3) to the lugs on the front of the deck with 5/8" x 1-3/4" bolts & 5/8" locknuts (4). Attach the other end of the A-Frame Bars (3) at the top and between the Rear Brace Bars (1) and Top Link (5) with 3/4" x 5-1/2" bolt, bushing & 3/4" nut (6). **FIGURE 1.**

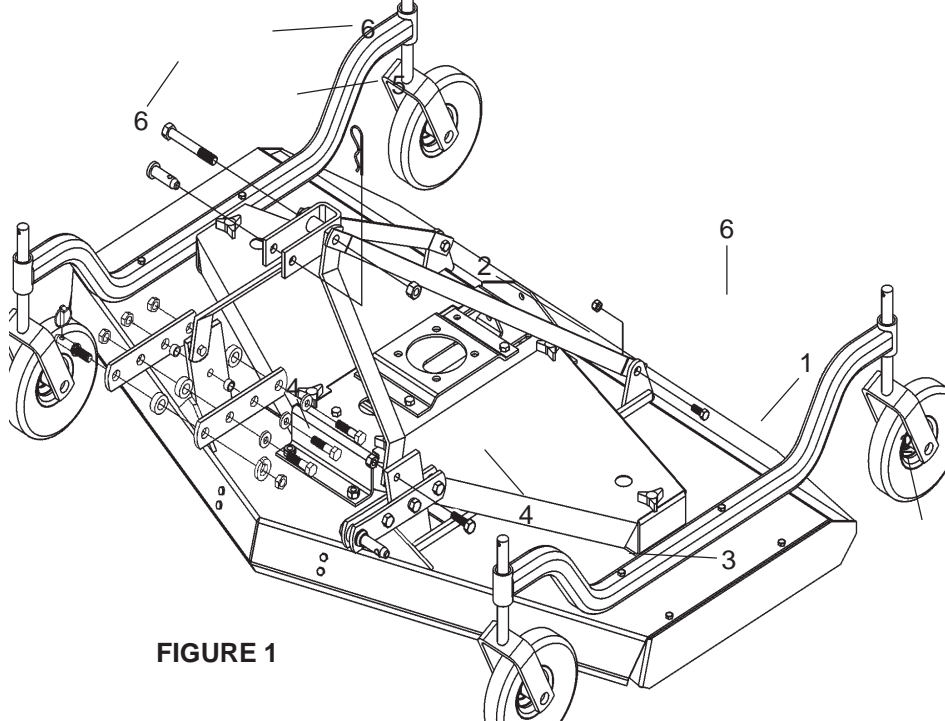
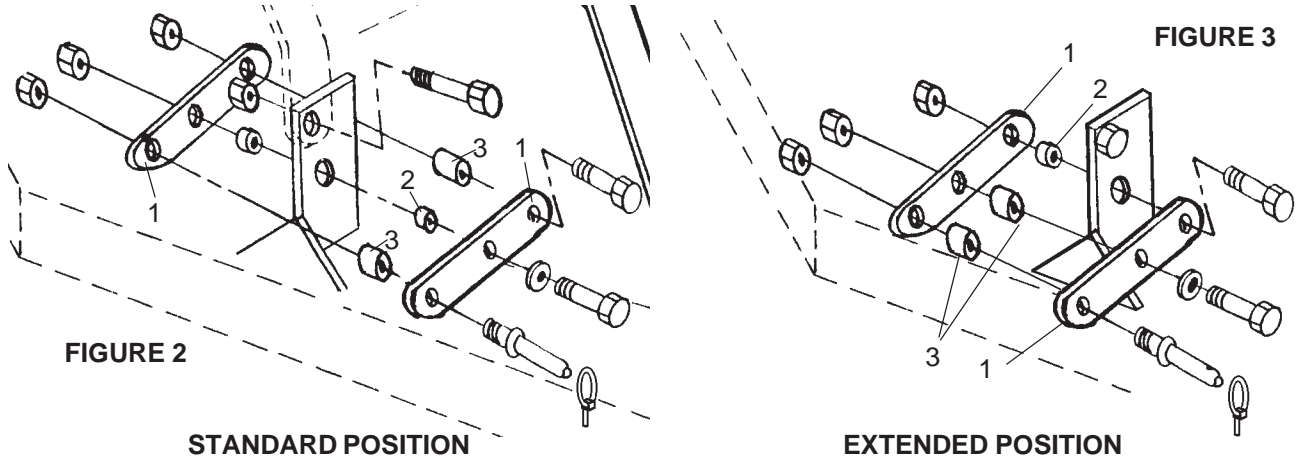

FIGURE 1

# ASSEMBLY

## A-FRAME ATTACHMENT (cont'd.)

Install floating hitch pins to main frame using either the standard or extended hitch positions. Exploded view shows standard position **FIGURE 2**. To install in extended position move flats (1) forward and place bushings (2) in rear holes and bushing (3) at center hole. **FIGURE 3**.



## CASTER WHEEL ATTACHMENTS

Attach the right and left Axle Arm Weldment (5) to the deck with 3/8" bolts (3) flatwasher (1-1/2OD x 3/16 thick) (7), and 3/8 locknuts (8). Install two one inch spacers (1) and one 1/2 inch spacer (4) on each fork and wheel assembly shaft (6). Insert fork shaft (9) into axle arm weldment (5). Install two additional one inch spacers (1) on each axle shaft (9) and retain using Snapper Pin. **FIGURE 4**.

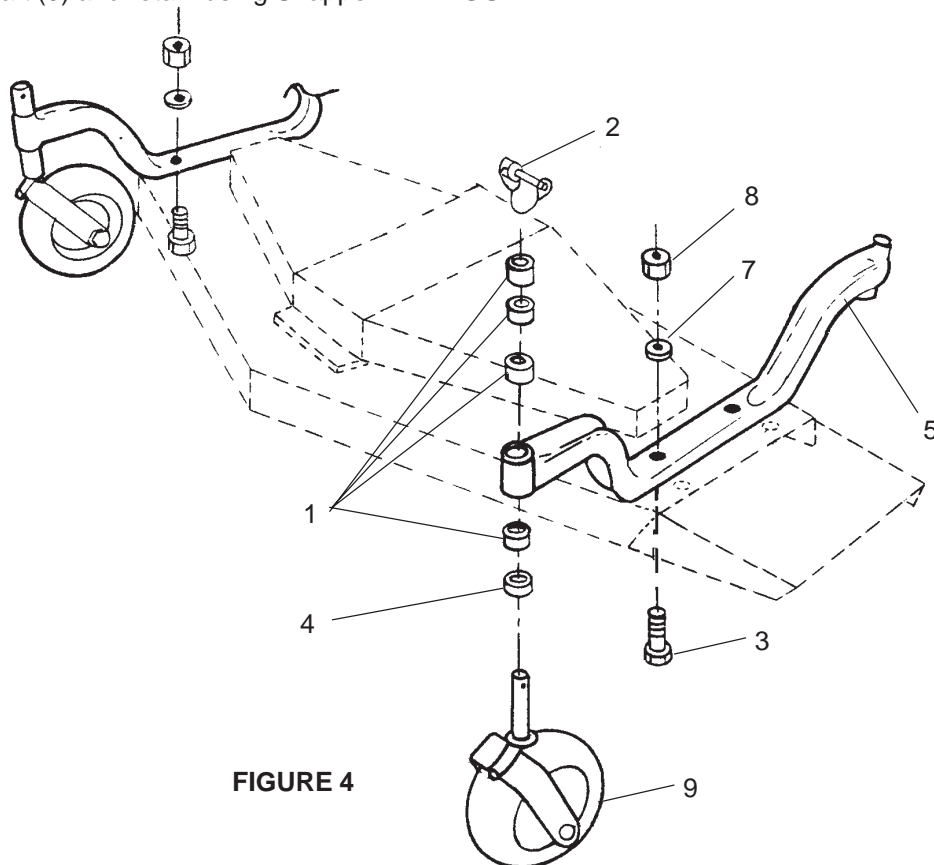





# OPERATION SECTION

Operation Section 4-1

# OPERATION

The safe operation of this machine is the responsibility of the operator. The operator should be familiar with the cutter and tractor and all safety practices before starting operation. This mower is designed for lawn or grass mowing. It is not designed for rough conditions or heavy weed mowing. It is equipped with suction type blades for best results in lawn mowing.

Always operate tractor PTO at 540 rpm.

This section provides information for attaching mower to tractor and preparing it for field operation. Review this data prior to tractor hookup and operation.

## **TRACTOR PREPARATION - Do not install on a tractor over 40 horsepower.**

### **Ballast**

An implement code of has been assigned to the fully-equipped Lift-Type GK mower so that you can determine the tractor front ballast requirements. Refer to your tractor Operator's manual for the code number and ballasting requirements.

**WARNING!** Do not operate with less than 20% of tractor's gross unballasted mass on front wheel with mower in transport position.



### **Wheel Treads**

Tractor wheel tread spacing should be increased when working on inclines or rough ground to reduce the possibility of tipping.

### **Stabilizer Bars or Sway Blocks**

Use stabilizer bars or sway blocks to prevent side sway of the mower.

### **Drawbar**

Shorten or remove the tractor Drawbar so it will not interfere with the up and down movement of the Mower.

**WARNING!** Do not get between Tractor and Mower when engine is running!



## **ATTACHING MOWER TO TRACTOR - LIFT TYPE**

This mower is designed for 540 RPM PTO only with CAT I hitch. Back the tractor up to the mower so that the lower Draft Arms are in alignment with the mower lower lift pins. Stop the engine, lock the brakes or place the tractor in park. Connect the tractor and Stabilizer Bars to the lower lift pins. Adjust the Top link so it will pin to the top holes in the A-Frame or into holes in floating top link.

**DANGER!** **NEVER ALLOW CHILDREN TO OPERATE, RIDE ON, OR COME CLOSE TO MOWER OR TRACTOR.** Usually, 15-16 year-old children who are mature and responsible can operate the mower with reasonable safety if they have read Operator's Manual, been trained in safe operation of the machine, and are physically large and strong enough to reach and operate controls easily.



# OPERATION

## DRIVELINE ATTACHMENT TO TRACTOR

1. Grab and pull collar on end of attaching yoke toward cutter.
2. Slide yoke (with collar depressed) onto PTO shaft.
3. Move yoke back and forth until locking collar clicks forward and locks the yoke in place.

### WARNING!



When attaching PTO yoke to tractor PTO shaft, it is important that spring activated locking collar slides freely and is seated in groove on PTO shaft.

### WARNING!



Be sure PTO shielding and all other shielding is installed and is in good condition.

## CUTTING HEIGHT ADJUSTMENT

### WARNING!



Avoid personal injury! Be sure tractor engine is off, key is removed, and **ALLOW BLADES TO STOP TURNING** before dismounting to make adjustments.

**Important:** Avoid very low cutting heights. Striking the ground with blades gives the most damaging shock loads a cutter can encounter and will cause damage to cutter and drive.

1. Using the tractor, raise the mower off the ground and support under it with secure blocking so not to let the mower drift down during maintenance.
2. Holding wheel and yoke assembly up, remove quick-lock pin from top of gauge wheel spindle. Position full length spacers and half spacer as required. All spacers on top of spindle tube allows for approximately 1" cutting height. Adjustments range from 1" to a maximum of 4-1/2" in 1/2" increments.

## STARTING & STOPPING CUTTER

Power for operating cutter is supplied from tractor PTO. Refer to your tractor manual instructions for engaging and disengaging the PTO. Always engage the PTO at low engine rpm. Always operate at recommended PTO speed of 540 RPM. Learn how to stop tractor and cutter quickly in case of an emergency.

**IMPORTANT:** Stop cutter and tractor immediately upon striking an obstruction. Inspect the cutter and repair any damage before resuming operation. **Do not disengage PTO when engine is a full PTO RPM. Always idle engine before disengaging PTO.**

### WARNING!



Avoid personal injury. When attempting to stop a tractor which does not have live PTO, the momentum created by the blade carrier of a rotary cutter can cause the tractor to be pushed forward. **DO NOT** operate this cutter unless tractor has live or independent PTO.

To commence operation, reduce engine speed and engage the tractor PTO. Before starting to cut, gradually increase engine speed to develop full PTO speed.

# OPERATION

Enter the area to cut with the cutter operating at PTO speed and, if it becomes necessary to temporarily regulate engine speed during operations, increase or decrease the throttle gradually.

To transport, disengage the PTO, raise full transport height.

## CUTTING SPEED

Proper ground speed for cutting will depend upon the height, type, and density of material to be cut.

Normally, ground speed will range from 1-1/2 to 3 mph. Tall dense material should be cut at low speed while thin medium height material can be cut at a faster ground speed.

## CUTTING TIPS

Always operate PTO at recommended RPM when cutting. This is necessary to maintain proper blade speed and to produce a clean cut.

Under certain conditions, tractor tires may roll some grasses down and prevent them from being cut at the same height as the surrounding area. When this occurs, reduce the tractor ground speed, but maintain PTO RPM. The lower speed will permit grasses to be at least partially rebound and be cut. Taking a partial cut and/or reversing the direction of travel may also produce a cleaner cut.

As often as possible, stop mowing when other people are passing by. Although the Mower is shielded to prevent objects from being thrown out by the blades, no one shield device is 100% effective. The operator has greater knowledge of the dangers of being around this Mower while it is operational than the person on the street.

### WARNING!



Avoid personal injury. Pick up all rocks and other debris before cutting. Enter new areas carefully. Cut material higher the first time to allow cutter to clear unseen objects. Never assume an area is clear. Always check.

Extremely tall grass should be cut twice. Raise cutter and cut twice the desired height. Cut the second time at desired height at 90 degrees to first pass.

Remember, sharp blades produce cleaner cuts and use less power.

Before cutting, analyze the area to determine the best cutting procedure. Consider the height and type of material and the terrain type: hilly, level or rough.

Grass is best cut when it is dry. Mowing wet grass can cause plugging resulting in grass clumps behind the mower.

Grass should be mowed frequently as shorter clippings deteriorate faster.

## DETACHING AND STORING

Lower the Mower to the Ground. Park the Tractor with the transmission in the correct gear (Automatic Transmission--Park; Standard Transmission--Neutral). Set the parking brake, shut off the engine, and remove the key. Wait until the PTO stops rotating before getting down from the tractor.

Disconnect the driveline from the tractor PTO and store it to prevent it from contacting the ground.

Always reinstall the Master Shield over the tractor PTO Shaft. This shield should always remain in place except when connecting or disconnecting driveline.

# OPERATION

## BEFORE OPERATING OR TRANSPORTING THIS MOWER

Always display this SMV emblem (**FIGURE 1**) on the rear of the tractor transporting this mower where it is clearly visible to oncoming traffic. Prominent display of this symbol will help the operator avoid accidents which could cause injury or possibly death.

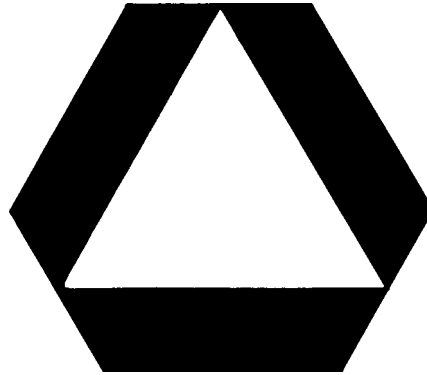

**FIGURE 1**

## DRIVELINE LENGTH CHECK PROCEDURE

### WARNING!



A loose shaft could slip off and result in personal injury or damage to cutter. When attaching PTO yoke to tractor PTO shaft, it is important that spring activated locking collar slides freely and locking balls are seated in groove on PTO shaft.

### WARNING!



Before operating cutter, check to make sure the driveline will not bottom out or become disengage.

- \* Disengage the Driveline from the tractor PTO Shaft.
- \* Slide the Driveline together until it "bottoms out" solidly.
- \* Apply colored tape to the Inner Shield 1/8" from the end of the Outer Shield. **FIGURE 2**
- \* Re-attach the Driveline to the PTO Shaft.

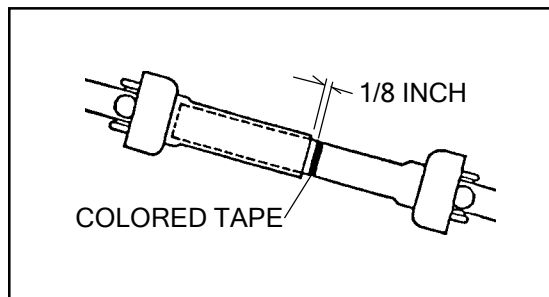

**FIGURE 2**

**Driveline in maximum compressed position**

# OPERATION

## DRIVELINE LENGTH

Raise mower to full transport or until driveline just hits deck at front. If distance between colored tape and outer shield tube is 1-9/16" or less, drive tubes should be shortened per **Figure 4**. Always maintain 1-9/16" clearance when operated in shortest working position. Shorten inner and outer guard tubes equally. Shorten inner and outer sliding profiles by the same amount that the shield tubes were shortened. Round off all sharp edges and remove burrs. Grease sliding profiles. **FIGURE 3**.

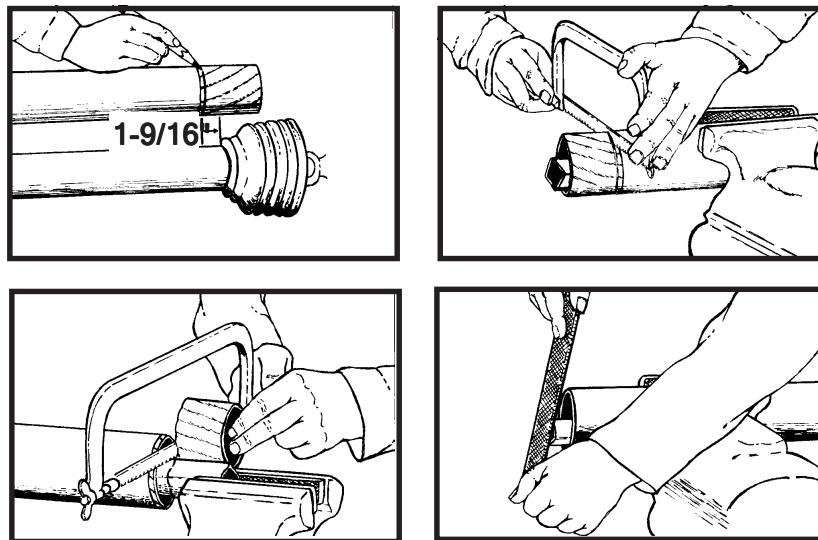

**FIGURE 3**

Lower mower to lowest position possible. Check distance from colored tape to end outer shield tube. Driveline tube engagement must always exceed 12 inches. If not consult dealer to obtain longer driveline.

## FRONT GAUGE WHEEL INTERFERENCE CHECK

Do not operate mower until this interference check has been performed. If you change tractors, you must perform the check for that mounting.

Raise mower with tractor hydraulics to maximum height of tractor lift.

Pivot both front gauge wheels forward and check that there is clearance between gauge wheels and tractor tires.

If there is interference, you must move hitch pin to extended position (See assembly section). Move tractor tires inward to obtain clearance or lower mower until clearance exists. Set 3-Point quadrant stop so mower cannot be raised beyond set point. **FIGURE 4**.

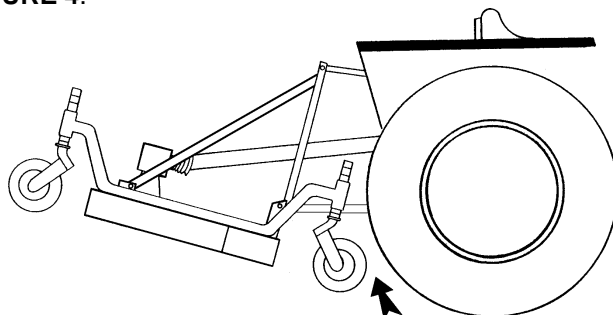

**Figure 4 - Front Gauge Wheel Clearance**

# OPERATION

## TROUBLESHOOTING

PROBLEM	POSSIBLE CAUSE	REMEDY
STREAKING	Slow Blade Speed Worn Blade Tips	Operate PTO at 540 RPM. Replace with Genuine <b>RHINO</b> Blades. See your Rhino dealer. Sharpen blades uniformly.
	Dull Blades Blades unable to cut that part of grass pressed down by path of tractor tires or casters Mowing Too Fast Drive Belt Loose Belt Glazed/Slipping	Slow ground speed of tractor but keep engine running at full PTO rpm. Cutting lower will help. Slow down until cured. Tighten per instructions. Apply belt dressing or replace with special <b>RHINO</b> belt.
	Blade Loose on Spindle	Tighten blade bolt securely. (Note: Left Hand threads Torque to 85 ft. lbs.)
	Conditions to wet for mowing	Allow grass to dry before mowing.
MATERIAL DISCHARGES FROM MOWER UNEVENLY, material BUNCHES MATERIAL ALONG SWATH	Material too high and too much material  Belt Slipping  Grass Wet	Reduce ground speed but maintain 540 rpm at tractor PTO, or make two passes over material. Raise the mower for the first pass and lower to desired height for the second and cut at 90 deg. to first pass. Raise rear of mower high enough to permit material to discharge, but not so high that conditions listed above occur. Tighten or replace with special <b>RHINO</b> belt. Allow grass to dry before mowing. Slow ground speed of tractor but keep engine running at full PTO rpm. Cutting lower will help.
HEAVY VIBRATION	Too high blade speed Broken/bent Blade  Worn/Unbalanced Blade Bent/Broken Sheave Trash Hung on Blade	Do not exceed 540 PTO RPM. Replace with genuine <b>RHINO</b> Blades. See your <b>RHINO</b> dealer. Grind uniformly or replace. Replace parts. Clean off blade.
BELT SLIPPING	Belt loose  Belt Glazed Oil on belt	Tighten or replace with Special <b>RHINO</b> belt. Use belt dressing or replace. Clean or replace.

# OPERATION

## TROUBLESHOOTING

PROBLEM	POSSIBLE CAUSE	REMEDY
BELT SLIPPAGE	Mower overloading, material too tall or heavy	Reduce tractor ground speed but maintain full PTO rpm. Cut material twice, one high pass and then mow at desired height. Cut a partial swath.
	Oil on belt from over lubrication	Be careful not to over lubricate. Clean lubricant from belt and pulleys with clean rag. Replace oil soaked belt.
	Belt hung up or rubbing	Check belt for free travel in pulleys and belt guides. Check under mower and around blade spindle shafts for wire, rags, or other foreign material. Clean all material from under mower.
FRAYED EDGES ON COVER	Belt misaligned or belt rubbing guide. Pulley misalignment	Re-align belt or guide. Be sure belt doesn't rub any other part while running. Inspect to ensure belt is running in center of backside idler. Shim idler as necessary to align.
BELT ROLLOVER	Pulley misalignment Damaged belt Foreign object in pulley grooves	Re-align Replace belt.* Inspect all pulley grooves for rust, paint or weld spots and remove.
	Worn pulley groove	Replace pulley
DAMAGED BELT	Rollover, high shock loads or installation damage	Replace belt.*
BELT BREAKAGE	High shock loads	Avoid abusive mowing. Avoid hitting the ground or large obstructions.
	Belt came off drive	Check drive alignment for foreign material in grooves. Ensure proper tension. Avoid hitting solid objects or ground.

\*Check broken belt for damage by laying it flat on floor. If belt does not lie flat (has humps or twists), which indicated broden or stretched cords, it must be replaced.



# **MAINTENANCE SECTION**

Maintenance Section 5-1

# MAINTENANCE

Before operating your Finishing Mower, make sure it is properly lubricated and thoroughly inspected. Only a minimum of time and effort is required to regularly lubricate and maintain this machine to provide long life and trouble free operation.

**WARNING!** Always disengage the PTO before raising the Rotary Cutter for transporting or making adjustments.



## LUBRICATION INFORMATION

Do not let excess grease collect on or around parts, particularly when operating in sandy areas. The illustrations below shows lubrication points. The chart gives the frequency of lubrication in hours, based on normal operating conditions. Severe or unusual conditions may require more frequent lubrication. **Figure 1.**

Use an SAE multi-purpose, lithium-type grease for all locations shown. Be sure to clean the fitting thoroughly before using grease gun. Daily lubrication of the wing driveline slip joint is necessary. Failure to maintain proper lubrication will result in damage to U-joints, gearbox, and/or driveshaft.

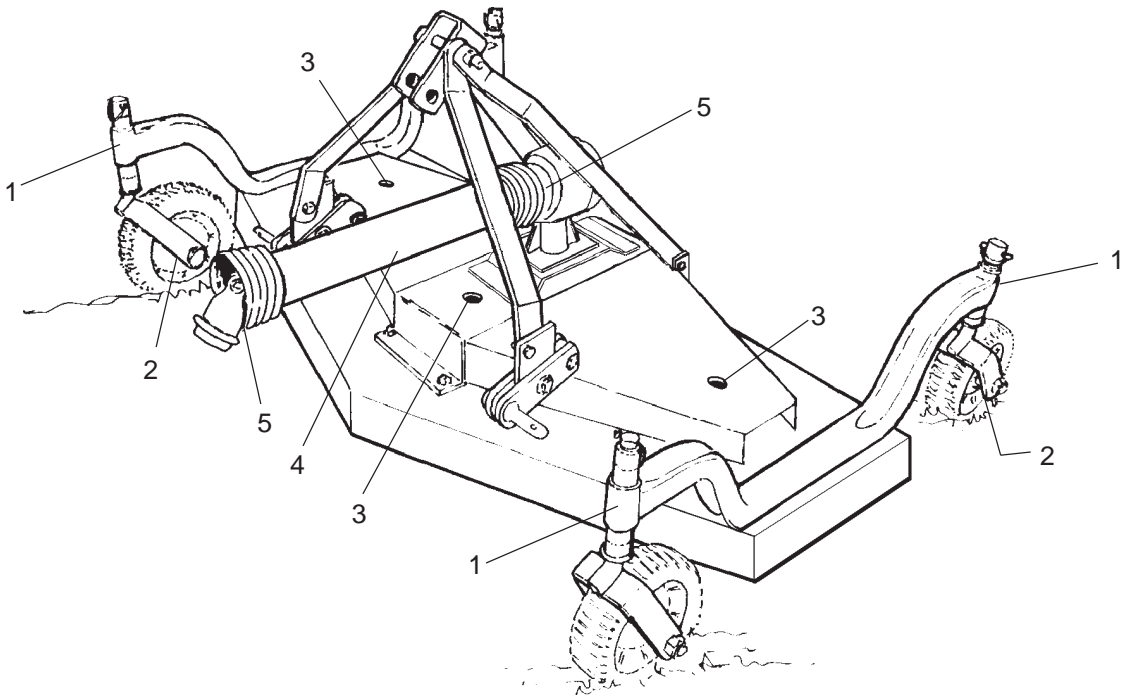

LUBRICATION FITTING LOCATION FIGURE 1

ITEM	DESCRIPTION	FREQUENCY
1	Gauge Wheel Pivots	8 Hours or daily
2	Wheel Hubs	8 Hours or daily
3	Blade Spindle	8 Hours or daily
4	U-Joint Telescoping Member	8 Hours or daily
5	U-Joints	8 Hours or daily

# MAINTENANCE

## GEARBOX

The Gearbox has been filled with lubricant to the Test Plug Level prior to shipment. However, you should check the oil level at Test Plug before operating, and frequently thereafter.

The gearbox should not require additional lubricant unless the box is cracked or a seal is leaking. It is recommended that the oil level plug be removed after every 8 to 10 hours of operation and oil added until it runs out Test Plug hole. The Test Plug is located on the side of the Gearbox. Filler Plug is located on top of Gearbox. **Figure 2.**

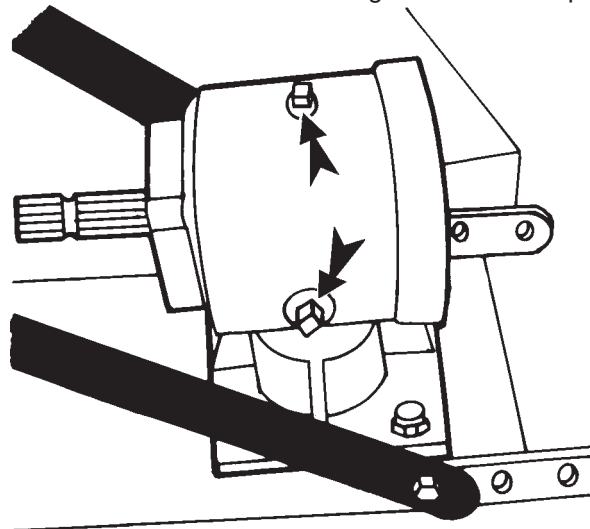

FIGURE 2

Recommended lubricant is NLGI Grade 000 Grease (P/N 00765444) with the capacity of one quart.

**NOTE:** Overfilling the Gearbox will cause pressure to build up and cause Oil Seals to leak.

**ATTENTION:** If the Gearbox suddenly starts making an unusual noise, stop at once, check for leaks, and refill Gearbox as required.

## GAUGE WHEEL ASSEMBLIES

Gauge wheels are equipped with bushings which require grease daily. Grease Fittings are provided in the Wheel Hub and Gauge Wheel Pivot. Grease after 8 hours of use. **FIGURE 3 & 4.**

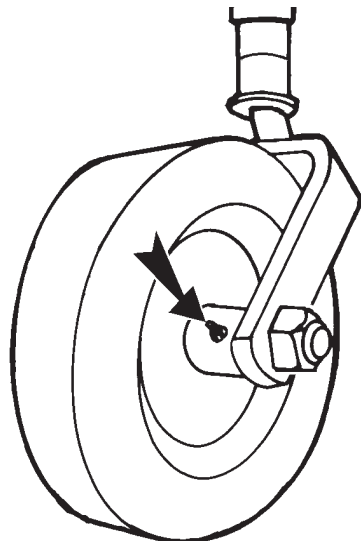

FIGURE 3

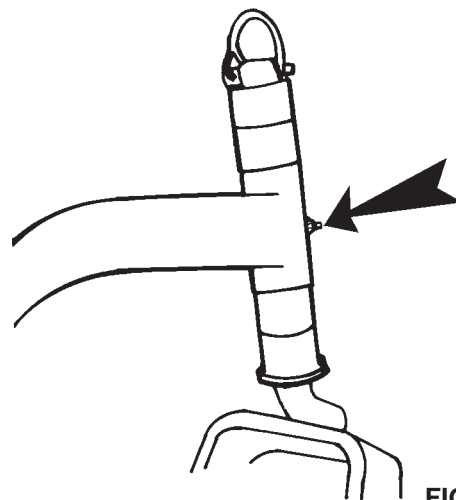

FIGURE 4

# MAINTENANCE

## DRIVELINE LUBRICATION

Grease Fittings are located on the Cross Assembly of each U-Joint and on the telescoping tubes. Grease the U-Joint after each 8 hours of use. Figure 5. Do not force grease through the Needle Cup Assemblies.

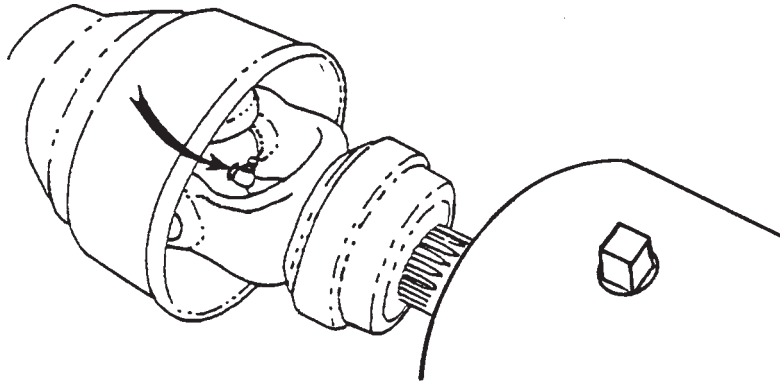

FIGURE 5

The telescoping PTO shaft inside the shielding must be lubricated daily. **Figure 6.**

Disconnect driveline from tractor and pull halves apart. Insert grease into outer profile cavity on half attached to gearbox and spread evenly. Install driveline halves together.

Reconnect driveline to tractor. Raise and lower cutter after applying grease to spread over joint working area.

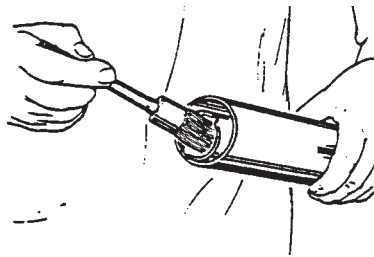

FIGURE 6

### WARNING!



When attaching PTO yoke to tractor PTO shaft, it is important that the spring-activated locking collar slides freely and locking ball are seated on the groove on PTO shaft. A loose yoke could slip off and result in personal injury or damage to cutter.

## BLADE SPINDLE LUBRICATION

Blade spindles must be lubricated daily (every 8 hrs). Access lubrication fitting through hole in outer sheilds and in center gearbox mounting. Each spindle has vent hole in top just under drive pulley and must be lubricated enough each time to force small amount of grease out. **NOTE:** Do not over lube as excess grease may get on belt drive.

# MAINTENANCE

## BLADE SERVICING

Inspect blades before each use to determine that they are properly installed and in good condition. Replace any blade that is bent, excessively nicked, worn, or has any other damage. Small nicks can be ground out when sharpening.

Use only original equipment blades on this cutter. They are made of special heat-treated alloy steel. Substitute blades may not meet specification and may fail in a hazardous manner that could cause injury.

## BLADE SHARPENING

Always sharpen both cutting edges of each blade at the same time, the same amount, to maintain balance. Follow original sharpening pattern as shown. Do not sharpen blade to a razor edge, but leave a 1/32" blunt edge. Do not shapen back side of blade. **Figure 7.**

**WARNING!** Avoid personal injury. Always block the cutter up to prevent it from falling when the blades and/or carrier are being serviced.



MAINTAIN CORNER

FOLLOW ORIGINAL PATTERN

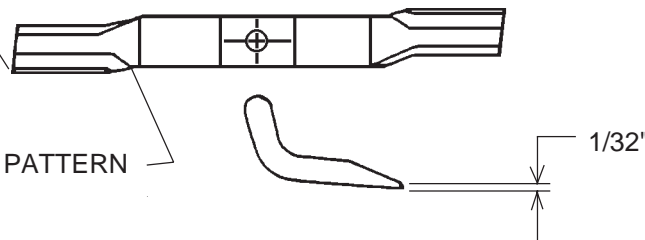

FIGURE 7

## BLADE REMOVAL

Hold the end of blade using heavy leather gloves and remove left hand threaded bolt.

## BLADE INSTALLATION

Install washer on blade bolt, insert bolt into blade, insert seal protector washer over blade bolt and then thread bolt into spindle shaft. **NOTE:** Blade bolt has left hand threads. Tighten blade bolt to 85 ft. lbs. torque. Use heavy leather gloves during tightening process to hold blade and wrench.

# MAINTENANCE

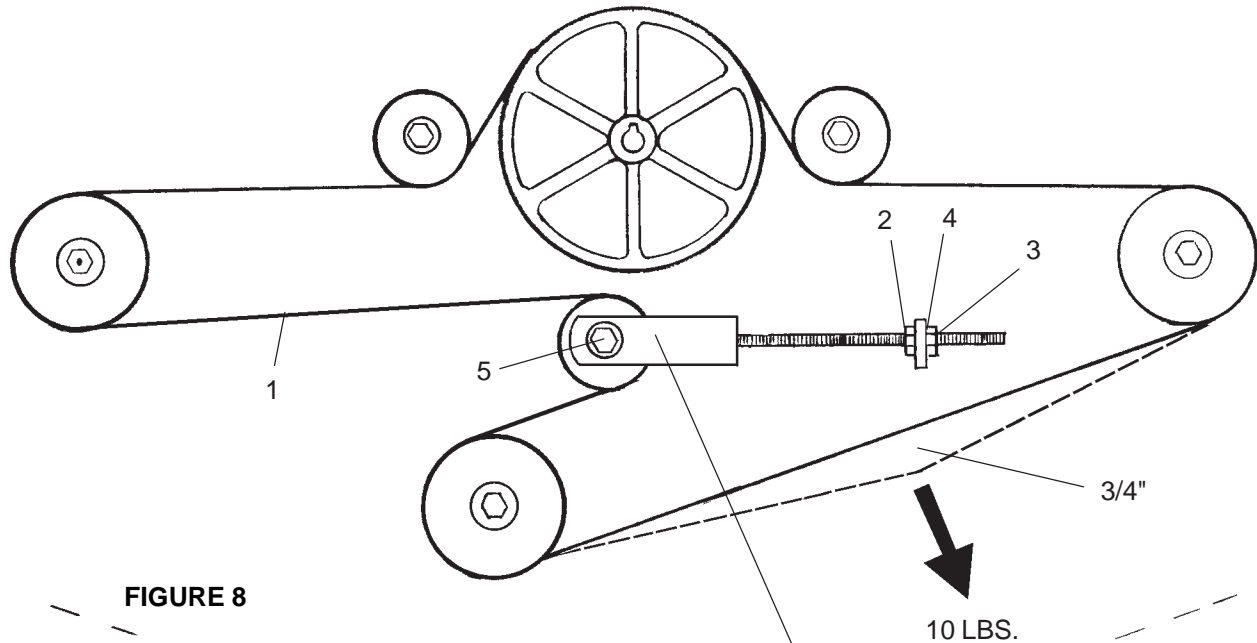
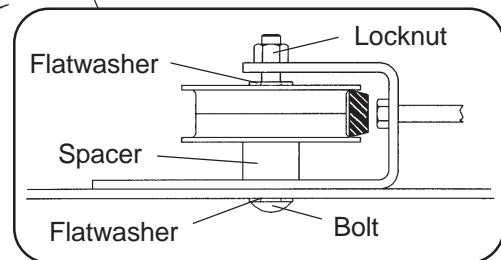

FIGURE 8



## BELT ADJUSTMENT PROCEDURE (All Models except 11')

Adjust the tension in the drive belts, item 1, properly so that they deflect 3/4" when a force of approximately 10 lb. is applied as indicated.

Tighten drive belts by loosening nut, items 2 & 5, and turn nut, item 3 against the anchor plate until proper tension is reached. **DO NOT OVERTIGHTEN.** Tighten jam nut, item 4., and nut item 2. And retighten item 5. **FIG. 8.**

Replace the belt safety shields using wing nuts.

## BELT INSTALLATION (All Model except 11')

**NOTE:** Always replace belts as matched set of two.

To replace drive belts (1), remove belt shields and loosen nuts (2, and 3). Loosen and remove nut (5). Disassemble tensioning idler noting location of all loose parts. Loosen front pair of gearbox mount retaining bolts. Remove rear gearbox mount retaining bolts. Note location of shim washers if present so they can be reinstalled later. This allows gearbox mount to be raised so belts can be inserted and removed between top of deck and gearbox shaft. Once belts are in place on large drive sheave, reinstall and tighten gearbox retaining hardware. Locate rear of gearbox mount at same elevation as it was, before being removed. Reassemble tensioning idler with belt between idler and bracket. Route belts as shown in layout and tension per adjustment procedure.

# MAINTENANCE

## STORAGE

Your rotary mower represents an investment from which you should get the greatest possible benefit. Therefore, when the season is over, the cutter should be thoroughly checked and prepared for storage so that a minimum amount of work will be required to put it back into operation for the next season. The following are suggested storage procedures:

1. Thoroughly clean the cutter.
2. Lubricate the cutter as covered in Maintenance Section.
3. Tighten all bolts and pins to the recommended torque.
4. Check the cutter for worn or damaged parts. Make replacements immediately.
5. Store the cutter in a clean, dry place with the cutter housing resting on blocks.
6. Use spray touch-up enamel where necessary to prevent rust and maintain the appearance of the cutter.



## PROPER TORQUE FOR FASTENERS

The chart lists the correct tightening torque for fasteners. When bolts are to be tightened or replaced, refer to this chart to determine the grade of bolts and the proper torque except when specific torque values are assigned in manual text.

**NOTE:** These values apply to fasteners as received from supplier, dry or when lubricated with normal engine oil. They do not apply if special graphited or molydisulphide greases or other extreme pressure lubricants are used. This applies to both UNF fine and UNC coarse threads.

## RECOMMENDED TORQUE IN FOOT POUNDS UNLESS OTHERWISE STATED IN THE MANUAL \*

Proper Torque values for bolts that are measured in Inches

Bolt Diameter			
	Head Marking No Marks Grade Two	Head Marking Three Lines Grade Five	Head Marking Six Lines Grade Eight
	Pound - Foot Value Dry	Pound - Foot Value Dry	Pound - Foot Value Dry
1/4"	5.5	9	12.5
5/16"	11	18	26
3/8"	20	33	46
7/16"	32	52	75
1/2"	50	80	115
9/16"	70	115	160
5/8"	100	160	225
3/4"	175	280	400
7/8"	175	450	650
1"	270	675	975
1-1/8"	375	850	1350
1-1/4"	530	1200	1950
1-3/8"	700	1550	2550
1-1/2"	930	2100	3350

Proper Torque values for Metric bolts





Bolt Diameter				
	Head Marking 4.8	Head Marking 8.8 or 9.8	Head Marking 10.9	Head Marking 12.9
	Pound - Foot Value Dry	Pound - Foot Value Dry	Pound - Foot Value Dry	Pound - Foot Value Dry
6mm	4.5	8.5	12	14.5
8mm	11	20	30	35
10mm	21	40	60	70
12mm	37	70	105	120
14mm	60	110	165	190
16mm	92	175	255	300
18mm	125	250	350	410
20mm	180	350	500	580
22mm	250	475	675	800
24mm	310	600	850	1000
27mm	450	875	1250	1500
30mm	625	1200	1700	2000

FIGURE 9

\* To get Newton-Meters multiply pound-foot of torque by 1.356

# MAINTENANCE

## BLADE SPINDLE SERVICE INSTRUCTIONS (FIGURE 10)

### DISASSEMBLY

1. Remove adjusting nut #3.
2. Support spindle housing #2 under flange and drive out shaft assembly #1.

**CAUTION !** Use tube on top end of shaft to protect grease fitting.



3. Remove bearing cups from housing. Remove lower bearing from shaft assembly by inserting punch through hole in shaft hub and drive bearing off shaft. Once bearing has been moved 3/8" - 1/2" up shaft, lay flatbars on either side of the shaft and support across vice..or other convenient means. Remove bearing by driving as described in step #2.
4. Clean all parts and reassemble with new parts can proceed.

### ASSEMBLY

1. Press bearing cups in spindle housing.
2. Insert bearing cone in bottom of housing and press in bottom seal #6, flush with bottom of housing.
3. Insert shaft assembly #1 through bottom seal and bearing. Press or lightly drive shaft until it bottom against bearing.
4. Turn spindle over and sit on blade mount washer. Install top bearing and seal. NOTE: Direction of seal lip on top side.
5. Install top adjusting nut #3. Adjust nut to give bearing end play of .002" - .006". Apply Loctite 242 to nut.
6. Grease spindle, until grease is forced out top seal lip.

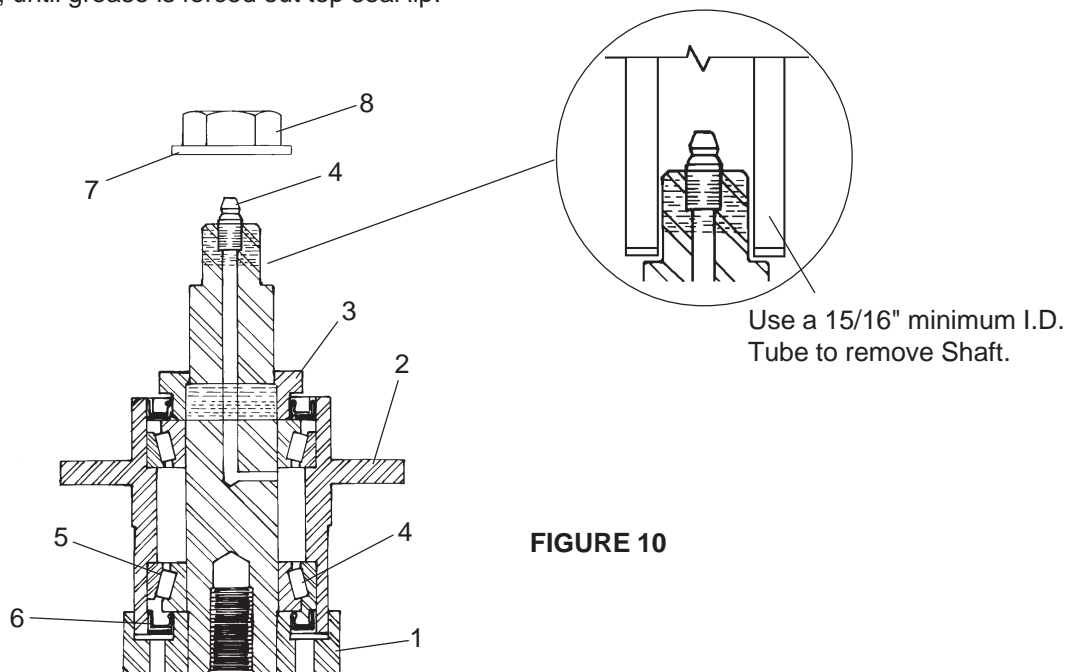

FIGURE 10



# MAINTENANCE

## SERVICING DRIVELINE SHIELDS (Figure 11)

1. Remove locking screw #1.
2. Twist shield tube in relation to cone to align white tab with slot in cone.
3. Pull on shield tube to remove complete shield from assembly.
4. Shield Bearing is split and can be removed by pulling ends apart. Note positioning of bearing before removing.
5. To replace flex cone on shield tube, cut old cone off with knife. Remove chain assembly. Heat collar of the new one in a water bath (approx 80 deg. C or 176 deg. F) and pull cone over end of shield tube. Rotate shield cone to align notches in shield tube end with slots in cone. Reattach chain assembly.
6. To reassembly shield, insert over profile tube, align tabs on shield bearing with slots in shield, insert tabs into slots and twist cone in relation to shield tube so that bearing tabs are located between slots in shield cone. Reinstall locking screw.

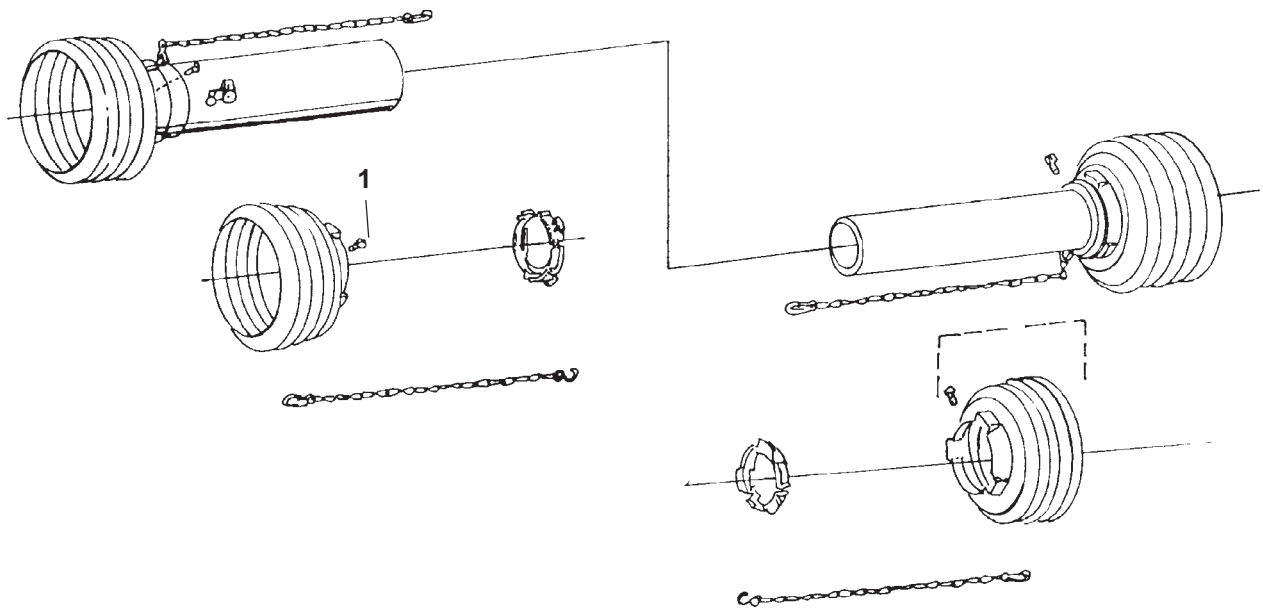

FIGURE 11

# SERVIS-RHINO

## LIMITED WARRANTY

### 1. LIMITED WARRANTIES

- 1.01. Servis-Rhino warrants for one year from the purchase date to the original non-commercial, governmental, or municipal purchaser ("Purchaser") and warrants for six months to the original commercial or industrial purchaser ("Purchaser") that the goods purchased are free from defects in material or workmanship.
- 1.02. Manufacturer will replace for the Purchaser any part or parts found, upon examination at one of its factories, to be defective under normal use and service due to defects in material or workmanship.
- 1.03. This limited warranty does not apply to any part of the goods which has been subjected to improper or abnormal use, negligence, alteration, modification, or accident, damaged due to lack of maintenance or use of wrong fuel, oil, or lubricants, or which has served its normal life. This limited warranty does not apply to any part of any internal combustion engine, or expendable items such as blades, shields, guards, or pneumatic tires except as specifically found in your Operator's Manual.
- 1.04. Except as provided herein, no employee, agent, Dealer, or other person is authorized to give any warranties of any nature on behalf of Manufacturer.

### 2. REMEDIES AND PROCEDURES.

- 2.01. This limited warranty is not effective unless the Purchaser returns the Registration and Warranty Form to Manufacturer within 30 days of purchase.
- 2.02. Purchaser claims must be made in writing to the Authorized Dealer ("Dealer") from whom Purchaser purchased the goods or an approved Authorized Dealer ("Dealer") within 30 days after Purchaser learns of the facts on which the claim is based.
- 2.03. Purchaser is responsible for returning the goods in question to the Dealer.
- 2.04. If after examining the goods and/or parts in question, Manufacturer finds them to be defective under normal use and service due to defects in material or workmanship, Manufacturer will:
  - (a) Repair or replace the defective goods or part(s) or
  - (b) Reimburse Purchaser for the cost of the part(s) and reasonable labor charges (as determined by Manufacturer) if Purchaser paid for the repair and/or replacement prior to the final determination of applicability of the warranty by Manufacturer.The choice of remedy shall belong to Manufacturer.
- 2.05. Purchaser is responsible for any labor charges exceeding a reasonable amount as determined by Manufacturer and for returning the goods to the Dealer, whether or not the claim is approved. Purchaser is responsible for the transportation cost for the goods or part(s) from the Dealer to the designated factory.

### 3. LIMITATION OF LIABILITY.

- 3.01. MANUFACTURER DISCLAIMS ANY EXPRESS (EXCEPT AS SET FORTH HEREIN) AND IMPLIED WARRANTIES WITH RESPECT TO THE GOODS INCLUDING, BUT NOT LIMITED TO, MERCHANTABILITY AND FITNESS FOR A PARTICULAR PURPOSE.
- 3.02. MANUFACTURER MAKES NO WARRANTY AS TO THE DESIGN, CAPABILITY, CAPACITY, OR SUITABILITY FOR USE OF THE GOODS.
- 3.03. EXCEPT AS PROVIDED HEREIN, MANUFACTURER SHALL HAVE NO LIABILITY OR RESPONSIBILITY TO PURCHASER OR ANY OTHER PERSON OR ENTITY WITH RESPECT TO ANY LIABILITY, LOSS, OR DAMAGE CAUSED OR ALLEGED TO BE CAUSED DIRECTLY OR INDIRECTLY BY THE GOODS INCLUDING, BUT NOT LIMITED TO, ANY INDIRECT, SPECIAL, CONSEQUENTIAL, OR INCIDENTAL DAMAGES RESULTING FROM THE USE OR OPERATION OF THE GOODS OR ANY BREACH OF THIS WARRANTY. NOTWITHSTANDING THE ABOVE LIMITATIONS AND WARRANTIES, MANUFACTURER'S LIABILITY HEREUNDER FOR DAMAGES INCURRED BY PURCHASER OR OTHERS SHALL NOT EXCEED THE PRICE OF THE GOODS.
- 3.04. NO ACTION ARISING OUT OF ANY CLAIMED BREACH OF THIS WARRANTY OR TRANSACTIONS UNDER THIS WARRANTY MAY BE BROUGHT MORE THAN TWO (2) YEARS AFTER THE CAUSE OF ACTION HAS OCCURRED.

### 4. MISCELLANEOUS.

- 4.01. Proper Venue for any lawsuits arising from or related to this limited warranty shall be only in Guadalupe County, Texas.
- 4.02. Manufacturer may waive compliance with any of the terms of this limited warranty, but no waiver of any terms shall be deemed to be a waiver of any other term.
- 4.03. If any provision of this limited warranty shall violate any applicable law and is held to be unenforceable, then the invalidity of such provision shall not invalidate any other provisions herein.
- 4.04. Applicable law may provide rights and benefits to purchaser in addition to those provided herein.

### KEEP FOR YOUR RECORDS

ATTENTION: Purchaser should fill in the blanks below for his reference when buying repair parts and/or for proper machine identification when applying for warranty.

Servis-Rhino Implement Model \_\_\_\_\_ Serial Number \_\_\_\_\_

Date Purchased \_\_\_\_\_ Dealer \_\_\_\_\_

ATTENTION:  
READ YOUR OPERATOR'S MANUAL

RHINO®  
1020 S. Sangamon Ave.  
Gibson City, IL 60936  
800-446-5158  
Email: parts@servis-rhino.com





## TO THE OWNER/OPERATOR/DEALER

To keep your implement running efficiently and safely, read your manual thoroughly and follow these directions and the Safety Messages in this Manual. The Table of Contents clearly identifies each section where you can easily find the information you need.

The OCCUPATIONAL SAFETY AND HEALTH ACT (1928.51 Subpart C) makes these minimum safety requirements of tractor operators:

### REQUIRED OF THE OWNER:

1. Provide a Roll-Over-Protective Structure that meets the requirements of this Standard; and
2. Provide Seatbelts that meet the requirements of this paragraph of this Standard and SAE J4C; and
3. Ensure that each employee uses such Seatbelt while the tractor is moving; and
4. Ensure that each employee tightens the Seatbelt sufficiently to confine the employee to the protected area provided by the ROPS.

### REQUIRED OF THE OPERATOR

1. Securely fasten seatbelt if the tractor has a ROPS.
2. Where possible, avoid operating the tractor near ditches, embankments, and holes.
3. Reduce speed when turning, crossing slopes, and on rough, slick, or muddy surfaces.
4. Stay off slopes too steep for safe operation.
5. Watch where you are going - especially at row ends, on roads, and around trees.
6. Do not permit others to ride.
7. Operate the tractor smoothly - no jerky turns, starts, or stops.
8. Hitch only to the drawbar and hitch points recommended by the tractor manufacturer.
9. When the tractor is stopped, set brakes securely and use park lock, if available.

- 
- Keep children away from danger all day, every day...**
  - Equip tractors with rollover protection (ROPS) and keep all machinery guards in place...**
  - Please work, drive, play and live each day with care and concern for your safety and that of your family and fellow citizens.**



WARRANTY REGISTRATION CARD IS ON FILE.  
WILL BE REFUSED UNTIL COMPLETED, SIGNED  
ATTENTION: ANY CLAIM SUBMITTED TO SERVIS-RHINO®

DEALER AND PURCHASER MUST SIGN.  
DAYS OF DELIVERY DATE OF THIS MACHINE.  
FILLED OUT, SIGNED, AND MAILED WITHIN 30  
THIS WARRANTY REGISTRATION MUST BE  
TO PLACE THIS WARRANTY IN EFFECT,  
IMPORTANT!

PLEASE FILL OUT OWNER WARRANTY REGISTRATION INFORMATION  
SIGN, AND DROP LAST COPY IN ANY MAILBOX.  
Please fold (do not tear), tape, and drop in any mailbox.

SERVIS-RHINO®  
1020 S. Sangamon Ave.  
Gibson City, IL 60936-9907















## Free Manuals Download Website

<http://myh66.com>

<http://usermanuals.us>

<http://www.somanuals.com>

<http://www.4manuals.cc>

<http://www.manual-lib.com>

<http://www.404manual.com>

<http://www.luxmanual.com>

<http://aubethermostatmanual.com>

Golf course search by state

<http://golfingnear.com>

Email search by domain

<http://emailbydomain.com>

Auto manuals search

<http://auto.somanuals.com>

TV manuals search

<http://tv.somanuals.com>