

# RICOH

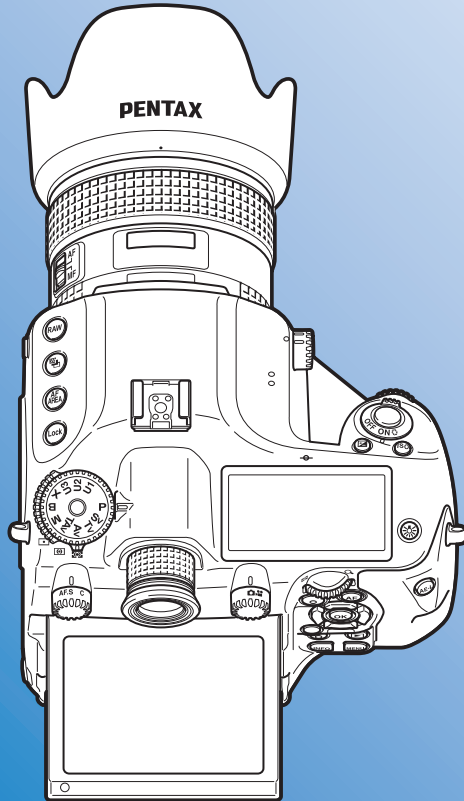

Medium Format Digital SLR Camera

# PENTAX 645Z

## Operating Manual



To ensure the best performance from your camera,  
please read the Operating Manual before using the camera.

Thank you for purchasing our PENTAX 645Z medium format digital SLR camera. Please read this manual before using the camera in order to get the most out of all the features and functions. Keep this manual safe, as it can be a valuable tool in helping you to understand all the camera's capabilities.

### **Lenses you can use**

In general, lenses that can be used with this camera are D FA645 and FA645 lenses, and 645 lenses that have an Aperture **A** (Auto) position. To use any other lens or accessory, see p.28 of this manual.

### **Regarding copyrights**

Images taken with this camera that are for anything other than personal enjoyment cannot be used without permission according to the rights as specified in the Copyright Act. Please take care, as there are cases where limitations are placed on taking pictures even for personal enjoyment during demonstrations, performances or of items on display. Images taken with the purpose of obtaining copyrights also cannot be used outside the scope of use of the copyright as laid out in the Copyright Act, and care should be taken here also.

### **Trademarks**

Microsoft, Windows and Windows Vista are registered trademarks of Microsoft Corporation in the United States of America and other countries. Macintosh, Mac OS, and QuickTime are trademarks of Apple Inc., registered in the U.S. and other countries.

Intel, Intel Core, and Pentium are trademarks of Intel Corporation in the U.S. and/or other countries.

SDXC Logo is a trademark of SD-3C, LLC.

Eye-Fi, the Eye-Fi logo and Eye-Fi *connected* are trademarks of Eye-Fi, Inc.

This product includes DNG technology under license by Adobe Systems Incorporated.

The DNG logo is either a registered trademark or trademark of Adobe Systems Incorporated in the United States and/or other countries.

HDMI, the HDMI logo and High-Definition Multimedia Interface are trademarks or registered trademarks of HDMI Licensing, LLC in the United States and/or other countries.

All other trademarks are the property of their respective owners.

This product supports PRINT Image Matching III. PRINT Image Matching enabled digital still cameras, printers and software help photographers to produce images more faithful to their intentions. Some functions are not available on printers that are not PRINT Image Matching III compliant.

Copyright 2001 Seiko Epson Corporation. All Rights Reserved. PRINT Image Matching is a trademark of Seiko Epson Corporation. The PRINT Image Matching logo is a trademark of Seiko Epson Corporation.

### **AVC Patent Portfolio License**

This product is licensed under the AVC Patent Portfolio License for the personal use of a consumer or other uses in which it does not receive remuneration to (i) encode video in compliance with the AVC standard ("AVC video") and/or (ii) decode AVC video that was encoded by a consumer engaged in a personal activity and/or was obtained from a video provider licensed to provide AVC video. No license is granted or shall be implied for any other use.

Additional information may be obtained from MPEG LA, L.L.C. See <http://www.mpegla.com>.

### **To users of this camera**

- Do not use or store this camera in the vicinity of equipment that generates strong electromagnetic radiation or magnetic fields. Strong static charges or the magnetic fields produced by equipment such as radio transmitters could interfere with the monitor, damage the stored data, or affect the camera's internal circuitry and cause camera misoperation.
- The liquid crystal panel used for the monitor is manufactured using extremely high precision technology. Although the level of functioning pixels is 99.99% or better, you should be aware that 0.01% or fewer of the pixels may not illuminate or may illuminate when they should not. However, this has no effect on the recorded image.
- In this manual, the generic term "computer(s)" refers to either a Windows PC or a Macintosh.
- In this manual, the term "battery(ies)" refers to any type of batteries used for this camera and its accessories.

There is a possibility that the illustrations and the display screen of the monitor in this manual are different from the actual ones.

## FOR USING YOUR CAMERA SAFELY

We have paid close attention to the safety of this camera. When using this camera, we request your special attention regarding items marked with the following symbols.



### Warning

This symbol indicates that ignoring this item could cause serious personal injuries.



### Caution

This symbol indicates that ignoring this item could cause minor or medium personal injuries, or loss of property.

## ABOUT THE CAMERA



### Warning

- Do not disassemble or modify the camera. High voltage areas are present inside the camera, with the risk of electric shock.
- If the camera interior is exposed due to dropping or otherwise damaging the camera, never touch the exposed portion. There is a risk of electric shock.
- Do not aim the camera at the sun or other strong light sources when taking pictures or leave the camera sitting in direct sunlight with the lens cap off. Doing so may cause the camera to malfunction or cause a fire.
- Do not look at the sun or other strong light sources through the lens. Doing so may lead to a loss of eyesight or cause vision to be impaired.
- If any irregularities occur during use, such as smoke or a strange odor, stop use immediately, remove the battery or the AC adapter, and contact your nearest service center. Continued use can cause a fire or electrical shock.



### Caution

- Some portions of the camera heat up during use. There is a risk of low temperature burns when holding such portions for long periods.
- Should the monitor be damaged, be careful of glass fragments. Also, be careful not to allow the liquid crystal to get on your skin or in your eyes or mouth.
- Depending on your individual factors or physical condition, the use of the camera may cause itching, rashes or blisters. In case of any abnormality, stop using the camera and get medical attention immediately.

## About the Battery Charger and AC Adapter



### Warning

- Always use the battery charger and AC adapter exclusively developed for this camera, with the specified power and voltage. Using a battery charger or AC adapter not exclusive to this camera, or using the exclusive battery charger or AC adapter with an unspecified power or voltage can cause a fire, electric shock, or camera breakdown. The specified voltage is 100 - 240V AC.
- Do not disassemble or modify the product. This can cause a fire or electrical shock.
- If the generation of smoke or strange odor from the product or other abnormality occurs, immediately discontinue using and consult your nearest service center. Continued use can cause a fire or electrical shock.
- If water should happen to get inside the product, consult your nearest service center. Continued use can cause a fire or electrical shock.

- If you see a lightning flash or hear thunder during use of the battery charger or AC adapter, unplug the power plug and discontinue using. Continued use can cause damage to the product, fire or electrical shock.
- Wipe off the power plug if it should become covered with dust. Accumulated dust may cause a fire.
- To reduce the risk of hazards, use only CSA/UL certified power supply cord set, cord is Type SPT-2 or heavier, minimum NO.18 AWG copper, one end with a molded-on male attachment plug cap (with a specified NEMA configuration), and the other is provided with a molded-on female connector body (with a specified IEC nonindustrial type configuration) or the equivalent.

### **Caution**

- Do not place or drop heavy objects on or forcefully bend the AC plug cord. Doing so may damage the cord. Should the AC plug cord be damaged, consult your nearest service center.
- Do not touch or short-circuit the terminal area of the AC plug cord while the cord is plugged in.
- Do not handle the power plug with wet hands. This can cause an electric shock.
- Do not drop the product, or subject it to violent impact. This can cause the product to breakdown.
- Do not use the battery charger D-BC90 to charge batteries other than the rechargeable lithium-ion battery D-LI90. Attempting to charge other types of batteries may cause an explosion or heating, or may damage the battery charger.

## About the Battery

### **Warning**

- If any leakage from the battery should come in contact with your eyes, do not rub them. Flush your eyes with clean water and get medical attention immediately.

### **Caution**

- Only use the specified battery with this camera. Use of other batteries may cause an explosion or fire.
- Do not disassemble the battery. Disassembling the battery may cause an explosion or leakage.
- Remove the battery from the camera immediately if it becomes hot or begins to smoke. Be careful not to burn yourself during removal.
- Keep wires, hairpins, and other metal objects away from the + and - contacts of the battery.
- Do not short the battery or dispose of the battery in fire. This can cause an explosion or fire.
- If any leakage from the battery should come in contact with skin or clothing, it may cause irritation to the skin. Wash the affected areas thoroughly with water.
- Precautions for D-LI90 Battery Usage:  
USE SPECIFIED CHARGER ONLY.
  - RISK OF FIRE AND BURNS.
  - DO NOT INCINERATE.
  - DO NOT DISASSEMBLE.
  - DO NOT SHORT CIRCUIT.
  - DO NOT EXPOSE TO HIGH TEMP. (140°F / 60°C)
 SEE MANUAL.

## Keep the Camera and its Accessories out of the Reach of Small Children

### Warning

- Do not place the camera and its accessories within the reach of small children.
  1. If the product falls or is operated accidentally, it may cause serious personal injuries.
  2. Wrapping the strap around a neck may cause suffocation.
  3. To avoid the risk of a small accessory such as the battery or memory cards from being swallowed by mistake, keep them out of the reach of small children. Seek medical attention immediately if an accessory is accidentally swallowed.

## Care to be Taken During Handling

### Before Using Your Camera

- When traveling, take the Worldwide Service Network listing that is included in the package. This will be useful if you experience problems abroad.
- When the camera has not been used for a long time, confirm that it is still working properly, particularly prior to taking important pictures (such as at a wedding or when traveling). Contents of the recording cannot be guaranteed if recording, playback or transferring your data to a computer, etc. is not possible due to a malfunction of your camera or recording media (memory cards), etc.

## About the Battery and Charger

- To keep the battery in optimum condition, avoid storing it in a fully charged state or in high temperatures.
- If the battery is left inserted and the camera is not used for a long time, the battery will over-discharge and shorten the battery's life.
- Charging the battery a day before use or on the day of use is recommended.
- The AC plug cord provided with this camera is developed exclusively for the battery charger D-BC90. Do not use it with other devices.

## Precautions on Carrying and Using Your Camera

- Do not subject the camera to high temperatures or high humidity. Do not leave the camera in a vehicle, as the temperature can get very high.
- Do not subject the camera to strong vibrations, shocks, or pressure. Use a cushion to protect the camera from vibrations of motorcycles, automobiles, or ships.
- The temperature range for camera use is -10°C to 40°C (14°F to 104°F).
- The monitor may appear black at high temperatures, but will return to normal at normal temperatures.
- The monitor may respond more slowly at low temperatures. This is due to liquid crystal properties, and is not a malfunction.
- Sudden temperature changes will cause condensation on the inside and outside of the camera. Place the camera in your bag or a plastic bag, and remove it after temperatures of the camera and surroundings are equalized.

- Avoid contact with garbage, mud, sand, dust, water, toxic gases, or salt. These could cause the camera to breakdown. Wipe the camera to dry off any rain or water drops.
- Do not press on the monitor with excessive force. This could cause it to break or malfunction.
- Be careful not to overtighten the screw in the tripod socket when using a tripod.

## Cleaning Your Camera

- Do not clean the camera with organic solvents such as thinner, alcohol, and benzene.
- Use a lens brush to remove dust accumulated on the lens. Never use a spray blower for cleaning as it may damage the lens.
- Please contact your nearest service center for professional cleaning of the CMOS sensor. (This will involve a fee.)
- Periodic inspections are recommended every one to two years to maintain high performance.

## Storing Your Camera

- Do not store the camera with preservatives or chemicals. Storage in high temperatures and high humidity can cause mold to grow on the camera. Remove the camera from its case and store it in a dry and well-ventilated place.
- Avoid using or storing the camera where it may be exposed to static electricity or electrical interference.
- Avoid using or storing the camera in direct sunlight or in locations where it may be exposed to rapid changes in temperature or to condensation.

## About SD Memory Cards

- The SD Memory Card is equipped with a write-protect switch. Setting the switch to LOCK prevents new data from being recorded on the card, the stored data from being deleted, and the card from being formatted by the camera or computer.

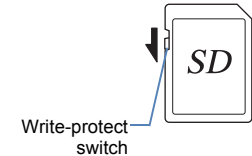

- The SD Memory Card may be hot when removing the card immediately after using the camera.
- Do not remove the SD Memory Card or turn off the power while the card is being accessed. This may cause the data to be lost or the card to be damaged.
- Do not bend the SD Memory Card or subject it to violent impact. Keep it away from water and store away from high temperatures.
- Do not remove the SD Memory Card while formatting. The card may be damaged and become unusable.
- Data on the SD Memory Card may be deleted in the following circumstances. We do not accept any liability for data that is deleted if
  1. the SD Memory Card is mishandled by the user.
  2. the SD Memory Card is exposed to static electricity or electrical interference.
  3. the SD Memory Card has not been used for a long time.
  4. the SD Memory Card or the battery is removed while the card is being accessed.
- If the SD Memory Card is not used for a long time, the data on the card may become unreadable. Be sure to regularly make a backup of important data on a computer.
- Format new SD Memory Cards. Also format SD Memory Cards previously used with other cameras.

- Please note that deleting data stored on an SD Memory Card, or formatting an SD Memory Card does not completely erase the original data. Deleted data can sometimes be recovered using commercially available software. If you are going to discard, give away or sell your SD Memory Card, you should ensure that the data on the card is completely deleted or the card itself is destroyed if it contains any personal or sensitive information.
- The data on your SD Memory Card should be managed at your own risk.

## About Eye-Fi Cards

- An SD Memory Card with a built-in wireless LAN (“Eye-Fi card”) can be used with this camera.
- Use of an access point and an Internet connection are required for transferring images via wireless LAN. For details, refer to the Eye-Fi website. (<http://www.eye.fi>)
- Update your Eye-Fi card to the latest firmware before using it.
- Set [Action Mode] of [Wireless Memory Card] to [OFF], or do not use an Eye-Fi card in a location where the use of wireless LAN devices is restricted or prohibited, such as airplanes.
- Eye-Fi cards can be used only in the country in which the card was purchased. Please observe all local laws governing the Eye-Fi card usage.
- This camera features a function to enable/disable the communication function of the Eye-Fi card, however, we do not guarantee the operability of all Eye-Fi card functions.
- Refer to the Eye-Fi card manual for details on how to use the card.
- Please contact the Eye-Fi card manufacturer regarding any malfunctions or problems concerning Eye-Fi cards.

# Provided Manuals

This camera comes with two manuals: “Operating Manual” (this book) and “Menu Reference”. Use these as needed.

## Operating Manual

Describes the necessary preparations before use and the basic operations of your camera. The “Operating Manual” contains pages 1 to 107.

## Menu Reference

Describes the functions that can be set when  is pressed and the product specifications. After you read the “Operating Manual” and become familiar with the basic operations of your camera, you can carry the “Menu Reference” with you as a handy reference guide. The “Menu Reference” contains pages R1 to R57.

The following symbols indicate reference page numbers with related information.

 Refer to another location within the same document.

 Refer to a location in the other document.

# Operating Manual Contents

FOR USING YOUR CAMERA SAFELY .....	1
Care to be Taken During Handling .....	3
<b>Provided Manuals .....</b>	<b>5</b>
<b>1 Before Using Your Camera .....</b>	<b>9</b>
<b>Checking the Contents of the Package.....</b>	<b>10</b>
<b>Names and Functions of Working Parts .....</b>	<b>11</b>
Operating Controls.....	12
Adjusting the Angle of the Monitor.....	14
<b>Display Indicators .....</b>	<b>15</b>
Monitor .....	15
Viewfinder.....	22
LCD Panel .....	23
Electronic Level .....	23
<b>2 Getting Started .....</b>	<b>25</b>
<b>Attaching the Strap.....</b>	<b>26</b>
<b>Attaching a Lens .....</b>	<b>26</b>
Lens Compatibility Chart.....	28
<b>Using the Battery and Charger .....</b>	<b>30</b>
Charging the Battery.....	30
Inserting/Removing the Battery .....	30
Using the AC Adapter .....	32
<b>Inserting a Memory Card .....</b>	<b>33</b>
<b>Power .....</b>	<b>34</b>
<b>Initial Settings .....</b>	<b>34</b>
Language Setting.....	34
Date Adjustment .....	35
Formatting a Memory Card.....	36

<b>Diopter Adjustment.....</b>	<b>37</b>
Attaching the Large Eyecup .....	37
<b>Testing Your Camera .....</b>	<b>38</b>
Shooting .....	38
Reviewing Images .....	39
<b>How to Change Function Settings.....</b>	<b>40</b>
Using the Direct Keys.....	41
Using the Control Panel .....	41
Using the Menus .....	42

## 3 Shooting Functions 43

<b>Focusing .....</b>	<b>44</b>
Selecting the Focus Mode.....	44
<b>Exposure Setting.....</b>	<b>47</b>
Selecting the Metering Mode.....	47
Setting the Sensitivity .....	47
Changing the Exposure Mode.....	48
AE Lock .....	50
<b>Movie Recording .....</b>	<b>51</b>
Playing Back Movies .....	52
<b>White Balance.....</b>	<b>53</b>
Manual White Balance .....	54
Color Temperature .....	55
<b>Drive Mode.....</b>	<b>56</b>
Continuous Shooting .....	56
Self-timer .....	57
Remote Control .....	57
Multi-exposure .....	58
Interval Shooting .....	59
Interval Composite .....	60
Interval Movie Record .....	61
Exposure Bracketing .....	62
Mirror Lock-up Shooting .....	63



<b>Flash Mode</b> .....	<b>64</b>
Attaching a Flash .....	64
Setting the Flash Mode .....	65
Flash Compatibility Chart .....	66
<b>Preview</b> .....	<b>67</b>
Setting the Preview Method .....	67
<b>Custom Image</b> .....	<b>68</b>
Saving the Settings of a Captured Image .....	69

## 4 Playback and Processing Functions

71

<b>Setting the Playback Functions</b> .....	<b>72</b>
<b>Displaying a Single Image</b> .....	<b>73</b>
Deleting Images One by One .....	73
Zoom Display .....	73
<b>Changing the Playback Method</b> .....	<b>74</b>
Multi-image Display .....	74
Folder Display .....	75
Calendar Filmstrip Display .....	75
Slideshow .....	76
Image Rotation .....	76
<b>Editing and Processing Images</b> .....	<b>77</b>
Image Copy .....	77
Resize/Cropping .....	77
Color Moiré Correction .....	78
Digital Filter .....	79
Movie Edit .....	81
RAW Development .....	82
<b>Protecting Images</b> .....	<b>83</b>
<b>Connecting the Camera to an AV Device</b> .....	<b>84</b>

## 5 Using a Computer 85

<b>Connecting to a Computer</b> .....	<b>86</b>
System Requirements .....	86
Connecting the Camera to a Computer .....	87
<b>Using the Provided Software</b> .....	<b>88</b>
Installing the Software .....	88
Digital Camera Utility 5 Screen .....	90

## 6 Appendix 93

<b>Optional Accessories</b> .....	<b>94</b>
<b>Error Messages</b> .....	<b>97</b>
<b>Troubleshooting</b> .....	<b>98</b>
<b>Index</b> .....	<b>100</b>
<b>WARRANTY POLICY</b> .....	<b>105</b>

### **Regarding User Registration**

In order to better serve you, we request that you complete the user registration, which can be found on the CD-ROM supplied with the camera (p.91) or on our website.

Thank you for your cooperation.

# 1

## Before Using Your Camera

---

Checking the Contents of the Package .....	10
Names and Functions of Working Parts .....	11
Display Indicators .....	15

# Checking the Contents of the Package

The following accessories are packaged with this camera.  
Check that all accessories are included before using your camera.



Hot shoe cover Fk  
(Installed on camera)



Sync socket 2P cap  
(Installed on camera)

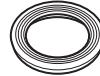

Standard eyecup  
(Installed on camera)



Large eyecup 645  
O-EC107

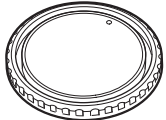

Body mount cap 645  
(Installed on camera)



Triangular ring and protective cover  
(Installed on camera)

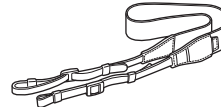

Strap  
O-ST150



Rechargeable Lithium-ion Battery  
D-LI90

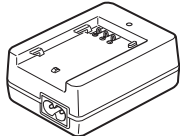

Battery charger  
D-BC90



AC plug cord

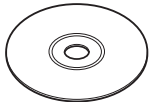

Software (CD-ROM)  
S-SW150

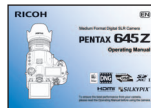

Operating Manual (this manual)



Menu Reference

# Names and Functions of Working Parts

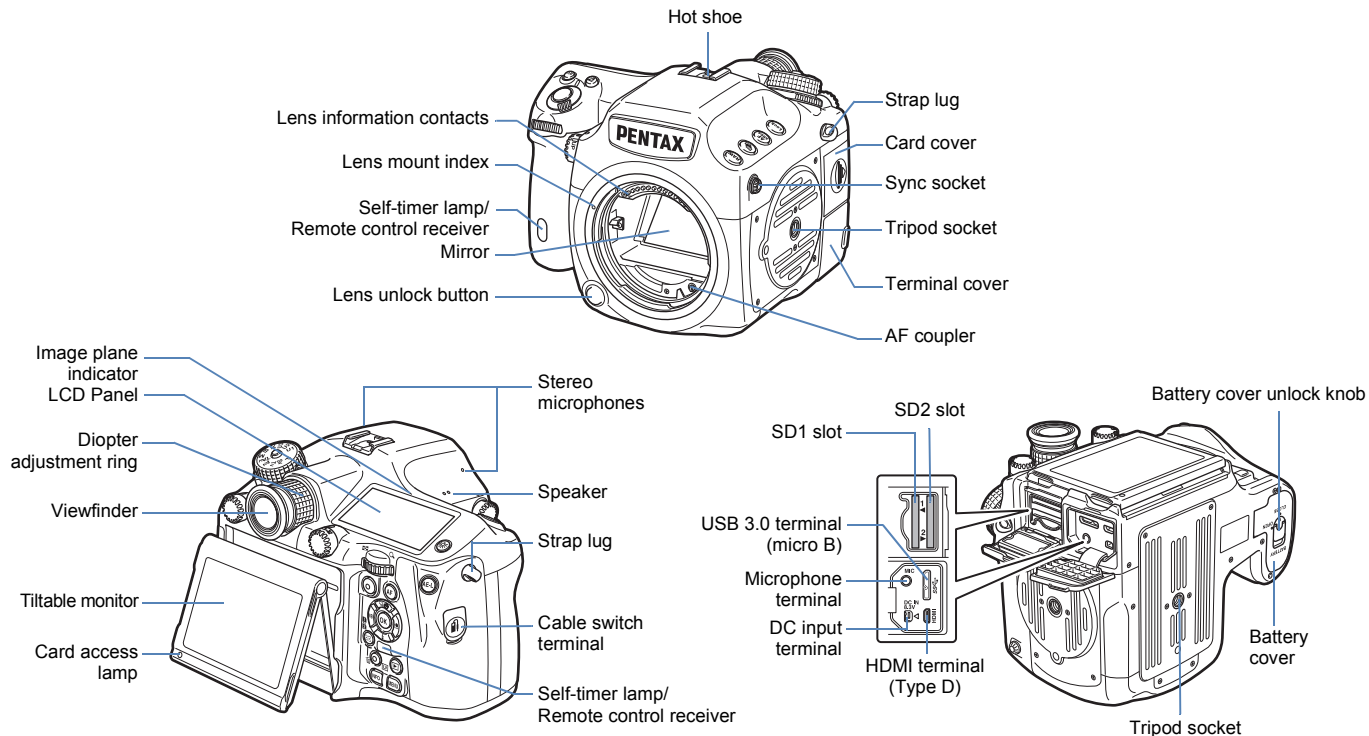

\* The front and rear views show the camera with the Hot shoe cover Fk removed.

## Caution

- Although the angle of the tiltable monitor can be changed (raised or lowered), the monitor cannot be moved in the left/right direction. Do not twist or apply strong force to the movable section, or hit the viewfinder part with the monitor. Always return to its original position when not in use.
- Be sure to close the terminal cover correctly to keep out dust and moisture.

## Operating Controls

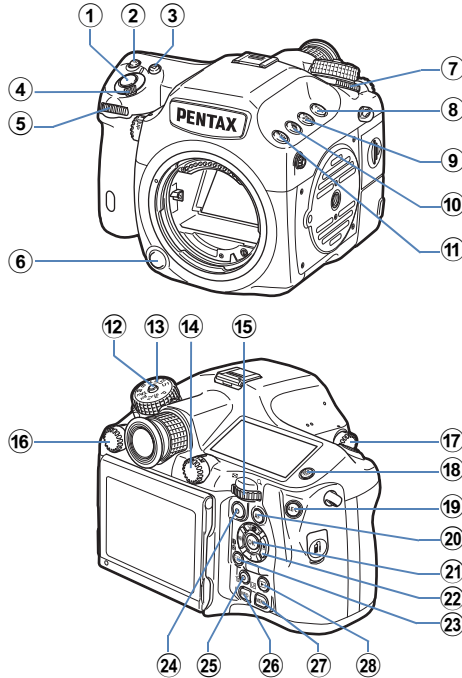

### ① Shutter release button

Press to capture images. (p.38)  
In playback mode, press halfway to switch to capture mode.

### ② ISO button (ISO)

Press to change the ISO sensitivity. (p.47)

### ③ EV Compensation button (☒)

Press to change the exposure compensation value. (p.50)

### ④ Main switch

Move to turn the power on/off or to preview. (p.34, p.67)

### ⑤ Front e-dial (☀)

Changes the values for camera settings such as exposure. (p.49)  
You can change the menu category when a menu screen is displayed. (p.42)

In playback mode, use this to select a different image. (p.39)

### ⑥ Lens unlock button

Press to detach the lens on the camera. (p.26)

### ⑦ Metering mode switching dial

Changes the metering mode. (p.47)

### ⑧ Lock button (Lock)

Temporarily disables e-dial and button operations to prevent misoperation. (📖 p.R43)

### ⑨ AF area button (AF AREA)

Press to change the AF point. (p.45)

### ⑩ Exposure Bracketing button (☰)

Sets exposure bracketing. (p.62)

### ⑪ RAW/Fx button (RAW)

You can assign a function to this button. (📖 p.R20)

### ⑫ Mode dial lock button

















Press to allow the mode dial to be turned. (p.49)

### ⑬ Mode dial





Changes the exposure mode. (p.49)

### ⑭ Stills/Movie switching dial

Switches between 📷 (Still capture) mode and 🎬 (Movie recording) mode. (p.38)

- 15 Rear e-dial** (  )  
Changes the values for camera settings such as exposure. (p.49)  
You can change the menu tabs when a menu screen is displayed. (p.42)  
You can change the camera settings when the control panel is displayed. (p.41)  
In playback mode, use this to magnify an image or display multiple images at the same time. (p.73, p.74)
- 16 AF mode switching dial**  
Switches between the autofocus modes (**AFS/C**). (p.44)
- 17 Mirror Up dial**  
Enables shooting with the mirror raised up. (p.63)
- 18 Illumination button** (  )  
Illuminates the LCD panel. (p.23)
- 19 AE Lock button** (  )  
Locks the exposure value before shooting. (p.50)  
In playback mode, the JPEG image that was just taken is also saved in RAW format. (p.39)
- 20 AF button** (  )  
Available for adjusting focus, instead of pressing the shutter release button halfway. (p.44)
- 21 OK button** (  )  
When a menu or the control panel is displayed, press this button to confirm the selected item.
- 22 Four-way controller** (  )  
Displays the Drive Mode, Flash Mode, White Balance or Custom Image setup menu. (p.41)  
When a menu or the control panel is displayed, use this to move the cursor or change the item to set.  
Press  in single image display of the playback mode to display the playback mode palette. (p.72)  
When selecting the area of an image to magnify or to use as a focusing area, you can move the area diagonally by pressing two keys at the same time.
- 23 AF point change/Card slot switching button** (  /  )  
Press this button to enable changing the AF point. (p.45)  
In playback mode, press this button to switch between the memory cards for playback that are inserted in the two slots, SD1 and SD2. (p.39)
- 24 Green button** (  )  
Resets the values being adjusted.  
Switches to ISO AUTO when adjusting the sensitivity. (p.47)
- 25 Live View/REC/Delete button** (  /  /  )  
Displays the Live View image. (p.39)  
Starts/stops recording a movie in  mode. (p.51)  
In playback mode, press to delete images. (p.73)
- 26 INFO button** (  )  
Changes the style of the display on the monitor. (p.15, p.19)
- 27 MENU button** (  )  
Displays a menu. Press this button while the menu is displayed to return to the previous screen. (p.42)
- 28 Playback button** (  )  
Switches to playback mode. Press the button again to switch to capture mode. (p.39)

## Button and Dial Operations

You can operate both a button and e-dial, such as  and  or  and , to change the settings using either of the following methods.

Operation	Confirming the Setting
Turn the dial while pressing the button.	Take your finger off the button.
Press the button, take your finger off the button, and then turn the dial.	Press the button again or wait until the exposure metering timer goes off.

Hereafter, this Operating Manual explains by using the “Turn the dial while pressing the button” operation.

For the **Lock** and **AF AREA** buttons, only the operation of turning  while pressing the button is available.

## Adjusting the Angle of the Monitor

- 1 Hold the camera grip with your right hand and hold the top of the monitor with your left hand.

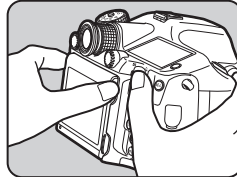

- 2 Slowly lower until it stops.

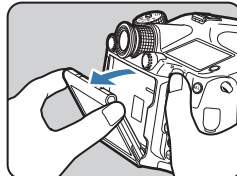

- 3 Hold the bottom of the monitor and lift upward.

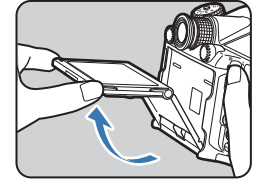

- 4 Adjust the angle.

Perform Step 3 and then Step 2 to retract the monitor.

### Caution

- Do not twist or apply strong force to the movable section.
- Be careful not to hit the viewfinder part with the monitor.



# Display Indicators

## Monitor

The various indicators appear on the monitor depending on the camera settings and shooting conditions.

## Capture Mode

With this camera, you can take pictures while looking through the viewfinder or while viewing the image on the monitor. When using the viewfinder, you can take pictures while checking the status screen displayed on the monitor and the viewfinder. When not using the viewfinder, you can take pictures while viewing the Live View image displayed on the monitor.

The camera is in “standby mode” when it is ready to shoot, such as when the status screen or Live View image is displayed. Press **INFO** in standby mode to display the “control panel” and change settings. (p.17) You can change the type of information displayed in standby mode by pressing **INFO** while the control panel is displayed. (p.18)

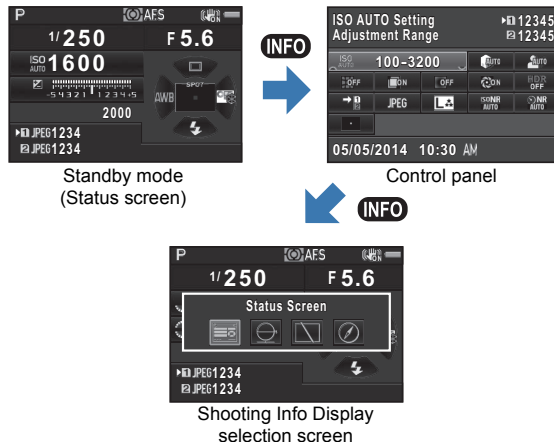

## Status Screen

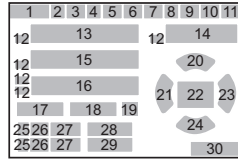

- 1 Exposure Mode (p.48)
- 2 AE Lock (p.50)
- 3 Mirror Up (p.63)
- 4 Copyright Information embedded (📖 p.R33)
- 5 HDR Capture (📖 p.R16)
- 6 Metering mode (p.47)
- 7 Focus Method (p.44)
- 8 Wireless LAN status (📖 p.R34)
- 9 GPS positioning status (📖 p.R18)
- 10 Shake Reduction (p.63)
- 11 Battery level (p.31)
- 12 E-dial guide
- 13 Shutter speed
- 14 Aperture value
- 15 Sensitivity (p.47)
- 16 EV Compensation (p.50)/ Exposure Bracketing (p.62)
- 17 Enable/Disable Controls (📖 p.R43)
- 18 Number of shots during Multi-exposure, Interval Shooting or Interval Composite
- 19 180° Rotation Info (📖 p.R15)
- 20 Drive Mode (p.56)
- 21 White Balance (p.53)
- 22 AF point (p.45)
- 23 Custom Image (p.68)
- 24 Flash Mode (p.65)
- 25 Card slot number
- 26 File Format (📖 p.R15)
- 27 Image storage capacity
- 28 Flash Exposure Compensation (p.65)
- 29 White Balance fine tuning (p.53)
- 30 Operation guide

## Live View

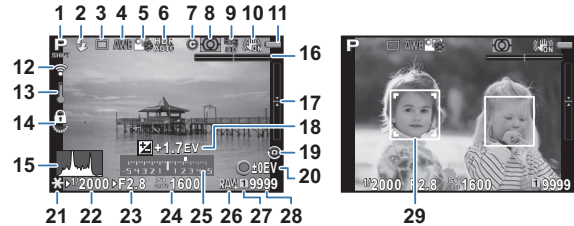

- 1 Exposure Mode (p.48)
- 2 Flash Mode (p.65)
- 3 Drive Mode (p.56)
- 4 White Balance (p.53)
- 5 Custom Image (p.68)
- 6 HDR Capture (📖 p.R16)
- 7 Copyright Information embedded (📖 p.R33)
- 8 Metering mode (p.47)
- 9 GPS positioning status (📖 p.R18)
- 10 Shake Reduction (p.63)/ Movie SR (📖 p.R25)
- 11 Battery level (p.31)
- 12 Wireless LAN status (📖 p.R34)
- 13 Temperature warning
- 14 Enable/Disable Controls (📖 p.R43)
- 15 Histogram
- 16 Electronic Level (horizontal tilt) (p.23)
- 17 Electronic Level (vertical tilt) (p.23)
- 18 EV Compensation (p.50)
- 19 180° Rotation Info (📖 p.R15)
- 20 Operation guide  
Number of shots during Multi-exposure, Interval Shooting or Interval Composite
- 21 AE Lock (p.50)
- 22 Shutter speed
- 23 Aperture value
- 24 Sensitivity (p.47)
- 25 EV bar scale
- 26 File Format (📖 p.R15)
- 27 Card slot number in use
- 28 Image storage capacity
- 29 Face detection frame (when [Contrast AF] is set to [Face Detection]) (p.46)

### Memo

- In [Live View] of the 3 menu, you can change the settings of the items displayed on the monitor during Live View. (📖 p.R19)

## Control panel

### 📷 mode

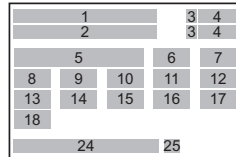
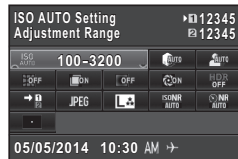

### When shooting with Live View

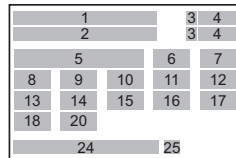
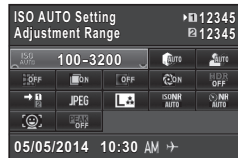

### 👤 mode

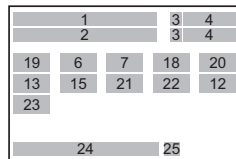
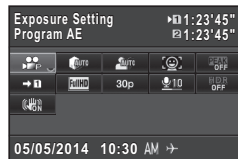

- 1 Function name
- 2 Setting
- 3 Card slot number
- 4 Number of recordable still pictures/movie recordable time
- 5 Sensitivity (p.47)/ ISO AUTO Setting (p. R17)
- 6 Highlight Correction (p. R16)
- 7 Shadow Correction (p. R16)
- 8 Distortion Correction (p. R16)
- 9 Lateral Chromatic Aberration Adjustment (p. R16)
- 10 Peripheral Illumination Correction (p. R16)
- 11 Diffraction Correction (p. R16)
- 12 HDR Capture (p. R16)
- 13 Memory Card Options (p. R15)
- 14 File Format (p. R15)
- 15 JPEG Recorded Pixels and Quality Level (p. R15)/ movie recorded pixels (p. R24)
- 16 High-ISO NR (p. R17)
- 17 Slow Shutter Speed NR (p. R17)
- 18 AF Active Area (p.45)/ Contrast AF (p. R18)
- 19 Exposure Setting (p. R24)
- 20 Focus Peaking (p. R18)
- 21 Framerate (p. R24)
- 22 Recording Sound Level (p. R24)
- 23 Movie SR (p. R25)
- 24 Current date and time
- 25 Destination (p. R28)

### 📌 Memo

- Items that can be selected vary depending on the current camera setup.
- If no operations are made within 1 minute while the control panel is displayed, the camera will return to standby mode.
- You can change the display color of the status screen, control panel and menu cursor in [Display Color] of [LCD Display] in the **1** menu. (p. R30)

## Shooting Info Display

You can change the type of information displayed in standby mode by pressing **INFO** while the control panel is displayed. Use **◀▶** to select the type and press **OK**.

### ● When shooting with the viewfinder

<b>Status Screen</b>	Displays the settings for shooting with the viewfinder. (p.16)	
<b>Electronic Level</b>	<p>Displays the camera angle. A bar scale indicating the camera angle in the horizontal direction appears at the bottom of the screen, and a bar scale indicating the camera angle in the vertical direction appears on the right side. If the camera angle cannot be detected, both ends and the center of the bar scales flash red. Disappears if no operations are made within 1 minute.</p>	 <p>Example: Tilted 1.5° to the left (yellow) No vertical tilt (green)</p>
<b>Display Off</b>	Nothing is displayed on the monitor.	
<b>Electronic Compass</b>	The current latitude, longitude, altitude, direction, and Coordinated Universal Time (UTC) are displayed. Turn the camera off and on again to return to the status screen. Available only when the optional GPS unit is attached to the camera and is operating. (p.96)	

### ● When shooting with Live View

<b>Standard Information Display</b>	The Live View image and the settings for shooting with Live View are displayed. (p.16)
<b>No Information Display</b>	Certain icons, such as those for the Exposure Mode and Drive Mode, are not displayed.

## Vertical Display

When the camera is held vertically, the status screen and control panel are displayed in the vertical position. To not display images in the vertical position, set [Auto Screen Rotation] to off in [LCD Display] of the **1** menu. (p.R30)



## Playback Mode

The captured image and shooting information are displayed in single image display of the playback mode.

Press **INFO** to change the type of information displayed in single image display. Use **◀▶** to select the type and press **OK**.



Single image display  
(Standard Information Display)



Playback Info Display  
selection screen

<b>Standard Information Display</b>	Captured image, file format, exposure parameters, and operation guide indicators are displayed.
<b>Detailed Information Display</b>	Detailed information on how and when the image was taken is displayed (p.20).
<b>Histogram Display</b>	Captured image and brightness histogram are displayed (p.21). Not available during movie playback.
<b>RGB Histogram Display</b>	Captured image and RGB histogram are displayed (p.21). Not available during movie playback.
<b>No Information Display</b>	Only the captured image is displayed.

## Memo

- Press **1/2** to switch between the memory cards inserted in the two slots, SD1 and SD2.
- The display selected in the Playback Info Display selection screen appears in playback mode when the camera is turned off and on again. If [Playback Info Display] is set to off in [Memory] of the **4** menu, the [Standard Information Display] always appears first when the camera is turned on. (p.R22)
- You can display the grid with [Grid Display] of the **1** menu. (p.R26)
- You can set the camera so that the bright (overexposed) areas in the image blink red with [Highlight Alert] of the **1** menu. (p.R26)

## Detailed Information Display

### Still pictures

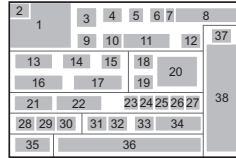

### Movies

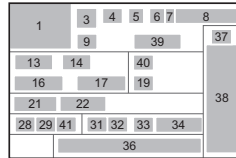

### Page 2

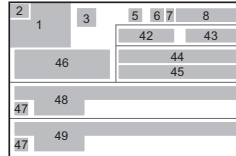
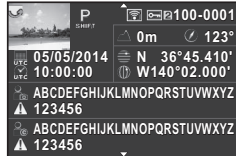

- 1 Captured image
- 2 Rotation Information (📖 p.R41)
- 3 Exposure Mode (p.48)
- 4 Digital Filter (p.79)/  
HDR Capture (📖 p.R16)
- 5 Transferred via Wireless LAN (📖 p.R34)
- 6 Protect setting (p.83)
- 7 Card slot number in use
- 8 Folder number-File number (📖 p.R31, 📖 p.R33)
- 9 Drive Mode (p.56)
- 10 Flash Mode (p.65)
- 11 Flash Exposure  
Compensation (p.65)
- 12 Color Moiré Correction (p.78)
- 13 Shutter speed
- 14 Aperture value
- 15 Exposure Bracketing (p.62)
- 16 Sensitivity (p.47)
- 17 EV Compensation (p.50)
- 18 Focus Method (p.44)
- 19 Metering mode (p.47)
- 20 AF point (p.45)
- 21 White Balance (p.53)
- 22 White Balance fine tuning (p.53)
- 23 Distortion Correction (📖 p.R16)
- 24 Lateral Chromatic Aberration  
Adjustment (📖 p.R16)
- 25 Peripheral Illumination  
Correction (📖 p.R16)
- 26 Diffraction Correction (📖 p.R16)
- 27 Color Fringe Correction (p.82)
- 28 File Format (📖 p.R15)
- 29 JPEG Recorded Pixels (📖 p.R15)/movie recorded  
pixels (📖 p.R24)
- 30 JPEG Quality (📖 p.R15)
- 31 Highlight Correction (📖 p.R16)
- 32 Shadow Correction (📖 p.R16)
- 33 Shake Reduction (p.63)/  
Movie SR (📖 p.R25)
- 34 Lens focal length
- 35 Color Space (📖 p.R41)
- 36 Shooting date and time
- 37 Custom Image setting (p.68)
- 38 Custom Image parameters
- 39 Length of time of the recorded  
movie
- 40 Volume
- 41 Framerate (📖 p.R24)
- 42 Altitude (📖 p.R18)
- 43 Lens direction (📖 p.R18)
- 44 Latitude (📖 p.R18)
- 45 Longitude (📖 p.R18)
- 46 Universal Coordinated Time
- 47 Information tampering  
warning
- 48 Photographer (📖 p.R33)
- 49 Copyright Holder (📖 p.R33)

## Histogram Display/RGB Histogram Display

Use ▲▼ to switch between the Histogram Display and RGB Histogram Display.

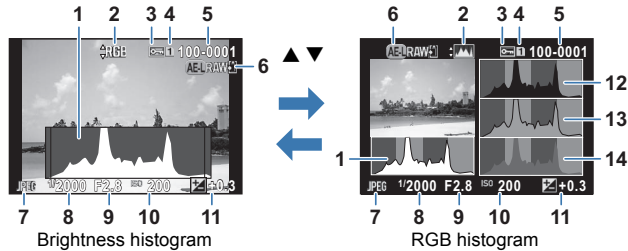

- 1 Histogram (Brightness)
- 2 Switch RGB histogram/  
Brightness histogram
- 3 Protect setting
- 4 Card slot number in use
- 5 Folder number-File number
- 6 Save RAW Data (p.40)
- 7 File Format

- 8 Shutter speed
- 9 Aperture value
- 10 Sensitivity
- 11 EV Compensation
- 12 Histogram (R)
- 13 Histogram (G)
- 14 Histogram (B)

## Viewfinder

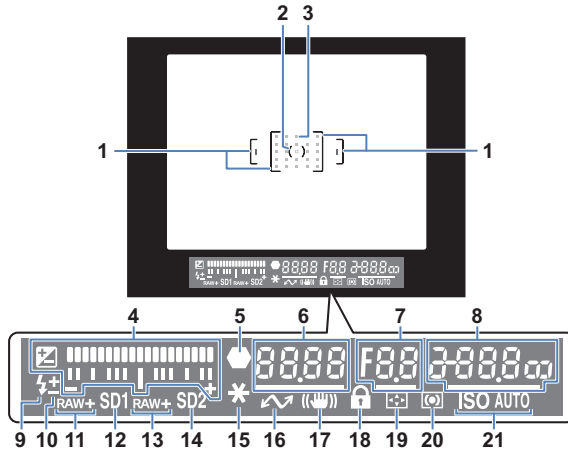

- 1 AF frame
- 2 Spot metering frame (p.47)
- 3 AF point (p.45)
- 4 EV bar scale:  
Displays the exposure compensation value or the difference between the proper and current exposure values in **M** or **X** mode.  
Displays the camera angle when [Electronic Level] is set to on.
- 5 Focus indicator
- 6 Shutter speed
- 7 Aperture value
- 8 Sensitivity (p.47):  
Displays the difference between the proper and current exposure values in **M** or **X** mode when [Electronic Level] is set to on.
- 9 Flash:  
Appears when the flash is available.  
Blinks when the flash is recommended or is being charged.
- 10 Flash Exposure Compensation (p.65)
- 11 SD1 file format (p.R15)

- 12 SD1 slot
- 13 SD2 file format (p.R15)
- 14 SD2 slot
- 15 AE Lock (p.50)
- 16 Tethered shooting
- 17 Shake Reduction (p.63)
- 18 Enable/Disable Controls (p.R43)
- 19 Change AF Point (p.45)
- 20 Metering mode (p.47)
- 21 ISO/ISO AUTO

### ● EV bar scale

Shows the difference between the proper and current exposure values in **M** or **X** mode. If the value exceeds the range of the EV bar scale, the “+” or “-” blinks.

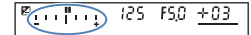

### ● Exposure Warning

When the proper exposure cannot be obtained with the values set in **P**, **Sv**, **Tv**, **Av**, or **TAv** mode, the values beyond the range of automatic adjustment blink.

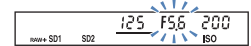

### ● Memo

- The AF point appears in red (Superimpose AF Area) when the shutter release button is pressed halfway. To turn off the red light of the superimposed AF point, set [14. Superimpose AF Area] to off in the **C2** menu. (p.R40)
- The item 16 appears when the camera is connected to a computer using optional tethered shooting software.



## LCD Panel

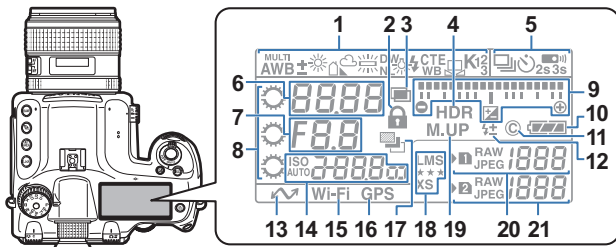

- |  |   |
|--|---|
| <ul style="list-style-type: none"> <li>1 White Balance (p.53)</li> <li>2 Enable/Disable Controls (p.R43)</li> <li>3 Multi-exposure (p.58)</li> <li>4 HDR Capture (p.R16)</li> <li>5 Drive Mode (p.56)</li> <li>6 Shutter speed/Focusing area selection mode (p.45)</li> <li>7 Aperture value</li> <li>8 E-dials</li> <li>9 EV bar scale/Electronic Level/ EV Compensation (p.50)</li> <li>10 Battery level (p.31)</li> <li>11 Copyright Information embedded (p.R33)</li> <li>12 Flash Exposure Compensation (p.65)</li> <li>13 Tethered shooting</li> <li>14 Sensitivity (p.47)/Exposure compensation value (p.50)</li> </ul> | <ul style="list-style-type: none"> <li>15 Wireless LAN connection (p.R34)</li> <li>16 GPS positioning status (p.R18)</li> <li>17 Exposure Bracketing (p.62)</li> <li>18 JPEG Recorded Pixels/JPEG Quality (p.R15)</li> <li>19 Mirror Up (p.63)</li> <li>20 SD1 file format (p.R15)/ Remaining image storage capacity (up to [1999])</li> <li>21 SD2 file format (p.R15)/ Remaining image storage capacity (up to [1999])/USB Connection mode (p.R30)/Sensor Cleaning (p.R37)</li> </ul> <p><b>PcS:</b> MSC mode<br/> <b>PcP:</b> PTP mode<br/> <b>CIn:</b> During sensor cleaning</p> |
|--|---|

## Memo

- Press to illuminate the LCD panel. (p.R20)
- The item 13 appears when the camera is connected to a computer using optional tethered shooting software.

## Electronic Level

You can check whether the camera is tilted horizontally by displaying the electronic level. The electronic level can be displayed on the EV bar scale in the viewfinder and LCD panel, and/or on the Live View screen.

Select whether to display the electronic level in [Electronic Level] of the 3 menu. (p.R19)



When level (at 0°)



When tilted 4.5° to the left



When held vertically and tilted 3° to the right

# MEMO

# 2

## Getting Started

---

<b>Attaching the Strap .....</b>	<b>26</b>
<b>Attaching a Lens .....</b>	<b>26</b>
<b>Using the Battery and Charger .....</b>	<b>30</b>
<b>Inserting a Memory Card .....</b>	<b>33</b>
<b>Power .....</b>	<b>34</b>
<b>Initial Settings .....</b>	<b>34</b>
<b>Diopter Adjustment .....</b>	<b>37</b>
<b>Testing Your Camera .....</b>	<b>38</b>
<b>How to Change Function Settings .....</b>	<b>40</b>

# Attaching the Strap

2

Getting Started

- 1 Pass the end of the strap through the triangular ring.

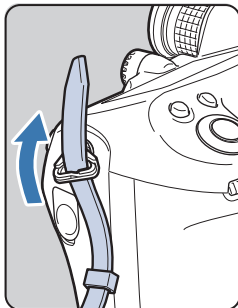

- 2 Secure the end of the strap on the inside of the clasp.

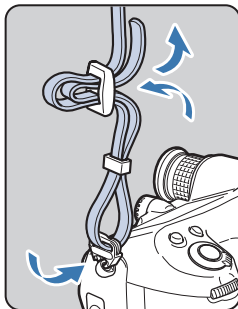

# Attaching a Lens

- 1 Make sure that the camera is turned off.

- 2 Remove the body mount cap (1) and lens mount cap (2).

Hold down the lens unlock button (3) and remove the body mount cap.

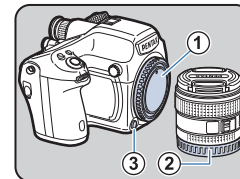

- 3 Align the lens mount index (red dots; 4) on the camera and the lens, and turn the lens clockwise.

Do not press the lens unlock button at this time.

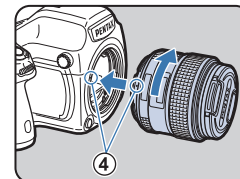

## To remove the lens

Turn the lens counterclockwise while holding down the lens unlock button.

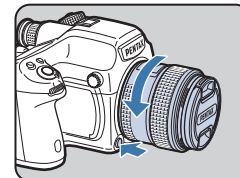

- 4 Remove the front lens cap by pushing the top and bottom portions as indicated in the illustration.**

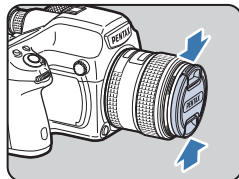

**Caution**

- When attaching or removing the lens, choose an environment that is relatively free of dirt and dust.
- Keep the body mount cap attached on the camera when a lens is not attached.
- Be sure to attach the lens mount cap and lens cap to the lens after removing it from the camera.
- Do not insert your fingers inside the lens mount of the camera or touch the mirror.
- The camera body and lens mount incorporate lens information contacts. Dirt, dust, or corrosion may damage the electrical system. Please contact your nearest service center for professional cleaning.
- We assume no responsibility nor liability for accidents, damages and malfunctions resulting from the use of lenses made by other manufacturers.

# Lens Compatibility Chart

When using the D FA645 lens (for digital cameras), all of the functions of this camera are available. Lenses for our medium format film cameras can also be used with this camera; however, the following restrictions apply. (✓: Available #: Restricted x: Not available)

Function	Lens	A645	FA645	A645/FA645	A645/FA645	67
	Accessories	Lens only		With Rear converter A and Auto extension tube A	With Helicoid extension tube *1	With Adapter 645 for 67 lens
P/Sv/Tv/TAv mode		✓	✓	✓	x	x
Av/M mode		✓	✓	✓	✓*2	✓
Program P-TTL auto flash		✓	✓	✓	x	x
P-TTL auto flash		✓	✓	✓	✓	✓
Automatic change of lighting angle when using AF540FGZ, AF540FGZ II, AF500FTZ, AF360FGZ, AF360FGZ II, or AF330FTZ		x	✓	x	x	x
Display of aperture value in viewfinder at aperture position <b>A</b>		✓	✓	#*4	x	x
Display of aperture guide in viewfinder at a position other than <b>A</b> *3		x	✓	x	x	x
<b>AF</b>		x	✓	x	x	x
Display of focus indicator in viewfinder in <b>MF</b> mode*5		✓*6	✓	✓	✓*6	✓*6
Metering mode switching		✓	✓	✓	#*7	#*7
[Lens Correction] of the  1 menu		x	✓	x	x	x

\*1 This includes all types of helicoid extension tubes and accessories without information contacts.

\*2 Stop-down metering

\*3 Depending on the lens, the aperture ring value and the value displayed in the viewfinder may not match.

\*4 The lens aperture value is displayed when using Auto extension tube A or Rear converter A645 2x.

The display varies when using Rear converter A645 1.4x with a lens other than A★645 300mm F4 or FA★645 300mm F4.

**[Displaying the lens aperture value as is indicated on the lens]**

FA645 300mm F5.6, FA645 400mm F5.6, A★645 600mm F5.6

**[Displaying the maximum effective aperture value when combined with a lens]**

A645 200mm F4, FA645 200mm F4, A★645 300mm F4, FA★645 300mm F4, A645 macro 120mm F4, FA645 macro 120mm F4



**[Displaying the aperture value with the aperture stopped down by two stops]**

FA645 150mm F2.8

\*5 Available only when the lens aperture value without accessories is F5.6 or wider, or when the maximum effective aperture value combined with accessories is F5.6 or wider.

\*6 When using A645 macro 120mm F4, the function may become unreliable when the magnification ratio on the lens is set to between "1" (1:1) and "2" (1:2).

 (Spot) is always selected as the focusing area selection mode.

\*7 The camera uses  (Center-weighted metering) even when  (Multi-segment metering) is selected.

## Using the Lens Shutter of the LS Lens

The PENTAX 64LS lenses have a built-in leaf shutter which allows for high speed flash synchronization.

When using a leaf shutter lens, set the shutter speed ring on the lens to LS.

Note that the following restrictions apply when using a leaf shutter lens.

- The shutter of the lens cannot be used during Live View.
- The camera operates in **M** mode regardless of the exposure mode setting on the camera.
  - The difference from the proper exposure is not displayed.
  - [LS] is displayed for the shutter speed.
  - The proper exposure is not obtained even when **○** is pressed.
- EV Compensation is not available.
  - Setting the shutter speed ring to LS when EV Compensation is set cancels EV Compensation.
- AE Lock is not available.
  - Setting the shutter speed ring to LS when AE Lock is set cancels AE Lock.
- Continuous Shooting, Self-timer (2 sec.), Remote Control (3 sec. delay), and Remote Continuous Shooting of the drive modes are not available.
  - Setting the shutter speed ring to LS when Self-timer (2 sec.) is set switches the shooting mode to Self-timer (12 sec.).
  - Setting the shutter speed ring to LS when Remote Control (3 sec. delay) or Remote Continuous Shooting is set switches the shooting mode to Remote Control (immediate release).
- Mirror Lock-Up Shooting is not available.
  - Setting the shutter speed ring to LS when the mirror is raised lowers the mirror.
- Optical Preview is not available.
  - If the shutter of the lens is charged in advance, Digital Preview can be used. (The same applies when using the Digital Preview to preview the image with White Balance or Custom Image.)

- Interval Shooting, Exposure Bracketing, and HDR Capture are not available.
  - Setting the shutter speed ring to LS when Exposure Bracketing or HDR Capture is set cancels the setting.
  - Setting the shutter speed ring to LS when Interval Shooting is set exits Interval Shooting.
- In Multi-exposure mode, the shutter of the lens must be charged manually for each shot.
- An external flash cannot be used even when connected to the hot shoe. Be sure to use the sync terminal on the lens.
- An external flash cannot be synchronized even when connected to the sync socket on the camera.
- The flash mode setting is not applied to LS shooting.

# Using the Battery and Charger

Use the battery D-LI90 and battery charger D-BC90 exclusively developed for this camera.

## Charging the Battery

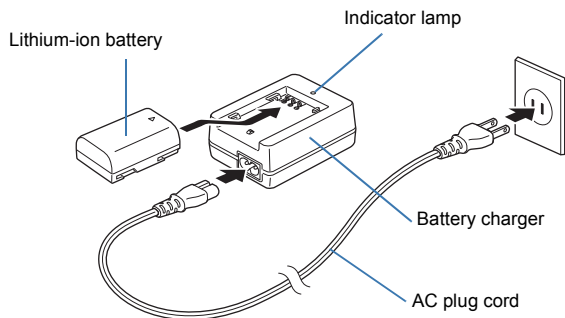

**1** Connect the AC plug cord to the battery charger.

**2** Plug the AC plug cord into the power outlet.

**3** Face the ▲ mark on the battery up, and insert it into the battery charger.

The indicator lamp is lit while charging and turns off when the battery is fully charged.

**4** Remove the battery from the battery charger.

### Caution

- Do not use the battery charger D-BC90 to charge batteries other than D-LI90. Charging other batteries may cause damage or heating.
- Replace the battery with a new one in the following cases:
  - If the indicator lamp blinks or does not light after the battery is inserted correctly
  - If the battery starts to run down more quickly even after being charged (the battery may have reached the end of its service life)

### Memo

- The maximum charging time is approximately 390 minutes (it depends on temperature and remaining battery power). Charge in a location where the temperature is between 0°C and 40°C.

## Inserting/Removing the Battery

### Caution

- Insert the battery correctly. If the battery is inserted incorrectly, it may not be removed.
- Wipe the electrodes of the battery with a soft dry cloth before inserting.
- Do not open the battery cover or remove the battery while the power is on.
- Be careful as the camera or battery may become hot after the camera is used continuously for a long period of time.
- Remove the battery when you will not use the camera for a long time. The battery may leak and damage the camera if left installed during prolonged periods of non-use. If the removed battery will not be used for six months or longer, charge the battery for about 30 minutes before storing it, and after that, recharge the battery every six to twelve months.
- Store the battery in a location where the temperature will remain at or below room temperature. Avoid locations with high temperatures.
- The date and time may be reset if you leave the battery out of the camera for long periods of time. If this happens, set the current date and time again. (📖 p.R28)



## 1 Open the battery cover.

Lift the battery cover unlock knob, turn it towards OPEN to unlock, and then pull the cover open.

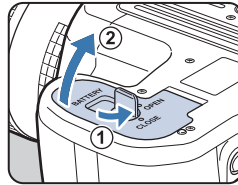

## 2 Face the ▲ mark on the battery towards outside of the camera, and insert the battery until it locks into place.

### To remove the battery

Push the battery lock lever in the direction of ③.

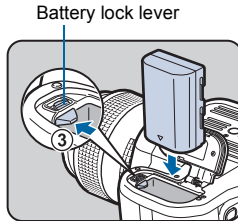

## 3 Close the battery cover.

Turn the battery cover unlock knob towards CLOSE to lock.

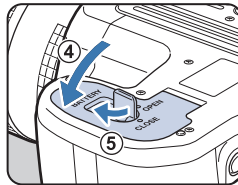

## ● Battery Level Indicator

You can check the remaining battery level with the battery level indicator on the monitor (when the monitor is in standby mode) or on the LCD panel.

Monitor	LCD Panel	Battery Level
(Green)		Battery is full.
(Green)		Battery is one-third empty.
(Yellow)		Battery is two-thirds empty.
(Red)	lit	Battery is almost empty.
[Battery depleted]	blinks	The camera turns off after displaying the message. (The LCD panel indicator continues to blink.)

## 📎 Memo

- The battery level may not be displayed properly if the camera is used at low temperatures or when performing Continuous Shooting for a long time.
- Battery performance temporarily decreases as the temperature decreases. When using the camera in cold climates, have extra batteries at hand and keep them warm in your pocket. Battery performance will return to normal at room temperature.
- Have extra batteries ready when traveling overseas, or taking a lot of pictures.
- Use the optional AC adapter kit when using the camera for a prolonged period. (p.32)
- The battery level is not displayed when using the AC adapter.

## Using the AC Adapter

We recommend using the optional AC adapter kit K-AC132 when using the monitor for a long time or when connecting to the camera to a computer or AV device.

**1** Make sure that the camera is turned off, and open the terminal cover.

**2** Align the ▲ marks on the DC terminal of the AC adapter and DC input terminal of the camera, and connect.

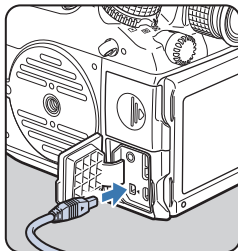

**3** Connect the AC adapter to the AC plug cord, and plug the cord into the power outlet.

### ⚠ Caution

- Make sure that the camera is turned off before connecting or disconnecting the AC adapter.
- Make sure that connections are secure between the terminals. The memory card or data may be corrupted if the connection to the power supply is lost while the card is being accessed.
- The battery in the camera does not charge when connected to the AC adapter.
- Be sure to read the manual of the AC adapter kit before using the AC adapter.

# Inserting a Memory Card

The following memory cards can be used with this camera.

- SD Memory Card, SDHC Memory Card, and SDXC Memory Card
- Eye-Fi card
- Flucard compatible with this camera

In this manual, these cards are referred to as memory cards. Ideally you should use a high-speed, large-capacity memory card.

## ⚠ Caution

- A memory card must be formatted with this camera before use. (🔗 “Formatting a Memory Card” p.36)

**1** Make sure that the camera is turned off.

**2** Slide the card cover in the direction of ①.

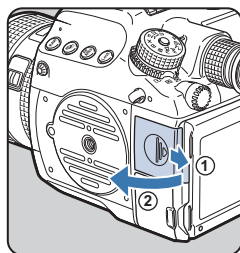

**3** Insert the card all the way into the memory card slot with the memory card label facing toward the monitor.

Insert a memory card into one or both of the SD1 and SD2 slots.

To use an Eye-Fi card or a Flucard, insert the card in the SD2 slot.

**To remove the memory card**

Push the card in again.

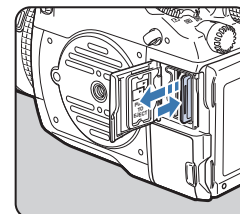
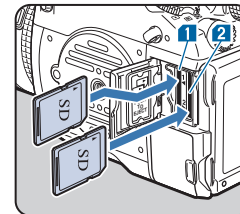

**4** Close the card cover, and slide it in the opposite direction of ①.

## ⚠ Caution

- Be sure to fully close the card cover. The camera will not turn on if the card cover is open.
- Do not turn off the power or remove the memory card while the card access lamp is lit.
- Use a high-speed memory card when recording movies. If the write speed cannot keep up with the recording speed, the writing may stop during recording.

## 📎 Memo

- For details on how the data is recorded when two memory cards are inserted, refer to “Memory Card Options” (📖 p.R15).
- When using an Eye-Fi card or a Flucard, refer to “Wireless Memory Card” (📖 p.R34).



# Power

## 1 Turn the main switch to [ON].

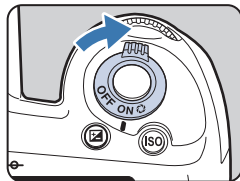
The first time the camera is turned on after purchase, the [Language/言語] screen appears.



### Memo

- Always turn the camera off when not in use.
- The power will automatically turn off when you do not perform any operations within a set period of time (Auto Power Off). To reactivate the camera after it turns off automatically, turn it on again, or press the shutter release button or .
- By default, the camera is set to power off automatically after 1 minute of inactivity. You can change the setting in [Auto Power Off] of the  3 menu. ( p.R34)

# Initial Settings

## Language Setting

The first time the camera is turned on after purchase, the [Language/言語] screen appears on the monitor. Follow the procedure below to set the display language and the current date and time.

### 1 Use to select the desired language and press .

The [Initial Setting] screen appears in the selected language.

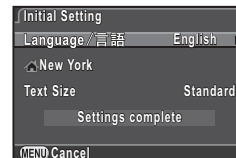

### 2 Press .

The cursor moves to  (Hometown).

If the hometown is set as you desire, proceed to Step 7 on p.35.

### 3 Press .

The [ Hometown] screen appears.

### 4 Use to select a city.

Use  to change the region.

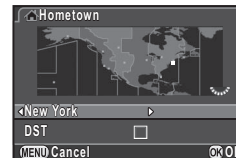

### 5 Press .

The cursor moves to [DST] (daylight saving time).

## 6 Use ◀▶ to select or and press OK.

The camera returns to the [Initial Setting] screen.

## 7 Press ▼.

The cursor moves to [Text Size].

## 8 Press ▶, use ▲▼ to select [Standard] or [Large], and press OK.

Selecting [Large] increases the text size of the selected menu items.



## 9 Press ▼ to select [Settings complete] and press OK.

The [Date Adjustment] screen appears.



## Memo

- You can select from 75 cities for the hometown and destination. (📖 p.R28)
- In this manual, the menu screens hereafter are shown with [Text Size] set to [Standard].
- To change the Language, Hometown or Text Size settings, use the ↶1 menu. (📖 p.R28)

## Date Adjustment

### 1 On the [Date Adjustment] screen, press ▶ and use ▲▼ to select the date format.

Select [mm/dd/yy], [dd/mm/yy] or [yy/mm/dd].

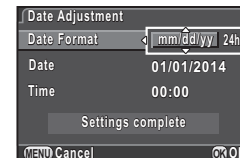

### 2 Press ▶, and use ▲▼ to select 24h or 12h.

### 3 Press ▶.

The frame returns to [Date Format].

### 4 Press ▼ and then ▶.

The frame moves to the month if the date format is set to [mm/dd/yy].

### 5 Use ▲▼ to set the month, day and year.

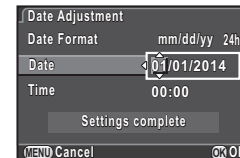

### 6 Set the time in the same manner.

If you select [12h] in Step 2, the camera switches between am and pm depending on the time.



### 7 Select [Settings complete] and press OK.

The status screen is displayed and the camera switches to standby mode.

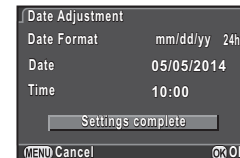
The seconds value is set to 0 seconds when OK is pressed.



## Memo

- Pressing **MENU** while setting the date and time cancels the settings and switches the camera to standby mode. The [Initial Setting] screen or the [Date Adjustment] screen will appear again the next time the power is turned on.
- To change the date and time, use the  1 menu. ( p.R28)

## Formatting a Memory Card

4

A memory card must be formatted with this camera before use.

### 1 Press **MENU**.

The  1 menu appears.

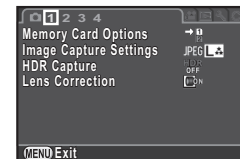

### 2 Turn or to display 4 menu.

### 3 Use to select [Format] and press .

The [Format] screen appears.

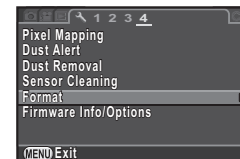

### 4 Use to select the memory card slot to format and press .

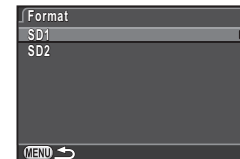

## 5 Press **▲** to select [Format] and press **OK**.

Formatting starts.

When formatting is completed, the **↶4** menu reappears.

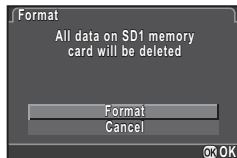

## 6 Press **MENU**.

The camera returns to standby mode.

### Caution

- Do not remove the memory card while formatting. The card may be damaged.
- Formatting deletes all data, both protected and unprotected.

### Memo

- When a memory card is formatted, the volume label "645Z" is assigned to the card. When this camera is connected to a computer, the memory card is recognized as a removable disk with the name "645Z".

# Diopter Adjustment

You can adjust the diopter from approximately  $-3.5$  to  $+2.0$  m<sup>-1</sup>.

- 1 Turn the diopter adjustment ring until the focusing brackets on the focusing screen are in focus while looking through the viewfinder.

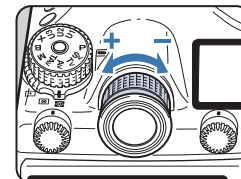

Turn the diopter adjustment ring clockwise for a negative value and counterclockwise for a positive value.

## Attaching the Large Eyecup

Attach the Large Eyecup 645 O-EC107 as needed.

- 1 Slightly stretch the rim of the large eyecup and attach it on the camera, covering over the standard eyecup.

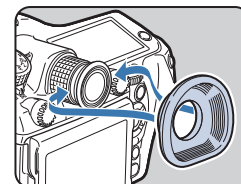

# Testing Your Camera

## Shooting

Take some test pictures to ensure that the camera is functioning properly.

- 1 Turn the camera on.
- 2 Turn the Stills/Movie switching dial to .

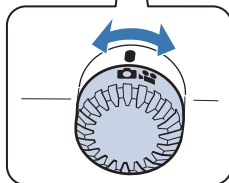
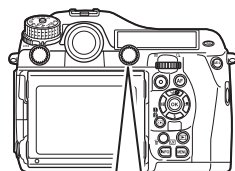

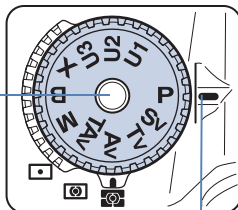

- 3 Turn the mode dial while pressing the mode dial lock button.

Mode dial lock button



Dial indicator

The selected exposure mode is displayed on the monitor (Guide Display).



 Guide Display settings ( p.R30)







- 4 View the subject through the viewfinder and press the shutter release button.

The captured image appears on the monitor (Instant Review).

### Available operations during Instant Review

	Deletes the image.
	Magnifies the image.
	Saves the RAW image (only when a JPEG image was taken and the data remains in the buffer).

### Memo

- You can display the preview image on the monitor and check the depth of field before shooting. (p.67)
- You can set the operation and display settings during Instant Review in [Instant Review] of the 4 menu. ( p.R19)
- You can change the settings for the in-focus beep in [Sound Effects] of the 1 menu. ( p.R29)



## Shooting with Live View

### 1 Press **LV** in Step 4 on p.38.

The Live View image is displayed on the monitor.





### 2 Position the subject inside the AF frame on the monitor and press the shutter release button halfway.



AF frame

#### Available operations during Live View

- OK** Magnifies the image.  
Use  to change the magnification (up to 16×).  
Use  to change the area to magnify.  
Press  to return the display area to the center.  
Press **OK** to return to 1× image display.

- LV** Exits the Live View shooting.

Subsequent steps are the same as shooting with the viewfinder.

## Reviewing Images

You can play back captured images.

### 1 Press .



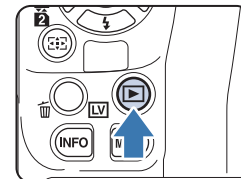









The camera enters playback mode and the most recently captured image (image with the highest file number) is displayed on the monitor (single image display).



### 2 Review the captured image.



#### Available operations

-  /  to the left Displays the previous image.
-  /  to the right Displays the next image.
-  Deletes the image. (p.73)
-  to the right Magnifies the image (up to 16×). (p.73)  
Use  to change the area to magnify.  
Press  to return the display area to the center.  
Press **OK** to return to the entire image display.
-  to the left Switches to the thumbnail display (p.74).
-  Switches between the SD1 card and SD2 card.
-  Saves the RAW image (only when a JPEG image was taken and the data remains in the buffer).
-  Changes the type of information displayed (p.19).

### Memo

- When **AE-L RAW** is displayed on the monitor, the JPEG image that was just taken can also be saved in RAW format (Save RAW Data).
- Refer to “Playback and Processing Functions” (p.71) for details on playback functions.
- Use the provided software “Digital Camera Utility 5” to play back images using a computer. ( “Using a Computer” p.85)

## How to Change Function Settings

---

The camera functions and their settings can be selected and changed by using the following ways.

<b>Direct keys</b>	Press <b>▲▼◀▶</b> in standby mode.
<b>Control panel</b>	Press <b>INFO</b> in standby mode. (indicated with the  icon in this manual)
<b>Menus</b>	Press <b>MENU</b> .

## Using the Direct Keys



You can use the direct keys in standby mode to directly set functions.

▲	Drive Mode	p.56
▼	Flash Mode	p.64
◀	White Balance	p.53
▶	Custom Image	p.68

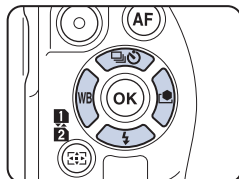

The following explains how to set the flash mode as an example.

### 1 Press ▼ in standby mode.

The Flash Mode setting screen appears.

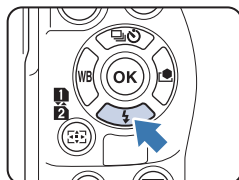

### 2 Use ◀▶ to select a flash mode.

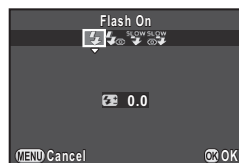

### 3 Press OK.

The camera returns to standby mode.

## Using the Control Panel

INFO

You can set frequently used shooting functions. The following explains how to set [Slow Shutter Speed NR] as an example.

### 1 Press INFO in standby mode.

The control panel appears.

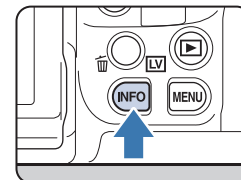

### 2 Use ▲▼◀▶ to select the item you want to change the setting for.

Only items which can be set can be selected.

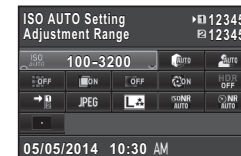

### 3 Use ☀ or ☾ to change settings.

Press OK to display the detailed setting screen for the selected item, and press OK again to confirm the setting change.



### 4 Press MENU.

The camera returns to standby mode.

2

Getting Started

## Using the Menu

MENU

This section explains how to use the menus: [CAMERA] Rec. Mode], [MOVIE] Movie], [PLAYBACK] Playback], [SETUP] Set-up] and [CUSTOM] Custom Setting]. The following explains how to set [Slow Shutter Speed NR] in the CAMERA menu as an example.

### 1 Press MENU in standby mode.

The CAMERA menu appears on the monitor.

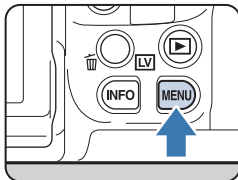

### 2 Press RIGHT or turn the mode dial to the right.

Each time RIGHT is pressed, the menu will change in the following sequence: CAMERA 2, CAMERA 3, CAMERA 4, MOVIE 1 ... CAMERA 1.

When the mode dial is turned to the right, the category will change in the following sequence: CAMERA 1, MOVIE 1, PLAYBACK 1, SETUP 1, CUSTOM 1.

### 3 Use UP/DOWN to select an item and press RIGHT.

Available settings are displayed. Any detailed settings are displayed in the submenu.

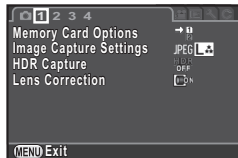

### 4 Use UP/DOWN to select an item and press OK.

Next, set other items.

Press MENU to exit the menu and return to the screen that was displayed before selecting a menu item.

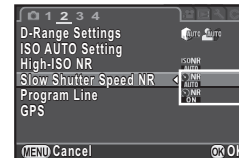

### Caution

- Your settings may not be saved if the camera is turned off improperly (such as by removing the battery while the camera is on).

### Memo

- Press MENU to display the first tab of the proper menu for the camera conditions at that time. To display the menu tab last selected first, set in [23. Save Menu Location] of the CUSTOM menu. (p.R41)
- Settings are returned to their default values with [Reset] of the MOVIE menu. (p.R35) To reset all the settings of the Custom Setting menu (C1-5) to the defaults, use [Reset Custom Functions] of the CUSTOM menu. (p.R43)
- Refer to "Menu Reference" for details on each menu.
  - CAMERA Rec. Mode Menu p.R15
  - MOVIE Movie Menu p.R24
  - PLAYBACK Playback Menu p.R26
  - SETUP Set-up Menu p.R28
  - CUSTOM Custom Setting Menu p.R39

# 3

## Shooting Functions

---

<b>Focusing .....</b>	<b>44</b>
<b>Exposure Setting .....</b>	<b>47</b>
<b>Movie Recording .....</b>	<b>51</b>
<b>White Balance .....</b>	<b>53</b>
<b>Drive Mode .....</b>	<b>56</b>
<b>Flash Mode .....</b>	<b>64</b>
<b>Preview .....</b>	<b>67</b>
<b>Custom Image .....</b>	<b>68</b>

# Focusing

3

Shooting Functions

## Selecting the Focus Mode

- 1 Switch the focus modes between AF and MF on the lens.

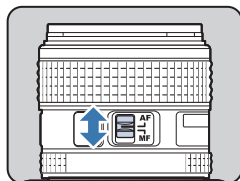

The autofocus method for shooting with the viewfinder differ from that for shooting with Live View.

<b>Shooting with the viewfinder</b>	TTL phase-matching autofocus: Select from <b>AFS</b> or <b>AFC</b> . Set the focusing area using the AF points. (p.45) Faster autofocus performance than contrast detection AF is possible.
<b>Shooting with Live View</b>	Contrast detection AF: Face Detection and Tracking are available. (p.46)

### Memo

- You can use the **AF** button to focus on the subject. The **AF** button operation can be set in [Button Customization] of the **C4** menu. (p.R20)
- You can adjust the AF focus position with [24. AF Fine Adjustment] in the **C4** menu. (p.R42)

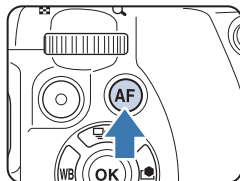

## Setting the AF Mode when Shooting with the Viewfinder

- 1 Use the AF mode switching dial on the camera to select either **AFS** or **C**.

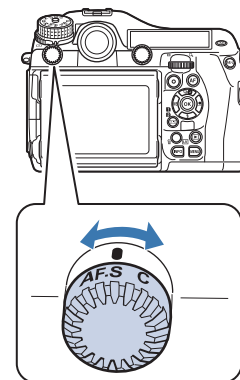

<b>AFS</b> Autofocus/ Single mode	Locks the focus at the position where the subject is in focus.
<b>C (AFC)</b> Autofocus/ Continuous mode	Continuously adjusts the focus to keep the subject in focus. The shutter can be released even if the subject is not in focus. The camera automatically tracks the subject if the subject is determined to be a moving object during focusing.

### Memo

- The settings for AF operations can be set in the **C3** menu. (p.R40)



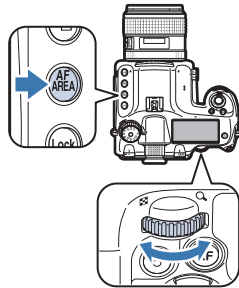

## Selecting the Focusing Area (AF Point)

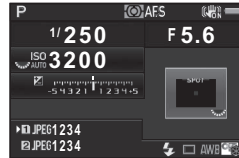

1 Turn  while pressing .





The AF area appears on the status screen and LCD panel.



 <b>Auto (27 AF Points)</b>	Out of the 27 AF points, the camera automatically selects the optimum focusing area. (Default setting)
 <b>Zone Select</b>	Out of the selected 9 AF points, the camera automatically selects the optimum focusing area.
 <b>Select</b>	Sets the focusing area to the user selected point from 27 points.
 <b>Expanded Area AF (S)</b>	Sets the focusing area to the user selected point from 27 points. When the subject happens to move out of the selected focusing area after being focused, 8 peripheral points are used as back-up points. Not available in <b>A.F.S.</b> mode.
 <b>Expanded Area AF (M)</b>	Sets the focusing area to the user selected point from 27 points. When the subject happens to move out of the selected focusing area after being focused, 24 peripheral points are used as back-up points. Not available in <b>A.F.S.</b> mode.

 <b>Expanded Area AF (L)</b>	Sets the focusing area to the user selected point from 27 points. When the subject happens to move out of the selected focusing area after being focused, 26 peripheral points are used as back-up points. Not available in <b>A.F.S.</b> mode.
 <b>Spot</b>	Sets the focusing area to the center of the 27 points.



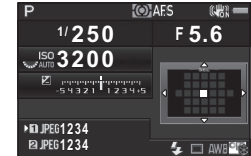

Proceed to Step 2 when a mode other than  or  is selected.

## 2 Select the desired AF point.











The AF point appears in the viewfinder.



### Available operations

	Changes the AF point.
	Returns the AF point to the center.
	Switches the function of the arrow keys (  ) to that for Change AF Point or the direct key operation.

## Memo

- When the AF point can be changed,  appears in the viewfinder.
- You can also set the AF point with [AF Active Area] on the control panel.
- You will hear a beep when the function of  is switched by pressing . You can change the setting with [Sound Effects] in the  1 menu. ( p.R29)
- To enable changing the AF point (disable the direct key operation) any time the focusing area selection mode is set to , , , , or , set in [26. 4-way Controller Options] of the **C4** menu. ( p.R42)
- Some AF points cannot be selected depending on the lens or accessories used. (p.28)

## Setting the AF Mode during Live View

You can select an autofocus mode when shooting with Live View.



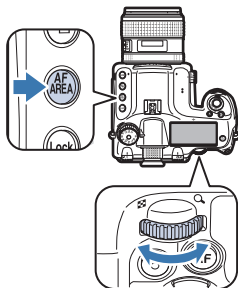

### 1 Turn while pressing

 .



The screen for selecting an autofocus mode appears.



 <b>Face Detection</b>	Detects and tracks faces of people. (Default setting) The main face detection frame for AF and AE is displayed in yellow.
 <b>Tracking</b>	Tracks the subject in focus. The shutter can be released even if the subject is not in focus.
 <b>Multiple AF Points</b>	Sets the focusing area to the desired area. The sensor is divided into 35 areas (7 horizontal by 5 vertical), and you can select a wider or narrower focusing area by using 1, 9, 15, or 21 of those 35 available areas.
 <b>Select</b>	Sets the focusing area by the number of pixels.
 <b>Spot</b>	Sets the focusing area to a limited area at the center.

Proceed to Step 2 if  or  is selected.

### 2 Press .



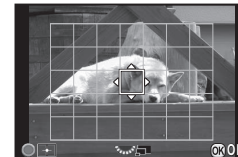

The screen to set the AF area is displayed.

### 3 Select the AF area.

Use the frame that appears on the monitor to change the position and size of the AF area.



#### Available operations

	Changes the position of the AF area.
	Increases/reduces the size of the AF area (when  is selected).
	Returns the AF area to the center.





### 4 Press .

The AF area is set.

### Caution

- When  is selected, the focus lock operation (composition adjustment with the half press of the shutter release button) does not work.

### Memo

- You can also select an autofocus mode for Live View in [Contrast AF] of [Live View] in the 3 menu or [Contrast AF] in the control panel. (  p.R18)
- When [Focus Peaking] of [Live View] in the 3 menu or [Focus Peaking] in the control panel is set to on, the outline of the subject in focus is emphasized and makes it easier to check the focus. (  p.R18)







# Exposure Setting

## Selecting the Metering Mode

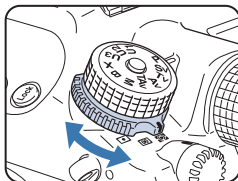
### 1 Turn the metering mode switching dial.

The set metering mode is displayed on the status screen, Live View screen and in the viewfinder.



 <b>Multi-segment</b>	Meters the brightness in multiple different zones of the sensor. In backlit locations, this mode automatically adjusts exposure.
 <b>Center-weighted</b>	Meters the brightness with an emphasis on the center of the sensor. The sensitivity increases at the center and no automatic adjustment is performed even in backlit conditions.
 <b>Spot</b>	Meters the brightness only within a limited area at the center of the sensor. Useful when the subject is small.

### Memo

- You can link the metering point and the AF point. Set in [5. Link AE and AF Point] of the **C1** menu. ([p.R39](#))

### Exposure Metering Timer

Set the exposure metering time with [3. Meter Operating Time] of the **C1** menu. ([p.R39](#))

## Setting the Sensitivity

You can set the sensitivity to [AUTO] or a value in the range equivalent to ISO 100 to 204800 (ISO 100 to 3200 for  mode).

### 1 Turn while pressing **ISO**.

Press  while pressing **ISO** to switch to [AUTO].

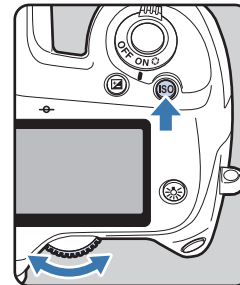



### Memo

- Set the range of automatic sensitivity adjustment with [ISO AUTO Setting] in the **☑2** menu or on the control panel. ([p.R17](#))
- You can set the sensitivity in increments of 1 EV or in accordance with the EV Steps setting for exposure. Set from [2. Sensitivity Steps] of the **C1** menu. ([p.R39](#))
- You can reduce noise at high sensitivity with [High-ISO NR] in the **☑2** menu or on the control panel. ([p.R17](#))
- The framerate for Continuous Shooting may slow down when the sensitivity is high.







## Changing the Exposure Mode

The following are the available exposure modes.

(✓ : Available × : Not available)



Exposure Mode	Function	EV Compensation	Change Shutter Speed	Change Aperture Value	Change Sensitivity
<b>P</b> Program Automatic Exposure	Automatically sets the shutter speed and aperture value according to the program line. You can use  or  to switch between shutter priority and aperture priority.	✓	✓	✓	✓
<b>Sv</b> Sensitivity Priority Automatic Exposure	You can set the desired sensitivity.	✓	×	×	Other than AUTO
<b>Tv</b> Shutter Priority Automatic Exposure	You can set the desired shutter speed.	✓	✓	×	✓
<b>Av</b> Aperture Priority Automatic Exposure	You can set the desired aperture value.	✓	×	✓	✓
<b>TAv</b> Shutter & Aperture Priority Automatic Exposure	Automatically sets the sensitivity according to the set shutter speed and aperture value.	✓	✓	✓	AUTO only
<b>M</b> Manual Exposure	You can set exposure parameters.	✓	✓	✓	Other than AUTO
<b>B</b> Bulb Exposure	Bulb shooting	×	×	✓	Other than AUTO
<b>X</b> Flash X-sync Speed	The shutter speed is locked at 1/125 seconds. Use this when using a flash that does not automatically set the sync speed.	✓	×	✓	Other than AUTO
<b>U1/U2/U3</b> User settings	Lets you capture images with the previously-saved exposure mode and settings.	—	—	—	—

### Memo

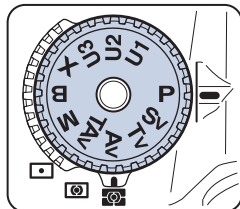

- Set the program line in [Program Line] of the 2 menu. ( p.R18)
- The sync speed of **X** can be changed in [25. Flash Sync Speed] of the 4 menu. ( p.R42)
- Save the settings to **U1**, **U2**, or **U3** in [Save USER Mode] of the 4 menu. ( p.R22)

**1** Turn the mode dial while pressing the mode dial lock button.



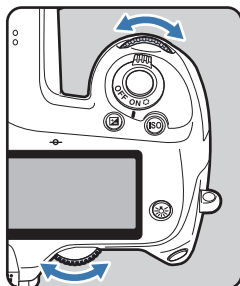

**2** Use  or  to change settings.



 and/or  appear on the status screen next to the setting that is being changed.

The value that can be changed is underlined in the viewfinder.



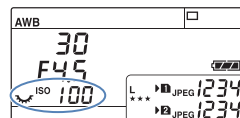
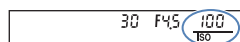
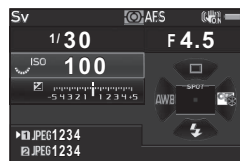

 and/or  appear on the LCD panel for the value that can be changed.



During Live View,  appears for the value that can be changed.



### Memo



- The settings for exposure can be specified in increments of 1/3 EV steps. In [1. EV Steps] of the **C**1 menu, you can change the adjustment steps to 1/2 EV steps. (📖 p.R39)
- A proper exposure may not be obtained with the selected shutter speed and aperture value when the sensitivity is set to a certain sensitivity value.
- In **M** or **X** mode, the difference from the proper exposure is displayed on the EV bar scale while the exposure is adjusted.
- In **B** mode, the drive mode cannot be set to Continuous Shooting, Multi-exposure+Continuous, Interval Shooting, Interval Composite, or Exposure Bracketing.
- For each exposure mode, you can set the camera operation for when  or  is turned or  is pressed. Set in [E-Dial Programming] of the 4 menu. (📖 p.R20)

## EV Compensation

The compensation value can be set between -5 and +5 EV (-2 and +2 EV in  mode).

### 1 Turn while pressing .

 is displayed on the status screen, Live View screen, LCD panel and in the viewfinder during compensation.

Press  while pressing  to return to 0.0.

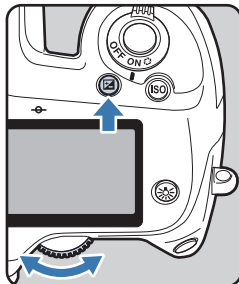

## AE Lock





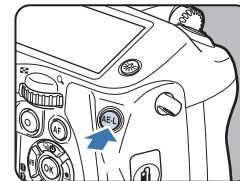

AE Lock is the function that locks the exposure prior to taking the picture.

### 1 Press .

 is displayed on the status screen, Live View screen, LCD panel and in the viewfinder when AE Lock is set.



### Memo

- The exposure remains in memory for twice the amount of the exposure metering timer, even after you take your finger off .
- You will hear a beep when  is pressed. You can change the setting with [Sound Effects] in the  1 menu. ( p.R29)
- When AE Lock is set in **M** mode, you can change the shutter speed and aperture value while maintaining the exposure value.
- AE Lock is not available in **B** or **X** mode.
- When any of the following operations are performed, AE Lock is canceled.
  - When  is pressed again
  - When , **MENU**, or **INFO** is pressed
  - When the mode dial is turned
  - When the lens is changed
  - When the aperture ring of the lens with an aperture **A** position is set to **A** or is switched to a position other than **A**
- When using a zoom lens whose maximum aperture varies depending on the focal length, the shutter speed and aperture value change depending on the zooming position while AE Lock is engaged. However, the exposure value does not change and a picture is taken at the brightness level when AE Lock is set.
- Exposure can be locked when focus is locked. Set in [4. AE-L with AF Locked] of the **C1** menu. ( p.R39)

# Movie Recording

- 1 Turn the Stills/Movie switching dial to .

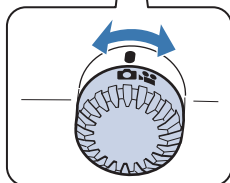
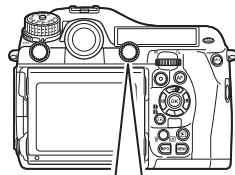

Live View is displayed.

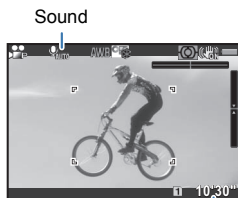

Recordable Time

- 2 Focus on the subject.

In **AF** mode, press the shutter release button halfway.

- 3 Press .

Movie recording starts.  
In the upper left area of the monitor, "REC" blinks and the size of the file being recorded is displayed.

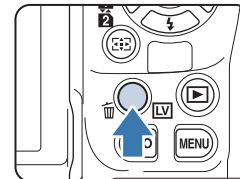





- 4 Press  again.

Movie recording stops.

-  **Caution**

- When recording a movie with sound, the camera operation sounds are also recorded.
- If the internal temperature of the camera becomes high during recording, the recording may be terminated.

-  **Memo**

- Recording can also be started or stopped by pressing the shutter release button fully.
- You can change the movie settings in the  1 menu or from the control panel. (  p.R24) When [Exposure Setting] is set to , , or , you can set the exposure before shooting.
- You can record a movie continuously up to 4 GB or 25 minutes. When the memory card is full, recording stops.

## Using an External Microphone

You can connect a commercially available stereo microphone to the microphone terminal on the camera. Using an external microphone can also help to reduce the possibility of recording camera operation sounds. The following specifications are recommended for external microphones.

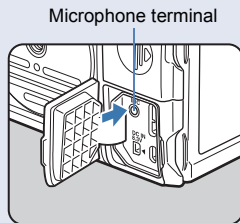

<b>Plug</b>	Stereo mini plug (φ3.5 mm)
<b>Format</b>	Stereo electret condenser
<b>Power</b>	Plug-in Power Method (operating voltage of 2.0 V or lower)
<b>Impedance</b>	2.2 kΩ

If the external microphone is disconnected during recording, no sound will be recorded.

## Playing Back Movies

- 1 Display the movie to play back in single image display of the playback mode.



### Available operations













▲	Plays back/pauses a movie.
▶	Forwards a frame (when paused).
Press and hold ▶	Fast-forwards playback.
◀	Reverses a frame (when paused).
Press and hold ◀	Fast-reverses playback.
▼	Stops playback.
🔊	Adjusts the volume (21 levels).
AE-L	Saves the displayed frame as a JPEG file (when paused).

### Memo



- In [Movie Edit] of the playback mode palette, movies can be divided or selected frames can be deleted. (p.81)

# White Balance

The following settings are available.

Setting		Color Temperature
AWB	AWB Auto White Balance (default setting)	Approx. 4,000 to 8,000K
	 Multi Auto White Balance	
	Daylight	Approx. 5,000K
	Shade	Approx. 8,000K
	Cloudy	Approx. 6,000K
	 Fluorescent - Daylight Color	Approx. 5,700K
	 Fluorescent - Daylight White	Approx. 4,700K
	 Fluorescent - Cool White	Approx. 4,200K
	 Fluorescent - Warm White	Approx. 3,500K
	Tungsten	Approx. 2,850K
	Flash	Approx. 5,400K
<b>CTE</b>	Color Temperature Enhancement	–
	Manual White Balance 1 to 3	–
<b>K</b>	Color Temperature 1 to 3	Approx. 2,500 to 10,000K

## Memo



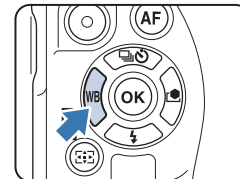

- When  is set, even if various light sources are present at the shooting location, the camera automatically adjusts the white balance according to the light source of each area. (Not available in  mode.)

## 1 Press in standby mode.

The White Balance setting screen appears.



## 2 Select the White Balance.

For AWB, ,  and **K**, press  and then use  to select the White Balance.



### Available operations when shooting with the viewfinder

Main switch to  Uses Digital Preview to preview the background image with the white balance setting applied.

**AE-L** Saves the preview image (only when the image can be saved).

Proceed to Step 5 if you do not need to fine-tune the white balance.

## 3 Press **INFO**.

The fine-tuning setting screen appears.

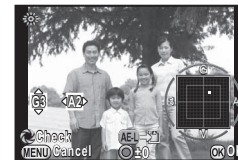

### Available operations

  Adjust: Green-Magenta

  Adjust: Blue-Amber

 Resets the adjustment value to the default setting.

## 4 Press **OK**.

The screen of Step 2 reappears.

# 3

**5 Press  $\text{OK}$ .**

The camera returns to standby mode.

**Memo**

- The settings for the white balance can be set in the **C2** menu. (📖 p.R40)

## Manual White Balance

You can save up to three manual white balance settings.

**1 Select  $\text{WB}$  in Step 2 on p.53 and press  $\blacktriangledown$ .****2 Select from  $\text{WB}1$  to  $\text{WB}3$ .****3 Under the light you wish to measure the white balance of, select a white area as the subject, and press the shutter release button fully.**

The captured image is displayed.

[The operation could not be completed correctly] appears when measuring is unsuccessful. Press  $\text{OK}$  to remeasure the white balance.

**4 Use  $\blacktriangle$   $\blacktriangledown$   $\blacktriangleleft$   $\blacktriangleright$  to specify the measuring range.****5 Press  $\text{OK}$ .**

The White Balance setting screen reappears.

## Saving the White Balance Settings of a Captured Image

You can copy the white balance settings of an image captured with this camera and save them as Manual White Balance.

**1 In single image display of the playback mode, display the image with the white balance settings you want to copy and then press  $\blacktriangledown$ .**

The playback mode palette appears.

**2 Select  $\text{WB}$  (Save as Manual WB) and press  $\text{OK}$ .**

The save confirmation screen appears.

**3 Select the “Manual” number 1, 2 or 3 to save the settings.**

Use  $\text{WB}$  to select a different image.

**4 Press  $\text{OK}$ .**

The white balance settings of the selected image is saved as Manual White Balance and the camera switches to standby mode.

**Caution**

- The fine-tuned white balance value used when shooting is not saved.



## Color Temperature



You can save up to three color temperature settings. (The default setting is [5000K].)

- 1 Select **K** in Step 2 on p.53, and press **▼**.
- 2 Select from **K1** to **K3**.
- 3 Press **INFO**.
- 4 Adjust the color temperature.

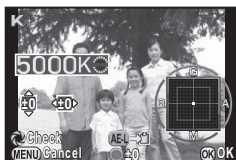
Set the color temperature value within the range from 2500K to 10000K.





### Available operations

	100 Kelvin units
	1000 Kelvin units
	Fine-tunes the color temperature.

### 5 Press **OK**.

The White Balance setting screen reappears.

### Memo

- Select [Mired] in [13. Color Temperature Steps] of the **C2** menu to set the color temperature in mired units. The color temperature can be changed in 20 mired units with , and 100 mired units with . However, figures are converted to and displayed in Kelvin. ( p.R40)

# Drive Mode

You can choose from the following drive modes.

<b>Single Frame Shooting</b> (□)	Normal capture mode
<b>Continuous Shooting</b> (□/□)	Continuously takes pictures while the shutter release button is kept pressed. The number of pictures that can be taken continuously varies according to the shutter speed.
<b>Self-timer</b> (☺/☺)	Releases the shutter about 12 seconds or 2 seconds after the shutter release button is pressed.
<b>Remote Control</b> (☺/☺/☺)	Enables shooting with remote control. Select from [Remote Control], [Remote Control (3 sec. delay)] or [Remote Continuous Shooting].
<b>Multi-exposure</b> (□/□/☺/☺)	Creates a composite picture by taking multiple images and merging them into a single image. Select from [Multi-exposure], [Multi-exposure +Continuous], [Self-timer+Multi-exposure] or [Remote Control+Multi-exposure].
<b>Interval Shooting</b> (☺)	Takes pictures at a set interval from a set time.
<b>Interval Composite</b> (☺)	Takes still images at a set interval and merges them into a single image. Star and moon trails can be captured in one image.
<b>Interval Movie Record</b> (☺)	Takes still images at a set interval from a set time and saves them as a single movie file. Available only in <b>☺</b> mode.

## Memo

- Only **☺** (Remote Control Off), **☺** or **☺** can be selected in **☺** mode.
- The Drive Mode setting is saved even after the power is turned off. If [Drive Mode] is set to off in [Memory] of the **☺**4 menu, the setting returns to Single Frame Shooting when the power is turned off. (p.R22)
- When the drive mode that employs the self-timer or remote control is selected, exposure may be affected by the light entering through the viewfinder. In such a case, use the AE Lock function. (p.50)

## Caution

- There are restrictions on some drive modes when used in combination with some other functions. (p.R44)

## Continuous Shooting

### 1 Press ▲ in standby mode.

The Drive Mode setting screen appears.

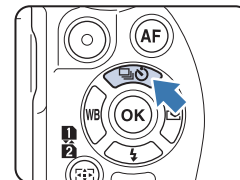

### 2 Select □ and press ▼.

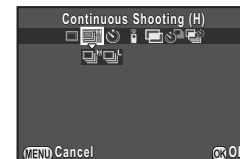

### 3 Select □ or □ and press OK.

The camera returns to standby mode.

## Memo

- When the AF mode is set to **AFS**, the focus position is locked in the first frame.
- The framerate may slow down when the sensitivity is high.

## Self-timer



### 1 Press **▲** in standby mode.

The Drive Mode setting screen appears.

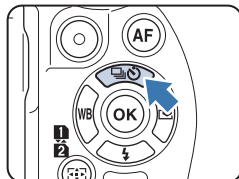

### 2 Select and press **▼**.



### 3 Select or and press **OK**.

The camera returns to standby mode.

### 4 Press the shutter release button halfway, then fully.

The self-timer lamp blinks.

The shutter will be released about 12 seconds or 2 seconds.

## Remote Control



### 1 Press **▲** in standby mode.

The Drive Mode setting screen appears.

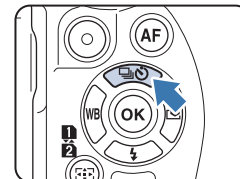

### 2 Select and press **▼**.

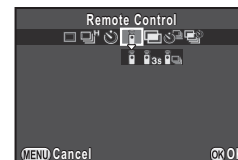

### 3 Select , , or and press **OK**.

The camera returns to standby mode.

The self-timer lamp blinks.

### 4 Press the shutter release button halfway.

### 5 Point the remote control unit towards the remote control receiver on the front or back of the camera, and press the shutter release button on the remote control unit.

#### Memo

- The maximum operating distance of the remote control unit is approx. 4 m from the front of the camera and approx. 2 m from the back of the camera.
- To adjust focus with remote control, set in [19. AF with Remote Control] of the **C3** menu. ([p.R41](#))
- When using the Remote Control Waterproof O-RC1, the autofocus system can be operated with the  button. The **Fn** button cannot be used.

## Multi-exposure



### 1 Press ▲ in standby mode.

The Drive Mode setting screen appears.

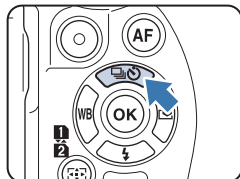

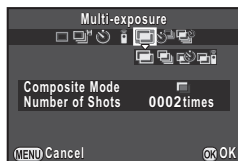

### 2 Select and press ▼.

### 3 Select , , or , and press ▼.



### 4 Select [Composite Mode].

 <b>Average</b>	Creates a composite image with the average exposure.
 <b>Additive</b>	Creates a composite image with the cumulatively added exposure.
 <b>Bright</b>	Creates a composite image that combines only bright parts.

### 5 Specify [Number of Shots].

Select from 2 to 2000 shots.



### 6 Press **OK**.

The camera returns to standby mode.

### 7 Press the shutter release button to start shooting.



Instant Review is displayed.

#### Available operations during Instant Review

	Discards pictures taken up to that point and takes pictures again from the first picture.
<b>MENU</b>	Saves pictures taken up to that point and displays the  menu.

After the set number of pictures are taken, the camera returns to normal capture mode.

### Caution

- Multi-exposure cannot be used with [HDR Capture] in the  1 menu at the same time. The mode set last is used.
- [Lens Correction] in the  1 menu is not available when Multi-exposure is set.

# Interval Shooting



## 1 Press **▲** in standby mode.

The Drive Mode setting screen appears.

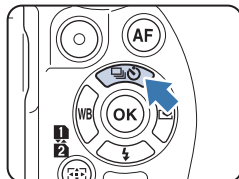

## 2 Select and press **▼**.

## 3 Set the shooting conditions.

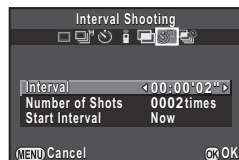

<b>Interval</b>	Select from 2 seconds to 24 hours.
<b>Number of Shots</b>	Select from 2 to 2000 shots.
<b>Start Interval</b>	Select whether to take the first picture now or at a set time. When [Set Time] is selected, set the time at which to start shooting in [Start Time].

## 4 Press **OK** to finish setting.

The camera returns to standby mode.

## 5 Press the shutter release button to start shooting.

When [Start Interval] is set to [Now], the first picture is taken. When set to [Set Time], shooting starts at the set time.

To cancel shooting, press **MENU** in standby mode.

After the set number of pictures are taken, the camera returns to normal capture mode.

## Memo

- A new folder is created when Interval Shooting is performed, and the captured images are saved there. When shooting in a different drive mode after performing Interval Shooting, a new folder will be created again.
- The shortest interval time that can be set for [Interval] is 30 seconds when [HDR Capture] is set in the  1 menu.

## Interval Composite



### 1 Press ▲ in standby mode.

The Drive Mode setting screen appears.

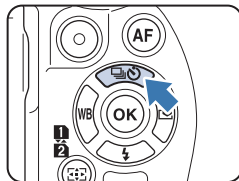

### 2 Select and press ▼.

### 3 Set the shooting conditions.

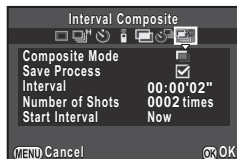

<b>Composite Mode</b>	Select from [Average], [Additive] or [Bright]. (Refer to "Multi-exposure" (p.58).)
<b>Save Process</b>	Select <input checked="" type="checkbox"/> to save the image in the process of composition.
<b>Interval</b>	Select from 2 seconds to 24 hours.
<b>Number of Shots</b>	Select from 2 to 2000 shots.
<b>Start Interval</b>	Select whether to take the first picture now or at a set time. When [Set Time] is selected, set the time at which to start shooting in [Start Time].

### 4 Press **OK** to finish setting.

The camera returns to standby mode.

### 5 Press the shutter release button to start shooting.

When [Start Interval] is set to [Now], the first picture is taken. When set to [Set Time], shooting starts at the set time.

To cancel shooting, press **MENU** in standby mode.

After the set number of pictures are taken, the camera returns to normal capture mode.

### Memo

- When [Save Process] is set to , a new folder is created and the composite image is saved there. When shooting in a different drive mode after performing Interval Composite, a new folder will be created again.
- Mount the camera on a tripod during Interval Composite.

## Interval Movie Record



In mode, you can use [Interval Movie Record] to take still pictures at a set interval from a set time and save them as a single movie file (Motion JPEG, file extension: .AVI).

### 1 Turn the Stills/Movie switching dial to and press **▲**.

The Drive Mode setting screen appears.

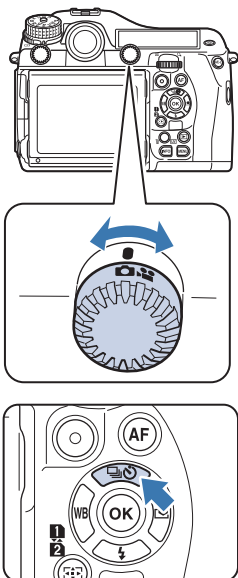

### 2 Select and press **▼**.

### 3 Set the shooting conditions.

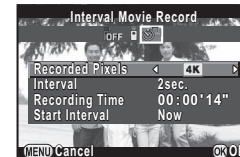

<b>Recorded Pixels</b>	Select from <b>4K</b> , <b>FullHD</b> , or <b>HD</b> .
<b>Interval</b>	Select from 2 sec., 5 sec., 10 sec., 20 sec., 30 sec., 1 min., 5 min., 10 min., 30 min., or 1 hr.
<b>Recording Time</b>	Set the time from the start to the end of recording. Select from 14 seconds to 99 hours. The time that can be set varies depending on the [Interval] setting.
<b>Start Interval</b>	Select whether to take the first picture now or at a set time. When [Set Time] is selected, set the time at which to start shooting in [Start Time].

### 4 Press **OK** to finish setting.

The camera returns to standby mode.

### 5 Press the shutter release button to start shooting.

When [Start Interval] is set to [Now], the first picture is taken. When set to [Set Time], shooting starts at the set time.

Instant Review is displayed, and then the monitor turns off.

After the set number of pictures are taken, the camera returns to standby mode.

### Memo

- The shortest interval time that can be set for [Interval] is 30 seconds when [HDR Capture] is set in the 1 menu.

## Exposure Bracketing



You can use Exposure Bracketing to take 2 (standard exposure and underexposure, or standard exposure and overexposure), 3 or 5 images with different exposure levels.

This function can be used with Continuous Shooting, Self-timer, or Remote Control set by pressing ▲.

### 1 Turn while pressing to set the number of shots.

Check the setting on the LCD panel.

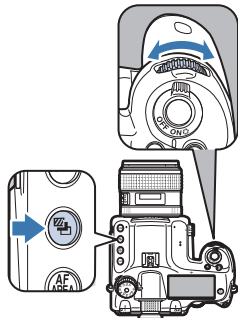

Right (clockwise)      OFF→3→5→2→2→OFF  
 Left (counterclockwise)      OFF→2→2→5→3→OFF

### 2 Turn while pressing to set the bracket value.

EV Steps	Compensation Value
1/3 EV	±0.3, ±0.7, ±1.0, ±1.3, ±1.7, ±2.0
1/2 EV	±0.5, ±1.0, ±1.5, ±2.0

Press ● while pressing  to return to [OFF] and [--].

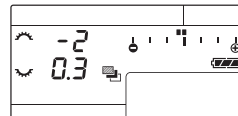

2 images (underexposed) at 0.3 EV

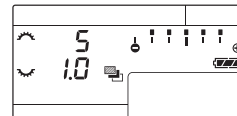

5 images at 1.0 EV

### 3 Press the shutter release button fully.

Select [OFF] in Step 1 to finish shooting with Exposure Bracketing.

#### Memo

- Set the auto bracketing order with [8. Bracketing Order] in the **C2** menu. (📖 p.R40)
- Set the EV step interval with [1. EV Steps] in the **C1** menu. (📖 p.R39)
- Set [9. One-Push Bracketing] in the **C2** menu to shoot all frames with one press of the shutter release button. (📖 p.R40)
- If you take your finger off the shutter release button before shooting of the set number of images is completed, the next bracket setting will remain effective for twice the amount of the exposure metering time.
- You can combine Exposure Bracketing with the P-TTL auto flash to change the flash output continuously. Confirm that the flash unit is fully charged before shooting each frame.

#### Caution

- This function is not available in **B** mode.
- This function cannot be used with Multi-exposure, Interval Shooting, or Interval Composite. The function set last is used.



## Mirror Lock-up Shooting

This raises the mirror.

This function can be used with another drive mode set by pressing ▲.

### 1 Turn the Mirror Up dial.

The camera is ready to raise the mirror.

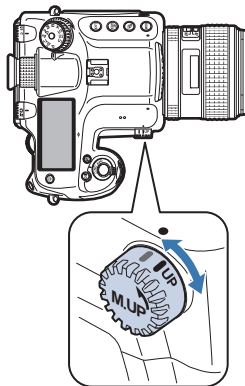

### 2 Press the shutter release button fully.

The mirror is raised.

### 3 Press the shutter release button fully again.

The mirror returns to its original position after an image is taken.

To exit Mirror Lock-up Shooting, return the Mirror Up dial to its original position.

### Memo

- The mirror automatically returns to its original position if 5 minutes elapse after the mirror is raised or the Auto Power Off function is activated. Depending on the shooting conditions, the mirror may return to its original position before 5 minutes elapse.
- To disable the Mirror Up dial operation, set in [27. Mirror Up Operation] of the C4 menu. (p.R42)

### Caution

- Mirror Lock-up Shooting is not available when shooting with Live View. When the mirror is raised, the Live View image is not displayed even if [LV] is pressed.
- Turning the mode dial or adjusting the lens aperture ring when the mirror is raised lowers the mirror.
- The image preview is not available when the mirror is raised.
- The mirror is not raised during Interval Shooting or Interval Composite even when the Mirror Up dial is set to the "UP" position.

### Shake Reduction

The Shake Reduction function is available when a lens with the SR system is used in mode. Refer to the SR-supported lens manual for details on using the function. The Shake Reduction function is automatically turned off when Self-timer, Remote Control, Interval Movie Record, or Mirror Lock-up Shooting is set. In mode, the Shake Reduction function can be activated from [Movie SR] of the 1 menu. (p.R25)

# Flash Mode

3

Shooting Functions

## Attaching a Flash

- 1 Remove the hot shoe cover of the camera.

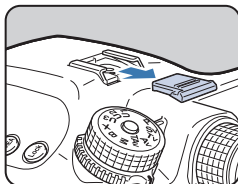

- 2 Attach the flash and turn on the camera.

### Caution

- Do not use high-voltage or high-current external flashes. They may cause the camera to malfunction.
- A flash with reversed polarity (the center of the hot shoe or sync plug has a negative symbol) cannot be used, as this may damage the camera or flash.
- Linked functions do not work.
- To prevent vignetting caused by Trailing Curtain Sync from occurring, it is recommended to take a test shot using a shutter speed one stop slower than the flash sync speed.

## Using a Sync Cord

You can connect a sync cord to the sync socket on the camera.

Sync socket

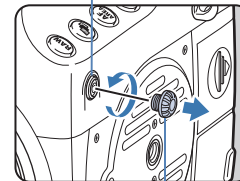

Sync socket 2P cap

### Memo

- The flash connected to the sync socket can be discharged in Modeling Flash or Test Flash mode by pressing . The setting can be changed with [Illumination Button] in [Button Customization] of the 4 menu. ( p.R20)

### Caution

- The contact of the sync socket is not dust-proof or water-resistant. Attach the provided Sync socket 2P cap when not in use.

## Setting the Flash Mode



The following flash modes are available. The flash modes that can be set vary depending on the exposure mode.

Flash Mode	Available Exposure Modes
Flash On	
Flash On+Red-eye Reduction	P, Sv, Tv, Av, TAv, M, B, X
Slow-speed Sync	P, Sv, Av
Slow-speed Sync+Red-eye	P, Sv, Av

### 1 Press ▼ in standby mode.

The screen to set a flash mode appears.

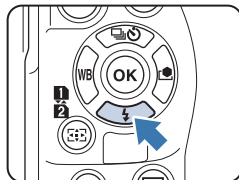

### 2 Select a flash mode.



### 3 To compensate the flash output, press ▼ and then use to adjust the value.

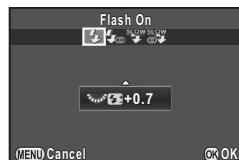

The compensation value varies depending on the setting of [1. EV Steps] (p.R39) in the C1 menu.

EV Steps	Compensation Value
1/3 EV	-2.0, -1.7, -1.3, -1.0, -0.7, -0.3, 0.0, +0.3, +0.7, +1.0
1/2 EV	-2.0, -1.5, -1.0, -0.5, 0.0, +0.5, +1.0

Press to reset the value to 0.0.

### 4 Press .

The camera returns to standby mode.

# Flash Compatibility Chart

The following functions are available when using this camera with our flashes.

(✓: Available ×: Not available)

Function \ Flash	AF540FGZ II AF360FGZ II	AF540FGZ AF360FGZ	AF200FG AF160FC	AF500FTZ AF330FTZ	AF400FTZ AF240FT	AF400T AF280T AF200T	AF140C AF080C	AF200SA	AF200S AF160 AF140
P-TTL auto flash	✓ <sup>*3</sup>	✓ <sup>*3</sup>	✓ <sup>*3</sup>	×	×	×	×	×	×
External auto flash	×	✓	×	×	×	✓	×	✓	✓
Red-eye reduction	✓	✓	✓	×	×	×	×	×	×
Automatic switch of the shutter speed to the flash sync speed after the flash is charged	✓	✓	✓	✓	✓	✓	✓	✓	✓
Setting the aperture value in <b>P</b> or <b>Tv</b> mode	✓	✓	×	×	×	✓ <sup>*4</sup>	✓ <sup>*4</sup>	×	✓ <sup>*5</sup>
Slow-speed Sync flash	✓	✓	✓	✓	✓	✓ <sup>*6</sup>	✓ <sup>*6</sup>	✓	✓ <sup>*5</sup>
Trailing Curtain Sync flash <sup>*1</sup>	✓	✓	×	✓ <sup>*7</sup>	✓ <sup>*7</sup>	×	×	×	×
Contrast-control-sync flash	✓	✓	×	×	×	×	×	×	×
Slave flash	✓	✓	×	✓ <sup>*8</sup>	×	×	×	×	×
Flash Exposure Compensation	✓	✓	✓	×	×	×	×	×	×
AF Assist Light	✓	✓	×	✓	✓	×	×	×	×
Discharging a flash multiple times	✓	×	×	✓ <sup>*8</sup>	×	×	×	×	×
High-speed sync flash Wireless flash <sup>*2</sup>	✓	×	×	×	×	×	×	×	×

\*1 There is a limit to the available shutter speeds.

\*2 Two or more compatible flash units are required.

\*3 Available only when using A645, A★645, FA645, FA★645, or D FA645 lenses.

\*4 When the flash setting is MS or M, the aperture value changes automatically.

\*5 When the flash setting is MS or M, the aperture value changes automatically in **Tv** mode.

\*6 The aperture value changes automatically.

\*7 The flash fully discharges.

\*8 Unavailable for AF330FTZ.



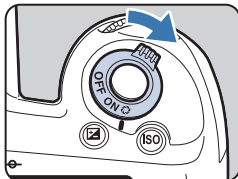

# Preview

Turn the main switch to  to use the preview function.  
There are two preview methods.









<b>Optical Preview</b>	For checking the depth of field with the viewfinder. (Default setting)
<b>Digital Preview</b>	For checking the composition, exposure and focus on the monitor. (The maximum display time: 60 seconds) You can magnify or save the preview image.

## Setting the Preview Method

- 1 Select [Button Customization] in 4 menu and press .**  
The [Button Customization] screen appears.
- 2 Select [Preview Dial] and press .**  
The [Preview Dial] screen appears.
- 3 Select [Optical Preview] or [Digital Preview] and press .**
- 4 Press  three times.**  
The camera returns to standby mode.

## Memo

- Optical Preview is always used when Multi-exposure, Interval Shooting, Interval Composite or Mirror Lock-up Shooting is used.
- The display settings and camera operation during Digital Preview can be changed in [Digital Preview] of the 4 menu. ( p.R19)
- The preview function can also be assigned to . ( p.R20)  
You can easily switch between Optical Preview and Digital Preview after assigning different kinds of preview methods to the two controls,  of the main switch and .

# Custom Image

Select the desired picture style from the following modes and enjoy taking pictures with a creative finishing tone.

Image Tone	Parameter
<b>Bright/Natural/ Portrait/Landscape/ Vibrant/Radiant</b>	Saturation: -4 to +4
	Hue: -4 to +4
	High/Low Key Adj: -4 to +4
	Contrast: -4 to +4
	Sharpness: -4 to +4
<b>Muted/ Bleach Bypass</b>	Saturation: -4 to +4
	Toning: Off/Green/Yellow/Orange/Red/Magenta/ Purple/Blue/Cyan
	High/Low Key Adj: -4 to +4
	Contrast: -4 to +4
	Sharpness: -4 to +4
<b>Reversal Film</b>	Sharpness: -4 to +4
<b>Monochrome</b>	Filter Effect: None/Green/Yellow/Orange/Red/ Magenta/Blue/Cyan/Infrared Filter
	Toning: Off/Green/Yellow/Orange/Red/Magenta/ Purple/Blue/Cyan
	High/Low Key Adj: -4 to +4
	Contrast: -4 to +4
	Sharpness: -4 to +4
<b>Cross Processing</b>	Random/Preset 1-3/Favorite 1-3 <sup>*1</sup>

\*1 The settings of a captured image can be saved with [Save Cross Processing] of the playback mode palette. (p.69)

## Memo

- By default, [Custom Image] is set to [Natural].

### 1 Press **▶** in standby mode.

The Custom Image setting screen appears.

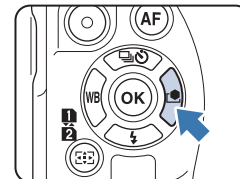

### 2 Select an image finishing tone.



#### Available operations when shooting with the viewfinder

Main switch to Uses Digital Preview to preview the background image with the selected effect applied.

**AE-L** Saves the preview image (only when the image can be saved).

Proceed to Step 6 if you do not need to change the parameters.

### 3 Press **INFO**.

The parameter setting screen appears.

## 4 Set the parameters.



### Available operations

▲▼	Selects a parameter.
◀▶	Adjusts the value.
	Switches between [Contrast], [Contrast Highlight Adjustment] and [Contrast Shadow Adjustment].
	Switches between [Sharpness], [Fine Sharpness] and [Extra Sharpness]. (Not available in  mode.)
○	Resets the adjustment value to the default setting.

## 5 Press **OK**.

The screen of Step 2 reappears.

## 6 Press **OK**.

The camera returns to standby mode.

## Memo

- When [Reversal Film] is selected and [White Balance] is set to [Auto White Balance], images are captured with an effect similar to using a daylight film.

## Saving the Settings of a Captured Image

The outcome of Cross Processing varies each time a picture is taken. If you take a cross processed image that you like, you can save the Cross Processing settings used in that image so that you can repeatedly use the same settings.

### 1 Press **▼** in single image display of playback mode.

The playback mode palette appears.

### 2 Select (Save Cross Processing) and press **OK**.

The camera searches for cross processed images starting from the most recent image taken.

[No cross processed image] appears if there are no cross processed images.

### 3 Use to select a cross processed image.



### 4 Select the “Favorite” number 1, 2 or 3 to save the settings and press **OK**.

The settings of the selected image are saved as your “Favorite” settings.

## Memo

- The saved Cross Processing settings can be loaded by selecting [Cross Processing] in Step 2 of “Custom Image” (p.68), and selecting one of the Favorite settings 1 to 3 for the parameter.

# MEMO



# 4

## Playback and Processing Functions

---











Setting the Playback Functions .....	72
Displaying a Single Image .....	73
Changing the Playback Method .....	74
Editing and Processing Images .....	77
Protecting Images .....	83
Connecting the Camera to an AV Device .....	84





# Setting the Playback Functions

Playback functions can be set in the playback mode palette as well as the  menu.

Press  in single image display of the playback mode to display the playback mode palette.



Item	Function	Page
 <b>Image Rotation</b> *1	Changes the rotation information of images.	p.76
 <b>Digital Filter</b> *1	Processes images with digital filters.	p.79
 <b>Color Moiré Correction</b> *1 *2	Reduces color moiré in images.	p.78
 <b>Resize</b> *1 *2	Changes the number of recorded pixels of the image.	p.77
 <b>Cropping</b> *1	Crops out only the desired area of an image.	p.78
 <b>Protect</b>	Protects images from being accidentally erased.	p.83
 <b>Slideshow</b>	Plays back images one after another.	p.76
 <b>Save as Manual WB</b> *1	Saves the white balance settings of the captured image as Manual White Balance.	p.54
 <b>Save Cross Processing</b>	Saves the settings used for an image captured in Cross Processing mode of Custom Image as your "Favorite" settings.	p.69
 <b>RAW Development</b> *3	Develops RAW images into JPEG images and saves them as a new file.	p.82

Item	Function	Page
 <b>Movie Edit</b> *4	Divides a movie or deletes unwanted segments.	p.81
 <b>Image Copy</b>	Copies images between memory cards in SD1 and SD2 slots.	p.77
 <b>Eye-Fi Image Transfer</b> *5	Transfers selected images wirelessly using an optional Eye-Fi card.	 p.R34

\*1 Not available when a movie is displayed.



\*2 Not available when a RAW image is displayed.

\*3 Available only when a RAW image is saved.

\*4 Available only when a movie is displayed.

\*5 Available only when an Eye-Fi card is inserted in the SD2 slot.

## Memo

- The functions of the playback mode palette can be used only for the images saved on the memory card that is currently being played back. To use the functions for the images saved on the other memory card, switch to the other memory card slot with  during single image display, then display the playback mode palette.
- When saving images that have been edited with functions such as [Resize], you can choose whether to save the images to the memory card in the SD1 or SD2 slot if both cards are available for recording.
- Refer to "Menu Reference" for details on the  menus. ( p.R26)



# Displaying a Single Image

## Deleting Images One by One

### Caution

- Deleted images cannot be restored.
- Protected images cannot be deleted. (p.83)

### 1 Display the image to delete in single image display.

### 2 Press .

The delete confirmation appears.



### 3 Select [Delete] and press .

### Memo

- Select the file format to delete for the images saved in RAW+ format.
- When deleting multiple images at once, refer to “Multi-image Display” (p.74) or “Folder Display” (p.75).
- To delete all images, use [Delete All Images] in the 1 menu. (p.R27)

## Zoom Display

Images can be magnified up to 16× in playback mode.







### 1 Display the image to magnify in single image display.

### 2 Turn to the right.



The image magnifies at each click.



#### Available operations

	to the right	Magnifies the image.
	to the left	Reduces the image.
		Changes the area to magnify.
		Returns to the entire image display.
		Displays the previous or next image without changing the magnification and the position of the image to magnify.
		Changes the type of information displayed.
		Switches between the memory cards to play back without changing the magnification and the position of the image to magnify.

### Memo

- You can magnify the image by following the same procedure during Instant Review (p.38) or Digital Preview (p.67).
- You can set the initial magnification with [Quick Zoom] in the 1 menu. (p.R26)
- When the image is magnified to the actual pixel size,  is displayed at the bottom right of the screen. If the  is turned to view the next or previous image during actual pixel size display, the next or previous image is displayed in the actual pixel size. The magnification for the actual pixel size varies depending on the number of recorded pixels of the image.

# Changing the Playback Method

## Multi-image Display



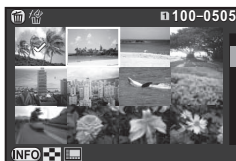

You can display 6, 12, 20, 35 or 80 thumbnail images at the same time. (Default setting: 12 Thumbnail Display)

### 1 Turn to the left in single image display.

The multi-image display screen appears.



#### Available operations

	Moves the selection frame.
	Shows the next/previous page.
	Switches between the SD1 card and SD2 card.
	Shows the display style selection screen.



	Deletes the selected images.
---	------------------------------

### 2 Press .

The selected image appears in single image display.

#### Memo

- Icons such as  are not displayed on the thumbnail images when [80 Thumbnail Display] is selected.





## Select & Delete

### 1 Press in Step 1 of “Multi-image Display”.

### 2 Select the images to delete.



#### Available operations

	Moves the selection frame.
	Confirms/cancels the selection of the image to delete.
	Selects the range of images to delete.
	Shows the selected image in single image display. Use  to select a different image.

In the upper left area of the monitor, the number of selected images is displayed.

### 3 Press .

The delete confirmation screen appears.

### 4 Select [Delete] and press .

#### Memo

- You can select up to 500 images at a time.
- Protected images cannot be selected.
- You can delete the images selected individually along with the images selected by specifying the range to delete.
- Use the same steps to select multiple images for the following functions.
  - Image Copy (p.77)
  - RAW Development (p.82)
  - Protect (p.83)
  - Eye-Fi Image Transfer ( p.R34)

## Folder Display

Images are grouped and displayed by folder in which they are saved.



- 1 Turn  to the left in Step 1 of “Multi-image Display”.

Up to eight folders are displayed at once.

- 2 Select a folder.



### Available operations

	Moves the selection frame.
	Displays the images in the folder on the multi-image display screen.
	Deletes the folder and all the images in it.

## Deleting a Folder

- 1 Select a folder to delete in Step 1 of “Folder Display” and press .

The delete confirmation screen appears.

- 2 Select [Delete] and press .

The selected folder and all the images in it are deleted.

When there are protected images in the folder, select [Delete all] or [Leave all].

## Memo

- Refer to “Menu Reference” for details on folder names. ( p.R31)

## Calendar Filmstrip Display

Images are grouped and displayed by shooting date.

- 1 Press  in Step 1 of “Multi-image Display”.

The display style selection screen appears.





- 2 Select [Calendar Filmstrip Display].

Images are displayed by shooting date.



Shooting date Thumbnail

### Available operations

	Selects a shooting date.
	Selects an image taken on the selected shooting date.
 to the right	Displays the selected image in single image display. (  to the left: Returns to displaying images by shooting date.)
	Deletes the selected image.

- 3 Press .

The selected image appears in single image display.

## Slideshow



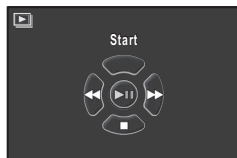

You can play back all images saved on a memory card successively.

### 1 Select in the playback mode palette.

The start screen is displayed and slideshow starts.





#### Available operations

	Pauses/resumes playback.
	Displays the next or previous image.
	Stops playback.
	Adjusts the volume of the movie.

After all images are played back, the camera returns to single image display.

### Memo

- You can change the display settings for slideshow in [Slideshow] of the  1 menu. Slideshow can also be started from the Slideshow setting screen. ( p.R26)

## Image Rotation

Image rotation information is saved according to the orientation of the camera when the image was shot. When [Auto Image Rotation] in the  1 menu is set to on (default setting), the image is automatically rotated based on the rotation information during playback.

The rotation information of an image can be changed by following the procedure below.

### 1 Display the image to edit in single image display.

### 2 Select in the playback mode palette.



The selected image is rotated in 90° increments and the four thumbnail images are displayed.

### 3 Select the desired rotation direction and press .

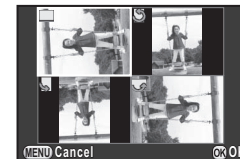

The image rotation information is saved.



### Caution

- When [22. Save Rotation Info] is set to off in the **C4** menu, image rotation information is not saved when shooting. ( p.R41)
- You cannot change the rotation information in the following cases.
  - Protected images
  - Images without a rotation information tag
  - When [Auto Image Rotation] is set to off in the  1 menu ( p.R26)
- Movie files cannot be rotated.

### Memo

- For images captured with [180° Rotation Info] in [Image Capture Settings] of the  1 menu set to on, the orientation of the camera when the image was taken is rotated 180° and saved as the rotation information. ( p.R15)

# Editing and Processing Images

## Image Copy

Copies images between memory cards in SD1 and SD2 slots.

**1** Select an image saved on the memory card from which the images have to be copied, and display it in single image display.

**2** Select  in the playback mode palette.

**3** Select [Select image(s)] or [Select a folder] and press **OK**.

**4** Select the image(s) or folder to copy.

Refer to Step 2 of “Select & Delete” (p.74) for how to select the image(s) or a folder.

**5** Press **INFO**.

The save confirmation screen appears.

**6** Select the location to save the image(s) or folder and press **OK**.

### Memo

- A new folder is created at the selected location to save the copied image(s).

## Resize/Cropping

### Caution

- Only JPEG images captured with this camera can be resized or cropped. TIFF images and movies cannot be resized or cropped. RAW images cannot be resized.
- Images already resized or cropped to the minimum file size cannot be processed.

## Resize

Changes the number of recorded pixels of the selected image, and saves it as a new file.

**1** Display the image to edit in single image display.

**2** Select  in the playback mode palette.

The screen to select the number of recorded pixels appears.

**3** Use **◀ ▶** to select the number of recorded pixels.

You can select an image size smaller than that of the original image.



**4** Press **OK**.

The save confirmation screen appears.

**5** Select [Save to SD1] or [Save to SD2] and press **OK**.

## Cropping

Crops out only the desired area of the selected image and saves it as a new image.

**1** Display the image to edit in single image display.





**2** Select  in the playback mode palette.

The cropping frame to specify the size and position of the area to crop appears on the screen.

**3** Specify the size and position of the area to crop by using the cropping frame.



### Available operations

	Changes the size of the cropping frame.
	Moves the cropping frame.
	Changes the aspect ratio or Image Rotation setting.
	Rotates the cropping frame (only when possible).

**4** Press **OK**.

The save confirmation screen appears.

**5** Select [Save to SD1] or [Save to SD2] and press **OK**.

## Color Moiré Correction

Reduces color moiré in images.

**1** Display the image to edit in single image display.

**2** Select  in the playback mode palette.

If the image cannot be edited, [This image cannot be processed] appears.

**3** Use **◀▶** to select the level and press **OK**.

The save confirmation screen appears.



**4** Select [Save to SD1] or [Save to SD2] and press **OK**.

### ! Caution

- The Color Moiré Correction can be used only for the JPEG images captured with this camera. RAW/TIFF images and movies cannot be corrected.



## Digital Filter

You can process captured images with digital filters. The following filters are available.

Filter Name	Effect	Parameter
<b>Base Parameter Adj</b>	Adjusts the parameters to create the desired image.	Brightness: -8 to +8
		Saturation: -3 to +3
		Hue: -3 to +3
		Contrast: -3 to +3
		Sharpness: -3 to +3
<b>Extract Color</b>	Extracts one or two specific colors and makes the rest of the image black and white.	Extracted Color 1: Red/Magenta/Blue/Cyan/Green/Yellow
		Extractable Range of Color 1: 1 to 5
		Extracted Color 2: OFF/Red/Magenta/Blue/Cyan/Green/Yellow
		Extractable Range of Color 2: 1 to 5
<b>Toy Camera</b>	Creates an image that looks as though it was shot with a toy camera.	Shading Level: Low/Medium/High
		Blur: Low/Medium/High
		Tone Break: Red/Green/Blue/Yellow
<b>Retro</b>	Creates an image with the look of an old photo.	Toning: B3 to A3
		Frame Composite: None/Thin/Medium/Thick
<b>High Contrast</b>	Enhances the contrast in the image.	1 to 5
<b>Shading</b>	Creates an image with darkened edges.	Shading Type: 4 types
		Shading Level: -3 to +3
<b>Invert Color</b>	Inverts image colors.	OFF/ON
<b>Unicolor Bold</b>	Extracts a specific color and makes the rest of the image black and white.	Red/Magenta/Blue/Cyan/Green/Yellow
<b>Bold Monochrome</b>	Creates a monochrome image and emphasizes the contrast.	Low/Medium/High

Filter Name	Effect	Parameter
<b>Tone Expansion</b>	Creates an image with a unique contrast.	Low/Medium/High
<b>Sketch</b>	Creates an image that looks as though it was drawn with a pencil.	Contrast: Low/Medium/High
		Scratch Effect: OFF/ON
<b>Water Color</b>	Creates an image that looks as though it was painted.	Intensity: Low/Medium/High
		Saturation: OFF/Low/Medium/High
<b>Pastel</b>	Creates an image that looks as though it was drawn with a crayon.	Low/Medium/High
<b>Posterization</b>	Lessens the tone of the image to create an image that looks as though it was hand-drawn.	1 to 5
<b>Miniature</b>	Blurs a part of the image to create a simulated miniature scene.	In-Focus Plane: -3 to +3
		In-Focus Width: Narrow/Middle/Wide
		In-Focus Plane Angle: Horizon/Vertical/Positive Slope/Negative Slope
		Blur: Low/Medium/High
<b>Soft</b>	Creates an image with a soft focus throughout the image.	Soft Focus: Low/Medium/High
		Shadow Blur: OFF/ON
<b>Starburst</b>	Creates an image with a special sparkling look by adding extra glitter to the highlights of night scenes or lights reflected on water.	Effect Density: Small/Medium/Large
		Size: Small/Medium/Large
		Angle: 0°/30°/45°/60°
<b>Fish-eye</b>	Creates an image that looks as though it was shot with a fish-eye lens.	Low/Medium/High
<b>Slim</b>	Changes the horizontal and vertical ratio of the image.	-8 to +8

## 1 Display the image to edit in single image display.

## 2 Select **0** in the playback mode palette.

The screen to select a filter appears.

## 3 Select a filter.

Use  to select a different image.

Proceed to Step 6 if you do not need to change the parameters.



## 4 Press **INFO**.

The parameter setting screen appears.

## 5 Set the parameters.



### Available operations

- |    |                      |
|----|----------------------|
| ▲▼ | Selects a parameter. |
| ◀▶ | Adjusts the value.   |

## 6 Press **OK**.

The save confirmation screen appears.

## 7 Select [Apply additional filter(s)], [Save to SD1] or [Save to SD2], and press **OK**.

Select [Apply additional filter(s)] when you want to apply additional filters to the same image. The screen of Step 3 reappears.

## ! Caution

- Only JPEG and RAW images captured with this camera can be edited with the digital filters. TIFF images cannot be edited.

## 📌 Memo

- You can apply up to 20 filters to the same image.

## Recreating Filter Effects

Retrieves the filter effects of the selected image and applies the same filter effects to other images.

## 1 Display a filter-processed image in single image display.

## 2 Select **0** in the playback mode palette.

## 3 Select [Recreating filter effects] and press **OK**.

The filter effects used for the selected image appear.

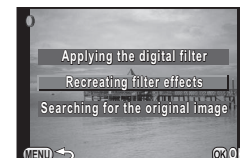

## 4 To check the parameter details, press **INFO**.

Press **INFO** again to return to the previous screen.



## 5 Press **OK**.

The image selection screen appears.

**6** Use  to select an image for applying the same filter effects.

You can only select an image saved in the same memory card that has not been processed with a filter.



**7** Press **OK**.

The save confirmation screen appears.

**8** Select **[Save to SD1]** or **[Save to SD2]** and press **OK**.

 **Memo**

- If [Searching for the original image] is selected in Step 3, the original image prior to digital filter application can be retrieved.

## Movie Edit

**1** Display the movie to edit in single image display.

**2** Select  in the playback mode palette.

The screen to edit a movie appears.

**3** Select the point where you want to divide the movie.

The frame at the dividing point is displayed at the top of the screen.

Up to four points can be selected to divide the original movie into five segments.

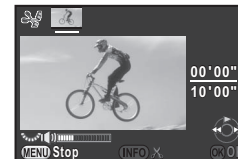

### Available operations

 Plays back/pauses a movie.

 Forwards a frame (when paused).

Press and hold  Fast-forwards playback.

 Reverses a frame (when paused).

Press and hold  Fast-reverses playback.

 Adjusts the volume.

 Confirms/cancels a dividing point.

Proceed to Step 7 if you do not want to delete any segment.

**4** Press .

The screen to select segments to delete is displayed.

**5** Use   to move the selection frame and press **OK**.

The segments to delete are specified. (Multiple segments can be deleted at once.)

Press **OK** again to cancel the selection.



**6 Press **MENU**.**

The screen of Step 3 reappears.

**7 Press **OK**.**

The save confirmation screen appears.

**8 Select [Save to SD1] or [Save to SD2] and press **OK**.****Memo**

- Select dividing points in chronological order from the beginning of the movie. When canceling the selected dividing points, cancel each of them in reverse order (from the end of the movie to the beginning). In an order other than specified, you can neither select dividing points nor cancel the selections of the dividing points.

## RAW Development

You can develop RAW images into JPEG or TIFF format.

**1 Select **RAW** in the playback mode palette.**

The screen for selecting a RAW image processing option appears.

**2 Select the desired option and press **OK**.**

Select single image	Develops an image.
Select multiple images	Develops up to 500 images with the same settings.
Select a folder	Develops up to 500 images in the selected folder with the same settings.

When [Select single image] is selected, proceed to Step 6. The image/folder selection screen appears.

**3 Select the image(s) or a folder.**

Refer to Step 2 of "Select & Delete" (p.74) for how to select the image(s) or a folder.

**4 Press **INFO**.**

The screen for selecting the parameter setting method appears.

**5 Select the parameter setting method and press **OK**.**

<b>Develop images as shot</b>	Allows you to change File Format, JPEG Recorded Pixels, and JPEG Quality.
<b>Develop images with modified settings</b>	Allows you to change Image Capture Settings (File Format, Aspect Ratio, JPEG Recorded Pixels, JPEG Quality, Color Space), Lens Correction (Distortion Correction, Lat-Chromatic-Ab Adj, Peripheral Illumin. Corr., Diffraction Correction, Color Fringe Correction), White Balance, Custom Image, Digital Filter, HDR, Sensitivity, High-ISO NR, and Shadow Correction.

**6 Set the parameters.****Available operations**

▲ ▼	Selects a parameter.
◀ ▶	Adjusts the value.
☀	Selects a different image (when in single image display).

For Image Capture Settings and Lens Correction, press ▶ and use ▲ ▼ to select an item.

For White Balance, Custom Image and Digital Filter, press ▶ to display the setting screen.

## 7 Press **OK**.

The save confirmation screen appears.

## 8 Select **[Save to SD1]** or **[Save to SD2]** and press **OK**.

When **[Select single image]** is selected, select **[Continue]** or **[Exit]**, and press **OK**.

### Caution

- Only RAW images captured with this camera can be developed. Images captured with other cameras cannot be processed on this camera.

### Memo

- You cannot save the background image or use Digital Preview while setting the Custom Image or White Balance parameters.
- When the White Balance parameter is set to **[Manual White Balance]**, press **INFO** to display the fine-tuning screen.
- The Digital Filter parameter cannot be applied to RAW images captured when **[HDR Capture]** of the **1** menu is set.
- When **[Select multiple images]** or **[Select a folder]** is selected in Step 2, a folder with a new number is created, and the JPEG images are stored in it.
- With the provided software “Digital Camera Utility 5”, you can develop RAW files on a computer. (p.88)

# Protecting Images

You can protect images from being accidentally deleted.

### Caution

- Even protected images are deleted if the inserted memory card is formatted.

## 1 Select in the playback mode palette.

The screen for selecting the unit for processing appears.

## 2 Select **[Select image(s)]** or **[Select a folder]** and press **OK**.



## 3 Select the image(s) or a folder.

Refer to Step 2 of “Select & Delete” (p.74) for how to select the image(s) or a folder.

Proceed to Step 5 if **[Select a folder]** is selected.

## 4 Press **INFO**.

The confirmation screen appears.

## 5 Select **[Protect]** and press **OK**.

To remove protection from the image, select **[Unprotect]**.

### Memo

- To protect all images stored in the memory card, select **[Protect All Images]** of the **1** menu. (p.R26)

# Connecting the Camera to an AV Device

Connect to an AV device, such as a TV, equipped with an HDMI terminal to display Live View images while shooting or to play back images in playback mode.

Make sure to have a commercially available HDMI cable equipped with an HDMI terminal (type D).

4

Playback and Processing Functions

**1 Turn the AV device and camera off.**

**2 Open the terminal cover of the camera, and connect the HDMI cable to the HDMI terminal.**

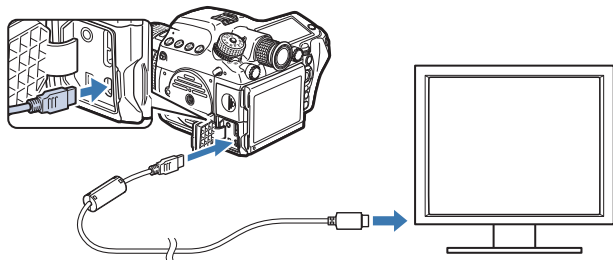

**3 Connect the HDMI cable to the input terminal on the AV device.**



**4 Turn the AV device and camera on.**

The camera turns on in HDMI mode, and the camera information is displayed on the screen of the connected AV device.

## Caution

- While the camera is connected to an AV device, nothing is displayed on the camera monitor. Also, you cannot adjust the volume on the camera. Adjust the volume on the AV device.

## Memo

- Check the operating manual of the AV device and select a suitable input terminal for connecting the camera.
- If you intend to use the camera continuously for a long period, use of the optional AC adapter kit is recommended.
- By default, the maximum resolution supported by both the AV device and camera is automatically selected. If it fails to play back images properly, change the setting in [HDMI Out] of the  2 menu. ( p.R30)

# 5

## Using a Computer

---

Connecting to a Computer .....	86
Using the Provided Software .....	88

# Connecting to a Computer

The captured images can be transferred to a computer by connecting the camera using a USB cable and can be managed using the provided software.

## System Requirements

We recommend the following system requirements to connect the camera to a computer or to use the provided software “Digital Camera Utility 5”.

### Windows

<b>OS</b>	Windows 8.1 (32 bit/64 bit) / Windows 8 (32 bit/64 bit) / Windows 7 (32 bit/64 bit) / Windows Vista (32 bit/64 bit)
<b>CPU</b>	Intel Core 2 Quad or higher
<b>RAM</b>	4 GB or more
<b>HDD</b>	Program installation and start-up: 100 MB or more Space taken up on HDD (per file): [JPEG] Approximately 25 MB [TIFF] Approximately 150 MB [RAW] Approximately 70 MB
<b>Monitor</b>	1280×1024 pixels, 24 bit full-color or higher

### Macintosh

<b>OS</b>	Mac OS X 10.9 / 10.8 / 10.7 / 10.6
<b>CPU</b>	Intel Core 2 Quad or higher
<b>RAM</b>	4 GB or more
<b>HDD</b>	Program installation and start-up: 100 MB or more Space taken up on HDD (per file): [JPEG] Approximately 25 MB [TIFF] Approximately 150 MB [RAW] Approximately 70 MB
<b>Monitor</b>	1280×1024 pixels, 24 bit full-color or higher

### Memo

- QuickTime is required to play back movies transferred to a computer. You can download it from the following site:  
<http://www.apple.com/quicktime/download/>



## Connecting the Camera to a Computer

Connect the camera to a computer using an USB cable. Make sure to have a commercially available USB cable equipped with a micro B terminal.

- 1 Turn the computer on.
- 2 Turn the camera off.
- 3 Open the terminal cover of the camera, and connect the USB cable to the USB terminal.

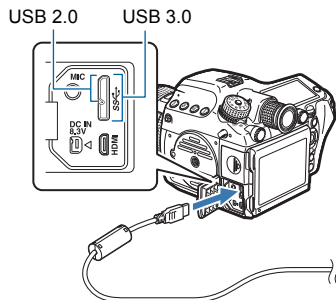

- 4 Connect the USB cable to the USB port of the computer.
- 5 Turn the camera on.  
The camera is recognized as a removable disk.  
If the "645Z" dialog appears, select [Open folder to view files].
- 6 Save the captured images to the computer.
- 7 Disconnect the camera from the computer.

### Caution

- The camera cannot be operated while it is connected to a computer. To operate the camera, terminate the USB connection on the computer, then turn off the camera and remove the USB cable.

### Memo

- When connected to a computer, use of the optional AC adapter kit is recommended.
- The USB connection mode when connecting the camera to a computer can be set in [USB Connection] of the  $\curvearrowright$  2 menu. (📖 p.R30) Normally, you do not need to change the default setting ([MSC]).
- A memory card with a built-in wireless LAN "Eye-Fi card" (Wi-Fi transmission) or a "Flucard" compatible with this camera can be used. By using these cards, images can be transferred from the camera to a computer or other device via wireless LAN. (📖 p.R34)

### USB Terminal

The micro B terminal supports both USB 3.0 cables and USB 2.0 cables. Both types can be used with this camera. If the host controller of the device to be connected to the camera supports USB 3.0, the use of a USB 3.0 cable makes the data transfer process faster.

# Using the Provided Software

“Digital Camera Utility 5” is included on the provided CD-ROM (S-SW150). Using the Digital Camera Utility 5, you can manage images saved on a computer, develop RAW images taken with this camera and adjust the color of them.

## ● Compatible file formats

- .jpg (JPEG), .tif (TIFF), .pef (RAW files in our original format), .dng (RAW files in DNG format)

## Installing the Software

You can install the software from the provided CD-ROM.

## 📌 Memo

- When multiple accounts have been setup on the computer, log on with an account that has administrative rights before installing the software.
- The installation procedure varies depending on your operating environment. Refer to the following to install the software.

## For Windows 7

### 1 Turn the computer on.

Shut down other software running.

### 2 Place the CD-ROM (S-SW150) into the optical drive.

The [Software Install] screen appears.

If the [Software Install] screen does not appear:

- 1 Click [Computer] from the Start menu.
- 2 Double-click the optical drive (S-SW150) icon.
- 3 Double-click [Setup.exe].

### 3 Click [32bit] or [64bit].

Select according to the operating environment.

The screen to select a desired language appears.



### 4 Select the desired language and click [OK].

The [InstallShield Wizard] screen appears in the selected language.

### 5 Click [Next].

Follow the instructions on the screen to perform subsequent steps.

### 1 Turn the Macintosh on.

Shut down other software running.

### 2 Place the CD-ROM (S-SW150) into the optical drive.

The CD-ROM icon appears on the desktop.

If the CD-ROM icon does not appear:

1 Select [Preferences] in the [Finder] menu.

2 Tick the [CDs, DVDs, and iPods] check box on the [General] tab.

### 3 Double-click the CD-ROM (S-SW150) icon.

### 4 Double-click the [Software Installer] icon.

### 5 Click [Digital Camera Utility 5].

Follow the instructions on the screen to perform subsequent steps.



# Digital Camera Utility 5 Screen

When Digital Camera Utility 5 is launched, the following screen appears.

## Memo

- The screenshots used in this explanation are for Windows.

## Browser Mode

You can perform the file management functions such as viewing and managing the images.

5

Using a Computer

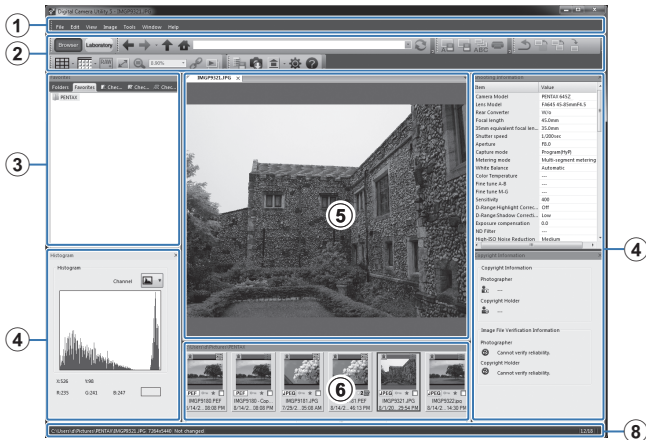

## Laboratory Mode

The control panel for adjusting the image appears here.

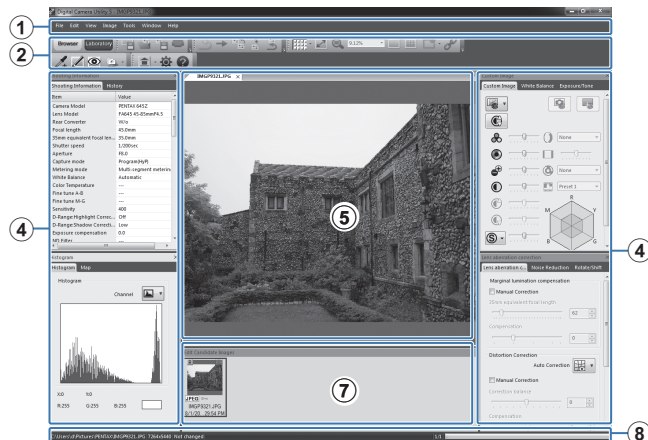

## ① Menu Bar

You can execute a function and change various settings here.  
For Macintosh, the Menu bar appears at the top of the desktop.

## ② Tool Bar

Frequently used functions are provided as Tool bar buttons.

## ③ Navigation Panel

This panel is only displayed in Browser mode. There are "Folders", "Favorites", "Checkmark 1", "Checkmark 2", and "Checkmark 3" panels.

## ④ Control Panel

The shooting information and settings of the selected image appear in this panel.

The control panel display varies depending on the mode.

## ⑤ Image View Page

The image selected from the image list is displayed.

When multiple image display pages are open, the images can be arranged left to right or up and down by dragging the tab. For Macintosh, select [Align images vertically] or [Align images horizontally] in the [Window] menu.

## ⑥ List of images in the current folder

The list of images in the selected folder appears here.

## ⑦ List of candidate images for editing

The list of images that can be edited appears here.

## ⑧ Status Bar

Information on the selected item appears.

## Viewing the Help Menu

Refer to the Help menu for details on using the Digital Camera Utility 5 program.

### 1 Click the button on the Tool bar.

Or, select [Digital Camera Utility 5 Help] from the [Help] menu.

## Regarding User Registration

In order to better serve you, we request that you complete the user registration.

### 1 Click [User Registration] on the [Software Install] screen.

A world map for Internet User Registration is displayed.

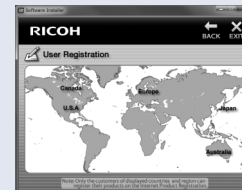

### 2 If your computer is connected to the Internet, click the displayed country or area and then follow the instructions to register your software.

Note that you can only register online if your country or area is shown.

# MEMO

# 6

## Appendix

---

<b>Optional Accessories .....</b>	<b>94</b>
<b>Error Messages .....</b>	<b>97</b>
<b>Troubleshooting .....</b>	<b>98</b>
<b>Index .....</b>	<b>100</b>
<b>WARRANTY POLICY .....</b>	<b>105</b>

# Optional Accessories

Several accessories are provided for use with this camera. Please contact our service center for details regarding the accessories.

Products marked with an asterisk (\*) are the same as those supplied with the camera.

## Power Supply Accessories

### Battery Charger kit K-BC90 (\*)

(Kit includes Battery charger D-BC90 and AC plug cord.)

### Rechargeable Lithium-ion Battery D-LI90 (\*)

### AC Adapter Kit K-AC132

(Kit includes AC adapter D-AC120 and AC plug cord.)

Lets you power this camera from an AC outlet.

6

Appendix

## Flash Accessories

### Auto Flash AF540FGZ II

### Auto Flash AF360FGZ II

The AF540FGZ II and AF360FGZ II are P-TTL auto flash units with a maximum guide number of approximately 54 and 36 (both ISO 100/m), respectively. Their features include slave-sync flash, contrast-control-sync flash, high-speed sync flash, wireless flash, slow-speed sync and trailing curtain sync flash.



AF540FGZ II



AF360FGZ II

### Auto Flash AF200FG

The AF200FG is a P-TTL auto flash unit with a maximum guide number of approximately 20 (ISO 100/m).

It features contrast-control-sync flash and slow-speed sync flash when combined with the AF540FGZ, AF540FGZ II, AF360FGZ or AF360FGZ II unit.



AF200FG



### Auto Macro Flash AF160FC

The AF160FC is a flash system especially designed for macro photography to take close, shadowless pictures of small objects. It is compatible with existing TTL auto flash functions and can be used with a wide range of PENTAX cameras by using the provided adapter rings.



AF160FC

### Hot Shoe Adapter FG

### Extension Cord F5P



Hot Shoe Adapter FG

### Off-camera Shoe Adapter F

Use the adapters and cords to use the external flash away from the camera.



Off-camera Shoe Adapter F

## For Viewfinder

### Large Eyecup 645 O-EC107 (\*)

## Interchangeable Focusing Screen

### AF Framed Matte DF-80 (\*)

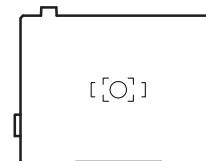

### AF Cross-Lined Matte DG-80

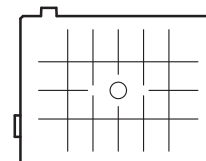

### AF Golden Section Matte DK-80

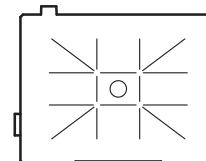

## Cable Switch CS-205

Connect to the cable switch terminal and operate the camera shutter release button. The cord length is 0.5 m.



## Remote Control

Used for remote control shooting.

Operating distance for remote control

From the front of camera: approx. 4 m

From the back of camera: approx. 2 m

### Remote Control F



### Remote Control Waterproof O-RC1



## GPS Unit O-GPS1

By attaching the O-GPS1 to the hot shoe, the latitude, longitude, altitude, direction, and Coordinated Universal Time (UTC) can be recorded in the image file.

The Electronic Compass can be used with this camera. (📖 p.R18)



## Strap

### Camera Strap O-ST150 (\*)

## Other Accessories

### Body Mount Cap 645 (\*)

### Hot Shoe Cover Fk (\*)

### Sync Socket 2P Cap (\*)

### Imagesensor Cleaning Kit O-ICK1

### FLUCARD O-FC1



This SD memory card has a built-in wireless LAN (Wi-Fi transmission) function. Connect with a communication terminal such as a smartphone or tablet via wireless LAN and operate the communication terminal to shoot or view images. (📖 p.R34)



# Error Messages

Error Messages	Description
<b>Memory card full</b>	The memory card is full and no more images can be saved. Insert a new memory card or delete unwanted files.
<b>No image</b>	There are no images that can be played back on the memory card.
<b>This image cannot be displayed</b>	You are trying to play back an image in a format not supported by this camera. You may be able to play it back on a computer.
<b>No card in the camera</b>	There is no memory card inserted in the camera.
<b>Memory card error</b>	The memory card has a problem, and image capture and playback are impossible. You may be able to play it back on a computer. Or, the camera failed to initialize the Eye-Fi function when using the Eye-Fi card. Press <b>Ⓞ</b> .
<b>Card is not formatted</b>	The memory card you have inserted is unformatted or has been previously used on another device and is not compatible with this camera. Use the card after formatting it with this camera. (p.36)
<b>Card is locked</b>	The write-protect switch on the memory card you have inserted is locked. (p.4)
<b>This image cannot be magnified</b>	You are trying to magnify an image that cannot be magnified.
<b>The image is protected</b>	You are trying to delete an image that is protected. Remove protection from the image. (p.83)

Error Messages	Description
<b>Not enough battery power remaining to activate Pixel Mapping</b>	These messages appear when you try to perform Pixel Mapping or Sensor Cleaning, or to update the firmware if the battery level is insufficient. Install a fully charged battery.
<b>Not enough battery power remaining to clean sensor</b>	
<b>Not enough battery power remaining to update the firmware</b>	
<b>Unable to update firmware. There is a problem with the firmware update file</b>	Unable to update the firmware. The update file is damaged. Try downloading the update file again.
<b>Image folder cannot be created</b>	The maximum folder number (999) is being used, and no more images can be saved. Insert a new memory card or format the card.
<b>Unable to store image</b>	The image could not be saved because of a memory card error.
<b>The operation could not be completed correctly</b>	The camera was unable to adjust the manual white balance. Try the operation again.
<b>No more images can be selected</b>	You are trying to select more than the maximum number of images for Select & Delete, Protect, RAW Development, Image Copy, or Eye-Fi Image Transfer.
<b>No image can be processed</b>	There are no images that can be processed using the Digital Filter or RAW Development function.

Error Messages	Description
<b>This image cannot be processed</b>	Appears when you try to perform Digital Filter, Color Moiré Correction, Resize, Cropping, Save as Manual WB, RAW Development, or Movie Edit for images captured with other cameras, or when you try to perform Resize or Cropping for minimum file size images.
<b>This function is not available in the current mode</b>	You are trying to set a function that is not available for the exposure mode that is set.
<b>The camera will turn off to prevent damage from overheating</b>	The camera will turn off because its internal temperature is too hot. Leave the camera turned off until it has had time to cool down before turning on the camera again.
<b>Set the Eye-Fi communication to "SELECT"</b>	Images cannot be transferred when [Action Mode] is not set to [SELECT] in [Wireless Memory Card] of the  menu. (  p.R34)
<b>Image not found</b>	There are no images that can be transferred when an Eye-Fi card is used.
<b>Cannot be selected</b>	This folder cannot be selected because the number of files exceeds the maximum number allowed.

### Caution













- Error messages related to a memory card appear for each card slot being used. If an error message appears, take the appropriate action for the respective card slot.

## Troubleshooting

In rare cases, the camera may not operate correctly due to static electricity. This can be remedied by taking the battery out and putting it back in again. When the mirror remains in the UP position, take the battery out and put it back in again. Then, the mirror will retract when the camera is turned on again. If, after performing these procedures, the camera operates correctly, it does not require any repairs.

We recommend checking the following items before contacting a service center.

Problem	Cause	Remedy
<b>The camera does not turn on.</b>	Battery is not installed properly.	Check the orientation of the battery.
	The battery power is low.	Charge the battery.
<b>The shutter cannot be released.</b>	There is no available space on the memory card.	Insert a memory card with available space or delete unwanted images.
	Data is being processed.	Wait until processing is finished.
<b>Autofocus does not work.</b>	The subject is difficult to focus on.	<b>AF</b> cannot work well for low-contrast objects (the sky, white walls, etc.), dark colors, intricate designs, rapidly-moving objects or scenery shot through a window or a net-like pattern. Lock focus on another object located at the same distance as your subject, then aim at the target and take a picture. Alternatively, use <b>MF</b> .
	The subject is too close.	Move away from the subject and take a picture.

Problem	Cause	Remedy
<b>The focus cannot be locked.</b>	AF Mode of Live View is set to  (Tracking).	Set [Contrast AF] to  ,  ,  or  . (p.46)
<b>The camera is not recognized when it is connected to a computer.</b>	The USB connection mode is set to [PTP].	Set [USB Connection] to [MSC] in the  2 menu. (  p.R30)
<b>Dust or dirt particles appear in images.</b>	The CMOS sensor is dirty or dusty.	Activate [Dust Removal] from the  4 menu. The Dust Removal function can be activated every time the camera is turned on and off. (  p.R37) Refer to “Sensor Cleaning” if the problem persists. (  p.R37)
<b>There are pixels in the monitor or captured images that do not light up or remain lit.</b>	There are defective pixels in the CMOS sensor.	Activate [Pixel Mapping] from the  4 menu. (  p.R35) It takes about 30 seconds to correct the defective pixels, so be sure to install a fully charged battery.

# Index

## Symbols

menu .....	R5, R15
menu .....	R8, R24
menu .....	R8, R26
menu .....	R9, R28
<b>C</b> menu .....	R11, R39
mode .....	51

## Numerics

180° Rotation Info .....	R15
1st Frame Action in AF.C .....	R41
4-way Controller Options .....	R42

## A

AC adapter .....	32, 94
Accessories .....	10, 28, 94
Action in AF.C Continuous .....	R41
AdobeRGB .....	R41
AE Lock .....	50
AE-L with AF Locked .....	R39
AF area .....	45, 46
AF Button .....	R20
AF Fine Adjustment .....	R42
AF frame .....	39
AF Mode .....	44
AF point .....	45
AF with Remote Control .....	R41
<b>AF.C</b> .....	44

<b>AF.S</b> .....	44
AF.S Setting .....	R40
Aperture Priority Automatic Exposure mode .....	48
Aspect Ratio .....	78, 82
Auto (AF Active Area) .....	45
Auto EV Compensation .....	R39
Auto Image Rotation .....	R26
AUTO ISO Parameters .....	R17
Auto Power Off .....	R34
Auto Resize .....	R35
Auto Screen Rotation .....	R30
Auto White Balance (White Balance) .....	53

AV device .....	84
<b>Av</b> mode .....	48
<b>AWB</b> (White Balance) .....	53
AWB in Tungsten Light .....	R40

## B

<b>B</b> mode .....	48
Base Parameter Adj (Digital Filter) .....	79
Battery .....	30
Battery level .....	31
Bleach Bypass (Custom Image) .....	68
Bold Monochrome (Digital Filter) .....	79
Bracketing .....	62
Bracketing Order .....	R40
Bright (Custom Image) .....	68
Brightness histogram .....	21

Bulb (B) Mode Options .....	R39
Bulb Exposure mode .....	48
Button .....	12
Button Customization .....	R20

## C

<b>C</b> (AF Mode) .....	44
Cable switch .....	95
Cable switch terminal .....	11
Calendar Filmstrip Display .....	75
Card access lamp .....	11
Center-weighted metering .....	47
Changing the image size .....	77
Charging the battery .....	30
Charging time .....	30
City .....	R28
Cloudy (White Balance) .....	53
Color Fringe Correction .....	82
Color Moiré Correction .....	78
Color Space .....	R41
Color Temperature (White Balance) .....	55
Color Temperature Steps .....	R40
Computer .....	87
Connecting to a computer .....	86
Continuous mode .....	44
Continuous Shooting .....	56
Contrast (Custom Image) .....	68
Contrast AF .....	R18
Contrast detection AF .....	44
Control panel .....	17, 41

Copyright Holder.....	R33
Copyright Information .....	R33
Create New Folder.....	R32
Cropping .....	78
Cross Processing (Custom Image) .....	69
<b>CTE</b> (White Balance) .....	53
Custom Image .....	68
Custom setting menu.....	R11, R39
<b>D</b>	
Date Adjustment .....	35, R28
Daylight (White Balance) .....	53
Default settings .....	R5
Delete .....	73, R27
Delete all images .....	R27
Delete an image.....	73
Deleting a folder.....	75
Destination.....	R29
Detailed Information Display.....	20
Developing RAW images.....	82
Dial.....	12
Dial indicator .....	38
Diffraction Correction .....	R16
Digital Camera Utility 5 .....	90, 91
Digital Filter.....	79
Digital Preview .....	67, R19
Diopter adjustment.....	37
Direct keys .....	41, R13
Display Color .....	R30
Display language .....	34, R28

Distortion Correction .....	R16
DNG .....	R15
D-Range Settings.....	R16
Drive Mode.....	56
DST (daylight saving time).....	R29
Dust Alert .....	R36
Dust Removal.....	R37
Dynamic range .....	R16
<b>E</b>	
E-Dial Programming .....	R20
Electronic Compass .....	18, R18
Electronic Level.....	18, 23, R19
Enable/Disable Controls.....	R43
Error messages.....	97
EV bar scale.....	22
EV Compensation .....	50
EV Steps .....	49, R39
Exif.....	R33
Expanded Area AF (AF Active Area) .....	45
Exposure Bracketing .....	62
Exposure metering timer .....	47, R39
Exposure Mode .....	48
Exposure Mode (USER mode) .....	R15, R23
Exposure Setting (Movie).....	R24
Exposure warning .....	22
Extract Color (Digital Filter).....	79
Eyecup .....	37
Eye-Fi card.....	33, R34

Eye-Fi Image Transfer.....	R34
<b>F</b>	
Face Detection (Contrast AF).....	46
File Format .....	R15
File Name .....	R32
File No. ....	R33
Filter Effect (Custom Image).....	68
Firmware Info/Options .....	R38
Fish-eye (Digital Filter) .....	79
Flash.....	64, 94
Flash (White Balance) .....	53
Flash compatibility.....	66
Flash compensation .....	65
Flash Mode.....	65
Flash On .....	65
Flash Sync Speed .....	48, R42
Flicker Reduction.....	R34
Flucard.....	33, 96, R34
Fluorescent - Cool White (White Balance).....	53
Fluorescent - Daylight Color (White Balance).....	53
Fluorescent - Daylight White (White Balance).....	53
Fluorescent - Warm White (White Balance).....	53
Focus Method.....	44
Focus Peaking.....	R18
Folder display .....	75
Folder Name.....	R31

Format .....	36, <a href="#">R38</a>
Framerate .....	<a href="#">R24</a>
Function settings.....	40

**G**

GPS .....	<a href="#">R18</a>
GPS Time Sync .....	<a href="#">R18</a>
GPS unit .....	96
Green button .....	<a href="#">R20</a>
Grid Display .....	<a href="#">R19</a> , <a href="#">R26</a>
Guide Display .....	38, <a href="#">R30</a>

**H**

HDMI Out.....	<a href="#">R30</a>
HDMI terminal.....	84
HDR Capture .....	<a href="#">R16</a> , <a href="#">R24</a>
Help .....	91
High Contrast (Digital Filter) .....	79
High/Low Key Adj (Custom Image)...	68
High-ISO NR.....	<a href="#">R17</a>
Highlight Alert .....	<a href="#">R19</a> , <a href="#">R26</a>
Highlight Correction .....	<a href="#">R16</a>
Histogram Display.....	21, <a href="#">R19</a>
Hold AF Status.....	<a href="#">R41</a>
Hometown.....	34, <a href="#">R29</a>
Hue (Custom Image) .....	68

**I**

Illumination Button .....	<a href="#">R21</a>
Image Capture Settings .....	<a href="#">R15</a>
Image Copy .....	77
Image finishing tone.....	68

Image plane indicator.....	11
Image Rotation.....	76
Image storage capacity .....	<a href="#">R49</a>
Initial settings .....	34
Initializing a memory card .....	36, <a href="#">R38</a>
Installing software .....	88
Instant Review.....	38, <a href="#">R19</a>
Interchangeable focusing screen ....	95
Interval Composite .....	60
Interval Movie Record .....	61
Interval Shooting .....	59
Invert Color (Digital Filter) .....	79
ISO AUTO Setting.....	<a href="#">R17</a>
ISO sensitivity .....	47

**J**

JPEG.....	<a href="#">R15</a>
-----------	---------------------

**K**

Kelvin .....	55, <a href="#">R40</a>
--------------	-------------------------

**L**

Landscape (Custom Image).....	68
Language/言語 .....	34, <a href="#">R28</a>
Language setting.....	34, <a href="#">R28</a>
Lat-Chromatic-Ab Adj.....	<a href="#">R16</a>
LCD Display .....	<a href="#">R30</a>
LCD Display Settings .....	<a href="#">R30</a>
LCD Panel.....	23
LCD Panel Illumination.....	<a href="#">R41</a>
Lens .....	26
Lens compatibility.....	28

Lens Correction .....	<a href="#">R16</a>
Link AE and AF Point .....	<a href="#">R39</a>
Live View .....	16, 39, <a href="#">R18</a>
Locking exposure value.....	50
LS lens.....	29

**M**

<b>M</b> mode.....	48
<b>M.U.P</b> .....	63
Macintosh .....	86
Manual Exposure mode.....	48
Manual White Balance.....	54
Memory.....	<a href="#">R22</a>
Memory card.....	33
Memory Card Options .....	<a href="#">R15</a> , <a href="#">R24</a>
Menu.....	42, <a href="#">R5</a>
Menu operation.....	42, <a href="#">R14</a>
Meter Operating Time.....	<a href="#">R39</a>
Metering mode.....	47
Microphone.....	52
Miniature (Digital Filter) .....	79
Mired.....	55, <a href="#">R40</a>
Mirror Up.....	63
Mirror Up Operation.....	<a href="#">R42</a>
Mode dial .....	38, 49
Mode dial lock button.....	38
Monitor.....	15
Monochrome (Custom Image).....	68
Motion JPEG .....	61
Movie Capture Settings .....	<a href="#">R24</a>
Movie Edit.....	81



Movie menu .....	R8, R24
Movie mode .....	51
Movie SR .....	R25
MSC.....	R30
Multi Auto White Balance (White Balance).....	53
Multi-exposure .....	58
Multi-image display .....	74
Multiple AF Points (Contrast AF) .....	46
Multi-segment metering .....	47
Muted (Custom Image).....	68

## N

Names of parts .....	11
Natural (Custom Image) .....	68
Noise Reduction .....	R17

## O

One Push File Format.....	R21
One-Push Bracketing.....	R40
Optical Preview.....	67

## P

<b>P</b> mode .....	48
Pastel (Digital Filter) .....	79
PEF.....	R15
Peripheral Illumination Correction..	R16
Photographer .....	R33
Pixel Mapping .....	R35
Pixels .....	R15
Playback .....	39

Playback Info Display selection screen .....	19
Playback menu.....	R8, R26
Playback mode.....	39
Playback mode palette.....	72, R13
Portrait (Custom Image).....	68
Posterization (Digital Filter) .....	79
Power .....	34
Power frequency .....	R34
Preview .....	67, R19
Preview Dial .....	67, R21
Program Automatic Exposure mode .....	48
Program Line.....	48, R18
Protect.....	83, R26
Protect All Images .....	R26
Provided software .....	88
PTP .....	R30

## Q

Quality Level .....	R15
Quick Zoom.....	R26
QuickTime.....	86

## R

Radiant (Custom Image).....	68
RAW.....	R15
RAW/Fx Button .....	R20
Rec. Mode menu .....	R5, R15
Recordable time .....	51
Recorded Pixels .....	R15, R24

Recording Sound Level .....	R24
Red-eye Reduction.....	65
Remote Control .....	57, 96
Reset .....	R35, R43
Resize.....	77
Retro (Digital Filter) .....	79
Reversal Film (Custom Image).....	68
RGB histogram .....	21
Rotate Display 180°.....	R19
Rotation .....	76
Rotation Direction (E-Dial Programming) .....	R20

## S

Saturation (Custom Image) .....	68
Save as Manual WB .....	54
Save Menu Location.....	42, R41
Save RAW Data .....	38, 39, 40, R19
Save Rotation Info .....	R41
Save Settings (White Balance).....	54
Save USER Mode .....	R22
SD Memory Card.....	33
Select (AF Active Area) .....	45
Select (Contrast AF).....	46
Select & Delete.....	74
Self-timer .....	57
Sensitivity .....	47, 82
Sensitivity Priority Automatic Exposure mode.....	48
Sensitivity Steps .....	R39
Sensor Cleaning.....	R37

Sequential Numbering .....	R33	Starburst (Digital Filter) .....	79	USB Connection .....	87, R30
Set-up menu .....	R9, R28	Status Screen.....	16	USB terminal .....	87
Shade (White Balance).....	53	Stereo microphone.....	11	<b>U1/U2/U3</b> mode .....	48, R22
Shading (Digital Filter) .....	79	Stills/Movie switching dial.....	38, 51	User registration .....	91
Shadow Correction .....	R16	Strap.....	26	User setting mode .....	48, R22
Shake Reduction .....	63, R25, R43	Superimpose AF Area.....	22, R40		
Shake Reduction Options .....	R43	<b>Sv</b> mode.....	48	<b>V</b>	
Sharpness (Custom Image).....	68	Switch.....	12	Vertical position .....	18
Shooting.....	38	Switching between the memory cards		Vibrant (Custom Image) .....	68
Shooting Info Display.....	18	.....	39	Viewfinder.....	22
Shooting information.....	15	Sync cord .....	64	Volume .....	R24, R29
Shutter & Aperture Priority Automatic		Sync socket.....	64	Volume label.....	37
Exposure mode .....	48	Sync socket 2P cap.....	64		
Shutter Priority Automatic Exposure		System requirements .....	86	<b>W</b>	
mode .....	48			WARRANTY POLICY.....	105, R55
Single image display.....	19, 39, 73	<b>T</b>		Water Color (Digital Filter).....	79
Single mode.....	44	<b>TAv</b> mode .....	48	WB Adjustable Range .....	R40
Sketch (Digital Filter) .....	79	Testing your camera .....	38	WB When Using Flash .....	R40
Slideshow .....	76, R26	Text Size .....	35, R29	White Balance .....	53
Slim (Digital Filter) .....	79	TIFF.....	82, R15	Wi-Fi transmission.....	R34
Slow Shutter Speed NR.....	R17	Time Setting .....	R29	Windows .....	86
Slow-speed Sync .....	65	Tone Expansion (Digital Filter).....	79	Wireless LAN.....	R34
Soft (Digital Filter).....	79	Toning (Custom Image) .....	68	Wireless Memory Card.....	R34
Sound .....	51	Toy Camera (Digital Filter).....	79	World Time .....	R28
Sound Effects .....	R29	Tracking (Contrast AF).....	46		
Speaker .....	11	TTL phase-matching autofocus.....	44	<b>X</b>	
Specifications.....	R45	Tungsten (White Balance).....	53	<b>X</b> mode.....	48
Spot (AF Active Area).....	45, 46	<b>Tv</b> mode.....	48		
Spot metering .....	47			<b>Z</b>	
sRGB .....	R41	<b>U</b>		Zone Select (AF Active Area).....	45
Standby mode.....	15	Unicolor Bold (Digital Filter) .....	79	Zoom display .....	73

# WARRANTY POLICY

---

All our cameras purchased through authorized bona fide photographic distribution channels are guaranteed against defects of material or workmanship for a period of twelve months from the date of your purchase. Service will be rendered, and defective parts will be replaced without cost to you within that period, provided the camera does not show evidence of impact, sand or liquid damage, mishandling, tampering, battery or chemical corrosion, operation contrary to operating instructions, or modification by an unauthorized repair shop. The manufacturer or its authorized representatives shall not be liable for any repair or alterations except those made with its written consent and shall not be liable for damages from delay or loss of use or from other indirect or consequential damages of any kind, whether caused by defective material or workmanship or otherwise; and it is expressly agreed that the liability of the manufacturer or its representatives under all guarantees or warranties, whether expressed or implied, is strictly limited to the replacement of parts as hereinbefore provided. No refunds will be made on repairs by non-authorized service facilities.

## Procedure During 12-month Warranty Period

Any camera which proves defective during the 12-month warranty period should be returned to the dealer from whom you purchased the camera or to the manufacturer. If there are no representatives of the manufacturer in your country, send the camera to the manufacturer, with postage prepaid. In this case, it will take a considerable length of time before the camera can be returned to you owing to the complicated customs procedures required. If the camera is covered by warranty, repairs will be made and parts replaced free of charge, and the camera will be returned to you upon completion of servicing. If the camera is not covered by warranty, regular charges of the manufacturer or of its representatives will apply. Shipping charges are to be borne by the owner. If your camera was purchased outside of the country where you wish to have it serviced during the warranty period, regular handling and servicing fees may be charged by the manufacturer's representatives in that country. Notwithstanding this, your camera returned to the manufacturer will be serviced free of charge according to this procedure

and warranty policy. In any case, however, shipping charges and customs clearance fees to be borne by the sender. To prove the date of your purchase when required, please keep the receipt or bills covering the purchase of your camera for at least a year. Before sending your camera for servicing, please make sure that you are sending it to the manufacturer's authorized representatives or their approved repair shops, unless you are sending it directly to the manufacturer. Always obtain a quotation for the service charge, and only after you accept the quoted service charge, instruct the service station to proceed with the servicing.

- **This warranty policy does not affect the customer's statutory rights.**
- **The local warranty policies available from our distributors in some countries can supersede this warranty policy. Therefore, we recommend that you review the warranty card supplied with your product at the time of purchase, or contact our distributor in your country for more information and to receive a copy of the warranty policy.**

**For customers in USA**  
**STATEMENT OF FCC COMPLIANCE**

This device complies with Part 15 of the FCC Rules. Operation is subject to the following two conditions: (1) This device may not cause harmful interference, and (2) this device must accept any interference received, including interference that may cause undesired operation.

Changes or modifications not approved by the party responsible for compliance could void the user's authority to operate the equipment.

This equipment has been tested and found to comply with the limits for a Class B digital device, pursuant to part 15 of the FCC Rules.

These limits are designed to provide reasonable protection against harmful interference in a residential installation. This equipment generates, uses and can radiate radio frequency energy and, if not installed and used in accordance with the instructions, may cause harmful interference to radio communications. However, there is no guarantee that interference will not occur in a particular installation. If this equipment does cause harmful interference to radio or television reception, which can be determined by turning the equipment off and on, the user is encouraged to try to correct the interference by one or more of the following measures:

- Reorient or relocate the receiving antenna.
- Increase the separation between the equipment and receiver.
- Connect the equipment into an outlet on a circuit different from that to which the receiver is connected.
- \* Consult the dealer or an experienced radio/TV technician for help.

**For customers in Canada**

This Class B digital apparatus complies with Canadian ICES-003.

**Pour les utilisateurs au Canada**

Cet appareil numérique de la classe B est conforme à la norme NMB-003 du Canada.

**FOR CALIFORNIA, U.S.A. ONLY**

Perchlorate Material-special handling may apply.

The lithium battery used in this camera contains perchlorate material, which may require special handling.

See [www.dtsc.ca.gov/hazardouswaste/perchlorate](http://www.dtsc.ca.gov/hazardouswaste/perchlorate)

**Declaration of Conformity**  
According to 47CFR, Parts 2 and 15 for  
**Class B Personal Computers and Peripherals**

We: RICOH IMAGING AMERICAS CORPORATION

Located at: 633 17<sup>th</sup> Street, Suite 2600  
Denver, Colorado 80202 U.S.A.  
Phone: 800-877-0155  
FAX: 303-790-1131

Declare under sole responsibility that the product identified herein complies with 47CFR Parts 2 and 15 of the FCC rules as a Class B digital device. Each product marketed is identical to the representative unit tested and found to be compliant with the standards. Records maintained continue to reflect the equipment being produced can be expected to be within the variation accepted, due to quantity production and testing on the statistical basis as required by 47CFR §2.909. Operation is subject to the following two conditions: (1) This device may not cause harmful interference, and (2) This device must accept any interference received, including interference that may cause undesired operation. The above named party is responsible for ensuring that the equipment complies with the standards of 47CFR §15.101 to §15.109.

Product Name: Lens-interchangeable medium-format digital SLR (Single Lens Reflex) Camera

Model Number: PENTAX 645Z

Contact person: Customer Service Manager

Date and Place: March, 2014, Colorado

## Information for Users on Collection and Disposal of Old Equipment and Used Batteries



### 1. In the European Union

These symbols on the products, packaging and/or accompanying documents mean that used electrical and electronic equipment and batteries should not be mixed with general household waste.

Used electrical/electronic equipment and batteries must be treated separately and in accordance with legislation that requires proper treatment, recovery and recycling of these products.



By disposing of these products correctly you will help ensure that the waste undergoes the necessary treatment, recovery and recycling and thus prevent potential negative effects on the environment and human health which could otherwise arise due to inappropriate waste handling.

If a chemical symbol is added beneath the symbol shown above, in accordance with the Battery Directive, this indicates that a heavy metal (Hg = Mercury, Cd = Cadmium, Pb = Lead) is present in the battery at a concentration above an applicable threshold specified in the Battery Directive.

For more information about collection and recycling of used products, please contact your local authorities, your waste disposal service or the point of sale where you purchased the products.

### 2. In other countries outside the EU

These symbols are only valid in the European Union. If you wish to discard used products, please contact your local authorities or dealer and ask for the correct method of disposal.

For Switzerland: Used electrical/electronic equipment can be returned free of charge to the dealer, even when you don't purchase a new product. Further collection facilities are listed on the home page of [www.swico.ch](http://www.swico.ch) or [www.sens.ch](http://www.sens.ch).



The CE Mark is a Directive conformity mark of the European Union.

# MEMO



<b>RICOH IMAGING COMPANY, LTD.</b>	2-35-7, Maeno-cho, Itabashi-ku, Tokyo 174-8639, JAPAN ( <a href="http://www.ricoh-imaging.co.jp">http://www.ricoh-imaging.co.jp</a> )
<b>RICOH IMAGING EUROPE S.A.S</b>	112 Quai de Bezons, B.P. 204, 95106 Argenteuil Cedex, FRANCE ( <a href="http://www.ricoh-imaging.fr">http://www.ricoh-imaging.fr</a> )
<b>RICOH IMAGING DEUTSCHLAND GmbH</b>	Am Kaiserkai 1, 20457 Hamburg, GERMANY ( <a href="http://www.ricoh-imaging.de">http://www.ricoh-imaging.de</a> )
<b>RICOH IMAGING UK LTD.</b>	PENTAX House, Heron Drive, Langley, Slough, Berks SL3 8PN, U.K. ( <a href="http://www.ricoh-imaging.co.uk">http://www.ricoh-imaging.co.uk</a> )
<b>RICOH IMAGING AMERICAS CORPORATION</b>	633 17th Street, Suite 2600, Denver, Colorado 80202, U.S.A. ( <a href="http://www.us.ricoh-imaging.com">http://www.us.ricoh-imaging.com</a> )
<b>RICOH IMAGING CANADA INC.</b>	1770 Argentia Road Mississauga, Ontario L5N 3S7, CANADA ( <a href="http://www.ricoh-imaging.ca">http://www.ricoh-imaging.ca</a> )
<b>RICOH IMAGING CHINA CO., LTD.</b>	23D, Jun Yao International Plaza, 789 Zhaojiabang Road, Xu Hui District, Shanghai, 200032, CHINA ( <a href="http://www.ricoh-imaging.com.cn">http://www.ricoh-imaging.com.cn</a> )

**<http://www.ricoh-imaging.co.jp/english>**

- Specifications and external dimensions are subject to change without notice.



## Free Manuals Download Website

<http://myh66.com>

<http://usermanuals.us>

<http://www.somanuals.com>

<http://www.4manuals.cc>

<http://www.manual-lib.com>

<http://www.404manual.com>

<http://www.luxmanual.com>

<http://aubethermostatmanual.com>

Golf course search by state

<http://golfingnear.com>

Email search by domain

<http://emailbydomain.com>

Auto manuals search

<http://auto.somanuals.com>

TV manuals search

<http://tv.somanuals.com>