



RICOH

RDC-6000

IMAGE CAPTURING DEVICE

Operation Manual

To ensure correct use of your digital camera, read this manual carefully before use. Keep the manual handy for future reference.

Introduction

Thank you for purchasing a Ricoh digital camera. This manual explains the correct handling procedures and precautions for your camera. To ensure the best performance, please read the manual thoroughly before using the camera. Keep the manual handy for quick future reference.

Ricoh Co., Ltd.

Test Shots

Check that your camera is recording the images correctly by taking a number of test shots.

Copyright

Reproduction or alteration of copyrighted documents, magazines, music and other materials, other than for personal, home or similarly limited purposes, without the consent of the copyright holder is prohibited.

Exemption from Liability

Ricoh Co., Ltd. assumes no liability for failure to record or play back images caused by malfunction of the digital camera.

Warranty

This product is manufactured to local specifications and the warranty is valid within the country of purchase. Should the product fail or malfunction while you are abroad, the manufacturer assumes no responsibility for servicing the product locally or bearing the expenditure incurred therefor.

Radio Interference

Operating the digital camera in the vicinity of other electronic equipment may adversely affect the performance of both devices. In particular, operating the camera close to a radio or television may lead to interference. If interference occurs, follow the procedures below.

- Move the camera as far away as possible from the TV, radio or other device
- Reorient the TV or radio antenna.
- Plug the devices into separate electrical outlets.

- This publication may not be reproduced in whole or part without the express written permission of Ricoh. ©2000 Ricoh Co., Ltd. All rights reserved.
- Ricoh reserves the right to change the contents of this publication without notice. Considerable care was taken in preparing this manual. If, however, you have questions about any part of the manual, or note mistakes or inaccuracies, please contact us at the address listed on the back cover.
- The illustrations in this manual may differ from this product. Those are used for the illustration purposes only.

Microsoft, MS and Windows are registered trademarks of Microsoft Corporation in the United States of America and other countries. Macintosh is a registered trademark of Apple Computer, Inc., in the United States of America and other countries. All trademarked company and product names mentioned in this manual are the property of their respective owners.

Safety Precautions

Warning Symbols

Various symbols are used throughout this instruction manual and on the product to prevent physical harm to you or other people and damage to property. The symbols and their meanings are explained below.



Warning

This symbol indicates matters that may lead to death or serious injury if ignored or incorrectly handled.



Caution

This symbol indicates matters that may lead to injury or physical damage if ignored or incorrectly handled.

Sample Warnings



The  symbol alerts you to actions that must be performed.



The  symbol alerts you to prohibited actions.

The  symbol may be combined with other symbols to indicate that a specific action is prohibited.

● Examples



Do not touch



Do not disassemble

Observe the following precautions to ensure safe use of this equipment.



Warning



- Turn off the power immediately in the event of irregularity, such as the equipment emitting smoke or a strange smell. Remove the batteries as soon as possible, being careful to avoid electric shocks or burns. If you are drawing power from a household electrical outlet, be sure to unplug the power cord from the outlet to avoid fire or electrical hazards. Discontinue use of the equipment immediately if it is malfunctioning. Contact the nearest service center at your earliest convenience.

Warning



- Turn off the power immediately if any metallic object, water, liquid or other foreign object gets into the equipment. Remove the batteries as soon as possible, being careful to avoid electric shocks or burns. If you are drawing power from a household electrical outlet, be sure to unplug the power cord from the outlet to avoid fire or electrical hazards. Discontinue use of the equipment immediately if it is malfunctioning. Contact the nearest service center at your earliest convenience.



- Avoid any contact with the liquid crystal inside the LCD monitor, should the monitor be damaged. Follow the emergency measures below in the following circumstances.
 - SKIN: If any of the liquid crystal gets on your skin, wipe it off and rinse the affected area thoroughly with water, then wash well with soap.
 - EYES: If it gets in your eyes, wash your eyes with clean water for at least 15 minutes and seek medical advice immediately.
 - INGESTION: If any of the liquid crystal is ingested, rinse the mouth out thoroughly with water. Have the victim drink a large amount of water and induce vomiting. Seek medical assistance immediately.



- Follow these precautions to prevent the batteries from leaking, overheating, igniting or exploding.
 - Do not use batteries other than those specifically recommended for the equipment.
 - Do not carry or store together with metal objects such as ballpoint pens, necklaces, coins, hairpins, etc.
 - If a strange odor, color change, etc., is noticed either during use or during charging, disconnect the camera immediately.

Warning



- Please observe the following in order to prevent fire, electrical shock or cracking due to the adapter.
 - Use only the indicated power supply voltage. Also avoid bunching wiring and extension cords.
 - Do not damage, bundle or alter power cords. Also, do not place heavy objects on power cords, or strongly pull or bend power cords.
 - Do not connect or disconnect the power plug with wet hands. Always grip the plug section when disconnecting a power cord.
 - Do not wrap in cloth, etc., during use.



- Keep the equipment out of the reach of children. Their inability to read and understand warnings and safety precautions may lead to accidents.



- Keep this product out of the reach of children. Children cannot understand and observe the items in “Safety Precautions” and “Usage Precautions” and can thus cause a malfunction to occur.



- Do not touch the internal components of the equipment if they become exposed as a result of being dropped or damaged. The high-voltage circuitry in the equipment could lead to an electric shock. Remove the batteries as soon as possible, being careful to avoid electric shocks or burns. Take the equipment to your nearest dealer or service center if it is damaged.



- Do not attempt to disassemble, repair or alter the equipment yourself. The high-voltage circuitry in the equipment poses significant electrical hazard.



- Do not use the equipment in the bathroom or shower as this could result in fire or electric shock.

Warning



- Do not use the equipment near flammable gases, gasoline, benzine, thinner or similar substances to avoid the risk of explosion, fire or burns.
- Do not use the equipment in aircraft or other locations where usage is restricted or prohibited as this may lead to disasters or accidents.



- Wipe off any dust that accumulates on the electrical plug as this may lead to fire.
- Use only the specified AC adapters (supplied) for this equipment in household electrical outlets. Other adapters pose the risk of fire, electric shock or injury.



- To avoid the risk of fire, electric shock or injury, do not use the AC adapter with commercially available electronic transformers when traveling abroad.

Observe the following precautions to ensure safe use of this unit.

Caution



- Contact with fluid leaking from a battery can lead to burns. If part of your body comes in contact with a damaged battery, wash the area with water immediately. (Do not use soap.) If a battery starts to leak, remove it immediately from the equipment and wipe the battery chamber thoroughly before replacing it with a new battery.



- Plug the power cords securely into the electrical outlets. Loose cords pose a fire hazard.



- Do not allow the camera to get wet. In addition, do not operate it with wet hands. Both pose the risk of electric shock.



- Do not fire the flash at drivers of vehicles, such as bicycles, cars and trains, as this may cause the driver to lose control and result in a traffic accident.



- Do not grasp batteries with metallic tweezers as this may form a short circuit and lead to fire or electric shock.

Safety Warnings for Accessories

- Safety warnings for the optional accessories, such as the remote control unit or the AC adapter, are contained in the instruction manual provided with each product and should be read thoroughly before operating the equipment.

CONTENTS

Safety Precautions	1
Camera Features	9
Parts & Names	10
Explanation of LCD Monitor Displays	12
LCD Monitor	12
LCD Panel	14
Menus	16
Basic Operation/Quick Reference	19
Preparations	19
Shooting	20
Playback	21
Erasing	22

Chapter 1 GETTING STARTED

Before Using the Camera	24
Checking the Package Contents	24
Attaching the Wrist Strap	24
Powering the Camera	25
Loading the Battery	25
Charging the Battery	27
Using an AC Adapter	27
SmartMedia Memory Cards	29
What is a SmartMedia Memory Card?	29
Inserting a SmartMedia Memory Card	30
Formatting a SmartMedia Memory Card	31
Setting the Date and Time	33
Adjusting the LCD Monitor Brightness	35
How To Hold the Camera	36

Chapter 2 BASIC SHOOTING

Operation Flow	40
Turning on the Camera	41
Selecting PIC (Image quality) Mode	42
Selecting Recording Mode	43
Digital Zoom	44
How to View Images on the LCD Monitor	45
Shooting	46

Special Shooting Functions	50
Recording Motion Picture Mode	50
Changing the Flash Mode	51
Setting the Exposure Modes	53
Changing the White Balance	56
Using the Self-Timer	59
Using Focus Lock to Take Pictures	60
Focus Modes	61
Using the Grid Templates	63
Redeye Reduction Mode	64
Changing the ISO Sensitivity	64
Recording Monochrome Images	65
Interval (Time Lapse) Shooting	66
Using Auto Bracket	68
Adding Image Quality Modes (Image Enlargement)	69

Chapter 3 PLAYBACK

Before Starting to Playback Recorded Images	72
Playback Display	72
Connecting to a TV	73
Playing Back a File	74
Playing Back Still Images, Text and Quick Shooting	75
Playing Back Motion Pictures	76
Special Playback Functions	77
Multi Image Playback	77
Zoom Playback	78
Auto Playback	79
Protecting a File	80
Setting DPOF (Digital Print Order Format)	81
Setting a Print Service	81

Chapter 4 ERASING

Erasing a File (Image)	86
Erase	86
Erase All Images	87
Erase Selected Files (Images)	88

Chapter 5 MISCELLANEOUS

Transferring Images to a PC	90
Installing Camera Utility Software	90
Changing Camera Settings	93
Formatting SmartMedia	93
Keep Settings	94
Auto Power Off Setting	95
Changing the LCD Off Setting	96
Changing OSD (On-Screen Display) Language	97
Changing Video-Out Signal Method (NTSC/PAL)	97
Changing LCD Confirmation	98
Changing the LCD Setting	99
Initializing Settings	99
Sequence Number Initialization	100
Using the Remote Control	101
Shooting	101
Playing	103
Erasing	104

APPENDIX

Accessories	108
Handling Precautions	109
Care and Storage	110
Troubleshooting	111
Using Your Digital Camera in Other Countries	114
About the Warranty and Servicing	115
Specifications	117
Recording Capacities	119

Camera Features

● 2,140,000-pixel resolution compact camera

With a 2,140,000-pixel resolution CCD, the compact camera produces high-quality, high-resolution images (1600 × 1200). The camera is so light you can carry it with you anywhere.

● Immediate recording

Using the camera is as simple as clicking the shutter release button. Images thus shot are written to a SmartMedia memory card (2/4/8/16/32/64 MB).

● Instant playback

You can instantly review recorded image files simply by switching to Play mode. You can also magnify the images zoom playback or display several images at once (6-image display).

● Multiple image recording modes

The RDC-6000 offers multiple image recording modes to suit your specific photographic needs, including F (Fine) mode, which puts the emphasis on image quality, N (Normal) and E (Economy) mode, which allows you to capture more images than any other mode.

● Digital zoom

The 4.0 × zoom lens allows you to capture subjects in a variety of compositions, from close-ups to shots with a background.

● Natural colors

The white balance feature allows you to capture a subject in its natural colors under any lighting conditions, indoors or outdoors.

● Close-ups

Macro mode for taking close-up shots at distances up to 13 cm (5.1 inches) is ideally suited for taking pictures of flowers and small objects, etc.

● Motion picture

Motion pictures can be recorded in two different image quality modes.

● Monitors images on the TV screen

Connect the digital camera to a TV set with the video interface cable supplied and you can display your image files on the TV screen. You can also connect the camera to a video deck or video printer to dub the images onto a videotape or make full color prints.

● Transfers images to a PC

You can transfer the images onto a PC using software compatible with the digital camera. When loaded onto a PC, the images can be printed on a color printer or color copier.

Parts & Names

■ Camera Body

Front

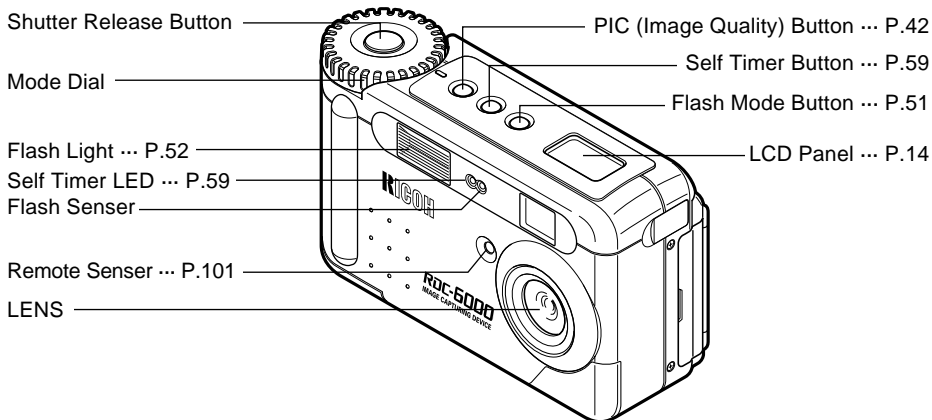

Back

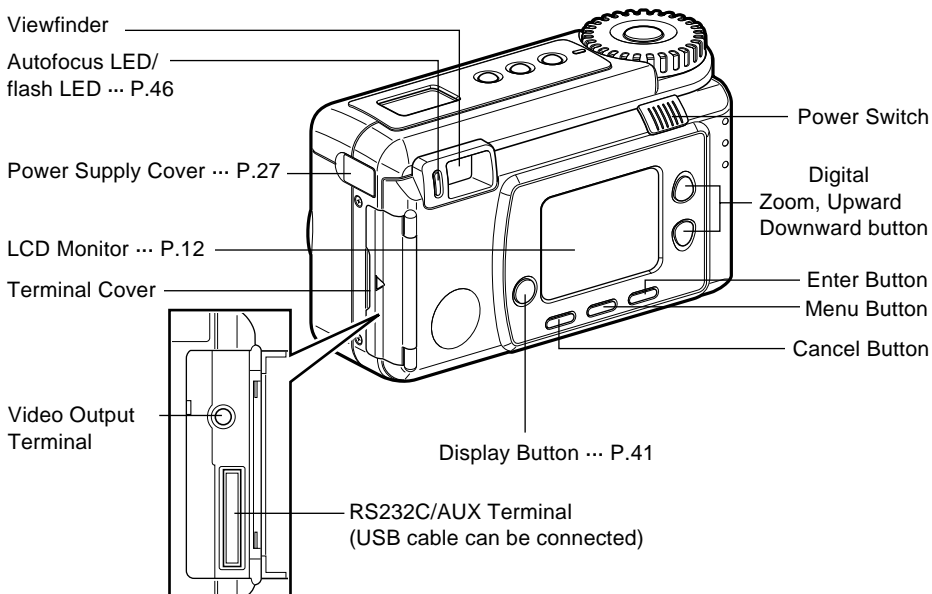

■ Bottom

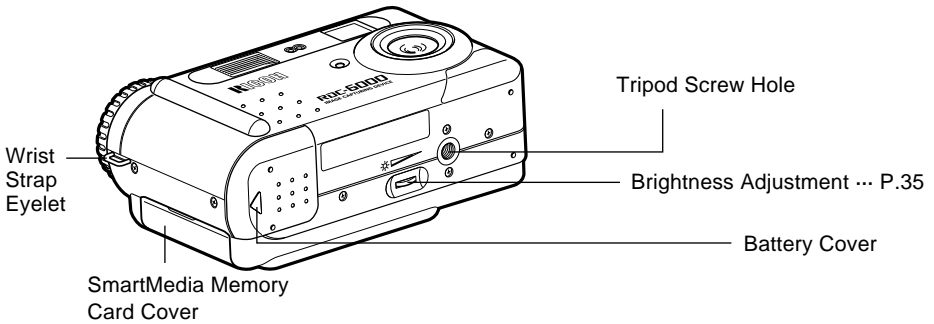

■ AC Adapter (100V – 240V)

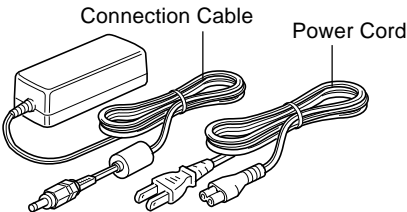

■ Rechargeable Battery DB-20

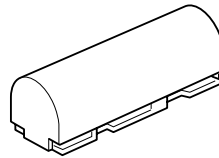

■ SmartMedia Memory Card

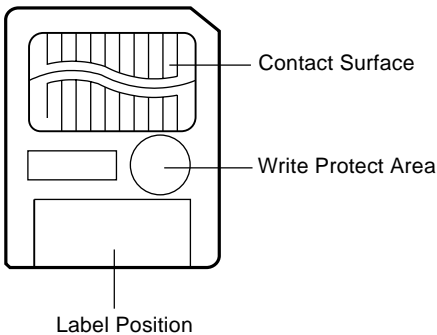

■ Remote Control Unit (Optional) (DR-3)

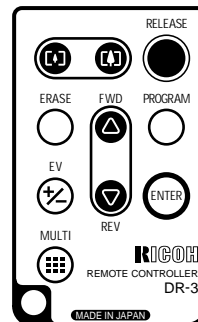

Explanation of LCD Monitor Displays

The LCD monitor or the LCD panel displays symbols and figures showing the status of your digital camera, such as the battery level, the number of pictures that can be taken, and the mode settings.

LCD Monitor

■ Recording Mode Display

- Recording Mode Display (Still image, Text, Quick shooting)

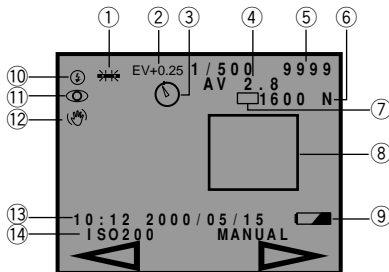

- ① White Balance Indicator (Auto, Daylight ☀, Overcast ☁, Tungsten 🔥, Fluorescent 💡, User Define (U), W/B Calibration (W)) (P.56)
- ② EV +/- (P.54)
- ③ Self-Timer (⌚) (P.59)
- ④ Exposure Mode Display (P.53)
- ⑤ Recording Data Indicator (Displays the remaining no. of pictures)
- ⑥ PIC Mode (1600, 800, 640, F, N, E) (P.42)
- ⑦ Recording Mode (□, △, ▭) (P.43)
- ⑧ Manual Focus Indicator (Displays when in manual focus)
- ⑨ Battery (🔋) (P.26)
- ⑩ Flash Mode (🔦, 🔦, 🔦, 🔦 Flashing) (P.51)
- ⑪ Redeye Reduction Mode (👁) (P.64)
- ⑫ Exposure Warning (⚠) (P.47)
- ⑬ Date & Time Display
- ⑭ ISO Sensitivity (P.64)
- ⑮ Recordable time
- ⑯ File Name
- ⑰ Image Protected Mark (🔒) (P.80)
- ⑱ Number of Image
- ⑲ Zoom Playback (P.44)
- ⑳ AV1 file (Motion Picture file)
- ㉑ Shooting Date and Time

■ Motion Picture Mode Display

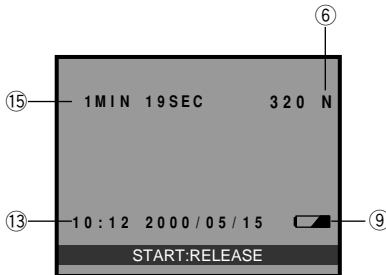

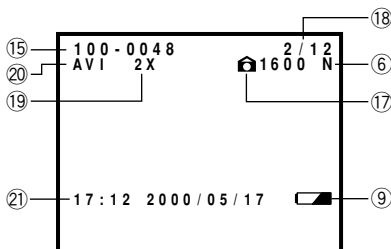

■ Playback Mode Display



- Note** • All items of information are shown for illustration purposes. During actual camera operation, only the relevant items are displayed.

■ Warning Message

If any of the warning messages listed below appear on the camera's LCD monitor, read the corresponding explanation and take the corrective action suggested.

Warning Message	Status	Explanation and Remedy	Reference Page
	Flashing	Indication low batteries. Have replacement batteries ready	P.27
	Lit	System in processing	–
CARD FULL	Flashing	The SmartMedia Memory Card has run out of memory	P.29
NO CARD	Flashing	The SmartMedia memory card is out of position. Mount a SmartMedia memory card	P.30
NO IMAGE	Lit	There are no files to play. Mount a SmartMedia memory card with files recorded on it.	P.74
WRITE PROTECTED	Flashing	A write-protected SmartMedia memory card is found. Remove the write protection label from the card to gain access to it	P.29
UNMATCHED FILE	Flashing	You attempted to play an unplayable file.	P.74
FILE NUMBER OVER	Flashing	No more file numbers can be added. Insert a new SmartMedia memory card to continue recording.	P.30
SET DATE/TIME	Flashing	The date has not been set. Set the date before starting operations with the camera.	P.33

■ Error Messages

If any of the error messages listed below appear on the camera's LCD monitor, read the corresponding explanation and take the corrective action suggested.

Error Message	Explanation and Remedy	Reference Page
CARD ERROR	The SmartMedia memory card is unformatted. Format the card with the camera before using it.	P.31
	A SmartMedia memory card of this type is not supported by this camera. Use another type of SmartMedia.	P.29

Note If the above remedies are carried out and the error display still won't clear, call your dealer or our service center.

LCD Panel

■ Displays Appearing during Recording

Recording

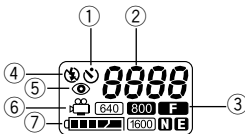

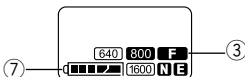

- ① Self-Timer (🕒) (P.59)
- ② Recording (📷)
- ③ PIC Mode (1600, 800, 640, F, N, E, B) (P.42)
- ④ Flash Mode (🔆, 🔆^A, 🔆^B, 🔆^C Blink) (P.51)
- ⑤ Redeye Reduction (👁️) (P.64)
- ⑥ Motion picture (🎞️) (P.50)
- ⑦ Battery (🔋) (P.26)

Playback/Erase





- Only the Motion Picture mode [], PIC mode [F,N] and battery mark [] are displayed when the motion picture mode is set.

■ Error display and countermeasure

When the following error is displayed, check the cause and take the proper countermeasure.

Error display	Countermeasure	Reference
	<ul style="list-style-type: none"> • The SmartMedia is not formatted. Use this camera to format before continuing. • The SmartMedia cannot be used with this camera. Use a different SmartMedia. 	<p>31</p> <p>30</p>



- If the error display does not disappear after the above countermeasures have been taken, please contact your local dealer or Ricoh repair center.

Menus

This camera features four menus which can be used to enter or change the settings for recording, playing or erasing image files.

■ SET Menu

With the camera turned on, set the mode dial to **[SET]**. To cancel the setup menu, turn the mode dial to select another mode.

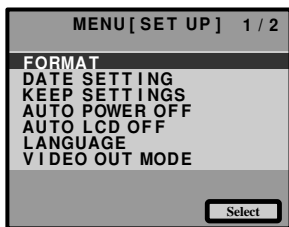

FORMAT: Formats a SmartMedia memory card. (P.31)
DATE SETTING: Sets the date and time. (P.33)
KEEP SETTINGS: Saves camera settings. (P.94)

AUTO POWER

OFF: Enables or disables the camera (P.95)

AUTO LCD OFF Enables or disables the LCD (P. 96)

LANGUAGE: Switches the LCD monitor display between English, German, French and Japanese. (p.97)

VIDEO OUT MODE: ... Switches the camera between NTSC and PAL when it is connected to a TV set. (P.97)

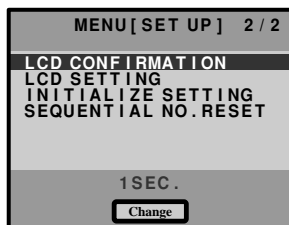

LCD

CONFIRMATION: Sets the confirmation time for images after shooting. (P.98)

LCD SETTING: Selects whether to let the camera come up with the LCD monitor enabled or disabled when it is powered on in a recording mode. (P.99)



INITIALIZE

SETTING: Initialize all the settings. (P.99)

SEQUENTIAL

NO. RESET: Reset the images sequence number orderly. (P.100)

■ Record Menu

With the camera turned on, set the mode dial to [] and press the MENU button. To exit the record menu, press the CANCEL [] button.

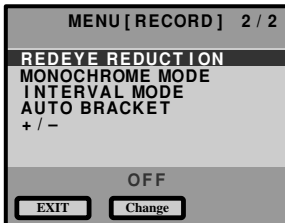

RECORDING

MODE: Switches between recording modes, such as still picture, text, quick shooting (P.43).

GRID TEMPLATE Sets crossed lines to assist with image taking. (P.63)

WHITE BALANCE: Switches between the white balance settings (P.56).

EXPOSURE MODE: ... PROGRAM and AV F NO setting. (P.53)

IMAGE

ENLARGEMENT: Take the picture by 1.5 times magnification (P.69)

ISO SENSITIVITY: Selects ISO sensitivity among 100, 200 and 400. (P.64)

FOCUS: Switches between AUTO, MACRO, AREA, 2.5M, INFINITY and MANUAL. (P.61)

REDEYE

REDUCTION: Reduces the red-eye when shooting live subjects with flash. (P.64)

MONOCHROME

MODE: Records images in Black & White or sepia. (P.65)



INTERVAL MODE: Switches interval (time lapse) setting on and off (P.66).

AUTO BRACKET: Three frames are exposed: one frame at the current exposure compensation value, one at -0.5EV and another at +0.5EV. (P.68)

+/- (Exposure

compensation): Sets the exposure compensation (P.54).

■ Play Menu

With the camera turned on, set the mode dial to [] and press the MENU button. To exit the play menu, press the CANCEL [] button.



ZOOM PLAYBACK: ... Displays an enlarged image. (P.78)

AUTO PLAYBACK: ... Plays all images automatically within a preset length of time. (P.79)

PROTECT: Protects image files from erasure. (P.80)

DPOF: Select this function to generate recorded images for submission to digital printing services or other applications. (P.81)

■ Erase Menu

With the camera turned on, set the mode dial to []. To exit the erase menu, set the mode dial to another mode.

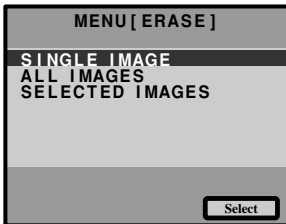



SINGLE IMAGE: Erases selected images one at a time (except protected images) (P.86).

ALL IMAGES: Erases all the files from the card (except protected images) (P.87).

SELECTED IMAGES:.. Erases multiple selected images (except for protected files) at once. (P.88)

* Protected files cannot be erased.

Note

- The [] setting on the mode dial is used to take motion picture mode.
- The [] setting on the mode dial is used to transfer image files from the camera to a PC.

Basic Operation/Quick Reference

This section provides introductory information about the Ricoh RDC-6000 digital camera. Further details can be found in the reference pages mentioned below.

Preparations

Loading the Batteries (P.25-26)

- 1 Load the batteries into the camera.**
Charge the batteries before loading. (P.27)
* When using an AC adapter, connect it to the camera and then to the AC outlet. (P.27)

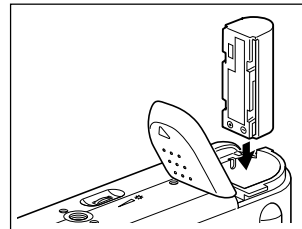
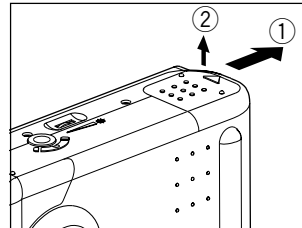

Inserting a SmartMedia Memory Card (P.29-32)

- 1 Make sure that the camera is turned off.**
- 2 Open the card cover and insert a SmartMedia memory card.**
 - Before using a new SmartMedia memory card, you must first format (initialize) it with the camera. (P.31)

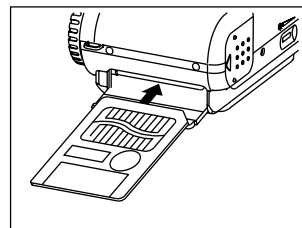
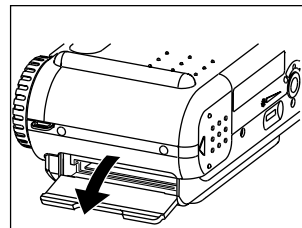

Setting the Date and Time (P.33-34)

- ❶ Slide the power switch and set the mode dial to [SET].
- ❷ Press the or button to select [DATE SETTING].
- ❸ Press the ENTER button.
- ❹ Press the or button to change the digit.
- ❺ Press the MENU button.
Repeat steps ❹ and ❺ above to complete the settings.
* Each time you press the MENU button, the cursor will move, from year to month, day, hour and minute.
- ❻ After you have set the number of minutes, press the ENTER button.

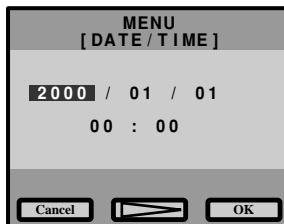
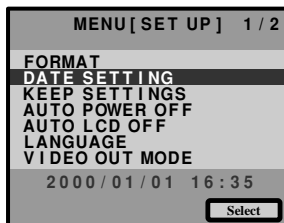



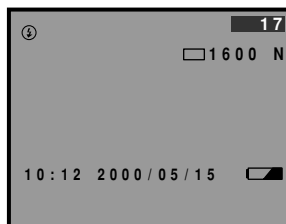
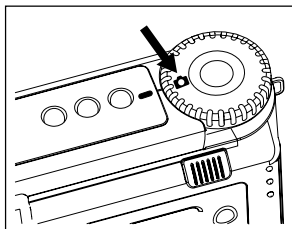

Shooting

Basic Shooting Procedure (P.40-49)

- ❶ Slide the power switch and set the mode dial to [].
- ❷ Press the PIC button to select a PIC (Image quality) mode.
- ❸ Setting the recording mode
 1. Press the MENU button to display the Record menu.
 2. Press the and buttons and select Record Mode.
 3. Press the MENU button and select [].
 4. Press the CANCEL button to return the display.
- ❹ Press the or button to select the desired size of the subject.
* When digital zoom is used, use the LCD monitor to position the subject.
- ❺ Press the shutter release button to record the image.



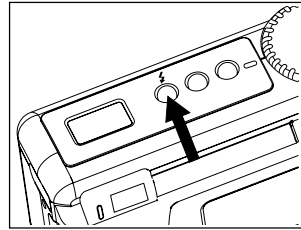

Changing the Flash Mode (P.51-52)

- 1 Set the mode dial to [].
- 2 Press the flash mode button to select a flash mode.
You can choose Flash Off () , Auto (A) , Forced Flash () , or Slow synchro mode ( : flashing).
The selected mark will be displayed on the LCD monitor or on the LCD panel.
- 3 Press the shutter release button to record the image.



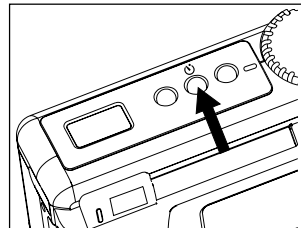

Using the Self-Timer (P.59)

- 1 Set the mode dial to [].
- 2 Press the self timer button.
The self timer is now set.
The  mark will be displayed on the LCD monitor or on the LCD panel.
- 3 Press the shutter release button to record the image.
The self timer LED will start flashing and the shutter will be released after a delay of about 10 seconds.



Playback

Playing Back Files (P.74-79)

- 1 Slide the power switch on and set the mode dial to [].
- 2 Press the  or  button to select a file you wish to view

* The multi-image and zoom playback features allow you to view several image files at once or magnify an image. (P.77)

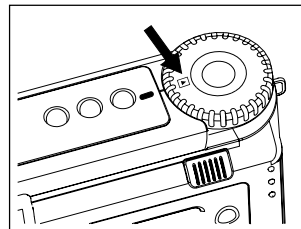



Erasing

Erasing Files (P.86-88)

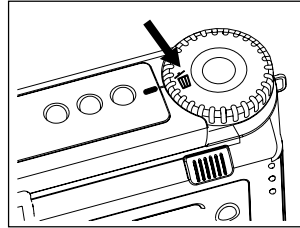
- 1 Slide the power switch on and set the mode dial to [].





- 2 Press the  or  button to select the erase mode and press the ENTER button.



* Remember that files cannot be restored once they are erased. Before starting to erase a file, make sure that you want to erase it.

If you selected [SINGLE IMAGE]

- 3 Press the  or  button to select a file you want to erase and press the shutter release button.



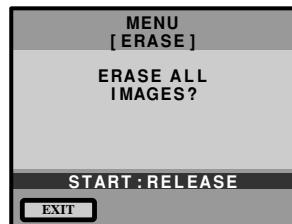

If you selected [ALL IMAGES]

- 3 Press the shutter release button.



If you selected [SELECTED IMAGES]

- 3 Press the  or  button to select a file you want to erase and press the ENTER button.

Repeat step 3, as needed, to erase additional files at a time. And press the ENTER button again to cancel the erasure setting.

- 4 Press the shutter release button.



Free Manuals Download Website

<http://myh66.com>

<http://usermanuals.us>

<http://www.somanuals.com>

<http://www.4manuals.cc>

<http://www.manual-lib.com>

<http://www.404manual.com>

<http://www.luxmanual.com>

<http://aubethermostatmanual.com>

Golf course search by state

<http://golfingnear.com>

Email search by domain

<http://emailbydomain.com>

Auto manuals search

<http://auto.somanuals.com>

TV manuals search

<http://tv.somanuals.com>