

RICOH



PJ WX4130N

Operating Instructions

For safe and correct use, be sure to read "Safety Information" before using the machine.

TABLE OF CONTENTS

Introduction.....	5
Copyrights to Images.....	5
Important.....	5
Notes to Users Viewing 3D Images.....	5
Manuals Provided with the Projector.....	7
Manuals for the Projector.....	7
Manuals List.....	7
Viewing the PDF Manual on the CD-ROM.....	9
How to Read This Manual.....	10
Symbols.....	10
Notes.....	10

1. Preparations for Using the Projector

Main Functions.....	11
Checking the Accessories.....	13
Projector Parts and Their Functions.....	15
Control Panel (Top View).....	15
Front and Left-Side View.....	16
Rear and Right-Side View.....	17
Remote Control Parts and Their Functions.....	18
How to Use the Remote Control.....	20
Effective Range of the Remote Control.....	20
Loading Batteries into the Remote Control.....	21
Inputting Text.....	22
Operating a Computer with the Remote Control.....	23
Operating Multiple Projectors with the Remote Control.....	24
Positioning the Projector.....	26
Relationship Between the Projection Distance and the Screen Size.....	26
Connecting Equipment to the Projector.....	28
Connecting a Computer.....	28
Connecting AV Equipment.....	29
Connecting the Power Cord.....	30

2. Projecting an Image

Basic Operations.....	33
-----------------------	----

Turning On the Projector.....	34
Selecting an Input Signal.....	35
Adjusting the Angle of the Projection.....	36
Adjusting the Image.....	37
Adjusting the Volume of the Speaker.....	40
Manipulating Images with the Remote Control.....	40
Turning Off the Projector.....	44
Projecting Images from a USB Memory Device or Digital Camera.....	46
Connecting the USB Device.....	47
Projecting Still Images.....	47
Projecting Videos.....	48
Disconnecting the USB Device.....	49
Converting Presentation Files to JPEG Files.....	49

3. Using the Projector via a Network

Connecting the Projector to a Network.....	53
Connecting Using an Ethernet Cable.....	55
Connecting Using a Wireless LAN.....	57
Wireless LAN Connection Workflow.....	57
Simple Wireless LAN Setup.....	59
Projecting Images Using Network Utility.....	61
What Is Network Utility?.....	61
Simple 1:1 Connection.....	62
Network Connection.....	63
Settings Using a USB Memory Device.....	64
Using the Projection Server Function.....	67
Configuring the Network Server.....	67
Configuring the Projector.....	68
Projecting Files that Are Stored on the Server.....	68

4. Changing the Projector Settings

Viewing the Menu Screen.....	71
Using the Menu Screen.....	73
Restoring Settings to Their Default Settings.....	77
List of Menu Items.....	79

Image Adjustment Menu.....	83
Display Settings Menu.....	87
Default Settings Menu.....	90
Network/USB Settings Menu.....	95
USB Settings.....	95
Network Settings.....	96
Network Application Settings.....	103
Display Status.....	105
5. Troubleshooting	
Indicator Display List.....	107
Common Problems.....	110
6. Maintenance	
Operating Precautions.....	115
Cleaning the Projector.....	116
Cleaning the Projection Window.....	116
Cleaning the Projector.....	116
Replacing the Lamp.....	117
Managing the Projector Using Projector Management Utility.....	120
Installing Projector Management Utility.....	120
Settings Required to Use Projector Management Utility.....	121
Starting Projector Management Utility.....	121
Consumables.....	123
7. Appendix	
Specifications.....	125
Specifications for the Projector.....	125
List of Compatible Signals.....	127
Computer Input.....	127
Y/Pb/Pr Input.....	129
Video Input.....	130
HDMI Input.....	130
Specifications for Ports.....	134
Computer In Port.....	134
Control Port.....	135

Copyrights.....	137
Where to Inquire.....	138
Trademarks.....	139
INDEX	141

Introduction

Copyrights to Images

When projecting images using the projector, be careful not to infringe the copyright of protected materials.

The following are examples that may infringe the copyright of protected materials.

- Broadcasting images or movies for commercial purposes
- Modifying images or movies using functions such as freeze, magnify, or zoom to broadcast images for commercial purposes or public viewing
- Varying the aspect ratio of images or movies using a function that changes the screen size to broadcast images for commercial purposes or public viewing

Important

In no event will the company be liable for direct, indirect, special, incidental, or consequential damages as a result of handling or operating the machine.

The manufacturer shall not be responsible for any damage or expense that might result from the use of parts other than genuine parts from the manufacturer with your office products.

Notes to Users Viewing 3D Images

Pay attention to the following points when viewing images using 3D glasses with the projector:

- How 3D images are viewed may vary according to the individual.
- Do not use 3D glasses for viewing any material other than 3D images.
- Before viewing 3D images, make sure to read the manuals provided with your 3D glasses and 3D compatible content.
- Avoid viewing 3D images for a long period of time. Take a break of 15 minutes or longer after every hour of viewing.
- If you feel sick while viewing 3D images, stop viewing them. If you continue to feel sick, consult a doctor.
- When viewing 3D images in a room where an LED lighting system or fluorescent lights are used, you may feel that the light in the room flickers. If this is the case, dim the lights until you do not notice any flickers, or turn off the lights.
- If you or any member of your family has a history of light-sensitive seizures, consult a doctor before viewing 3D images.

-
- To view 3D images, sit in front of the screen so that your eyes are parallel and level with the screen.
 - Viewing 3D images from a place that is too close to the screen may result in eye strain. The distance between the screen and you should be at least three times the height of the screen.
 - Adult supervision is required for children using 3D glasses.
 - Viewing 3D images is not recommended for children under 6 years old. It may negatively affect development of their vision. Consult a doctor before using 3D glasses.

Manuals Provided with the Projector

Manuals for the Projector

Read this manual carefully before you use the projector.

Refer to the manuals that are relevant to what you want to do with the projector.

★ Important

- The manuals are provided in various formats.
- Adobe® Acrobat® Reader®/Adobe Reader must be installed in order to view the manuals as PDF files.

Safety Information

Provides information about safe usage of the projector.

To avoid injury and prevent damage to the projector, be sure to read Safety Information.

Setup Guide

Provides basic information about how to install the projector. Since the contents of this manual are a summary of Operating Instructions, see Operating Instructions for detailed information.

Operating Instructions

Provides information about how to install the projector, how to project images using the projector, and how to configure the projector. It also provides information about troubleshooting and maintenance.

↓ Note

- The following software products are referred to using general names:

Product name	General name
RICOH PJ Network Utility Type A	Network Utility
RICOH JPEG Conversion Tool Type A	JPEG Conversion Tool

Manuals List

Manual Name	Printed Manuals Provided	PDF Manuals Provided
Safety Information	Yes	No
Setup Guide	Yes	No

Manual Name	Printed Manuals Provided	PDF Manuals Provided
Operating Instructions	No	Yes

Viewing the PDF Manual on the CD-ROM

This section describes how to view the PDF manual on the supplied manual CD-ROM.

File path

The manual is included in the following folder on the CD-ROM:

Manual\<(language)

1. **Insert the CD-ROM in the CD-ROM drive of your computer.**
2. **Specify a language.**

The launcher screen appears.

3. **Click [Read PDF manuals].**

The PDF manual is displayed on the screen.

Note

- To view the PDF manuals, you need to have Adobe Acrobat Reader/Adobe Reader installed on your computer.

How to Read This Manual

Symbols

This manual uses the following symbols:

 **Important**

Indicates points to pay attention to when using the projector.

 **Note**

Indicates supplementary explanations of the projector's functions, and instructions on resolving user errors.

[]

Indicates the names of buttons on the control panel and remote control. It also indicates items displayed on the menu screens.

Notes

Contents of this manual are subject to change without prior notice.

Two kinds of size notation are employed in this manual.

Some illustrations in this manual might be slightly different from the machine.

Certain options might not be available in some countries. For details, please contact your local dealer.

Depending on which country you are in, certain units may be optional. For details, please contact your local dealer.

1. Preparations for Using the Projector

This chapter explains the names and functions of the different parts of the projector and remote control, and how to use them. It also explains how to position the projector and how to connect it to other equipment.

Main Functions

The projector features the following functions that you can use.

Auto set function

The projector detects the signal and adjusts for flickering and the position of the projected image if you press the [Auto set] button when the projector is connected to a computer.

Auto keystone function

The projector automatically adjusts the shape of the projected image according to the angle at which the projector is positioned.

AV Mute/Freeze

Pressing the [AV Mute] button mutes the sound and blanks the screen. Pressing the [Freeze] button pauses the image temporarily.

Magnify/Zoom

Pressing the [Magnify] button enlarges the projected image. Pressing the [Zoom] button reduces the projected image.

Wall color correction

You can adjust the hue of the image in accordance with the color of the wall on which it is projected.

Password setting/Key lock

You can specify a password for the projector to limit the people that can use it. The buttons on the control panel can be disabled with the key lock setting to prevent misoperation.

Administrator authentication

Enable administrator authentication so that only the administrator can change the security settings. This improves the security of the projector because general users cannot change the settings.

User logo function

The projector can project a registered logo or image when there is no signal or when it is starting up.

Presentations without a computer

The projector can project JPEG or MPEG files from a USB memory device that is connected to it. JPEG files stored on a digital camera can also be projected.

It is possible to convert PowerPoint materials to JPEG format using JPEG Conversion Tool and then project them using the projector.

Mouse remote control

You can operate the mouse pointer on a computer by using the remote control provided with the projector.





Network Utility

Network Utility is an application that is provided with the projector and is used for connecting the projector and a computer to project images. You can also easily specify wireless LAN settings using this application.

Checking the Accessories

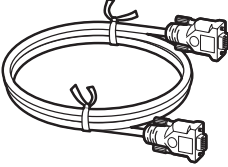
The projector is provided with the following accessories. Make sure that everything is included in the package.

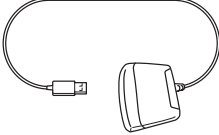
If anything is missing or damaged, contact your sales representative or service representative.

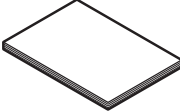
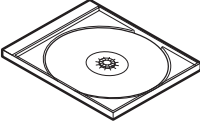
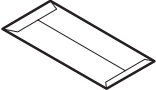
Remote control AAA battery LR03 (2 ea)	
RGB cable (3 m)	
Power cord	
Mouse remote control receiver	
Carrying bag	
Safety Information Setup Guide	
CD-ROM	
Warranty card	

 **Note**

- The bundled accessories may vary depending on the location that this product was purchased.
- Use only the RGB cable provided with the projector.
- Use only the power cord set provided with the projector.
- The Operating Instructions and various applications are on the provided CD-ROM. For procedures about how to read Operating Instructions, see p.9 "Viewing the PDF Manual on the CD-ROM". For instructions about using the applications, see p.51 "How to use JPEG Conversion Tool", p.61 "How to use Network Utility", and p.120 "Managing the Projector Using Projector Management Utility".

Projector Parts and Their Functions

Control Panel (Top View)

1

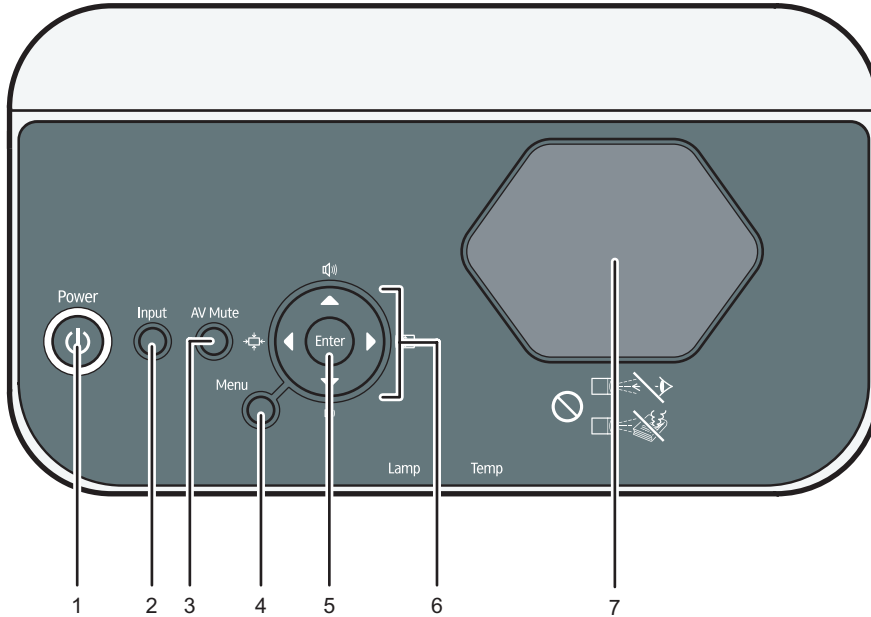

CLB009

1. [Power] button

Turns the projector on and off. You can confirm the status of the projector with the indicator.

- On: Power is on.
- Off: Power is off.
- Flashing at 1 or 3 second intervals: Standby.
- Flashing at short intervals: Starting up or cooling.

2. [Input] button

Switches the signal input. The input signal changes each time the button is pressed.

3. [AV Mute] button

Temporarily blanks the screen and mutes the audio.

4. [Menu] button

Displays the menu screen. Press it again to close the menu screen.

5. [Enter] button

Enters the selected mode.

6. Arrow buttons

Used to operate the menu screen. The [▶] and [◀] buttons are used to adjust the size of the projected image. The [▲] and [▼] buttons are used to adjust the volume.

7. Projection window

Enlarges and projects the image (light).

↓ Note

- The top of the projector is covered with a protective film when it is shipped. Remove the film before using the projector.

Front and Left-Side View

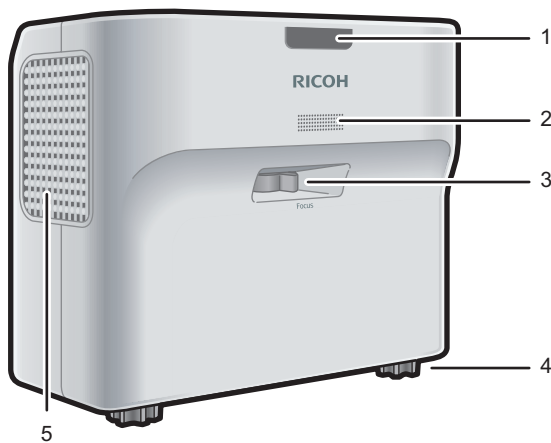

CLB010

1. Remote control receiver, LED indicators

Receives the signal from the remote control. You can confirm the status of the projector by referring to the LED indicators. The left LED shows the status of the lamp, and the right LED shows the temperature inside the projector. For details, see p.107 "Indicator Display List".

2. Speaker

Outputs the audio input from an external device.

3. Focus lever

Adjusts the focus of the image.

4. Adjustable feet

Adjusts the angle of the projection.

5. Exhaust vents

Releases hot air from inside the projector.

Rear and Right-Side View

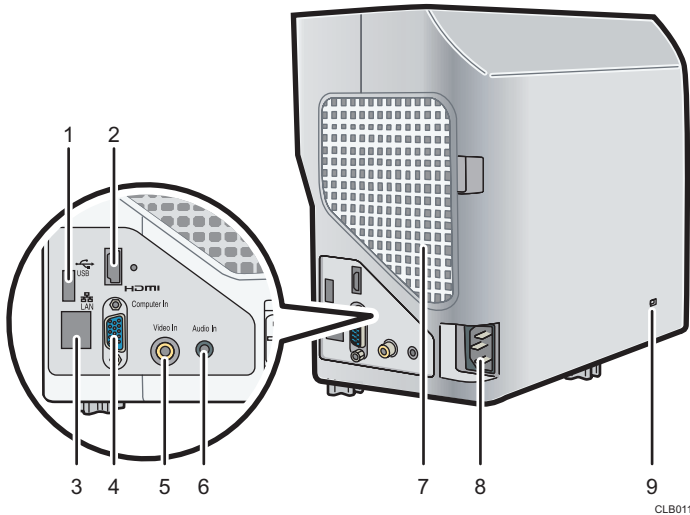

1. USB port

For connecting a USB memory device or USB device cable.

2. HDMI port

For connecting an HDMI (High-Definition Multimedia Interface) cable.

3. LAN port

For connecting an Ethernet cable.

4. Computer In port (Y/Pb/Pr)

For inputting RGB signals from a computer or component image signals (Y/Pb/Pr) from a video player.

5. Video In port

For inputting image signals from a video player.

6. Audio In port

For inputting audio signals from a computer or video player.

7. Intake vents

For circulating air from the outside to cool the projector.

8. AC In socket

For connecting the power cord set provided with the projector.

9. Security slot

For connecting an anti-theft cable.

Remote Control Parts and Their Functions

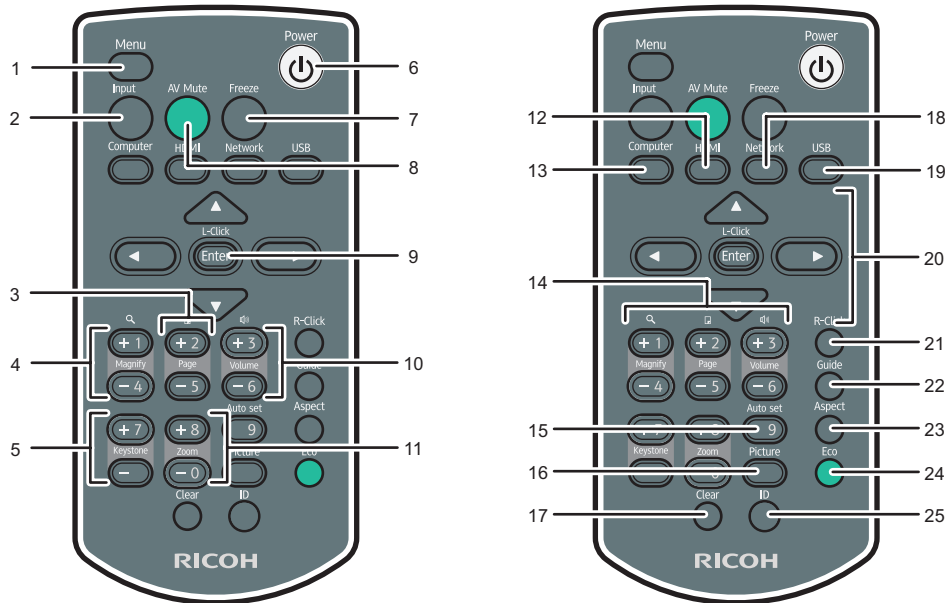

CLB013

1. [Menu] button

Displays the menu screen. Press it again to close the menu screen.

2. [Input] button

Switches the signal input. The signal that is input changes each time the button is pressed.

3. [Page] buttons

Changes slides, such as in a PowerPoint presentation. Press [−] to go to the next page. Press [+] to go to the previous page. These buttons can be used when the mouse remote control receiver is connected to a computer.

4. [Magnify] buttons

Enlarges the image. Press the [+] button to enlarge the image. Press the [−] button to reduce the image to its original size.

5. [Keystone] buttons

Adjusts for keystone distortion. Press the [+] button to increase the correction value. Press the [−] button to decrease the correction value.

6. [Power] button

Turns the projector on and off.

7. [Freeze] button

Temporarily pauses the image.

8. [AV Mute] button

Temporarily blanks the screen and mutes the audio.

9. [Enter] button

Enters the selected item or mode.

10. [Volume] buttons

Adjusts the volume of the speaker. Press the [+] button to increase the volume. Press the [-] button to decrease the volume.

11. [Zoom] buttons

Reduces the image. Press the [-] button to reduce the image. Press the [+] button to enlarge the image to its original size.

12. [HDMI] button

Switches to HDMI input mode.

13. [Computer] button

Switches to computer input mode. If only the Y/Pb/Pr signal is input, the Y/Pb/Pr screen appears when you press this button.

14. Number buttons

Used to enter numbers.

15. [Auto set] button

Automatically adjusts the image to match the signal input from a computer.

16. [Picture] button

Switches the screen mode.

17. [Clear] button

Deletes entered characters.

18. [Network] button

Switches to network input mode.

19. [USB] button

Switches to USB input mode.

20. Arrow buttons

Used to operate the menu screen.

21. [R-Click] button

Used to operate the computer with the remote control. It is the same as the right-click button on a mouse.

22. [Guide] button

Displays the operation guide for slideshows.

23. [Aspect] button

Switches the size of the projected image.

24. [Eco] button

Switches the lamp power level.

25. [ID] button

Registers the remote control ID.

How to Use the Remote Control

1

You can use the remote control to turn the projector on and off, and to change the signal of the image being input and projected. You can also enlarge or reduce the image and mute the audio.

Note the following precautions when using the remote control:

- Do not drop or hit the remote control.
- Do not place the remote control in a place that is very hot or very humid.
- Do not get the remote control wet. Also, do not place it on anything that is wet.
- Do not dismantle the remote control.

Effective Range of the Remote Control

Point the remote control at the remote control receiver on the projector to use it.

The effective range of the remote control is about 4.5 meters (14.7 feet) from the receiver and at an angle of about 15 degrees to the remote control receiver on the projector.

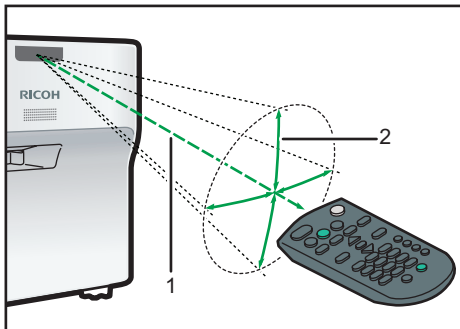

1. Distance: up to 4.5 meters (14.7 feet)

2. Angle: within 15 degrees

↓ Note

- The remote control may not be effective in some areas and in some conditions. If this happens, point the remote control at the projector and try it again.
- The remote control may not work if the remote control receiver on the projector is exposed to sunlight, fluorescent light, or strong light.

Loading Batteries into the Remote Control

WARNING

- For safe operation, follow the warnings below regarding the batteries used in the remote control. If you use the batteries incorrectly, it may result in fire or injury due to batteries leaking or exploding.
 - Do not use batteries other than the ones specified.
 - Do not mix and use batteries that are different types or that are new and old.
 - Correctly insert batteries according to the polarity (+/-).
 - Do not charge non-rechargeable batteries.
 - Do not heat or throw the batteries into fire or water.
 - Do not connect the positive and negative terminals on a battery with a wire.
 - Remove the batteries from the remote control that are past their suggested use period or that are depleted.
 - Remove the batteries when they will not be used for extended periods.
 - Keep the batteries out of the reach of children. Children may swallow or choke on the batteries. If this happens, contact a doctor immediately.

1. Remove the battery cover from the remote control.

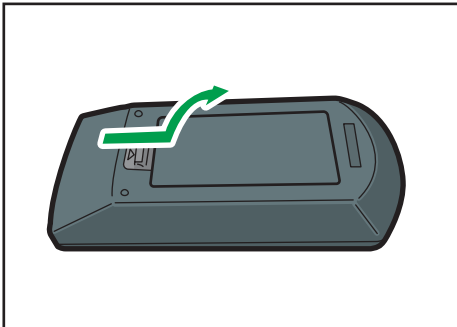

CLB015

2. Insert the batteries.

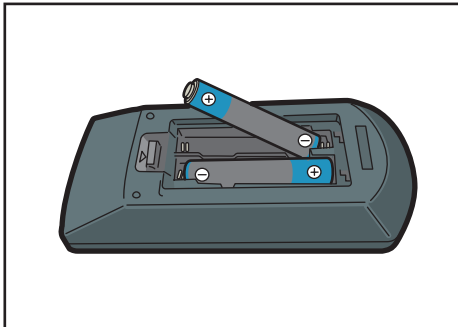

CLB016

Note the direction of the positive and negative terminals when inserting the batteries.

3. Close the battery cover.

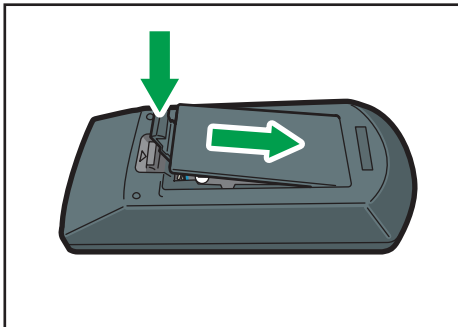

CLB017

↓ Note

- Replace the batteries if the remote control does not work or if the effective distance becomes too narrow.

Inputting Text

Use the keyboard that is displayed on screen to input text on the setting screen.

1. Use the [▲], [▼], [◀], and [▶] buttons on the remote control to select a character on the screen.

The selected character is highlighted in orange.

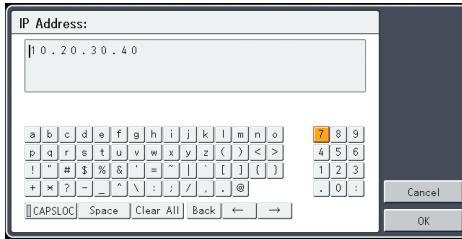

2. Press the [Enter] button.

The selected character appears in the text area.

3. After inputting all the characters, select [OK].

4. Press the [Enter] button.

The text is input.

↓ Note

- You can also use the number buttons on the remote control to input numbers.

Operating a Computer with the Remote Control

You can operate a computer using the projector's remote control. This function can be used when the mouse remote control receiver is connected to a computer.

A computer with a USB port that supports USB 2.0 can be used. Supported operating systems are Windows XP, Vista, and 7.

★ Important

- Connect the mouse remote control receiver to a computer only when operating the computer with the remote control. When operating the projector with the remote control while the mouse remote control receiver is connected to the computer, the pointer on the computer screen also moves according to the key operations of the remote control.

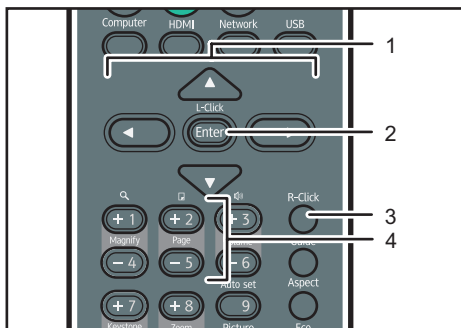

CLB018

1. Arrow buttons

Moves the mouse pointer. Press the button that corresponds to the direction you want to move the pointer.

2. [Enter] button

Left clicks.

3. [R-Click] button

Right clicks.

4. [Page] button

The [+] and [-] buttons change the pages in a PowerPoint presentation.

1. Connect the mouse remote control receiver to the computer.

2. Point the remote control at the mouse remote control receiver and press the buttons.

Note

- Some computers cannot be operated using the projector's remote control.
- The remote control may not work if the mouse remote control receiver is exposed to sunlight, fluorescent light, or strong light. If this happens, change the position or orientation of the mouse remote control receiver.
- To drag-and-drop, hold down the [Enter] button while moving the pointer with the arrow buttons, and then release the button at the targeted location.

Operating Multiple Projectors with the Remote Control

You can operate multiple projectors with a single remote control. It is possible to operate a maximum of four projectors.

You need to specify an ID number to assign to each projector in [Remote Control ID] under [Default Settings] in advance.

1. While pressing the [ID] button, press the number button that corresponds to the ID number of the projector to be operated for three seconds or more.

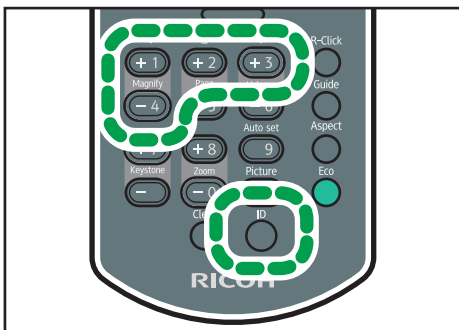

CLB020

The ID number assigned to the remote control is changed.

2. Operate the projector.

 **Note**

- The remote control cannot operate a projector unless the ID on the remote control is the same as the controller ID specified in the projector's Default Settings menu.
- The ID number specified in the remote control is effective until a different ID number is specified.
- The ID number in the remote control must be specified again if the batteries are changed.

Positioning the Projector

When positioning the projector, place it so that the projector's rear side faces the screen. Make sure the projector and the screen are parallel to each other.

Adjust the distance between the projector and the screen according to the size of the projected image. For details, see p.26 "Relationship Between the Projection Distance and the Screen Size".

Projection Mode

You can position the projector in one of two ways.

Select the setting according to the position of the projector in [Projection Mode] under [Default Settings]. For details, see p.90 "Default Settings Menu".

- Standard

The projector is placed in front of a screen onto which the images are projected.

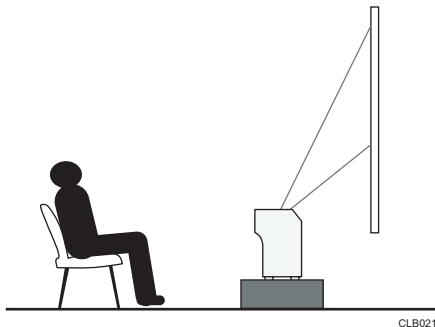

- Rear

The projector is placed behind a screen onto which the images are projected.

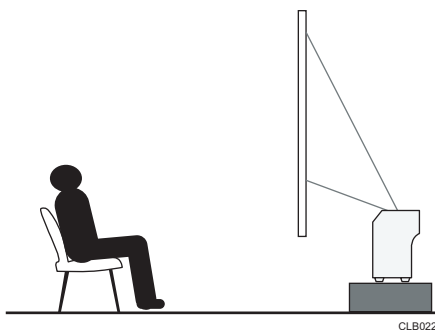

Relationship Between the Projection Distance and the Screen Size

The size of the projected image varies according to the distance from the projector to the screen.

Refer to the following table to position the projector in a suitable position.

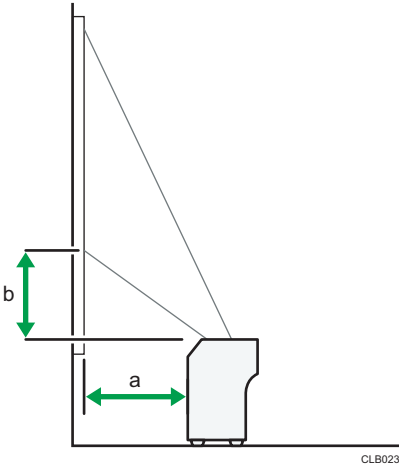

Projection size *1	a Projection distance	b Projection height
48 inches	12 cm (4.6 inches)	9 cm (3.7 inches)
60 inches	17 cm (6.5 inches)	12 cm (4.7 inches)
80 inches	25 cm (9.8 inches)	16 cm (6.2 inches)

*1 The sizes of the projected images are for a full size image without keystone adjustment.

Connecting Equipment to the Projector

⚠ CAUTION

- Do not place the power cord and connection cable in a way that might cause someone to trip and fall. The product might fall over and cause an injury.

Various equipments can be connected to the projector.

Turn off the power to any equipment before connecting it to the projector. Be sure to read the manual for the applicable equipment before connecting it to the projector.

Connecting a Computer

Connect an RGB cable to the Computer In port of the projector and to the RGB output of a computer. To input audio signals, connect an audio cable to the Audio In port of the projector and to the audio output of a computer.

If an HDMI interface is available on a computer you want to use, connect an HDMI cable to the HDMI ports of the projector and the computer.

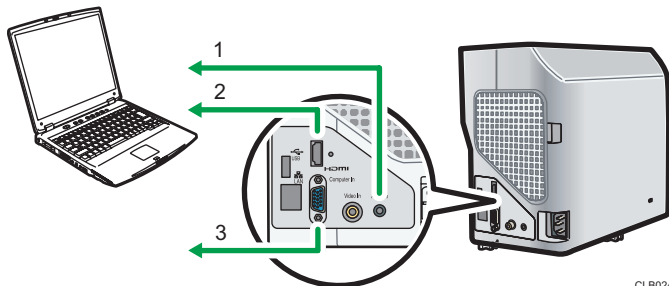

1. To the audio output
2. To the HDMI port
3. To the RGB output

↓ Note

- Some computers cannot be connected to the projector. Before connecting a computer to the projector, check the output terminals and signal compatibility.
- To input a DVI signal to the projector, connect a conversion adapter or cable to the Computer In port or the HDMI port of the projector.
- The Audio In port is used for equipment that connects to the Computer In port or Video In port.

Connecting AV Equipment

Use a cable that supports the signal being input when connecting AV equipment.

To connect a DVD recorder, connect a conversion adapter BNC-pin to the Computer In port of the projector and to the Y/Pb/Pr output of the recorder.

To connect a video recorder or a DVD player, connect a video cable to the Video In port of the projector and to the video output of the recorder or the player.

To input audio signals, connect an audio cable to the Audio In port of the projector and to the audio output of the recorder or the player.

If an HDMI interface is available on a device you want to use, connect an HDMI cable to the HDMI ports of the projector and the device.

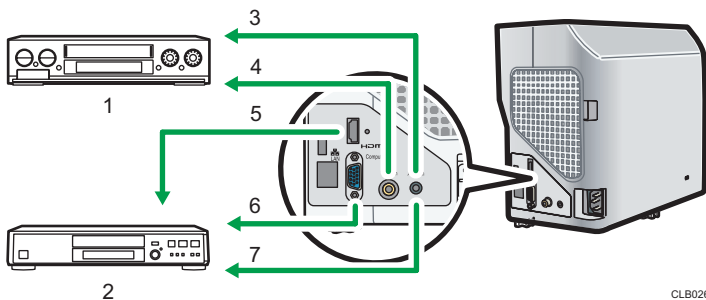

1. Video player, DVD player
2. DVD recorder
3. To the audio output
4. To the video output
5. To the HDMI port
6. To the Y/Pb/Pr output
7. To the audio output

↓ Note

- The Audio In port is used for equipment that connects to the Computer In port or Video In port.
- Some devices may not operate properly when connected using HDMI.
- Use only an HDMI cable that has the HDMI logo. To input 1080p image signals, use a high-speed HDMI cable. A conventional HDMI cable may not work properly.

Connecting the Power Cord

WARNING

- Do not use any power sources other than those that match the specifications shown. Doing so could result in fire or electric shock.

WARNING

- Do not use any frequencies other than those that match the specifications shown. Doing so could result in fire or electric shock.

WARNING

- The supplied power cord is for use with this machine only. Do not use it with other appliances. Doing so could result in fire or electric shock.

WARNING

- It is dangerous to handle the power cord plug with wet hands. Doing so could result in electric shock.

CAUTION

- Do not place the power cord and connection cable in a way that might cause someone to trip and fall. The product might fall over and cause an injury.

CAUTION

- Push the power plug all the way into the power outlet. Do not use a power outlet with a loose connection. Doing so may result in heat buildup. Plug the power cord in the correct direction into the base. If they are not plugged in correctly, it could result in smoke, fire, or electric shock.

CAUTION

- When disconnecting the power cord from the wall outlet, always pull the plug, not the cord. Pulling the cord can damage the power cord. Use of damaged power cords could result in fire or electric shock.

1. Insert the connector of the power cord set into the AC In socket on the right side of the projector.

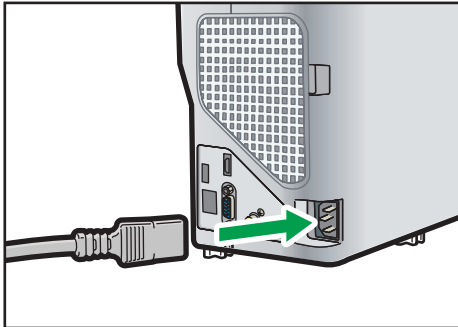

CLB028

2. Insert the power plug into a power outlet.

Note

- Do not place anything near the power outlet.
- When [Power On Method] in [Default Settings] is specified as [Auto.], the projector turns on as soon as the power plug is inserted in a power outlet (direct power on).

2. Projecting an Image

This chapter explains the procedure for projecting an image.

Basic Operations

WARNING

- Do not look into the projection window or vent when the product is on. The bright light may damage your eyes. Be especially careful in an environment with children.

CAUTION

- Do not place low heat resistant material near the exhaust vents. Hot air may come from the exhaust vents, resulting in damage to the product or an accident.

CAUTION

- Do not block the projection light when it is on. If you do so, the part that is blocking the projection light may get quite hot and deform, deteriorate or cause a burn or fire. The reflected light may make the projection window hot and cause a product failure. To temporarily suspend projection, select the mute function. To suspend longer, turn off the product.

Important

- **Unplug the power cord if the projector will not be used for an extended period of time.**
- **If the lamp is used for an extended period of time, it may not light up or the image may become dark. If this happens, replace the lamp. In some rare cases, the lamp's brightness may vary slightly due to the characteristics of a lamp.**

Note

- The projector supports various RGB signals, but signals that are not WXGA signals are expanded or compressed when displayed and the image quality is slightly decreased. We recommend setting the computer's output to WXGA to get better image quality.
- The motion of images in videos projected using the DVD software on a computer may seem unnatural.
- Connect the projector and equipment before using the projector. For details, see p.28 "Connecting Equipment to the Projector".
- If [Key Lock] in [Default Settings] is specified as [On], you cannot operate the projector from its control panel. Use the remote control.
- If you press a button that is disabled, the projector beeps and an error icon appears on the screen.
- If [Beep] in [Default Settings] is specified as [Off], the projector does not beep.

Turning On the Projector

Make sure that the power plug is inserted into a power outlet. For details, see p.30 "Connecting the Power Cord".

1. Press the [Power] button.

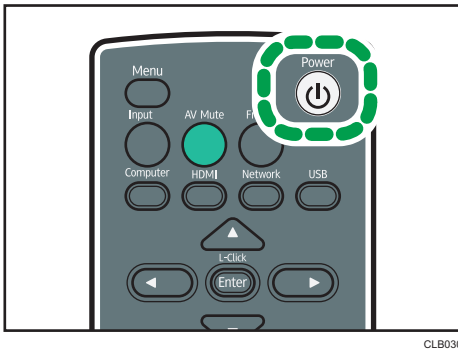

The projector beeps and the indicator flashes blue.

The start-up screen is displayed.

↓ Note

- Make sure the projector is positioned squarely in front of the screen. For details, see p.26 "Positioning the Projector".
- When the projector is turned on for the first time after it is purchased, the start menu appears. Specify the display language and lamp power level. For details, see p.34 "When the start menu is displayed".
- The password input screen is displayed if a password for the projector is specified in [Password] under [Default Settings]. Enter a password.
- When [Power On Method] in [Default Settings] is specified as [Auto.], the projector turns on as soon as the power plug is inserted in a power outlet (direct power on).
- The start-up screen closes shortly after appearing. You can specify that the start-up screen not appear in [Start-up Screen] under [Display Settings].

When the start menu is displayed

When the projector is turned on for the first time after it is purchased, specify the display language and lamp power level.

1. Select the display language, and then press the [Enter] button.
2. Select the lamp power level, and then press the [Enter] button.

↓ Note

- The start menu is only displayed the first time the projector is used. However, the start menu is displayed when the projector is turned on after [Reset All] in [Default Settings] is executed.
- The display language and lamp power level can also be changed in the menu screen. For details, see p.90 "Default Settings Menu".

Selecting an Input Signal

Select a signal that is compatible with the equipment that is connected to the projector.

1. Turn on the equipment that is connected to the projector.

To project the image of a video player, press the play button on the video player.

2. Press the [Input] button.

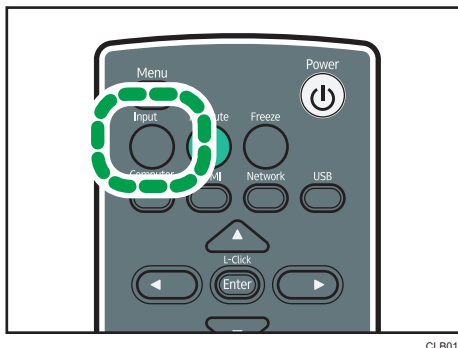

CLB019



The input signal is detected automatically and the image is projected. The input signal changes each time the [Input] button is pressed.

↓ Note

- In step 2, the input signal selection screen appears if [Off] is specified for [Auto Input Search] in [Default Settings]. Select a signal that is compatible with the equipment that is connected.
- Switch the computer's image output when projecting a notebook computer's screen. For details, see p.36 "When projecting the screen of a notebook computer".
- You can also select the input signal directly with the [Computer], [HDMI], [Network], or [USB] button on the remote control.
- The standby screen for the network input is displayed if the signal is lost or there is no signal being input from the connected equipment. Check that the equipment is turned on and that it is properly connected to the projector.
- If the project does not support the input signal, a "Unsupported signal" message is displayed.

When projecting the screen of a notebook computer

When connecting a notebook computer to the projector, switch the computer's image output.

In Windows operating systems, the image output can be switched with a function key. While pressing and holding the [Fn] key, press the  key, the  key, or the LCD/VGA function key.

Examples of various computers

Computer brand	Key combination
MSI	[Fn] + [F2]
Everex, Mitsubishi, NEC, Panasonic, Sotec	[Fn] + [F3]
Gateway, HP	[Fn] + [F4]
acer, Sharp, Sotec, Toshiba	[Fn] + [F5]
Hitachi, IBM, lenovo, Sony	[Fn] + [F7]
Asus, Dell, Epson, Hitachi	[Fn] + [F8]
Fujitsu	[Fn] + [F10]

↓ Note

- Depending on the computer, the image may not be projected properly if it is displayed on the computer's LCD display while being projected onto the screen by the projector. If this happens, turn off the computer's LCD display. For details about switching the display, see the manual provided with the computer.
- For details about operating the computer, see the manual provided with the computer.

Adjusting the Angle of the Projection

You can adjust the height of the projected image by using the adjustable feet to change the angle of the projector.

1. Lift the front of the projector and adjust the length of the adjustable feet.

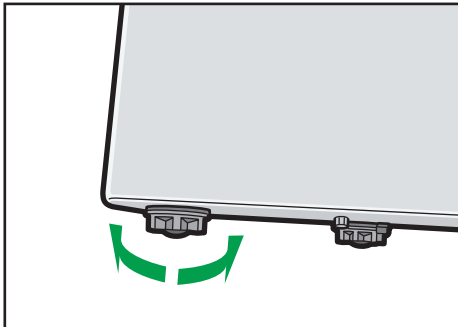

CLB031

Turn the adjustable feet to the left to make it longer. Turn the adjustable feet to the right to make it shorter.

↓ Note

- Adjust the height of the right and left adjustable feet so the projector is level. If the projector is inclined too much, an error occurs and operation cannot be performed.
- The projector automatically adjusts the projected image for keystone distortion according to the projection angle. If [Auto Keystone] in [Default Settings] is specified as [Off], manually adjust for keystone distortion. For details, see p.39 "Adjusting for keystone distortion".

Adjusting the Image

Adjust the focus of the projected image with the focus lever. If there is any keystone distortion, adjust it with the [Keystone] buttons on the remote control.

If the projected image is larger than the screen, adjust the size of the image using the [Zoom] buttons.

Changing the size of the projected image

Reduces and displays the image. The image can be reduced in a range of 80 to 100%.

If the projected image is larger than the screen, reduce the size of the image using the [Zoom] buttons.

1. Press the [Zoom⁻] button to reduce the image.



CLB037

The ratio decreases each time the [-] button is pressed. You can confirm the current ratio on the value bar at the bottom of the screen.

2. Press the [Zoom⁺] button to enlarge the image.

The ratio increases each time the [+] button is pressed. The image is enlarged until it reaches the original size.

Note

- You can also adjust the size of the projected image from the control panel on the projector.
- The image may sometimes be disrupted while it is reduced.

Adjusting the focus

Adjust the focus of the projected image.

1. Move the focus lever on the front of the projector to the left or right.

The shape of the projected image changes slightly when the focus lever is moved.

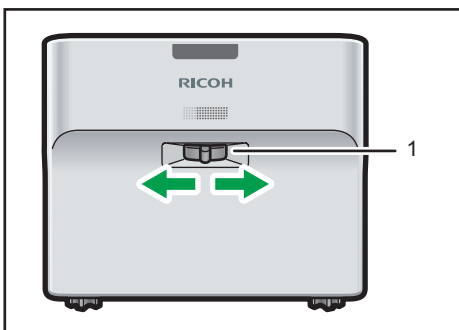

CLB032

1. Focus lever

Adjusting for keystone distortion

If the projector is placed at an angle, the projected image will be distorted. This is called keystone distortion.

If [Auto Keystone] in [Default Settings] is specified as [Off], manually adjust for keystone distortion.

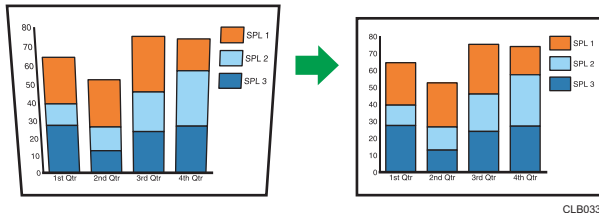

CLB033

2

1. Press the [Keystone⁺] and [Keystone⁻] buttons to adjust the keystone distortion.

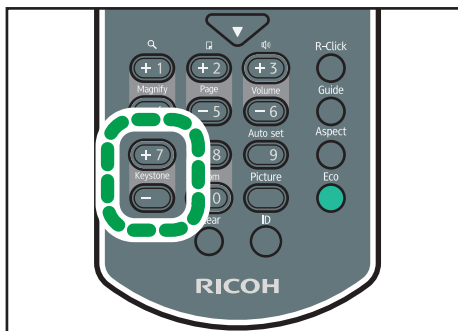

CLB063

The value bar appears at the bottom of the screen. Press the [+] button to increase the correction value. Press the [-] button to decrease the correction value.

↓ Note

- Some data may be lost or the image quality may be degraded depending on the degree of the keystone adjustment and the type of the image.
- You can manually adjust for keystone distortion even if [Auto Keystone] is specified as [On]. However, if you change the angle of the projector, it is automatically adjusted again.
- The keystone adjustment level stays registered even if the projector is turned off. We recommend that you specify [Auto Keystone] to [Off] if the projector and screen are permanently installed.

Automatically adjusting the image

The image quality and position are automatically adjusted according to the input signal.

This function is available when you select [Computer] as an input signal.

1. Press the [Auto set] button.

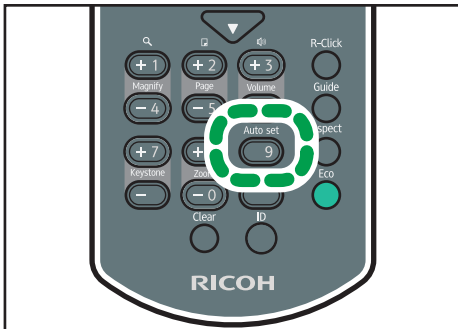

CLB034

Note

- Depending on the type of input signal, some images may not be displayed or correctly adjusted. If this happens, adjust the image with [Position] in [Image Adjustment]. For details about the types of signals that can be input to the projector, see p.127 "List of Compatible Signals".

Adjusting the Volume of the Speaker

1. Press the [Volume+] and [Volume-] buttons to adjust the volume.

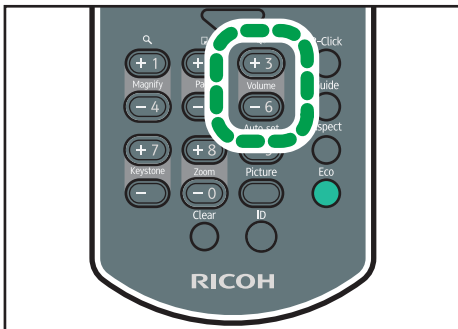

CLB035

The value bar appears at the bottom of the screen. Press the [+] button to increase the volume. Press the [-] button to decrease the volume.

Note

- You can also adjust the volume of the speaker from the control panel on the projector.

Manipulating Images with the Remote Control

Use the remote control to manipulate projected images.

Enlarging the image

Enlarges and displays a part of the image. The image can be enlarged in a range of 100 to 200%. The enlarged image becomes grainy due to the digital processing.

1. Press the [Magnify⁺] button to enlarge the image.



CLB036

The ratio increases each time the [+] button is pressed.

Pressing the [▲], [▼], [◀], and [▶] buttons moves the display position of the enlarged image.

2. Press the [Magnify⁻] button to reduce the image.

The ratio decreases each time the [-] button is pressed. The image is reduced until it reaches the original size.

↓ Note

- An icon appears on the screen when the image is enlarged.
- The Magnify function is canceled automatically if any operation is performed.
- The image may sometimes be disrupted while it is enlarged or while moving the enlarged portion.

Temporarily blanking the image and muting the audio

Temporarily blanks the screen and mutes the audio.

This is useful when projecting images from another projector or an OHP.

1. Press the [AV Mute] button.

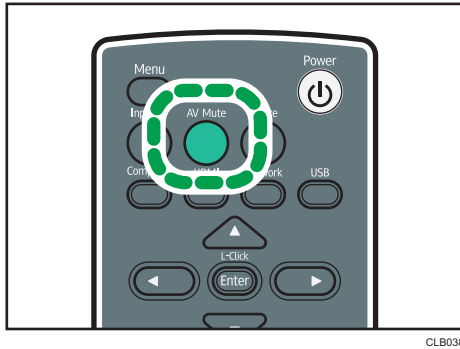

The image blanks and the audio mutes.

2. To cancel this function, press the [AV Mute] button again.

Note

- An icon appears on the screen when mute is used.
- The mute function is canceled automatically if any button on the control panel is pressed.
- You can also use the [AV Mute] button on the projector's control panel.

Pausing the image

Pauses the video or moving image that is being projected.

1. Press the [Freeze] button.

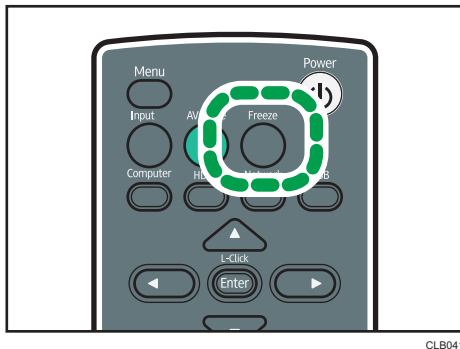

The image is paused.

2. To cancel this function, press the [Freeze] button again.

Note

- An icon appears on the screen when freeze is used.
- The Freeze function is canceled automatically if any operation is performed.

- When the [Freeze] button is pressed, the image that is being projected at that time is stored in memory, and that image is projected. Because of this, even though the projector has paused the image, the equipment continues to play the video.

Changing the image quality

1. Press the [Picture] button.

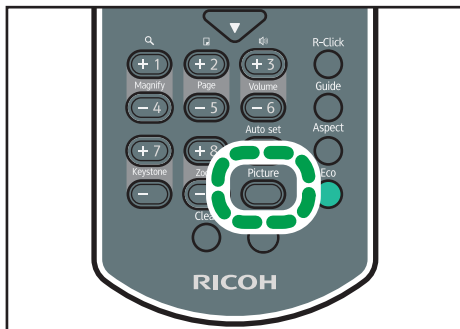

CLB039

2. Select a setting from the list using the [▲] and [▼] buttons, and then press the [Enter] button.

Note

- You can also change the screen mode with [Image Adjustment]. For items that can be specified, see p.83 "Image Adjustment Menu".

Changing the aspect ratio of the projected image

1. Press the [Aspect] button.

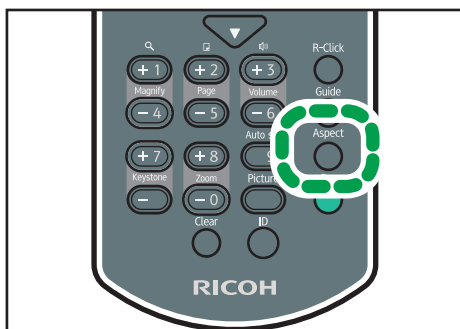

CLB040

2. Select a setting from the list using the [▲] and [▼] buttons, and then press the [Enter] button.

Note

- You can also change the aspect with [Display Settings]. For items that can be specified, see p.87 "Display Settings Menu".

Switching the lamp mode

2

Select eco mode if the image is too bright or when projecting images in a dark room.

1. Press the [Eco] button.

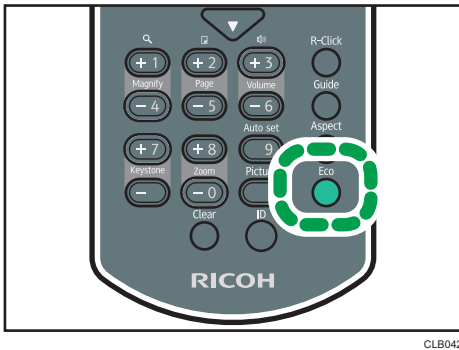

CLB042

The mode changes each time the button is pressed.

Note

- You can also change the lamp power level with [Default Settings]. For items that can be specified, see p.87 "Display Settings Menu".

Turning Off the Projector

1. Press the [Power] button.

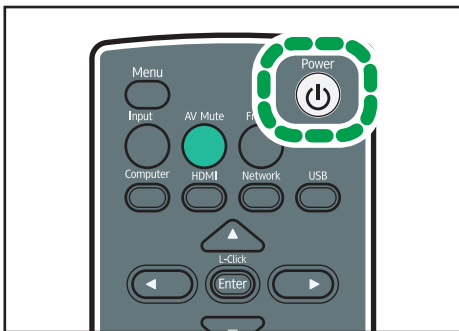

CLB030

The confirm screen appears.

2. Press the [Power] button.

The projector beeps and the projector turns off.

↓ Note

- After turning the projector off, wait about five minutes for the lamp to cool before turning the projector on again. The lamp may not light if it is very hot.
- The projector turns off as soon as the power plug is removed from the power outlet (direct power off).

Projecting Images from a USB Memory Device or Digital Camera

The projector can project JPEG and MPEG files stored on a USB memory device that is connected to the projector. JPEG files stored in digital cameras can also be projected. Images can be displayed easily even if a computer is not connected.

The USB devices must support USB 2.0.

★ Important

- **It is recommended to back up the data saved to a USB device before using it. The manufacturer is not responsible for any damage due to the loss of data.**
- **Do not disconnect the power plug while the USB device is being accessed. Doing so may cause malfunction or data loss.**

The following file extensions are compatible with the projector.

- Files stored on a USB memory device
 - jpg, jpeg, JPG, JPEG, mpg, mpeg, MPG, MPEG, m2ts, m2t, M2TS, M2T
- Files stored on a digital camera
 - jpg, jpeg, JPG, JPEG

The supported video file formats are MPEG-2 Video Compression and MPEG Audio Compression Layer-3.

↓ Note

- The maximum number of files that can be displayed in the list is 512 per folder.
- Characters that can be used for file names and folder names are single-byte letters and numbers and characters used in the language specified in [Language] under [Default Settings]. If characters for languages other than the language specified are used, the file name or folder name will not be displayed properly.
- The folder name or file name can be 255 characters max.
- Data in a folder that is stored six levels or more into a hierarchy cannot be accessed.
- Depending on the file type, the projector may not be able to project the image.
- Depending on the type of USB memory device, it may not be usable with the projector. USB memory devices with passwords cannot be used.
- For information about which digital cameras can be used with the projector, contact your sales representative or service representative.

Connecting the USB Device

Connect the USB memory device or digital camera to the projector.

The USB device can be connected even if the projector is already on.

1. Connect the USB device to the USB port on the projector.

Check the port orientation before connecting.

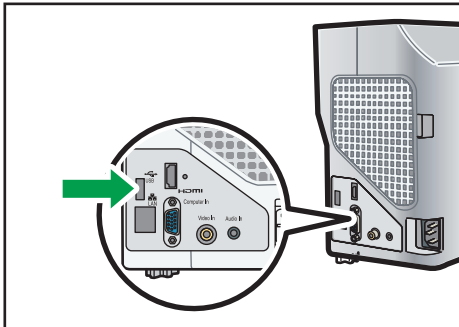

Note

- If the projector does not recognize the USB device when it is connected, disconnect and reconnect the USB device.
- The provided mouse remote control receiver, and commercially available mouse controllers and USB hubs cannot be connected.

Projecting Still Images

Connect the USB memory device or digital camera to the projector. For details, see p.47 "Connecting the USB Device".

A projected image can be controlled using the remote control.

- Right arrow button (▶): Displays the next image.
- Left arrow button (◀): Displays the previous image.
- Up arrow button (▲): Rotates the image 90° to the right.
- Down arrow button (▼): Rotates the image 90° to the left.
- [Enter] button: Starts an automatic slide show. Pressing the [Enter] button again stops the slide show. You can switch the images manually.
- [Menu] button: Displays the file list while an image is being projected.

1. Press the [USB] button.

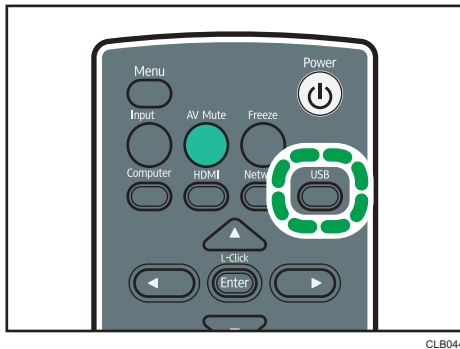

The input signal switches to the USB, and the files within the root directory are displayed.

2. Use the [▲] and [▼] buttons to select the JPEG file or folder.

3. Press the [Enter] button.

If you select a JPEG file, its image is projected. If you select a folder, the file list within the folder is displayed. Repeat steps 2 and 3 until you can display the file you want to project.

Note

- You can also control the projected images using the control panel on the projector.
- Images are displayed in the numerical and alphabetical order of their file name headers.
- If [Auto Demo] in [USB Settings] is specified as [On], the images in the root directory are played automatically.
- Depending on the JPEG file, the projector may not be able to display it. If the file cannot be displayed, converting the file with JPEG Conversion Tool may enable the projector to display it. For details about JPEG Conversion Tool, see p.49 "Converting Presentation Files to JPEG Files".

Projecting Videos

Connect the USB memory device to the projector. For details, see p.47 "Connecting the USB Device".

A projected video can be controlled using the remote control.

- Right arrow button (▶): Displays the next video. If a video is being projected, this button fast forwards the video.
- Left arrow button (◀): Displays the previous video. If a video is being projected, this button rewinds the video.
- [Enter] button: Pause. Press the [Enter] button again to restart the playback. If a video is paused, pressing the left or right arrow buttons switches the video.
- [Menu] button: Displays the file list while a video is being projected.

1. Press the [USB] button.

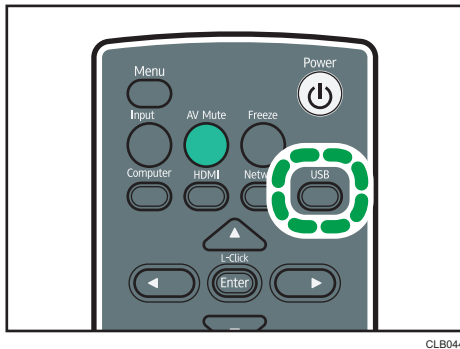

The input signal switches to the USB, and the files within the root directory are displayed.

2. Use the [▲] and [▼] buttons to select the MPEG file or folder.

3. Press the [Enter] button.

If you select an MPEG file, the video plays. If you select a folder, the file list within the folder is displayed. Repeat steps 2 and 3 until you can display the file you want to project.

↓ Note

- You can also control the projected videos from the control panel on the projector.
- The rewind and fast forward speed increases three levels each time the button is pressed. To reduce the speed to its original, pause the video by pressing the [Enter] button, and then press it again to restart the video.

Disconnecting the USB Device

1. Press the [Menu] button while the video is being projected.

2. Select [Remove Device] on the [USB File Projection] screen.

The confirmation screen is displayed.

3. Select [OK].

4. Disconnect the USB device.

↓ Note

- A USB device can be disconnected by selecting [Remove Device] in [USB Settings].

Converting Presentation Files to JPEG Files

Microsoft PowerPoint presentation files can be converted to JPEG files, which are compatible with the projector.

You can do presentations without a computer if you save converted JPEG files to a USB memory device and then display the slides using the projector.

The converted files can also be transferred to a server.

Operating Environment

- Supported operating system
 - Windows XP (32-bit version) Professional Edition and Home Edition, SP3 or later
 - Windows XP (64-bit version) Professional Edition SP2 or later
 - Windows Vista (32-bit and 64-bit versions) Ultimate, Business, Home Premium, and Home Basic, SP2 or later
 - Windows 7 (32-bit and 64-bit versions) Home Premium, Professional, Ultimate, Enterprise
- Memory size
 - Recommended memory size for the operating system of the computer you are using

1. Double-click the "JPEG Conversion Tool" icon.

JPEG Conversion Tool starts.

2. Drag and drop the PowerPoint file to be converted into the "JPEG Conversion Tool" dialog box.

To manually specify the file, enter the file name in [File Location:].

3. Specify the destination to which you want to save the converted file.

To save to a computer, select [Local PC].

To save to a server, select [Server], and then select the server to which you want to save the file.

4. Click [Convert&Save].

5. Click [OK].

↓ Note

- To convert PowerPoint files, Microsoft PowerPoint 2003, 2007, or 2010 must be installed on the computer to you are using.
- JPEG Conversion Tool is compatible with still images that have a ".ppt" or ".pptx" extension. Animations and audio are not compatible.
- To convert PowerPoint files with the ".pptx" extension, Microsoft PowerPoint 2007 or later must be installed on the computer you are using.
- The number of JPEG files created is equivalent to the number of slides. The file name after conversion is "slide + File Number + .jpg".
- For the settings method when saving converted files to the server, refer to the JPEG Conversion Tool Help.

How to use JPEG Conversion Tool

JPEG Conversion Tool is included on the supplied CD-ROM.

1. Insert the CD-ROM in the CD-ROM drive of your computer.

2. Specify a language.

The launcher screen appears.

3. Click [JPEG Conversion Tool Type A].

4. Specify a destination to save the application.

The "RICOH JPEG Conversion Tool Type A" folder is copied to the computer.

5. To create a shortcut icon on the desktop, click [OK].

6. Close the screen.

To start JPEG Conversion Tool, double-click the shortcut icon on the desktop or "RICOH JPEG Conversion Tool TypeA.exe" in the folder.

↓ Note

- You can also use JPEG Conversion Tool by dragging and dropping the "RICOH JPEG Conversion Tool Type A" folder that is on the provided CD-ROM to the computer. JPEG Conversion Tool is copied to the computer.
- To delete JPEG Conversion Tool, delete the JPEG Conversion Tool folder that was copied to the computer.

3. Using the Projector via a Network

This chapter explains the settings for using the projector via a network. This chapter also explains the operations that use Network Utility.

Connecting the Projector to a Network

The projector can be connected to a network using a wireless LAN or an Ethernet cable. For details, see p.55 "Connecting Using an Ethernet Cable", or p.57 "Connecting Using a Wireless LAN".

To use the projector via a network, you must specify settings such as the IP address in [Network Settings]. The required settings are described below:

Wired LAN

Item	Wired LAN	Wireless LAN
Wired LAN Settings	As necessary	-
TCP/IP Settings	Required	-

Wireless LAN

Item	Wired LAN	Wireless LAN
Simple Settings	-	As necessary
Wireless LAN Settings	-	As necessary
Security	-	As necessary
TCP/IP Settings	-	Required

LAN Common

Item	Wired LAN	Wireless LAN
Network Interface	Required	Required
DNS Settings	As necessary	As necessary
Projector Search Settings	As necessary	As necessary
HTTP Client Settings	As necessary	As necessary
HTTP Server Settings	As necessary	As necessary

For details, see p.96 "Network Settings".

Note

- When operating the projector from a computer via a network, use Network Utility which is provided with the projector. For details, see p.61 "Projecting Images Using Network Utility".

Connecting Using an Ethernet Cable

⚠ CAUTION

- Do not place the power cord and connection cable in a way that might cause someone to trip and fall. The product might fall over and cause an injury.

The projector is compatible with 10BASE-T, 100BASE-TX, and 1000BASE-T Ethernet interfaces.

★ Important

- If the projector is turned on, turn it off before connecting the Ethernet cable.

3

Status of the network connection

You can confirm the status of the network connection by the patterns in which the LEDs on the Ethernet interface light up. If the projector is not connected to a network, no LEDs light up.

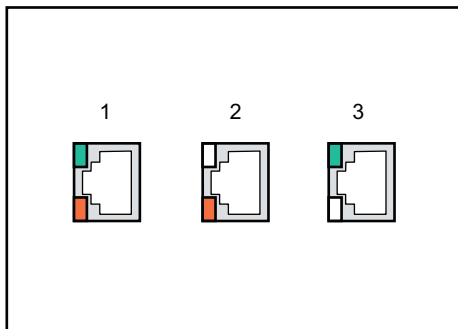

CLB072

- When 1000BASE-T is active (orange and green LEDs light up)
- When 100BASE-TX is active (orange LED lights up)
- When 10BASE-T is active (green LED lights up)

- Insert the Ethernet cable into the Ethernet interface.

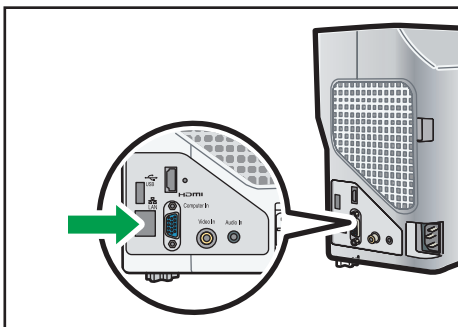

CLB045

- Connect the other end of the Ethernet cable to a network device such as a hub.
- Turn the projector on.

 **Note**

- Use an Ethernet cable that is shielded.
- To use the projector via a network, you must specify settings such as the IP address in the Network Settings menu. For items that must be specified, see p.53 "Connecting the Projector to a Network".

Connecting Using a Wireless LAN

WARNING

- Do not use a wireless LAN if there is electromagnetic interference from other equipment. Doing so may cause an accident due to the other equipment malfunctioning from the electromagnetic interference.

The projector has a built-in wireless LAN board.

Wireless uses radio waves to exchange information instead of an Ethernet cable. The wireless LAN radio waves pass through barriers such as walls within a fixed area, so the following problems may occur:

Leak of Personal Information

- Information such as IDs, passwords, credit card numbers, and the contents of e-mails, etc., may be stolen by a third party.

Illegal Access to the Network

- Data and systems may be corrupted or manipulated by a virus.
- An imposter may access information illegally.
- Confidential information may be accessed illegally.

To minimize the possibility of these problems occurring, it is recommended to check the functions built into the wireless LAN devices, such as the projector and wireless LAN access points, and to specify security settings.

Note

- If the wireless network reception is poor, the connection may be interrupted or disabled. If the wireless reception of the projector and access points is poor, try the following:
 - Move the projector and access points closer to each other.
 - Make sure there is a clear line of sight between the access point and the projector.
 - Make sure the access point and projector are close to each other, and move devices that emit radio signals such as microwave ovens further away.

Wireless LAN Connection Workflow

The projector is compatible with ad hoc mode and infrastructure mode. Select the communications mode according to the network environment of the site to be used.

Ad Hoc mode

This mode communicates with the computer directly, and not via an access point. No other equipment is required, so this mode is suited for locations that have no network environment.

If you use ad hoc mode, make the following settings:

Settings Using Simple 1:1 Connection

Action	Method	Refer to
Wireless LAN settings	Simple 1:1 Connection (Network Utility)	p.62 "Simple 1:1 Connection"
Image projection	Simple 1:1 Connection (Network Utility)	p.62 "Simple 1:1 Connection"

Settings Using a USB Memory Device

When the computer is in ad hoc mode, use the following method:

Action	Method	Refer to
Wireless LAN settings	Write Settings to USB Memory (Network Utility)	p.64 "Copying computer settings to the projector"
Image projection	Network Connection (Network Utility)	p.63 "Network Connection"

↓ Note

- As the radio wave range is limited, use an office or conference room with a good line of sight.
- If you are using ad hoc mode, other computers cannot access the projector.

Infrastructure mode

This mode can communicate with networks in which both wireless and wired LAN devices are connected via a wireless LAN access terminal. It is necessary to user greater security since all communication is via a network. Use infrastructure mode in environments in which a wireless LAN has already been configured.

If you use infrastructure mode, make the following settings:

Settings Using Simple Wireless LAN Setup

Action	Method	Refer to
Wireless LAN settings	Simple Wireless LAN Setup	p.59 "Simple Wireless LAN Setup"
Image projection	Network Connection (Network Utility)	p.63 "Network Connection"

Simple Wireless LAN Setup

To use the projector via a wireless LAN, the network settings must be configured. If you use the wireless LAN simple setup function, the infrastructure settings can be easily configured.

The simple wireless LAN setup function acquires the wireless LAN settings registered in the access point, and configures those settings for the projector automatically. The access point must also be compliant with the simple wireless LAN setup function.

Select [Wireless LAN] in [Network Interface] under [Network Settings] beforehand. Further, specify the IP address and DHCP server using [TCP/IP Settings] in [Wireless LAN].

Setup Method

- Using push buttons
 - Press the projector and access point keys or buttons to get them to connect to each other and register the settings.
- Enter the access point's PIN code in the projector
 - Enter the PIN code that was generated by the access point in the projector to get them to connect to each other and register the settings. The access point's PIN code must be registered in the PIN code field of the projector.

1. Press the [Menu] button.

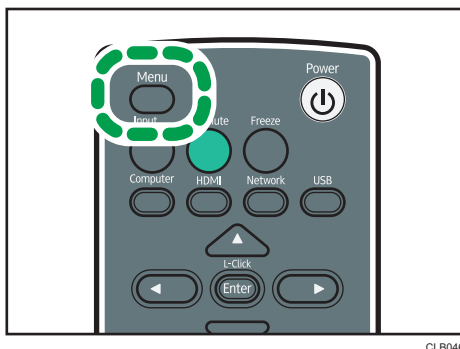

CLB046

2. Select the [Network/USB Settings] menu.

3. Select **[Network Settings]**.
4. Select **[Wireless LAN]**.
5. Select either **[Connect by PIN]** or **[Connect by Push]** in **[Simple Wireless LAN Setup]**.
6. If **[Connect by PIN]** is selected, enter the PIN code generated by the access point in the projector, and then proceed to step 7.

You must preconfigure the access point's simple wireless LAN setup function.

7. If **[Connect by Push]** is selected, press the **access point push button**.
8. Select **[OK]** on the confirmation screen.

The wireless LAN setup is complete.

Projecting Images Using Network Utility

What Is Network Utility?

Network Utility is a software application that connects the projector and a computer to project images. Images that can be projected are computer screens and still images.

The main Network Utility functions are described below:

Simple 1:1 Connection

Projects images by connecting the computer and projector using a wireless LAN in ad hoc mode.

Network Connection

Projects images by connecting to the projector that is connected to the network using an Ethernet cable or a wireless LAN.

Settings Using a USB Memory Device

Specifies the wireless LAN settings using a USB memory device. There are two methods to do this: one method is to copy the computer settings to the projector, and the other method is to copy the projector settings to the computer.

Network Utility operating environment is described below.

- Supported operating system
 - Windows XP (32-bit version) Professional Edition, Home Edition, SP3 or later
 - Windows Vista (32-bit and 64-bit versions) Ultimate, Business, Home Premium, Home Basic, SP2 or later
 - Windows 7 (32-bit and 64-bit versions) Home Premium, Professional, Ultimate, and Enterprise

- Memory size

Recommended memory size for the operating system of the computer you are using

↓ Note

- To configure the wireless LAN settings using the following methods, log in to the computer with administrator privileges:
 - Simple 1:1 Connection
 - Settings using a USB memory device
- For detailed Network Utility operating methods, refer to the Network Utility Help.

How to use Network Utility

Network Utility is included on the supplied CD-ROM.

1. Insert the CD-ROM in the CD-ROM drive of your computer.

2. Specify a language.

The launcher screen appears.

3. Click [PJ Network Utility Type A].

4. Specify a destination to save the application.

The "RICOH PJ NetworkUtility Type A" folder is copied to the computer.

5. To create a shortcut icon on the desktop, click [OK].

6. Close the screen.

To start Network Utility, double-click the shortcut icon on the desktop or "RICOH PJ NetworkUtility TypeA.exe" in the folder.

Note

- You can also use Network Utility by dragging and dropping the "RICOH PJ NetworkUtility Type A" folder that is on the provided CD-ROM into the computer or a USB memory device.
- To delete Network Utility, delete the Network Utility folder.

Simple 1:1 Connection

To connect the computer and projector using the wireless LAN in ad hoc mode, select [Simple 1:1 Connection].

Make sure the projector's communication mode is "ad hoc". You can confirm the projector's LAN status on Network Information displayed on the screen.

1. Turn the projector on.

2. Press the [Network] button.

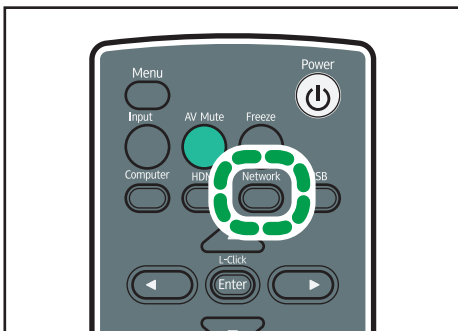

CLB074

3. Press the [Enter] button.

The connection wait screen is displayed.

4. Double-click the "Network Utility" icon on the computer.

Network Utility starts.

5. Click the [Simple 1:1 Connection] tab.

6. Select the projection method.

7. If you select [Transmit Still Image File], specify the file to be projected.

8. Click [Start].

A number appears on both the projected screen and on the computer's screen.

9. If the numbers displayed on both screens are the same, click [OK].

The computer screen or selected file is projected.

Note

- When Network Utility ends, the computer wireless LAN settings automatically reset to their pre-connection settings.
- To close Network Utility, either select [Exit], or click [X] to close the window.

Network Connection

When connecting to a projector that is connected to the network using an Ethernet cable or a wireless LAN, select [Network Connection].

A maximum of four projectors can be selected at the same time. If you select multiple projectors, they will all project the same image.

1. Turn the projector on.

2. Press the [Network] button.

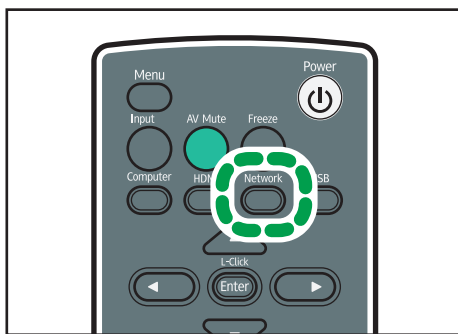

3. Double-click the "Network Utility" icon on the computer.

Network Utility starts.

4. Click the [Network Connection] tab.

5. Select the connected projector from [Select Projector(s) to Use (Up to 4 devices)].

If you want to manually enter the projector IP address, select [Connect by Manual Entry], and enter the IP address.

6. Select the projection method.

7. If you select [Transmit Still Image File], specify the file to be projected.

8. Click [Start].

The computer screen or selected file is projected.

Note

- To close Network Utility, either select [Exit], or click [X] to close the window.

Settings Using a USB Memory Device

The wireless LAN settings information can be shared between the computer and projector using a USB memory device. This is useful when you are setting up multiple devices at one time.

The wireless LAN settings information is stored on the USB memory device. There are two methods to do this: one method is to copy the computer settings to the projector, and the other method is to copy the projector settings to the computer.

Copying computer settings to the projector

1. Insert the USB memory device into the computer USB port.

2. Double-click the "Network Utility" icon.

Network Utility starts.

3. Click [Menu].

4. Click [Write Settings to USB Memory].

5. Click [Execute] in [Copy Setting Information].

The computer's wireless LAN settings are displayed on the screen.

6. Click [OK].

The settings are saved to the USB memory device.

7. Turn the projector on.

8. Press the [Network] button.

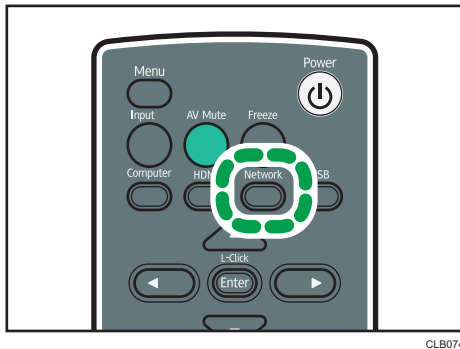

3

9. Insert the USB memory device into the USB port on the projector.

The confirmation screen is displayed.

10. Select [OK].

The wireless LAN settings saved to the USB memory device are reflected in the projector.

11. Select [OK].

↓ Note

- If the conformation screen does not appear when you insert the USB memory device into the projector's USB port, remove the USB memory device. Press the [Network] button, and then reinsert the device.
- It is also possible to change the wireless LAN settings on the computer using Network Utility, and to save the settings to the USB memory device. For details, see Help.

Copying projector settings to the computer

1. Turn the projector on.

2. Insert the USB memory device into the USB port on the projector.

3. Press the [Menu] button.

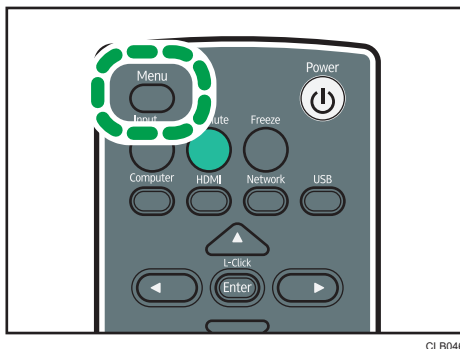

4. Select the [Network/USB Settings] menu.
5. Select [Network Settings].
6. Select [Wireless LAN]
7. Select [Enable] in [Wireless Connection via USB] under [Simple Wireless LAN Setup].
8. Select [Simple Connection (USB Memory)], and then press the [Enter] button.

The wireless LAN settings for the projector are saved to the USB memory device.

9. Select [OK].
10. Press the [Menu] Button.
11. Select [USB Settings].
12. Select [OK] in [Remove Device].
13. Disconnect the USB memory device.
14. Insert the disconnected USB memory device into the USB port on the computer.
15. Double-click the "Network Utility" icon on the computer.
Network Utility starts.
16. Click [Menu].
17. Click [Read Settings from USB Memory].
18. Click [OK].
19. When the USB memory device selection screen is displayed, select the USB memory device from which to read the settings, and click [OK].
20. When the wireless LAN adapter selection screen is displayed, select the wireless LAN adapter that you want to store of, and click [OK].

The computer settings are complete.

Using the Projection Server Function

The projector accesses the network server to project JPEG files saved on the server.

You do not need to carry a storage device or computer that has the files to be used. Therefore, it is useful to protect information.

Accessing folders on the server can be controlled by registering an access number.

Configuring the Network Server

3

A network server on which IIS (Internet Information Services) is installed can be used as a projection server.

Projection server operations have been verified for the following operating systems:

- Windows Server 2003 R2 Standard (32-bit version) SP2 and IIS 6

IIS 6 is not provided with a URL rewrite module. Use a URL rewrite module provided by a third party.

- Windows Server 2008 R2 Standard (64-bit version) SP1 and IIS 7

Install the URL Rewrite Module that can be downloaded from Microsoft Download Center. If the ASP (Active Server Pages) Execution Environment is not available on the network server, install the ASP module.

The following settings are required on the network server that is used as a projection server:

Creating a virtual directory

Create a directory (virtual directory) that the projector accesses on the network server.

Register the alias name and directory path of the virtual directory by following the wizard instructions. For detailed procedures, see the Microsoft Web site.

- Alias name

An alias name is required when the projector accesses the virtual directory.

The settings must be configured in [Projection Server] under [Network Application Settings]. For details, see p.68 "Configuring the Projector".

- Directory path

This is a path for the directory in which files projected by the projector are stored.

To store files converted by JPEG Conversion Tool on the network server, register the directory path. For details, see JPEG Conversion Tool Help.

Storing the folder management file for the projection server

The folder management file for the projection server is stored in the "Projection Server" folder on the supplied CD-ROM. Copy the folder management file to the virtual directory on the network server.

Registering a URL rewrite rule

Using a URL rewrite module, register a rule to rewrite "original characters" to "rewritten characters":

- Original characters: ^alias name of the virtual directory/(.*)
- Rewritten characters: /alias name of the virtual directory/name of the folder management file

If you use IIS 7, and if the alias name is "ABC" and the folder management file name is "xyz.asp", the characters become the following:

- Original characters: ^ABC/(.*)
- Rewritten characters: /ABC/xyz.asp

3

Configuring the Projector

Configure the settings for the projection server in [Projection Server] under [Network Application Settings] beforehand.

- Validate Projection by Projection Server
Specify to [Enable].
- Server URL

Enter the projection server URL and the alias name of the virtual directory in the following format:

Projection server URL/alias name/{n}

If the projection server URL is "http://hostname" and the alias name is "document", enter "http://hostname/document".

An IP address can be used as the projection server URL.

If you select [Access Number] in [Access Restriction Type], add "{n}" at the end of the Server URL.

Specify other settings in [Projection Server], if necessary.

Note

- To use the projection server function, you must specify the network settings in advance. For details, see p.53 "Connecting the Projector to a Network".
- For details about how to change the settings, see p.73 "Using the Menu Screen". For details about the setting items, see p.103 "Network Application Settings".

Projecting Files that Are Stored on the Server

Store files to be projected using the projector in the virtual directory on the network server.

If you select [Access Number] in [Access Restriction Type], create a folder whose name is the number that you specify as Access Number. After this, store the files to be projected in the folder. To project the files stored in the folder, enter the access number when accessing the projection server.

A projected image can be controlled using the remote control.

- Right arrow button (▶): Displays the next image.
- Left arrow button (◀): Displays the previous image.
- [Menu] button: Displays the file list while an image is being projected.

1. Turn the projector on.
2. Press the [Network] button.

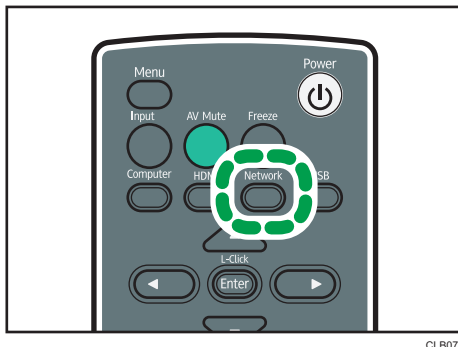

CLB074

3. Press the [Enter] button.

The confirmation screen is displayed.

4. Select [OK].

The list of files in the root directory is displayed.

5. Select the file to be projected.

If you select a folder, the file list within the folder is displayed. Repeat these steps until you can display the file you want to project.

6. To quit the projection, press the [Menu] button to display the file list, and the select [Exit].

↓ Note

- If [Access Restriction Type] is specified for [Access Number] after step 3, the access number input screen is displayed. Contact your server administrator for your access number.

4. Changing the Projector Settings

This chapter explains the settings on the menu screen and how to change the settings.

Viewing the Menu Screen

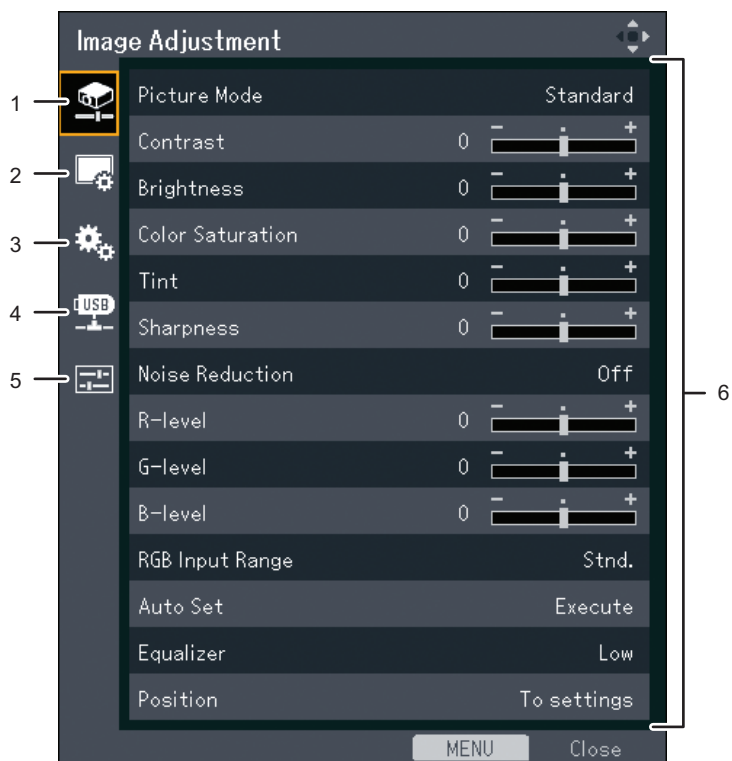

CLB065

1. Image Adjustment menu tab

Enables the image items to be adjusted and configured.

For the Image Adjustment menu settings, see p.83 "Image Adjustment Menu".

2. Display Settings menu tab

Enables the screen display items to be configured.

For the Display Settings menu settings, see p.87 "Display Settings Menu".

3. Default Settings menu tab

Enables the installation status, etc., to be configured.

For the Default Settings menu settings, see p.90 "Default Settings Menu".

4. Network/USB Settings menu tab

Enables the network and USB settings to be configured.

For the Network/USB Settings menu settings, see p.95 "Network/USB Settings Menu".

5. Display Status tab

Enables information such as input signals and lamp usage time, etc., to be displayed.

For item that can be displayed, see p.105 "Display Status".

6. Settings

The settings and information for each menu can be displayed.

For the list of possible settings for each menu, see p.79 "List of Menu Items".

Using the Menu Screen

This section explains the methods for changing the menu screen using the remote control.

1. Press the [Menu] button.

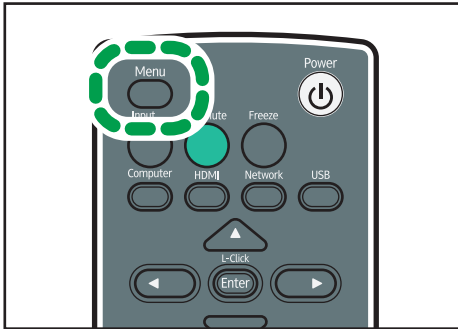

CLB046

4

2. Select the menu tab using the [▲] and [▼] buttons.

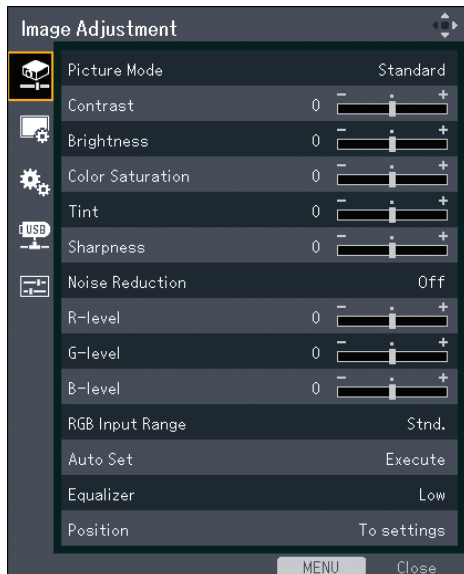

If you select the Display Status tab, you can confirm the information in this step.

3. Press the [▶] button.

4. Select the item to be changed using the [▲] and [▼] buttons.

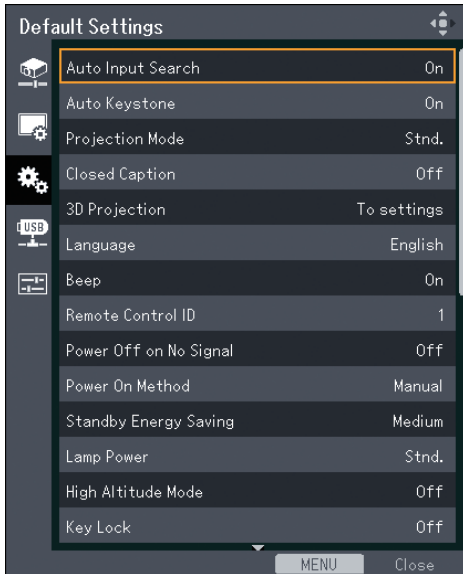

If [To settings] is displayed on the right, the item has a submenu. Press the [Enter] button to display the submenu screen.

5. Press the [Enter] button.

If [Execute] is displayed to the right of the item you select, the function is executed in this step.

6. Change the settings.

The method for changing the settings depends on the item.

- Adjusting values using the values bar

Change the value using the [◀] and [▶] buttons, and then press the [Enter] button.

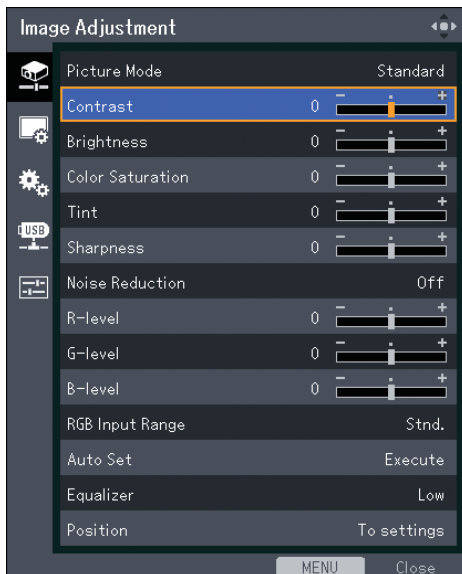

- Selecting the value from a list

Change the value using the [▲], [▼], [◀], and [▶] buttons, and then press the [Enter] button.

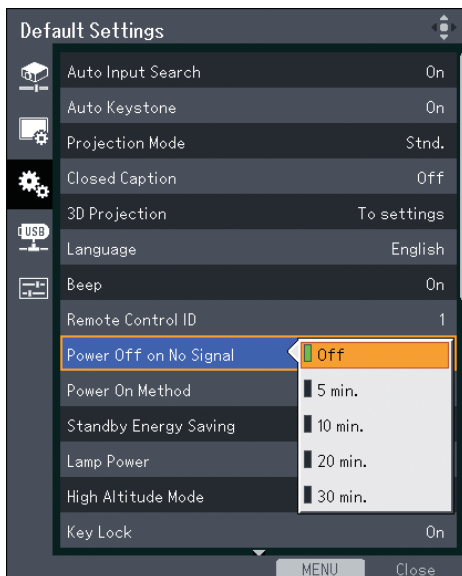

- Inputting numbers

Use the number buttons on the remote control to input numbers.

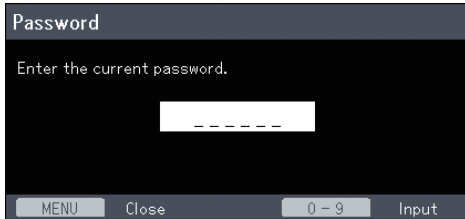

- Inputting text

Use the keyboard that is displayed on screen to input text. You can also use the number buttons on the remote control to input numbers.

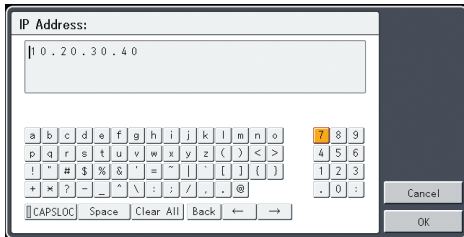

Note

- The control panel on the projector can be used for operations, but numbers for settings cannot be inputted.
- A confirmation screen appears before some functions are executed or some settings are changed.
- The Network/USB Settings menu has three submenu screens, [USB Settings], [Network Settings], and [Network Application Settings]. Open the submenu according to the settings you want to change, and then go to step 2 to change the settings.
- Changes to the settings are automatically applied when you close the menu screen. You do not need to press the [Enter] button.
- Settings in the Network/USB Settings menu are not applied until you select [Reflect] on the confirmation screen.

Restoring Settings to Their Default Settings

This section explains the method for restoring the projector settings to the default values using the remote control.

1. Press the [Menu] button.

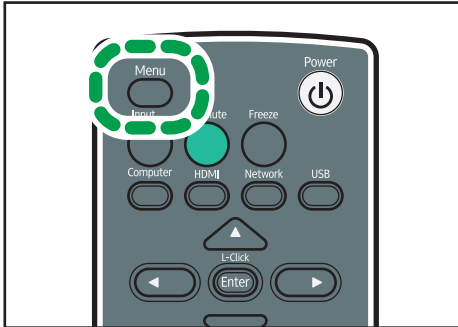

CLB046

2. Select the Default Settings menu tab, and then press the [Enter] button.

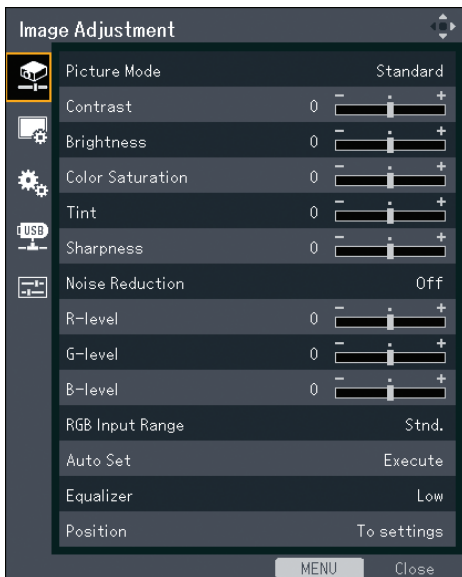

3. Select [Reset All], and then press the [Enter] button.

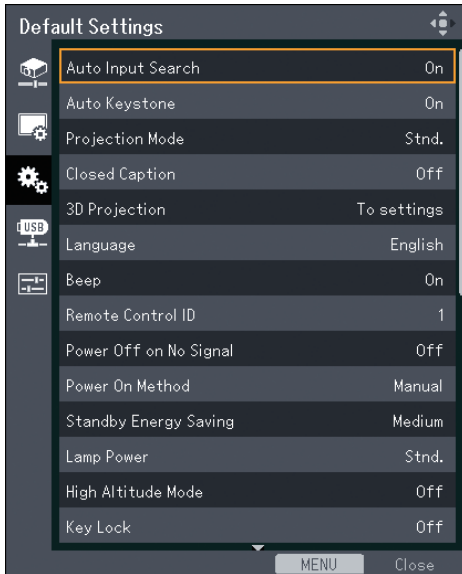

4. Select [OK] in the confirm screen, and then press the [Enter] button.

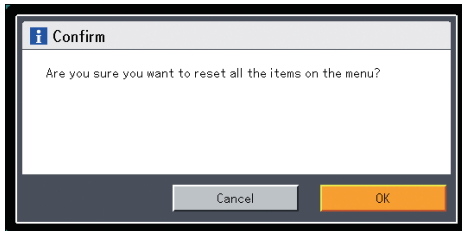

Note

- The following settings cannot be reset with this function:
 - [User Logo] in [Display Settings]
To reset the registered user logo, select [Reset Logo] in [Display Settings].
 - [Password] in [Default Settings]
 - [Administrator Password] in [Network/USB Settings]
To reset the registered passwords, contact your service representative.

List of Menu Items

Image Adjustment menu

Item	Summary
Picture Mode	Select the picture mode.
Contrast	Adjust the image contrast.
Brightness	Adjust the image brightness.
Color Saturation	Adjust the color saturation of the image.
Tint	Adjust the tint of the image.
Sharpness	Adjust the sharpness of the image.
Noise Reduction	Select whether or not to use the function to reduce the Y/Pb/Pr (480i/576i) or video signal noise.
R-level	Adjust the level of red in the image.
G-level	Adjust the level of green in the image.
B-level	Adjust the level of blue in the image.
RGB Input Range	Select the RGB input range.
Auto Set	Automatically adjust the items set for the image according to the type of input signal.
Equalizer	Select the strength of the functions that reduce the HDMI signal noise.
Position	Adjust the values for the image position.

Display Settings menu

Item	Summary
Keystone	Adjust for image keystone distortion.
Aspect	Select the screen size of the image.
Display Position	Move the image if the projected image is smaller or larger than the screen size.

Item	Summary
Wall Color Correction	Select the image hue according to the projection surface when the image is being projected on something other than a screen.
Background on NoSignal	Select the image display when there is no input signal.
Display Help	Select whether or not to display Help when there is no input signal.
Display Icon	Select whether or not to display icons when switching the input signals and settings.
Start-up Screen	Select whether or not to display the start-up screen when the projector is turned on.
User Logo	Register and confirm user logos.

Default Settings menu

Item	Summary
Auto Input Search	Select whether or not to only select inputs with signals when switching input signals.
Auto Keystone	Select whether or not to implement keystone correction automatically depending on the angle of the projector's position.
Projection Mode	Select the projection method according to how the projector is positioned.
Closed Caption	Select the closed caption display method.
3D Projection	Specify 3D projection.
Language	Select the language in which to display menus, etc.
Beep	Select whether or not to beep during use.
Remote Control ID	Select the projector remote control ID.
Power Off on No Signal	Select the time from the final operation to automatic power shutdown when there are no input signals.

Item	Summary
Power On Method	Select whether or not to use the auto power on function.
Standby Energy Saving	Select the level of energy saving while on standby.
Lamp Power	Select the lamp power level.
High Altitude Mode	Select whether or not to increase the speed of the fan.
Key Lock	Select whether or not to lock the buttons on the control panel.
Reset All	Reset all menus to their defaults.
Password	Register a password for the projector.

Network/USB Settings menu

- USB Settings

Item	Summary
Settings	Specify the file projection method using a USB device.
Display Status	Confirm the status of the USB device.

- Network Settings

Item	Summary
Wired LAN	Specify the wired LAN settings.
Wireless LAN	Specify the wireless LAN settings.
LAN Common	Specify the common wired LAN and wireless LAN settings.
Projector ID	Enter an ID to identify the projector on the network.
Display Status	Confirm the status of network settings.

- Network Application Settings

Item	Summary
PJLink	Specify the PJLink settings.
Security	Specify the security settings.
Projection Server	Specify the projection server settings.
Display Status	Confirm the status of the network application settings.

Display Status

4

Item	Summary
Input	Displays the selected input signals.
Resolution	Displays the resolution.
Frequency	Displays the synchronous frequency.
Sync	Displays the synchronous signal polarity.
Signal Format	Displays the Y/Pb/Pr signal format.
Video Mode	Displays the video signal color format.
Lamp Time	Displays the lamp usage time.
Lamp Reset Count	Displays the number of lamp replacements.
Total Time	Displays the projector usage time.
Total CO ₂ Reduction	Displays the total CO ₂ amount that can be reduced by setting the lamp mode to eco mode.
Eco Time Ratio	Displays the ratio of the time eco mode was used to the total use time.
Main FW Version	Displays the version of the firmware on the main board.

Image Adjustment Menu

Picture Mode

Select the picture mode.

This function is not available when you select [On] in [3D Projection] under [Default Settings].

Default: **[Standard]**

- Bright

This image mode makes it easier to see the projection in bright locations.

- Standard

This is the standard image mode.

- Natural

Photos appear more natural in this mode.

Contrast

Adjust the image contrast.

The greater the value, the stronger the image contrast.

Default: **0**

- -16 to +16

Brightness

Adjust the image brightness.

The greater the value, the brighter the image.

Default: **0**

- -16 to +16

Color Saturation

Adjust the color saturation of the image.

The greater the value, the richer the image.

This function is available when you select [Y/Pb/Pr] or [Video] as an input signal.

Default: **0**

- -16 to +16

Tint

Adjust the tint of the image.

This function is available when you select [Y/Pb/Pr], [HDMI] (Y/Pb/Pr signals), or [Video] as an input signal.

Default: **0**

- -16 to +16

Sharpness

Adjust the sharpness of the image.

The greater the value, the sharper the image.

Default: **0**

- -8 to +8

Noise Reduction

Select whether or not to use the function to reduce the Y/Pb/Pr (480i/576i) or video signal noise.

This function is available when you select [Y/Pb/Pr] (480i/576i) or [Video] as an input signal.

Default: **[Off]**

- On
- Off

R-level

Adjust the level of red in the image.

The greater the value, the stronger the color red is in the image.

Default: **0**

- -16 to +16

G-level

Adjust the level of green in the image.

The greater the value, the stronger the color green is in the image.

Default: **0**

- -16 to +16

B-level

Adjust the level of blue in the image.

The greater the value, the stronger the color blue is in the image.

Default: **0**

- -16 to +16

RGB Input Range

Select the RGB input range.

When connecting an AV equipment which outputs a full-range RGB signal by HDMI cable, the image becomes clearer by selecting [Full].

This function is available when you select [HDMI] (RGB signals) as an input signal.

Default: **[Full]**

- Std.
- Full

Auto Set

Automatically adjust the items set for the image according to the type of input signal.

This function is available when you select [Computer] as an input signal.

Equalizer

Select the strength of the functions that reduce the HDMI signal noise.

This function is available when you select [HDMI] as an input signal.

Default: **[Low]**

- Low
- High

Position

Adjust the values for the image position.

This function is available when you select [Computer] as an input signal.

- Phase

Adjust to eliminate image flicker.

Default: **+16**

- 0 to +31

- Frequency

Adjust to eliminate moiré patterns and flicker when you project images with thin vertical-stripes.

Default: **0**

- -64 to +64

- H-position

Adjust the horizontal position of the image.

Default: **0**

- -64 to +64

- V-position

Adjust the vertical position of the image.

Default: **0**

- -32 to +32

- Clamp Pulse 1

Adjust the clamp pulse position.

- 0 to +255
- Clamp Pulse 2

Adjust the clamp pulse width.

- 0 to +255

Display Settings Menu

Keystone

Adjust for image keystone distortion.

This setting changes automatically depending on the angle of the projector position if you select [On] in [Auto Keystone] under [Default Settings].

Default: **0**

- -32 to +32

Aspect

Select the screen size of the image.

This function is not available when you select [USB Memory] as an input signal.

Default: **[Normal]**

- Normal
Display in full screen without changing the input signal aspect ratio.
- 16:9
Display using 16:9 aspect ratio (1280 × 720 resolution).
- Full
Display using 1280 × 800 resolution.
- Native
Display the image without changing the resolution of the input signal.
- Zoom
Display the image width as the projection screen width while maintaining the input signal aspect ratio.

Display Position

Move the image if the projected image is smaller or larger than the screen size.

You can move the image using the [▲], [▼], [◀], and [▶] buttons.

This function is not available when you select [Network] or [USB Memory] as an input signal.

Wall Color Correction

Select the image hue according to the projection surface when the image is being projected on something other than a screen.

Default: **[Off]**

- Off
- Whiteboard
- Beige

- Gray
- Blackboard (Green)

Background on NoSignal

Select the image display when there is no input signal.

Default: **[Logo]**

- Logo
- Blue
- None

Display Help

Select whether or not to display Help when there is no input signal.

Default: **[On]**

- On
- Off

Display Icon

Select whether or not to display icons when switching the input signals and settings.

Default: **[On]**

- On
- Off

Start-up Screen

Select whether or not to display the start-up screen when the projector is turned on.

Default: **[On]**

- On
- Off

User Logo

Register and confirm user logos.

User logos can be displayed in the start-up screen or as the background when there are no input signals.

- Register Logo

Register a user logo. You can register an image with a resolution of up to 1280 × 800 pixels.

Project the image to be registered as a user logo, and then execute this function.

This function is available when you select [Computer], [HDMI] (RGB signals), or [Network] as an input signal.

- Confirm Logo

Display the registered user logo.

- Reset Logo

Delete the registered user logo.

Default Settings Menu

Auto Input Search

Select whether or not to only select inputs with signals when switching input signals.

Default: **[On]**

- On
- Off

Auto Keystone

Select whether or not to implement keystone correction automatically depending on the angle of the projector's position.

Default: **[On]**

- On
- Off

Projection Mode

Select the projection method according to how the projector is positioned.

Default: **[Std.]**

- Std.
Select this mode when the projector is placed in front of a screen.
- Rear
Select this mode when the projector is placed behind a screen.

Closed Caption

Select the closed caption display method.

The projector supports closed captioning, which allows subtitles to be displayed at the bottom of the picture. This is pursuant to the regulations set forth by the US Federal Communications Commission (FCC).

Select [CC-1] to [CC-4] to display the dialogue and narration of TV programs and videos that are closed captioned.

This function is available when you select [Video] as an input signal.

Default: **[Off]**

- Off
- CC-1
- CC-2
- CC-3
- CC-4

3D Projection

Specify 3D projection.

- 3D Projection

Select whether or not to use 3D projection.

The image will be slightly darker if this is set to [On].

Default: **[Off]**

- On
- Off

- DLP Link

Select whether or not to synchronize 3D images and DLP images.

Default: **[On]**

- On
- Off

- L/R Reverse

Select whether or not to reverse left and right in a 3D image.

Default: **[Normal]**

- Normal
- Reverse

Language

Select the language in which to display menus, etc.

Default: **[English]**

Beep

Select whether or not to beep during use.

Default: **[On]**

- On
- Off

Remote Control ID

Select the projector remote control ID.

Specify the ID for each projector when operating multiple projectors using one remote control.

Default: **[1]**

- 1
- 2
- 3

- 4

Power Off on No Signal

Select the time from the final operation to automatic power shutdown when there are no input signals.

Default: **[Off]**

- Off
- 5 min.
- 10 min.
- 20 min.
- 30 min.

4

Power On Method

Select whether or not to use the auto power on function.

Default: **[Manual]**

- Manual
Turn the projector on when the [Power] button is pressed.
- Auto.
Automatically turn on the projector when the power cord is connected.

Standby Energy Saving

Select the level of energy saving while on standby.

You can save power by using this function. The energy saving level is highest when you select [High] and lowest when you select [None]. However, this function affects network functions and start-up time. Select a mode according to how you use the projector.

Default: **[Medium]**

- High
Wired LAN and Wireless LAN are disabled when the projector is in standby.
- Medium
Wired LAN is enabled but Wireless LAN is disabled when the projector is in standby.
- Low
Wired LAN and Wireless LAN are enabled.
- None
Wired LAN and Wireless LAN are enabled. Start-up time is faster.

Lamp Power

Select the lamp power level.

Select [Eco] if the image is too bright or when projecting images in a dark room.

Default: **[Std.]**

- Eco
- Std.

High Altitude Mode

Select whether or not to increase the speed of the fan.

The number of fan rotations is high when set to [On]. Select [On] only when using the projector at an altitude of more than 1,500 meters (4,921 feet). Do not select [On] when the altitude is less than 1,500 meters (4,921 feet).

Default: **[Off]**

- On
- Off

Key Lock

Select whether or not to lock the buttons on the control panel.

You can change this setting to [Off] by pressing the [AV Mute] button on the projector's control panel for 10 seconds.

Default: **[Off]**

- On
- Off

Reset All

Reset all menus to their defaults.

This function cannot restore the default settings of [User Logo] in [Display Settings], [Password] in [Default Settings], and [Administrator Password] in [Network/USB Settings].

Password

Register a password for the projector.

- Register Password

Enter a 6-digit password.

The current password is required to change the password.

Default: **[000000]**

- Password Protect

Select whether or not to enter a password when the projector is turned on. If this is selected, a password must be entered when the projector is turned on after the power cord has been unplugged. However, a password is not required when turning the projector on from the standby mode.

A password is required to change this setting.

Default: **[Off]**

- On
- Off

Network/USB Settings Menu

USB Settings

You can specify how to project files from a USB device and confirm the status of the USB device.

Settings

- Auto Demo
Select whether or not to start a slide show automatically when the projector is connected to the USB device.
Default: **[Off]**
 - On
 - Off
- Repeat
Select whether or not to repeat video playback.
Default: **[Off]**
 - On
 - Off
- Display Interval (sec.)
Enter the slide show switching interval from 5 to 999 seconds.
Default: **5 seconds**
- Remove Device
The USB device can be removed when this command is executed.

Display Status

- USB Memory
Display the USB device status.
 - USB Memory Free Space (KB)
Display the space available on the USB device (Displayed in KB).
 - USB Memory Access Status
Display whether or not the USB device can be accessed.
- Firmware Version
Display the firmware version.
 - Network/USB Function Firmware Version
Display the firmware version of the network and USB functions.

- Energy Saving IO Firmware Version
Display the energy-saving IO firmware version.

Network Settings

Enables the wired LAN and wireless LAN settings, projector ID registration, and network status to be verified.

Wired LAN

Specify the wired LAN settings.

- Wired LAN Settings
 - Transmission Speed
Select the wired LAN speed.
Select a speed that matches your network environment. It is recommended that [Auto-Negotiation] be selected.
Default: **[Auto-Negotiation]**
 - Auto-Negotiation
 - 10BASE-T Full Duplex
 - 10BASE-T Half Duplex
 - 100BASE-TX Full Duplex
 - 100BASE-TX Half Duplex
 - MAC Address
Display the projector's MAC address.
- TCP/IP Settings
 - DHCP
Select whether to enable or disable DHCP.
The IP address is allocated automatically from the DHCP server when [Enable] is selected. When [Disable] is selected, enter the IP address, subnet mask, and default gateway manually.
Default: **[Enable]**
 - Enable
 - Disable
 - IP Address
Enter the projector's IP address.
Default: **0.0.0.0**

- Subnet Mask
Enter the subnet mask.
Default: **0.0.0.0**
- Default Gateway
Enter the default gateway.
Default: **0.0.0.0**

Wireless LAN

Specify the wireless LAN settings.

- Simple Settings
 - Wireless Connection via USB
Select whether or not to use the wireless LAN settings function using a USB memory device.
Default: **[Enable]**
 - Enable
 - Disable
 - Simple Connection (USB Memory)
Save the wireless LAN settings of the projector to the USB memory device.
You can copy the wireless LAN settings saved in the USB memory device to a computer.
 - Simple Wireless LAN Setup
Acquire the wireless LAN settings registered in the access point, and specify infrastructure mode wireless LAN settings for the projector automatically.
This function may not work depending on the access point.
- Wireless LAN Settings
 - SSID
Enter the SSID to identify the network to which the projector is connected via wireless LAN. Enter up to 32 characters.
 - MAC Address
Display the projector's MAC address.
 - Communication Mode
Select the wireless LAN communication mode.
Default: **[Adhoc]**
 - Infrastructure
 - Adhoc
 - Channel

Select the channel to use when [Adhoc] is selected.

Select the channel that matches the type of wireless LAN being used.

The channels available might differ depending on the country.

Default: **[11]**

For IEEE 802.11 b/g/n (2.4 GHz): 1, 2, 3, 4, 5, 6, 7, 8, 9, 10, 11

- Security

- Authentication Method

Select the wireless LAN authentication method.

Only [Open System] is selectable when you select [Adhoc] in [Communication Mode].

Default: **[Open System]**

- Open System
 - WEP Shared Key
 - WPA-PSK
 - WPA2-PSK

- Encryption Method

Select the wireless LAN encryption method.

If you select [No Encryption], the communication is not encrypted. [No Encryption] is selectable only when you select [Open System] in [Authentication Method].

Select [WEP] when you select [Open System] or [WEP Shared Key] in [Authentication Method].

Select [TKIP] or [CCMP] when you select [WPA-PSK] or [WPA2-PSK] in [Authentication Method].

Default: **[No Encryption]**

- No Encryption
 - WEP
 - TKIP
 - CCMP

- Transmission WEP Key Number

Select the Key number used to authenticate and encrypt transmissions when you select [WEP] in [Encryption Method].

Default: **[1]**

- 1
 - 2
 - 3

- 4
- Network Key

Enter the WEP key when you select [WEP Shared Key] or [Open System] in [Authentication Method] and select [WEP] in [Encryption Method].

When using 64 bit WEP, up to 10 characters can be used for hexadecimal and up to 5 characters for ASCII. When using 128 bit WEP, up to 26 characters can be used for hexadecimal and up to 13 characters for ASCII.

Enter PSK when [WPA-PSK] or [WPA2-PSK] is selected in [Authentication Method].

When using a PSK, up to 64 characters can be used for hexadecimal and 8 to 63 characters for ASCII.
- TCP/IP Settings
 - DHCP

Select whether to enable or disable DHCP.

The IP address is allocated automatically from the DHCP server when [Enable] is selected. If you select [Disable], manually enter the IP address, subnet mask, and default gateway.

Default: **[Enable]**

 - Enable
 - Disable
 - IP Address

Enter the projector's IP address.

Default: **0.0.0.0**
 - Subnet Mask

Enter the subnet mask.

Default: **0.0.0.0**
 - Default Gateway

Enter the default gateway.

Default: **0.0.0.0**
- Reset Wireless LAN Settings
 - Reset Wireless LAN Settings

Restore all the wireless LAN settings to their defaults.

LAN Common

Specify the wired LAN and wireless LAN settings.

- Network Interface
 - Network Interface

Select the network interface to be used.

Default: **[Wired LAN Priority]**

- Wired LAN
- Wireless LAN
- Wired LAN Priority

Give priority to wired LAN if connected to the network via an Ethernet cable.
Disconnect the Ethernet cable when using a wireless LAN.

- Disable

- DNS Settings

- Primary DNS Server Address

Enter the IP address of the primary DNS server.

Default: **0.0.0.0**

- Secondary DNS Server Address

Enter the IP address of the secondary DNS server.

Default: **0.0.0.0**

- Host Name

Display the projector's host name.

The [Projector Name] in [Projector ID] is used as the projector's host name.

- Domain Name

Enter the projector's domain name. Enter up to 63 characters.

- Projector Search Settings

- Projector Search

Select whether or not to search for the projector automatically when the projector and the device connected to the projector are on the same network.

Default: **[Enable]**

- Enable
- Disable

- HTTP Client Settings

- HTTP Proxy Server Port

Enter an HTTP proxy server port that is between 0 and 65535.

Default: **80**

- HTTP Proxy Server Name

Enter an HTTP proxy server name that is up to 128 characters.

- HTTP Proxy User Name

Enter an HTTP proxy user name that is up to 31 characters.

- HTTP Proxy Password

Enter an HTTP proxy password that is up to 31 characters.

- HTTP Server Settings

- HTTP Port

Enter an HTTP port that is between 0 and 65535.

Default: **80**

- Manage Certificate

- Import Device Certificate

Import the device certificate saved on the USB memory device to the projector.

Insert the USB memory device into the USB port on the projector to display the file list.
Select the device certificate to be imported from the file list.

- Certificate List

The list of device certificates is displayed.

You can confirm details about the device certificate or delete it in this screen.

Projector ID

- Projector Name

Enter an ID to identify the projector on the network. Enter up to 16 characters.

Default: **[RP]xxxxxx** (xxxxxx is the last six digits of the wired LAN's MAC address)

Display Status

- Wireless LAN

- Connection Status

Display the wireless LAN connection status.

- MAC Address

Display the projector's MAC address.

- Access Point BSSID

Display the currently connected BSSID.

- Communication Mode

Display the wireless LAN communication mode.

- Transmission Speed

Display the wireless LAN transmission speed.

- Channel

Display the wireless LAN channel.

- SSID
Display the SSID of the connected wireless LAN network.
- Authentication Method
Display the wireless LAN authentication method.
- Encryption Method
Display the wireless LAN encryption method.
- IP Address
Display the IP address.
- Subnet Mask
Display the subnet mask.
- Default Gateway
Display the default gateway.
- Wired LAN
 - Connection Status
Display the wired LAN connection status.
 - MAC Address
Display the projector's MAC address.
 - Transmission Speed
Display the wired LAN transmission speed.
 - IP Address
Display the IP address.
 - Subnet Mask
Display the subnet mask.
 - Default Gateway
Display the default gateway.
- Firmware Version
 - Network/USB Function Firmware Version
Display the firmware version of the network and USB functions.
 - Energy Saving IO Firmware Version
Display the energy-saving IO firmware version.

Network Application Settings

These settings enable the projection server, PJLink, etc., to be specified, and the network application status to be verified.

PJLink

Specify the authentication and passwords when accessing the projector using application software that is compatible with PJLink.

- PJLink Authentication

Select whether or not to set PJLink authentication.

Default: **[Off]**

- On
- Off

- PJLink Password

Enter a password used when setting the PJLink authentication that is up to 32 characters.

Security

Specify the password to authenticate the administrator.

If administrator authentication is set, a password is required when changing [Transmission WEP key Number], [Network Key], [PJLink Authentication], [PJLink Password], [Administrator Authentication] or [Administrator Password], and importing or deleting device certificates. A password is also required when operating the projector power via a network

- Administrator Authentication

Select whether or not to set administrator authentication.

Default: **[Off]**

- On
- Off

- Administrator Password

Enter the administrator password using up to 32 character.

Projection Server

Specify the projection server functions.

- Validate Projection by Projection Server

Select whether or not to enable the projection server functions.

Default: **[Disable]**

- Enable
- Disable

- Server URL

Enter the root URL of the server on which the files to be projected using the projection server functions are saved. Enter up to 128 characters.

- Index File

Enter the name of the index file on the projection server. Enter up to 31 characters.

- HTTP Proxy Server Usage

Select whether or not to use a proxy server.

Default: **[No]**

- Yes
- No

- Access Restriction Type

Select whether or not to display the access number input screen when you access the projection server.

Select [Access Number] if access to the projection server is restricted by an access number.

Default: **[None]**

- Access Number
- None

Display Status

- PLink

- PLink Class

Display the PLink class.

- Firmware Version

Display the firmware version.

- Network/USB Function Firmware Version

Display the firmware version of the network and USB functions.

- Energy Saving IO Firmware Version

Display the energy-saving IO firmware version.

Display Status

Input

Displays the selected input signals.

Resolution

Displays the resolution.

This item appears when you select [Computer] or [HDMI] as an input signal.

Frequency

Displays the synchronous frequency.

This item appears when you select [Computer] or [HDMI] as an input signal.

Sync

Displays the synchronous signal polarity.

This item appears when you select [Computer] as an input signal.

Signal Format

Displays the Y/Pb/Pr signal format.

This item appears when you select [Y/Pb/Pr] as an input signal.

Video Mode

Displays the video signal color format.

This item appears when you select [Video] as an input signal.

Lamp Time

Displays the lamp usage time.

Lamp Reset Count

Displays the number of lamp replacements.

Total Time

Displays the projector usage time.

Total CO2 Reduction

Displays the total CO₂ amount that can be reduced by setting the lamp mode to eco mode.

Eco Time Ratio

Displays the ratio of the time eco mode was used to the total use time.

Main FW Version

Displays the version of the firmware on the main board.

5. Troubleshooting

This chapter explains the basic problems and troubleshooting methods when an indicator light is lit.

Indicator Display List



The projector uses the [Power] button, indicators, and beeps to notify you if a malfunction occurs. Check the indicator's status, and implement the following measures.

Indicator display image

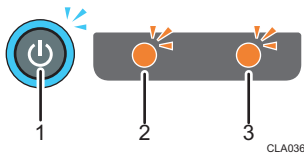
The [Power] button is located on top of the projector. The indicators are on the front of the projector. For details, see p. 15 "Projector Parts and Their Functions".



1. [Power] button
2. Lamp indicator
3. Temp indicator

Status	Causes	Solutions
<p>The projector does not turn on.</p> 	<p>The projector is malfunctioning.</p>	<p>Disconnect the power cord, and contact your service representative.</p>
<p>"Hardware Error" was displayed, and the projector turned off during operation.</p> 	<p>The projector has an internal malfunction.</p>	<p>Disconnect the power cord, wait a while, and then turn on the projector again.</p> <p>If the problem cannot be resolved, contact your service representative.</p>

Status	Causes	Solutions
<p>The lamp turned off during operation, or it does not turn on</p> 	<ul style="list-style-type: none"> • The lamp has overheated and cannot turn on. • The lamp's service life has expired. • The projector has malfunctioned. 	<ul style="list-style-type: none"> • Disconnect the power cord, wait a while, and then turn on the projector again. • If the lamp burns out, replace it with a new lamp. For details of how to replace the lamp, see p.117 "Replacing the Lamp".
<p>The lamp does not turn off.</p>  <p>Flashing interval: 2 seconds</p>	<p>The projector has an internal malfunction.</p>	<p>Disconnect the power cord, wait a while, and then turn on the projector again.</p> <p>If the problem cannot be resolved, contact your service representative.</p>
<p>The projector turned off during operation, or it does not turn on.</p>  <p>Flashing interval: 1 second</p>	<p>The lamp cover is not installed correctly.</p>	<p>Disconnect the power cord, and reinstall the lamp cover correctly. For details of how to install the lamp cover, see p.117 "Replacing the Lamp".</p>
<p>"Temperature Error" was displayed, and the projector turned off during operation.</p> 	<ul style="list-style-type: none"> • The interior has overheated. • The projector is being used in a high-temperature environment. 	<p>Place the projector so that the intake and exhaust vents are not blocked.</p> <p>Disconnect the power cord, wait a while, and then turn on the projector again.</p>
<p>"Fan Error" was displayed, and the projector turned off during operation.</p> 	<p>The cooling fan in the projector has malfunctioned.</p>	<p>Disconnect the power cord, and contact your service representative.</p>

Status	Causes	Solutions
<p>"Installation Error" was displayed, and the projector turned off during operation, or it does not turn on.</p> 	<p>The projector's angle is too great.</p>	<p>Place the projector at a proper angle, and then turn it on again.</p>

Note

- "🔦" means the indicator is flashing.

Common Problems

If you think a malfunction has occurred, check the following before contacting your service representative.

Problem	Solutions
Power does not turn on.	<ul style="list-style-type: none"> • Make sure the power plug or connector is connected correctly. • Make sure the lamp cover is mounted correctly. For details, see p. 117 "Replacing the Lamp".
Power turns off during use.	<ul style="list-style-type: none"> • Make sure the environment in which the projector is being used is within the acceptable temperature range. • Make sure the vents are not blocked.
No image.	<ul style="list-style-type: none"> • Make sure the input signal is switched correctly if [Auto Input Search] in [Default Settings] is set to [Off]. For details, see p.90 "Default Settings Menu". • Make sure the mute function is not turned on. For details, see p.41 "Temporarily blanking the image and muting the audio". • Check the settings of [Brightness] in [Image Adjustment]. For details, see p.83 "Image Adjustment Menu". • Make sure the computer or AV equipment is connected to the projector correctly. For details, see p.28 "Connecting Equipment to the Projector". • Make sure the computer's image output is switched correctly. For details, see p.36 "When projecting the screen of a notebook computer". • Make sure the computer or AV equipment is working properly.

Problem	Solutions
No sound.	<ul style="list-style-type: none"> • Press the [Input] button. For details, see p.35 "Selecting an Input Signal". • Make sure the mute function is not turned on. For details, see p.41 "Temporarily blanking the image and muting the audio". • Check the speaker's volume adjustment. For details, see p.40 "Adjusting the Volume of the Speaker". • Make sure the computer or AV equipment is connected to the projector correctly. For details, see p.28 "Connecting Equipment to the Projector". • Make sure the computer or AV equipment is working properly.
Image is not projected normally.	<ul style="list-style-type: none"> • Make sure the input signal is compatible with the projector. For details, see p.127 "List of Compatible Signals". • Check the status of the video tape or other video source.
Image is blurred. Image is partially out of focus.	<ul style="list-style-type: none"> • Make sure the projection window is clean. For details, see p.116 "Cleaning the Projection Window". • Check the focus adjustment. For details, see p.38 "Adjusting the focus". • Make sure the projection distance is within the projector's range. For details, see p.26 "Relationship Between the Projection Distance and the Screen Size". • Check the installation angles of the projector and screen. For details, see p.36 "Adjusting the Angle of the Projection". • Check the settings of [Sharpness] and [Phase] in [Image Adjustment]. For details, see p.83 "Image Adjustment Menu".

Problem	Solutions
Image is dark.	<ul style="list-style-type: none"> • Check the settings of [Brightness] and [Contrast] in [Image Adjustment]. For details, see p.83 "Image Adjustment Menu". • Make sure the lamp is not near the end of its service life. For details, see p.105 "Display Status". • Check the settings of [RGB Input Range] in [Image Adjustment]. For details, see p.83 "Image Adjustment Menu". • Make sure [3D Projection] in [Default Settings] is set to [Off]. For details, see p.90 "Default Settings Menu".
Color is faded. Tint is poor.	<ul style="list-style-type: none"> • Check the settings of [Color Saturation], [R-level], [G-level], and [B-level] in [Image Adjustment]. For details, see p.83 "Image Adjustment Menu". • Make sure the screen is clean. • Check the settings of [Wall Color Correction] in [Display Settings]. For details, see p.87 "Display Settings Menu". • Make sure the lamp is not near the end of its service life. For details, see p.105 "Display Status"
The projector's operation keys do not respond.	<ul style="list-style-type: none"> • Make sure [Key Lock] in [Default Settings] is not set to [On]. For details, see p.90 "Default Settings Menu".

Problem	Solutions
The remote control does not respond.	<ul style="list-style-type: none"> • Make sure the ID assigned to the remote control and in the settings of [Remote Control ID] in [Default Settings] are the same. For details, see p.90 "Default Settings Menu". • Make sure the batteries in the remote control are not dead. • Make sure the batteries are correctly loaded into the remote control. For details, see p.21 "Loading Batteries into the Remote Control". • Make sure the remote control is inside its effective range. For details, see p.20 "Effective Range of the Remote Control". • Make sure there is nothing placed between the remote control and the projector. • Make sure the remote control receiver is not exposed to strong light.
No images from USB devices.	<ul style="list-style-type: none"> • Make sure the USB memory device is connected correctly. • Make sure the connected USB memory device is compatible with the projector. • Make sure there are JPEG or MPEG files saved on the USB memory device. • Make sure the compression format, file size, and other conditions are compatible with the projector. For details, see p.46 "Projecting Images from a USB Memory Device or Digital Camera".
Wired LAN is disabled.	<ul style="list-style-type: none"> • Check the settings of [Wired LAN Settings] in [Network Settings] under [Network/USB Settings]. For details, see p.96 "Network Settings".

Problem	Solutions
Wireless LAN is disabled.	<ul style="list-style-type: none">• Check the settings of [Wireless LAN Settings] in [Network Settings] under [Network/USB Settings]. For details, see p.96 "Network Settings".• Make sure there is nothing placed between the computer and the projector.• Make sure the operating system of the computer is compatible with Network Utility. Log in to the computer using administrator privileges to configure the wireless LAN settings using Simple 1:1 Connection or a USB memory device. For details, see p.61 "What Is Network Utility?".• Make sure that the projector is not in standby.

6. Maintenance

This chapter explains the operating precautions and maintenance for the projector.

Operating Precautions

Pay attention to the following points when using the projector:

- If moving the projector under conditions including vibration and shock, use both the packing case and included carrying bag. Transporting the projector using the carrying bag only may damage it due to shock or vibration. Further, transporting the projector in a damaged packing case may damage the projector, so use a packing case that is in good condition.
- Do not apply volatile substances such as insecticide to the projector. Also, do not bring the projector into long-term contact with rubber or vinyl products. Doing so may cause discoloration or the paint to peel.
- The projector is not intended for long-term continuous operation. Further, remove the projector from the packing case before using. If a malfunction occurs when using the projector under these conditions, a fee is charged for repair even if the warranty is still in effect.
- Do not use locations that may be hot, such as near a heater. Doing so may cause the projector to malfunction or reduce the service life.
- Avoid locations that may become smoky. Particulates may adhere to the optical parts, reducing the service life and causing the image to darken.
- Using the projector close to a television or radio may adversely affect the images and sound. If this happens, move the projector away from the television or radio.
- Moving the projector from a low-temperature location to a high-temperature location may cause water droplets to form on the projector lens and parts due to condensation. Continued use under such conditions may cause malfunction, so do not use the projector until the water droplets have evaporated.
- The air is thin at high elevations, so the cooling efficiency of the projector is reduced. Select [On] in [High Altitude Mode] before using.
- Do not use the projector in an extremely inclined position ($\pm 20^\circ$ or greater). Doing so may cause malfunction or reduce the service life.
- Do not use benzene or paint thinners. Doing so may cause the projector to warp, discolor, or the paint to peel. Further, do not use cleaning cloths that contain chemicals.

Cleaning the Projector

WARNING

- Do not remove any covers or screws that are not mentioned in this manual. There are high voltage components inside the product that may cause electric shock. Contact your service representative if any of the product's internal components require maintenance, adjustment, or repair.
- Do not disassemble or modify the product. Doing so may cause injury or malfunction.

CAUTION

- When performing maintenance on the machine, always disconnect the power cord from the wall outlet.

Cleaning the Projection Window

6

When cleaning the projection window, make sure to do the following:

- Use a commercially available blower or cloth for cleaning glass, cleaning paper, lens cleaner, etc.
- The projection window surface scratches easily, so do not rub or tap it with a hard object.

Cleaning the Projector

When cleaning the projector, make sure to do the following:

- Disconnect the power plug before cleaning.
- Gently wipe any dirt from the projector using a soft cloth. Using a damp cloth may cause water to seep inside the projector and cause electric shock or malfunction.
- Do not use benzene or paint thinners. Doing so may cause the projector to warp, discolor, or the paint to peel. Further, do not use cleaning cloths that contain chemicals.

Replacing the Lamp

WARNING

- Before replacing the lamp, turn off the power and wait at least one hour to allow the product to cool completely. If it is not completely cool, you may burn or injure yourself due to the inside of the product and lamp unit being hot. If you replace the lamp without unplugging the power cord from the power outlet, electric shock or explosion may occur.
- Be careful when handling the used lamp so that it does not break. If it breaks, it may cause injury.

CAUTION

- Be sure to always use a dedicated replacement lamp that is new when replacing the lamp. If you use a lamp that is not dedicated, it may result in an explosion and injury.

Important

- **The lamp is a glass product. Do not touch the glass surface with bare hands, hit it forcefully, or damage it.**
- **This projector's lamp contains trace amounts of environmentally harmful inorganic mercury. Be careful not to break used lamps, and dispose of them in accordance with local regulations or contact your sales representative or service representative.**

When the lamp is due for replacement, the message "The lamp is reaching the end of its life. Please change it." is displayed. Change the lamp as instructed.

Furthermore, if the lamp is used for an extended period of time, the image may darken or the lamp may burn out. If this happens, replace the lamp with a new one.

When [Lamp Power] in [Default Settings] is specified as [Standard], replace the lamp after approximately 3,000 hours. When the setting is [Eco], replace it after approximately 4,000 hours. This may differ, however, depending on how the lamp is used.

- 1. Turn over the projector and place it on a flat surface so that you can see the bottom of the projector.**

2. Turn the knob counterclockwise, and then open the lamp cover.

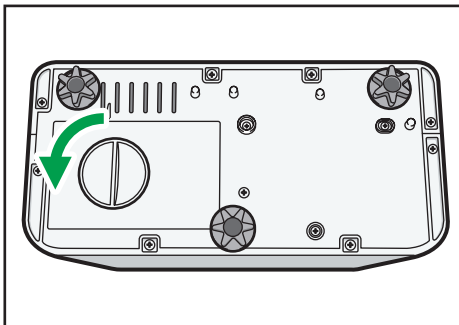

CLB059

3. Raise the metal handle.

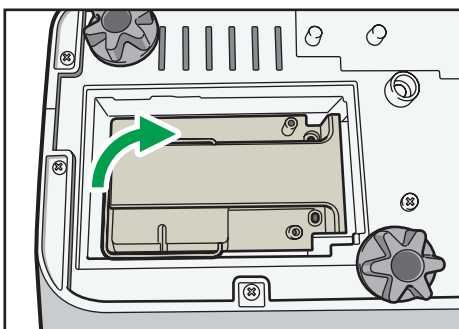

CLB061

4. Hold the handle, and then pull the lamp unit out of the projector.

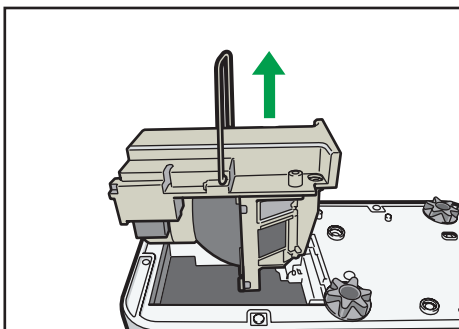

CLB062

5. Insert a new lamp unit.

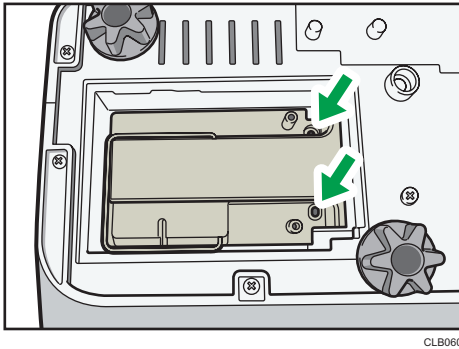

Make sure that the small projections inside the projector are inserted into the holes of the lamp unit properly.

6. Close the lamp cover.

Correctly install the outer lamp cover. Incorrect installation may prevent the lamp or projector from turning on.

7. Reset the lamp time.

For the reset method, see the manual provided with the lamp.

↓ Note

- The lamp's service life can be verified using [Lamp Time] in [Display Status].
- The lamp may stop working before it reaches its approximate service life or before the replacement message is displayed.

Managing the Projector Using Projector Management Utility

Projector Management Utility conforms to the PJLink class 1 standards, and is compatible with all class 1 commands.

A maximum of 100 projectors connected to the network can be managed using one computer.

Projector Management Utility operating environment is described below.

- Supported operating system
 - Windows XP SP3 (32-bit version) Professional Edition, Home Edition
 - Windows Vista (32-bit version) Ultimate, Business, Home Premium, Home Basic
 - Windows 7 (32-bit version) Home Premium, Professional, Ultimate, Enterprise
- Memory size
Recommended memory size for the operating system of the computer you are using
- Display resolution
800 × 600 pixels or more

↓ Note

- This software is to control and monitor projectors manufactured by our company. The software may not work properly when used to control other projectors.

Installing Projector Management Utility

Projector Management Utility is included on the supplied CD-ROM.

Log in to the computer with administrator privileges to install or uninstall utilities.

- 1. Close all applications.**
- 2. Insert the CD-ROM in the CD-ROM drive of your computer.**
- 3. Specify a language.**
The launcher screen appears.
- 4. Click [Projector Management Utility].**
- 5. Install the application by following the on-screen instruction.**
- 6. When the installation is complete, exit the installer.**

A shortcut icon is created on the desktop.

Note

- To uninstall Projector Management Utility, use the program delete function in [Control Panel] to delete "Projector Management Utility".

Settings Required to Use Projector Management Utility

Prepare the network so the projector can be connected. Specify the settings either in [Wireless LAN] or [Wired LAN].

Specify the following settings to control the projector using Projector Management Utility:

- [Projector ID] in [Network Settings]
- [PJLink] items in [Network Application Settings]

For details, see p.95 "Network/USB Settings Menu".

Note

- [PJLink Password] is not specified by factory defaults. It is recommended to register a password as soon as possible. If you forget the password, register a new password. The new password is valid.

Starting Projector Management Utility

Projector Management Utility acquires the projector registration information from the configuration file, when it is launched.

The following information can be obtained:

- Projector status (power on and off, input signal, Av mute on and off, lamp status, error status)
- Projector information (product name, manufacturer, available input ports, other information)

The functions that can be operated from Projector Management Utility are power on and off, input signal switching, and mute. Settings cannot be changed if the function specified by the projector is not compatible.

1. Double-click the "Projector Management Utility" icon on the desktop.

The information for the projectors detected by the application is displayed.

Note

- If using Projector Management Utility with Windows Vista or Windows 7, log in using administrator privileges.
- The projector must be registered in advance. For details, see the Projector Management Utility Help.

- Depending on the setting in [Standby Energy Saving], the projector does not respond even if the projector is in standby mode. Press the [Power] button, or change the setting in [Standby Energy Saving].
- If a communications error prevents the projector from being detected, "?" is displayed. If the connection failed due to an incorrect password or other reason, "x" is displayed.
- The details displayed in the Projector Management Utility "Input" and the corresponding projector input signals are described below:

Projector input signal	PJLink input name
Computer	RGB 1
Y/Pb/Pr	RGB2
HDMI	DIGITAL1
Video	VIDEO1
Network	NETWORK1
USB Memory	STORAGE1

- See the Projector Management Utility Help for how to use Projector Management Utility.

Consumables

- Lamp unit
Replacement Lamp Type 3

⬇ Note

- Contact your sales or service representative for information about consumables.

7. Appendix

This chapter explains the projector's specifications and compatible signals. This chapter also explains where to inquire about the projector and related services.

Specifications

Specifications for the Projector

Component	Specifications
Power consumption	300 W or less
Weight	Approx. 3.0 kg (6.7 lb.)
External dimensions (not including protruding parts)	257 × 144 × 221 mm (10.1 × 5.7 × 8.7 inches)
Operating environment	Temperature: 5 to 35°C (73 to 95°F), Humidity: 30 to 70%
Display element	<ul style="list-style-type: none">• Display method Single-chip DLP®• Panel size 0.65 inches• Pixels 1,024,000 pixels (1280 H × 800 V)
Projection method	Ultra short-focus lens/mirror projection method
Lamp	High-pressure mercury lamp (Standard mode: 225 W, Eco mode: 170 W)
Projection screen size	48 to 80 inches
Projection distance	12 to 25 cm (4.6 to 9.8 inches)
Speaker	2 W (Mono)

Component	Specifications
Connection ports	<ul style="list-style-type: none"><li data-bbox="591 309 824 388">• COMPUTER In port Mini D-SUB15 × 1<li data-bbox="591 399 930 478">• HDMI port (HDCP compliant)* HDMI × 1<li data-bbox="591 490 765 568">• Video In port RCA_1 pin × 1<li data-bbox="591 580 755 658">• Audio In port Mini Jack × 1<li data-bbox="591 670 820 748">• Control port USB-TYPE-minB × 1<li data-bbox="591 760 865 995">• USB port TYPE-A × 1 USB 2.0 High-speed Output voltage: DC 5 V Supply current: 500 mA<li data-bbox="591 1007 1030 1132">• LAN port RJ-45 10BASE-T/100BASE-TX/1000BASE-T

* HDCP (High-bandwidth Digital Content Protection) is a copyright protection method to encrypt digital signals across the DVI/HDMI interface and prevent unauthorized copying. The HDCP specification was developed and is licensed by Digital Content Protection, LLC. The HDMI port on this projector is HDCP compliant and can project digital video content protected by HDCP. Updates to the HDCP specification may void this compliance and prevent access to protected data. If this occurs, it is not caused by the projector.

List of Compatible Signals

Set the computer and AV equipment output signals so that they match the input signals compatible with the projector.

If resolutions or signal frequencies that are not compatible with the projector are input, the image may flicker or become blurred. Further, the image may not be displayed.

↓ Note

- Images with a resolution greater than 1280 × 800 are compressed when displayed, so some of the information may be lost or the image may deteriorate.

Computer Input

Mode	Resolution		Frequency		
	Horizontal (pixel)	Vertical (pixel)	Vertical (Hz)	Horizontal (kHz)	Clock (MHz)
640 × 480	640	480	59.940	31.469	25.175
			72.809	37.861	31.500
			75.000	37.500	31.500
			85.008	43.269	36.000
720 × 400	720	400	85.039	37.927	35.500
800 × 600	800	600	56.250	35.156	36.000
			60.317	37.879	40.000
			72.188	48.077	50.000
			75.000	46.875	49.500
			85.061	53.673	56.250
832 × 624	832	624	74.550	49.725	57.283
848 × 480	848	480	60.000	31.020	33.750

Mode	Resolution		Frequency		
	Horizontal (pixel)	Vertical (pixel)	Vertical (Hz)	Horizontal (kHz)	Clock (MHz)
1024 × 768	1024	768	60.004	48.363	65.000
			70.069	56.476	75.000
			75.029	60.023	78.750
			84.997	68.678	94.500
			74.700	60.134	79.857
1152 × 864	1152	864	75.000	67.500	108.000
1152 × 870	1152	870	75.062	68.682	100.001
1280 × 720	1280	720	60.000	45.000	74.250
1280 × 768	1280	768	59.995	47.396	68.250
			59.870	47.776	79.500
			74.893	60.289	102.250
			84.837	68.633	117.500
1280 × 800	1280	800	59.910	49.306	71.000
			59.810	49.702	83.500
			74.934	62.795	106.500
			84.880	71.554	122.500
1280 × 960	1280	960	60.000	60.000	108.000
			75.019	75.019	126.032
			85.002	85.937	148.500
1280 × 1024	1280	1024	60.020	63.981	108.000
			75.025	79.976	135.000
			85.024	91.146	157.500
1360 × 768	1360	768	60.015	47.712	85.500

Mode	Resolution		Frequency		
	Horizontal (pixel)	Vertical (pixel)	Vertical (Hz)	Horizontal (kHz)	Clock (MHz)
1366 × 768	1366	768	60.000	48.000	72.000
			59.790	47.712	85.500
1400 × 1050	1400	1050	59.948	64.744	101.000
			59.978	65.317	121.750
			74.867	82.278	156.000
1440 × 900	1440	900	59.901	55.469	88.750
			59.887	55.935	106.500
			74.984	70.635	136.750
			84.842	80.430	157.000
1600 × 900	1600	900	60.000	60.000	108.000
1600 × 1200	1600	1200	60.000	75.000	162.000
1680 × 1050	1680	1050	59.883	64.674	119.000
			59.954	65.290	146.250

Y/Pb/Pr Input

Mode	Resolution		Frequency		
	Horizontal (pixel)	Vertical (pixel)	Vertical (Hz)	Horizontal (kHz)	Clock (MHz)
480i (525i)	720	242.5	59.940	15.734	13.500
480p (525p)	720	483	59.940	31.469	27.000
576i (625i)	720	288	50.000	15.625	13.500
576p (625p)	720	576	50.000	31.250	27.000
720 / 50p	1280	720	50.000	37.500	74.250

Mode	Resolution		Frequency		
	Horizontal (pixel)	Vertical (pixel)	Vertical (Hz)	Horizontal (kHz)	Clock (MHz)
720 / 60p	1280	720	60.000	45.000	74.250
1080 / 50i	1920	540	50.000	28.125	74.250
1080 / 60i	1920	540	60.000	33.750	74.250
1080 / 50p	1920	1080	50.000	56.250	148.500
1080 / 60p	1920	1080	60.000	67.500	148.500

Video Input

Mode	Frequency
	Vertical (Hz)
NTSC	59.940
PAL	50.000
SECAM	50.000
PAL-M	59.940
PAL-N	50.000
PAL60	59.940
NTSC4.43	59.940

HDMI Input

Mode	Resolution		Frequency		
	Horizontal (pixel)	Vertical (pixel)	Vertical (Hz)	Horizontal (kHz)	Clock (MHz)
480i (525i)	720	242.5	59.940	15.734	13.500
576i (625i)	720	288	50.000	15.625	13.500

Mode	Resolution		Frequency		
	Horizontal (pixel)	Vertical (pixel)	Vertical (Hz)	Horizontal (kHz)	Clock (MHz)
480p (525p)	720	483	59.940	31.469	27.000
576p (625p)	720	576	50.000	31.250	27.000
720 / 50p	1280	720	50.000	37.500	74.250
720 / 60p	1280	720	60.000	45.000	74.250
1080 / 50i	1920	540	50.000	28.125	74.250
1080 / 60i	1920	540	60.000	33.750	74.250
1080 / 24p	1920	1080	24.000	27.000	74.250
1080 / 30p	1920	1080	30.000	33.750	74.250
1080 / 50p	1920	1080	50.000	56.250	148.500
1080 / 60p	1920	1080	60.000	67.500	148.500
640 × 480	640	480	59.940	31.469	25.175
			72.809	37.861	31.500
			75.000	37.500	31.500
			85.008	43.269	36.000
720 × 400	720	400	85.039	37.927	35.500
800 × 600	800	600	56.250	35.156	36.000
			60.317	37.879	40.000
			72.188	48.077	50.000
			75.000	46.875	49.500
			85.061	53.673	56.250
832 × 624	832	624	74.550	49.725	57.283
848 × 480	848	480	60.000	31.020	33.750

Mode	Resolution		Frequency		
	Horizontal (pixel)	Vertical (pixel)	Vertical (Hz)	Horizontal (kHz)	Clock (MHz)
1024 × 768	1024	768	60.004	48.363	65.000
			70.069	56.476	75.000
			75.029	60.023	78.750
			84.997	68.678	94.500
			74.700	60.134	79.857
1152 × 864	1152	864	75.000	67.500	108.000
1152 × 870	1152	870	75.062	68.682	100.001
1280 × 720	1280	720	60.000	45.000	74.250
1280 × 768	1280	768	59.995	47.396	68.250
			59.870	47.776	79.500
			74.893	60.289	102.250
			84.837	68.633	117.500
1280 × 800	1280	800	59.910	49.306	71.000
			59.810	49.702	83.500
			74.934	62.795	106.500
			84.880	71.554	122.500
1280 × 960	1280	960	60.000	60.000	108.000
			75.019	75.019	126.032
			85.002	85.937	148.500
1280 × 1024	1280	1024	60.020	63.981	108.000
			75.025	79.976	135.000
			85.024	91.146	157.500
1360 × 768	1360	768	60.015	47.712	85.500

Mode	Resolution		Frequency		
	Horizontal (pixel)	Vertical (pixel)	Vertical (Hz)	Horizontal (kHz)	Clock (MHz)
1366 × 768	1366	768	60.000	48.000	72.000
			59.790	47.712	85.500
1400 × 1050	1400	1050	59.948	64.744	101.000
			59.978	65.317	121.750
			74.867	82.278	156.000
1440 × 900	1440	900	59.901	55.469	88.750
			59.887	55.935	106.500
			74.984	70.635	136.750
			84.842	80.430	157.000
1600 × 900	1600	900	60.000	60.000	108.000
			60.000	75.000	162.000
1680 × 1050	1680	1050	59.883	64.674	119.000
			59.954	65.290	146.250

Specifications for Ports

Computer In Port

Pin assignment

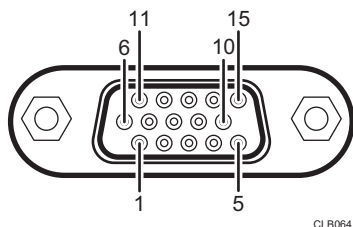

Pin No.	Pin description	
	During RGB input	During Y/Pb/Pr input
1	Video signal (R)	Color difference signal (Pr)
2	Video signal (G)	Luminance signal (Y)
3	Video signal (B)	Color difference signal (Pb)
4	N.C	-
5	GND	-
6	GND (R)	GND (Pr)
7	GND (G)	GND (Y)
8	GND (B)	GND (Pb)
9	N.C	-
10	GND	-
11	N.C	-
12	I ² C Data	-
13	Horizontal sync signal	-
14	Vertical sync signal	-
15	I ² C CLOCK	-

Input Signal

- RGB input
RGB signals: 0.7V (p-p), 75 Ω
Horizontal sync signal: TTL level (Pos/neg polarity)
Vertical sync signal: TTL level (Pos/neg polarity)
- Y/Pb/Pr input
Y signal: 1.0V (p-p), 75 Ω
Pb/Pr signals: 0.7V (p-p), 75 Ω

Control Port

Interface format

Communication method	RS-232C, 115,200bps, No Parity, Data Length: 8 bits; Stop Bit Length: 1 bit
Communication format	#(23h)' + Command + CR (0Dh) Only 1 command valid per communication. For the available commands, see "Main commands".
Data format	For input commands, only ASCII-compliant all-uppercase alphanumeric characters supported.
Replies	<ul style="list-style-type: none"> • Acknowledge (Aborted) '=(3Dh)' + Command(3byte) + ':(3Ah)' + 'E(45h)' + 'R(52h)' + 'O(30h)' + CR(0Dh) • No acknowledge '=(3Dh)' + 'E(45h)' + 'R(52h)' + 'O(30h)' + CR(0Dh) For details of Acknowledge (Normally ended), see "Main commands".

Main commands

Item	Command	Acknowledge (Normally ended) *
Power on	PON	=PON:SC0
Power off	POF	=POF:SC0

Item	Command	Acknowledge (Normally ended) *
Icon display on	ICN:1	=ICN:1
Icon display off	ICN:0	=ICN:0
Auto setting (RGB input)	PAT	=PAT:SC0
Status display on	DON	=DON:SC0
Status display off	DOF	=DOF:SC0
RGB input	INP:1	=INP:1
Y/Pb/Pr input	INP:2	=INP:2
HDMI input	INP:5	=INP:5
Video input	INP:9	=INP:9
Network input	INP:12	=INP:12
USB input	INP:13	=INP:13

* CR is added to the end of "Acknowledge (Normally ended)".

↓ Note

- The control port is for service representatives or administrators of the projector.
- A USB driver must be installed to control the projector using the control port. For details, contact your service representative.

Copyrights

This product uses open source and/or third party software. To check the information about software copyrights, see the documents in the "Copyrights" folder on the supplied CD-ROM.

Where to Inquire

Contact your sales or service representative for further information about topics covered in this manual or to inquire about topics not covered in this manual.

Trademarks

Adobe, Acrobat, and Reader are either registered trademarks or trademarks of Adobe Systems Incorporated in the United States and/or other countries.

DLP is a registered trademark of Texas Instruments. DLP Link is a trademark of Texas Instruments.

HDMI and High-Definition Multimedia Interface are trademarks or registered trademarks of HDMI Licensing, LLC.

Microsoft[®], PowerPoint[®], Windows[®], and Windows Vista[®] are either registered trademarks or trademarks of Microsoft Corporation in the United States and/or other countries.

PJLink trademark is a trademark applied for registration or is already registered in Japan, the United States of America and other countries and areas.

VGA and WXGA are trademarks or registered trademarks of IBM Corporation in the United States, other countries or both.

Other product names used herein are for identification purposes only and might be trademarks of their respective companies. We disclaim any and all rights to those marks.

The proper names of the Windows operating systems are as follows:

- The product names of Windows XP are as follows:

Microsoft[®] Windows[®] XP Professional Edition

Microsoft[®] Windows[®] XP Home Edition

Microsoft[®] Windows[®] XP Media Center Edition

Microsoft[®] Windows[®] XP Tablet PC Edition

Microsoft[®] Windows[®] XP Professional x64 Edition

- The product names of Windows Vista are as follows:

Microsoft[®] Windows Vista[®] Ultimate

Microsoft[®] Windows Vista[®] Business

Microsoft[®] Windows Vista[®] Home Premium

Microsoft[®] Windows Vista[®] Home Basic

Microsoft[®] Windows Vista[®] Enterprise

- The product names of Windows 7 are as follows:

Microsoft[®] Windows[®] 7 Home Premium

Microsoft[®] Windows[®] 7 Professional

Microsoft[®] Windows[®] 7 Ultimate

Microsoft[®] Windows[®] 7 Enterprise

- The product names of Windows Server 2003 R2 are as follows:

Microsoft[®] Windows Server[®] 2003 R2 Standard Edition

Microsoft® Windows Server® 2003 R2 Enterprise Edition

Microsoft® Windows Server® 2003 R2 Datacenter Edition

- The product names of Windows Server 2008 R2 are as follows:

Microsoft® Windows Server® 2008 R2 Foundation

Microsoft® Windows Server® 2008 R2 Standard

Microsoft® Windows Server® 2008 R2 Enterprise

Microsoft® Windows Server® 2008 R2 Datacenter

Microsoft® Windows Server® 2008 R2 for Itanium-based Systems

Microsoft® Windows® Web Server 2008 R2

Microsoft® Windows® HPC Server 2008 R2

INDEX

3D Projection.....91

A

AC In socket.....17
Accessories.....13
Ad Hoc mode.....58
Adjustable feet.....16, 36
Adjusting for keystone distortion.....39
Adjusting the focus.....38
Adjusting the image.....37, 39
Adjusting the projection angle.....36
Adjusting the volume.....40
Angle of the projection.....36
Arrow buttons.....15, 18
Aspect.....87
Aspect button.....18, 43
Audio In port.....17
Auto Input Search.....90
Auto Keystone.....90
Auto Set.....85
Auto set button.....18, 39
AV Mute button.....15, 18, 41

B

B-level.....84
Background on NoSignal.....88
Basic operations.....33
Beep.....91
Blanking the image.....41
Brightness.....83

C

Changing the aspect ratio.....43
Changing the image quality.....43
Changing the settings.....73
Changing the size of the image.....37
Cleaning.....116
Clear button.....18
Closed Caption.....90
Color Saturation.....83
Common problems.....110
Compatible signals.....127

Compatible signals (Computer input).....127
Compatible signals (HDMI input).....130
Compatible signals (Video input).....130
Compatible signals (Y/Pb/Pr input).....129
Computer button.....18
Computer In port.....17, 134
Computer-free presentations.....46
Connecting a computer.....28
Connecting AV equipment.....29
Connecting equipment.....28
Connecting the power cord.....30
Connecting the USB device.....47
Connecting to a network.....53
Consumables.....123
Contrast.....83
Control panel.....15
Control port.....135
Copying computer settings.....64
Copying projector settings.....65
Copyrights.....137
Copyrights to Images.....5

D

Default Settings menu.....90
Digital camera.....46
Disconnecting the USB device.....49
Display Help.....88
Display Icon.....88
Display Position.....87
Display Settings menu.....87
Display Status.....95, 101, 104, 105

E

Eco button.....18, 44
Eco Time Ratio.....105
Effective range.....20
Enlarging the image.....41
Enter button.....15, 18
Equalizer.....85
Error.....107
Ethernet.....55
Exhaust vents.....16

F

Fan Error.....	107
Focus.....	38
Focus lever.....	16, 38
Folder management file.....	67
Freeze button.....	18, 42
Frequency.....	105
Front view.....	16

G

G-level.....	84
Guide button.....	18

H

Hardware Error.....	107
HDMI button.....	18
HDMI port.....	17
High Altitude Mode.....	93
How to read this manual.....	10

I

ID button.....	18
Image Adjustment menu.....	83
Important.....	5
Indicator display list.....	107
Indicators.....	16
Infrastructure mode.....	58
Input.....	105
Input button.....	15, 18, 35
Input signal.....	35
Inputting text.....	22
Inquiry.....	138
Installation Error.....	107
Intake vents.....	17
Introduction.....	5

J

JPEG.....	49
JPEG Conversion Tool.....	49, 51

K

Key Lock.....	93
Keystone.....	87
Keystone button.....	18, 39

L

Lamp.....	117
Lamp power.....	44
Lamp Power.....	92
Lamp Reset Count.....	105
Lamp Time.....	105
LAN Common.....	99
LAN port.....	17
Language.....	34, 91
Left-side view.....	16
Loading batteries.....	21

M

Magnify button.....	18, 41
Main functions.....	11
Main FW Version.....	105
Managing the projector.....	120
Manipulating images.....	40
Manuals.....	7, 9
Menu button.....	15, 18
Menu items.....	79
Menu screen.....	71, 73, 77
Mouse remote control receiver.....	23
Muting the audio.....	41

N

Network.....	53
Network Application Settings.....	103
Network button.....	18
Network Connection.....	63
Network server.....	67
Network Settings.....	53, 96
Network Utility.....	61
Network/USB Settings.....	95
Noise Reduction.....	84
Notebook computer.....	36
Notes.....	10
Number buttons.....	18

O

Operating Instructions.....	7
Operating precautions.....	115

P

Page button.....	18
Password.....	93
Pausing the image.....	42
PDF manual.....	9
Picture button.....	18, 43
Picture Mode.....	83
PJLink.....	103, 120
Position.....	85
Positioning the projector.....	26
Power button.....	15, 18, 34, 44
Power cord.....	30
Power Off on No Signal.....	92
Power On Method.....	92
Precautions.....	115
Projecting an image.....	33, 46, 47, 48, 61, 67, 68
Projecting the computer's screen.....	36
Projection distance.....	26
Projection height.....	26
Projection Mode.....	90
Projection server.....	67, 68
Projection Server.....	103
Projection window.....	15, 116
Projector ID.....	101
Projector Management Utility.....	120, 121
Projector parts.....	15

R

R-Click button.....	18
R-level.....	84
Rear view.....	17
Remote control.....	18, 20, 21, 22, 40
Remote Control ID.....	24, 91
Remote control receiver.....	16
Replacing the lamp.....	117
Reset All.....	77, 93
Resolution.....	105
Restoring the settings.....	77
RGB Input Range.....	84
Right-side view.....	17

S

Safety Information.....	7
-------------------------	---

Screen size.....	26
Security.....	103
Security slot.....	17
Selecting an input signal.....	35
Server URL.....	68
Settings using a USB memory device.....	64
Setup Guide.....	7
Sharpness.....	84
Signal Format.....	105
Simple 1 to 1 Connection.....	62
Simple wireless LAN setup.....	59
Speaker.....	16
Specifications for ports.....	134
Specifications for the projector.....	125
Standby Energy Saving.....	92
Start menu.....	34
Start-up Screen.....	88
Switching the lamp mode.....	44
Symbols.....	10
Sync.....	105

T

Temperature Error.....	107
Tint.....	83
Top view.....	15
Total CO2 Reduction.....	105
Total Time.....	105
Trademarks.....	139
Troubleshooting.....	107, 110
Turning off the projector.....	44
Turning on the projector.....	34

U

URL rewriting feature.....	67
USB button.....	18, 47, 48
USB memory device.....	46
USB port.....	17
USB Settings.....	95
User Logo.....	88

V

Video In port.....	17
Video Mode.....	105
Virtual directory.....	67

Volume button..... 18, 40

W

Wall Color Correction.....87

Where to inquire.....138

Wired LAN.....55, 96

Wireless LAN.....57, 97

Z

Zoom button..... 18, 37

Free Manuals Download Website

<http://myh66.com>

<http://usermanuals.us>

<http://www.somanuals.com>

<http://www.4manuals.cc>

<http://www.manual-lib.com>

<http://www.404manual.com>

<http://www.luxmanual.com>

<http://aubethermostatmanual.com>

Golf course search by state

<http://golfingnear.com>

Email search by domain

<http://emailbydomain.com>

Auto manuals search

<http://auto.somanuals.com>

TV manuals search

<http://tv.somanuals.com>