

Cat. No. 32-1245
OWNER'S MANUAL

Please read before using this equipment.

8-Channel 170 MHz Portable Wireless PA System

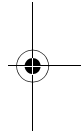
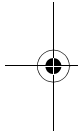

RadioShack®

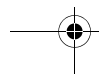
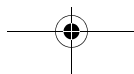

FEATURES

Your RadioShack 8-Channel 170 MHz Portable Wireless PA System is designed for classrooms, meeting rooms, or anywhere you need amplified sound. It can serve as a wireless microphone receiver, a wired microphone amplifier or both. It has a 20 watt audio amplifier and two audio inputs you can control separately. You can power it by AC 120V/60Hz or DC 14.4V/2.5A.

Notes:

- This system requires a 170MHz wireless or wired microphone (neither is supplied) for operation. Your local RadioShack store has a variety of wireless and wired microphones.
- Be sure to select the correct frequency channel for your PA system to match your wireless microphone's operating frequency channel. See "Using a Wireless Microphone" on Page 5.

Your PA System's features include:

170MHz Operation Frequency — to assure accurate sound reproduction.

Volume Controls — let you control the volume of a wireless or wired microphone.

Comander Noise Reduction — greatly reduces the low frequency noises.



Internal Helical Antenna — receives microphone signals up to 150 feet away.

Dual Microphone Use — lets you use wired and 170MHz wireless microphone at the same time.

8-Channel Wireless Selection — lets you select the suitable frequency channel to match your wireless microphone's operating frequency.

Your amplifier is ETL listed to UL standard and meets all applicable FCC standards.

WARNING: To reduce the risk of fire or shock hazard, do not expose this product to rain or moisture.

	CAUTION RISK OF ELECTRIC SHOCK. DO NOT OPEN.	
CAUTION: TO REDUCE THE RISK OF ELECTRIC SHOCK, DO NOT REMOVE COVER OR BACK. NO USER-SERVICEABLE PARTS INSIDE. REFER SERVICING TO QUALIFIED PERSONNEL.		



This symbol is intended to alert you to the presence of uninsulated dangerous voltage within the product's enclosure that might be of sufficient magnitude to constitute a risk of electric shock. Do not open the product's case.



This symbol is intended to inform you that important operating and maintenance instructions are included in the literature accompanying this product.

© 2000 Tandy Corporation.
All Rights Reserved.

RadioShack is a registered trademark used by Tandy Corporation.

FCC NOTICE

This device complies with part 15 of the FCC Rules. Operation is subject to the following two conditions: (1) this device may not cause harmful interference, and (2) this device must accept interference received, including interference that may cause undesired operation.

Product: 8-Channel 170 MHz Portable Wireless PA System
Model: 32-1245
Responsible Party: RadioShack 100 Throckmorton Fort Worth, TX 76102
Phone: 817-415-3200

This equipment has been tested and found to comply with the limits for a Class B digital device, pursuant to Part 15 of the FCC Rules. These limits are designed to provide reasonable protection against harmful interference in a residential installation. This equipment generates, uses and can radiate radio frequency energy and, if not installed and used in accordance with the instructions, may cause harmful interference to radio communications.

However, there is no guarantee that interference will not occur in a particular installation. If this equipment does cause harmful interference to radio or television reception, which can be determined by turning the equipment off and on, the user is encouraged to try to correct the interference by one or more of the following measures:

- Increase the separation between the equipment and the receiver.
- Connect the equipment into an outlet on a circuit different from that to which the receiver is connected.
- Consult your local RadioShack store or an experienced radio/TV technical for help.

Changes or modifications not expressly approved by RadioShack may cause interference and void the user's authority to operate the equipment.



PREPARATION

Using AC Power

You can power the PA system using the supplied AC cord.

Cautions:



The cord's plug must fit the system's **~120V AC 60Hz 60W** jack. The supplied cord meets these specifications. Using a cord that does not meet these specifications could damage the system or the AC cord. You can order a replacement cord through your local RadioShack store.

- Always connect the AC cord to the system before you connect it to AC power. When you finish, disconnect the cord from AC power before you disconnect it from the system.

Set the amplifier to **OFF**. Plug the power cord's plug into the amplifier's **~120V AC 60Hz 60W** jack. Then plug the other end of the cord into a standard AC outlet.

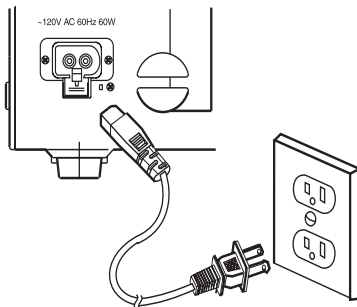

Caution: The supplied power cord has a polarized plug that fits into the outlet only one way. If the plug does not fit properly, turn it over and try again. Do not force it.

Using Vehicle Battery Power

You can power the PA system from a vehicle's 12V power source (such as a cigarette-lighter socket) using the supplied DC cord.

Cautions:



You must use a power source that supplies 12V DC and delivers at least 2500 mA. Its plug must fit the system's **DC 14.4V/2.5A** jack. The supplied adapter meets these specifications. Using a cord that does not meet these specifications could damage the system or the adapter.

- Always connect the cord to the system before you connect it to the power source. When you finish, disconnect the DC cord from the power source before you disconnect it from the system.

Set the amplifier to **OFF**. Plug the DC power cord's barrel plug into the **DC 14.4V/2.5A** jack. Then plug the other end of the cord into a standard DC source such as an automobile 12V accessory outlet.

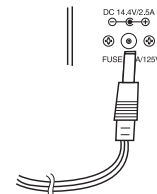

OPERATION

Notes:

- You can use a wireless and wired microphone at the same time.
- Be sure to select the correct frequency channel for your PA system to match your wireless microphone's operating frequency channel.

Using a Wireless Microphone

- Rotate **WIRELESS MIC VOLUME** counterclockwise to the minimum level (the smallest dot on the left side of the knob).
- Select the frequency channel on the PA system to match your microphone's operating frequency channel or channel combination by setting the **DIP** switch located on the back of the PA system.

For example, if your microphone frequency is **A**, use a sturdy pointed-object (like a ball-point pen or finger nail file) to set each switch on the **DIP** to  as indicated by the operation channel combination table located on the back panel. The "■" represents the raised nub on each switch.

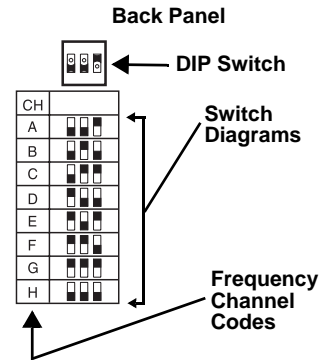

Notes:

- Wireless microphones are sold in three channel combinations: AEH, BDG, and CFH.
 - If you use two receivers in the same room with a separate wireless microphone assigned to each receiver, make sure the channels are not adjacent (follow in alphabetical sequence). For example, if one receiver is set to channel G and the other to H, it will create interference. To remove the interference, set one receiver to H and the other to F.
- Set **ON/OFF** to **ON**. **POWER** lights.

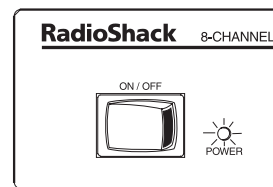

- Set the wireless microphone's **ON/OFF** switch to **ON**. **READY** lights.

5. Rotate **WIRELESS MIC VOLUME** to the desired level. (The larger the dot, the higher the level.)

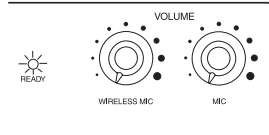

6. When you finish using the PA system, turn **WIRELESS MIC VOLUME** to the minimum position and set **ON/OFF** to **OFF**.

Using a Wired Microphone

1. Connect the wired microphone to the amplifier's **MIC** jack located on the back of the amplifier.

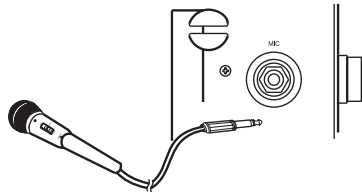

2. Rotate **MIC VOLUME** counter-clockwise to the minimum level (the smallest dot on the left side of the knob).
3. Set **ON/OFF** to **ON**. **POWER** lights.
4. Set the microphone's **ON/OFF** switch to **ON**.
5. Rotate **MIC VOLUME** to the desired level. (The larger the dot, the higher the level.)
6. When you finish using the PA system, rotate **MIC VOLUME** to the minimum position and set **ON/OFF** to **OFF**.

TROUBLESHOOTING

If you have problems operating your amplifier, try these suggestions. If you still have problems, contact your local RadioShack store for assistance.

Problem	Suggestion
No power	Make sure the AC or DC cord is properly connected.
	Make sure the power is turned on.
	Check the fuses and replace them if needed.
No sound (wireless microphone)	Make sure your transmitter and amplifier are operating on the same frequency.
	Adjust the wireless microphone volume control.
	Make sure the microphone transmitter is working and you are within 150 feet of the system.
No sound (wired microphone)	Make sure your wired microphone is properly connected and the microphone is not defective.
	Adjust the wired microphone volume control.

CARE AND MAINTENANCE

To enjoy your PA system for a long time:

- Keep the system dry. If it gets it wet, wipe it dry immediately.
- Use and store the system only in normal temperature environments.
- Handle the system gently and carefully. Don't drop it.
- Keep the system away from dust and dirt.
- Wipe the system with a damp cloth occasionally to keep it look new.

Modifying or tampering with the amplifier's internal components can cause a malfunction and invalidate its warranty and void your FCC authorization to operate it. If your amplifier is not performing as it should, take it to your local RadioShack store for assistance.

REPLACING THE FUSE

If the PA system stops operating properly, you might need to replace the fuse in the back of the system or the in-line fuse in the DC cord.

Important: Turn off the PA system and let it cool. Then try operating it again before you replace the fuse.

Caution: Do not use a fuse with ratings other than those specified. Doing so might damage your amplifier.

In the Back of the PA System

1. Set **ON/OFF** to **OFF** and unplug it.
2. Insert a flat-blade screwdriver into the fuse holder's cap located on the back of the amplifier, gently press in the cap, and rotate it counterclockwise until the fuse cap unlocks.
3. Remove the fuse holder's cap then pull out the fuse.
4. If the fuse is blown (the inside wire is broken), remove it and replace it with a 1.5A/125V fuse.
5. Insert the fuse holder's cap back into the socket on the back of the amplifier.
6. Carefully tighten the fuse holder's cap by pushing it in and rotating it clockwise until it locks.

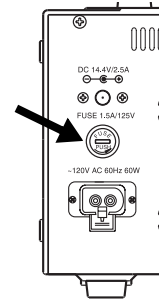

In the DC Cord

1. Unplug the DC cord from the cigarette-lighter socket and then the PA system.
2. Turn the cap counter clockwise to open the plug, then remove the fuse taking care not to lose the tip.
3. Replace the fuse with a new fuse of the same rating (3A/125V) and type.
4. Replace the cap and turn it clockwise to secure it closed.

SPECIFICATIONS

Channels	8
Wireless Microphone Channel Frequencies:	
A	169.445MHz
B	169.505MHz
C	170.245MHz
D	170.305MHz
E	171.045MHz
F	171.105MHz
G	171.845MHz
H	171.905MHz
AC Power	120V/60Hz
DC Power Jack	14.4V/2.5A
Receiver Fuse	1.5A/125V
DC Cord Fuse	3A/125V
Audio Output @10% THD	13W (nominal)
Distortion of Wired Microphone at Maximum Output	3%
Sensitivity of Wired Microphone	5mV
Wired Microphone S/N Ratio	50dB
Frequency Response of Wireless Microphone ...	300-3000Hz 0dB
HUM Noise at Wireless Microphone	5mV (nominal)
Sound Level (10 feet away)	85dB SPL

Specifications are typical: individual units might vary. Specifications are subject to change without notice.

Limited One-Year Warranty

This product is warranted by RadioShack against manufacturing defects in material and workmanship under normal use for one (1) year from the date of purchase from RadioShack company-owned stores and authorized RadioShack franchisees and dealers. EXCEPT AS PROVIDED HEREIN, RadioShack MAKES NO EXPRESS WARRANTIES AND ANY IMPLIED WARRANTIES, INCLUDING THOSE OF MERCHANTABILITY AND FITNESS FOR A PARTICULAR PURPOSE, ARE LIMITED IN DURATION TO THE DURATION OF THE WRITTEN LIMITED WARRANTIES CONTAINED HEREIN. EXCEPT AS PROVIDED HEREIN, RadioShack SHALL HAVE NO LIABILITY OR RESPONSIBILITY TO CUSTOMER OR ANY OTHER PERSON OR ENTITY WITH RESPECT TO ANY LIABILITY, LOSS OR DAMAGE CAUSED DIRECTLY OR INDIRECTLY BY USE OR PERFORMANCE OF THE PRODUCT OR ARISING OUT OF ANY BREACH OF THIS WARRANTY, INCLUDING, BUT NOT LIMITED TO, ANY DAMAGES RESULTING FROM INCONVENIENCE, LOSS OF TIME, DATA, PROPERTY, REVENUE, OR PROFIT OR ANY INDIRECT, SPECIAL, INCIDENTAL, OR CONSEQUENTIAL DAMAGES, EVEN IF RadioShack HAS BEEN ADVISED OF THE POSSIBILITY OF SUCH DAMAGES.

Some states do not allow limitations on how long an implied warranty lasts or the exclusion or limitation of incidental or consequential damages, so the above limitations or exclusions may not apply to you.

In the event of a product defect during the warranty period, take the product and the RadioShack sales receipt as proof of purchase date to any RadioShack store. RadioShack will, at its option, unless otherwise provided by law: (a) correct the defect by product repair without charge for parts and labor; (b) replace the product with one of the same or similar design; or (c) refund the purchase price. All replaced parts and products, and products on which a refund is made, become the property of RadioShack. New or reconditioned parts and products may be used in the performance of warranty service. Repaired or replaced parts and products are warranted for the remainder of the original warranty period. You will be charged for repair or replacement of the product made after the expiration of the warranty period.

This warranty does not cover: (a) damage or failure caused by or attributable to acts of God, abuse, accident, misuse, improper or abnormal usage, failure to follow instructions, improper installation or maintenance, alteration, lightning or other incidence of excess voltage or current; (b) any repairs other than those provided by a RadioShack Authorized Service Facility; (c) consumables such as fuses or batteries; (d) cosmetic damage; (e) transportation, shipping or insurance costs; or (f) costs of product removal, installation, set-up service adjustment or reinstallation.

This warranty gives you specific legal rights, and you may also have other rights which vary from state to state.

RadioShack Customer Relations, 200 Taylor Street, 6th Floor, Fort Worth, TX 76102

We Service What We Sell 12/99

03A00

811082350A
Printed in China

Free Manuals Download Website

<http://myh66.com>

<http://usermanuals.us>

<http://www.somanuals.com>

<http://www.4manuals.cc>

<http://www.manual-lib.com>

<http://www.404manual.com>

<http://www.luxmanual.com>

<http://aubethermostatmanual.com>

Golf course search by state

<http://golfingnear.com>

Email search by domain

<http://emailbydomain.com>

Auto manuals search

<http://auto.somanuals.com>

TV manuals search

<http://tv.somanuals.com>