



R I M A G E™

Desktop User Guide

Includes Liberty Printer

110716-000 Revision H



Use this manual to help you:

- *Identify autoloader and printer parts*
- *Configure the Liberty printer driver*

Desktop 1500 Autoloader – Model RAS12

Desktop 4500 Autoloader – Model RAS13

Notice for USA



Tested to Comply with FCC Standards FOR HOME OR OFFICE USE.
This device complies with part 15 of the FCC Rules. Operation is subject to the following two conditions: (1) This device may not cause harmful interference, and (2) this device must accept any interference received, including interference that may cause undesired operation. Any unauthorized modification to this equipment may result in the revocation by the FCC of the user's authority to operate this equipment. This product complies with UL 60950 3rd Edition.

Notice for Canada

This Class B digital apparatus complies with Canadian ICES-003. Cet appareil numérique de la classe B est conforme a la norme NMB-003 du Canada.
This product complies with CAN/CSA-C22.2 No. 60950-00 3rd Edition.

Notice for Europe



This product is in conformity with the EMC Directive (89/336/EEC) and the Low-Voltage Directive (73/23/EEC) through compliance with the following European standards: EN 55022: 1998 + Amd. 1: 2000 Class B Limit; EN 55024; EN 60950. The CE mark has been affixed in accordance with the CE Marking Directive 93/68/EEC.

Liberty Printer – Model CDPR3

Notice for USA



Tested to Comply with FCC Standards FOR HOME OR OFFICE USE.
This device complies with part 15 of the FCC Rules. Operation is subject to the following two conditions: (1) This device may not cause harmful interference, and (2) this device must accept any interference received, including interference that may cause undesired operation. Any unauthorized modification to this equipment may result in the revocation by the FCC of the user's authority to operate this equipment. This product contains a radio transmitter FCC ID: QT5-RFID1.
This product complies with UL 60950 3rd Edition.

Notice for Canada

This Class B digital apparatus complies with Canadian ICES-003. Cet appareil numérique de la classe B est conforme a la norme NMB-003 du Canada.

This product contains a radio transmitter IC: 4496A-RFID1 in conformance with RSS-210: Issue 5: 2001. *The term "IC" before the radio certification number only signifies that Industry Canada Technical specifications were met.*
This product complies with CAN/CSA-C22.2 No. 60950-00 3rd Edition.

Notice for Europe



This product is in conformity with the EMC Directive (89/336/EEC) and the Low-Voltage Directive (73/23/EEC) through compliance with the following European standards: EN 55022: 1998 + Amd. 1: 2000 Class B Limit; EN 55024; EN 60950. The CE mark has been affixed in accordance with the CE Marking Directive 93/68/EEC.



This product contains a radio transmitter (RFID1) in conformity with the following R&TTE directive 1995/5/EC through compliance with the following European standards: EN 300 330-2 v1.1.1: 2001; EN 301 489-3: 2002 Class B Limit.



R I M A G E

[Rimage Corporation](#)

7725 Washington Avenue South
Minneapolis, MN 55439

FAX: (952) 946-6956
Service: (952) 946-0004 (Asia/Pacific · Mexico/Latin America)
(800) 553-8312 (North America)
email: support@rimage.com
Rimage Technical Website:
<http://www.rimage.com/technical/>

Rimage Europe GmbH
Hans-Böckler-Straße 7
63128 Dietzenbach, Germany
Tel: +49-(0) 6074-8521-0
FAX: +49-(0) 6074-8521-21

Record of Revisions—PN 110716-000

Revision	Date	Description
H	1/27/04	Minor changes are in green text if the manual is viewed on the computer monitor.

Copyright© 2004 Rimage Corporation
Rimage™ is a trademark of the Rimage Corporation.
Perfect Image® is a registered trademark of the Rimage Corporation.
Dell® is registered trademark of Dell Computer Corporation.
Firewire® is a registered trademark of Apple Computer, Inc.
All other trademarks and registered trademarks are the property of their respective owners.

Document Disclaimer

Rimage Corporation reserves the rights to make improvements to the equipment and software described in this document at any time without any prior notice. Rimage Corporation reserves the right to revise this publication and to make changes from time to time in the content hereof without obligation of Rimage Corporation to notify any person or organization of such revisions or changes.

This document may contain links to web sites that were current at the time of publication, but may have moved or become inactive since. This document may contain links to sites on the Internet, which are owned and operated by third parties. Rimage Corporation is not responsible for the content of any such third-party site.

LIMITED 1-Year Warranty

Rimage warrants, to the original end user only, that all non-consumable parts of the Rimage Desktop autoloader products will be free from defects in material and workmanship for 12 months, according to the following terms:

- Rimage will replace or repair, at Rimage's discretion, any non-consumable parts found defective within the Warranty period.
- Valid from the date Rimage ships the product to you.
- Factory depot repair to Rimage Minnesota or Rimage Germany with a typical response of 15 business days (25 business days for International). On-site repair, Advanced Replacement, or faster response Maintenance Contracts are available for an additional fee.
- Rimage will pay ground service freight charges for components shipped to you.

The use of non-Rimage ink cartridges or refilling of ink cartridges voids the equipment warranty or maintenance coverage. Any applicable ink cartridge warranty shall not apply to Rimage ink cartridges that have been refilled, remanufactured, refurbished, misused, or tampered with in any way.

This Warranty Does Not include the following:

- Work done at the customer's location, or customer's loss of data.
- Shipment costs of equipment or components returned to the Rimage factory.
- Software and/or firmware enhancements released after purchase of the product.
- Equipment or parts that were tampered with, misused, neglected, or that were modified in any respect without the written consent of Rimage.
- Equipment or parts that have been damaged due to shipping or accidents, or damaged by lightning, storms, water, or power surges.
- Printer consumables including ink cartridges or print head.

You may not assign this Warranty without Rimage's written consent. Rimage is the intended beneficiary of this Warranty; if there is any inconsistency between this Warranty and any other agreement included with or relating to Rimage products, this Warranty shall govern. If any term of this Warranty is illegal or unenforceable, the legality and enforceability of the remaining provisions are not affected or impaired. This Warranty is to be interpreted under the laws of the State of Minnesota, without giving effect to conflict of law rules.

Rimage must receive written notice of any claimed defect or failure to perform within five (5) days after such failure or defect is first observed. For warranty service, call Rimage at (952) 946-0004. For Europe, call +49-(0) 6074-8521-0.

The Limited Warranty set forth above is Rimage's only Warranty in connection with the Desktop family of products. All other Warranties, whether written or oral, express or implied, contractual or statutory, including, but not limited to any Warranties of merchantability or fitness for any particular purpose are specifically excluded and disclaimed. In no event shall Rimage's liability under this Warranty exceed the obligation to repair or replace, at Rimage's discretion, a Warranted product, and, without limiting the foregoing, Rimage's liability under this Warranty shall not exceed the cost of the covered product.

To check order shipment information, return goods data, shipping details, or tracking specifics on the Rimage web site go to www.rimage.com and select **Order Status**.

Table of Contents

CD and DVD Recording Software Disclaimer	vi
Safety Precautions	vi
Chapter 1 – Overview and Contents	7
Overview.....	7
Box Contents	7
Chapter 2 – User Guide	8
Desktop Autoloader Parts	8
Front View	8
Desktop Operator Panel.....	8
Desktop Operator Button.....	9
Desktop 4500 Bin Configuration	9
Liberty Operator Panel	10
Ink Cartridge Status.....	11
Align Ink Cartridges	11
Label Design Requirements	15
Media Requirements.....	15
Change Printer Driver Settings	16
Advanced Tab.....	19
Printing.....	20
Settings	20
Maintenance	21
Center Image	22
Diagnostics.....	25
Update Autoloader Flash	25
Clean Cartridges	26
Tray Controller	27
Tray Controller Help.....	27
Find Additional Information	29
Online Help	29
Technical Support and Product Updates.....	29

CD and DVD Recording Software Disclaimer

This Product, Software, or Documentation may be designed to assist you in reproducing material in which you own the copyright or have obtained permission to copy from the copyright owner. Unless you own the copyright or have permission to copy from the copyright owner, you may be violating copyright law and be subject to payment of damages and other remedies. If you are uncertain about your rights, you should contact your legal advisor. If you are neither in possession of the copyright nor have authorization from the owner of the copyright, unauthorized copying of CDs violates national and international legislation and can result in severe penalties.

Safety Precautions

This manual and the indications on the product allow proper and safe operation. The indication marks below help protect you and other persons from injury, and equipment from damage. To ensure safety, please read the precautions in the online User Guide manual and familiarize yourself with their meaning before using the equipment.



Warning! Ignoring this symbol and performing wrong operation may cause death or severe injury.



Caution Ignoring this symbol and performing wrong operation may cause bodily harm or equipment damage.

WARNING:



The laser beam used by this CD Recorder is a Class 1 laser and may be harmful to the eyes. Do not attempt to open the recorder. An authorized field technician should perform all service procedures.

CAUTION:



For continued protection against risk of fire, replace the fuse only with same type and rating. An authorized field technician should perform all service procedures.

WARNING:



Ink may be harmful if swallowed. Avoid contact with eyes. Ink contains nitrites. If ingested, seek immediate medical attention. Keep out of reach of children.

Chapter 1 – Overview and Contents

Overview

This manual provides the information needed to identify the parts of the autoloader, and configure the Liberty printer driver. The Desktop autoloader consists of recorders, a printer, and an autoloader for transferring discs. **The Desktop autoloader and Rimage OfficeNet Software runs only on Windows 2000 Professional, and Windows XP (Professional and Home editions).**

For a basic overview of the Desktop autoloader parts, go to page 8.

Box Contents

After all the boxes are opened and the components are removed, you can use the check boxes to check off the included components.

Desktop Autoloader:

- Desktop Autoloader
- AC Power Cord
- USB Cable
- OfficeNet Software Suite disc
- Desktop User Guide
- Autoloader Control Cable
- Firewire Cable
- IEEE 1394 (Firewire) Host Adapter Card
- Software Activation Card
- Desktop QuickStart Directions
- Software Suite 6 Getting Started Guide

Printer:

- Liberty Printer
- Color Ink Cartridge
- Black Ink Cartridge

Computer: (Only if ordered with the Desktop Autoloader)

These parts are included only if a Rimage Control Center (computer) was ordered with the autoloader.

- Computer
- Monitor
- Keyboard
- Mouse and mouse pad
- Two AC Power Cords

Inspect the shipping boxes before installing the hardware. Contact your reseller or Rimage Corporation if items are missing or damaged.

Chapter 2 – User Guide

Desktop Autoloader Parts

This section describes the Desktop hardware and its features. The Desktop autoloaders have several major functional parts as shown below:

Front View

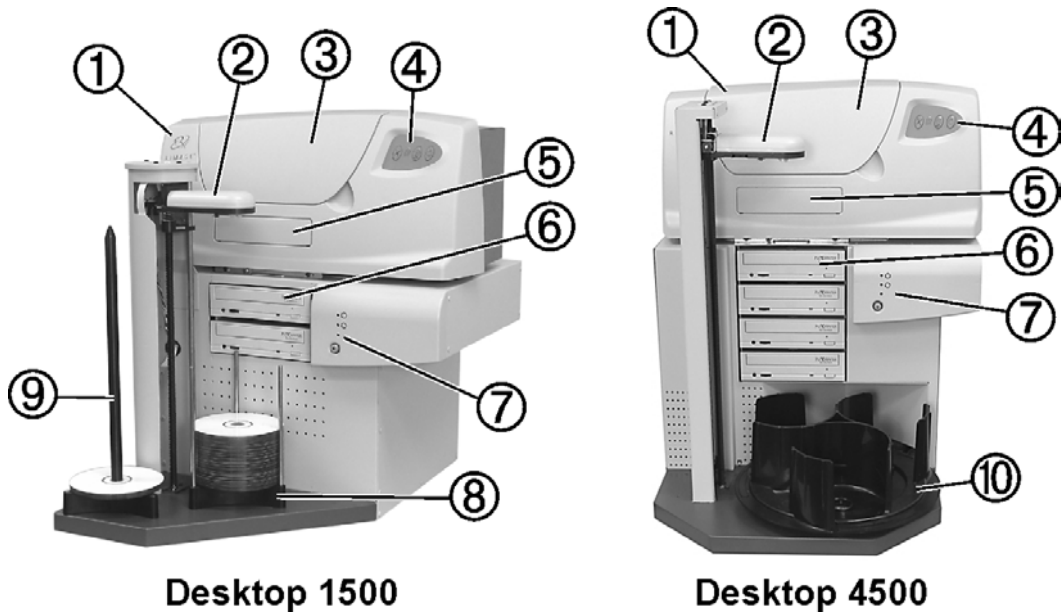

1 – Liberty Printer	5 – Printer Tray Door	9 – Output Spindle
2 – Picker	6 – Recorder	10 – Carousel
3 – Printer Top Cover	7 – Operator Panel	
4 – Printer Control Panel	8 – Supply Hopper	

Desktop Operator Panel

The Desktop autoloader has an operator panel located on the right side of the autoloader. The following status lights (LEDs) provide you with operational information.

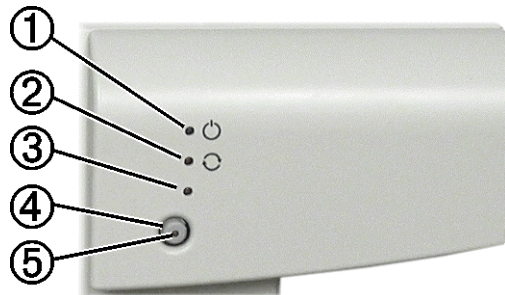

1 – Power LED	3 – Mode LED	5 – Button LED
2 – Active LED	4 – Operator Button	

Power LED

The green power LED lights when the power switch is on.

Active LED

The yellow active LED lights when there is communication through the control port.

Mode LED

The mode LED lights when the button diagnostic function is selected.

Button LED

The yellow button LED, located in the operator button, is lit when the autoloader is paused. It may also be lit during the button diagnostics. Directions for the Desktop Button Diagnostics may be downloaded from the service procedures on the Rimage Technical Web site.

Desktop Operator Button

The operator button can be used to pause the Desktop autoloader from processing discs. Pausing the autoloader is used so the operator can add and remove discs from output spindle, or change ink cartridges. To pause the Desktop autoloader, press the operator button when a disc is not in the printer, or being placed in the printer. To return to normal operation mode, press the operator button again. When the button LED is on and the mode LED is off, the autoloader is in the paused mode.

Desktop 4500 Bin Configuration

Bins 1 and 2 are configured as the default supply and output bins. The Desktop 4500 starts picking unrecorded discs from bin 2 and places the completed and failed discs into bin 3. When Bin 2 is empty, it picks discs from bin 1 and places them into bin 2. When removing the completed discs, the reject discs should be removed from the completed discs. The rejects should have a reject label printed on the disc unless that function was disabled in the Production Server options. Refer to the Reject Pattern Printing options located in the Printing Parameters of the Production Server.

Another option is to configure the bins so there is one input bin, one output bin and one reject bin. Refer to the Production Server online help file for directions.

Liberty Operator Panel

The Liberty printer operator panel has three buttons and four LEDs to indicate certain conditions.

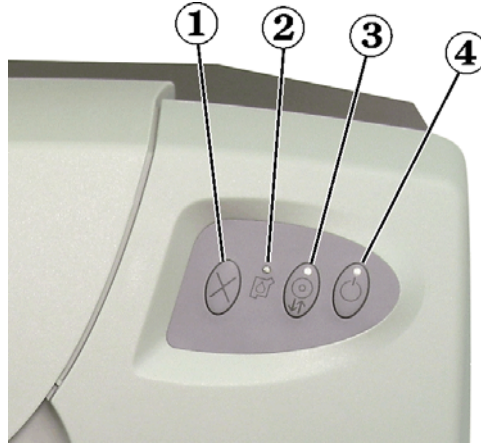

1 – Cancel Button	3 – Disc Button and LED
2 – Ink Cartridge Status LED	4 – Power Button and LED



Cancel Button: Not used.



Ink Cartridge Status LED: Flashes when an ink cartridge is low on ink, incorrectly installed, or when the printer cover is open. To check the ink cartridge status, refer to “[Ink Cartridge Status](#)” on page 11.



Disc Button and LED: The Disc button is used to move the tray in and out, and to load a disc for manual printing used in checking alignments. The Disc LED illuminates when a disc is on the tray.



Power Button and LED: The Power button is unused. **The green Power LED is only on when the [Tray Controller](#) is running and there is power to the printer. See [Tray Controller](#) on page 27.** The Power LED flashes when the printer is printing or in an error state. Error conditions can be viewed at the Production Server, or in the status field located inside the printer driver under the advanced tab.

Ink Cartridge Status

When the top cover is open, the ink cartridge cradle moves so that its arrow ⑥ points to one of the ink cartridge status indicators, indicating the cartridge status as shown below.

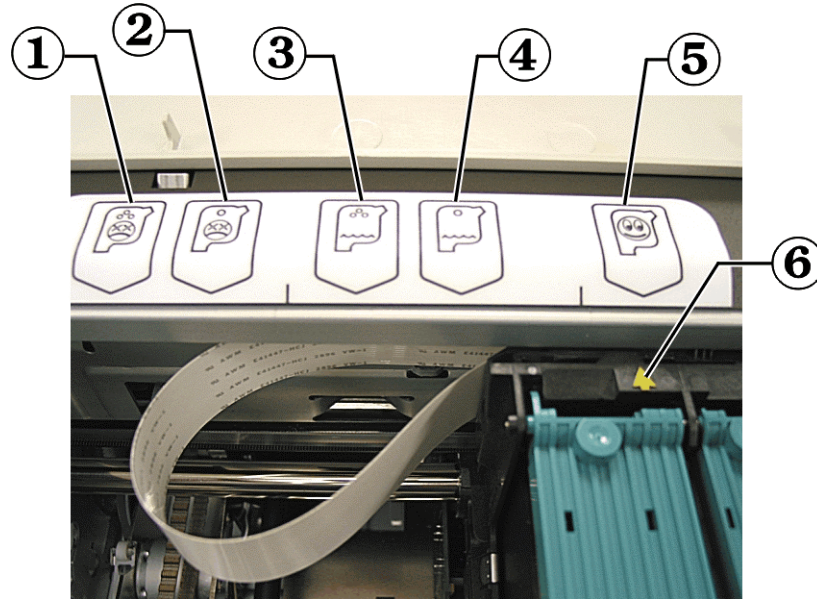

1 – Color Ink Cartridge Trouble	4 – Black Ink Cartridge Low
2 – Black Ink Cartridge Trouble	5 – Ink Cartridges Normal
3 – Color Ink Cartridge Low	6 – Status Indicator Arrow

In the figure above, the Status Indicator Arrow ⑥ is pointing to the Normal ⑤ status indicator. Refer to the “[Advanced Tab](#)” section on page 19 of this manual for additional problem solving information.

Warning

- Ink may be harmful if swallowed.
- Avoid contact with eyes.
- Ink contains nitrites. If ingested, seek immediate medical attention.
- Keep out of reach of children.
- Refilling ink cartridges may result in damage to the cartridge or printer.
- Rimage ink cartridges are not licensed for modification.



Note: You can only use authentic Rimage ink cartridges in the Liberty printer.

Align Ink Cartridges

For optimal print quality, align the ink cartridges using the steps below.

1. **Windows 2000** – Select the Windows **Start** button and select **Settings|Printers**.
2. **Windows XP** – Select the Windows **Start** button and select **Printers and Faxes**.
3. Right-click on the **Disc Color Printer** and select **Printing Preferences** from the drop-down menu.

4. Select the **Advanced** tab.
5. Select the **Align Cartridges** button.

If the buttons are grayed out, the tray controller must be started. For Windows 2000, select Windows' **Start | Programs | Rimage | Utilities | Disc Color Tray Controller** to start the Rimage Tray Controller.

For Windows XP, select Windows' **Start | All Programs | Rimage | Utilities | Disc Color Tray Controller** to start the Rimage Tray Controller.

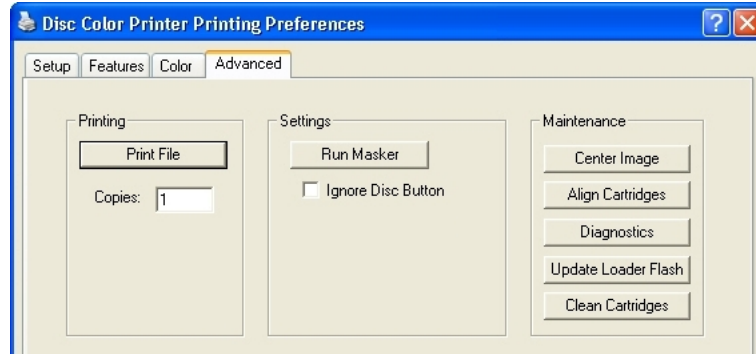

The **Align Cartridges** dialog displays.

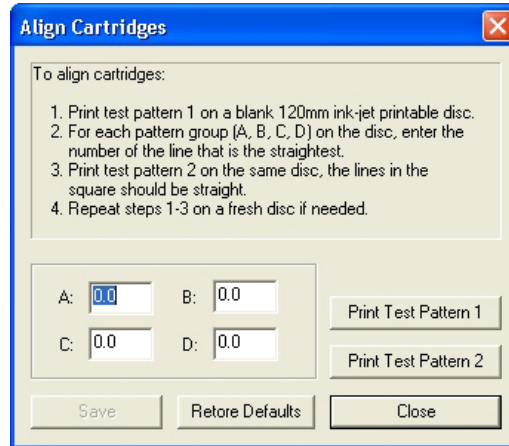

6. Select the **Print Test Pattern 1** button and the printer tray comes out.
7. Place an inkjet printable disc on the printer tray.

- When prompted, press the Disc button on the printer to close the tray and start the printing test.

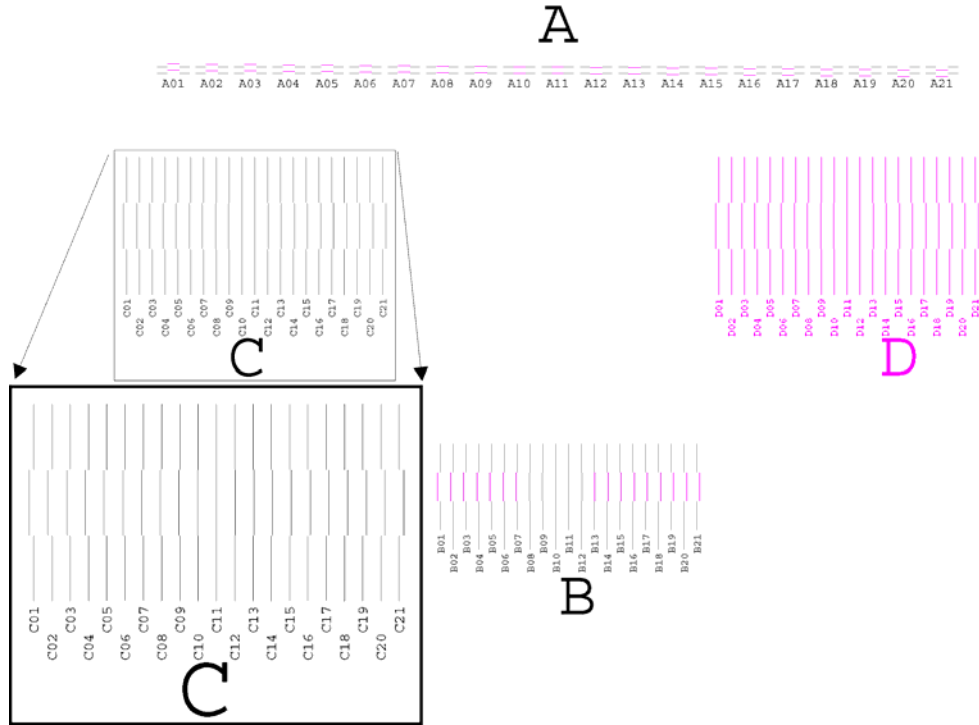

- There are four pattern groups (A, B, C, D) printed on the disc. Each group has a numbered index, shown as a set of numbers from 1 to 21. Locate the two lines that make the straightest line and enter the matching index value for each lettered group. You may enter decimal values if the lines are not exactly aligned.

In the above example, looking at group A, the straightest lines are at A11. Enter 11 in the group A field. In group C, the straightest lines are at C11. Enter the remaining groups and select **Save**.

- Place a disc on the printer tray and select the **Print Test Pattern 2** button.

11. When prompted, press the Disc button to print the following test pattern on a disc.

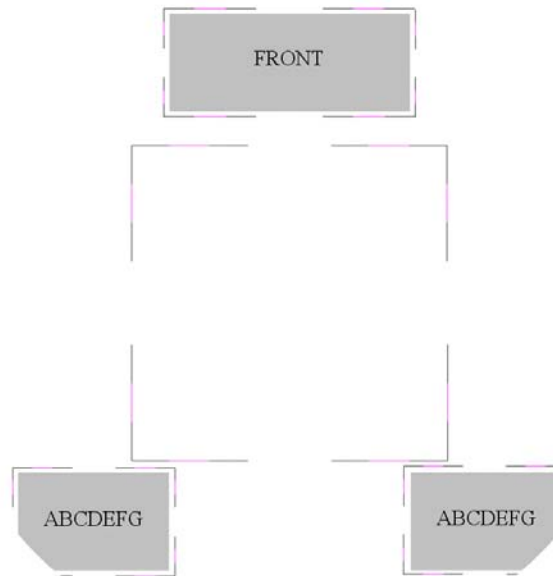

12. The black and magenta lines should be straight as shown above. If they are not inline with each other, repeat the alignment process starting at step 5.
13. Close the Align Cartridges window.
14. Close the Printing Preference window.
15. Press the Disc button to close the printer tray. If the printer tray does not close, close the tray controller application and open it again. Wait for the tray controller to initialize, about 60 seconds, and press the Disc button to close the tray.

Label Design Requirements

This section provides some things you need to consider before you create a label. Your first consideration is the media you will use. Select media that has an ink printable surface.

The OfficeNet software comes with a label editor called “CD Designer” which is installed on your system. Use CD Designer to design your labels.

If you have another software application that you prefer, you can create the label image and output it as an Acrobat (.pdf) file, or you can output a Windows bitmap (.bmp) file. The Acrobat file can print directly to the Liberty through the Rimage software. If you output a Windows bitmap file, insert it into CD Designer to create a label that prints with the Rimage software. To create a label with another program, use the following criteria when creating a label:

Color Depth: Save the artwork for the label with the color set to at least 256 colors; a higher color setting is recommended.

DPI: Use pictures or logos set to 300 DPI (Dots Per Inch).

Label Design Size: A full size disc is 120mm (4.723”) with a hub size that is 38mm (1.5”). The actual printable area is around 118mm (4.65”). The printable area and hub sizes vary depending on the disc manufacturer. The hole is 15mm (0.59”).

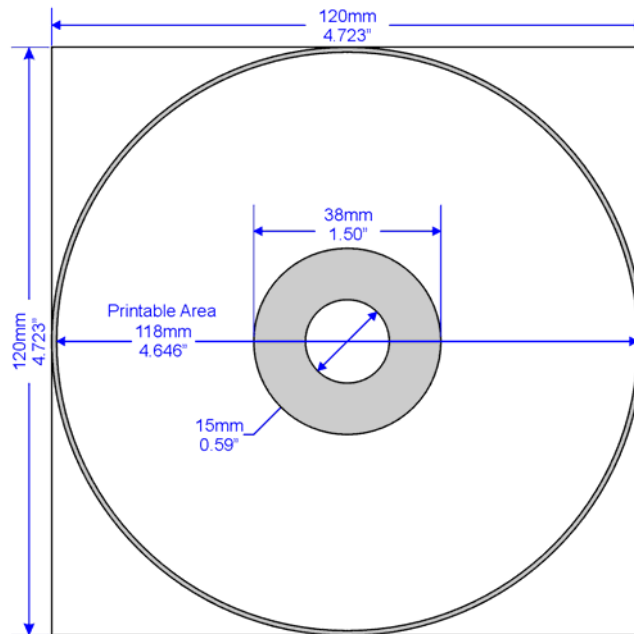

Page has no margins.

You can mask the outer non-printable area and print, or not print in the hub area. Set these options in the [Run Masker](#) section of the printer driver. Refer to page [21](#).

Media Requirements

Discs must be coated with a surface designed for ink-jet printing.

Change Printer Driver Settings

You can change the printer driver properties to select print quality, print orientation, ink volume, or other image adjustments.

1. On the **Start** menu, point to **Settings**, and then click **Printers**.
2. Right-click the printer you want to change on the shortcut menu, and then left-click **Printing Preferences**. The **Liberty Disc Color Printer Printing Preferences** dialog box opens.

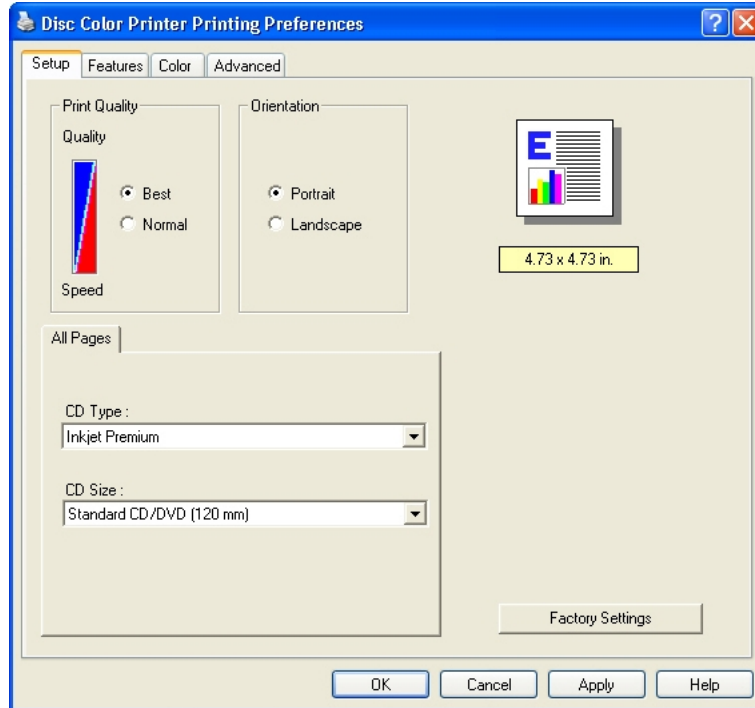

3. At the **Setup** tab, select the **Print Quality (Best or Normal)** and select the **Orientation (Portrait or Landscape)**.

Best quality produces the highest print quality and can eliminate the 'banding' effect that sometimes occurs in solid print areas. However, **Best** quality prints slower than **Normal** quality for most applications.

Normal quality delivers high-quality output at a faster print rate.

Portrait orientation prints the label vertically so the top of the label comes out of the printer first. **Landscape** orientation prints the label horizontally so the top of the label is located on the side of the printer tray.

Select the **CD Type (Inkjet Premium, Photo, or Plain)** and **CD Size (Standard CD/DVD (120 mm))**. **Photo** prints the highest quality and **Inkjet Premium** is the next step lower, but provides a faster print while maintaining a high quality print. The **Plain** setting provides the fastest print.

The **Photo** and **Inkjet Premium** settings eliminate banding issues. You may select **Factory Settings** to return all settings to their factory default settings.

4. Select the **Features** tab.

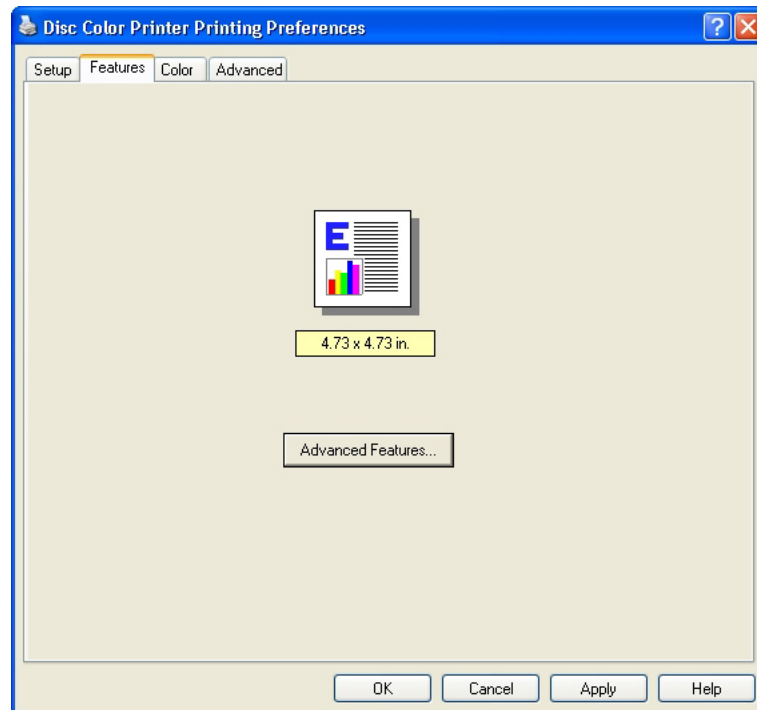

5. Select **Advanced Features** to open the **Advanced Features** dialog.

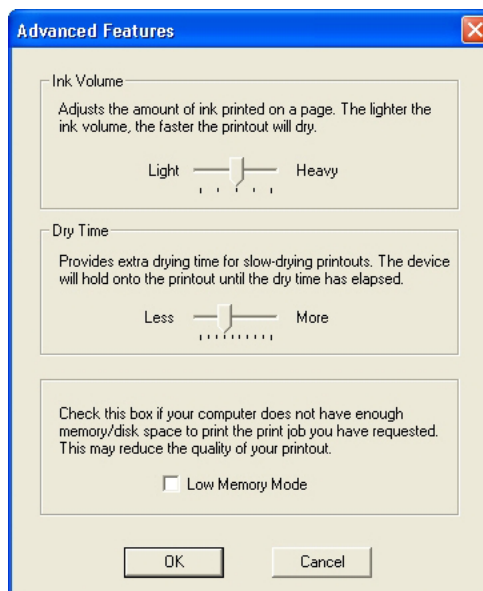

6. Adjust the **Ink Volume** if desired. Drag the slider to the left for lighter images (less ink) or to the right for denser images (more ink). Select **OK** when done.

The **Dry Time** and **Low Memory Mode** selections are not used.

- Adjust the **Color** tab settings (**Print in Grayscale**, **Saturation**, **Brightness**, and **Color Tone**) as needed.

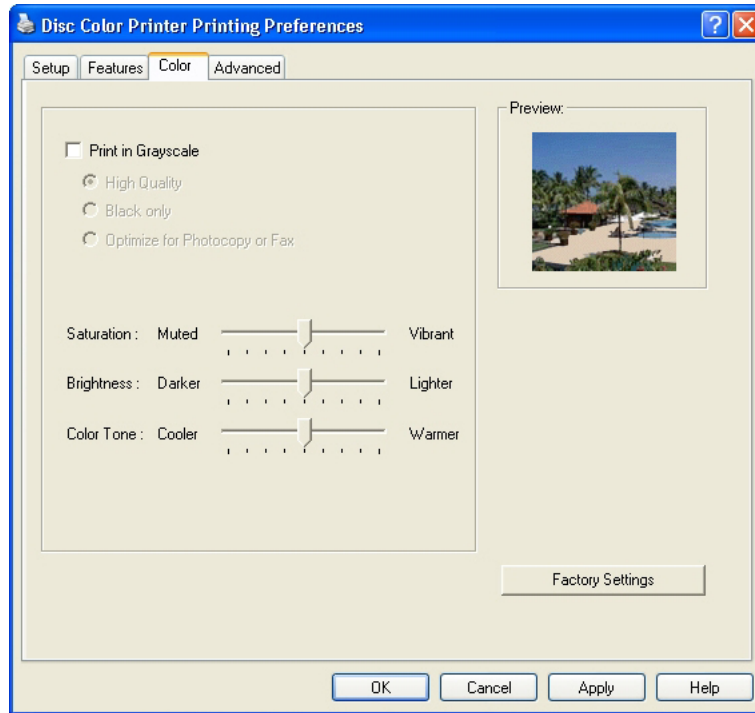

- **Print in Grayscale** print colors as various shades of gray.
 - **High Quality** uses the tri-color ink cartridge to print high quality grayscale images.
 - **Black Only** uses the black ink cartridge to print in grayscale.
 - **Optimize for Photocopy or Fax** is not used.
- **Saturation** adjusts the relative intensity of printed colors from **Muted** to **Vibrant**.
- **Brightness** adjusts the lightness or darkness of the printed image.
- **Color Tone** adjusts the perceived warmth or coolness of printed colors.
- **Factory Settings** returns the Color tab parameter changes to the factory set defaults.

Select **OK** to accept all the changes, or select **Cancel** to ignore the changes.



Note: The **Help** function does not apply to this printer.

Advanced Tab

The Advanced tab provides access to diagnostic functions, alignments, and a flash update function. The Advanced tab also displays Liberty status information, including Driver, Printer, TCH, Loader, and Status information.

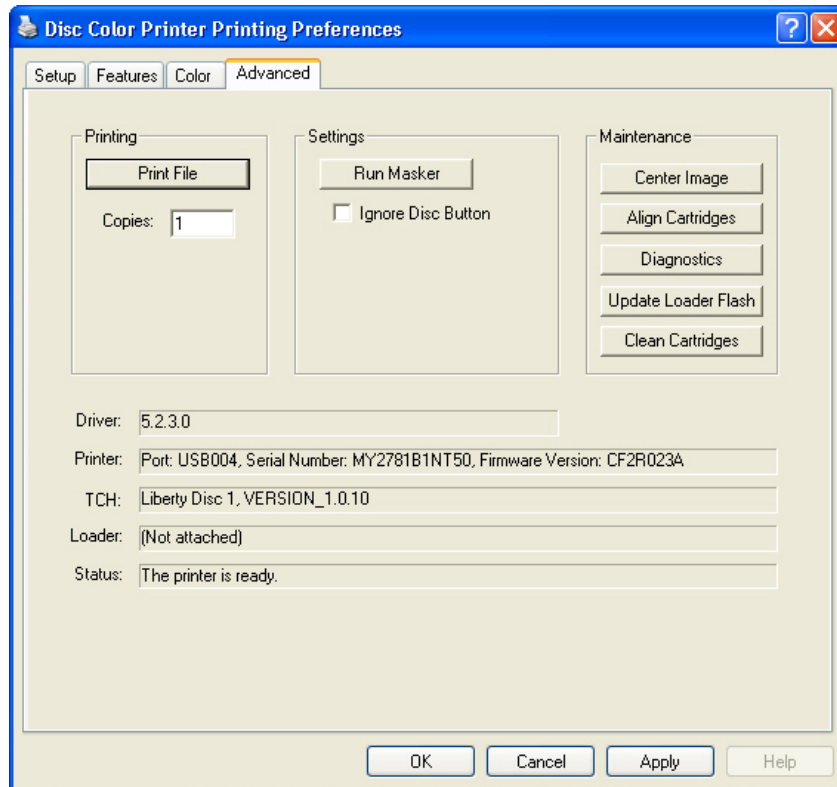

Driver - displays the installed Liberty Printer Driver version number.

Printer - displays the port number, serial number, and firmware version of the printer.

TCH (Tray Controller Handler) - displays the Handler name and version number.

Loader - displays the Rimage Desktop autoloader it is physically attached to and the version and serial number of the autoloader. If the Liberty printer displays (Not Attached), the autoloader control cable may not be connected.

Status - displays the current Liberty printer operating status.

Printing

The Printing section allows you to run a test print without running the complete system. A print file (.prn) must be created prior to running this operation.

1. At the **Printing Preferences** dialog, click the **Advanced** tab to open the following dialog.

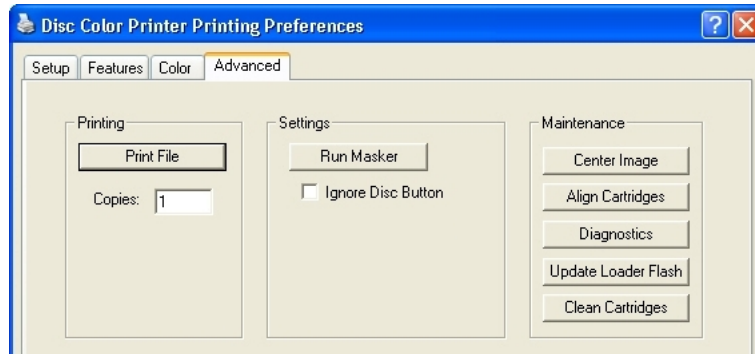

2. Select the **Print File** button and select a pre-rendered file to print for print testing purposes. The file you select must have been prepared for the Liberty printer. The label file will be printed as many times as set in the **Copies** box.

Settings

The Settings selection lets you select whether to ignore the Disc Button or run the Masker application.

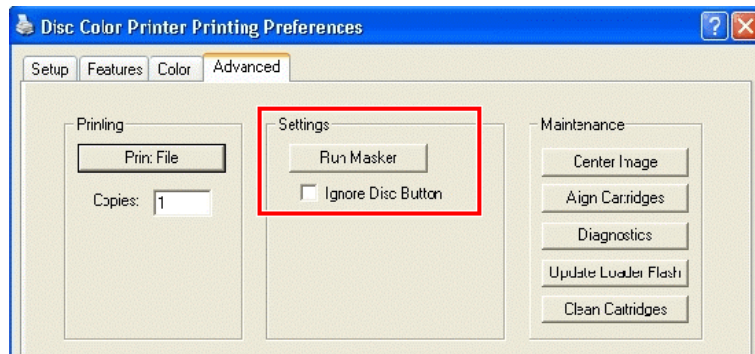

Ignore Disc Button

If selected, causes the printer not to wait for the activation of the disc button before printing. This option is ignored when connected to a Desktop autoloader.

Run Masker

When selected, the Rimage Raster Masker displays allowing you to adjust the mask (non-printable area) settings for the selected media type (**Standard CD/DVD 120 mm** only). This works well when printing rectangle or square pictures on the disc and you do not want the edges printed. If you print on the edges of a disc where there is not printable surface, the ink will smear or run.

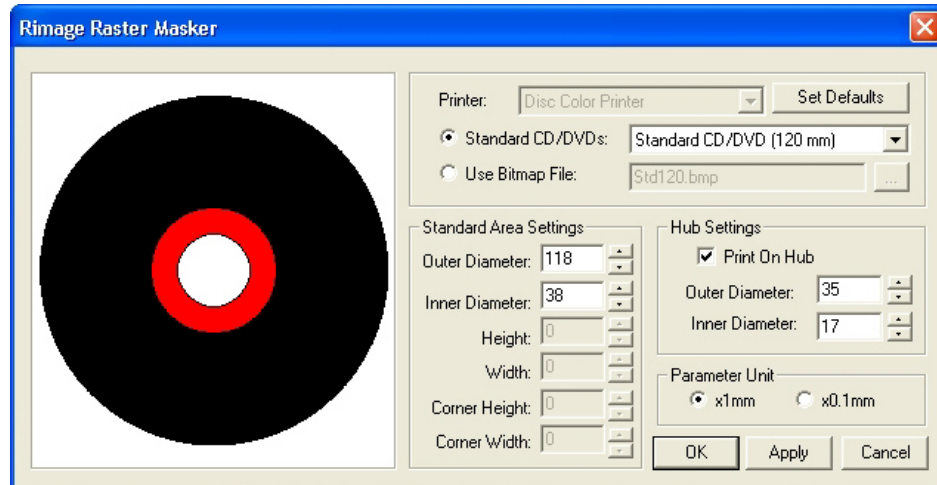

Standard Area Settings let you adjust the standard outer and inner diameter settings, etc.

Hub Settings let you select the **Print On Hub** feature and adjust the related outer and inner diameter settings.

Parameter Unit lets you switch between a unit of measure of times 1.0 mm or times 0.1 mm.

Maintenance

The maintenance section allows you to select alignment functions, diagnostics, or update the flash.

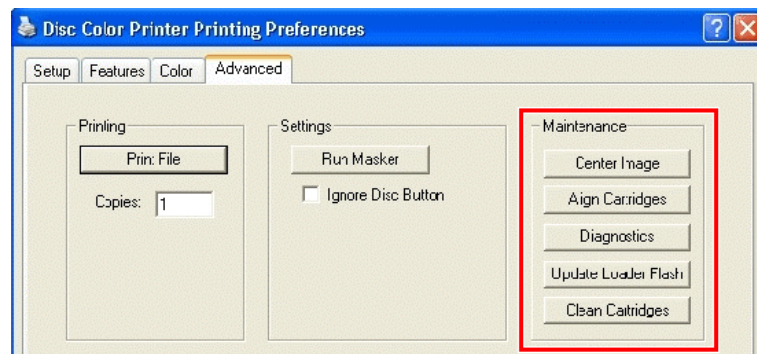

Center Image – The Center Image function is only required if the printed image is not centered on the label. Directions are found on the next page.

Align Cartridges – directions are found on page 11.

Diagnostics – directions are found on page 25.

Update Loader Flash – Rimage recommends using the Production Server to update the autoloader flash firmware. Refer to page 25.

Clean Cartridges – Cleans the ink jet nozzles when the jets are dried out. Refer to page 26.

Center Image

This function is used only when the printed image is not centered on the disc.

1. Stop all orders from processing. You can press the operator button on the Desktop autoloader or pause orders from the Production Server software.
2. Select the windows **Start** menu and select |**Settings**|**Printers**|.
3. Right-click on **Disc Color Printer** and select **Printing Preferences**.
4. Select the **Advanced** tab and select the **Center Image** button.

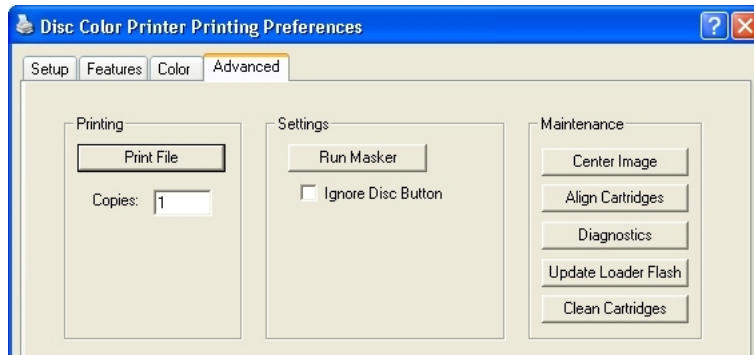

5. Select the **Print Test Pattern** button and the printer tray opens.

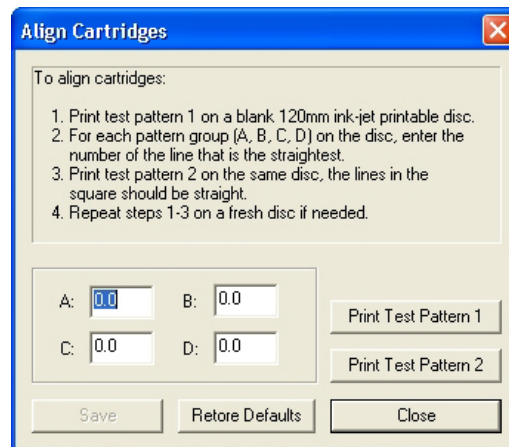

6. Place a full sized disc (120mm) on the printer tray.
7. When prompted, press the Disc button to close the printer tray.

- When it has finished printing, rotate the disc 180 degrees. Align three of the Position Lines, located on the outer edges of the disc, to the Tray Bracket Edge as shown here.

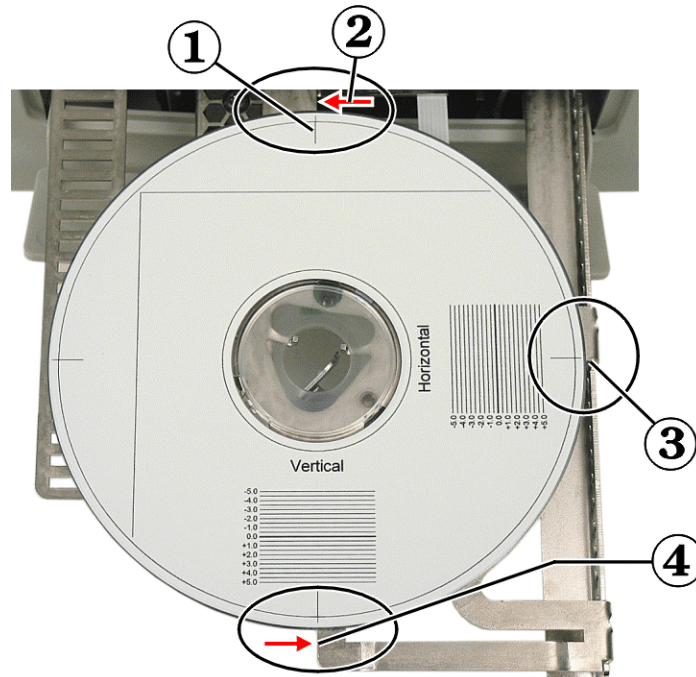

1 – Position Lines	2, 3, 4 – Tray Bracket Edge
--------------------	-----------------------------

- Select the **Print Test Pattern** button again.
- When prompted, press the Disc button to close the printer tray.
- When done printing, remove the disc.

12. Look at where each long line crosses the set of index lines.

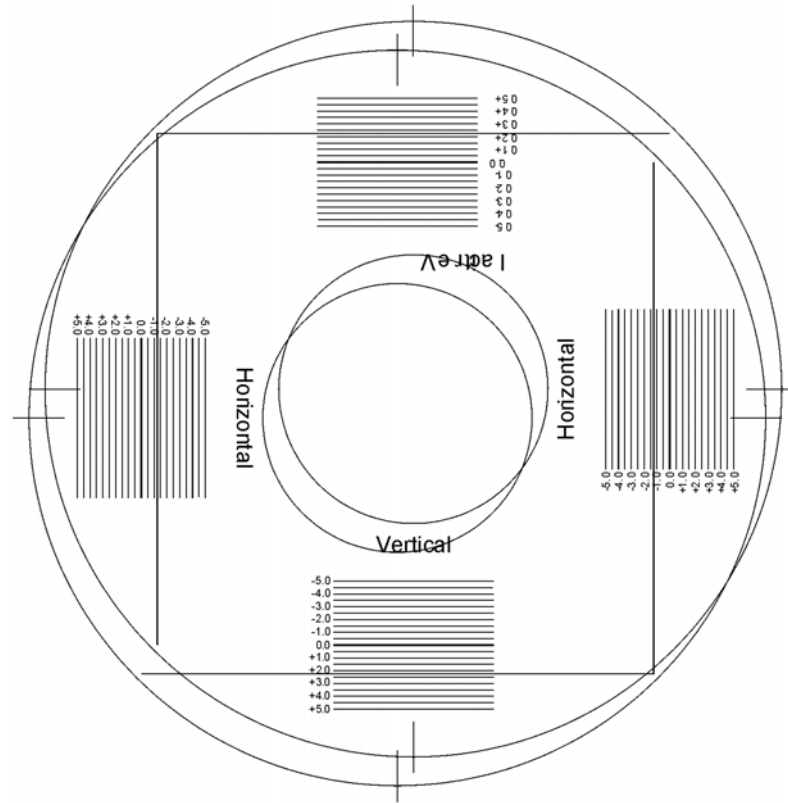

13. Enter the decimal index value where the long line crosses the index line in the Horizontal and Vertical group. Enter negative numbers with a negative character (-). Each line has a value of 0.5 units. The Horizontal value from above would be about -1.2 .

14. Select the **Save Settings** button.

15. To verify that the new values corrected the offset, place a new disc on the printer tray.

16. Select the **Print Test Pattern** button.

17. When prompted, press the Disc button to close the printer tray.

18. When it has finished printing, rotate the disc 180 degrees. Align the Position Lines on the outer edges of the disc to the printer's tray bracket.

19. Select the **Print Test Pattern** button.

20. When prompted, press the Disc button to close the printer tray.

21. After it completed printing the final pattern, remove the disc and check if the long lines cross the 0 index line.

22. If the long lines do not cross the zero index line in the vertical and horizontal groups, make final corrections and try again.

23. Select the **Close** button.

24. Select the Disc button to close the printer tray.

25. Close the Printing Preference window.

Diagnostics

At the **Advanced** tab under **Maintenance**, the **Diagnostics** dialog provides several device tests.

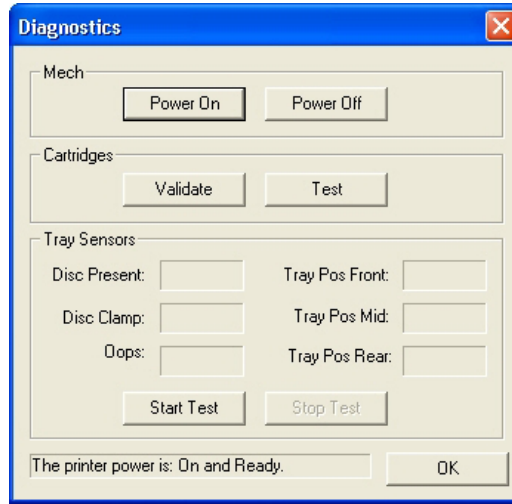

Mech

Select **Power Off** and **Power On** to cycle power to the tray mechanism. Select the **Power ON** button to resume operation.

Cartridges

Select the **Validate** button to verify if the ink cartridges are authentic ink cartridges.

Select the **Test** button to test communications between the printer and the cartridges.

Tray Sensors

The tray sensors function is for use only by, or at the direction of, Rimage Service personnel. Contact Rimage Corporation for additional information.

Update Autoloader Flash

To update the autoloader's flash firmware, download the latest flash from the Rimage Website. Save the flash file to the root of your local hard drive.

1. Open Production Server.
2. Stop the automation by making sure the **Start** button is not depressed as shown in here.

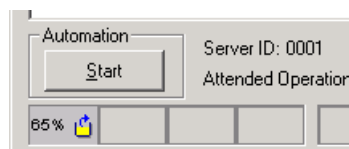

3. Insert Rimage software suite disc into the CD-ROM drive or download the latest flash version from the Rimage web site.
4. Unzip the flash file if it was downloaded from the website.
5. From the menu bar, select **Options/Update Transporter Flash**.

6. Select the location of the flash file from the Rimage OfficeNet Software Suite disc or the saved location if it was downloaded from the website.
7. Double-click the filename **name.bin** file.
8. The updating procedure runs until the flash file is updated to the autoloader. A dialog box appears that it completed the flash update.

Clean Cartridges

This function is used to clean or open the ink nozzles. The nozzles may become clogged from dry ink. This causes poor print from one or more nozzles not spraying one of the colored inks.

1. Stop all orders from processing. You can press the operator button on the Desktop autoloader or pause orders from the Production Server software.
2. Select the windows **Start** menu and select **|Settings|Printers|**.
3. Right-click on **Disc Color Printer** and select **Printing Preferences**.
4. Select the **Advanced** tab and select the **Clean Cartridges** button.
5. Select the **Light** button to clean the ink nozzles using the least amount of ink.



6. Try printing a test disc after cleaning the cartridges. If it still is not printing properly, use a heavier level if the nozzles do not open up after using the light duty cleaning.

Tray Controller

The Rimage Tray Controller icon () is installed in the Windows Icon Tray once it was initiated. **The tray controller must be running for the printer to function.**

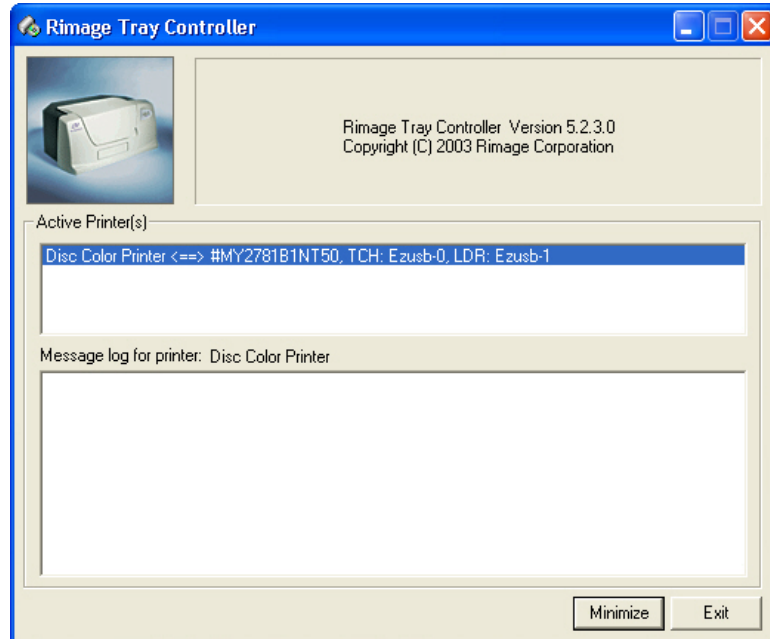

The Tray Controller application automatically runs in the background after the Production Server starts. The Tray Controller is only available if the Liberty Printer Driver was installed. The Printer Tray opens only if the PC is connected to the printer and the Tray Controller is running.

Tray Controller Help

This section is a helpful procedure if the printer tray did not come out after pressing the disc button.

1. Make sure the USB cable is plugged in at the printer and the PC.
2. Make sure the tray controller application is running. This is seen in the icon tray as shown here.



3. Make sure the tray controller application has finished initializing, by double-clicking on the tray controller icon.
4. Check for the status. If the status is OK and there are no error messages in the tray controller application, close the tray controller application and unplug the USB cable from the printer.
5. Plug the USB cable back in the printer.

6. Select the windows **Start** menu and select |**Programs**|**Rimage**|**Utilities**| and select **Disc Color Printer Tray Controller**.

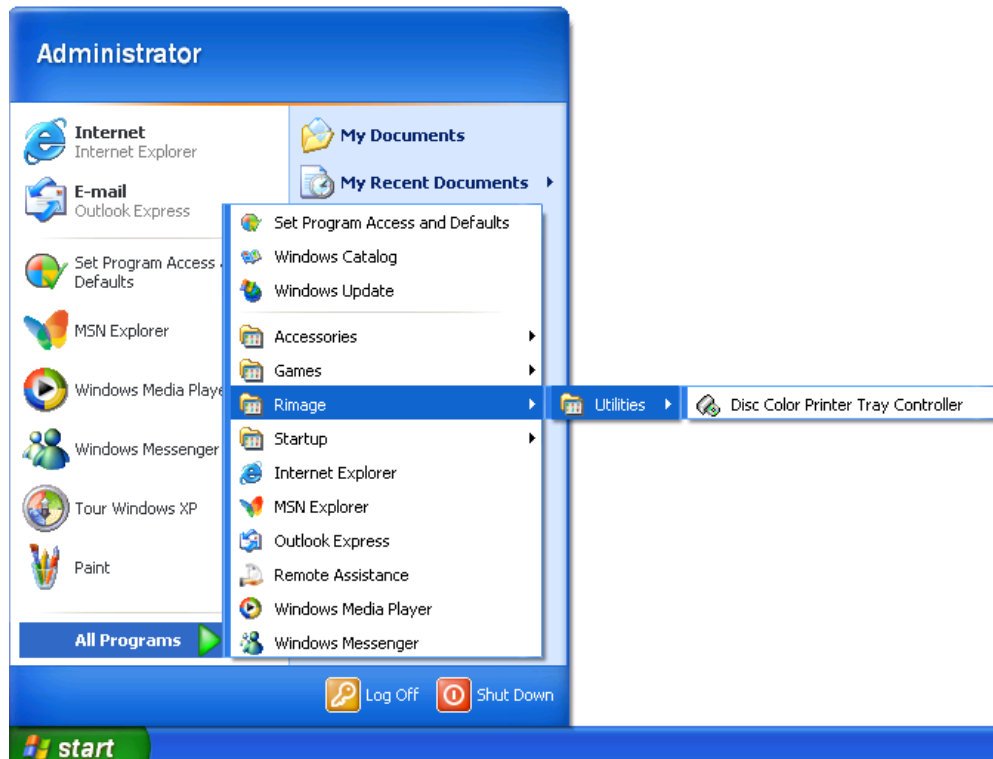

7. After the tray controller has completed the initialization, try opening the printer tray again by pressing the disc button.

Find Additional Information

Each software module contains online Help. Help features a Table of Contents pane on the left side of the window and the selected topic on the right. You may need to resize the windows to fit your screen.

Locate your printed *Software Suite 6 Getting Started Guide* for a short tutorial on creating your first disc.

Online Help

1. In QuickDisc for Windows, on the **Help** menu, click **Help Topics**. The initial QuickDisc help window displays.
2. Select the desired Help topic from the Table of Contents pane.

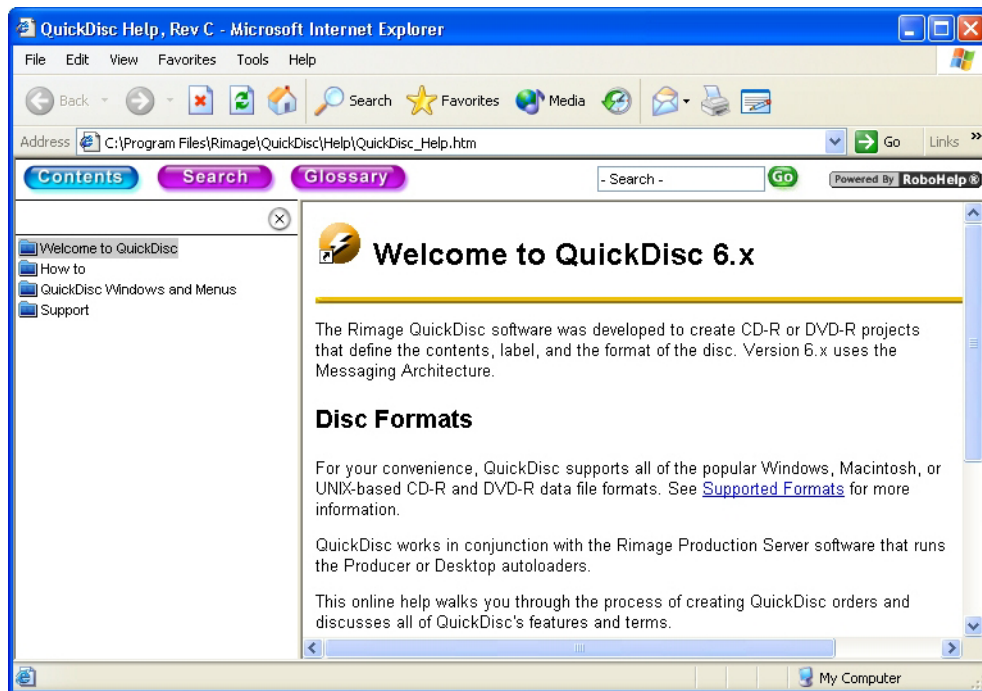

Technical Support and Product Updates

Support for the Desktop 1500 and 4500 is available directly from your authorized reseller or distributor. Online support for the Desktop autoloader is available on our website at <http://www.rimage.com/technical/>

Be sure to register your Desktop autoloader online or complete and return the registration card so we can notify you of upgrades as they become available.

Free Manuals Download Website

<http://myh66.com>

<http://usermanuals.us>

<http://www.somanuals.com>

<http://www.4manuals.cc>

<http://www.manual-lib.com>

<http://www.404manual.com>

<http://www.luxmanual.com>

<http://aubethermostatmanual.com>

Golf course search by state

<http://golfingnear.com>

Email search by domain

<http://emailbydomain.com>

Auto manuals search

<http://auto.somanuals.com>

TV manuals search

<http://tv.somanuals.com>