

QuattroDrive

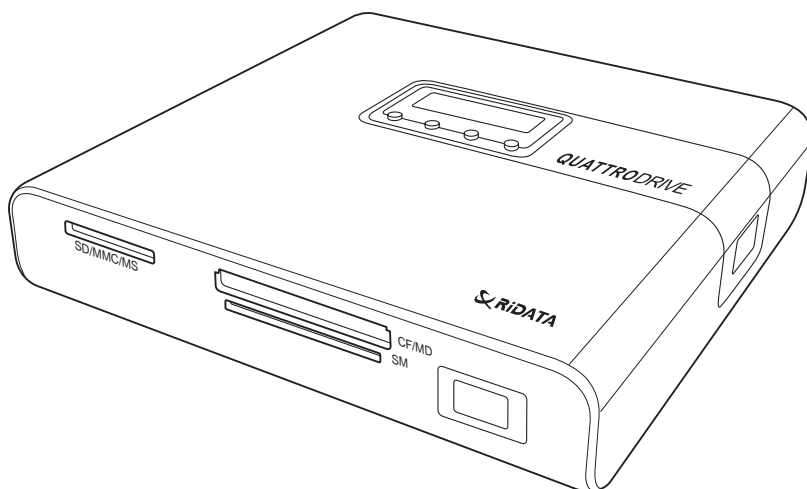

User Manual

ENGLISH

Contents

Introduction	1
About the Remote Control	1
Getting Started	4
Cable Connections	4
Connecting the Power	4
.....	4
Standalone Connection	4
Connecting to Headphones or a Stereo System	4
Connecting to a TV or Projector	5
Connecting to a Computer.....	5
Inserting Flash Memory Cards.....	6
Inserting and Removing a CD.....	6
Turning the QuattroDrive On	7
Installing Drivers	7
Using QuattroDrive	8
Using the OSD Setup Menus.....	8
Navigating the Menus.....	8
Adjusting the TV Settings	9
Setting the OSD Language.....	10
GENERAL SETUP	11
SPEAKER SETUP	12
AUDIO SETUP	13
PREFERENCES.....	15
DISC SETUP	18
Switching between Flash Memory Cards and a CD	18
Using the Remote Control	18
Using the Buttons on the QuattroDrive.....	18
Copying Files to the Computer	19
Copying from a Flash Memory Card.....	19
Copying from a CD	19
Listening to Music	19

Viewing and Editing Media Files	20
Viewing files with the SMART NAVI Menu	20
Viewing files without the SMART NAVI Menu	21
Using the Slide Show.....	22
Playing a VCD or DVD	23
Basic Functions	23
Programming the Playing Order of Audio or Video CDs.....	25
Going to a Particular DVD Chapter.....	25
Repeating Chapters/Tracks	26
Writing (Burning) Files to a CD	26
Writing from a Flash Memory Card.....	26
Disk Spanning.....	28
Writing from the Computer.....	28
Erasing a CD-RW	28
Appendix.....	29
Error Codes.....	29
Quick Start Guide.....	29
RESET CVBS NTSC	29
SET PAL	29

Introduction

About the Remote Control

Below is a description of the remote control's buttons:

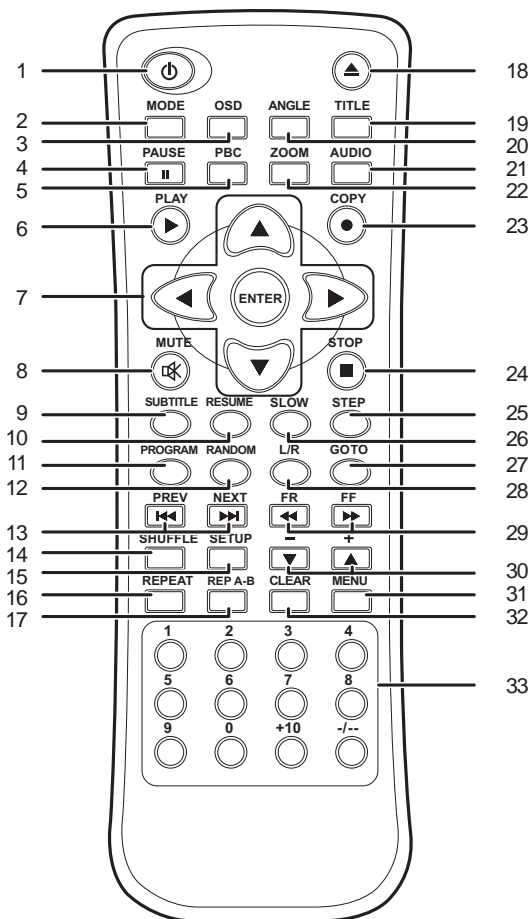

Button	Function
1. POWER ON/OFF	Turns the PhotoStorage on and off.
2. MODE	Switches between the CD and a flash card.

About the Remote Control

Button	Function
3. OSD	The On Screen Display (OSD) displays the status bar at the top of the screen that includes playback and remaining time for both the title and the chapter of the current multimedia.
4. PAUSE	Pauses playback of movies or music.
5. PBC	If a video CD has "Playback control" (PBC) written on its disc, it means that particular scenes or information can be selected for interactive viewing. Press this button to use this feature.
6. PLAY	Starts playback of multimedia files or CDs.
7. MENU CONTROL BUTTONS	Used for navigating and entering menus.
8. MUTE	Disables the sound during playback.
9. SUBTITLE	Changes the language of the DVD's subtitles.
10. RESUME	Used only in conjunction with the STEP button (25). Steps back through a movie one frame at a time.
11. PROGRAM	Displays a screen where you can program the playback of an audio CD.
12. RANDOM	Not used.
13. PREV/NEXT	Skips to the previous or next chapter of a DVD/VCD or track in the case of an audio CD, respectively.
14. SHUFFLE	Shuffles music tracks for random playback.
15. SETUP	Used for setting various options of the PhotoStorage.
16. REPEAT	Cycles through repeating of the current chapter/track, repeating of the whole CD/DVD, and no repeat.
17. REP A-B	Marks the start (A) and end (B) points for repeated playback.
18. EJECT	Ejects the disk.

Button	Function
19. TITLE	Displays the DVD's title screen where you can set various settings such as language and sound preferences. Use the MENU CONTROL buttons (7) to navigate around the screen.
20. ANGLE	Some DVD movies have images shot at different camera angles. Use this to select which angle you want to watch it from. This only works if there is an angle mark on the DVD and you have selected "ON" for angle mark in the GENERAL SETUP.
21. AUDIO	Selects the language for the DVD's audio output.
22. ZOOM	Cycles through three zoom levels: 1.5x, 2x, 3x, and zoom off.
23. COPY	Copyies (burns) files from the Flash Memory Card to the CD-RW.
24. STOP	Stops the playback of movies or music.
25. STEP	Steps through a movie one frame at a time. Press PLAY (6) to resume normal play.
26. SLOW	Cycles through 1/2x, 1/4x, and 1/8x of normal playback speed.
27. GO TO	Skips to a desired chapter.
28. L/R	Not used.
29. FR/FF	Cycles through 2, 4, 6, and 8 times normal playback speeds for fast reverse and fast forward respectively.
30. VOLUME CONTROLS	Controls the volume level.
31. MENU	Displays a menu for playing a DVD and obtaining the playback status.
32. CLEAR	Deletes numbers for GO TO play, repeated play, programed play and security codes.
33. NUMBER BUTTONS (0 ~ 9, 10+)	Selects a track or menu/submenu.

Getting Started

Cable Connections

The following descriptions show how to make the various connections.

Connecting the Power

Plug the DC power adaptor into a wall socket then connect the DC power adaptor to QuattroDrive **DC IN 5V** socket as shown in the diagram.

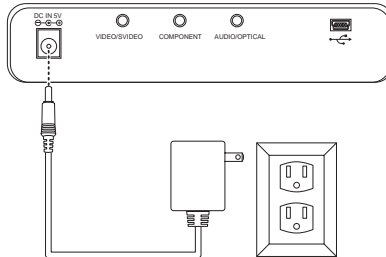

Standalone Connection

Without any connections, QuattroDrive can only be used for burning CD-CD-RW as a way to back up your files from a flash memory card.

Connecting to Headphones or a Stereo System

There are two ways in which you can make a connection for listening to music.

- Connect your headphone cable into the **AUDIO** socket on the QuattroDrive.
- Connect the audio cable from the **AUDIO** socket on the QuattroDrive to the audio input sockets on your stereo.

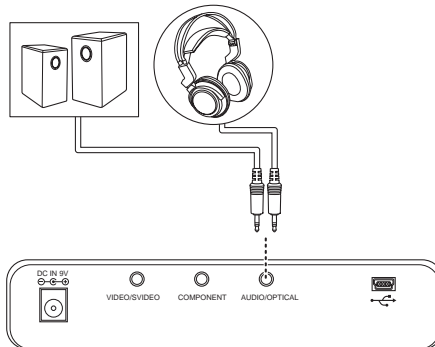

Connecting to a TV or Projector

Follow these steps to connect the QuattroDrive to a television or projector.

1. Connect the audio cable (red and white plugs) from the **AUDIO** socket to the audio IN socket of your TV or stereo system.
2. Connect the AV cable (yellow plug) from the QuattroDrive **VIDEO** socket to the **VIDEO IN** socket of the TV or projector.

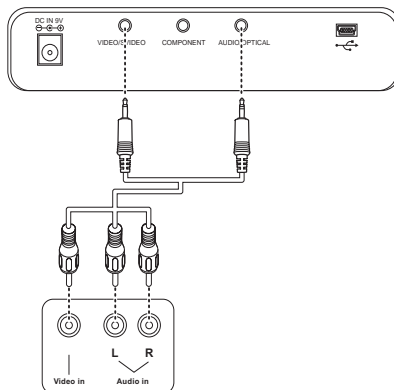

NOTE: The audio cable leading to the QuattroDrive has two black bands on the connector; the video cable has only one black band on the connector.

Connecting to a Computer

Follow these steps to connect the QuattroDrive to a computer

1. Connect the USB cable from the QuattroDrive USB port to the USB port on the back of the computer.

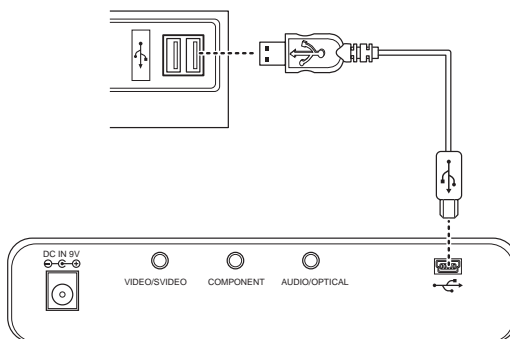

2. A “New hardware found” screen appears. Follow the instructions on the screen and restart your computer when prompted.

If you have Windows 98, you will need to install the drivers as described in *Installing Drivers* on page 7.

Once the drivers have been installed, a CD drive icon and up to three removable hard drive icons will appear in **My Computer** on the desktop.

Inserting Flash Memory Cards

Inserting Flash Memory Cards

QuattroDrive supports a number of different card types. The following instructions explain how to insert a Flash Memory Card.

1. Position the Flash Memory Card in the direction shown in the diagram.

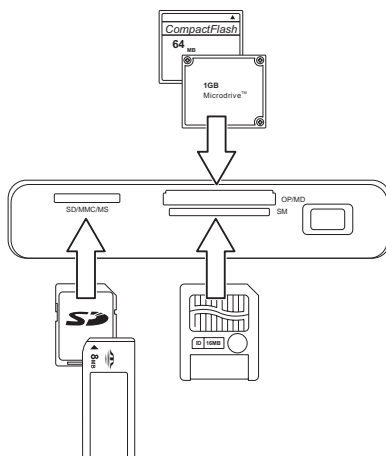

2. Make sure that the card is being inserted into the correct slot.
 - Left slot is for MS, MS Pre, MS Duo, SD and MMC cards
 - Middle top slot is for CF and MD cards
 - Middle below slot is for SM cards
3. Making sure that the card is oriented correctly – all cards will have a direction arrow indicated – push the card in until it locks in place. A slight amount of resistance will be felt as the card is seated. This is normal.

To remove a Flash Memory Card, grasp the end firmly between your thumb and index finger and pull the card from the slot.

NOTE: Only one Flash Memory Card can be used at any one time.

Inserting and Removing a CD

1. Press the eject button at the front of the QuattroDrive.

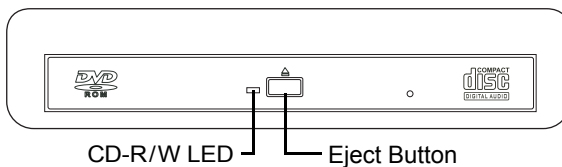

2. Insert or remove a CD/DVD from the QuattroDrive and close the drive.

Turning the QuattroDrive On

To turn on the QuattroDrive:

1. Make the appropriate connections as described in *Getting Started* on page 4.
2. Push the **POWER ON/OFF** button for about two seconds. The front LCD panel lights up and if connected to a TV or projector, the main screen appears.

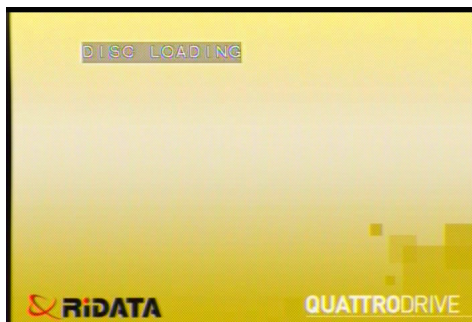

Installing Drivers

For Windows 98SE and ME, you will need to install the Card Reader and CD-RW drivers.

1. Connect the QuattroDrive to the computer as described in *Connecting to a Computer* on page 5.
2. Insert the supplied driver CD into the CD-ROM drive. The following screen is displayed.
3. Click **Card Reader Driver for Win 98SE/ME/2k/XP** and follow the instructions on the screen.
4. Click **CD-RW Driver for Win 98SE** and follow the instructions on the screen.



NOTE: For Mac OS X, refer to the `mac_installation.pdf` file located in the `Mac_Installation` directory of the Driver CD for installation instructions.

Using QuattroDrive

Using the OSD Setup Menus

This section describes the different settings within the Setup Menus.

Navigating the Menus

1. To bring up the **SETUP MENU**, press the **SETUP** button on the remote control.

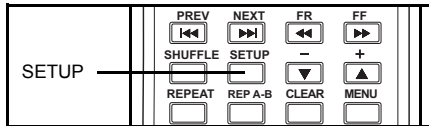

2. In the **MAIN PAGE** of the **SETUP MENU**, press the **UP** and **DOWN** buttons on the remote control to select the desired submenu.

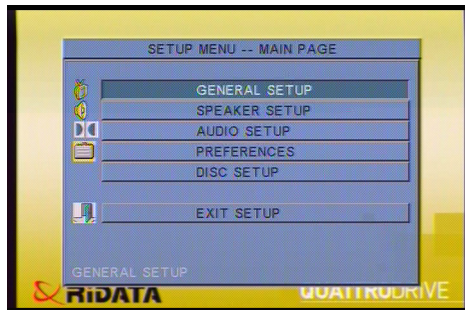
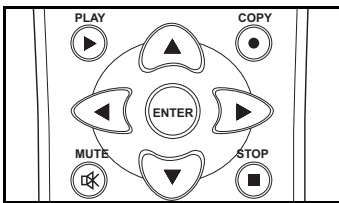

3. Press the **ENTER** button on the remote control to enter the selected submenu.
4. In the submenu, press the **UP** and **DOWN** buttons to select the desired setting.
5. Press the **RIGHT** button on the remote control to move across to the options for that setting in the right column, as shown below.

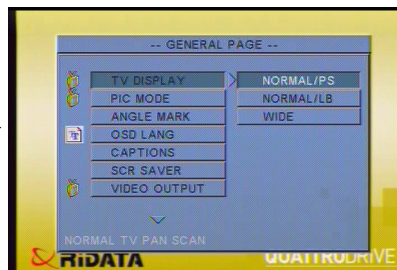
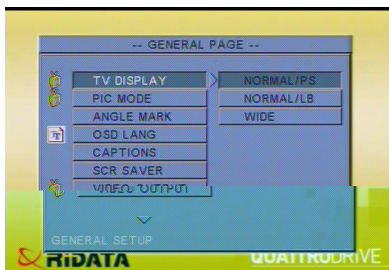

6. Press the **UP** and **DOWN** buttons to select the options for that setting.
7. Press the **ENTER** button to confirm your option.

To exit, press the **LEFT** button to return to the submenu settings in the left column. Scroll down to **MAIN PAGE** and press **ENTER** to return to the main menu.

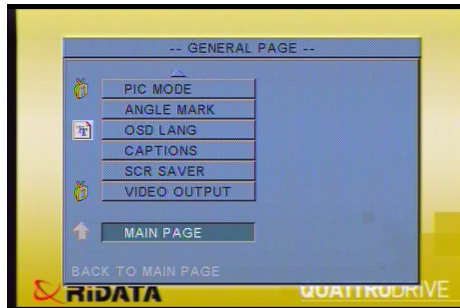

Scroll down to **EXIT SETUP** and press **ENTER** to exit the **SETUP MENU**.

Pressing the **SETUP** button on the remote control at any time will also exit the **SETUP MENU**.

If an arrow appears at the top or bottom of the left menu button column, it means there are more menus/options to choose from that aren't displayed on the screen.

Adjusting the TV Settings

To adjust the TV Settings:

1. Enter the **SETUP MENU** as described in *Navigating the Menus* on page 8.
2. Enter the **PREFERENCES page** and select **TV TYPE**.
3. Select the TV type required. Options are **MULTI**, **NTSC**, and **PAL**. **MULTI** means that both NTSC and PAL signals are sent from the QuattroDrive to the TV or Projector.

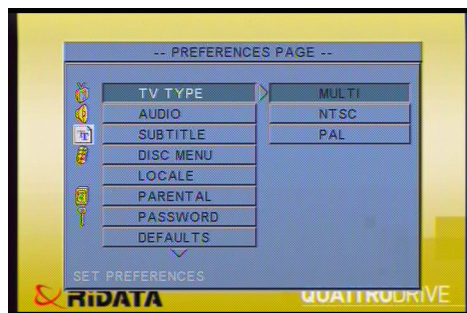

NOTE: You will also need to know whether the source DVD is in NTSC or PAL format before setting this option.

Using the OSD Setup Menus

- Return to the main menu and enter the **GENERAL SETUP** page.
- Scroll down to **VIDEO OUTPUT**.

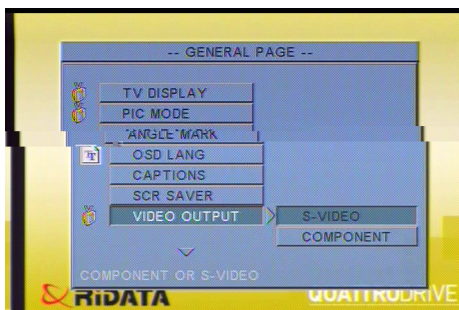

- Select the video output, **COMPONENT**, that you will be connecting to on the QuattroDrive. See *Connecting to a TV or Projector* on page 5.

Setting the OSD Language

To set the OSD language:

- Enter the **SETUP MENU** as described in *Navigating the Menus* on page 8.
- Enter the **GENERAL SETUP** page and scroll down to **OSD LANG**.

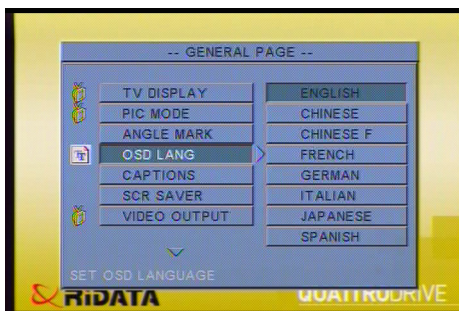

- Select the desired language.

GENERAL SETUP

TV DISPLAY has three options for choosing the displays aspect ratio.

- **NORMAL/PS** – for viewing on a normal TV.
- **NORMAL/LB** – for viewing similar to that of a movie at the theater. This is best used on a normal TV. There will be two black sections at the top and bottom of the screen.
- **WIDE** – This is similar to NORMAL/LB but meant for widevision televisions. If played on a normal television, the whole TV screen will display a picture but the sides will be cut off.

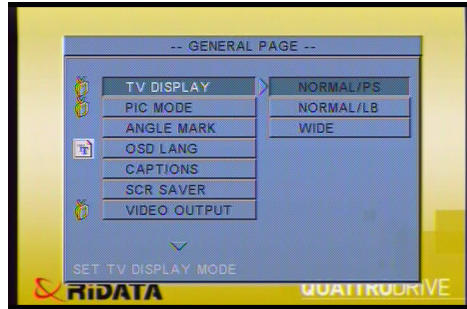

PIC MODE has three options.

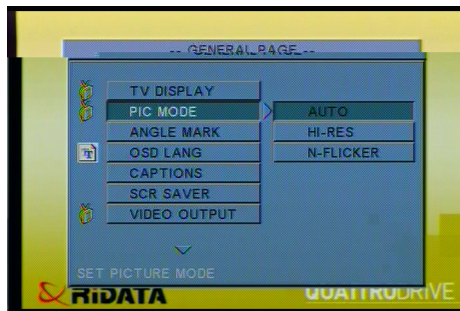

- **AUTO** – automatically chooses the best resolution for the unit being displayed on.
- **HIRES** – for high resolution picture mode.
- **N-FLICKER** – for non-flicker picture mode.

ANGLE MARK can be turned on or off. It is used to allow for viewing a movie from different angles. This can only be used if the DVD movie has been filmed from different angles.

For an explanation of **OSD LANG**, see *Setting the OSD Language* on page 10.

CAPTIONS can be turned on or off.

SCR SAVER can be turned on or off.

For an explanation of **VIDEO OUTPUT**, see *Adjusting the TV Settings* on page 9.

Using the OSD Setup Menus

SPEAKER SETUP

DOWNMIX converts Dolby surround sound to normal stereo sound maintaining a high quality sound.

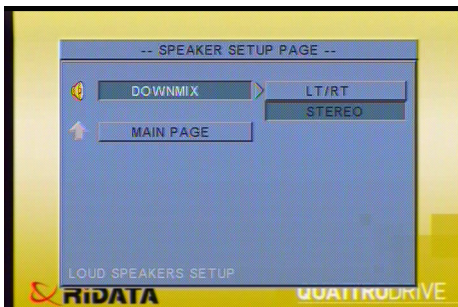

- **LR/RT** – is used when the DVD has been recorded in DOLBY PRO-LOGIC stereo.
- **STEREO** – produces ordinary stereo sounds.
- **OFF** - turns off downmixing.

NOTE: To enable the speaker options, set **DOWNMIX** to off and **AUDIO OUT** to **ANALOG** as described in *AUDIO SETUP* on page 13.

AUDIO SETUP

AUDIO OUT has three options

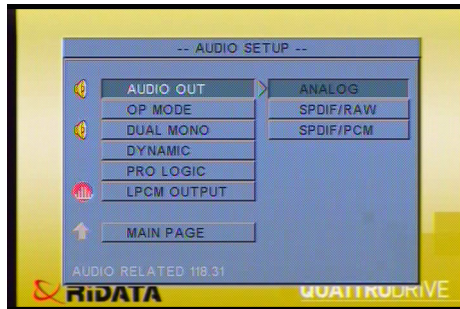

- **ANALOG** – This is normally used with speakers.
- **SPDIF/RAW** – Select this if the surround sound is output through or coaxial cables.
- **SPDIF/PCM** – Select this if the surround sound is output through or coaxial cables (pulse code modulation).

OPMODE has two options.

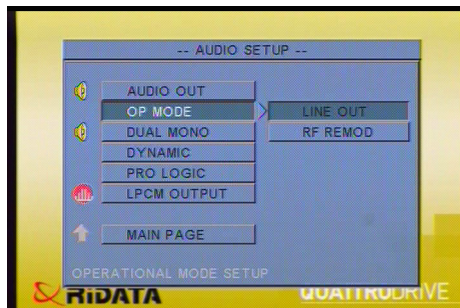

- **LINE OUT** – This is used in most cases.
- **RF REMOD** – Select this option when headphones are used.

Using the OSD Setup Menus

DUAL MONO – Can only be with Dolby Digital disks that have dual mono software encoded in them. You can select one of the following options: **STEREO**, **L-MONO**, **R-MONO**, or **MIX-MONO**.

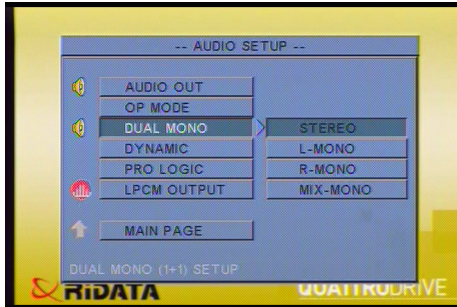

DYNAMIC – Move the slider to make your selection.

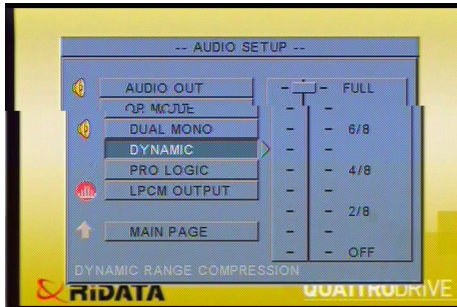

PRO LOGIC – Set this as **ON**, **OFF** or **AUTO**.

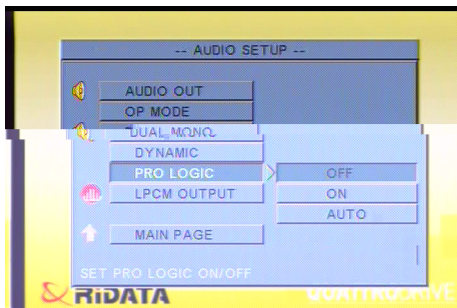

LPCM OUTPUT – Select 48K or 98K as the digitizing speed for LPCM. This is an uncompressed format for audio.

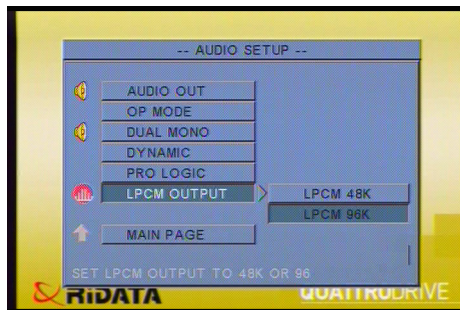

PREFERENCES

For an explanation of **TV TYPE**, see *Adjusting the TV Settings* on page 9.

DVDs may contain a number of different languages for **AUDIO**, **SUBTITLE** and **DISC MENU**. Setting these options automatically selects the languages to be used by the DVD if those languages are contained within the DVD itself. **SUBTITLE** also contains an **OFF** option.

LOCALE is used to select the country you're in.

PARENTAL and PASSWORD

are used together to set the age restriction for preventing children from watching violent or sexual scenes. To change or set up a new parental password, follow the steps below.

1. Go to **PASSWORD**, select **CHANGE** and press **ENTER** on the remote control.

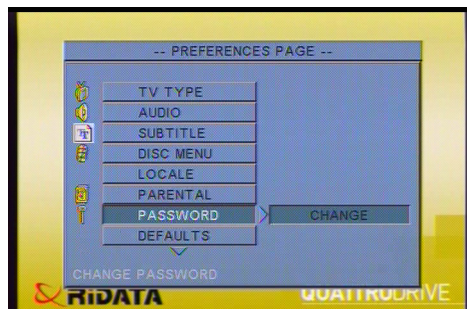
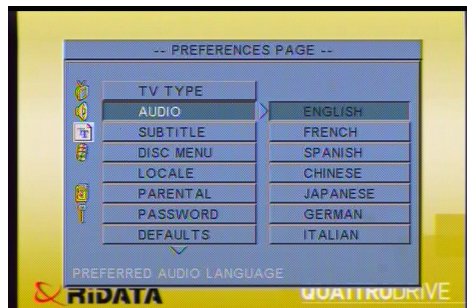

Using the OSD Setup Menus

2. Enter the old four digit password code using the number buttons on the remote. For a new machine, the default is 3308.

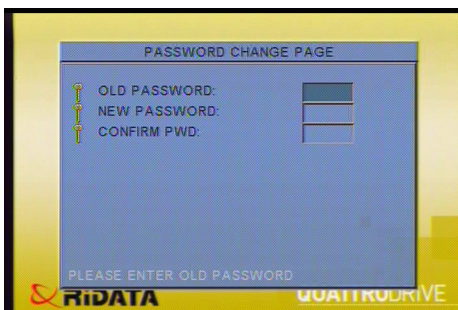

3. Enter the new four digit password code and then enter it a second time.
4. Set an appropriate restriction from the **PARENTAL** list.

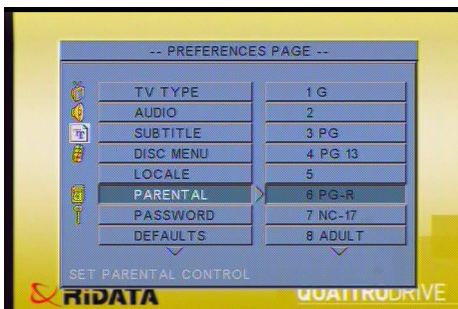

5. Upon setting a restriction, a Password Verification Page is displayed. Enter the 4 digit password and press **ENTER**.

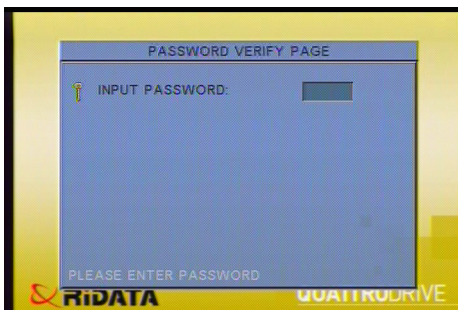

The **PARENTAL** list is the MPAA ratings and their definitions are listed in the following table.

MPAA RATINGS

	G	GENERAL AUDIENCES	Suitable for all ages.
	PG	PARENTAL GUIDANCE SUGGESTED	Some material may not be suitable for children.
Age base	PG-13	PARENTS STRONGLY CAUTIONED	Some material may be inappropriate for children under 13.
	R	RESTRICTED	Under 17 requires accompanying guardian or parent
	NC-17	NO ONE 17 OR UNDER ADMITTED	
	ADULT	NO ONE 18 OR UNDER ADMITTED	

When a DVD is played with a rating of that set in **PARENTAL** or higher, the password verification screen, shown in step 5, is displayed.

Enter the correct password using the number buttons on the remote control.

Select **RESET** in **DEFAULTS** to reset the settings back to factory settings.

Selecting **WITH MENU** for **SMART NAV** setting will enable you to view files on Flash Memory Cards or CD.

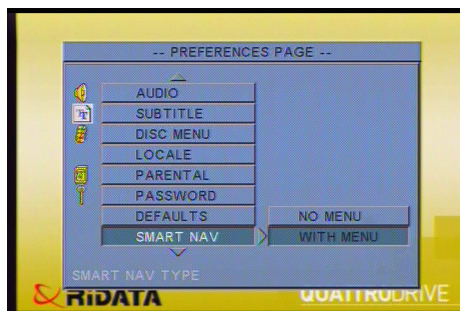

Switching between Flash Memory Cards and a CD

DISC SETUP

This page is used to set various CD-RW functions for burning (writing) a CD.

ERASE CD-RW is used to erase a CD-RW before burning.

MODE SELECT has three options.

WRITE MODE – burns to the CD.

TEST MODE – simulates a burn to the CD but does not actually perform an actual burn.

VERIFY MODE – burns to the CD and then verifies the data.

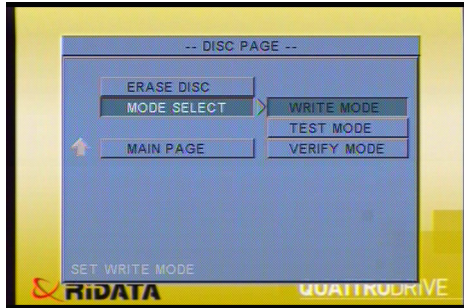

Switching between Flash Memory Cards and a CD

There are two ways to switch between a Flash Memory Card and a CD.

Using the Remote Control

This method is normally used when the QuattroDrive is connected to a TV or a projector.

Press the **MODE** button on the remote control. The **GOTO** button can also be used.

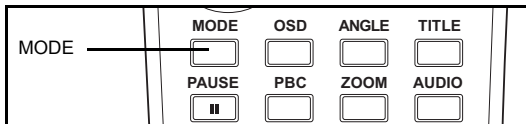

The OSD will display **FLASH CARD** or **DISC LOADING** in the top left corner.

Using the Buttons on the QuattroDrive

This method is used for when you are on the road and a TV or projector is not available.

1. Press the STOP/ESC button on the QuattroDrive to bring up the menu in the LCD panel.
2. Press the PREV and NEXT buttons to switch between **CArd**, **diSC**, **COpy** or **ErASE**.
3. Press the ENTER/PLAY button to switch to the desired media storage type, copy files to a CD-R/W or erasing a CD-RW. See *Writing (Burning) Files to a CD* on page 26 for details on the copy and erase functions.

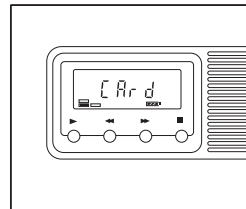

Copying Files to the Computer

Copying from a Flash Memory Card

1. Connect the QuattroDrive to the computer as described in *Connecting to a Computer* on page 5.
Once connected, a CD drive icon and up to three removable hard drive icons will appear in **My Computer** on the desktop.
2. Open the removable hard drive that contains the Flash Memory Card data.
3. Copy the files across to the computer as you normally would.

Files can also be copied to a Flash Memory Card in the same way.

Copying from a CD

1. Make connections as described in *Connecting to a Computer* on page 5.
Once connected, a CD drive icon and up to three removable hard drive icons will appear in **My Computer** on the desktop.
2. Open the new CD drive icon.
3. Copy the files across to the computer as you normally would.

Listening to Music

The QuattroDrive can be used as a portable CD or MP3 player all rolled into one. To listen to music, follow the steps below.

1. Make connections as described in *Connecting to Headphones or a Stereo System* on page 4.
2. Insert a music CD or a Flash Memory Card containing MP3 files or other music file formats as described in *Inserting and Removing a CD* on page 6 or *Inserting Flash Memory Cards* on page 6 respectively.
3. Switch to the correct media storage type as described in *Switching between Flash Memory Cards and a CD* on page 18.
4. Press the **PLAY** button on the QuattroDrive to start playback.

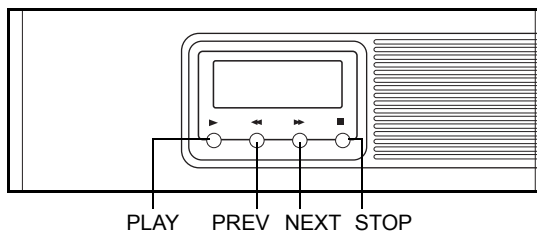

Press **PLAY** during playback to pause and then **PLAY** again to continue with playback.

Press **STOP** to stop playback.

Press **PREV** and **NEXT** buttons to go to the previous or next tracks respectively.

Viewing and Editing Media Files

To be able to use other functions effectively, such as repeat, program and so on, you will need to connect it to a TV as described in *Connecting to a TV or Projector* on page 5. See *Playing a VCD or DVD* on page 23 for other functions.

Viewing and Editing Media Files

To view pictures, you will first need to:

1. Make connections in *Connecting to a TV or Projector* on page 5.
2. Refer to *Switching between Flash Memory Cards and a CD* on page 18 to switch to the correct media storage type where the files are stored.

View files when **WITH MENU** option is set for **SMART NAVI**, as described in *PREFERENCES* on page 15, is easier than with **NO MENU**.

Viewing files with the SMART NAVI Menu

1. After setting **SMART NAVI** and exiting from the setup menu, the following screen will then appear.
2. Navigate through folders and select files as described in *Navigating the Menus* on page 8. Pressing a number on the remote control's number pad will also select that file or folder.

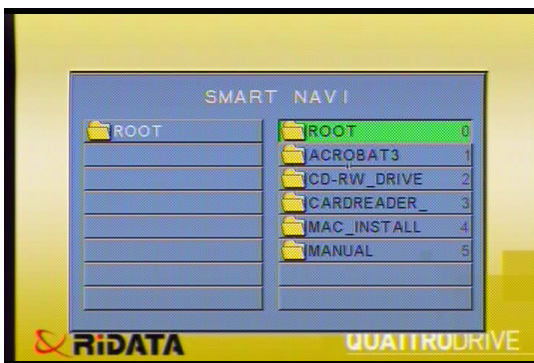

If you are in a sub folder, the top right menu item will be “..” which means to go back to the previous folder.

Selecting an audio or movie file will play that file. See *Listening to Music* on page 19 and *Playing a VCD or DVD* on page 23 for more information about these types of files.

3. Use the left and right buttons on the remote control to rotate the image 90°. Use the up and down buttons to mirror the image on the horizontal axis.

4. Press **STOP** button to exit.

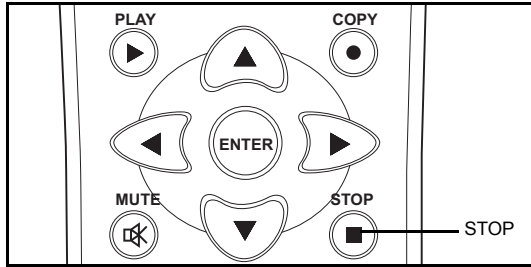

Viewing files without the SMART NAVI Menu

1. Press the **SHUFFLE** button until **FOLDER** is displayed on the OSD.

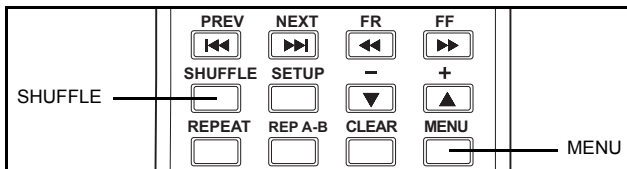

2. Press **MENU** and the following thumbnail screen will appear.
3. Press a number button on the remote control and the corresponding picture will be displayed.

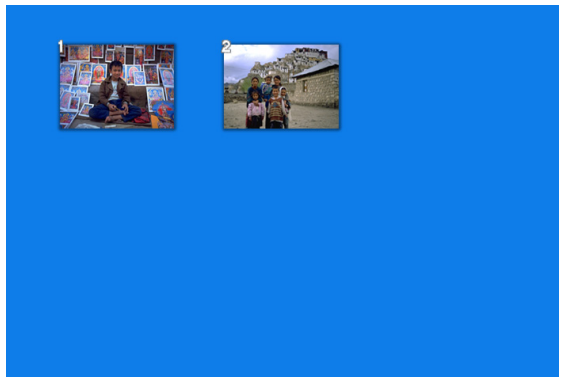

If slide show is not set to **NONE**, the pictures will be displayed otherwise it will display the pictures as a slide show.

4. Use the left and right buttons on the remote control to rotate the image 90°.
5. Use the up and down buttons to mirror the image on the horizontal axis.
5. Press **STOP** button to exit.

Viewing and Editing Media Files

Using the Slide Show

1. Bring up one of the two screens as described in the previous two sections, SMART NAVI and thumb nail screen.
2. Press the **RESUME** button to cycle through a number of different slide show effects as shown in the table below.

Mode	Effect	Mode	Effect
0	No special effects (default)	7	Wipe from right to left
1	Wipe from top to bottom	8	Wipe from left/right to center
2	Wipe from bottom to top	9	Wipe from center to left/right
3	Wipe from top/bottom to center	10	Wipe from edge to center
4	Wipe from center to top/ bottom	11	Horizontal blinds
5	Vertical blinds	12	Random
6	Wipe from left to right		

3. Press **PLAY** or **ENTER** on the remote control to start the slide show.
If slide show is set to **NONE**, a single picture will be displayed otherwise it will display the pictures as a slide show.
4. Use the left and right buttons on the remote control to rotate the image 90°.
Use the up and down buttons to mirror the image on the horizontal axis.
5. Press **STOP** button to stop the slide show.

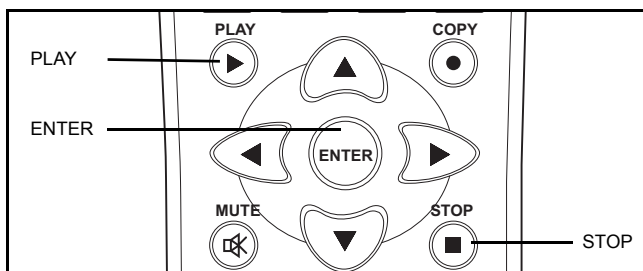

ecting to a T

ive



Drive. The DVD

epend

8

sed and

ovie from

have h

MARK, i

urned

ays the title

auses

playba

– If a vid

ans that

active vi

CM

es not work with

AUDIO – Cycles through the DV

Playing a VCD or DVD

- **PLAY** – Starts playing a multimedia CD/file or continues playback after pausing.
- **ARROW BUTTONS** – Selects a menu item in a DVD menu.
- **ENTER** – To choose an item on the DVD menu. Begins playback if the main QuattroDrive screen is being displayed.
- **MUTE** – Disable the sound during playback.
- **STOP** – Stops playing the multimedia CD or file.

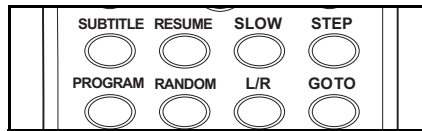
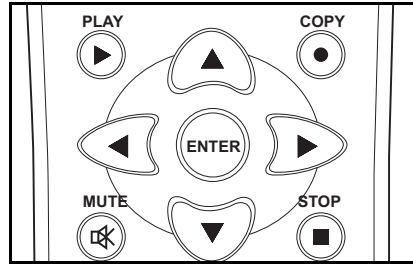

- **SUBTITLE** – Cycles through the DVD's available subtitle languages during playback.
- **RESUME** – Works only in conjunction with the **STEP** button and steps backward a frame at a time.
- **SLOW** – Cycles through 1/2x, 1/4x, 1/8x of normal playback speed in both a backward and forward direction and then back to normal playback speeds.
- **STEP** – Used to step through a frame at a time. Doesn't work with audio. Press the **PLAY** or **ENTER** buttons to continue with normal playback.

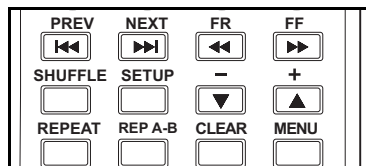

- **PREV/NEXT** – Skips to the previous or next chapter of a DVD/VCD or track in the case of an audio CD, respectively
- **FR/FF** – Cycles through 2, 4, 6, and 8 times normal playback speeds for fast reverse and fast forward respectively.
- **SHUFFLE** – Sets a random sequence for playing audio files or CDs. Press this until **RANDOM** appears in the top left corner of the OSD.
- **- and +** – These are the volume controls.
- **CLEAR** – Clears repeated tracks/titles, randomized tracks and programmed tracks.
- **MENU** – Displays the DVD's main menu.

Programming the Playing Order of Audio or Video CDs

To program the playing order of audio CDs, video CDs and other multimedia files, follow the steps below.

1. Play the audio or video CD/file as normal.
2. Pause playback.
3. Press **PROGRAM** on the remote control.

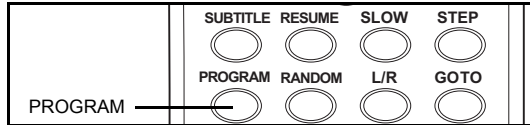

4. PROGRAM 00 : 0000 appears on the screen. Type in the tracks/chapters that you want to play in order.

Going to a Particular DVD Chapter.

1. Press the **GOTO** button on the remote control.

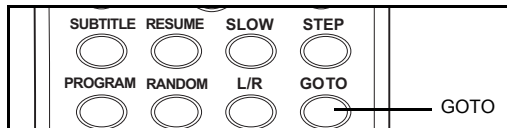

The screen to the right will appear.

2. Press the left or right arrow buttons on the remote control to select **TITLE** and enter the number using the number buttons.
3. Press the left or right arrow buttons again to select **CHAPTER** and use the number buttons to go to the desired chapter.
4. Pressing the **GOTO** button twice will bring up a time screen where you can enter a time frame to go to instead.

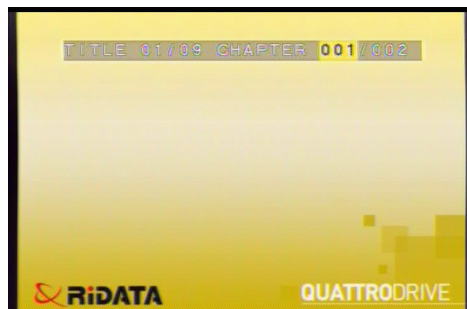

Writing (Burning) Files to a CD

Repeating Chapters/Tracks

Press the **REPEAT** button on the remote control for repeating chapters or tracks.

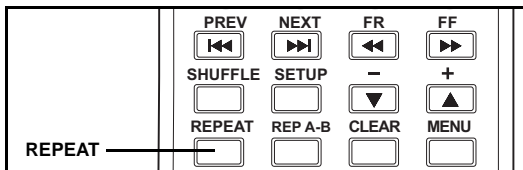

For DVDs, this will cycle through **CHAPTER REPEAT ON**, **TITLE REPEAT ON** and **REPEAT OFF**. The current chapter or title will be repeated.

For music, **REP-ONE** will repeat the current track while **REP-ALL** will repeat all tracks. **REPEAT OFF** will turn off repeating of tracks.

The **REP A-B** button is used for repeating between several titles or tracks.

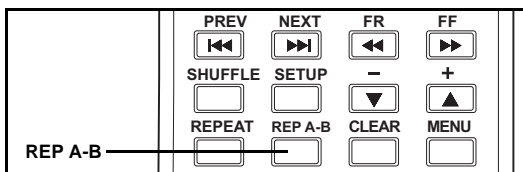

1. Press the **REP A-B** button to set the start position. The **A TO B SET A** message will be displayed.
2. Continue playing as normal until the desired end position and press **REP A-B** button again. The **A TO B SET B** message will be displayed.
3. Press the **REP A-B** button once again to cancel repeated playback.

Writing (Burning) Files to a CD

Files can be written to a CD-R or CD-RW, which is known as burning, as a way of backing up files. With a CD-RW, multi-session CDs are created enabling you to write to the CD as many times as you like.

Writing from a Flash Memory Card

There are two methods which you can use to write from a Flash Memory Card to a CD-RW.

When the QuattroDrive is connected to a TV/projector, follow the steps below.

1. Insert the Flash Memory Card as described in *Inserting Flash Memory Cards* on page 6.
2. Set up the disk burning options as described in *DISC SETUP* on page 18.
3. Insert a CD-RW or a blank CD-R into the QuattroDrive as described in *Inserting and Removing a CD* on page 6.

- Press **COPY** on the remote control to start burning files to the CD.

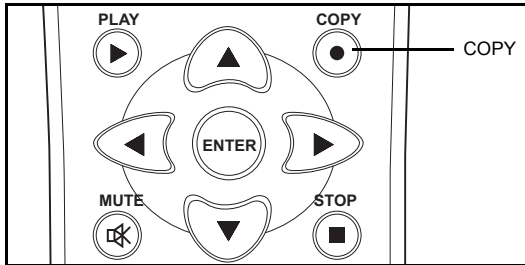

- Wait until the **COPY COMPLETED** message appears on the screen and the CD-R/W LED stops flashing before removing the CD.

When the QuattroDrive is not connected to a TV/projector, follow the steps below.

- Insert the Flash Memory Card as described in *Inserting Flash Memory Cards* on page 6.
- Insert a CD-RW or a blank CD-R into the QuattroDrive as described in *Inserting and Removing a CD* on page 6.
- Press the STOP/ESC button on the QuattroDrive to bring up the menu in the LCD panel.
- Press the PREV and NEXT buttons until **COPY** appears in the LCD panel.
- Press the ENTER/PLAY button to begin copying to the CD-RW. A number will appear showing the percent left to be copied as shown in the diagram. Wait until the **End** message or an error message (see *Error Codes* on page 29) appears before continuing.

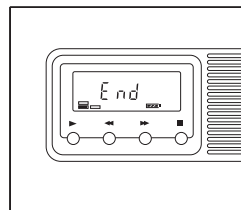
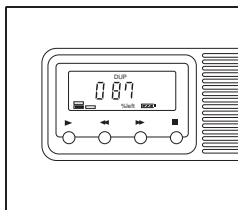

- Press the STOP/ESC button to get back to the main menu and again to exit.

NOTE: Ensure that **MODE SELECT** is not set to **TEST MODE** as described in *DISC SETUP* on page 18, before disconnecting from the TV/projector, otherwise files will not be burnt to the CD-R/W.

Files are placed in a directory called **DMX** with a consecutive number following. For example, files from your first burn will be placed in a directory called **DMX01**, files from your second burn will be placed in a directory called **DMX02** and so on.

Writing (Burning) Files to a CD

Disk Spanning

The QuattroDrive supports disk spanning which means, when burning files from a Flash Memory Card to a CD-RW and the CD-RW becomes full, the QuattroDrive will prompt you to insert a new CD-RW. After Inserting a new CD-RW, burning will automatically continue. This can be done up to four times in one burning session.

Writing from the Computer

1. Connect the QuattroDrive to a computer as described in *Connecting to a Computer* on page 5.
2. Use Nero ROM burning software or other burning software as you normally would.

Erasing a CD-RW

There are two methods which you can use to erase a CD-RW.

When the QuattroDrive is connected to a TV/projector, follow the steps below.

1. Insert a CD-RW as described in *Inserting and Removing a CD* on page 6.
2. Select the **ERASE CD-RW** menu item as described in *DISC SETUP* on page 18 and select **YES**.
3. Wait until **ERASE COMPLETED** message appears on the screen and the CD-R/W LED stops flashing before continuing.

When the QuattroDrive is not connected to a TV/projector, follow the steps below.

1. Insert a CD-RW as described in *Inserting and Removing a CD* on page 6.
2. Press the STOP/ESC button on the QuattroDrive to bring up the menu in the LCD panel.
3. Press the PREV and NEXT buttons until **ErASE** appears in the LCD panel.
4. Press the ENTER/PLAY button to enter this menu and **Go** will appear.
5. Press the ENTER/PLAY button to begin erasing the CD-RW and **ErASE** will appear again. Wait until the **End** message or an error message (see *Error Codes* on page 29) appears before continuing.
6. Press the STOP/ESC button to get back to the main menu and again to exit.

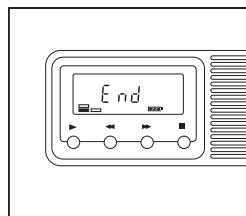
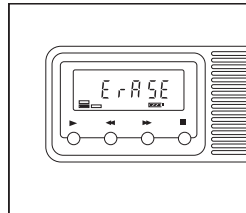

Appendix

Error Codes

This table lists the error codes that are displayed in the PhotoStorage's LCD panel when there is an error.

Error Code	Error Code
01 NO DISC	09 WRITE DVD ERROR
02 NO FLASH CARD	10 CD NOT ERASABLE
03 READ FLASH CARD ERROR	11 ERASE FAIL
04 BUFFER ERROR	12 DEVICE NOT READY
05 CD CLOSED	13 VERIFY READ FLASH ERROR
06 NOT ENOUGH FREE SPACE	14 VERIFY READ DISC ERROR
07 WRITE FAIL	15
08 WRITE PRE-GAP ERROR	16

Quick Start Guide

RESET CVBS NTSC:

1. SETUP ; press SETUP key one time
2. ↓*3 ; press ↓key three time
3. ENTER ; press ENTER key one time
4. ↓*7 ; press ↓key seven time
5. → ; press →key one time
6. ENTER ; press ENTER key one time
7. SETUP ; press SETUP key one time

SET PAL:

1. SETUP ; press SETUP key one time
2. ↓*3 ; press ↓key three time
3. ENTER ; press ENTER key one time
4. → ; press →key one time
5. ↓*2 ; press ↓key two time
6. ENTER ; press ENTER key one time
7. SETUP ; press SETUP key one time

Free Manuals Download Website

<http://myh66.com>

<http://usermanuals.us>

<http://www.somanuals.com>

<http://www.4manuals.cc>

<http://www.manual-lib.com>

<http://www.404manual.com>

<http://www.luxmanual.com>

<http://aubethermostatmanual.com>

Golf course search by state

<http://golfingnear.com>

Email search by domain

<http://emailbydomain.com>

Auto manuals search

<http://auto.somanuals.com>

TV manuals search

<http://tv.somanuals.com>