

SERVICE INSTRUCTIONS

1. Do NOT attempt to repair or adjust any electrical or mechanical functions on this unit. Doing so will void the Warranty.
2. If you need to exchange the unit, please return it in its original carton, with a sales receipt, to the store where you purchased it. If you are returning the unit more than 30 days after the date of purchase, please see the enclosed Warranty.
3. If you have any questions or comments regarding this unit's operation or believe any repair is necessary, please write to our Consumer Service Department or visit our website at www.rivalproducts.com

RIVAL
 c/o THE HOLMES GROUP, INC.
 CONSUMER SERVICE DEPARTMENT
 32 B SPUR DRIVE
 EL PASO, TX 79906

**ONE (1) YEAR LIMITED WARRANTY TERMS AND CONDITIONS
 SAVE THIS WARRANTY INFORMATION**

- A. This Warranty applies only to the original purchaser of this product.
- B. This Warranty applies ONLY to repair or replacement of any supplied or manufactured parts of this product that, upon inspection by The Holmes Group, Inc. authorized personnel, is shown to have failed in normal use due to defects in material or workmanship. The Holmes Group, Inc. will determine whether to repair or replace the unit. This Warranty does not apply to installation expenses.
- C. Operating this unit under conditions other than those recommended or at voltages other than the voltage indicated on the unit, or attempting to service or modify the unit, will render this WARRANTY VOID.
- D. Unless otherwise proscribed by law, The Holmes Group, Inc. shall not be liable for any personal injury, property or any incidental or consequential damage of any kind resulting from malfunctions, defects, misuse, improper installation or alteration of this product.
- E. All parts of this product are guaranteed for a period of 1 year as follows:
 1. Within the first 30 days from date of purchase, the store from which you purchased your product should replace this product if it is defective in material or workmanship (provided the store has in-stock replacement.) * If you intend to assert any claim in connection with the product, please follow the instructions in paragraph F.
 2. Within the first twelve months from date of purchase, The Holmes Group, Inc. will repair or replace the product if it is defective in material or workmanship, subject to the conditions in paragraph G.
- F. If you have any other problem or claim in connection with this product, please write to our Consumer Service Department.
- G. **IMPORTANT RETURN INSTRUCTIONS.** Your Warranty depends on your following these instructions if you are returning the unit to The Holmes Group, Inc.:
 1. Carefully pack the item in its original carton or other suitable box to avoid damage in shipping.
 2. Before packing your unit for return, be sure to enclose:
 - a) Your name, full address with zip code and telephone number,
 - b) A dated sales receipt or PROOF OF PURCHASE,
 - c) A check for return prepaid shipping and handling, and
 - d) The model number of the unit and the problem you are having. (Enclose in an envelope and tape directly to the unit before the box is sealed.)
 3. The Holmes Group, Inc. recommends you ship the package U.P.S ground service for tracking purposes.
 4. All shipping charges must be prepaid by you.
 5. Mark the outside of your package:

RIVAL
 c/o THE HOLMES GROUP, INC.
 32 B SPUR DRIVE
 EL PASO, TX 79906

This Warranty gives you specific legal rights, and you may have other rights which vary from state to state. The provisions of this Warranty are in addition to, and not a modification of, or subtraction from, the statutory warranties and other rights and remedies contained in any applicable legislation. To the extent that any provision of this Warranty is inconsistent with any applicable law, such provision shall be deemed voided or amended, as necessary, to comply with such law.



**Vacuum Food Sealer
 with Built-in Bag Roller**

**Vacuum Food Storage System
 Reference Guide**



www.seal-a-meal.com

©2005 The Rival Company
 A Division of The Holmes Group, Inc.

*Preserves the taste and
 nutritional value of stored foods!*

www.seal-a-meal.com

RIVAL®, the RIVAL Logo®, Seal-a-Meal®, the Seal-a-Meal Logo™, Lock 'n Seal™, Soft Seal™, Minute Marinating Canister™ and Air Out. Freshness In.™ are trademarks of The Holmes Group, Inc. or its subsidiary.

MICROBAN® is a registered trademark of Microban Products Company.

Printed in China

VS120-BL/CD/S/9100060000321

READ AND SAVE THESE INSTRUCTIONS

VS120 / VS120-BL / VS120-CD / VS120-S

IMPORTANT SAFEGUARDS

When using electrical appliances, basic safety precautions should always be followed, including the following:

1. Read the instructions carefully.
2. Do not use the Vacuum Food Sealer on wet or hot surfaces, or near a heat source.
3. Do not operate the Vacuum Food Sealer from the wall mounted storage position.
4. Always use the Vacuum Food Sealer on a level flat surface.
5. Do not immerse any part of the Vacuum Food Sealer, power cord or plug into water or other liquid.
6. To disconnect, unplug the power cord from the electrical outlet. Do not disconnect by pulling on the cord. Always unplug the Vacuum Food Sealer before cleaning.
7. Do not operate the Vacuum Food Sealer with a damaged power cord or plug.
8. Do not operate the Vacuum Food Sealer if it malfunctions or is in any way damaged. If the cord or the machine is damaged, it must be returned to an authorized service center. See warranty for more information.
9. Use only Seal-a-Meal® accessories or attachments.
10. Use the Vacuum Food Sealer only for its intended use.
11. Close supervision is required when this product is used near children.
12. This appliance should not be operated by children.
13. Do not allow the Vacuum Food Sealer to be used as a toy.
14. The Vacuum Food Sealer is not for commercial use.

SAVE THESE INSTRUCTIONS

This appliance is for HOUSEHOLD USE ONLY.

Do not attempt to service this product. Servicing other than cutting blade replacement should be performed by an authorized service representative.



POLARIZED PLUG

This appliance has a polarized plug (one blade is wider than the other). To reduce the risk of electric shock, this plug is intended to fit into a polarized outlet only one way. If the plug does not fit fully into the outlet, reverse the plug. If it still does not fit, contact a qualified electrician.

Do not attempt to modify the plug in any way. If the plug fits loosely into the AC outlet or if the AC outlet feels warm do not use that outlet.

START ENJOYING THE BENEFITS OF YOUR SEAL-A-MEAL® VACUUM FOOD STORAGE SYSTEM...

No more creative packaging to protect your food – stop double wrapping, squeezing or rolling air out of the bag... with one-touch operation it's easy to protect your food from air and moisture loss, the enemies of fresh food. Vacuum sealing locks air out and seals freshness in, preserving the taste and nutritional value of stored foods.

- Save Money – Protect against freezer burn and reduce waste
- Save Time – Prepare and store meals in advance
- Keep food fresh up to 5 times longer

The Seal-a-Meal® Vacuum Food Storage System is a quick and easy way for you to save time and money, while serving healthy food that tastes great!

SEAL-A-MEAL® VACUUM FOOD SEALER WITH SOFT SEAL™ VACUUM CONTROL

The Seal-a-Meal® Vacuum Food Sealer with Soft Seal™ Vacuum Control allows you to easily seal delicate foods without crushing - simply set the vacuum control for regular or delicate foods.

Seal-a-Meal® Vacuum Food Sealer with Soft Seal™ Vacuum Control includes the following:

- Vacuum Food Sealer
- Starter Bag Kit

Visit our fresh new website www.seal-a-meal.com to learn more about how to fully enjoy the benefits of your new Seal-a-Meal® Vacuum Food Storage System:

- New product information and special offers
- Helpful hints and tips
- Seal-a-Meal® recipes
- Purchase bags and accessories

Seal-a-Meal® Vacuum Food Storage System

- A. Vacuum Storage Canister Set
- B. Vacuum Bottle Stoppers
- C. Minute Marinating Canister™
- D. Bag Roll Holder and Cutter
- E. Multi-layer Vacuum Storage Bags and Rolls



Look for these products at your local retailer or visit www.seal-a-meal.com

KNOW YOUR SEAL-A-MEAL® VACUUM FOOD SEALER

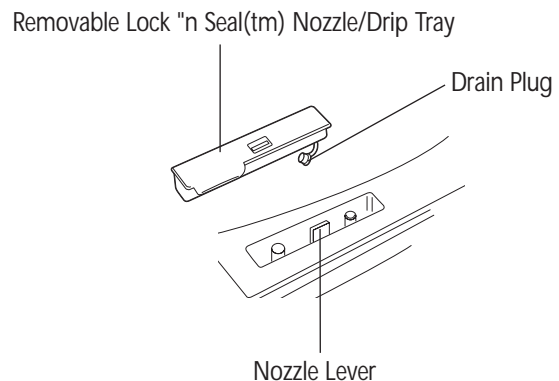
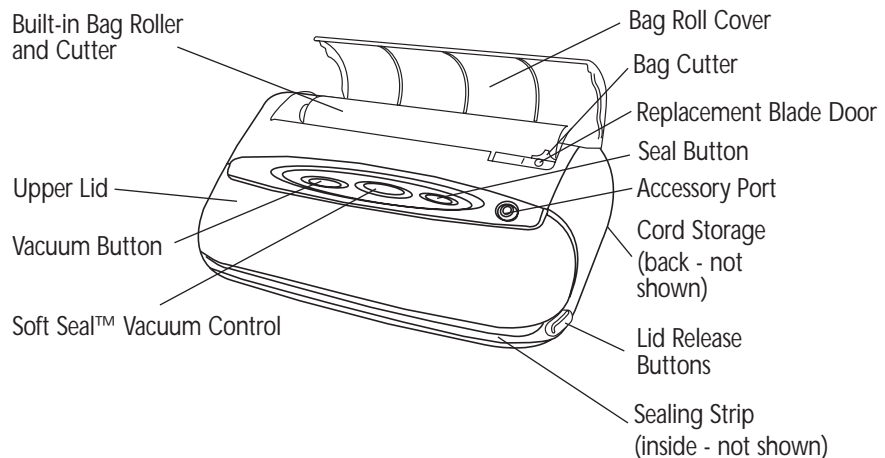

Your Seal-a-Meal® Vacuum Food Sealer can be used with pre-cut bags, bag rolls and accessories.

Seal-a-Meal® multi-layer bags can be frozen, refrigerated, boiled, are microwave safe and reusable. NOTE: DO NOT reuse bags if they have been used to store raw meats, fish, oily foods or have been boiled or microwaved.

HOW TO MAKE A CUSTOM SIZED BAG

1. Open the Bag Roll Cover.

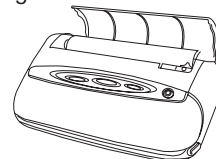

2. Pull out desired bag length (leaving at least 3 inches of extra room, to allow for bag contraction). Hold bag in place and slide Cutting Blade to left or right.

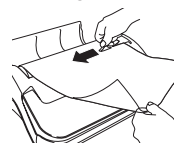

3. Open Lid. Place one end of cut bag on Sealing Strip at least 1/2" above the Sealing Strip.

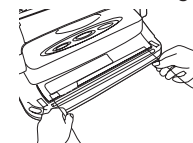

4. Close Lid. Firmly press down on both sides of lid making sure both sides are locked. **Note:** Sealer will not operate if Lid is not properly closed.

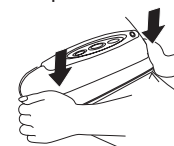

5. Press the Seal Button. Indicator light will turn off when seal is complete.

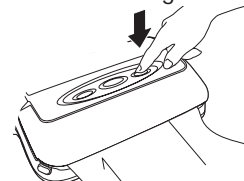

6. Push in Lid Release Buttons to open Lid.

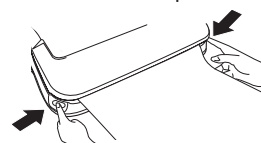

The custom sized bag is ready for vacuum sealing.

HOW TO VACUUM SEAL WITH SEAL-A-MEAL® BAGS

1. Place item to be sealed in pre-cut or custom sized bag, leaving at least 3 inches between contents and top of bag to allow for contraction.
2. Pull Lock 'n Seal™ Nozzle Lever forward to elevate.

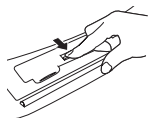

3. Insert Nozzle into bag. Align left edge of bag with Nozzle edge.

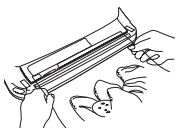

4. Push down Nozzle to secure bag. Make sure bag is straight (with no wrinkles).

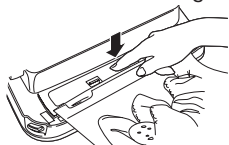

5. Firmly press down on both sides of lid making sure both sides are locked.

Note: Sealer will not operate if Lid is not properly closed.

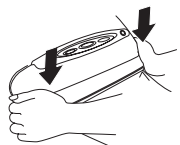

6. Switch Soft Seal™ Vacuum Control to desired setting. Set on Delicate if sealing delicate foods such as muffins or pastries to avoid crushing. Set on Regular for foods such as cheeses or meats. Refer to section on "Using the Soft Seal™ Vacuum Control" for more details.
7. Press the Vacuum Button. Vacuum Indicator Light will turn on. Once all of the air is removed, the unit will automatically switch to the seal mode. When both the Vacuum and Seal Indicator Lights turn off, the bag is vacuum sealed.

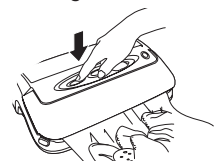

8. Push in Lid Release Buttons to open Lid.



9. Pull Lock 'n Seal™ Nozzle Lever forward to release sealed bag.

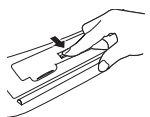

To stop the vacuum process at any time, press the Vacuum Button. You also have the option to bypass the auto seal function to instantly seal the bag and avoid crushing very delicate foods or drawing liquid from the bag. If Soft Seal™ Vacuum Control is set on Delicate simply press the Seal button. This will stop air from being drawn from the bag and seal the bag. If the Soft Seal™ Vacuum Control is set on Regular press the Vacuum Button immediately followed by the Seal Button. This will also stop air from being drawn from the bag and seal the bag.

Warning: Even though the Sealing Strip is not powered when Lid is open, it may still be hot.

Note: The unit has a 30 second cool down period between vacuuming cycles. Unit will not operate during this time.

CAUTION: This Vacuum Food Sealer is not for commercial use. If sealing more than 30 bags or canisters in a row, wait at least 25 minutes before continuing to use your Vacuum Food Sealer.

HOW TO VACUUM SEAL WITH SEAL-A-MEAL® ACCESSORIES

1. Make sure Lid is completely closed and locked. Firmly insert male end of accessory hose into Accessory Port.

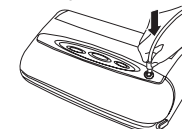

2. Attach other end of hose to Seal-a-Meal® accessory.

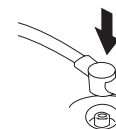

3. Make sure Soft Seal™ Vacuum Control is set on Regular. Press the Vacuum Button. Vacuum Indicator Light will turn on. Once all of the air is removed, the Sealer and Indicator Light will automatically turn off.

To stop the vacuum process at any time, press the Vacuum Button.

USING THE SOFT SEAL™ VACUUM CONTROL

To seal delicate foods such as breads, muffins or strawberries, set the Soft Seal™ Vacuum Control on Delicate.

The chart below is a guideline for the types of foods to be sealed on the Delicate setting. Results will vary depending on preparation, type and quantity of food being sealed and bag size used. For best results place food being sealed in a single layer inside the bag.

Food	Quantity	Bag Size*
Muffins	1	Quart
	4	Gallon
Bread	4 Slices	Quart
	8 Slices	Gallon
Bagels	1	Quart
	4	Gallon
Berries	1 Pint	Quart

* If making a custom sized bag use these dimensions:

Quart = 8" x 11.5" Gallon = 11" x 14.5"

If you are sealing very delicate foods or see that the food is beginning to crush when using the Delicate setting, simply press the Seal Button. This will stop air from being drawn from the bag and instantly seal the bag.

For best results, freeze delicate foods prior to vacuum sealing if using the Regular setting. This will help delicate foods to maintain their shape.

SEALING MOIST FOODS

When sealing moist foods, such as sauces or stews, you have the option to instantly seal the bag and bypass the auto-seal function if you see any liquid being drawn from the bag or whenever you believe the process is complete. If the Soft Seal™ Vacuum Control is set on Delicate simply press the Seal button. If the Soft Seal™ Vacuum Control is set on Regular press the Vacuum Button immediately followed by the Seal Button and the vacuum pump will stop as the bag is sealed.

Hint: For best results liquids should be frozen prior to vacuum sealing. Remove excess juices before sealing whenever possible

HOW TO SEAL BAGS WITHOUT VACUUMING

1. Place item to be sealed in pre-cut or custom sized bag.
2. Place bag at least 1/2" above the Sealing Strip. Make sure bag is straight (with no wrinkles) and close Lid.

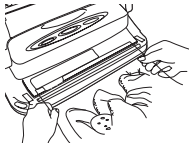

3. Firmly press down on both sides of lid making sure both sides are locked.
Note: Sealer will not operate if Lid is not properly closed.

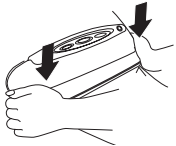

4. Press Seal Button. Indicator Light will turn off when the seal is complete.

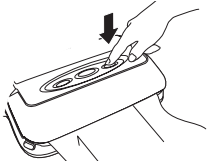

5. Push in Lid Release Buttons to open Lid.



Warning: Even though the Sealing Strip is not powered when Lid is open, it may still be hot.

CAUTION: This Vacuum Food Sealer is not for commercial use. If sealing more than 30 bags or canisters in a row, wait at least 25 minutes before continuing to use your Vacuum Food Sealer.

CARE AND CLEANING

Cleaning your Vacuum Food Sealer

- Always unplug the unit before cleaning.
- Always remove from wall mounted position prior to cleaning.
- Do not immerse in water
- Do not use abrasives to clean the unit.

For White, Black or other non-Chrome finishes:

- Wipe the outside of the unit with a damp cloth and soap.

For Chrome finish:

- Lightly spray a soft, clean cloth with a no wax formula furniture polish.
- Lightly rub the outside surfaces (such as the Lid) to remove fingerprints and restore the finish.

Note: Do not use no wax formula furniture polish on inside of unit or on plastic parts.

CAUTION: Do not immerse the Vacuum Food Sealer in water or other liquid.

Cleaning the Sealing Foam

Use a warm damp cloth with mild dish soap to remove any liquid or food particles that are on the surface of the foam.

Cleaning the Removable Lock 'n Seal™ Nozzle/Drip Tray

The Seal-a-Meal® Vacuum Food Sealer is equipped with a Removable Lock 'n Seal™ Nozzle/Drip Tray to trap any liquid that may be drawn from the bag. The Lock 'n Seal™ Nozzle/Drip Tray contains Microban® antimicrobial product protection, which inhibits the growth of stain and odor causing bacteria and keeps the unit cleaner between cleanings. Normal cleaning practices should be maintained. Does not protect user from food borne illnesses.

1. Pull Lever forward to release Nozzle/Drip Tray.
2. Carefully remove as not to spill any contents.
3. Over sink, open rubber Drain Plug located under the tray at the far end (Do NOT remove the recessed plug) and flush, or soak in warm soapy water (with a mild dish detergent).

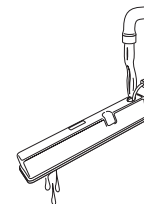

4. Rinse thoroughly and allow to dry.
5. Replace Lock 'n Seal™ Nozzle.

Cleaning the Bags

- Wash bags in warm, soapy water.
- Bags can be washed in the dishwasher if desired. Turn bags inside out and spread them over the top rack.
- Allow bags to dry completely before using.

NOTE: DO NOT reuse bags if they have been used to store raw meats, fish, oily foods or have been boiled or microwaved.

WALL MOUNTING FOR STORAGE

Follow the steps below to wall mount your Seal-a-Meal® Vacuum Food Sealer. This is for storage only; do not operate the Vacuum Food Sealer from the wall. Anchors and screws included.

1. Bore two 1/4" holes (8 3/8" apart) along a straight line on the wall, either vertically or horizontally.
2. Hammer one screw anchor into each hole.
3. Screw the provided screws into the anchors leaving 3/8" head outside of the wall.
4. Hang Sealer on the screw heads.

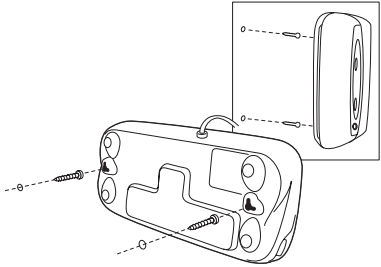

NOTE: Mounting is for storage only. Always clean the Removable Nozzle/Drip Tray prior to storing in the wall mounted position. The Vacuum Food Sealer should not be used while mounted on the wall.

REFILLING THE BAG ROLL

1. Pull out one end of spring loaded bag roll holder.
2. Remove cardboard from empty roll.
3. Slide replacement roll onto holder. Make sure roll is positioned to dispense from the bottom.
4. Place end of holder back into slot.

REPLACING THE BAG CUTTER BLADE

Replacement parts available at www.seal-a-meal.com or Call: 1-800-557-4825.

1. Open bag roll cover.

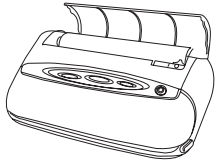

2. With a Phillips head screwdriver, unscrew the Replacement Blade door.

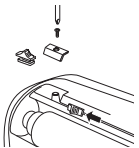

3. Remove the blade door.
4. Replace the old knife blade with the new one.
5. Replace the door.
6. Tightly secure the screw.

CAUTION: Sharp blade.

FOOD STORAGE COMPARISON CHART

Seal-a-Meal® Vacuum Food Storage System Outperforms Conventional Bags & Wraps		
	Storage Time with Conventional Bags & Wraps	Storage Time with Seal-a-Meal® Vacuum Food Storage System*
Freezer		
Beef (Steaks, Roasts)	6 - 12 months	2 - 3 years
Beef (Ground, Stew Meat)	3 - 4 months	1 year
Lean Fish (Cod, Haddock)	4 - 6 months	2 years
Fatty Fish (Salmon, Sea Trout)	2- 3 months	1 year
Pork Chops	4 - 6 months	2 - 3 years
Poultry	6 - 12 months	2 - 3 years
Soups and Sauces	2 - 4 months	1 - 2 years
Vegetables	6 - 9 months	2 - 3 years
Refrigerator		
Cheese	2- 4 weeks	4 - 8 months
Deli Meats	3 - 4 days	7 - 10 days
Fruits (Berries)	1 - 5 days	7 - 14 days
Vegetables	2 - 7 days	7 - 14 days
Pantry		
Cereal	2 -3 months	6 - 12 months
Coffee (Ground)	2 weeks	1 - 2 years
Cookies (Homemade)	1 -2 weeks	3 - 6 weeks
Flour	6 - 8 months	1 - 2 years
Nuts	6 - 8 months	1 - 2 years

* Seal-a-Meal® storage time estimates depend on preparation, quality of food and storage conditions.

HELPFUL HINTS & TIPS

BUY IN BULK

- Buy in bulk and keep it fresh for extended periods of time with Seal-a-Meal® Vacuum Food Storage System.
- Buying in bulk can save you thousands of dollars per year. See this chart below...

BULK FOOD COMPARISON CHART

ITEM	APPROXIMATE STANDARD PKG PRICE /LB	APPROXIMATE BULK PKG PRICE/LB	% SAVINGS PER LB	\$ SAVINGS PER LB	APPROXIMATE POUNDS PURCHASED PER YEAR (4 people)	TOTAL FOOD SAVINGS
Beef(USDA Choice)	\$5.99	\$4.49	25 %	\$1.50	225	\$336.94
Poultry(Chicken Breasts)	\$4.49	\$3.37	25 %	\$1.12	225	\$252.56
Pork	\$4.69	\$3.52	25 %	\$1.17	100	\$117.25
Fish	\$6.99	\$5.59	20 %	\$1.40	50	\$69.90
Cheeses	\$4.49	\$3.14	30 %	\$1.35	125	\$168.38
Fruits	\$4.99	\$3.74	25 %	\$1.25	500	\$623.75
Vegetables	\$1.99	\$1.49	25 %	\$0.50	1,000	\$497.50
Coffee(Beans)	\$8.99	\$5.99	33 %	\$3.00	15	\$45.00
						\$2,111.28

PREPARE MEALS IN ADVANCE

- Prepare large quantities of food, and then divide into smaller portions that work for you and your family. Seal in bags for tomorrow, next week, next month, etc.
- Easily reheat by placing bag directly in boiling water or microwave. To microwave, cut corner of bag to vent, and place on microwave safe dish.

KEEP LEFTOVERS AS FRESH AS THE DAY THEY WERE PREPARED

- After dinner, store leftovers in a Seal-a-Meal® bag, and keep in refrigerator or freezer for a later date.

MARINATE IN MINUTES

- Place food and favorite marinade in bag and vacuum seal for quick marinating.

PERFECT FOR FISHING AND HUNTING

- Use when fishing and hunting to keep your catch fresh until you're ready to prepare them as a meal. Seal-a-Meal® Vacuum Food Storage System prevents freezer burn during extended periods of time in the freezer. Store fish and meats in the freezer immediately after sealing.

NOTE: DO NOT store vacuum sealed fish (smoked or raw) at room temperature or in the refrigerator.

IT'S NOT JUST FOR FOOD

- Store clothing in Seal-a-Meal® bags to prevent potential damage when stored in an attic or closet.
- Protect valuable documents by sealing them in an airtight Seal-a-Meal® bag.
- Place cardboard or some stiff material on both sides of your documents to ensure that they maintain their continuity and shape.
- Keep your belongings clean and dry during boating or camping outings. Simply seal your clothing or materials prior to your trip.

TROUBLESHOOTING

NOTHING HAPPENS WHEN I PRESS THE VACUUM BUTTON

- 1) Make sure the power cord is correctly plugged into the electrical outlet.
- 2) Make sure the power cord is not damaged in any way.
- 3) Make sure the electrical outlet is operative by plugging in another appliance. If it is not, please check the circuit breakers or fuses in your home.
- 4) The unit is equipped with a cool down period between vacuum cycles. Please wait 30 seconds and try again.

AIR IS NOT REMOVED FROM THE BAG

- 1) Make sure the NOZZLE is completely inside the bag (refer to the "How to Vacuum Seal with Seal-a-Meal® Bags" section of the manual to determine if you are doing it correctly).
- 2) Check that the bag is sealed at one end and has no holes. Seal the bag with air in it and put it in water. Apply pressure to the bag. If there are bubbles present there is a leak, and a new bag should be used.
- 3) Verify that the Lock 'n Seal™ Nozzle/Drip Tray is in the drip tray compartment and seated properly (check to make sure the rubber drain plug is properly installed).
- 4) Make sure lid is completely latched into place on both sides.

AIR WAS INITIALLY REMOVED FROM THE BAG, BUT SOME HAS SINCE ENTERED THE BAG

- 1) Check the seal of the bag. There may be a hole or wrinkle that is allowing air to re-enter the bag. Carefully cut the bag open and re-seal it, or use an entirely new bag.
- 2) Make sure there is no moisture or juices from the food present within the bag. You may need to cut open the bag and re-seal it, or use an entirely new bag. Foods with excess liquids should be frozen prior to vacuum sealing. Please refer to the "How to Seal Delicate or Moist Foods" section.
- 3) Make sure there were no food items with sharp edges that may have punctured the bag. If you find a puncture hole seal the item in an entirely new bag.
- 4) Make sure no liquids were drawn to the sealing strip region.

THE BAG MELTS

The sealing strip may have been too hot during the sealing process. Allow the unit to cool for 30 seconds between uses. If the bag continues to melt, allow unit to cool with the lid in the upright position for 1-2 minutes before using.

THE BAG WILL NOT SEAL

See "Air Was Initially Removed from Bag" section above. Make sure no liquids were drawn to the sealing strip region.

Note: In the event the bag does not seal, the seal button can be manually pressed during the vacuum process at any time by pressing the seal button to seal the bag.

MINUTE MARINATING RECIPES

Save time – reduce marinating time from hours to minutes using Seal-a-Meal® Vacuum Food Storage Bags or Minute Marinating Canister™ (sold separately). Marinating in Seal-a-Meal® bags and canisters is a quick and easy way to infuse food with flavor.

ZESTY LIME MARINADE

½ cup of fresh lime juice	2 cloves of garlic- minced
2 tbs. grated lime peel	¼ cup of cilantro – chopped fresh
½ cup of olive oil	2 tsp. of red pepper flakes
Salt & pepper to taste	

In a bowl, stir all ingredients until well blended. This is enough marinade for 2 pounds and works well with chicken, beef, fish or shrimp.

JERK MARINADE

1 white onion, chopped	1 tsp. black pepper
¾ cup of scallions, chopped	2 tsp. of red pepper flakes
2 tsp. of thyme	¼ cup of light soy sauce
3 tsp. of brown sugar	¼ cup of vegetable oil
1 tsp. of allspice	3 tbs. of balsamic vinegar
¼ tsp. of ground nutmeg	¼ tsp. of hot sauce

Combine all ingredients in a food processor. Using the pulse switch or low speed mix ingredients until completely blended. This is enough marinade for 2 pounds and excellent with all food, especially chicken and beef.

GARLIC ROSEMARY MARINADE

¼ cup of fresh rosemary, chopped	½ cup of extra virgin olive oil
5 cloves of garlic, chopped	Salt & pepper to taste
½ cup of fresh lemon juice	

Combine all ingredients in a food processor using the pulse button or the low speed or mix ingredients in a bowl. Do not over process; visible pieces of rosemary should remain. Works best with lamb, chicken or pork.

CITRUS MARINADE

Zest of 1 lemon – reserve the juice	2 tbs. Ginger root – chopped
Zest of 1 orange – reserve the juice	4 garlic cloves
¼ cup of Soy sauce	¼ cup of honey

Combine the juice of the orange and lemon with the soy sauce in a bowl. Add the remaining ingredients into the bowl. Use a whisk to mix all of the ingredients. This is enough marinade for 2 pounds and works best with pork or chicken.

BOURBON MARINADE

½ cup sugar, brown	1 clove of garlic chopped
½ cup Dijon mustard	2 tbs. Worcestershire sauce
½ cup bourbon	1 medium onion chopped
½ cup soy sauce	Pepper to taste

In a bowl whisk the sugar, mustard, bourbon and soy sauce. When well blended stir the remaining ingredients in. This is enough marinade for 2 pounds and can be used for any beef, chicken, pork or shellfish.

SPICY RUM MARINADE

2 Jalapeno pepper- stems and seeds removed	¼ cup tbs. of cilantro, chopped
¾ cup of dark rum	4 cloves of garlic minced
½ cup of lime juice	1 tsp. of red pepper flakes
¼ cup of vegetable oil	

In a food processor or blender puree the pepper, rum and lime juice. Then add the remaining ingredients. This is enough marinade for 2 pounds and works best with shrimp, chicken or beef.

NOTES

Free Manuals Download Website

<http://myh66.com>

<http://usermanuals.us>

<http://www.somanuals.com>

<http://www.4manuals.cc>

<http://www.manual-lib.com>

<http://www.404manual.com>

<http://www.luxmanual.com>

<http://aubethermostatmanual.com>

Golf course search by state

<http://golfingnear.com>

Email search by domain

<http://emailbydomain.com>

Auto manuals search

<http://auto.somanuals.com>

TV manuals search

<http://tv.somanuals.com>