

**SERVICE INSTRUCTIONS**

1. Do NOT attempt to repair or adjust any electrical or mechanical functions on this unit. Doing so will void the Warranty.
2. If you need to exchange the unit, please return it in its original carton, with a sales receipt, to the store where you purchased it. If you are returning the unit more than 30 days after the date of purchase, please see the enclosed Warranty.
3. If you have any questions or comments regarding this unit's operation or believe any repair is necessary, please write to our Consumer Service Department or visit our website at [www.rivalproducts.com](http://www.rivalproducts.com)

RIVAL  
c/o JCS/THG, LLC  
CONSUMER SERVICE DEPARTMENT  
13120 JURUPA AVENUE  
FONTANA, CA 92337

**ONE (1) YEAR LIMITED WARRANTY****SAVE THIS WARRANTY INFORMATION**

- A. This Warranty applies only to the original purchaser of this product.
- B. This Warranty applies **ONLY** to repair or replacement of any supplied or manufactured parts of this product that, upon inspection by JCS/THG, LLC authorized personnel, is shown to have failed in normal use due to defects in material or workmanship. JCS/THG, LLC will determine whether to repair or replace the unit. This Warranty does not apply to installation expenses.
- C. Operating this unit under conditions other than those recommended or at voltages other than the voltage indicated on the unit, or attempting to service or modify the unit, will render this WARRANTY VOID.
- D. Unless otherwise proscribed by law, JCS/THG, LLC shall not be liable for any personal injury, property or any incidental or consequential damage of any kind resulting from malfunctions, defects, misuse, improper installation or alteration of this product.
- E. All parts of this product are guaranteed for a period of 1 year as follows:
1. Within the first 30 days from date of purchase, the store from which you purchased your product should replace this product if it is defective in material or workmanship (provided the store has in-stock replacement.). If you intend to assert any claim in connection with the product, please follow the instructions in paragraph F.
  2. Within the first twelve months from date of purchase, JCS/THG, LLC will repair or replace the product if it is defective in material or workmanship, subject to the conditions in paragraph G.
- F. If you have any other problem or claim in connection with this product, please write to our Consumer Service Department.
- G. **IMPORTANT RETURN INSTRUCTIONS.** Your Warranty depends on your following these instructions if you are returning the unit to JCS/THG, LLC:
1. Carefully pack the item in its original carton or other suitable box to avoid damage in shipping.
  2. Before packing your unit for return, be sure to enclose:
    - a) Your name, full address with zip code and telephone number,
    - b) A dated sales receipt or PROOF OF PURCHASE,
    - c) A check for return prepaid shipping and handling, and
    - d) The model number of the unit and the problem you are having. (Enclose in an envelope and tape directly to the unit before the box is sealed.)
  3. JCS/THG, LLC recommends you ship the package U.P.S ground service for tracking purposes.
  4. All shipping charges must be prepaid by you.
  5. Mark the outside of your package:

RIVAL  
c/o JCS/THG, LLC  
13120 JURUPA AVENUE  
FONTANA, CA 92337

This Warranty gives you specific legal rights, and you may have other rights may vary by jurisdiction. The provisions of this Warranty are in addition to, and not a modification of, or subtraction from, the statutory warranties and other rights and remedies contained in any applicable legislation. To the extent that any provision of this Warranty is inconsistent with any applicable law, such provision shall be deemed voided or amended, as necessary, to comply with such law.

©2005 JCS/THG, LLC

Rival® and The Rival Logo® are trademarks of JCS/THG, LLC.

Printed in China

CN753W/9100140000052  
CN753W05EM1



# Adjustable Can Opener

CN753-W

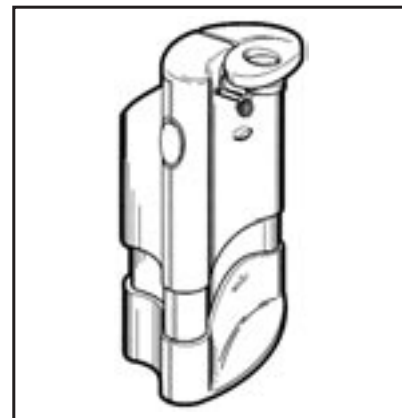

## Owner's Guide

# READ AND SAVE THESE INSTRUCTIONS

## IMPORTANT SAFEGUARDS

When using electrical appliances, basic safety precautions should always be followed, including the following:

1. Read all instructions.
2. To protect against risk of electrical shock, do not put unit in water or other liquid.
3. Close supervision is necessary when any appliance is used by or near children.
4. Unplug from outlet when not in use, before putting on or taking off parts, and before cleaning.
5. Avoid contact with moving parts.
6. Do not operate any appliance with a damaged cord or plug, or after the appliance malfunctions, or is dropped or damaged in any manner. Call Rival customer service. (See Warranty).
7. The use of attachments not recommended or sold by Rival may cause fire, electrical shock or injury.
8. Do not use outdoors.
9. Do not let cord hang over edge of table or counter, or touch hot surfaces, including the stove.
10. Do not open pressurized (aerosol-type) cans or cans of flammable liquids, such as lighter fluids.
11. To disconnect, remove plug from wall outlet.

## SAVE THESE INSTRUCTIONS

This appliance is for **HOUSEHOLD USE ONLY**. This unit never needs lubrication. No user-servicable parts inside. Do not attempt to service this product.

### POLARIZED PLUG



This appliance has a polarized plug (one blade is wider than the other). To reduce the risk of electric shock, this plug will fit into a polarized outlet only one way. If the plug does not fit fully into the outlet, reverse the plug. If it still does not fit, contact a qualified electrician.

Do not attempt to modify the plug in any way. If the plug fits loosely into the AC outlet or if the AC outlet feels warm do not use that outlet.

### ADJUSTABLE FEATURE

1. To open a tall can, place right hand on the top left side of the unit. Push the button on side of the can opener as shown, The can opener will pop-up automatically to its full height. Note: Be sure unit locks in place with a "click."
2. After opening can, hold button in and push down on top of the unit until it locks in place for a compact look.

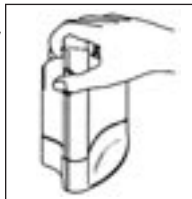

### HOW TO OPEN CANS

1. Plug cord into 120 volt, AC outlet.
2. Raise piercing lever enough to wedge can between cutting blade and feed gear as shown below.
3. Press lever down all the way to pierce lid and start cutting action. "Power pierce" feature: When you press down on the lever, motor will start rotating can for easier piercing.
4. Let go of lever and can opener will continue cutting and will stop automatically when can has been opened. (It is normal for motor to occasionally continue cutting action for a few seconds after lid has been severed).
5. To remove can, grasp it firmly and raise lever. Slide lid from magnet.

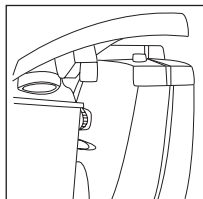

### TO OPEN EXTRA TALL CANS

1. If there is a dent in the rim of the can, open other end.
2. To open cans over 2 lbs., hold top of can opener to stabilize it.
3. Unit will not open rimless cans.

### HOW TO SHARPEN KNIVES

**DO NOT ATTEMPT TO SHARPEN HOLLOW GROUND BLADES OR THOSE WITH SERRATED EDGES.**

1. Be sure knife is clean and free of grease.
2. Place heel of knife into the guide slot located on the back of the can opener. Lightly draw the blade towards you, applying a slight downward pressure. Repeat this procedure four to five times to put on a "factory sharp" edge.

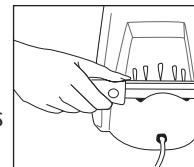

### HOW TO CLEAN BLADE ASSEMBLY

**NEVER SUBMERGE CAN OPENER IN WATER.**

1. Unplug cord. Lift piercing lever to vertical position as shown below. Hold appliance and ease cutting assembly out of case. Wash in hot, soapy water. Rinse and dry. Do not wash in automatic dishwasher.
2. To replace blade assembly, hold piercing lever in vertical position. Insert shaft into key hole. Push in piercing lever all the way. Rotate piercing lever clockwise until it is horizontal. If lever is properly engaged, it cannot be removed from can opener when in horizontal position.

**HINT:** Cutting mechanism may collect food or paper from can labels, and should be washed frequently.

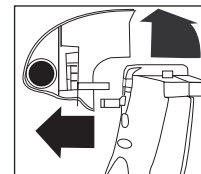

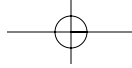

**NOTE**

**NOTE**

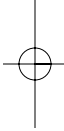
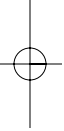

## Free Manuals Download Website

<http://myh66.com>

<http://usermanuals.us>

<http://www.somanuals.com>

<http://www.4manuals.cc>

<http://www.manual-lib.com>

<http://www.404manual.com>

<http://www.luxmanual.com>

<http://aubethermostatmanual.com>

Golf course search by state

<http://golfingnear.com>

Email search by domain

<http://emailbydomain.com>

Auto manuals search

<http://auto.somanuals.com>

TV manuals search

<http://tv.somanuals.com>