

UltraVac™

PATENTED

Controls for Modulating CORAYVAC® Infrared Heating Systems

Installation Manual



⚠ WARNING

Improper installation, adjustment, alteration, service or maintenance can result in death, injury or property damage. Read the Installation, Operation and Service Manual thoroughly before installing or servicing this equipment.

Installation must be done by an electrician qualified in the installation and service of control systems for heating equipment.

Installer

Please take the time to read and understand these instructions prior to any installation. Installer must give a copy of this manual to the owner.

Owner

Keep this manual in a safe place in order to provide your serviceman with necessary information.



Roberts-Gordon LLC
1250 William Street
P.O. Box 44
Buffalo, New York 14240-0044
Telephone: +1.716.852.4400
Fax: +1.716.852.0854
Toll Free: 800.828.7450

www.rg-inc.com
www.radiantheaters.com
www.corayvac.com
www.greenhouse-heater.com

TABLE OF CONTENTS

SECTION 1: Introduction	2	SECTION 7: Variable Frequency Drive Programming	42
1.1 Safety	2	7.1 VFD Parameter Settings For Use With ROBERTS GORDON® ULTRAVAC™	42
1.2 What is ROBERTS GORDON® ULTRAVAC™?.....	2	7.2 Altering VFD Parameters.....	43
1.3 General Requirements	2	SECTION 8: Commissioning The CORAYVAC® System	44
1.4 CORAYVAC® Design Requirements.....	2	8.1 Setting The CORAYVAC® End Burner Vacuum	44
1.5 Example Site Layout.....	3	SECTION 9: Troubleshooting	48
1.6 Check Installation Materials	3	SECTION 10: Replacement Parts	55
1.7 Safety Labels and Their Placement	3	10.1 ROBERTS GORDON® ULTRAVAC™ Controller Replacement Parts.....	56
1.8 Carton Contents	10	10.2 Variable Frequency Drive Replacement Parts	57
1.9 Standard Parts List.....	13	10.3 ULTRAVAC™ BMS Link Controller Replacement Parts.....	58
SECTION 2: Specifications	16	10.4 Repeater Replacement Parts	59
2.1 ROBERTS GORDON® ULTRAVAC™ Controller	16	10.5 Replacement Parts Instructions.....	60
2.2 ULTRAVAC™ BMS Link Controller	16	SECTION 11: The ROBERTS GORDON® ULTRAVAC™ Limited Warranty	62
2.3 NEMA 4 Enclosure (P/N 10080302)	16		
2.4 Repeater	16		
2.5 Temperature Sensors.....	16		
2.6 Line Reactor 480 V / 4 A Output.....	17		
2.7 Variable Frequency Drive (VFD)	19		
SECTION 3: Installation	21		
3.1 Preparation	21		
3.2 Positioning the ROBERTS GORDON® ULTRAVAC™ Controller and Variable Frequency Drive	21		
3.3 Cable Requirements:	22		
3.4 Electrical Installation Requirements of ULTRAVAC™ Controller	22		
3.5 Pump Requirements	23		
3.6 Variable Frequency Drive Requirements.....	23		
3.7 Indoor Sensor Placement	24		
3.8 Outdoor Sensor Placement	24		
3.9 Outside Air Supply	24		
SECTION 4: Typical External Diagrams	25		
SECTION 5: Communications	30		
5.1 Dedicated Phone Line for Central Controller Modem	30		
5.2 RS-485 Converter for Central Controller.....	31		
5.3 TCP/IP Communication Module	32		
5.4 Direct Connect.....	33		
5.5 Communications Between Multiple ROBERTS GORDON® ULTRAVAC™ Controllers.....	35		
SECTION 6: ULTRAVAC™ BMS Link Controller	38		
6.1 ULTRAVAC™ BMS Link Controller Overview	38		
6.2 ULTRAVAC™ BMS Link Controller Requirements.....	39		
6.3 Technical Data	40		
6.4 ULTRAVAC™ BMS Link Controller Programming.....	40		

There are references in this manual to various trademarks. All trademarks mentioned herein, whether registered or not, are the property of their respective owners. Roberts-Gordon LLC is not sponsored by or affiliated with any of the trademark or registered trademark owners, and make no representations about them, their owners, their products or services. Roberts-Gordon LLC is not sponsored by or affiliated with BACnet® or MODBUS®.

© 2011 Roberts-Gordon LLC

All rights reserved. No part of this work covered by the copyrights herein may be reproduced or copied in any form or by any means - graphic, electronic, or mechanical, including photocopying, recording, taping or information storage and retrieval systems - without the written permission of Roberts-Gordon LLC.

TABLE OF FIGURES

Figure 1: ULTRAVAC™ Controller Label Placement	4
Figure 2: ULTRAVAC™ BMS Link Controller Label Placement	5
Figure 3: VFD Label Placement	6
Figure 4: Repeater Label Placement	7
Figure 5: Connected Components	8
Figure 6: Example Site Layout	15
Figure 7: ROBERTS GORDON® ULTRAVAC™ Controller Specifications	18
Figure 8: Variable Frequency Drive Components (Factory pre-wiring shown)	20
Figure 9: Controller Mounting.....	21
Figure 10: Variable Frequency Drive Mounting.....	23
Figure 11: Indoor Sensor Mounting.....	24
Figure 12: Outdoor Sensor Placement.....	24
Figure 13: ROBERTS GORDON® ULTRAVAC™ Central Controller External Wiring	26
Figure 14: ROBERTS GORDON® ULTRAVAC™ Satellite Controller External Wiring	28
Figure 15: Modem Location	30
Figure 16: RS-485 PC Connection.....	31
Figure 17: TCP/IP Communication Module Mounting.....	32
Figure 18: TCP/IP Communication Module Wiring.....	33
Figure 19: 9 Pin Adapter for PC	34
Figure 20: Communications Between Multiple Controllers	35
Figure 21: Repeater External Wiring	36
Figure 22: Repeater Communication Wiring Between Multiple Controllers.....	37
Figure 23: Standard ULTRAVAC™ BMS Link Architecture	38
Figure 24: ULTRAVAC™ BMS Link Controller Schematic	39
Figure 25: Communication Between ULTRAVAC™ BMS Link Controller and Multiple ULTRAVAC™ Controllers ..	41
Figure 26: End Vent Vacuum	45
Figure 27: Possible Damper Couplings' Locations	46
Figure 28: Troubleshooting Flow Chart	49
Figure 29: Troubleshooting Flow Chart - Repeater	53
Figure 30: Troubleshooting Flow Chart - BACnet®	54
Figure 31: ROBERTS GORDON® ULTRAVAC™ Controller Components Diagram	56
Figure 32: Variable Frequency Drive Components Diagram ...	57
Figure 33: ULTRAVAC™ BMS Link Controller Components Diagram	58
Figure 34: Repeater Components Diagram	59



SECTION 1: INTRODUCTION

1.1 Safety



Your Safety is Important to Us!
This symbol is used throughout the manual to notify you of possible fire, electrical or burn hazards. Please pay special attention when reading and following the warnings in these sections.

Installation, service and annual inspection of controller must be done by an electrician qualified in the installation and service of control systems for heating equipment.

Installation, service and annual inspection of heater must be done by a contractor qualified in the installation and service of gas-fired heating equipment.

Read this manual carefully before installation, operation, or service of this equipment.

The heater must be applied and operated under the general concepts of reasonable use.

This appliance is not intended for use by persons (including children) with reduced physical, sensory or mental capabilities, or lack of experience and knowledge, unless they have been given supervision or instruction concerning use of the appliance by a person responsible for their safety.

Children should be supervised to ensure that they do not play with the appliance.

For optimum heater performance and safe heating conditions, inspect and maintain heater(s) before every heating season and as necessary. Also, know and maintain heater clearances to combustibles, see heater Installation, Operation and Service Manual for further details. If you require additional manuals, contact your ROBERTS GORDON® independent distributor or Roberts-Gordon at (716) 852-4400, (800) 828-7450 or at www.rg-inc.com.

1.2 What is ROBERTS GORDON® ULTRAVAC™?

The ROBERTS GORDON® ULTRAVAC™ is a micro-processor based control package designed for modulating control of CORAYVAC® heaters based on outdoor temperatures.

This controller is capable of giving control outputs to one vacuum pump and three heating zones. The controller also features inputs which are used for indoor and outdoor signal condition monitoring.

For the overall view of connected components for

ROBERTS GORDON® ULTRAVAC™, see Page 8, Figure 5.

System status and settings are viewed and altered from a PC (not supplied) running ROBERTS GORDON® ULTRAVAC™ Software.

1.3 General Requirements

⚠ DANGER

Electrical Shock Hazard
Disconnect electric before service.
Controller must be properly grounded to an electrical source.
Failure to follow these instructions can result in death or electrical shock.

The ROBERTS GORDON® ULTRAVAC™ series of controllers are supplied pre-configured for use with ROBERTS GORDON® CORAYVAC® infrared heating equipment only. Failure to comply with the installation instructions and configuration may invalidate the ROBERTS GORDON® ULTRAVAC™ limited warranty. See Page 62, Section 11.

ROBERTS GORDON® ULTRAVAC™ Software requires a PC (not supplied) running Windows® 95 or higher, with a Pentium® class processor and at least 64k of RAM.

The controller, variable frequency drive, burners, repeater, pump and outside air blower must be electrically grounded in accordance with the National Electrical Code® ANSI/NFPA 70 - latest revision.

Before proceeding with the installation of the controller, it will be necessary to check that the following points have been considered:

1.4 CORAYVAC® Design Requirements

CORAYVAC® burners shall be CRV B-6, B-8, B-9, B-10 or B-12 burners.

CORAYVAC® systems designed shall have **minimum** radiant pipe length and 1.5 - 2.0 feet per flow unit of tailpipe length.

-OR-

CORAYVAC® systems designed shall have **recommended** radiant pipe length and 1.2 - 1.5 feet per flow unit of tailpipe length. See the CORAYVAC® Design Manual (P/N 127500NA) for minimum and recommended radiant pipe length.

ERTS GORDON® independent distributor to obtain replacement signs or labels. See *Page 4, Figure 1 through Page 7, Figure 4.*

1.5 Example Site Layout

Page 15, Figure 6 is an example layout for a building where ROBERTS GORDON® ULTRAVAC™ will be used to control the infrared heating systems shown. The layout consists of three zones of ROBERTS GORDON® ULTRAVAC™.

1.6 Check Installation Materials**1.6.1 Switchable Loads**

The controller relays are rated for switching loads no greater than 3 A. The total added current load for all 8 relays must not exceed 25 A.

1.6.2 Control Wiring

Shielded cable (four twisted pairs of stranded 24 AWG minimum wire) is required for use with indoor sensors.

Shielded cable (one twisted pair of stranded 22 AWG minimum wire) is required for the outdoor air sensor, VFD signal wiring, pressure switch and wiring from controller #1 to the PC.

Shielded cable (one twisted pair of stranded 22 AWG minimum wire) is required for RS-485 communications between controllers.

1.6.3 Control Board and Sensor Power

The power supply for all sensors is from the "+32 V" terminal to be found on the board of the controller. Power for the control board is 24 V provided by the relay board.

1.6.4 Programming Details

Every controller is pre-programmed for one pump and up to three heating zones. Use a site layout drawing to identify the heating zones.

1.7 Safety Labels and Their Placement

Product safety signs or labels should be replaced by the product user when they are no longer legible. Please contact Roberts-Gordon LLC or your ROB-

FIGURE 1: ULTRAVAC™ Controller Label Placement

Power/En Marche

Zone 1

Zone 2

Zone 3

Pump/Pompe

Light Label

Rating Plate Label

Front Door Panel (outside)

Electrical Shock Hazard Label

Logo Label

External Wiring Label

Front Door Panel (inside)

Control Board Wiring Label

Electrical Shock Hazard Label

Description	Part Number
Logo Label	91013207
Rating Plate Label	91008005
Light Label	91008007
Control Board Wiring Label	91008004
External Wiring Label	91008003
Shock Hazard label	91008001

FIGURE 3: VFD Label Placement

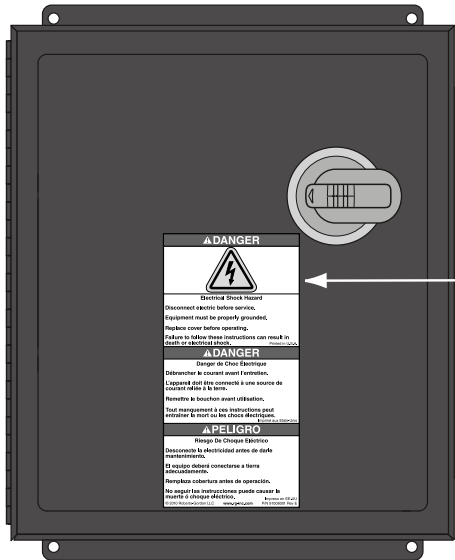

Front Door Panel (outside)

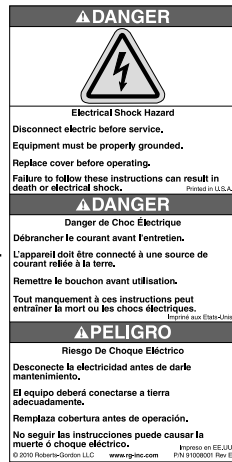

Electrical Shock Hazard Label

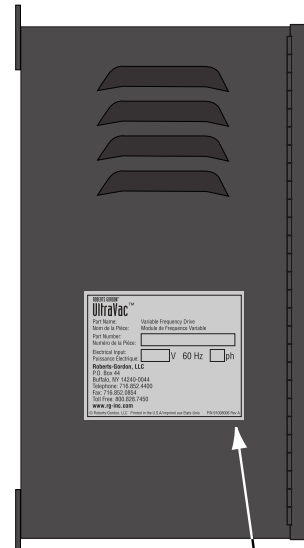

Side Panel (outside)

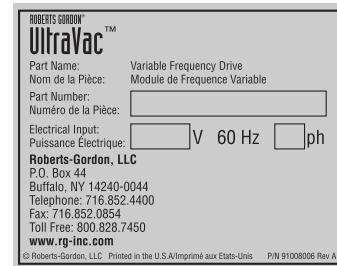

Rating Plate Label

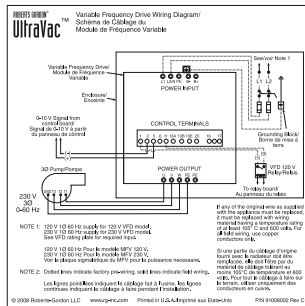

Wiring Diagram Label

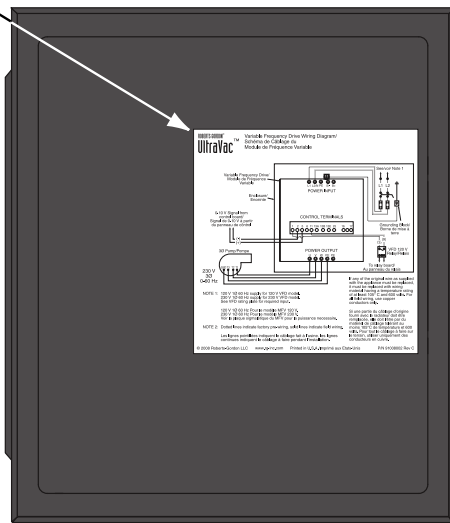

Front Door Panel (inside)

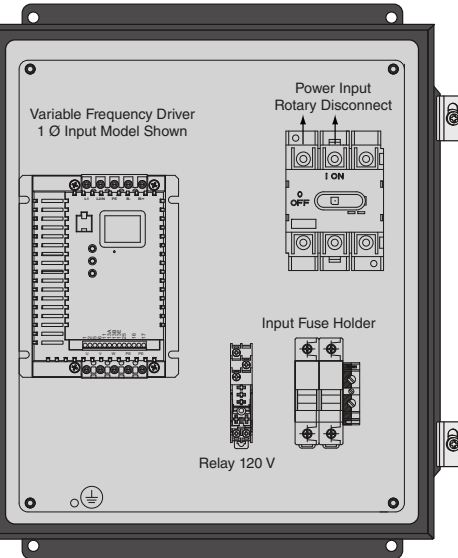

Description	Part Number
Rating Plate Label	91008006
Wiring Label (230 V)	91008004
Wiring Label (460 V)	91008003
Shock Hazard label	91008001

FIGURE 4: Repeater Label Placement

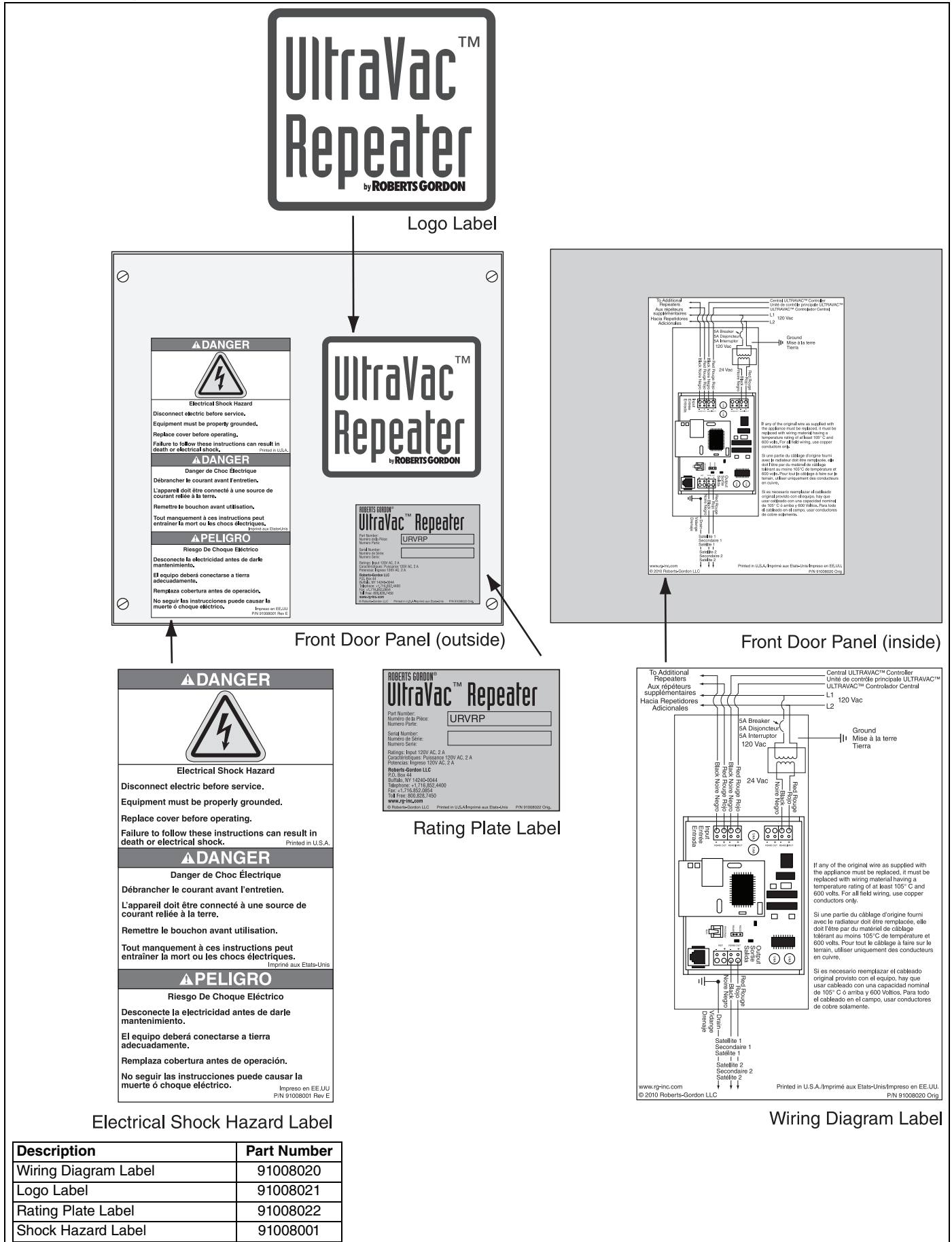
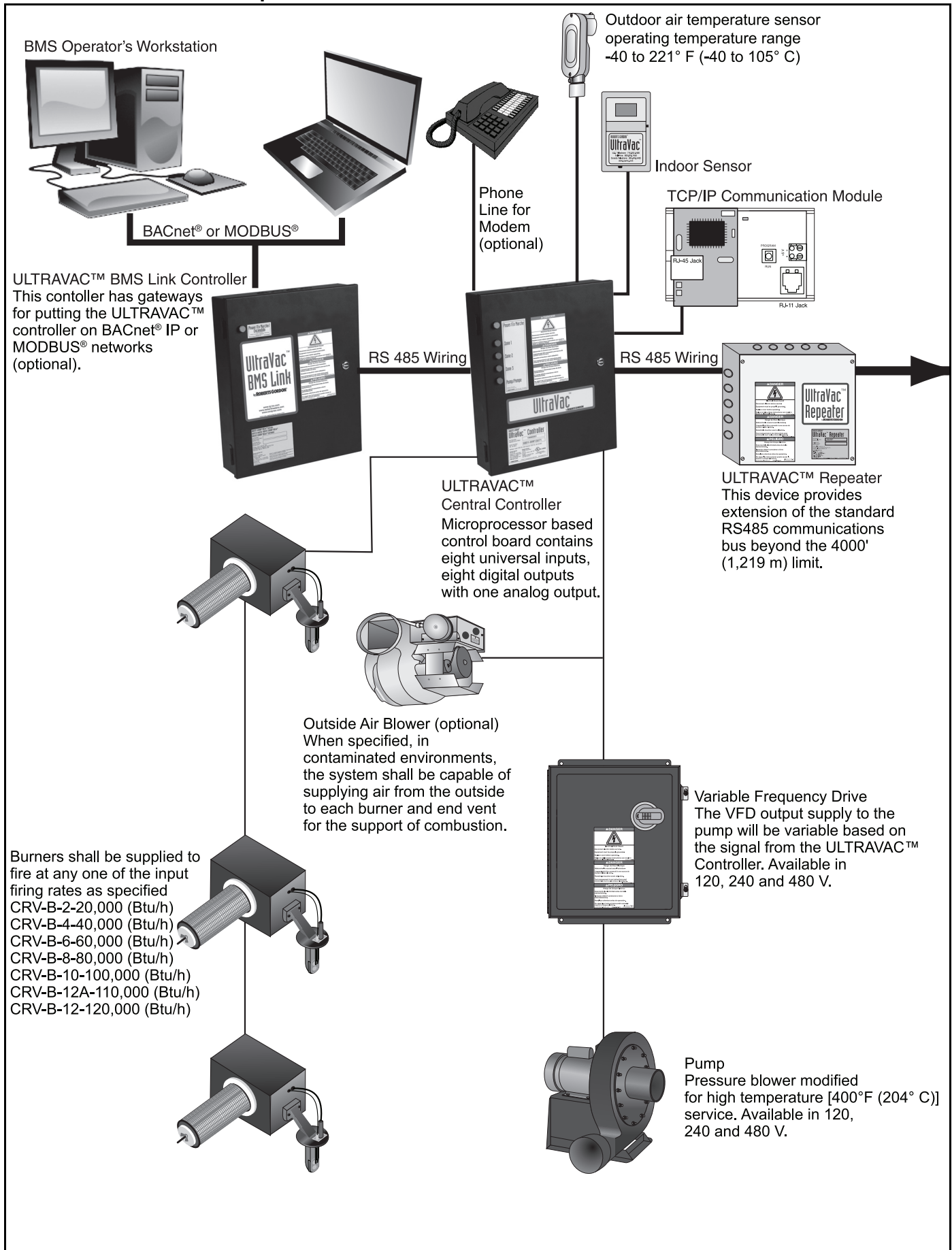
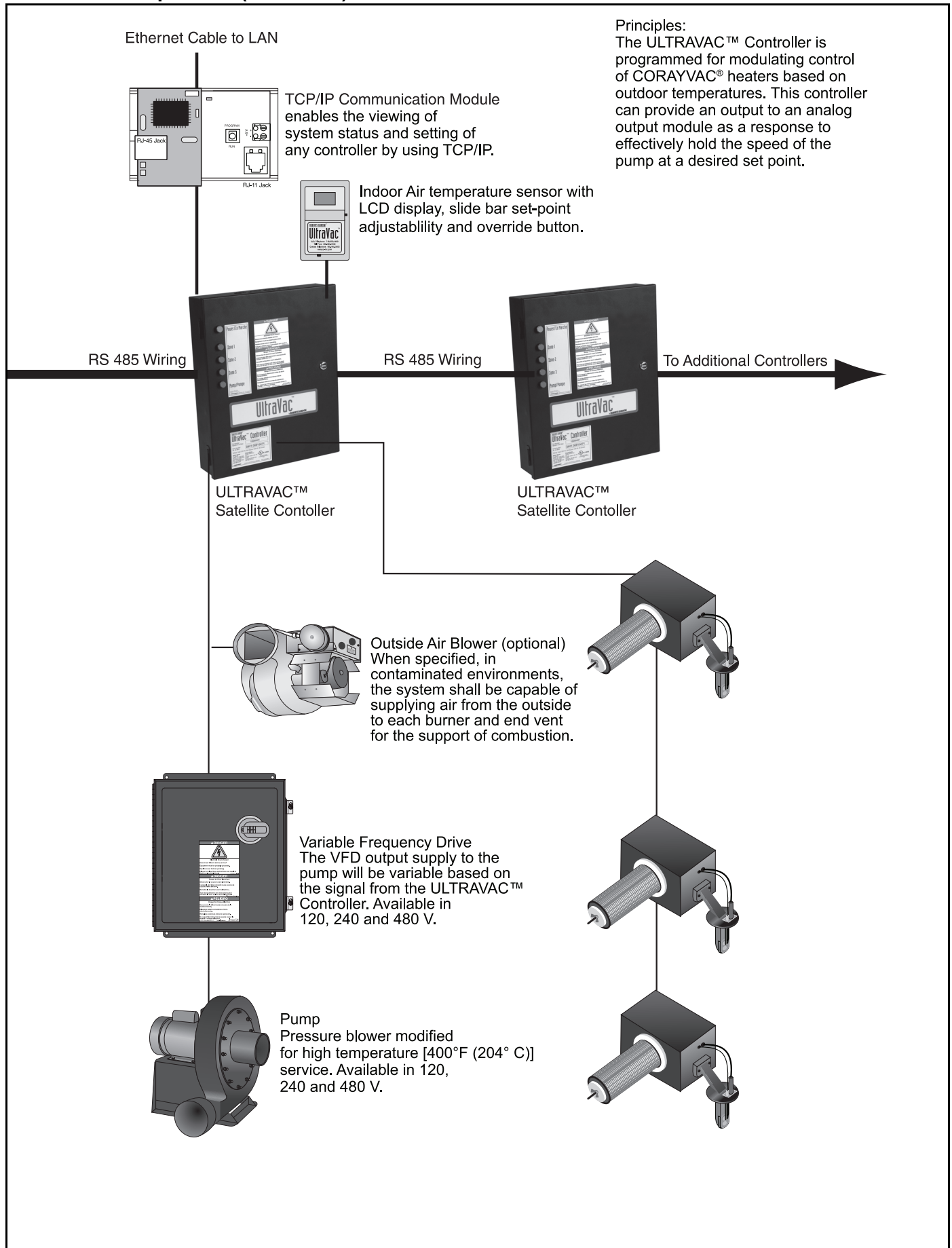

FIGURE 5: Connected Components



Connected Components (continued)



1.8 Carton Contents

URVSC: ULTRAVAC™ Satellite Controller

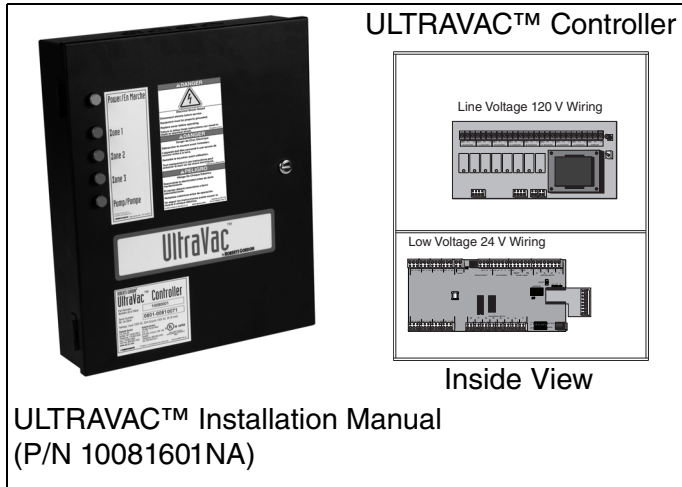

URVCL: ULTRAVAC™ Central Controller with TCP/IP Communication Module

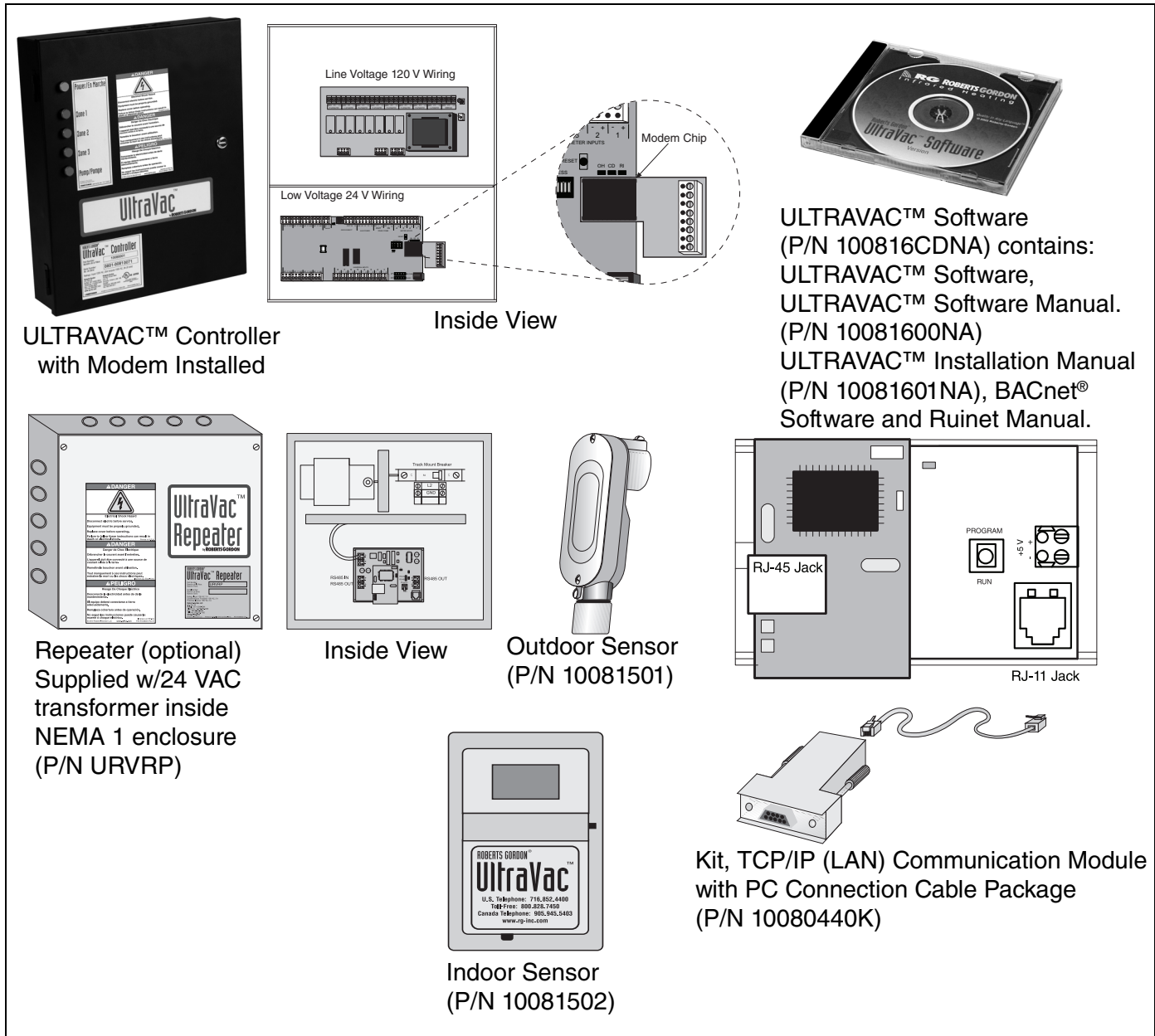

URVCCM: ULTRAVAC™ Central Controller with Modem



ULTRAVAC™ Controller with Modem Installed

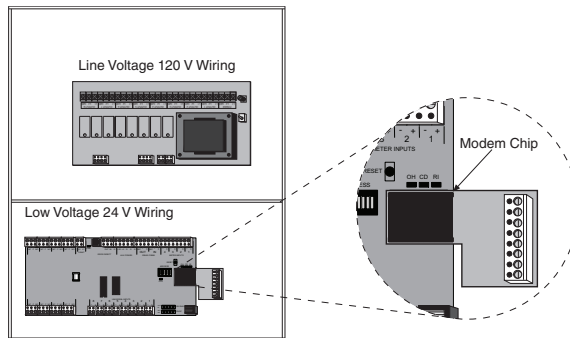

Inside View



ULTRAVAC™ Software (P/N 100816CDNA) contains:
 ULTRAVAC™ Software, ULTRAVAC™ Software Manual.
 (P/N 10081600NA), ULTRAVAC™ Installation Manual
 (P/N 10081601NA), BACnet® Software and Ruinet Manual.

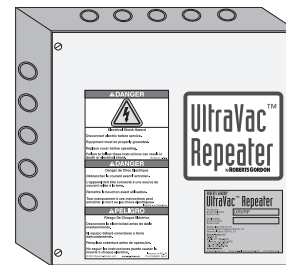

Repeater (optional)
 Supplied w/24 VAC
 transformer inside NEMA 1
 enclosure (P/N URVRP)

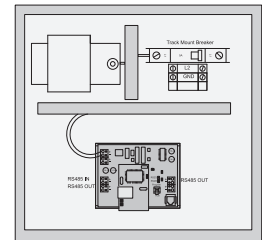

Inside View

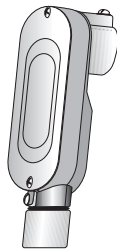
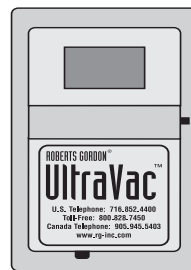
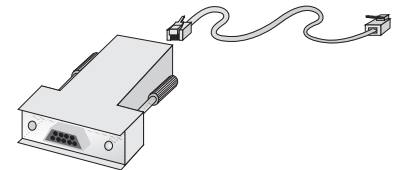
Outdoor Sensor
(P/N 10081501)Indoor Sensor
(P/N 10081502)PC Connection Cable Package
(P/N 10080410)

URVCCR: ULTRAVAC™ Central Controller with RS-485 Converter



ULTRAVAC™ Controller with Modem Installed

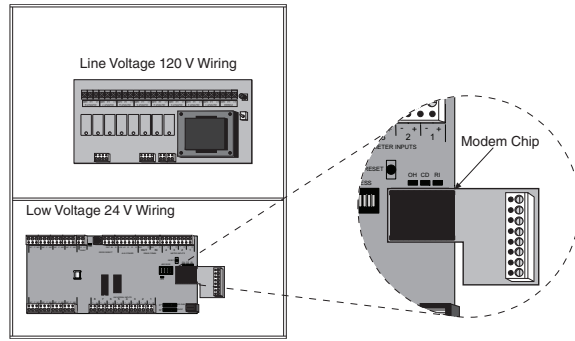

Inside View



ULTRAVAC™ Software (P/N 100816CDNA) contains: ULTRAVAC™ Software, ULTRAVAC™ Software Manual. (P/N 10081600NA), ULTRAVAC™ Installation Manual (P/N 10081601NA), BACnet® Software and Ruinet Manual.

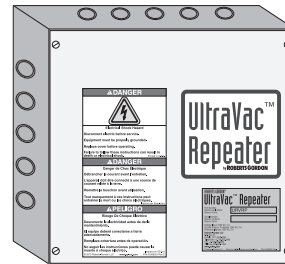

Repeater (optional) Supplied w/24 VAC transformer inside NEMA 1 enclosure (P/N URVRP)

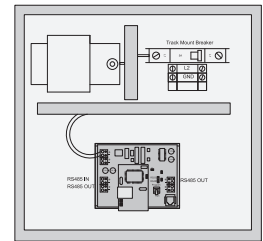

Inside View

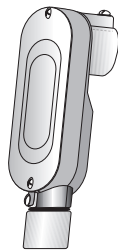

Outdoor Sensor (P/N 10081501)

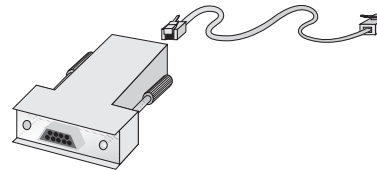

PC Connection Cable Package (P/N 10080410)

RS-485 Converter Package (P/N 10080430)

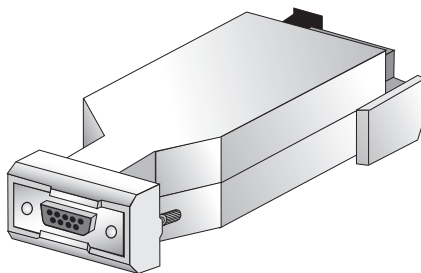

RS-485 Converter

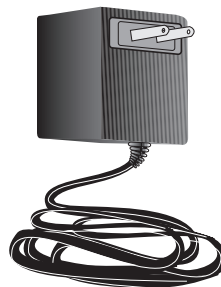

Power Supply

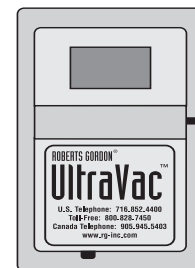

Indoor Sensor (P/N 10081502)

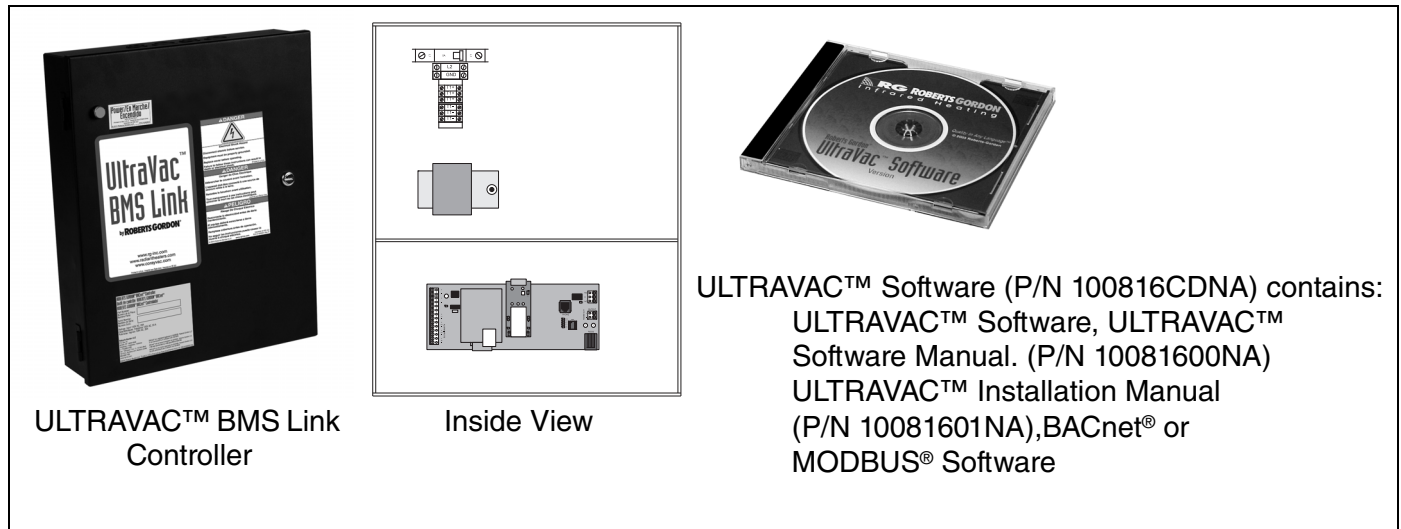
URVBNC: ULTRAVAC™ BMS Link Controller**1.9 Standard Parts List****Table 1: Contents of ULTRAVAC™ Controller and Accessories**

Part No.	Description
URVCLL	ULTRAVAC™ Central Controller (with TCP/IP Communication Module, Software & Manual), Including:
URVSC	Controller, ULTRAVAC™, 1 Pump 3 Zones (Satellite Control & Manual)
10080142	Modem Chip
10080440	TCP/IP Communication Module
10081501	Outdoor Sensor
10080410	PC Connection Cable Package
10081502	Indoor Sensor (sold separately)
URVCCM	ULTRAVAC™ Central Controller (with Modem Chip, Software & Manual), Including:
URVSC	Controller, ULTRAVAC™, 1 Pump 3 Zones (Satellite Control & Manual)
10080142	Modem Chip
1008150	Outdoor Sensor
10080410	PC Connection Cable Package
10081502	Indoor Sensor (sold separately)
URVCCR	ULTRAVAC™ Central Controller (with RS-485 Converter, Software & Manual), Including:
URVSC	Controller, ULTRAVAC™, 1 Pump 3 Zones (Satellite Control & Manual)
10080142	Modem Chip
10080430	RS-485 Converter with 9V Power Supply
1008150	Outdoor Sensor
10080410	PC Connection Cable Package
10081502	Indoor Sensor (sold separately)
URVBNC	ULTRAVAC™ ULTRAVAC™ BMS Link Controller (with Software CD & Manual, IOS Manual)
URVSC	Controller, ULTRAVAC™, 1 Pump 3 Zones (Satellite Control & Manual)

Table 2: Common Components of ROBERTS GORDON® ULTRAVAC™ Controls

Part No.	Description
Variable Frequency Drives*	
VFD751115	Variable Frequency Drive Assembly, .75 HP 115 V 1 Ø Input
VFD75230	Variable Frequency Drive Assembly, .75 HP 230 V 1 Ø Input
VFD20230	Variable Frequency Drive Assembly, 2 HP 230 V 1 Ø Input
VFD75115N4	Variable Frequency Drive Assembly, .75 HP 115 V 1 Ø Input, NEMA 4
VFD75230N4	Variable Frequency Drive Assembly, .75 HP 230 V 1 Ø Input, NEMA 4
VFD75460	Variable Frequency Drive Assembly, .75 HP 480 V 3 Ø Input
VFD75460N4	Variable Frequency Drive Assembly, .75 HP 480 V 3 Ø Input, NEMA 4
VFD20230N4	Variable Frequency Drive Assembly, 2 HP 230 V 1 Ø Input, NEMA 4
VFD20460	Variable Frequency Drive Assembly, 2 HP 480 V 3 Ø Input
VFD20460N4	Variable Frequency Drive Assembly, 2 HP 480 V 3 Ø Input, NEMA 4

*NEMA 4 VFDs are special order items. Call for availability.

NEMA4 Enclosures**

10080302	Enclosure, NEMA 4 for URV Controller
10081510	Enclosure, NEMA 4 for URV Sensor

**Enclosures only. Controller and/or Sensor must be purchased separately.

Related Accessories

10080142	Modem, Plug-In Chip
10080410	Cable Package, PC Connection
10080430	RS-485 Converter with 9 V Power Supply
10080440	TCP/IP Communication Module
10080600	Telephone Sharing Device, 4-Port
10081500	Sensor, Adjustable Indoor, °F, URV
10081501	Sensor, Outdoor, URV
10081502	Sensor, Adjustable Indoor, °C, URV
90602450	Voltage Surge Supresser
90602460	Load Reactor 180 V / 4 A Output
90602470	Line Reactor 180 V / 4 A Input
URVRP	Repeater, URV Communication

FIGURE 6: Example Site Layout

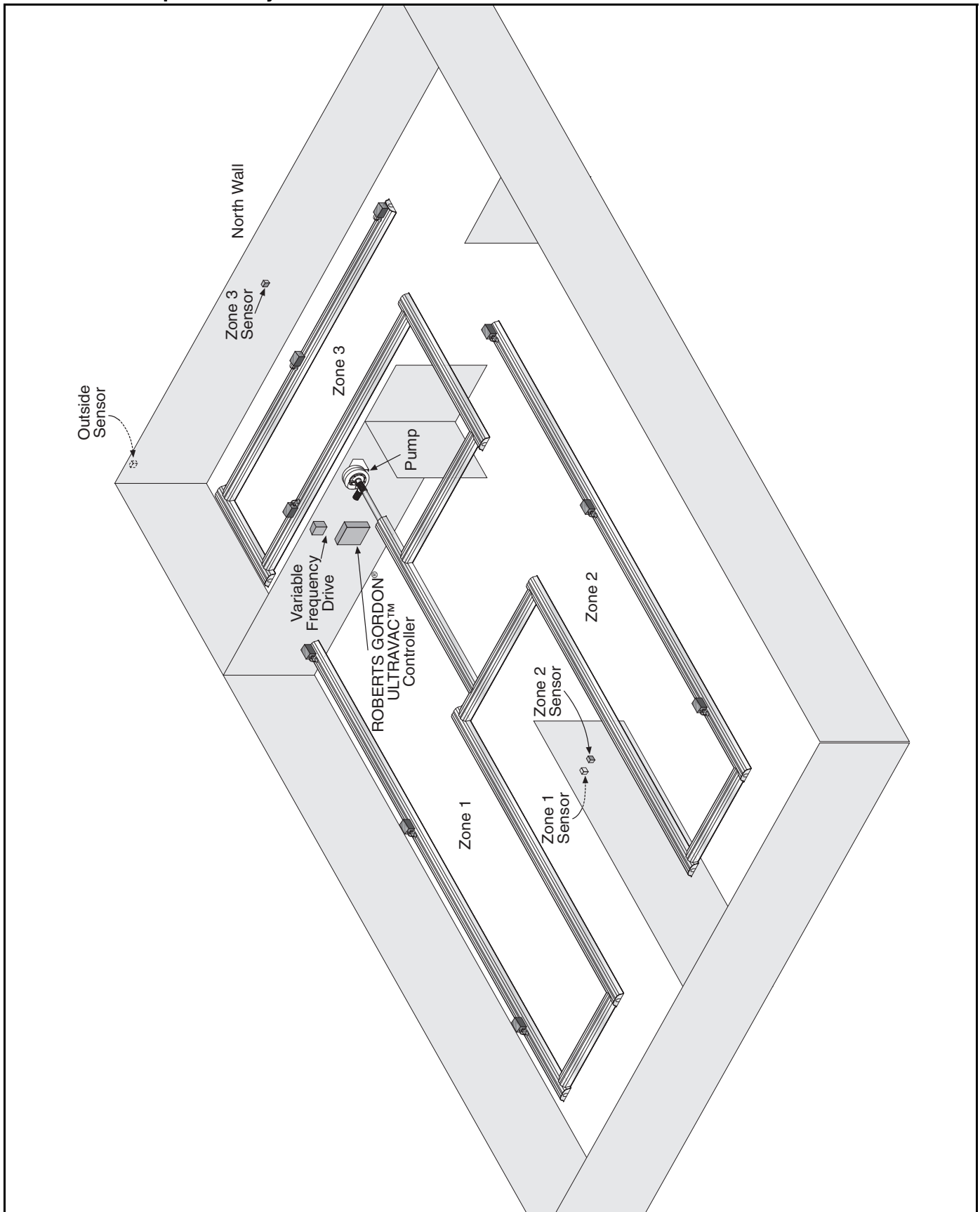

NOTE: Conceptual drawing, not to scale. Venting not shown.

SECTION 2: SPECIFICATIONS**2.1 ROBERTS GORDON® ULTRAVAC™ Controller****2.1.1 Standard Enclosure**

Construction: 16 gauge painted steel, hinged door, removable knockouts provided.

Dimensions: W x H x D
(in): 14.7 x 17.7 x 3.5
(cm): 37.3 x 45.0 x 8.9

2.1.2 Electrical

Power Supply: 120 V (+/- 10%) 1 Ø, 60 Hz
UL Standard: UL 916 / C22.2 No. 205-M1983

Universal Inputs:

Eight Universal Inputs
Thermistor
0-10 Vdc
4-20m A
Resistance
Dry contact

Analog Output:

One Analog Output 0-10 Vdc

Digital Inputs:

Digital Inputs: Timed, dry contact

Digital Outputs:

Eight Digital Output: Single Pole 3 A 120 Vac

Ports:

RS-485 Communications Bus
RS-232 Direct Connect Bus
RS-232 Modem Socket

2.2 ULTRAVAC™ BMS Link Controller**2.2.1 Standard Enclosure**

Construction: 16 gauge painted steel, hinged door, removable knockouts provided.

Dimensions: W x H x D
(in): 14.7 x 17.7 x 3.5
(cm): 37.3 x 45.0 x 8.9

2.2.2 Electrical

Power Supply: 120V (+/-10%) 1 Ø, 60 Hz

Ports:

RS-485 Communications Bus
Ethernet/IP

2.3 NEMA 4 Enclosure (P/N 10080302)

Description: NEMA 4 enclosure is sold separately as an option, for ULTRAVAC™ Controller and ULTRAVAC™ BMS

Link Controller.

Standard enclosures are field mounted inside the NEMA 4 enclosure.

Construction: 14 gauge painted steel, hinged door with 19" (48.3 cm) x (40.6 cm) 16" window.

Dimensions: W x H x D
(in): 24 x 24 x 9
(cm): 61.0 x 61.0 x 22.9

Protection

Rating: NEMA 4, 12

2.4 Repeater**2.4.1 Standard Enclosure**

Construction: Fabricated in accordance with UL specifications from code gauge steel, NEMA 1.

Finish: Austin screw cover boxes standard construction galvanized steel with ANSI 61 gray polyester powder coating.

Dimensions: W x H x D
(in): 12 x 12 x 4
(cm): 30.5 x 30.5 x 10.5

2.4.2 Electrical

Power Supply: 120 V (+/- 10%) 1 Ø, 60 Hz

Ports:

RS-485 Communications Bus
RS-232 Direct Connect Bus

2.5 Temperature Sensors**Indoor Sensor**

Dimensions: W x H x D
(in): 2.75 x 4.5 x 1.15
(cm): 7.0 x 11.4 x 2.9

Power: 32 V DC

Operating Temperature Range:
32° to 158° F (0° to 70° C)

Features: LCD temperature display, setpoint adjustment, override button

Outdoor Sensor (P/N 10081501)

Dimensions: W x H x D
(in): 1.4 x 5.3 x 2
(cm): 3.6 x 13.5 x 5.1

Operating Temperature Range:
-40° to 221° F (-40° to 5° C)

Enclosure: NEMA 4 gasketed aluminum LB housing, ½" threaded connection

NEMA 4 Enclosure for Indoor Sensor (P/N 10081510)

Description: NEMA 4 Enclosure is sold separately as an option. The indoor sensor is field mounted inside the NEMA 4 enclosure. Temperature thermistor and LCD temperature display will not operate properly inside the enclosure. LCD display feature should be disabled and use of the NEMA 4 sensor enclosure will require the use of an outdoor sensor (P/N 10081501) in the space to monitor zone temperature.

Dimensions: W x H x D
(in): 6.3 x 3.6 x 1.8
(cm): 16.0 x 9.1 x 4.6

Construction: Polycarbonate enclosure with clear front cover, 4 screw cover closure. 16 gauge galvanized subpanel.

Protection
Rating: NEMA 4, 4X

Flammability
Rating: UL-94-5V

Voltage Surge Suppressor 277 / 480 V

Construction: NEMA 2X Enclosure

Volts: 277 / 480 V

Frequency: 50/60 Hz

Wiring Size: #12 AWG Standard Wire

2.6 Line Reactor 480 V / 4 A Output

Construction: Fabricated in accordance with UL specifications from code gauge steel, NEMA 1.

Dimensions: W x H x D
(in): 10 x 8 x 8
(cm): 25 x 20 x 20

Rated
Current: 4 A
Volts: 480 V / 3 Ø

Line Reactor 480 V / 4 A Input

Construction: Fabricated in accordance with UL specifications from code gauge steel, NEMA 1.

Dimensions: W x H x D
(in): 10 x 8 x 8
(cm): 25 x 20 x 20

Rated
Current: 4 A
Volts: 480 V / 3 Ø

FIGURE 7: ROBERTS GORDON® ULTRAVAC™ Controller Specifications

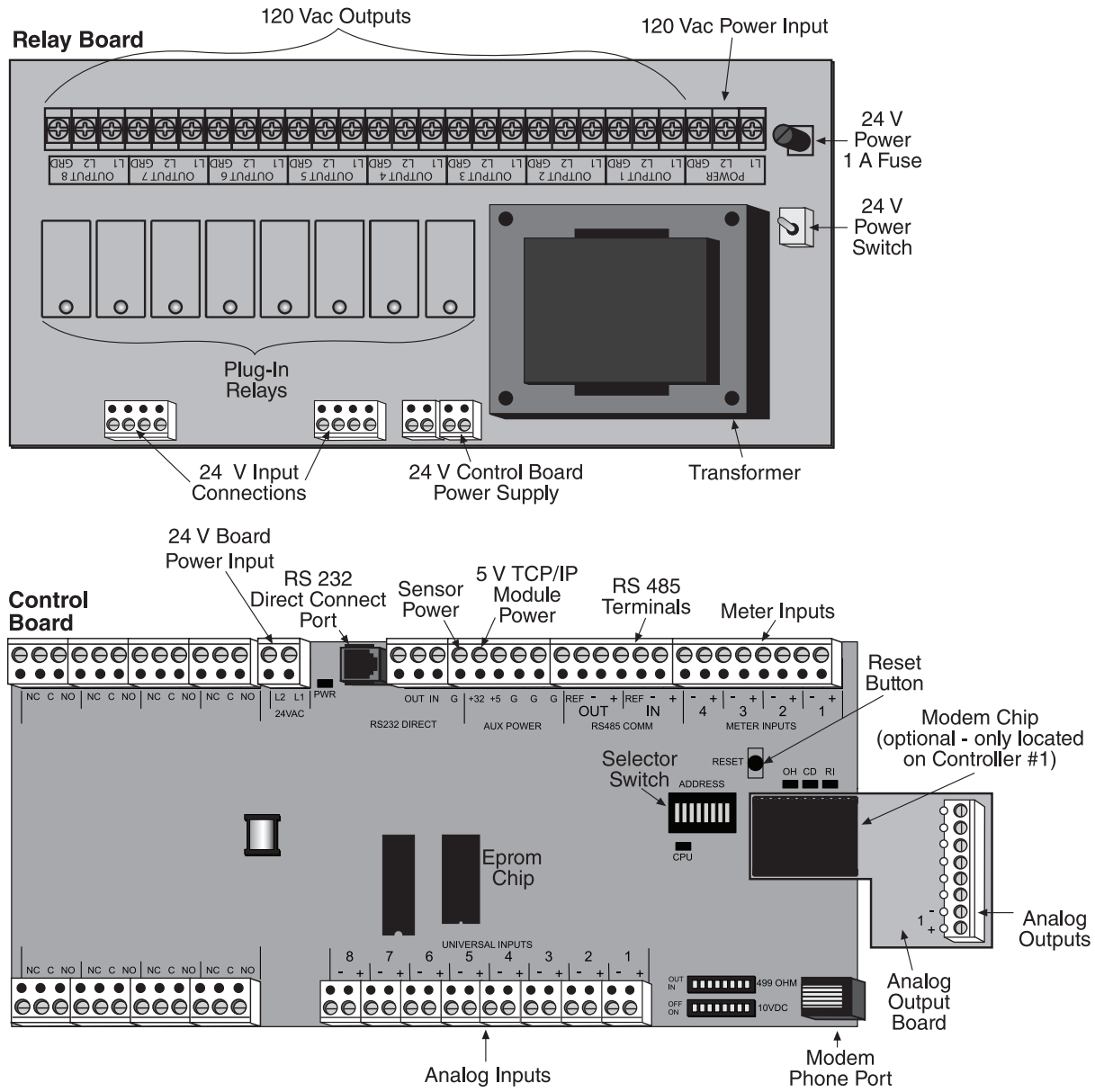

Controller Enclosure

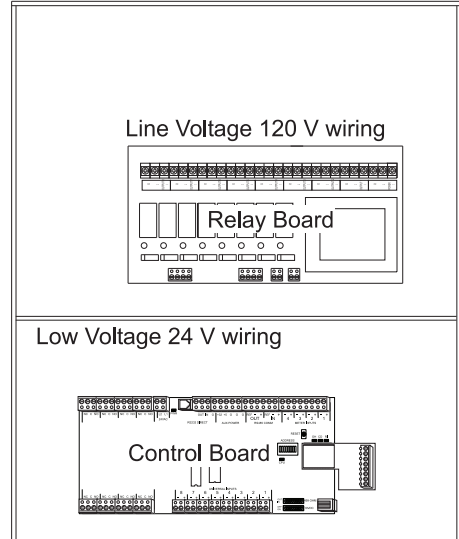

Note:
 To ensure robust control signaling:
 Do not run line voltage wiring through bottom section of enclosure that houses the control board.
 Do not run low voltage wiring through top section of enclosure that houses the relay board.

2.7 Variable Frequency Drive (VFD)

2.7.1 Enclosure

Standard Models

Construction: 14 gauge painted steel, mounting panel included, left-hinged door, vented.

Dimensions: W x H x D
(in): 12 x 14.375 x 8
(cm): 30.5 x 36.5 x 20.3

Protection: UL 50 Type 1, NEMA Type 1

NEMA 4 Models

Description: Drive assembly and components fully factory assembled inside NEMA 4 enclosure. Enclosure dimensions and construction vary by model.

Construction: VFD75115N4, VFD20230N4 and VFD20460N4 enclosures are 16 gauge painted steel, left hinged door, non-vented.

VFD75230N4 and VFD75460N4 enclosures are 14 gauge steel, left hinged door, non-vented.

Dimensions: W x H x D
VFD75115N4 (in): 20 x 16 x 10
(cm): 50.8 x 40.6 x 25.4
VFD75230N4 (in): 14 x 12 x 8
(cm): 35.6 x 30.5 x 20.3
VFD20230N4 (in): 20 x 16 x 10
(cm): 50.8 x 40.6 x 25.4
VFD75460N4 (in): 16 x 14 x 10
(cm): 40.6 x 35.6 x 25.4
VFD20460N4 (in): 20 x 16 x 10
(cm): 50.8 x 40.6 x 25.4

Protection: NEMA 3R, 4, 12, 13

2.7.2 Electrical

Power Output: 230 V, 3 Ø, 0-60 Hz
(for 115 V and 230 V models)

480 V, 3 Ø, 0-60 Hz
(for 480 V models)

Speed Reference Follower: 0-10 Vdc or 4-20 mA

UL Standard: Industrial Controls Equipment

Ambient Operating Temp.:
32° F - 104° F (0° C - 40° C)

.75 HP, 230 V Drive (used with EP-203 pump)

(P/N VFD75230 or VFD75230N4)
Power Input: 208/230 V, 1 Ø, 50-60 Hz
Input Voltage Tolerance: +/- 10%
Amps: 6.9/6.0 A

1 HP, 120 V Drive (used with EP-203 pump)

(P/N VFD75115 or VFD75115N4)
Power Input: 120 V, 1 Ø, 50-60 Hz
Input Voltage Tolerance: +/- 10%
Amps: 16.6 A

2 HP, 230 V Drive (used with EP-303 pump)

(P/N VFD20230 or VFD20230N4)
Power Input: 208/230 V, 1 Ø, 50-60 Hz
Input Voltage Tolerance: +/- 10%
Amps: 18.4/16.0 A

1 HP, 460 V Drive (used with EP-203 pump)

(P/N VFD75460 or VFD75460N4)
Power Input: 400/480 V, 3 Ø, 50-60 Hz
Input Voltage Tolerance: +/- 10%
Amps: 3.0/2.5 A

2 HP, 460 V Drive (used with EP-303 pump)

(P/N VFD20460 or VFD20460N4)
Power Input: 400/480 V, 3 Ø, 50-60 Hz
Input Voltage Tolerance: +/- 10%
Amps: 4.8/4.0 A

FIGURE 8: Variable Frequency Drive Components (Factory pre-wiring shown)

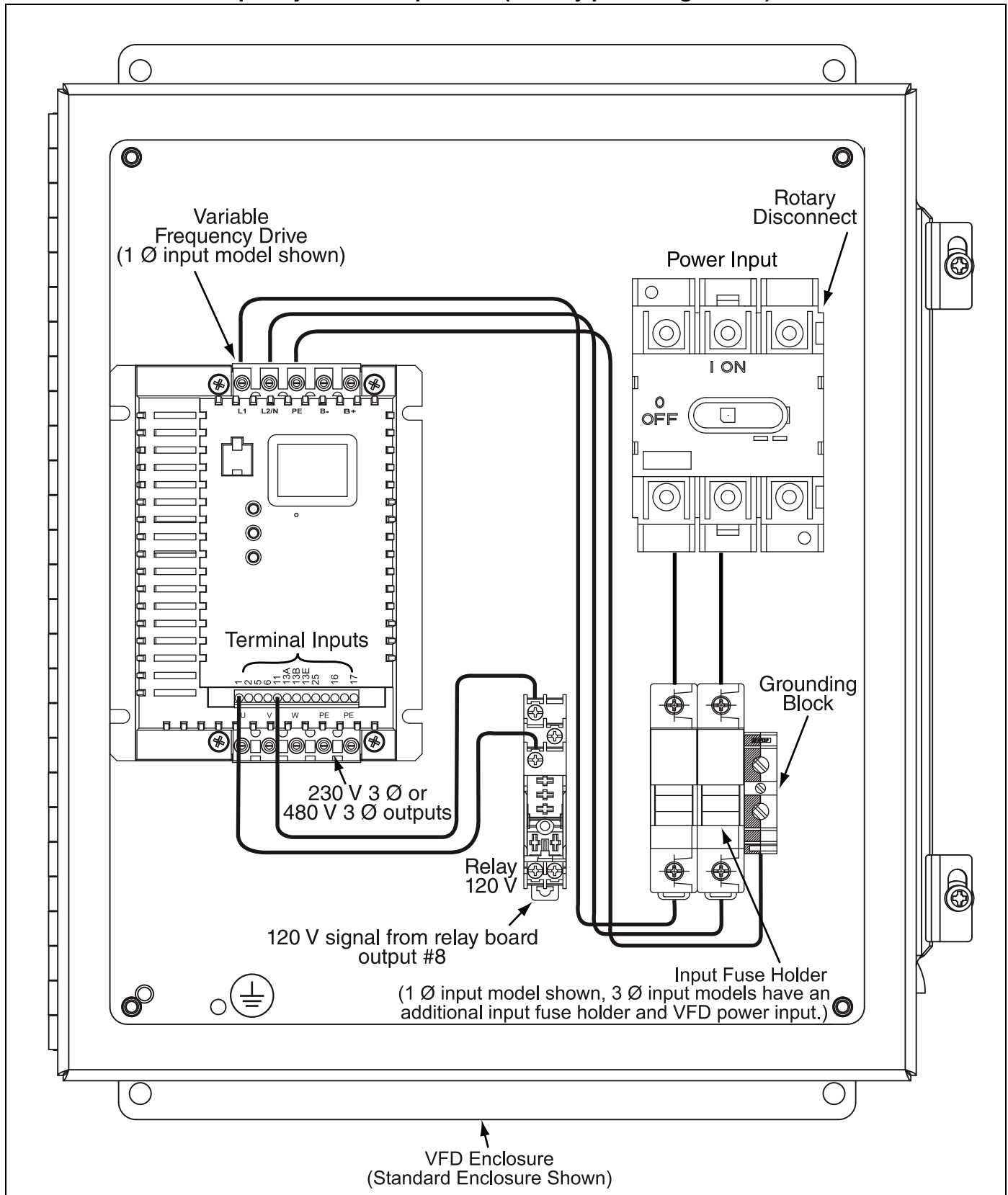

SECTION 3: INSTALLATION

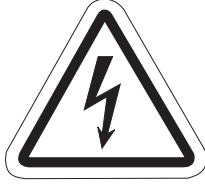
⚠ DANGER

Electrical Shock Hazard
Disconnect electric before service.
Controller must be properly grounded to an electrical source.
Failure to follow these instructions can result in death or electrical shock.

Installation of the ROBERTS GORDON® ULTRAVAC™ Controller and the associated external electrical wiring must be done by an electrician qualified in the installation of control systems for heating equipment.

3.1 Preparation

Before installing the controller, observe the following:

3.1.1 Ensure that you have a copy of the site layout for the project that clearly identifies the separate zones.

3.1.2 Familiarize yourself with the Controller and Variable Frequency Drive component names and locations. See Page 18, Figure 7 and Page 20, Figure 8.

3.2 Positioning the ROBERTS GORDON® ULTRAVAC™ Controller and Variable Frequency Drive

3.2.1 Choose a mounting location for the controller. For serviceability, it is convenient to mount the controller and variable frequency drive at occupant level in the vicinity of the pump. The variable frequency drive should not be more than 50' (15 m) from the pump.

Do not mount controller or VFD outdoors. VFD must not be installed where subjected to adverse conditions such as: combustible, oily, or hazardous vapors or dust; excessive moisture or dirt; vibration. To avoid damage from possible drips, do not mount controller or VFD directly beneath pump. Models with NEMA 4 rated enclosures will withstand exposure to dust, dirt and water.

VFD should be mounted in locations where the

maximum ambient temperature does not exceed 104°F (40°C). Avoid installing the VFD in mezzanines, direct sunlight, or near external heat sources because these locations usually have unpredictable temperature rises.

Note that the maximum distance from the controller to any sensor is 300' (120 m). For longer distances, larger gauge wire may be needed (Consult your local distributor). For multiple controllers, maximum length of communication wire from the first controller to the last is 4000' (1219 m) without the use of a repeater. A repeater is available for wire length greater than 4000' (1219 m). See Page 36, Section 5.5.1. Wiring between the RS-485 converter to the controller should not be more than 400' (122 m) in length. See Page 31, Section 5.2.

3.2.2 Position the controller and VFD at occupant level for ease of service. To avoid electrical interferences with communications bus, do not mount VFD directly next to controller. Allow 2' (.6 m) minimum between controller and VFD. If the VFD is more than 100' (150 m) from the pump a load reactor (P/N 90602460) must be used.

FIGURE 9: Controller Mounting

(Standard enclosure only, NEMA 4 enclosure mounting varies)

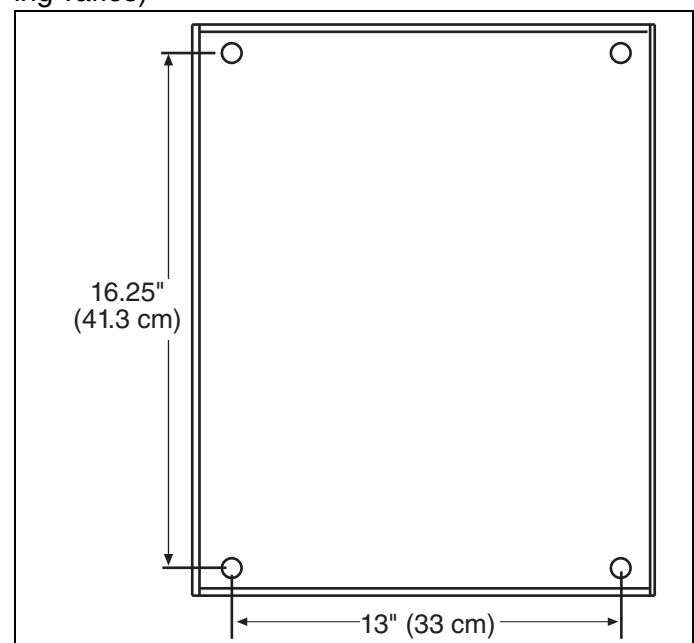

3.3 Cable Requirements:

As per individual building specification for class of cable to be used. Use copper conductors only.

3.3.1 ULTRAVAC™ Controller

Below is the recommended cable for the various connections for ULTRAVAC™ Controller:

- **Line Power Supply**
The power connection should be made with cable, size 14 AWG.
- **Eight Digital Output (Relays)**
The control connection for load of each individual relay should be made with cable, size 16 AWG.
- **Digital Input**
The wiring connection for the pressure switch should be unshielded cable, size 18 AWG.
- **Indoor Sensor Cable**
 - a) Shielded cable - Four twisted pairs of stranded, 24 AWG minimum or equivalent Madison Cable #08CFJ00004; Belden #9681.
 - b) Unshielded cable - Four twisted pairs of stranded, 24 AWG minimum or equivalent AMP#219538, #219513; Belden#1585, #1583A.
- **Outdoor Sensor Cable**
Shielded cable - One twisted pair of 22 AWG minimum or equivalent Belden #8451, #1503A; General Cable #C2514.
- **Communications between Multiple Controllers (RS-485)**
One twisted pairs of 18 AWG minimum or equivalent shield cable; Belden #1902, General Cable #C1670A.

3.3.2 ULTRAVAC™ BMS Link Controller

Below is the recommended cable for the various connections for ULTRAVAC™ BMS Link Controller:

- **Line Power Supply**
The power connection should be made with cable, size 18 AWG.
- **Communications between ULTRAVAC™ BMS Link and Multiple Controllers**
One twisted pair of 22 AWG minimum or equivalent shield cable; Belden #1902, General Cable #C1670A.

3.3.3 Variable Frequency Drive (VFD)

Below is the recommended cable for the various connections for VFD:

- **Line Power Supply**
Input Wire Size Requirements
- | | |
|------------------------|-----------|
| VFD P/N | Wire Size |
| VFD75115 or VFD75115N4 | 12 AWG |

VFD75230 or VFD75230N4	14 AWG
VFD20230 or VFD20230N4	12 AWG
VFD75460 or VFD75460N4	14 AWG
VFD20460 or VFD20460N4	14 AWG

- **VFD(0-10 Vdc) Speed Reference Control Wiring**
Shielded cable - one twisted pair of 22 AWG minimum or equivalent Belden #8451, #1503A; General Cable #C2514.

3.3.4 Repeater

Below is the recommended cable for the various connections for the repeater:

- **Line Power Supply**
The power connection should be made with cable, size 18 AWG.
- **RS485 Communications**
Multiple repeaters may be installed on the main loop and all communications cable should be made with shielded cable one twisted pair of 18-22 AWG.

3.4 Electrical Installation Requirements of ULTRAVAC™ Controller

⚠ DANGER



Electrical Shock Hazard

Disconnect electric before service.

Controller must be properly grounded to an electrical source.

Failure to follow these instructions can result in death or electrical shock.

- ULTRAVAC™ Controller must be feeding from a local fused isolator for a total amperage not exceeding **25 A**.
- Eight digital outputs for each individual relay must not exceed **3 A**.

NOTES:

- **The total added current load for each individual relay must not exceed 3 A.**
- **The total added current load for all 8 relays must not exceed 25 A.**

3.5 Pump Requirements

The pump is powered directly from the Variable Frequency Drive (VFD). The VFD will be energized via an output from the relay board switched through a designated relay.

3.6 Variable Frequency Drive Requirements

The VFD must be powered separately from the control enclosure. The 230 V drive power supply must be 230 V, 50-60 Hz, 1 Ø. The 120V drive power supply must be 120 V, 50-60 Hz, 1 Ø. The 480 drive power supply must be 480 V, 50-60 Hz, 3 Ø. See *Page 19, Section 2.7* for additional details. The VFD on/off switching is done by an output on the relay board. The 0-10 V signal from the ULTRAVAC™ controller enclosure wired into VFD input relays 5 and 2 (see *Page 26, Figure 13 through Page 28, Figure 14*) will dictate the speed of the pump. The VFD output supply to the pump is 230 V 3 Ø 0-60 Hz for 115 V and 230 V models and is 480 V, 3 Ø, 0-60 Hz for 480 V models. The frequency of the output supply signal to the pump will be varied based on the 0-10 V signal from the control enclosure. See *Page 21, Section 3.2* for additional installation requirements.

FIGURE 10: Variable Frequency Drive Mounting

(Standard enclosures only, NEMA 4 enclosure mounting varies by model)

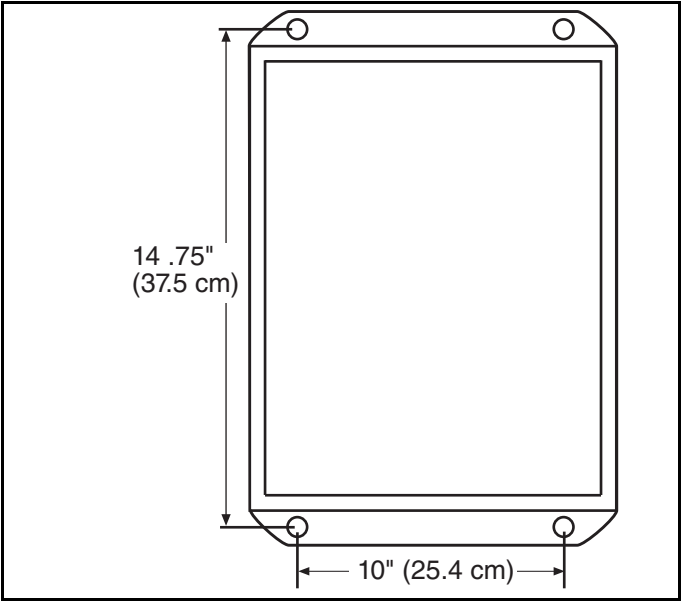

3.7 Indoor Sensor Placement

The sensor measures the air temperature in the building. It is important that the sensor is located in an area within the heated zone at occupant level. For the most accurate results, sensors should be mounted on an inside wall, away from any air vents or other sources of heat and cold. In order to avoid short system cycles and inaccurate temperature readings, do not mount sensors under the first section of radiant tube (first 10' (3 m) section of tube after the burner), in direct sunlight or in the path of other sources of radiant heat. The sensors are suitable for direct surface mounting or 4" (10.2 cm) x 2.13" (5.4 cm) junction box mounting.

FIGURE 11: Indoor Sensor Mounting

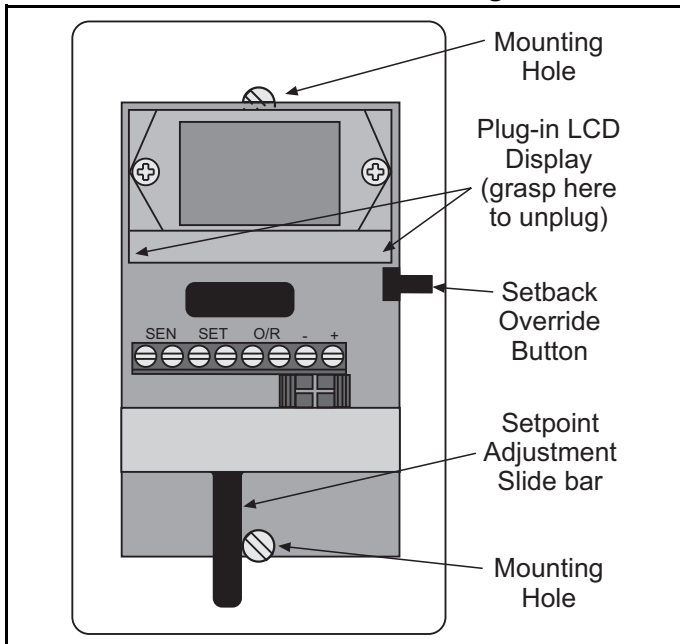

3.7.1 Indoor Sensor Mounting

Remove the cover of the sensor by the two 1/16" allen screws, located in the lower corners of the cover. To gain access to the top mounting hole, remove the plug-in LCD display. To remove the LCD display, grasp the green plug-in board at the lower corners and gently pull the board away from the sensor back plate. See Page 24, Figure 11. After removing the plug-in LCD display from its socket, secure the sensor to the wall or junction box using the screws provided. Replace the plug-in LCD display and secure the cover with the two 1/16" allen screws.

Wiring from 32 V terminals on the controller to sensor power terminals "+" and "-" is polarity sensitive. Reversing polarity may cause sensor

or control board damage. Refer to Page 26, Figure 13 and Page 28, Figure 14 for wiring details.

3.8 Outdoor Sensor Placement

The outdoor sensor measures air temperature outside the building. It is important that the sensor is located on the outside of the building on the north facing wall. Failure to mount the sensor on the north facing wall will result in artificially high temperature readings. If possible, locate the sensor high under an eave to prevent incorrect readings from direct sunlight and damage due to the elements.

FIGURE 12: Outdoor Sensor Placement

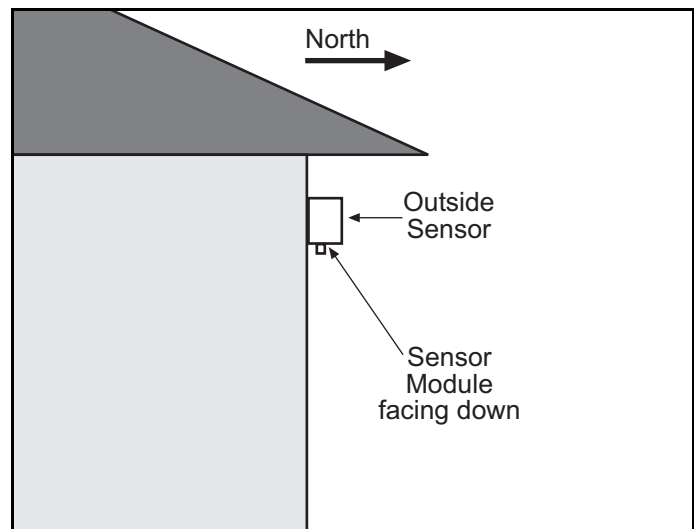

Mount the outside sensor with the sensor module facing down to prevent accumulation of dirt or water.

3.9 Outside Air Supply

If an outside air blower is to be used, See Page 26, Figure 13 for external wiring diagrams. See Page 22, Section 3.4 for current load.

SECTION 4: TYPICAL EXTERNAL DIAGRAMS

⚠ DANGER

Electrical Shock Hazard
Disconnect electric before service.
Controller must be properly grounded to an electrical source.
Failure to follow these instructions can result in death or electrical shock.

FIGURE 13: ROBERTS GORDON® ULTRAVAC™ Central Controller External Wiring

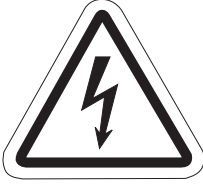
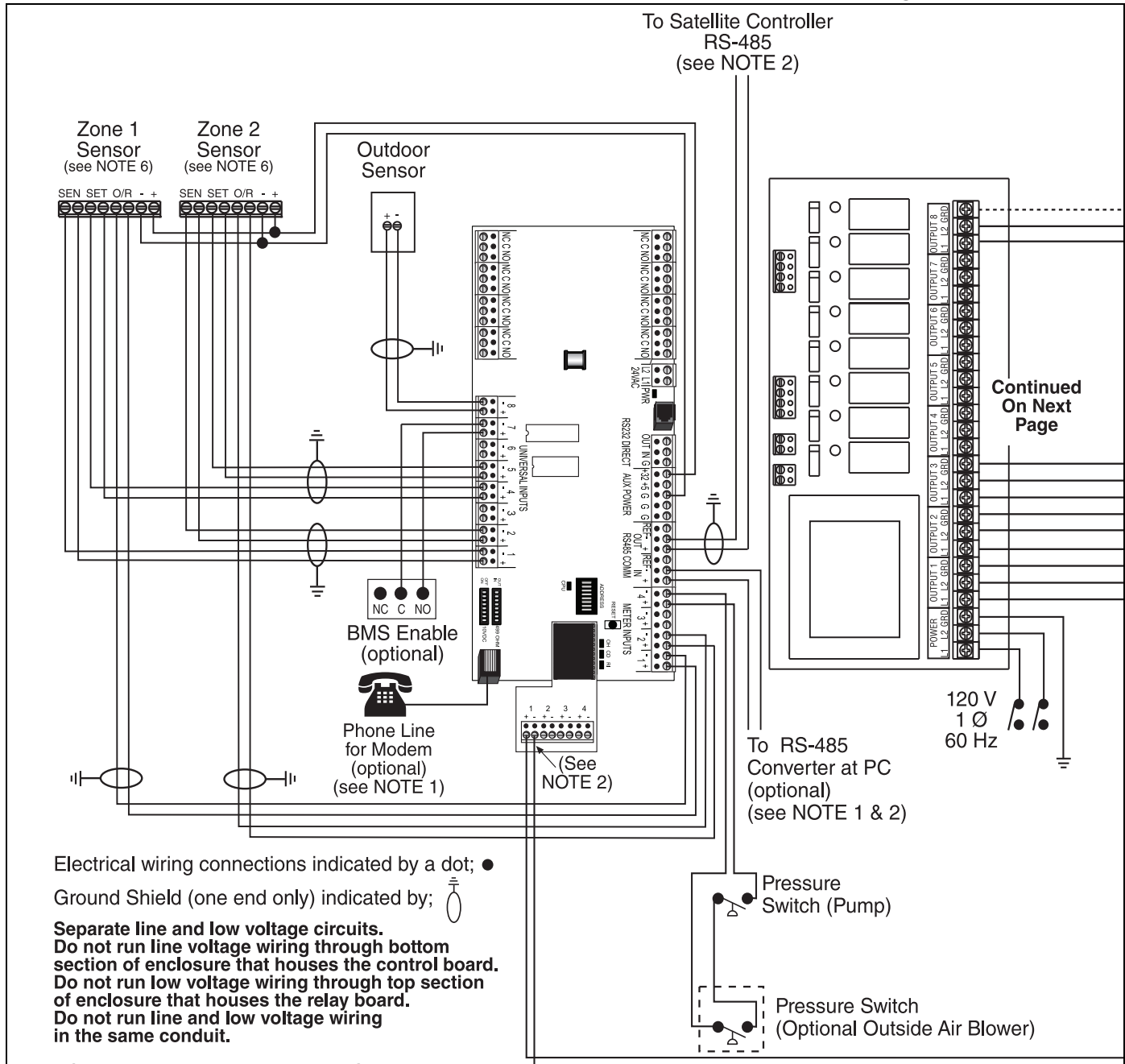

Electrical wiring connections indicated by a dot; ●
 Ground Shield (one end only) indicated by;

Separate line and low voltage circuits.
 Do not run line voltage wiring through bottom section of enclosure that houses the control board.
 Do not run low voltage wiring through top section of enclosure that houses the relay board.
 Do not run line and low voltage wiring in the same conduit.

NOTE 1: This diagram applies to the Central Controller (controller #1) only. For all Satellite Controllers see Satellite Controller External Wiring Diagram. Central Controller (controller #1) requires outdoor sensor wiring and either modem, RS-485 converter wiring, or TCP/IP module wiring.

NOTE 2: Twist shield wires for both RS-485 communication cables together and ground at central panel only. On controller #1 only, connect these twisted shield wires to ground. For VFD 0-10 V signal wiring, connect shield wire to ground at the controller only.

NOTE 3: 120 V 1 Ø 50-60 Hz supply for 120 V VFD model. 230V 1 Ø 50-60 Hz supply for 230 V VFD model. 480 V 3 Ø 50-60 Hz supply for 480 V VFD model. See VFD rating plate for required input. **Repetitive cycling of a disconnect or input contactor (more than once every two minutes) may cause damage to the drive.**

NOTE 4: Zone 3 Sensor(not shown) wiring is as follows: SEN output to analog input 3; SET output to analog input 6; O/R output to meter input 3; +/- outputs to +32 V/GND inputs.

NOTE 5: Internal pre-wiring not shown.

NOTE 6: Wiring from 32 V terminals on the controller to sensor power terminals "+" and "-" is polarity sensitive.

NOTE 7: All three power output wires from terminals U, V, and W to the pump motor must be kept tightly bundled and run in a separate conduit away from all other power and control wiring.

ROBERTS GORDON® ULTRAVAC™ Central Controller External Wiring (continued)

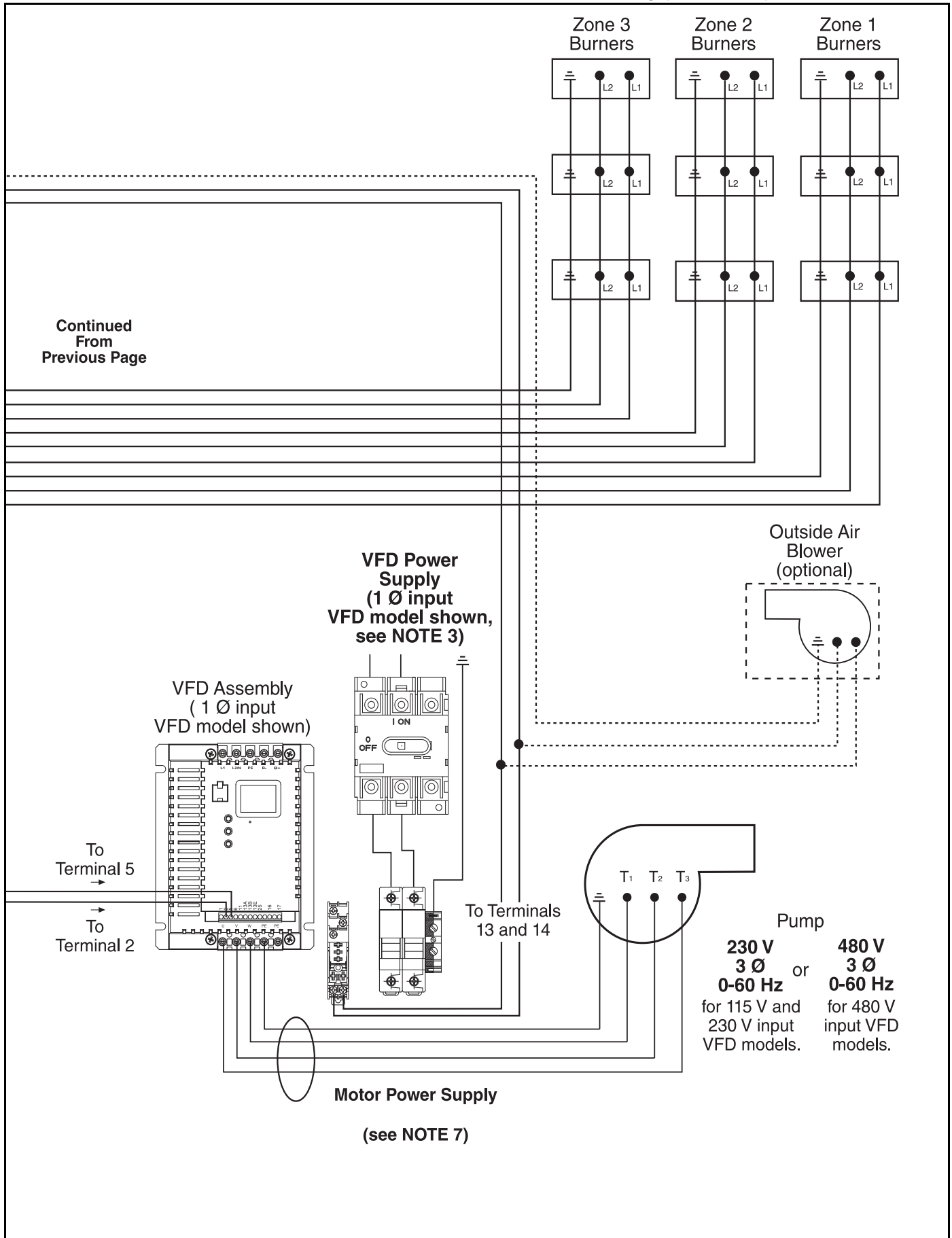
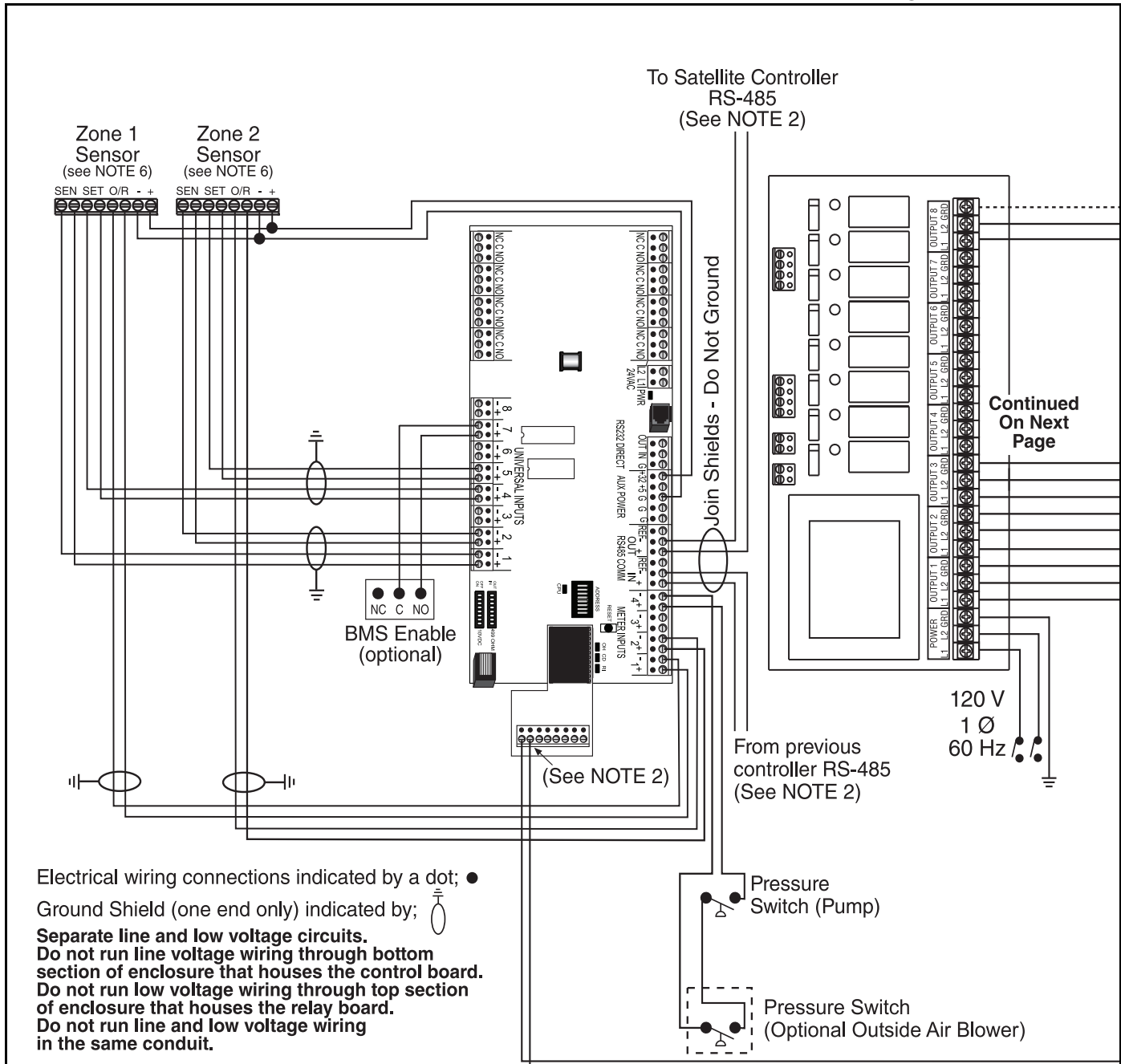



FIGURE 14: ROBERTS GORDON® ULTRAVAC™ Satellite Controller External Wiring



Electrical wiring connections indicated by a dot; ●
 Ground Shield (one end only) indicated by; 
Separate line and low voltage circuits. Do not run line voltage wiring through bottom section of enclosure that houses the control board. Do not run low voltage wiring through top section of enclosure that houses the relay board. Do not run line and low voltage wiring in the same conduit.

NOTE 1: This diagram applies to the Satellite Controller only. The Satellite Controller does not require modem, RS-485 converter wiring to the PC, TCP/IP module wiring, or outdoor sensor wiring. For Central Controller see Central Controller External Wiring Diagram.

NOTE 2: Twist shield wires for both RS-485 communication cables together and ground at central panel only. On controller #1 only, connect these twisted shield wires to ground. For VFD 0-10 V signal wiring, connect shield wire to ground at the controller only.

NOTE 3: 120 V 1 Ø 50-60 Hz supply for 120 V VFD model. 230V 1 Ø 50-60 Hz supply for 230 V VFD model. 480 V 3 Ø 50-60 Hz supply for 480 V VFD model. See VFD rating plate for required input. **Repetitive cycling of a disconnect or input contactor (more than once every two minutes) may cause damage to the drive.**

NOTE 4: Zone 3 Sensor(not shown) wiring is as follows: SEN output to analog input 3; SET output to analog input 6; O/R output to meter input 3; +/- outputs to +32 V/GND inputs.

NOTE 5: Internal pre-wiring not shown.

NOTE 6: Wiring from 32 V terminals on the controller to sensor power terminals "+" and "-" is polarity sensitive.

NOTE 7: All three power output wires from terminals U, V, and W to the pump motor must be kept tightly bundled and run in a separate conduit away from all other power and control wiring.

ROBERTS GORDON® ULTRAVAC™ Satellite Controller External Wiring (continued)

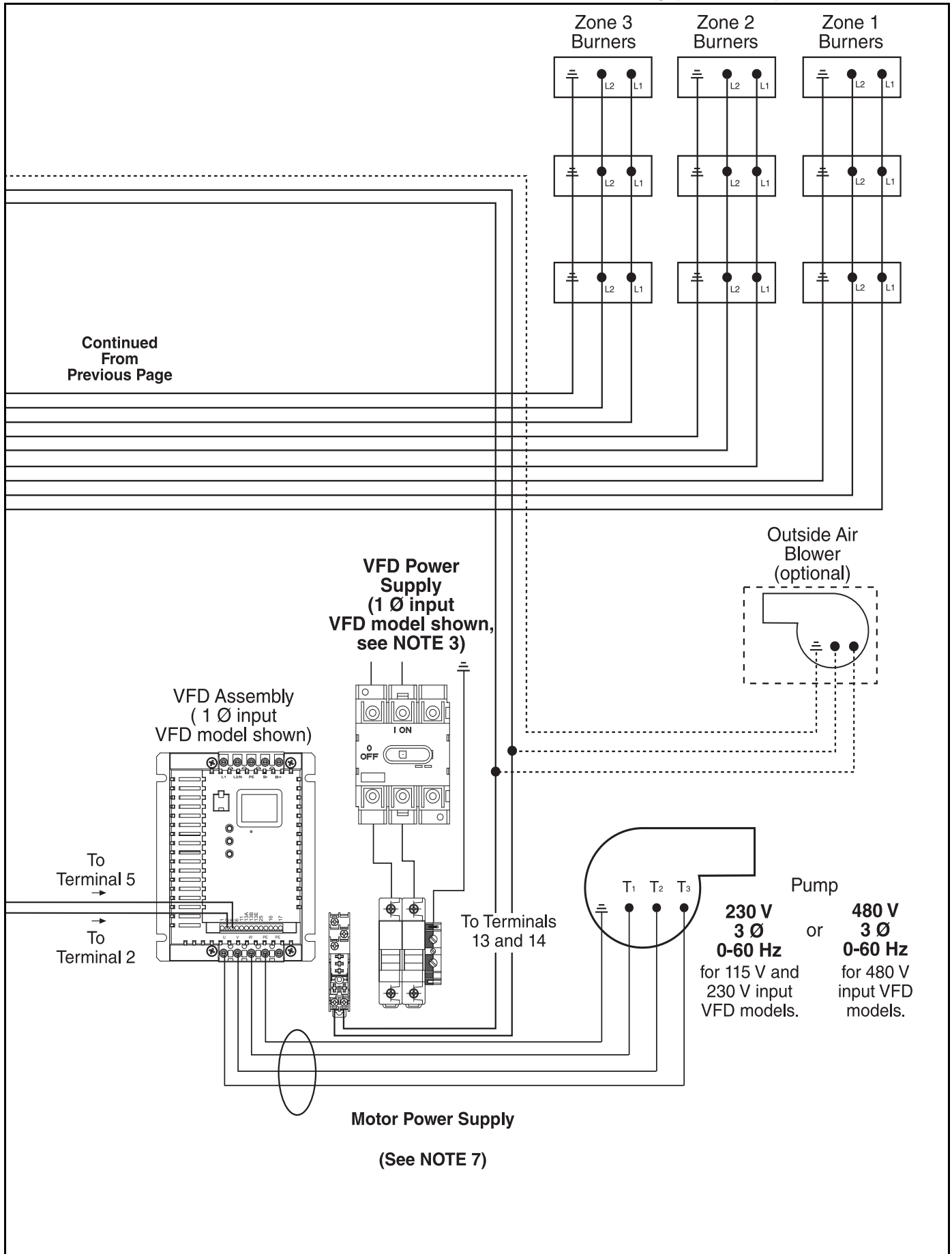

SECTION 5: COMMUNICATIONS

One ROBERTS GORDON® ULTRAVAC™ Controller per building (called the "central controller") must have equipment for remote communications to a PC. This equipment consists of either a modem chip, an RS-485 converter, or a TCP/IP communications module.

For remote **on-site and off-site** control and system status viewing, the central controller (controller #1) is fitted with a **modem chip**. See Page 30, Section 5.1.

If only remote **on-site** control and system status viewing is required, two controller communications interface devices are available: an **RS-485 converter** or a **TCP/IP communication module**.

An RS-485 converter is installed at a single PC, this PC can interface with any controller on the network of ULTRAVAC™ controllers. The RS-485 converter at the PC is wired directly to controller #1 using

shielded twisted pair communication wiring. See Page 31, Figure 16.

To interface with ULTRAVAC™ controllers through a Local Area Network (LAN), a TCP/IP Communication module is installed at controller #1. Controller #1 is wired to the LAN by an Ethernet cable. See Page 32, Section 5.3. Any computer on the LAN that has ULTRAVAC™ software installed can communicate with the controllers. Appropriate precautions must be taken to protect the Ethernet wiring from any possible electrical interference (noise) caused by surrounding machinery or equipment.

If multiple ULTRAVAC™ controllers are being used, the additional controllers communicate to controller #1 through communication wiring arranged in-series from one controller to the next. See Page 35, Section 5.5.

FIGURE 15: Modem Location

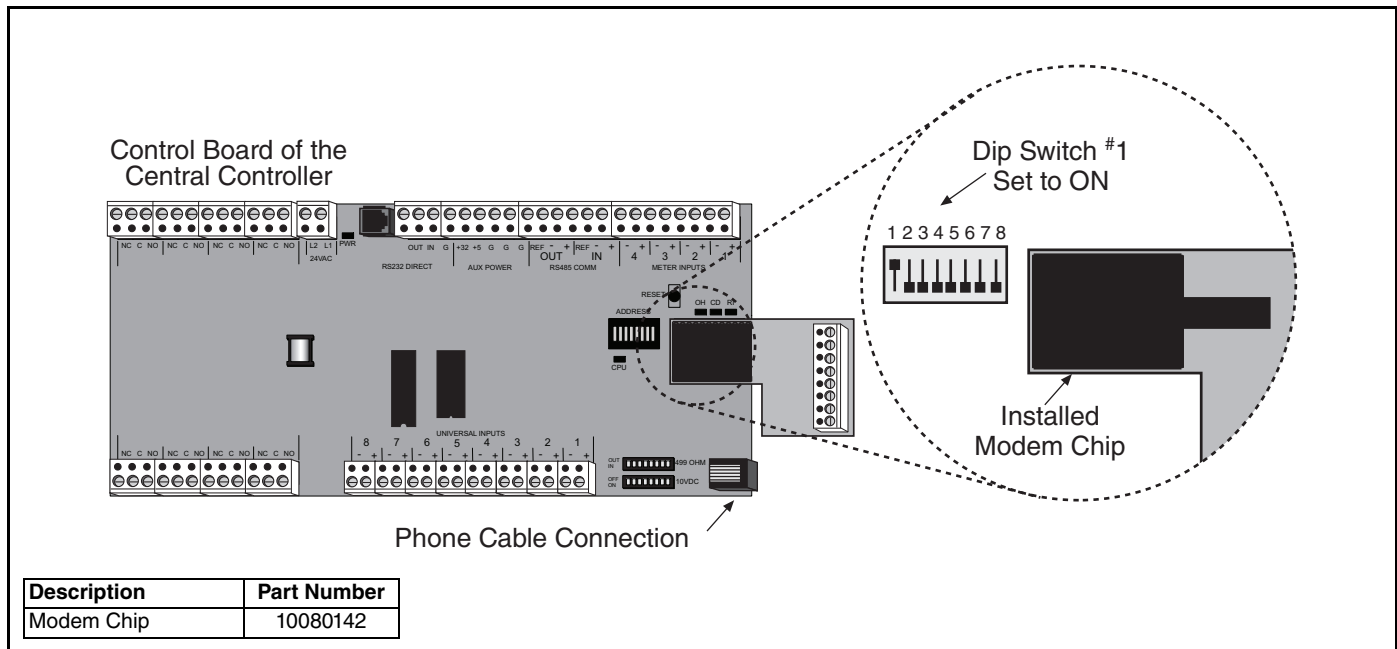

5.1 Dedicated Phone Line for Central Controller Modem

The Central Controller is fitted with a modem chip. To use the modem, the controller must have a phone line for modem communications. Install a phone line near the location of the Central Controller. The phone cable is plugged into the phone connection in the corner of the control board. See Page 30, Figure 15. If the modem option is not used for everyday communication to the controller(s), it can still be plugged into a phone line for troubleshooting or programming assistance. Contact your local ROBERTS GORDON® independent distributor for details.

If multiple ULTRAVAC™ controllers are being used, the additional controllers communicate to controller #1 through RS-485 communication wiring arranged in-series from one controller to the next. See Page 35, Section 5.5. This allows multiple controllers to be controlled from a PC through a single communication package at the central controller.

5.2 RS-485 Converter for Central Controller

For remote on-site viewing of system status and settings of any controller, use the RS-485 converter to connect a single PC (9 pin serial port) to the RS-485 terminals on the Central Controller. This will allow communication between one PC and any of the ULTRAVAC™ controllers on the network. For RS-485 converter wiring details see Page 31, Figure 16 and see Page 35, Section 5.5. Wiring between the RS-485 converter to the controller should not be more than 400' (122 m) in length.

For communication cable requirements see Page 22, Section 3.3.

If multiple ULTRAVAC™ controllers are being used, the additional controllers communicate to controller #1 through RS-485 communication wiring arranged in-series from one controller to the next. See Page 35, Section 5.5. This allows multiple controllers to be controlled from a PC through a single communication package at the central controller.

FIGURE 16: RS-485 PC Connection

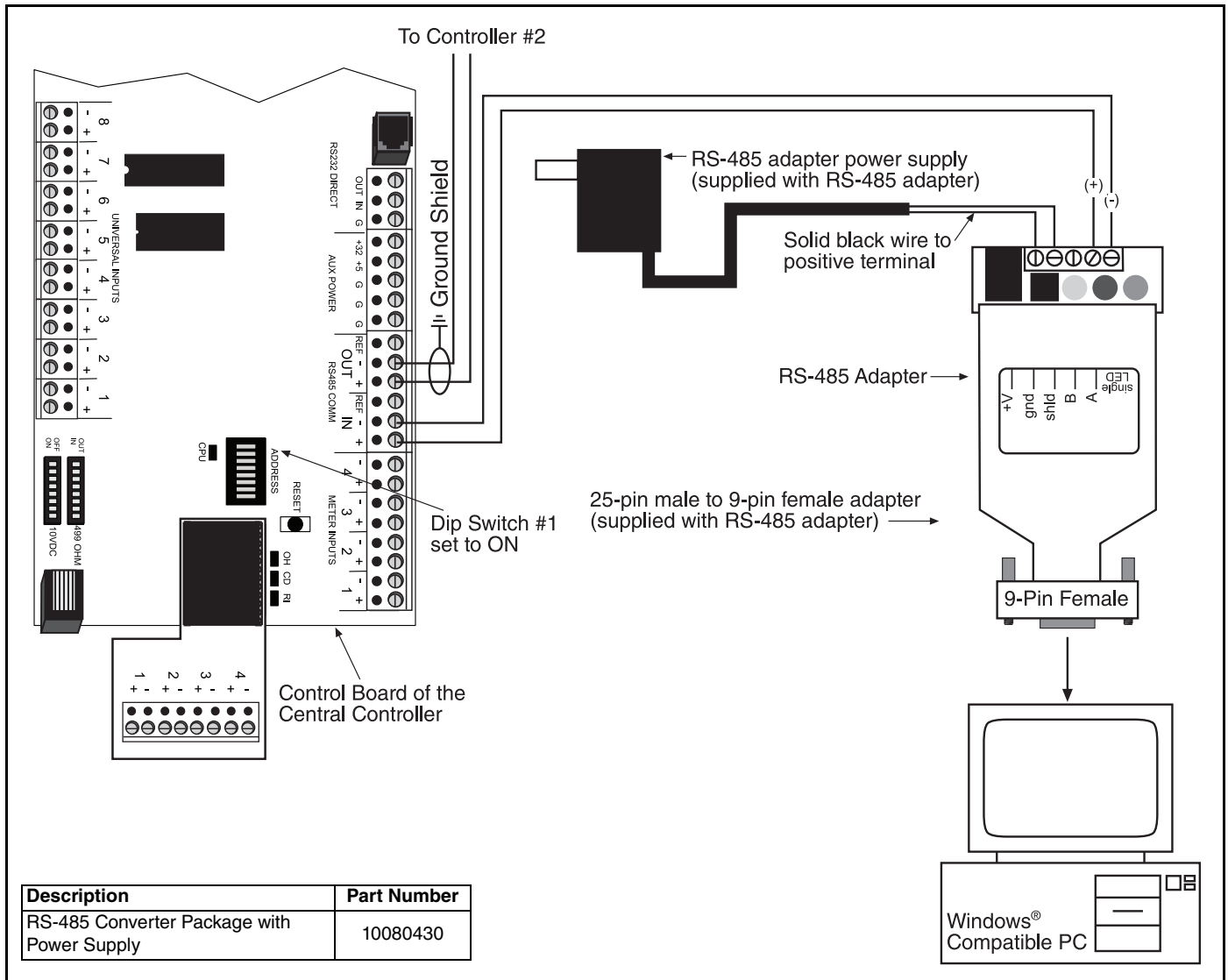

5.3 TCP/IP Communication Module

For remote on-site viewing of system status and settings of any controller, use the TCP/IP communication module to connect the controllers to a Local Area Network (LAN) via Ethernet cable. Any computer on the LAN that has ULTRAVAC™ software installed can be used to communicate with the controllers.

The module must be mounted inside the ULTRAVAC™ central controller (controller #1) enclosure next to the control board. The power (5V) for the module will come from the ULTRAVAC™ control board. The module will communicate to the controller via regular phone wire from the RJ11 jack on the module to the RS-232 direct connect port on the control board. The module will relay the data

from the controller to computers on the LAN via Ethernet cable plugged into the RJ45 jack on the module. A setup procedure must be performed on the module upon installation to create its IP address on the LAN. The setup instructions can be found in the ROBERTS GORDON® Software Manual (P/N 10081600NA).

For TCP/IP communication module wiring details, see Page 33, Figure 18.

If multiple ULTRAVAC™ controllers are being used, the additional controllers communicate to controller #1 through RS-485 communication wiring arranged in-series from one controller to the next. See Page 35, Section 5.5. This allows multiple controllers to be controlled from a PC through a single communication package at the central controller.

FIGURE 17: TCP/IP Communication Module Mounting

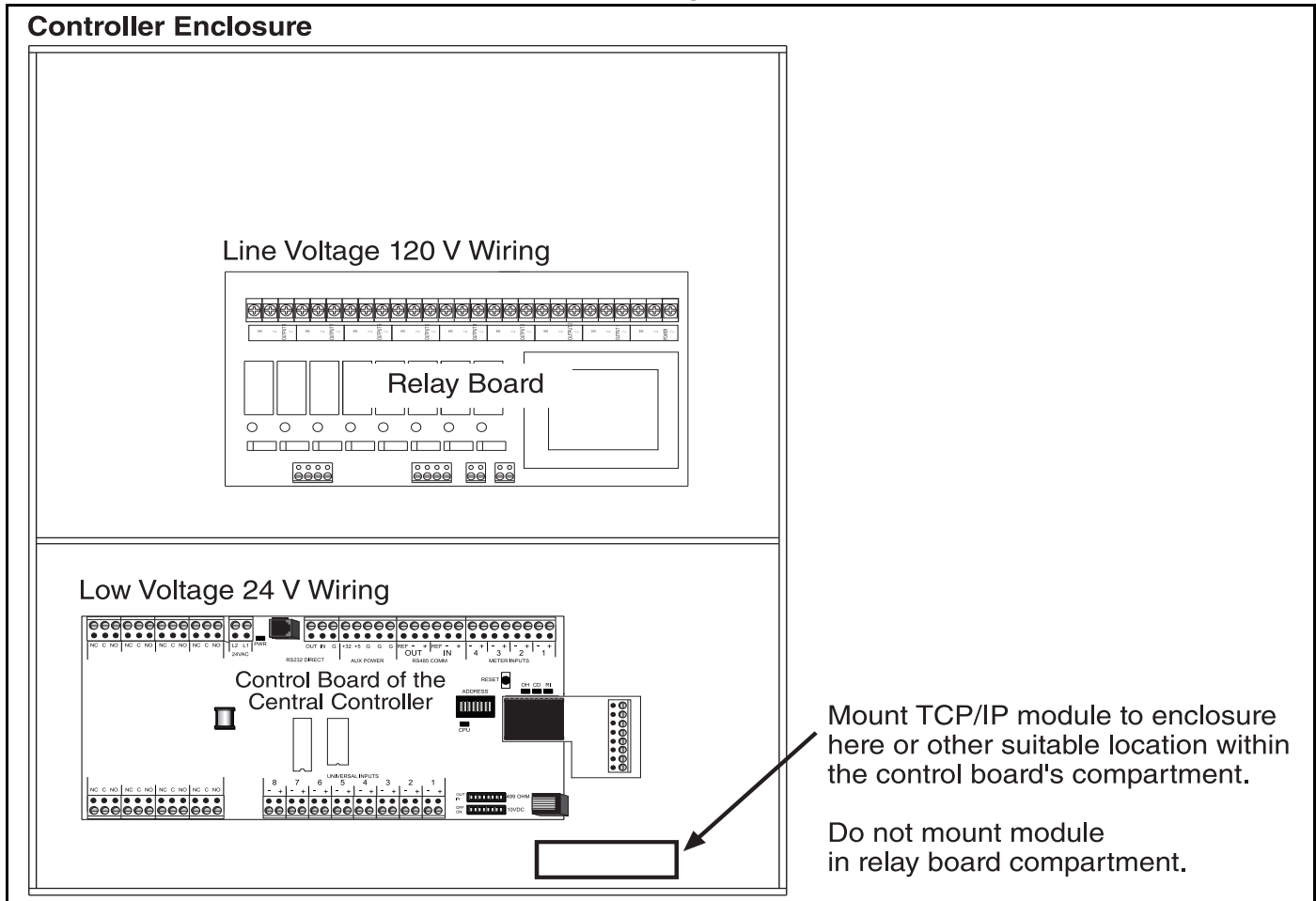
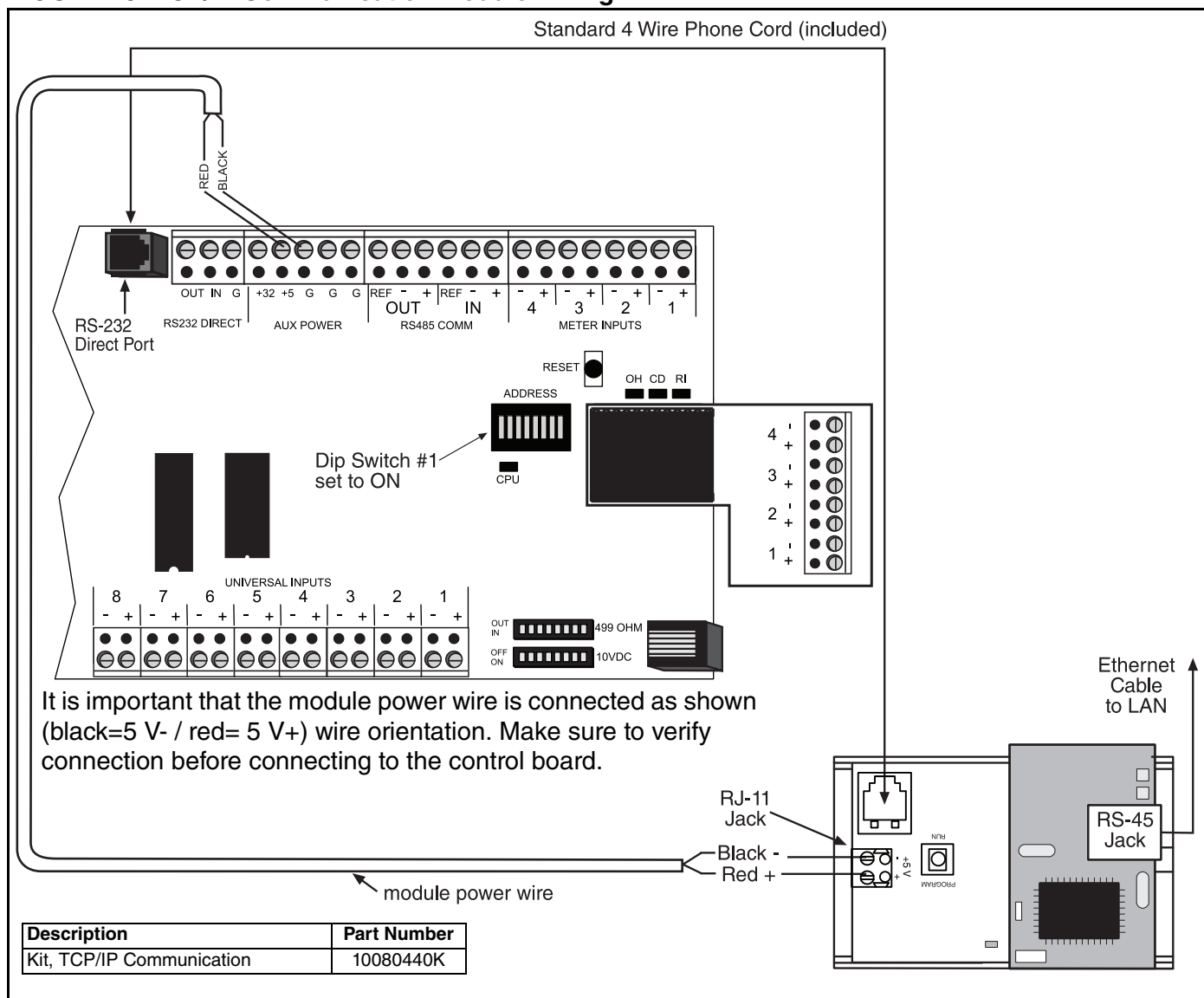

FIGURE 18: TCP/IP Communication Module Wiring

5.4 Direct Connect

For local viewing of system status and settings of any controller, a portable PC can be connected. Using the 9 pin adapter provided, (See Page 34, Figure 19), you may connect from your computer serial port to the RS-232 direct connect port on the control board via standard 4-wire phone cable. For identification of the RS-232 direct connect port, see Page 18, Figure 7. This can be useful when a PC is in close proximity to any ROBERTS GORDON® ULTRAVAC™ Controller or while troubleshooting at the controller using a laptop PC. This type of connector should not be used if the phone cable is more than 50' (15 m) in length.

Plug one end of the phone cable into the RS-232 direct port, plug the other end into the adapter shown in on Page 34, Figure 19. Plug the adapter into a 9-pin serial port on your computer.

If a PC does not have a serial port, but does have a USB port, purchase of a USB to Serial Converter is required.

A USB to 9-pin Serial Cable will allow connection between the RS-232 device (ULTRAVAC™ Control Board) and the USB port on the PC. The USB to serial RS232 DB9 Cable Adapter will be used in conjunction with the PC Connection Cable Package (P/N 10080410). USB to Serial RS232 DB9 Cable Adapters can be purchased at a local computer store or on the internet for \$20.00 or less. The converter should come with drivers and should draw power directly from USB, requiring no additional power adapter.

FIGURE 19: 9 Pin Adapter for PC

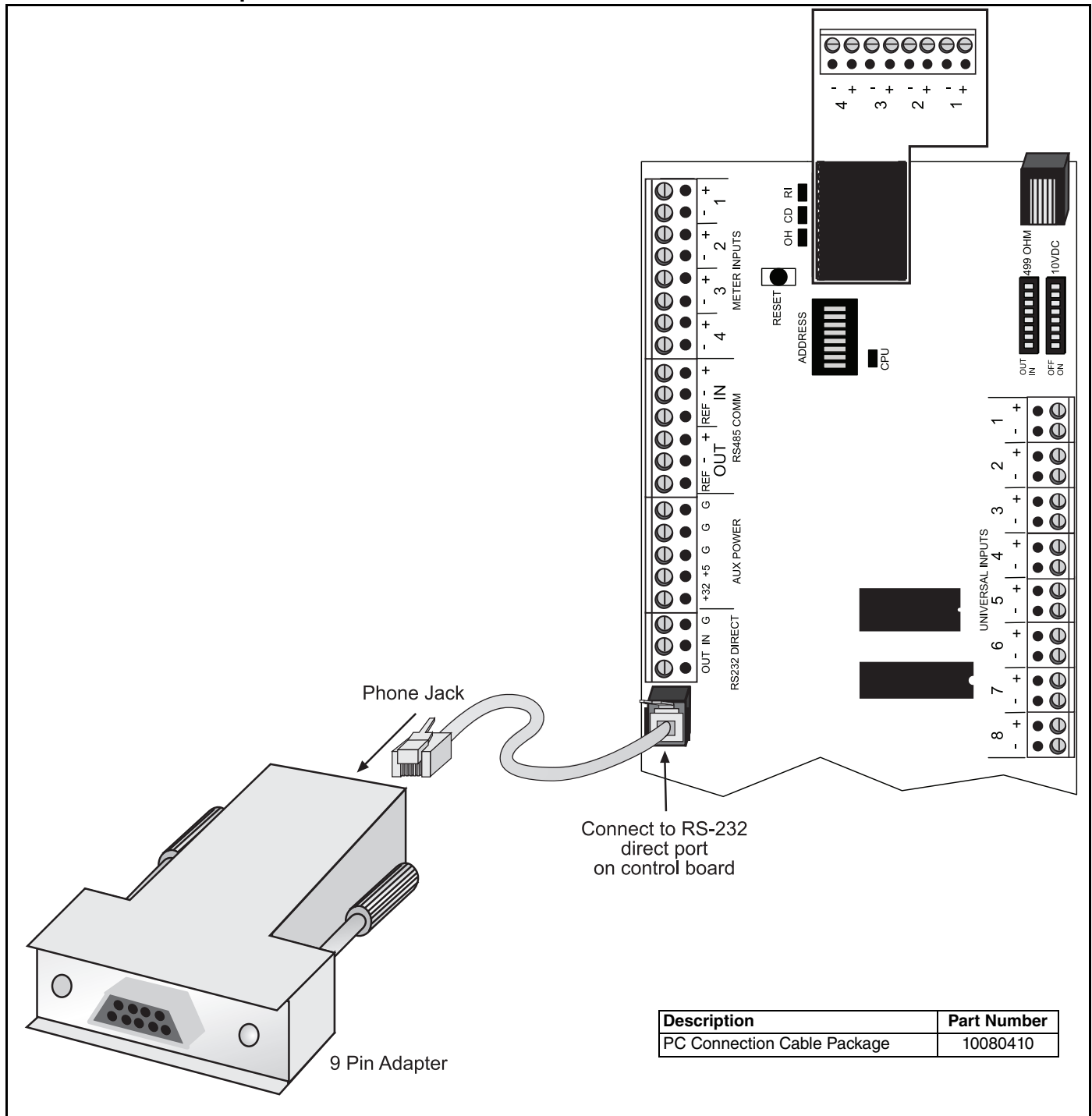

5.5 Communications Between Multiple ROBERTS GORDON® ULTRAVAC™ Controllers

If more than one ROBERTS GORDON® ULTRAVAC™ Controller is installed in a building, the controllers' RS-485 communications must be wired in series. See Page 35, Figure 20. Connect the RS-485 terminal on controller #1 to the RS-485 terminal on controller #2 and so on in a daisy chain fashion. For communication cable requirements, See Page 22, Section 3.3

From a PC, by dialing into the modem on controller #1 or by connecting to controller #1 via RS-485 converter or TCP/IP communication module, the

system status and settings can be viewed for any of the controllers on the network.

The control board identification dip switch must be set on each ROBERTS GORDON® ULTRAVAC™ Controller. See Page 35, Figure 20 for dip switch settings. Contact Roberts-Gordon or your ROBERTS GORDON® independent distributor, if more than 20 controllers are connected.

FIGURE 20: Communications Between Multiple Controllers

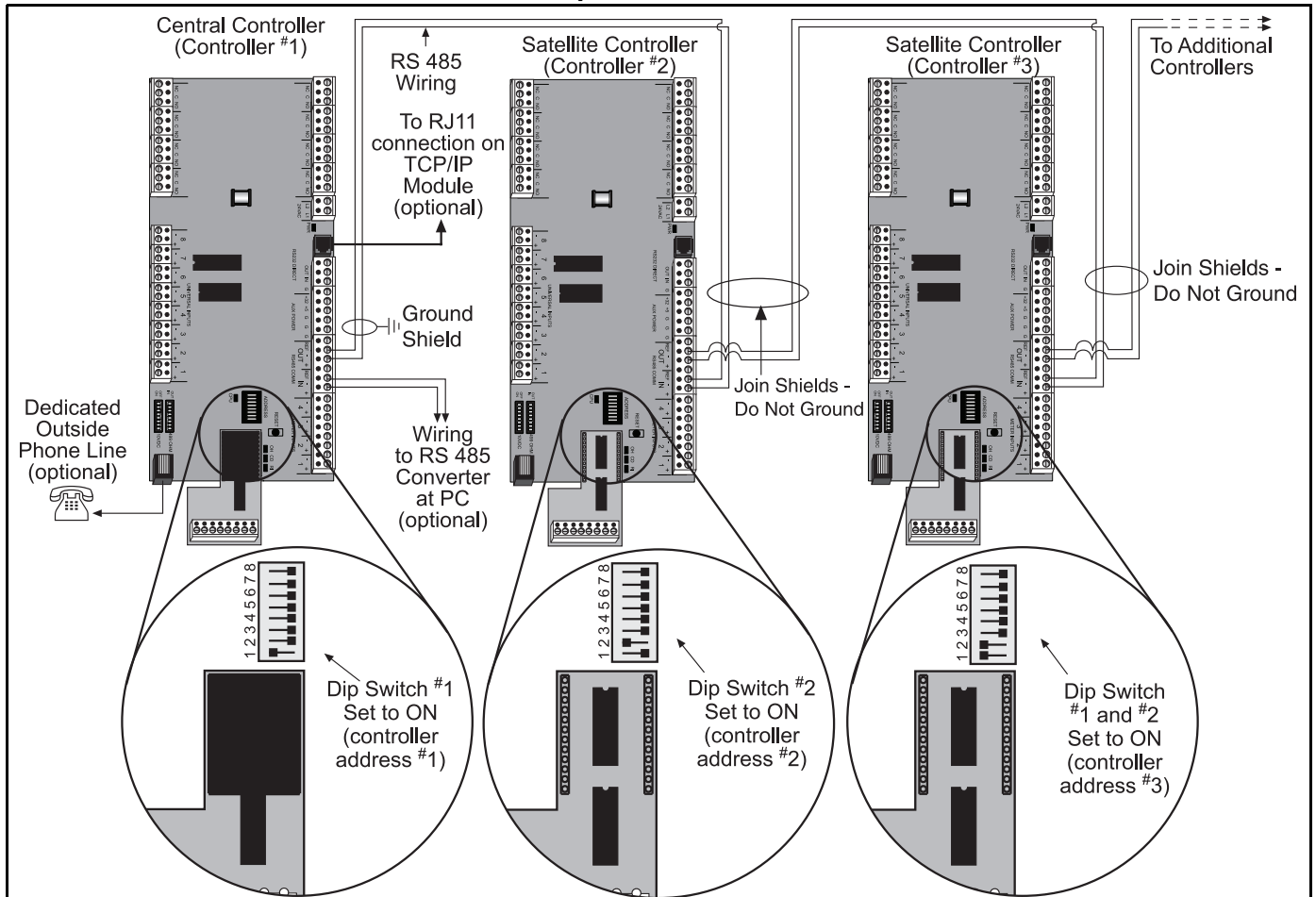

Controller/Address Number	Dip Switch Order (1,2,3,4,5,6,7,8) Values (1=ON, 0=OFF)	Controller/Address Number	Dip Switch Order (1,2,3,4,5,6,7,8) Values (1=ON, 0=OFF)
1 (Central Controller)	1000000	11	11010000
2	0100000	12	00110000
3	1100000	13	10110000
4	0010000	14	01110000
5	1010000	15	11110000
6	0110000	16	00001000
7	1110000	17	10001000
8	0001000	18	01001000
9	1001000	19	11001000
10	0101000	20	00101000

5.5.1 Repeater

If the RS-485 communications wire length is above 4000' (1219 m), a repeater must be used to extend the signal. The repeater can also be used to install in different methods:

- To extend communications beyond the standard 4000' (1219 m) limitation. See Page 36, Figure 21.
- To add parallel branches of ROBERTS GORDON® ULTRAVAC™ controller communications bus wiring. See Page 37, Figure 22.

NOTE: The maximum number of ROBERTS GORDON® ULTRAVAC™ Controllers that can be installed is 242.

FIGURE 21: Repeater External Wiring

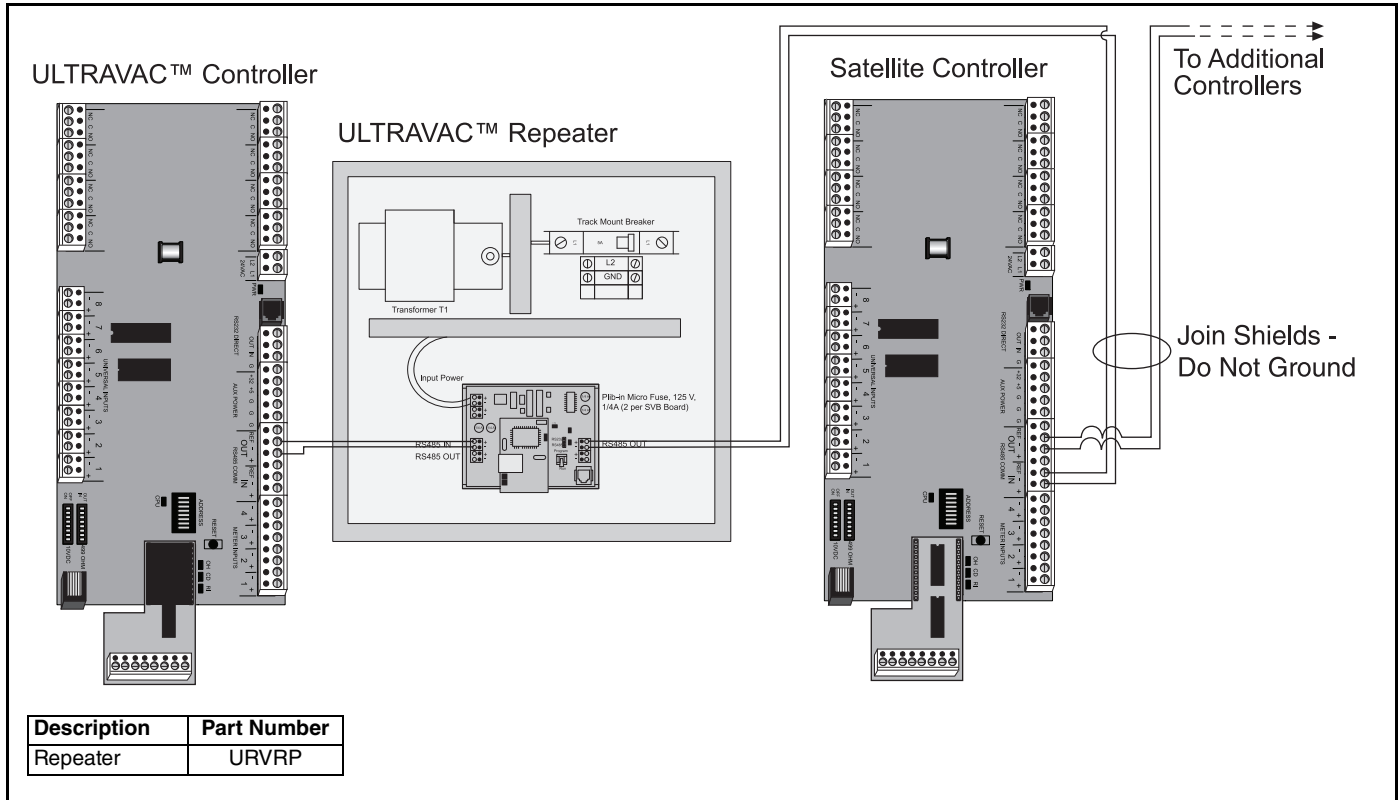
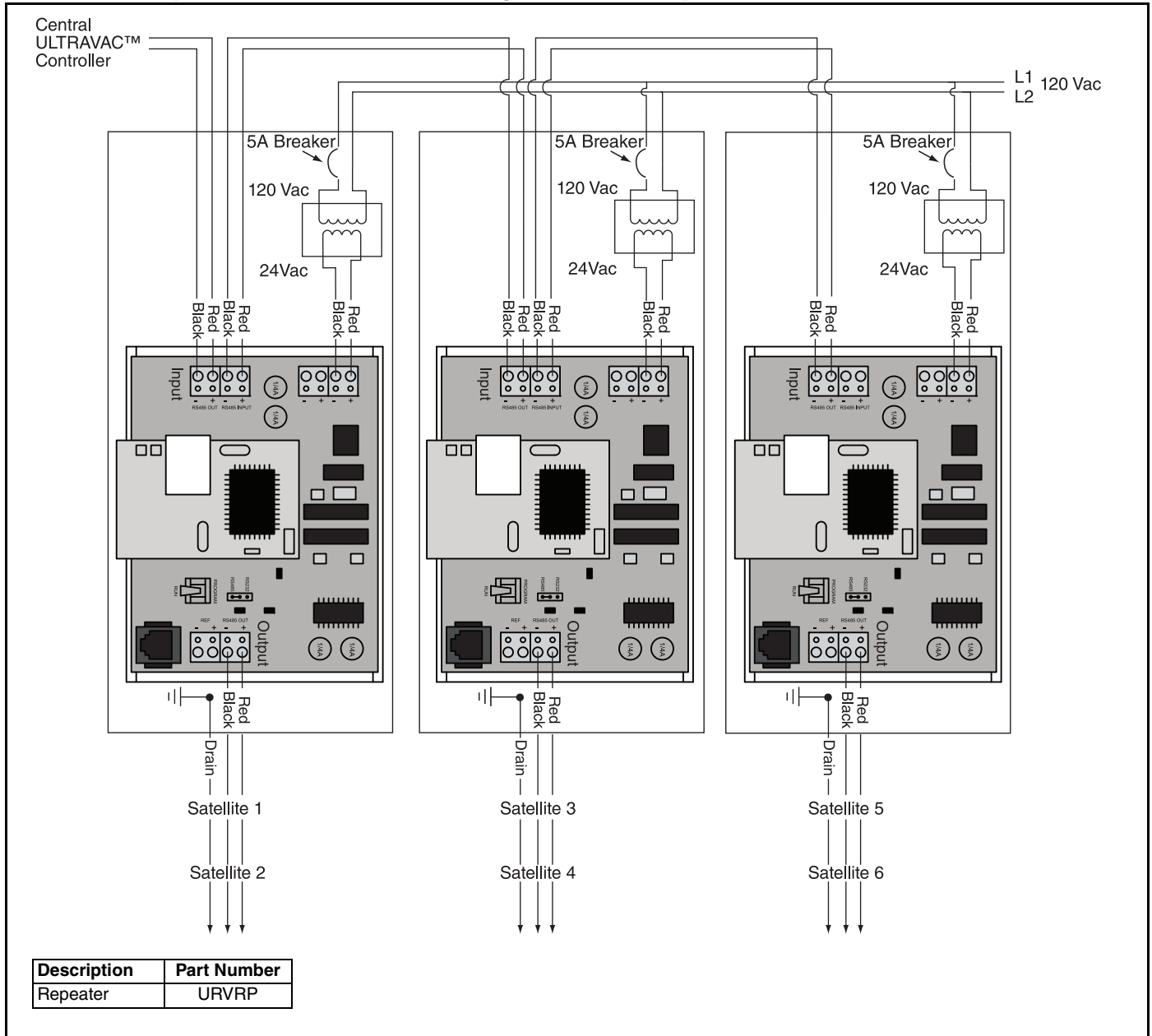

FIGURE 22: Repeater Communication Wiring Between Multiple Controllers



SECTION 6: ULTRAVAC™ BMS LINK CONTROLLER

6.1 ULTRAVAC™ BMS Link Controller Overview

Many customers have building management control systems that manage multiple mechanical systems in the building such as heating, ventilation, lighting, etc. ULTRAVAC™ Controls run a stand-alone proprietary program. With the addition of an ULTRAVAC™ BMS LINK Controller, the ULTRAVAC™ system can communicate with third party building management control systems using BACnet® or MODBUS® protocol.

Communication of data points from the ULTRAVAC™ system to the building controls system help allow building managers and end users to easily integrate ULTRAVAC™ into a single controls solution shared between multiple mechanical systems in the building. ULTRAVAC™ BMS Link has an option of communicating to the building control system via BACnet®/IP, BACnet® MSTP or MODBUS® protocol. The standard ULTRAVAC™ BMS Link architecture is detailed on Page 38, Figure 23.

FIGURE 23: Standard ULTRAVAC™ BMS Link Architecture

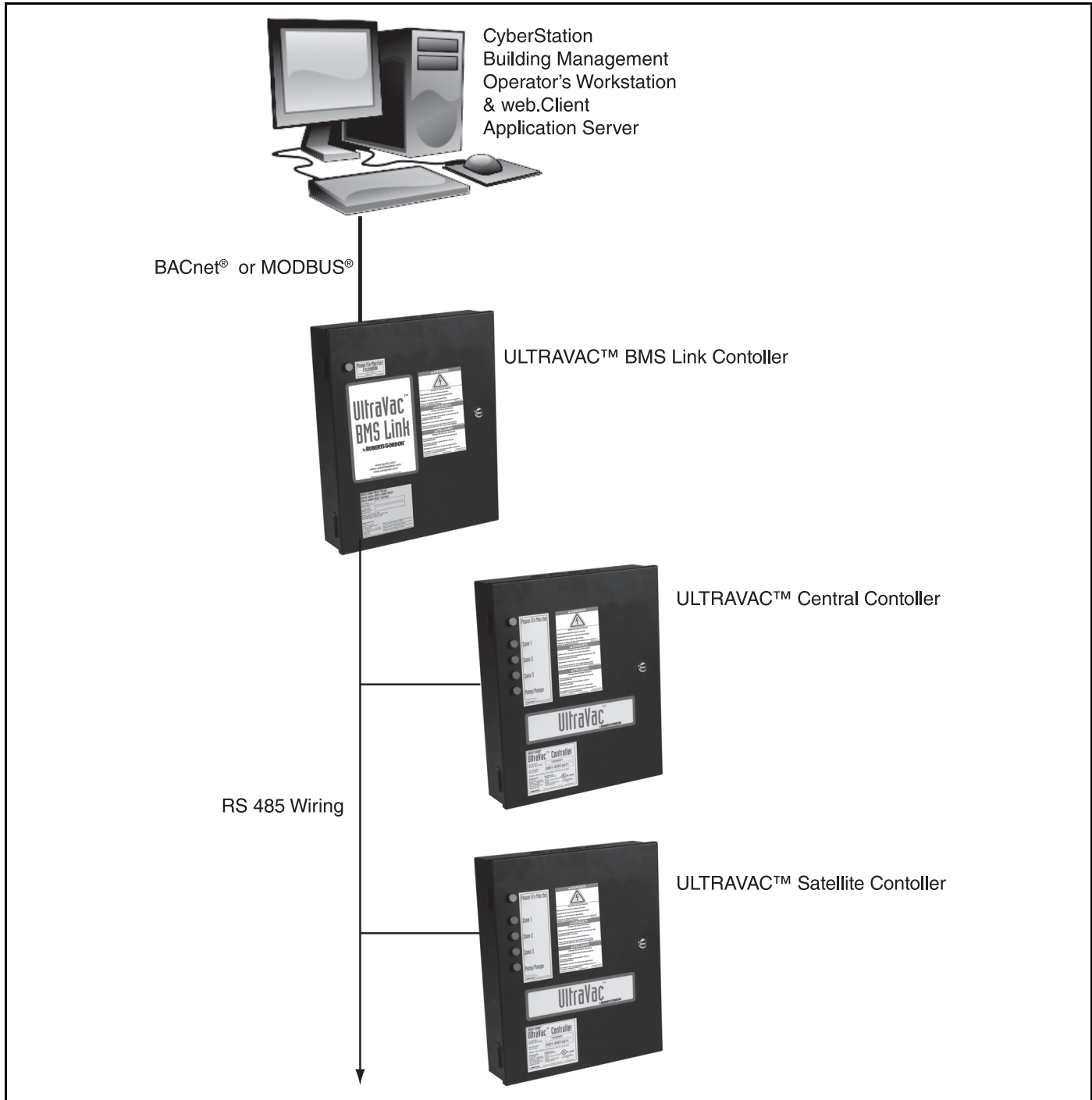
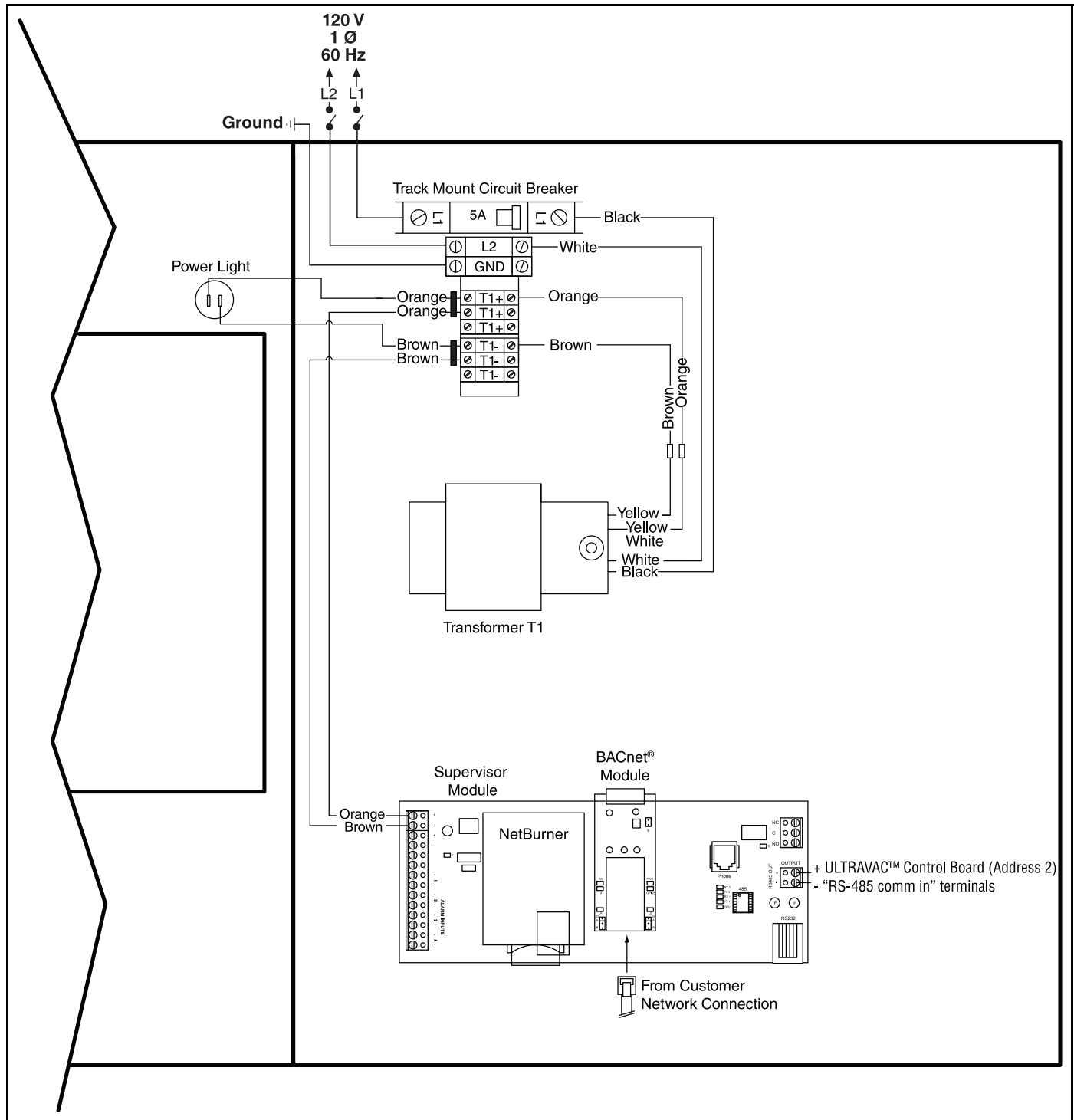

FIGURE 24: ULTRAVAC™ BMS Link Controller Schematic



6.2 ULTRAVAC™ BMS Link Controller Requirements

The purpose of the ULTRAVAC™ BMS Link Controller is to integrate with a third party building control system. This building control system is provided by others and must be capable of communicating via one of the ULTRAVAC™ BMS Link communication protocols.

For interface capability, one ULTRAVAC™ BMS Link Controller is needed for each ULTRAVAC™ network

of controllers. The ULTRAVAC™ BMS Link Controller is connected via communication wiring on the RS-485 communication bus to the ULTRAVAC™ central controller.

The ULTRAVAC™ BMS Link Controller requires a 115 V, 20 A dedicated power circuit. The control board identification dip switch must be set on each ULTRAVAC™ controller. See Page 41, Figure 25. This enables ULTRAVAC™ Controls to communicate with a variety of controls.

6.3 Technical Data

- Power Supply: 120 VAC.
- Frequency: 50/ 60 Hz.
- Network Cable: Standard Ethernet Cables.
- Communication Ports: RS-485 Communication Bus
- Memory: Memory Card, SD 1GB.

6.4 ULTRAVAC™ BMS Link Controller Programming

Each ULTRAVAC™ BMS Link Controller is custom programmed before it is shipped. The custom program allows the controller to interface with the proper total number of ULTRAVAC™ Controls installed at the jobsite. The total number of ULTRAVAC™ Controls (including the central controller and all satellite controllers, but not including the ULTRAVAC™ BMS Link Controller) and the job name and location are submitted to Roberts-Gordon upon placing the order for the ULTRAVAC™ BMS Link Controller.

Each ULTRAVAC™ BMS Link Controller is supplied with a printed report listing all of the available points. The information in the report must be communicated to the controls manager for use in configuring the third party building controls software. This documentation is intended for the contractor to leave with the controls manager or end user upon commissioning of the ULTRAVAC™ system. Refer to the ULTRAVAC™ BMS Link Controller User Manual included on our ULTRAVAC™ Software CD for onsite programming instructions.

FIGURE 25: Communication Between ULTRAVAC™ BMS Link Controller and Multiple ULTRAVAC™ Controllers

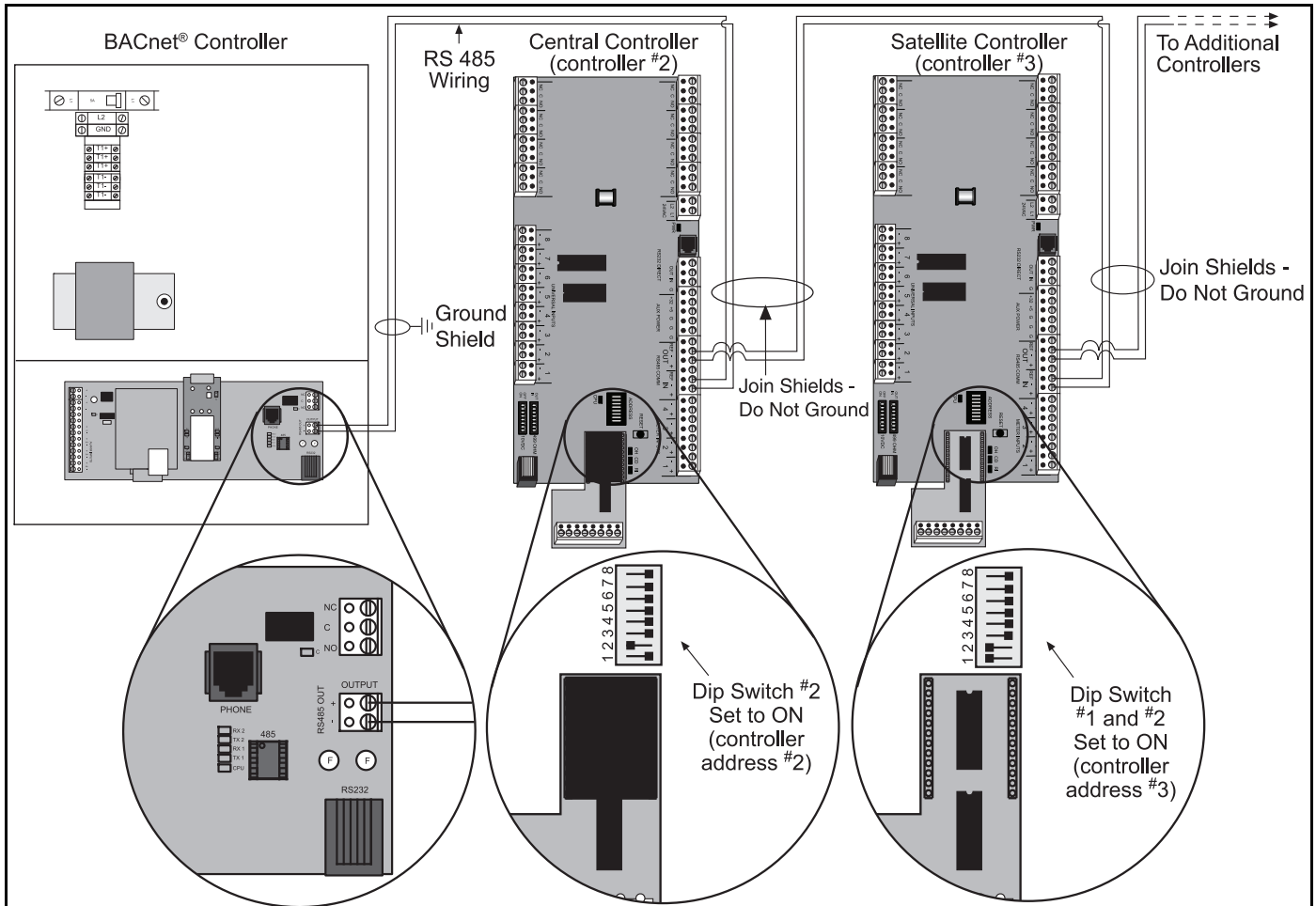

NOTE:
For retrofit projects, you must re-address existing boards beginning with address 2 (typically add 1 to each existing address).

Controller Number	Dip Switch Order (1,2,3,4,5,6,7,8) Values (1=ON, 0=OFF)	Address Number
1 (Central Controller)	01000000	2
2	11000000	3
3	00100000	4
4	10100000	5
5	01100000	6
6	11100000	7
7	00010000	8
8	10010000	9
9	01010000	10
10	11010000	11

Controller Number	Dip Switch Order (1,2,3,4,5,6,7,8) Values (1=ON, 0=OFF)	Address Number
11	00110000	12
12	10110000	13
13	01110000	14
14	11110000	15
15	00001000	16
16	10001000	17
17	01001000	18
18	11001000	19
19	00101000	20
20	10101000	21

SECTION 7: VARIABLE FREQUENCY DRIVE PROGRAMMING

7.1 VFD Parameter Settings For Use With ROBERTS GORDON® ULTRAVAC™

The VFD parameters come with factory default settings. The following parameter settings must be changed for ROBERTS GORDON® ULTRAVAC™. Settings can only be altered when the pump motor is stopped.

Verify that there is power to the VFD (LCD display will be on) and no power to the 24 V power switch on the relay board of the ROBERTS GORDON® ULTRAVAC™.

⚠ DANGER



Electrical Shock Hazard

Enclosure contains live electrical components.

Programming must be done by a trained technician only.

Replace cover before operating.

Failure to follow these instructions can result in death or electrical shock.

To override the rotary disconnect switch inside the VFD enclosure, turn the square rod with a wrench to the ON position. In order to be able to close the cover of the disconnect, the rods need to be turned back to the OFF position.

7.1.1

To enter the PROGRAM mode and access the parameters, press the Mode button. This will activate the PASSWORD prompt (if the password has not been disabled).

Display reads "00"

Upper right decimal point blinks

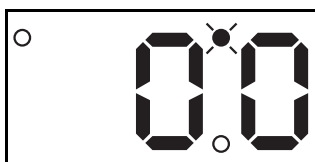

7.1.2

Use the arrow buttons to scroll to the password value (the factory set password is 225).

Press Mode to enter password.

Once the correct password value is entered, the display will read "P01", which indicates that the PROGRAM mode has been accessed at the beginning of the parameter menu (P01 is the first parameter).



NOTE: If the display flashes "Er", the password was incorrect, and the process to enter the password must be repeated.

7.1.3 Use the arrow buttons to scroll to the desired parameter number. For new parameter settings, See Page 43, Section 7.2.

7.1.4 Once the desired parameter number is found:

Press Mode to display present parameter setting (example setting is 20.0).

Upper right decimal point blinks.



Use arrow buttons to change setting.

Press Mode to store new setting and exit the program mode.

7.1.5 To change another parameter, press the Mode key again to re-enter the PROGRAM mode (the parameter menu will be accessed at the parameter that was last viewed or changed before exiting).

If the Mode key is pressed within two minutes of exiting the PROGRAM mode, the password is not required to access the parameters. After two minutes,

the password must be entered in order to access the parameters again.

7.2 Altering VFD Parameters

Using the procedure described on *Page 42, Section 7.1.1 through Section 7.1.5*, alter the following parameters:

Parameter Number	Parameter Name	Factory Default	New Setting
P01	Line Voltage	01	01
P03	Start Method	01	05
P05	Standard Speed Source	01	(03) (0-10) Vdc (04) (4-20) mA
P44	Password	225	Any # 000-999
P45	Speed at Minimum Signal	0.0Hz	Frequency Setting noted on <i>Page 44, Section 8.1.2</i>
P46	Speed at Maximum Signal	60.0Hz	Frequency Setting noted on <i>Page 44, Section 8.1.2</i>

SECTION 8: COMMISSIONING THE CORAYVAC® SYSTEM

NOTE: The ROBERTS GORDON® ULTRAVAC™ software must be installed on the PC, the communication connection must be made to the controller and all wiring of the ROBERTS GORDON® ULTRAVAC™ control boards, relay boards, burners, pumps and VFD must be completed before starting the commissioning procedure.

8.1 Setting The CORAYVAC® End Burner Vacuum

It is important to understand that the frequency that the VFD runs the motor at, determines the speed of the impeller in the pump. Variation of the impeller speed will increase or decrease vacuum in the system. The following procedure will help you set minimum and maximum VFD frequency settings to achieve proper vacuum in the system.

Step 8.1.1 At the controller, turn on the 24 V power switch on the relay board. At the PC, "connect" to the controller (see the ROBERTS GORDON® ULTRAVAC™ Software Installation and Operation Manual, P/N 10081600NA for details) and then open the **manual override screen(Alt + M)**. On the screen, click the "ON" button for the vacuum pump. Wait 30 seconds then click the ON button for zones 1-3.

Step 8.1.2 The pump should be running and the burners should light within 60 seconds. At the VFD, verify that the number displayed on the LCD screen is "60.0" If it is lower than 60.0, hit the "up" arrow button on the VFD until the number reads 60.0 Let the burners fire for approximately 20-30 minutes to warm up the system. Using a manometer, check the end vent vacuum in each zone (each branch of burners). See Page 45, Figure 26.

If the lowest end vent vacuum reading is above 3.0" wc, reduce the vacuum pump speed. Generally, the lowest end vent vacuum reading is on the longest branch of the system. Use the down arrow button on the VFD to reduce the frequency of the output signal to the pump, thus reducing the pump speed and lowering the end vent vacuum reading. Continue to reduce the frequency until the end vent vacuum reading is between 2.5" - 3.0" wc. Make note of this frequency setting below. The frequency is found on the VFD's LCD screen.

2.5" wc - 3.0" wc VFD Frequency Setting

Record Frequency Setting Here:

To avoid damage to the pump motor, do not adjust the frequency above 60.0 Hz. Verify that the end vent

vacuum readings in the remaining branches are proper. If necessary, adjust the proper damper coupling to achieve an end vent vacuum of 2.5" - 3.0" wc. See Page 45, Figure 26. Damper couplings should be found near the end of the radiant portion of the pipe in each branch or where a branch connects to other branches at a cross or tee. See Page 46, Figure 27.

FIGURE 26: End Vent Vacuum

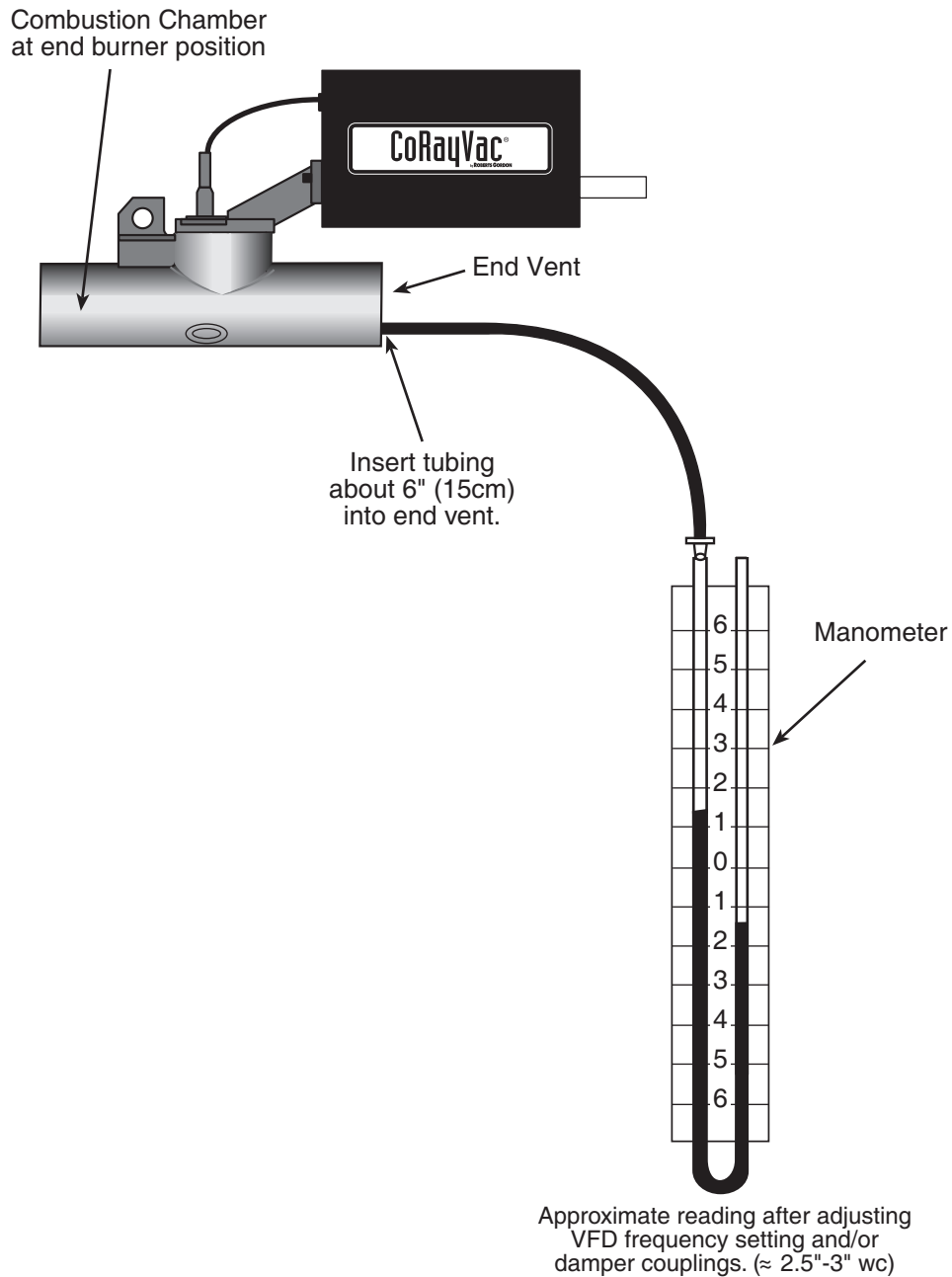
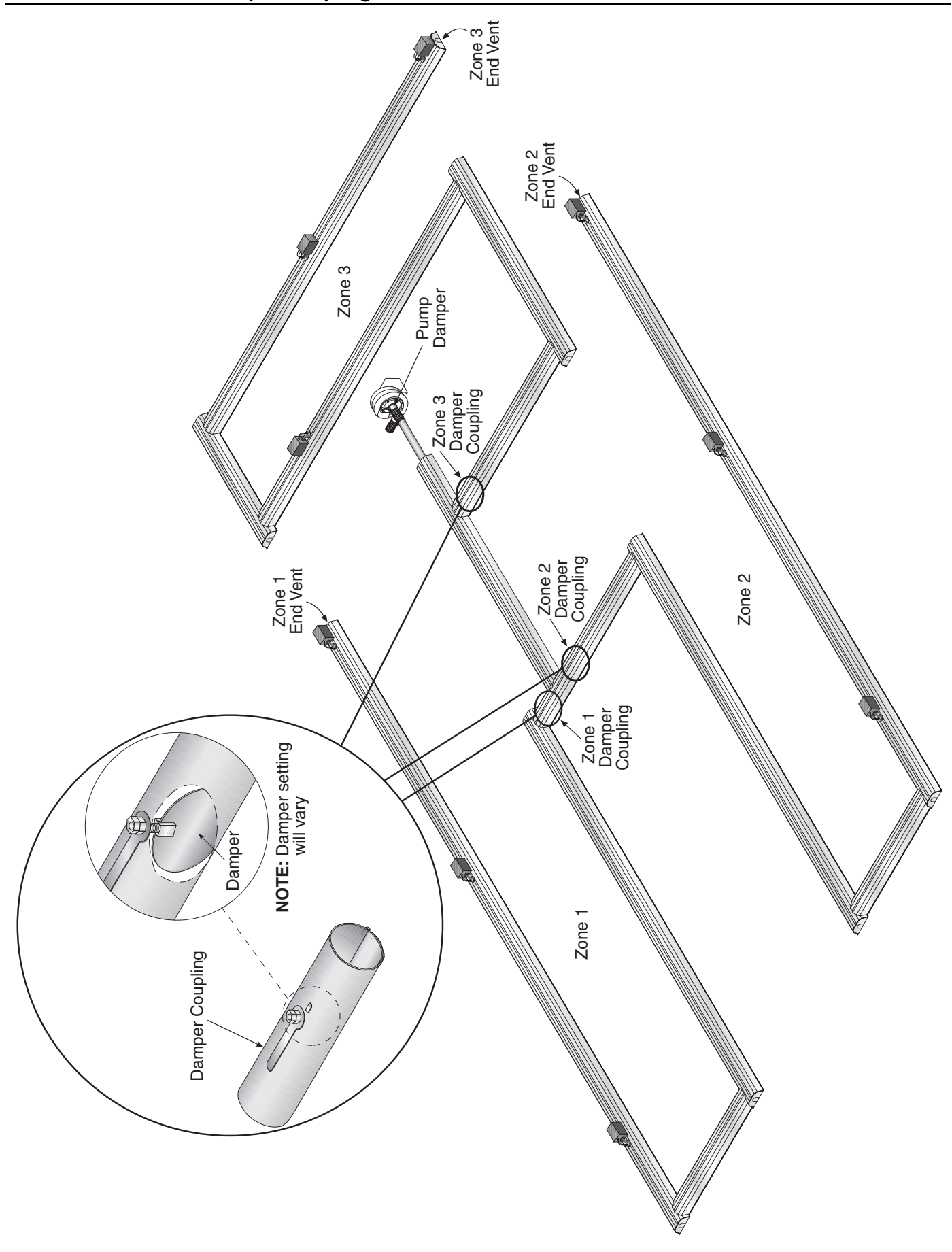

FIGURE 27: Possible Damper Couplings' Locations



Step 8.1.3 After setting end vent vacuums between 2.5" wc and 3.0" wc, while all the burners are still operating, use the down arrow button on the VFD to reduce the frequency of the output signal to the pump. Reduce the frequency of the VFD until the manometer at each of the end vents reads 1.0" wc - 1.2" wc, Make note of this frequency setting below. The frequency is found on the VFD's LCD screen.

1.0" w.c. - 1.2" wc VFD Frequency Setting

Record Frequency Setting Here:

Step 8.1.4 Return to the PC and click the pump and zones to "OFF".

Step 8.1.5 Using the procedure described on *Page 42, Section 7.1.1 through Section 7.1.5*, alter the following parameters on the VFD: Return to the PC and click the vacuum pump and three zones to "AUTO", then click exit.

Parameter Number	Parameter Name	Factory Default	New Setting
P01	Line Voltage	01	01
P03	Start Method	01	05
P05	Standard Speed Source	01	(03) (0-10) Vdc (04) (4-20) mA
P44	Password	225	Any # 000-999
P45	Speed at Minimum Signal	0.0Hz	Frequency Setting noted on <i>Page 44, Section 8.1.2</i>
P46	Speed at Maximum Signal	60.0Hz	Frequency Setting noted on <i>Page 44, Section 8.1.2</i>

SECTION 9: TROUBLESHOOTING

⚠ DANGER



Electrical Shock Hazard

Disconnect electric before service.

More than one disconnect switch may be required to disconnect electric to the unit.

Failure to follow these instructions can result in death or electrical shock.

⚠ WARNING



Explosion Hazard

Turn off gas supply to heater before service.

Failure to follow these instructions can result in death, injury or property damage.

FIGURE 28: Troubleshooting Flow Chart

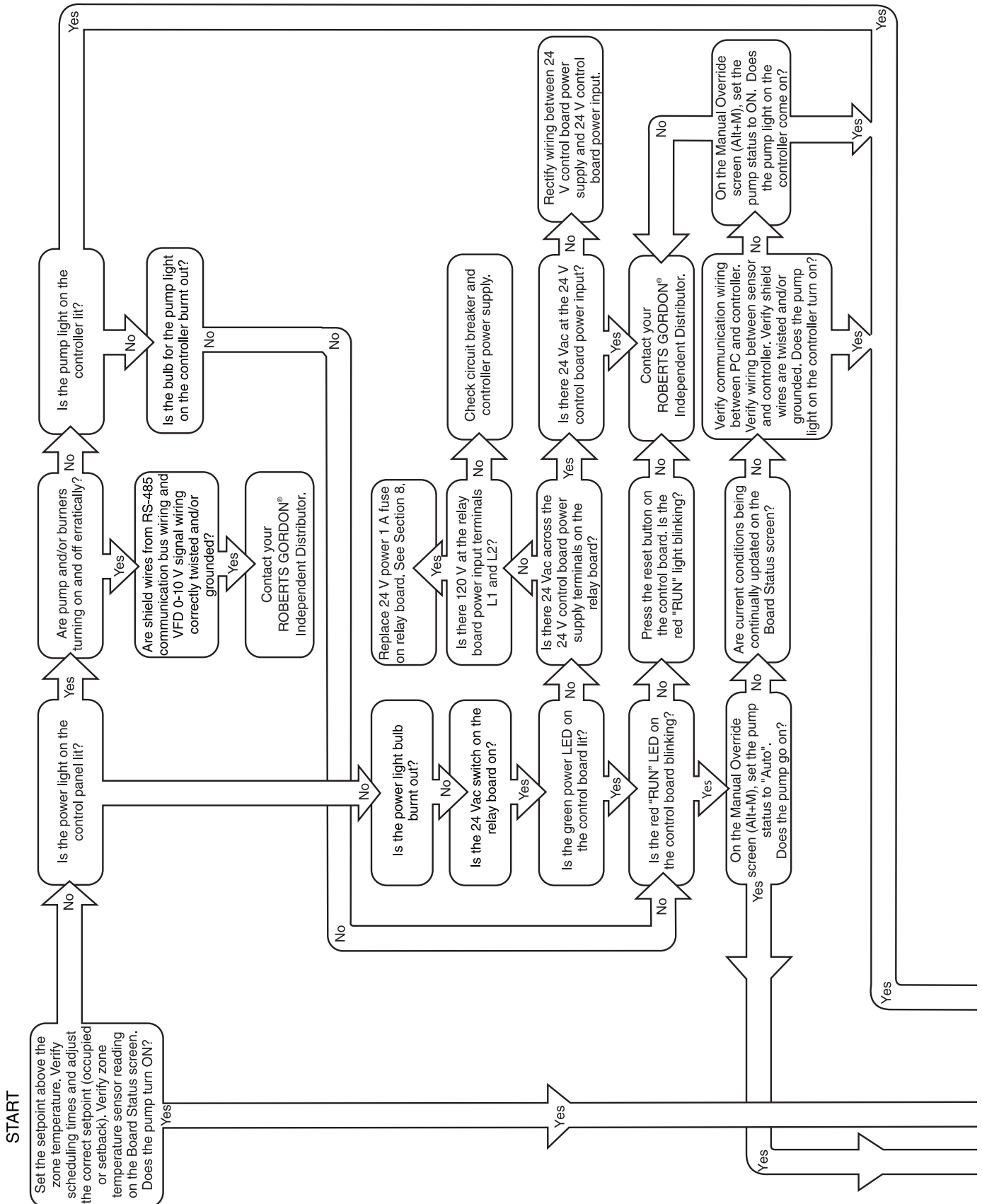

Troubleshooting Flow Chart (continued)

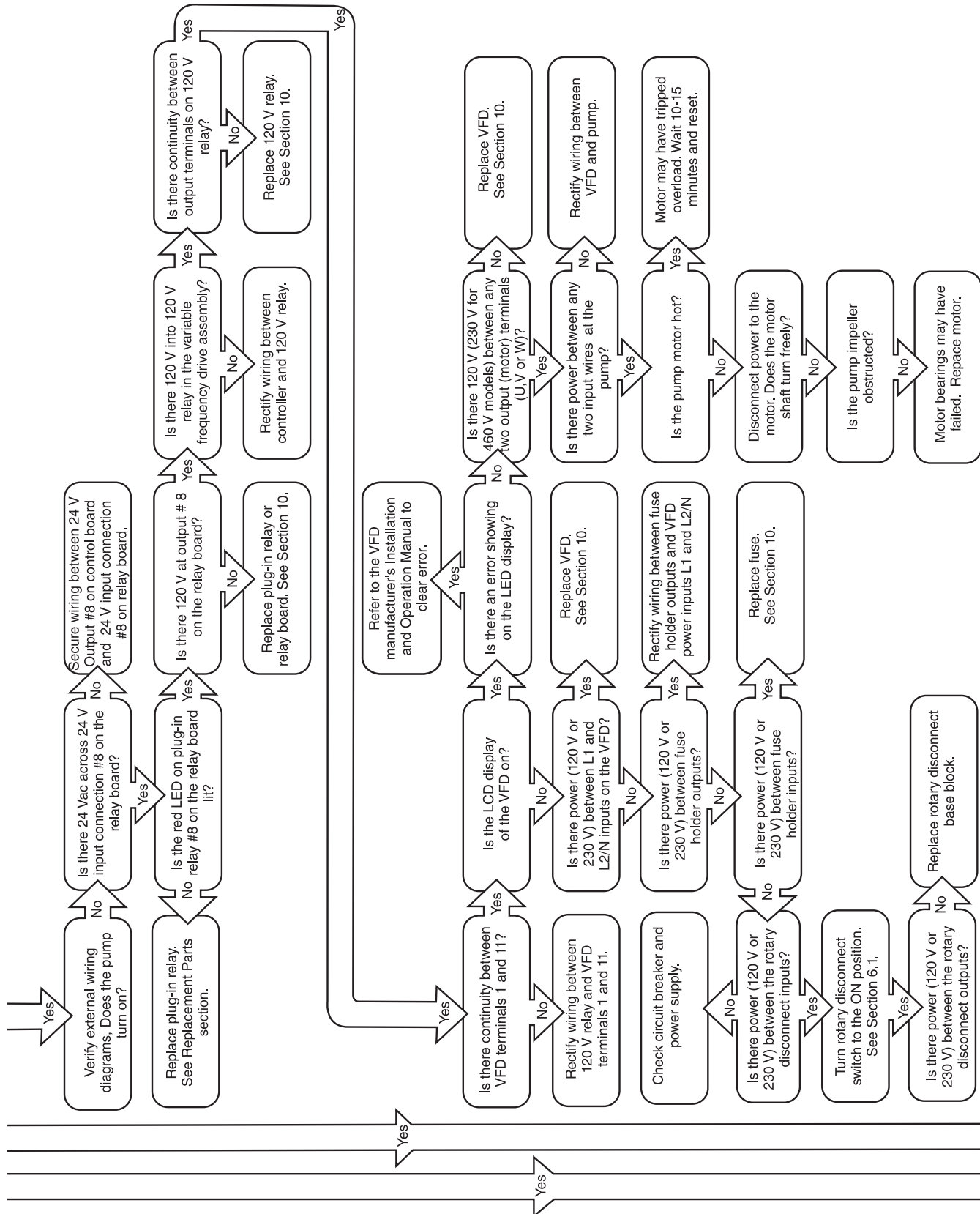

Troubleshooting Flow Chart (continued)

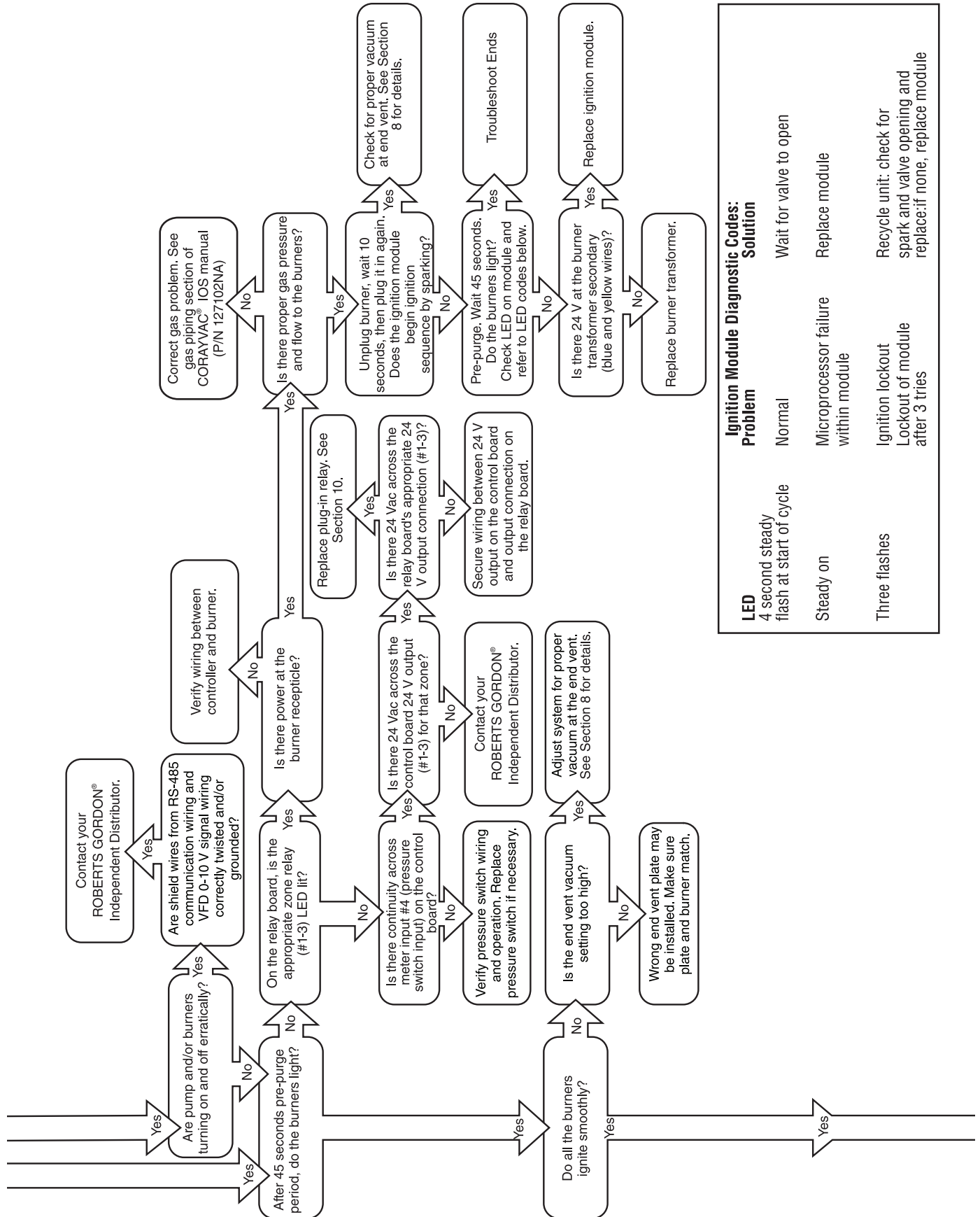

Ignition Module Diagnostic Codes:	
LED	Problem
4 second steady flash at start of cycle	Normal
Steady on	Microprocessor failure within module
Three flashes	Ignition lockout Lockout of module after 3 tries
	Solution
	Wait for valve to open
	Replace module
	Recycle unit: check for spark and valve opening and replace:if none, replace module

Troubleshooting Flow Chart (continued)

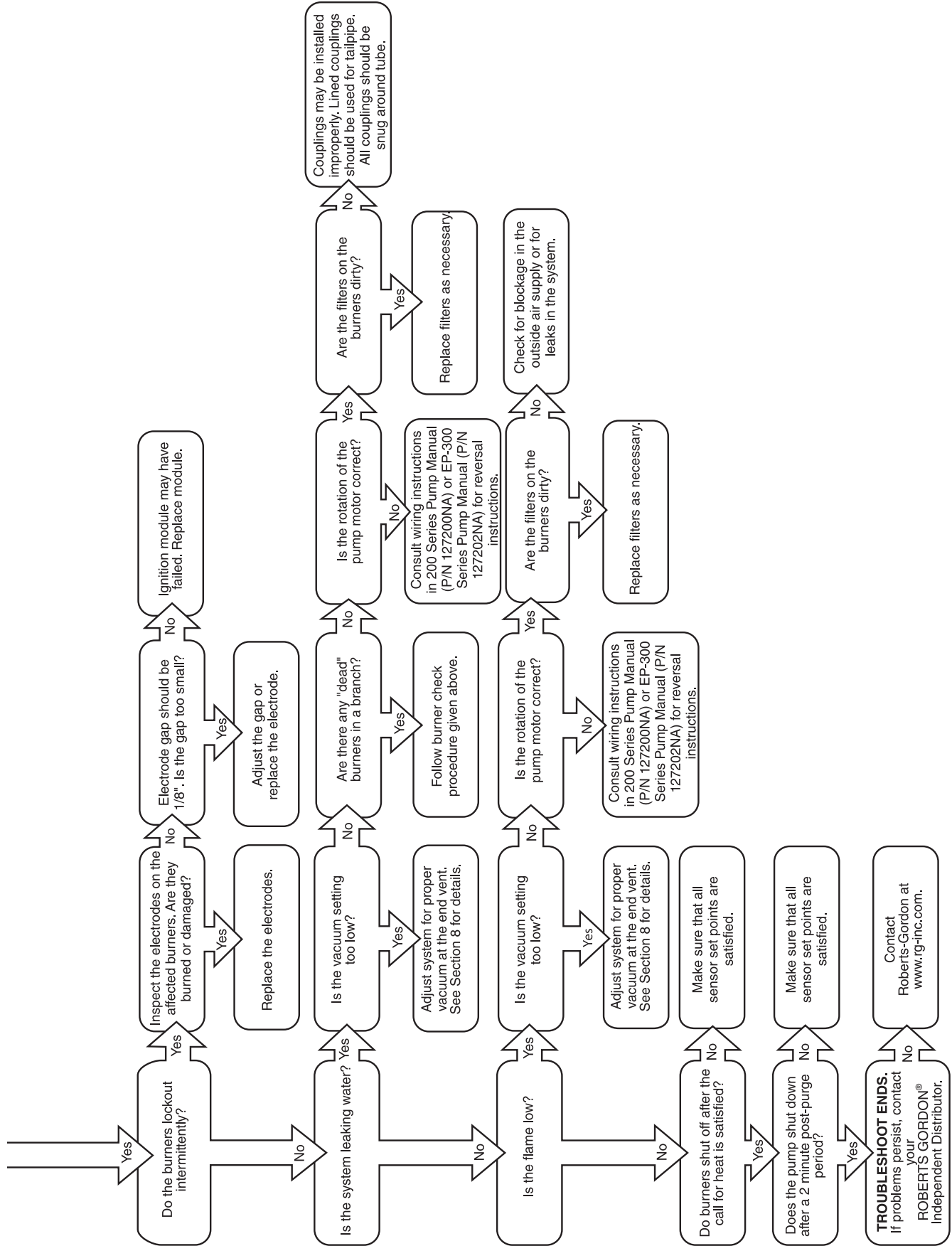

FIGURE 29: Troubleshooting Flow Chart - Repeater

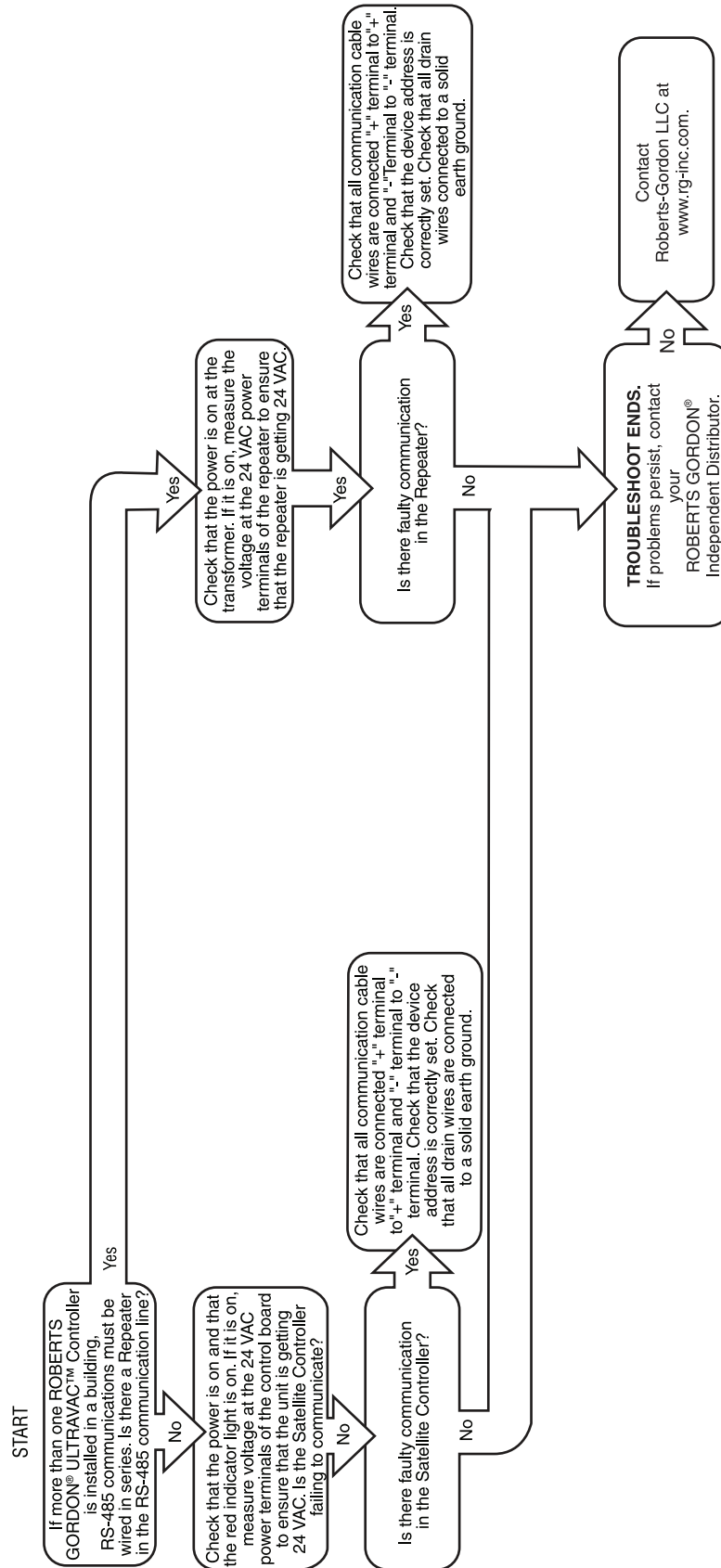
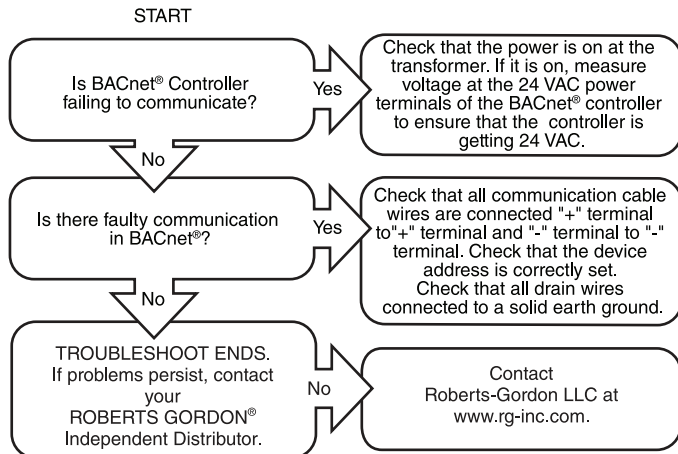





FIGURE 30: Troubleshooting Flow Chart - BACnet®



SECTION 10: REPLACEMENT PARTS

! DANGER		! WARNING	
			
Electrical Shock Hazard	Explosion Hazard	Fire Hazard	Carbon Monoxide Hazard
<p>Use only genuine ROBERTS GORDON® replacement parts per this installation, operation and service manual.</p>			
<p>Failure to follow these instructions can result in death, electric shock, injury or property damage.</p>			

10.1 ROBERTS GORDON® ULTRAVAC™ Controller Replacement Parts

Caution: Use only genuine ROBERTS GORDON® replacement parts. Use of parts not specified by Roberts-Gordon voids warranty.

FIGURE 31: ROBERTS GORDON® ULTRAVAC™ Controller Components Diagram

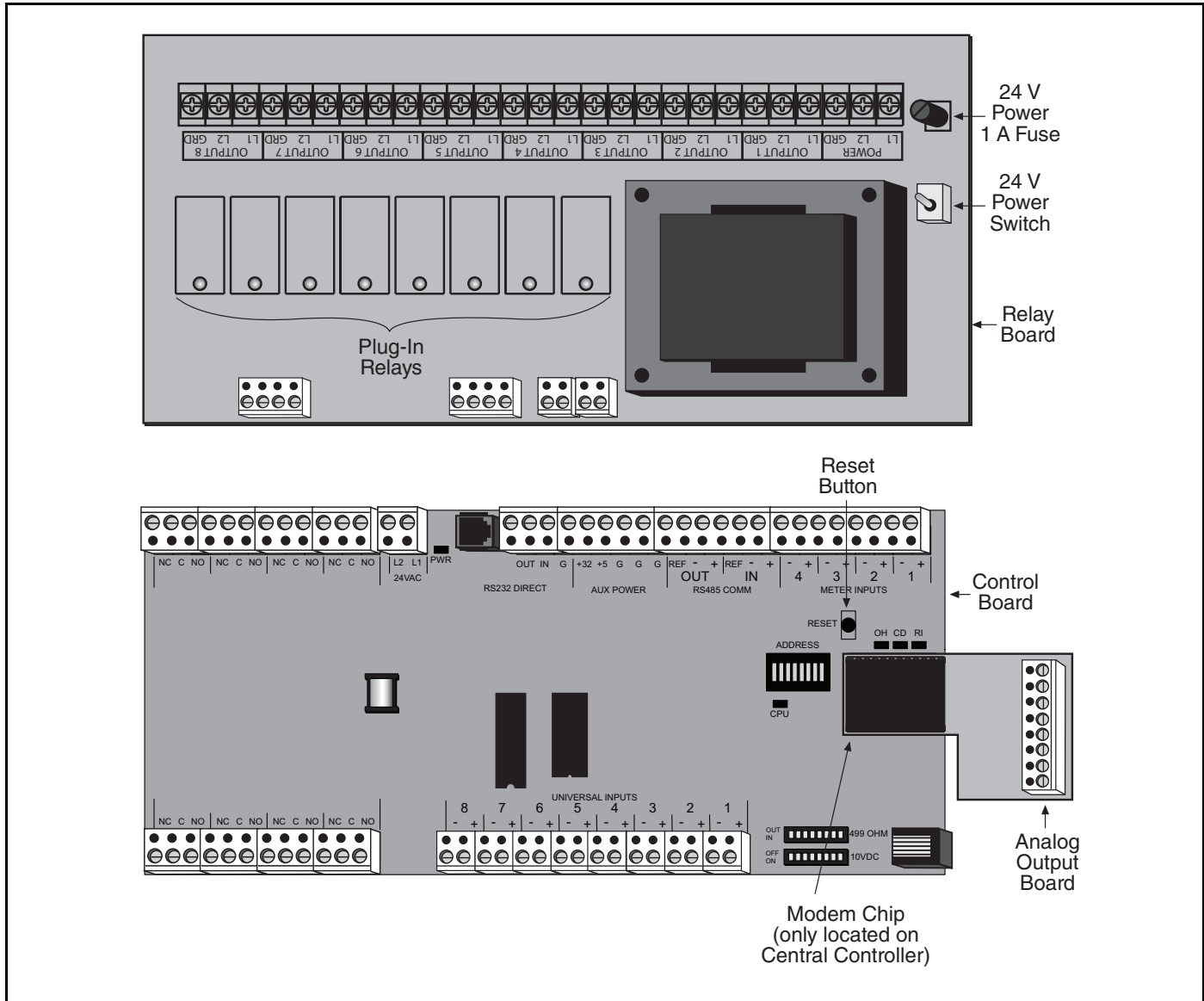

Description	Part Number
Control Board (150 style)	10080102
Relay Board	10080200
Analog Output Board	10080141
URV Eprom Chip (150 Style, current version)	10080122
Plug-In Relay	10080212
Modem Chip (located only on central controller)	10080142
1 A Fuse (Relay Board)	10080211
ROBERTS GORDON® ULTRAVAC™ Indoor Sensor °F (not shown)	10081500
ROBERTS GORDON® ULTRAVAC™ Outdoor Sensor (not shown)	10081501
ROBERTS GORDON® ULTRAVAC™ Indoor Sensor °C (not shown)	10081502
PC Connection Cable Package (not shown)	10080410
RS-485 Converter Package (not shown)	10080430
Kit, TCP/IP Communication Module (not shown)	10080440K
Telephone Sharing Device, 4 port	10080600

Description	Part Number
Relay 120 V Unitary	07100
Lights for 150 Style Control Board	
Lamp Green Enclosure Mount w/o Light	91321614
Lamp Red Enclosure Mount w/o Light	91321615
Light Diode 24 Vac	91321616

10.2 Variable Frequency Drive Replacement Parts

Caution: Use only genuine ROBERTS GORDON® replacement parts. Use of parts not specified by Roberts-Gordon voids warranty.

FIGURE 32: Variable Frequency Drive Components Diagram

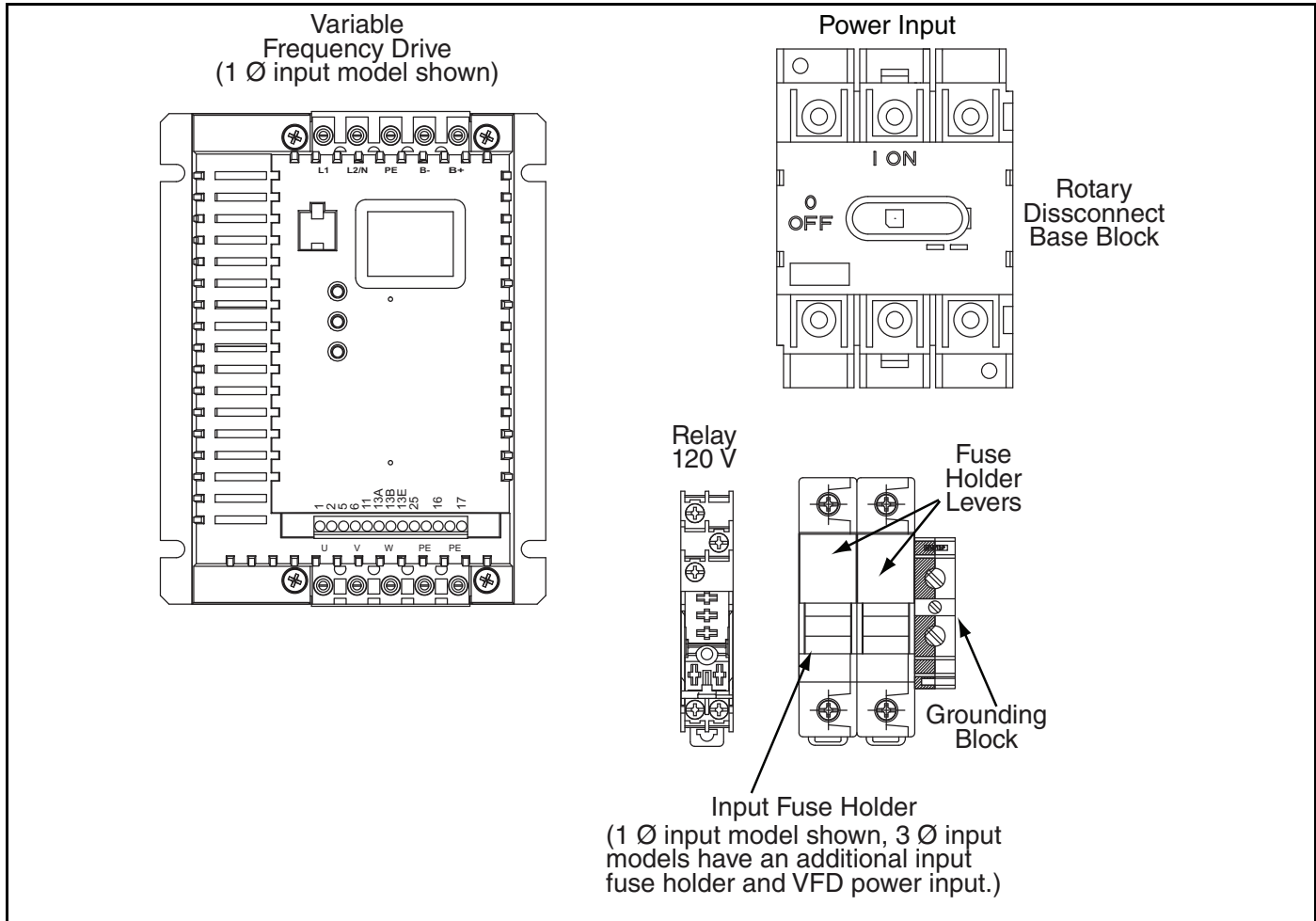

Description	Part Number
Variable Frequency Drive, 1 HP, 120 V, 1 Ø Input (for use with EP-203)	10081201
Variable Frequency Drive, 3/4 HP, 230 V, 1 Ø Input (for use with EP-203)	10081202
Variable Frequency Drive, 2 HP, 230 V, 1 Ø Input (for use with EP-303)	10081203
Variable Frequency Drive, 1 HP, 480 V, 3 Ø Input (for use with EP-203)	10081204
Variable Frequency Drive, 2 HP, 480 V, 3 Ø Input (for use with EP-303)	10081205
Relay, 120 V	90429100
Fuse 10 A (for .75 HP 230 V VFD, 1 HP 480 V VFD and 2 HP 480 V VFD)	91321410
Fuse 25 A (for 1 HP 120 V VFD and 2 HP 230 V VFD)	91321425
Grounding Block	91321300
Fuse Holder	91321400
Rotary Disconnect Base Block	91321550
Rotary Disconnect Handle (not shown)	91321551
Rotary Disconnect Rod (not shown)	91321552

10.3 ULTRAVAC™ BMS Link Controller Replacement Parts

FIGURE 33: ULTRAVAC™ BMS Link Controller Components Diagram

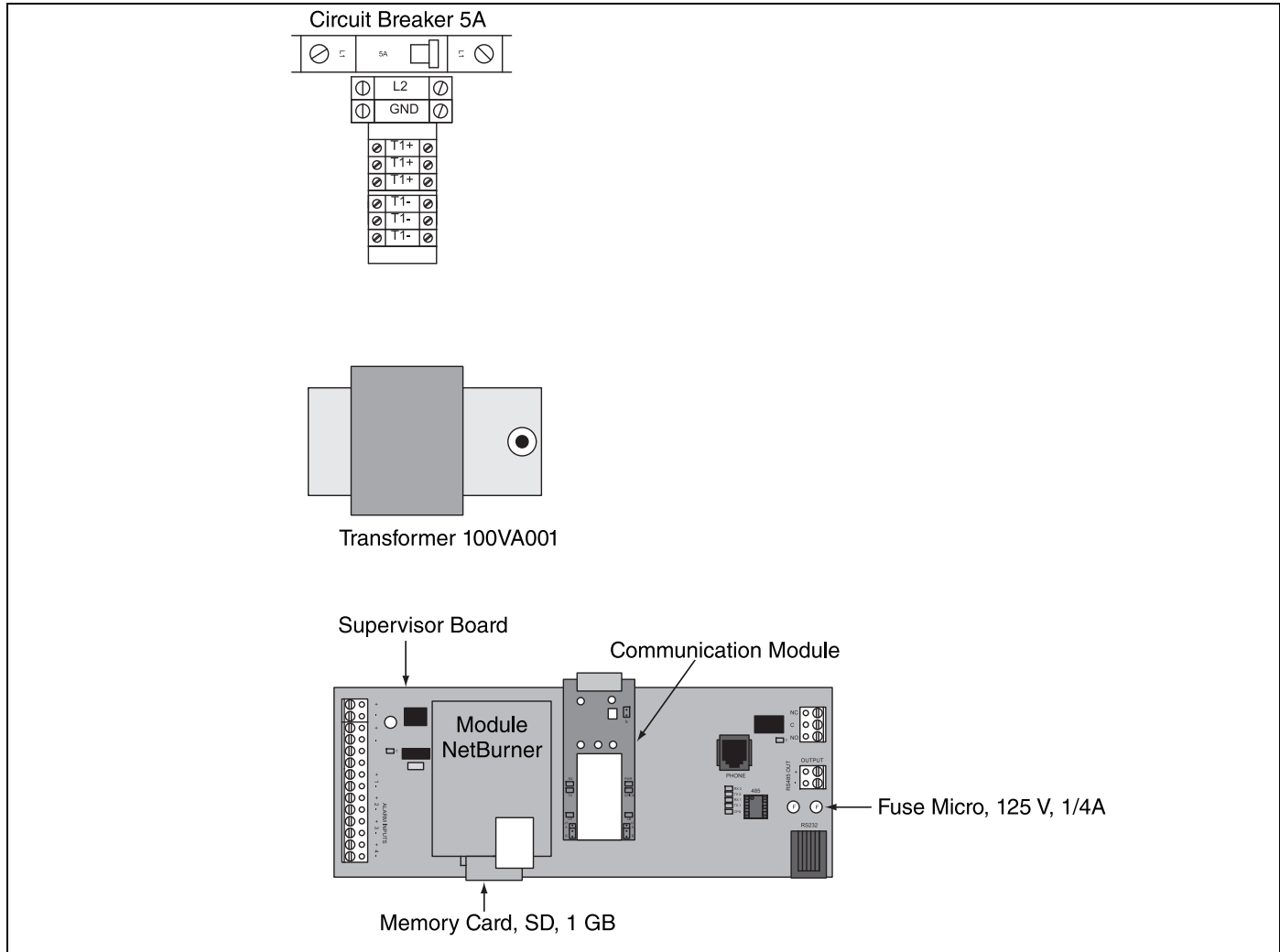

Description	Part Number
Communication Module	10081610
Supervisor Board	10081630
Module NetBurner	10081640
Circuit Breaker 5A	10081650
Transformer 100VA001	10081660
Memory Card, SD, 16 GB	10081680
Fuse Micro, 125 V, 1/4A	10081690

10.4 Repeater Replacement Parts

FIGURE 34: Repeater Components Diagram

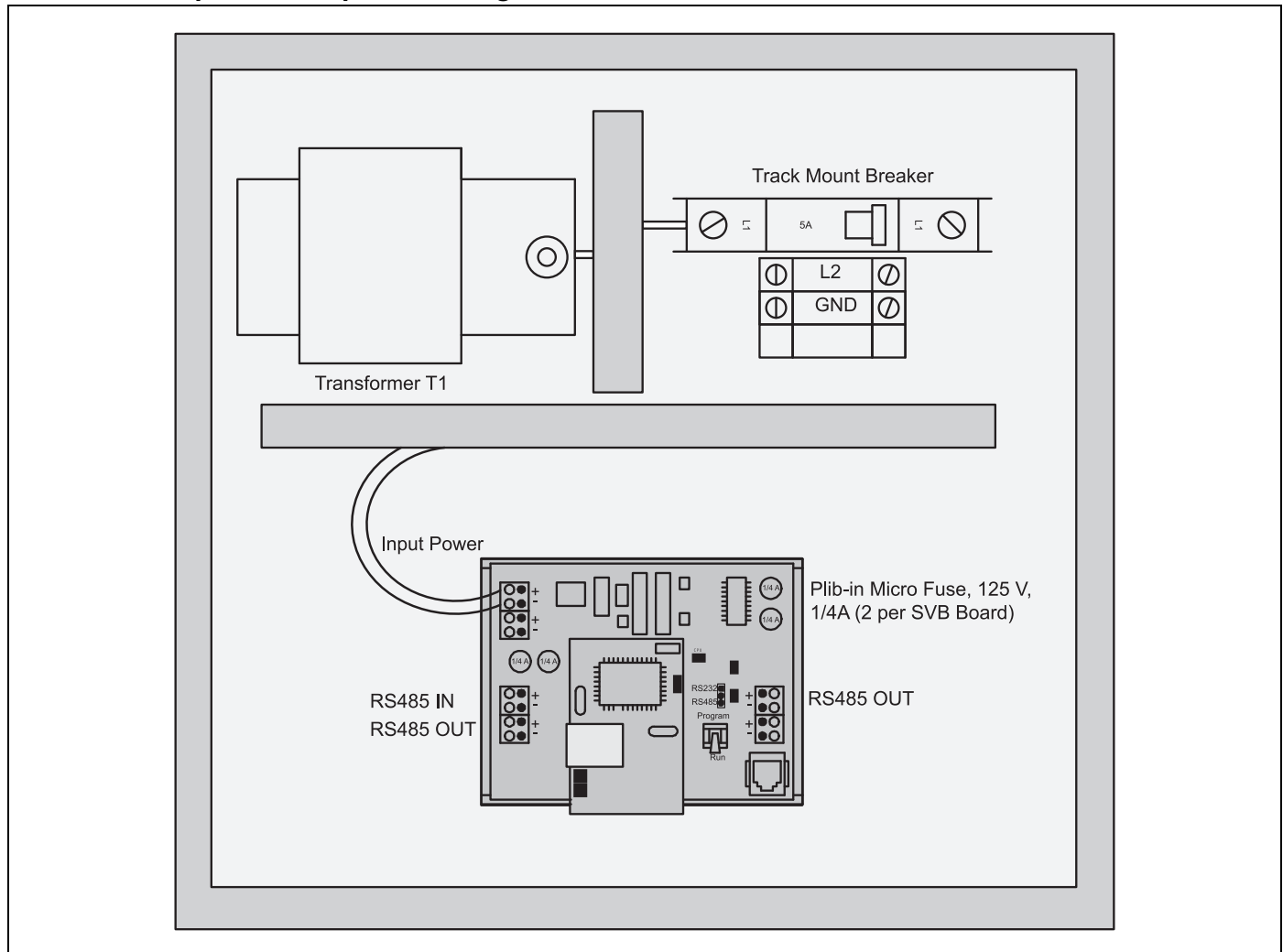

Description	Part Number
Repeater	10080445
Circuit Breaker 5A	10081650
Transformer	10081661
Micro Fuse, 125 V, 1/4A	10081690

10.5 Replacement Parts Instructions

⚠ DANGER

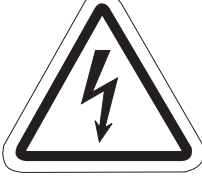

Electrical Shock Hazard

Disconnect electric before service.

Controller must be properly grounded to an electrical source.

Failure to follow these instructions can result in death or electrical shock.

10.5.1 Plug-In Relay

To replace the plug-in relay, turn off 120 V power to the relay board. Turn off the 24 V power switch on the relay board. Locate the malfunctioning relay and pull the relay from its socket.

Fit a new relay in the socket. Return 120 V power to the relay board and turn on the 24 V power switch on the relay board. Press the reset button on the control board and close the doors.

10.5.2 Control Board Power LED

The LED is linked to the 24 Vac input which supplies the control board with power. If the LED is not lit, there is no power to the board. If this is the case, check the 120 V power wiring to the relay board, the 24 Vac power wiring from the relay board to the control board and the 24 V power 1 A fuse.

10.5.3 10080122 Eprom Chip

The Eprom is where the controller's program (not settings) is stored. To take out the Eprom. The following steps must be taken:

Turn off the power to the control board by turning off the 24 V power switch on the relay board.

Locate the Eprom and with a small terminal screw driver placed underneath the device, pry the Eprom out of the socket.

To fit a new Eprom, look for the notch on one end of the Eprom. There is a notch on the socket and a notch on the Eprom. The Eprom should be fit so that the notch on the socket and the Eprom are aligned.

Turn on the 24 V power switch on the relay board, press the reset button on the control board and close

the doors.

10.5.4 24V Power 1 A Fuse

To replace the 1 A fuse, turn off power to the relay board and turn off the 24 V power switch on the relay board.

Locate the 1A fuse and remove it from its socket using a flathead screwdriver. Twist the fuse a 1/4 turn counter-clockwise until the fuse pops out of the socket. Replace it with a new fuse.

Slide the fuse back into the socket, press down and turn the fuse a 1/4 turn clockwise until secure.

Return 120 V power to the relay board and turn on the 24 V power switch on the relay board. Press the reset button on the control board and close the doors.

10.5.5 Variable Frequency Drive (VFD)

To replace the Variable Frequency Drive, turn off all power to the drive assembly at the breaker or disconnect switch. Turn off 120 V power to the relay board inside the ROBERTS GORDON® ULTRAVAC™ Controller. Turn off the 24 V power switch on the relay board.

Mark all wires connected to the VFD, noting the terminals that they are secured to. Remove all wires from the VFD terminals.

Remove the VFD from its mounting plate by removing the four securing screws.

Verify that the input voltage noted on the rating plate of the VFD matches the input voltage of the old VFD. Secure the new VFD to the mounting plate with the four screws. Return all wires to the correct VFD terminals. If possible, it may be easier to partially re-wire the new VFD before mounting it to the mounting plate.

Close the door and return power to the VFD. Return 120 V power to the relay board. Turn on the 24 V power switch on the relay board. Press the reset button on the control board and close the doors.

10.5.6 Variable Frequency Drive 25 A or 10 A Fuse

To replace a fuse, turn off input power to the variable frequency drive assembly at the breaker or disconnect switch.

Turn off 120 V power to the relay board inside the ROBERTS GORDON® ULTRAVAC™ Controller. Turn off the 24 V power switch on the relay board.

Inside the VFD assembly, open the fuse holder by

pulling down the lever to expose the fuse. Remove the old fuse and insert a new fuse. Verify the correct fuse rating, 25 A for 1 HP 120 V VFD or 2 HP 230 V VFD, 10 A for the .75 HP 230 V VFD, 1 HP 480 V VFD and 2 HP 480 V VFD. Close the fuse holder. Return power to the VFD assembly and verify that the VFD LCD screen is on. (dashes displayed). Close the VFD assembly door.

Return 120 V power to the relay board. Turn on 24 V power switch on the relay board. Press the reset button on the control board and close the doors.

SECTION 11: THE ROBERTS GORDON® ULTRAVAC™ LIMITED WARRANTY

Within 36 months from date of purchase by buyer or 42 months from date of shipment by Roberts-Gordon (whichever occurs first), replacement parts will be provided free of charge for any part of the product which fails due to a manufacturing or material defect.

Roberts-Gordon will require the part in question to be returned to the factory. Roberts-Gordon will, at its sole discretion, repair or replace after determining the nature of the defect and disposition of part in question.

ROBERTS GORDON® Replacement Parts are warranted for a period of 12 months from date of shipment from Roberts-Gordon or the remaining ROBERTS GORDON® System Control warranty.

ROBERTS-GORDON WILL NOT PAY FOR:

Service trips, service calls and labor charges.

Shipment of replacement parts.

Claims where the total price of the goods have not been paid.

Damage due to:

- Improper installation, operation or maintenance.
- Misuse, abuse, neglect, or modification of the ROBERTS GORDON® ULTRAVAC™ in any way.
- Use of the ROBERTS GORDON® ULTRAVAC™ for other than its intended purpose.
- Incorrect gas or electrical supply, accident, fire, floods, acts of God, war, terrorism, or other casualty.
- Improper service, use of replacement parts or accessories not specified by Roberts-Gordon.
- Failure to install or maintain the ROBERTS GORDON® ULTRAVAC™ as directed in the Installation, Operation and Service Manual.
- Relocation of the ROBERTS GORDON® ULTRAVAC™ after initial installation
- The use of the ROBERTS GORDON® ULTRAVAC™ in a corrosive atmosphere containing contaminants.
- The use of the ROBERTS GORDON® ULTRAVAC™ in the vicinity of a combustible or explosive material.
- Any defect in the ROBERTS GORDON® ULTRAVAC™ arising from a drawing, design, or specification supplied by or on behalf of the consumer.
- Damage incurred during shipment. Claim must be filed with carrier.

WARRANTY IS VOID IF:

The ROBERTS GORDON® ULTRAVAC™ is not installed by an electrician qualified in the installation and service of control systems for heating equipment.

You cannot prove original purchase date and required annual maintenance history.

The data plate and/or serial number are removed, defaced, modified or altered in any way.

The ownership of the ROBERTS GORDON® ULTRAVAC™ is moved or transferred. This warranty is nontransferable.

Roberts-Gordon is not permitted to inspect the damaged controller and/or component parts.

READ YOUR INSTALLATION, OPERATION AND SERVICE MANUAL.

If you have questions about your control, contact your installing professional. Should you need Replacement Parts or have additional questions, call or write:

Roberts-Gordon

1250 William Street

P.O. Box 44

Buffalo, New York 14240-0044

716.852.4400

On the web at: www.rg-inc.com

Roberts-Gordon's liability, and your exclusive remedy, under this warranty or any implied warranty (including the implied warranties of merchantability and fitness for a particular purpose) is limited to providing replacement parts during the term of this warranty.

Some jurisdictions do not allow limitations on how long an implied warranty lasts, so this limitation may not apply to you. There are no rights, warranties or conditions, expressed or implied, statutory or otherwise, other than those contained in this warranty.

Roberts-Gordon shall in no event be responsible for incidental or consequential damages or incur liability for damages in excess of the amount paid by you for the ROBERTS GORDON® ULTRAVAC™. Some jurisdictions do not allow the exclusion or limitation of incidental or consequential damages, so this limitation or exclusion may not apply to you. This warranty gives you specific legal rights, and you may also have other rights which vary from jurisdiction to jurisdiction.

Roberts-Gordon shall not be responsible for failure to perform under the terms of this warranty if caused by circumstances out of its control, including but not limited to war, fire, flood, strike, government or court orders, acts of God, terrorism, unavailability of supplies, parts or power. No person is authorized to assume for Roberts-Gordon any other warranty, obligation or liability.

LIMITATIONS ON AUTHORITY OF REPRESENTATIVES:

No representative of Roberts-Gordon, other than an Executive Officer, has authority to change or extend these provisions. Changes or extensions shall be binding only if confirmed in writing by Roberts-Gordon's duly authorized Executive Officer.

Free Manuals Download Website

<http://myh66.com>

<http://usermanuals.us>

<http://www.somanuals.com>

<http://www.4manuals.cc>

<http://www.manual-lib.com>

<http://www.404manual.com>

<http://www.luxmanual.com>

<http://aubethermostatmanual.com>

Golf course search by state

<http://golfingnear.com>

Email search by domain

<http://emailbydomain.com>

Auto manuals search

<http://auto.somanuals.com>

TV manuals search

<http://tv.somanuals.com>