

ROBERTS

Sound for Generations



CD9949

Stereo CD Radio
Cassette Recorder with



Symphony

Please read this manual before use

<i>Contents</i>	1
<i>Controls</i>	2
<i>Battery Operation</i>	3
<i>Mains Operation</i>	3
<i>Operating the radio</i>	4
<i>Presetting stations</i>	5
<i>Recalling a preset station</i>	6
<i>Inserting a CD</i>	7
<i>Playing a CD</i>	7
<i>CD bookmark</i>	8
<i>Selecting a track</i>	9
<i>Search function</i>	9
<i>Repeat play</i>	9
<i>Listening to cassette tapes</i>	10
<i>Recording from the radio</i>	11
<i>Recording from CD</i>	12
<i>Recording from the internal microphone</i>	12
<i>Recording from an external microphone</i>	13
<i>Preventing accidental erasure</i>	14
<i>Cleaning tape heads</i>	14
<i>Headphones</i>	15
<i>Specification</i>	16
<i>Circuit features</i>	16
<i>Mains supply</i>	17
<i>Guarantee</i>	18

**CLASS 1
LASER PRODUCT**

Warning

CLASS 1 LASER PRODUCT means that the laser's construction makes it inherently safe so that the legally prescribed maximum permissible radiation values can never be exceeded

Caution: Using any equipment or devices other than those described and specified in these operating instructions, or tampering with the unit in any way, can result in dangerous exposure to radiation.

Controls

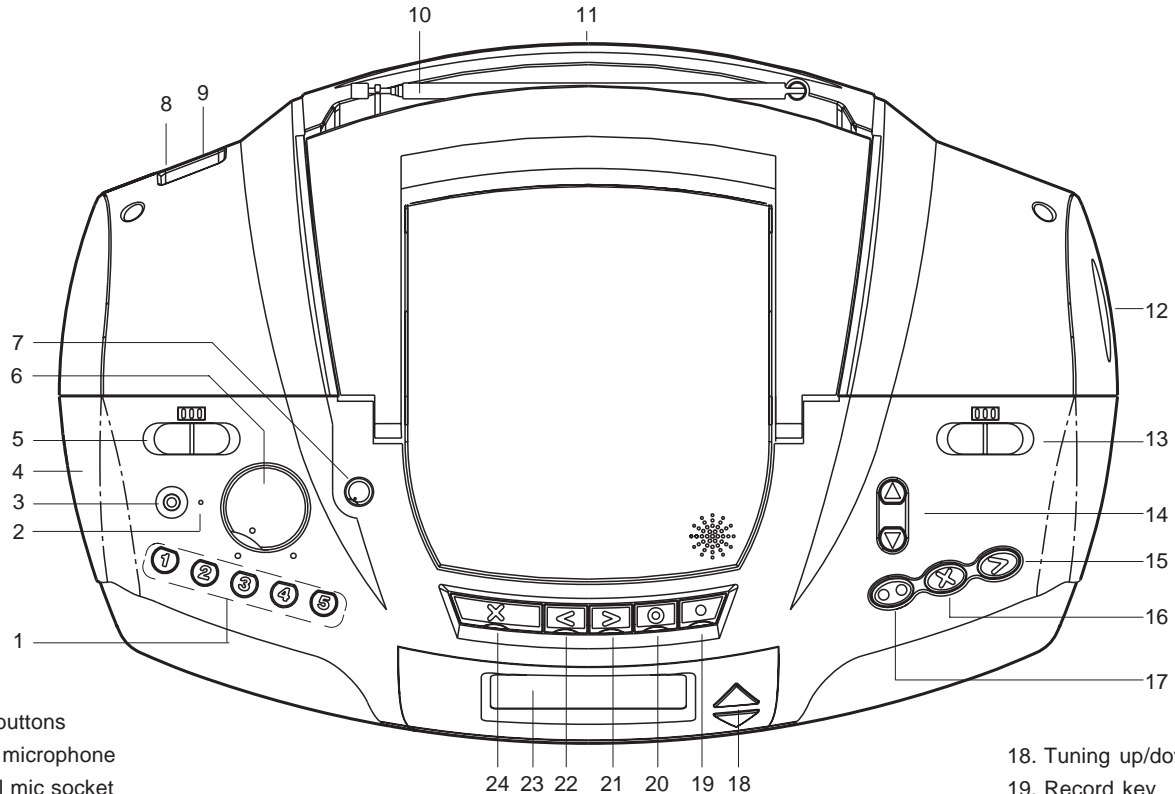

1. Preset buttons
2. Internal microphone
3. External mic socket
4. Headphone socket
5. Function switch
6. Volume control
7. Tone control
8. FM mono/stereo switch

9. Mains socket
10. Telescopic aerial
11. Battery compartment
12. Tuning tone volume
13. Waveband switch

14. CD track up/down buttons
15. CD Play/Pause button
16. CD Stop button
17. CD repeat button

18. Tuning up/down buttons
19. Record key
20. Play key
21. Rewind key
22. Fast forward key
23. LCD display
24. Stop key

Battery operation

1. Remove the **Battery cover** on the rear of your CD radio cassette by pushing the catches in the direction shown.
2. Insert eight LR14 (C size) batteries into the compartment. Take care to ensure all batteries are inserted with the correct polarity as shown inside the battery compartment. Replace the battery cover.
3. Reduced power, distortion, and a 'stuttering' sound are all signs that the batteries may need replacing.

We would recommend for economy that your CD9949 is used on the mains whenever possible with battery operation for occasional or stand-by use only.

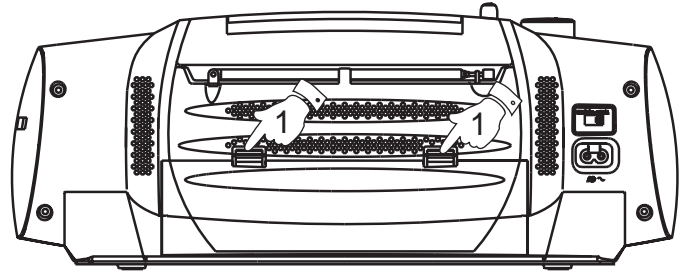

Mains operation

1. Place your CD radio cassette on a flat surface.
2. Plug the mains lead into the **Socket** located on the rear of your CD radio cassette. Ensure that the plug is pushed fully into the socket.
3. Plug the other end into a wall socket and switch on.
4. Do not allow this unit to be exposed to moisture (e.g. dripping or splashing). Do not leave your radio where excessive heat could cause damage such as in a parked car where the heat from the sun can build up even though the outside temperature may not seem too high.

Note: The unit remains connected to the mains even when it is switched off. The unit is only isolated from the mains if the mains plug is removed from the wall socket.

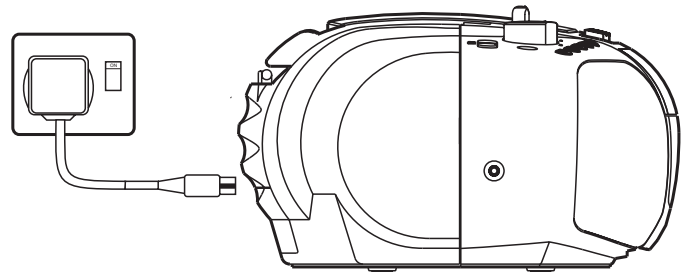

Operating the radio

1. Slide **Function switch** to the *Radio* position.
2. Slide **Waveband switch** to select the required wave band . For the FM waveband fully extend the **Telescopic aerial** angle and rotate, if necessary, to obtain best reception.
3. Press and hold down either the **Tuning up** or **Tuning down** buttons for more than 0.5 sec to commence scan tuning. An audible tone will be heard indicating that the radio is tuning. The tone will increase in pitch for tuning up and decrease in pitch for tuning down.
4. Your radio will scan the selected waveband, sound a beep tone and stop automatically when it finds a station of sufficient strength.
5. To recommence scan tuning, press and hold down either the **Tuning up** or **Tuning down** buttons for more than 0.5 sec.
6. When the waveband end is reached the radio will beep and continue tuning from the opposite waveband end.
7. Adjust the **Volume** and **Tone controls** to the desired settings.
8. To switch off your radio slide the **Function switch** to the *Off/Tape* position.

Note: On FM if a station being received is weak some hiss may be audible. To reduce the hiss slide the FM Stereo/Mono switch (on rear) to the mono position. The stereo indicator will be removed from the display.

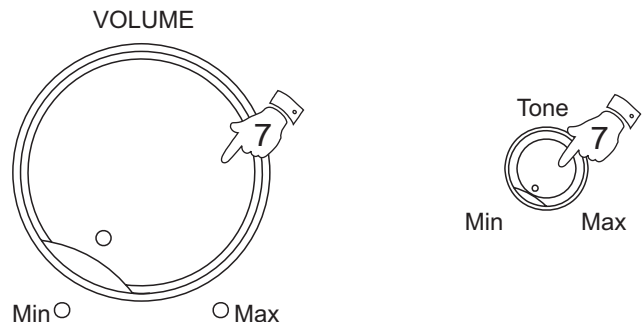
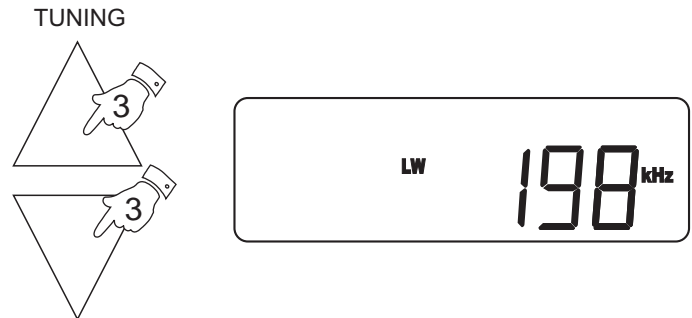
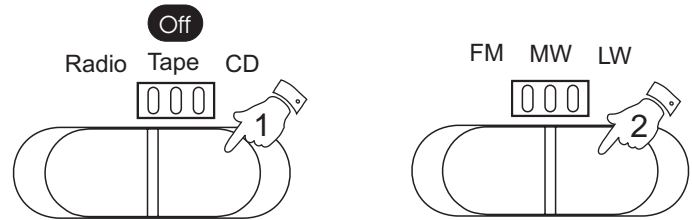

Presetting stations

You may preset up to 15 different stations, 5 on FM, 5 on MW and 5 on LW.

1. Slide **Function switch** to the *Radio* position to switch on.
2. Slide **Waveband switch** to select the required wave band
3. Tune into a station as previously described on page 4.
4. Press and hold down the required **Preset button** until the radio beeps (greater than 2 seconds) The preset number will appear in the display and the station will be stored under the chosen preset button.
5. Repeat this procedure for the remaining presets.
6. Stations stored in preset memories may be overwritten by following the above procedure.

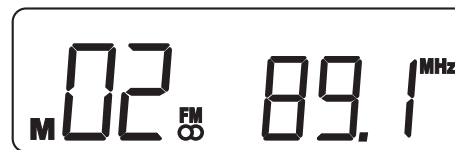
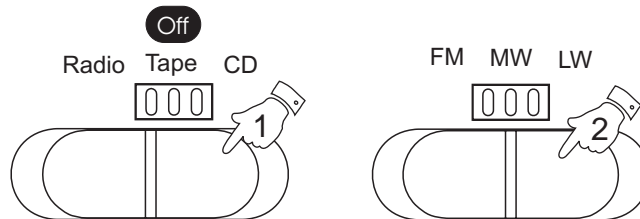

Recalling a preset station

1. Slide **Function switch** to the *Radio* position to switch on.
2. Slide **Waveband switch** to select the required wave band
3. Momentarily press the required **Preset button**, the preset number and station frequency will appear in the display.
4. Adjust the **Volume** and **Tone controls** to the desired settings.
5. To switch off your radio slide the **Function switch** to the *Off/Tape* position.

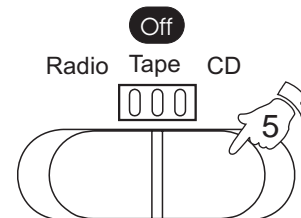
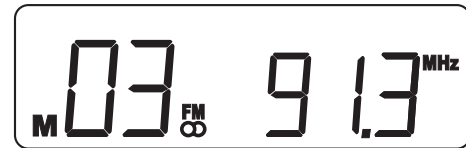
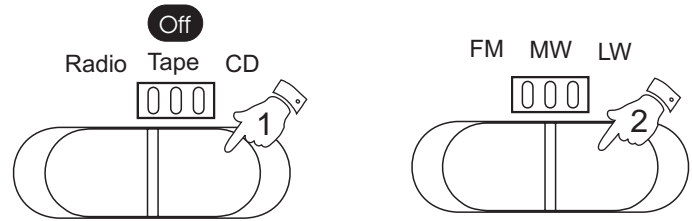

Inserting a CD

1. Slide the **Function switch** to the **CD** position.
2. To open the CD compartment, press the **CD door** on the edge marked Open/Close
3. Insert an Audio CD, printed side facing up. Close the **CD door**. The CD player will scan the contents of the CD and the total number of tracks and total playing time will appear on the display.

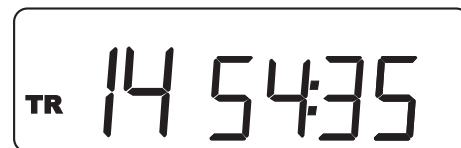
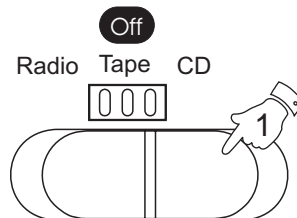

Playing a CD

1. Press the **CD Play/Pause button** to start playback. The display will show the track number and playing time.
2. Adjust the **Volume** and **Tone controls** to the desired settings
3. To pause playback press the **CD Play/Pause button**. The **Play/Pause indicator** will appear in the display. To resume playback press the **CD Play/Pause button** again.
4. To stop playback, press the **CD Stop button**.
5. To remove the CD, open the **CD door** by pressing the edge marked Open/Close. The CD door should only be opened when the CD is in Stop mode.

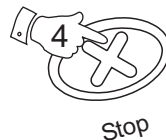
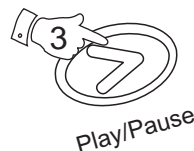

CD bookmark

Your 'Symphony' CD radio cassette recorder has a unique feature called CDBookmark.

Whilst playing a CD simply press stop and your CD unit will automatically remember the last played position ensuring that next time you press Play you return to the same place without losing a single word.

CD bookmark will remember the last played position after switching to radio, tape or even power off mode.

1. Press the **CD Play/Pause button** to start playback. The display will show the track number and playing time.

2. Press the **CD Stop button and** the display will show RESUME together with the track number and CD bookmark time.

3. To resume play at the CD bookmark simply press the **CD Play/Pause button** after several seconds the CD will resume play exactly where you left off.

4. CD bookmark can be cancelled by pressing the **CD Stop button** twice.

CD bookmark will also be cancelled when the end of CD is reached or if the CD door is opened.

Note: Batteries or mains power must be maintained to ensure operation of CD Bookmark.

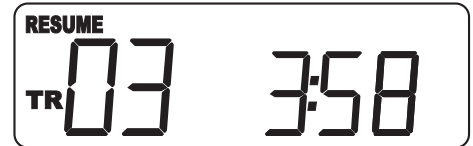
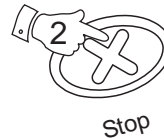
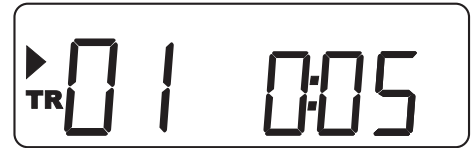

Selecting a track

1. Whilst the CD is playing, press and release either the **Track up** or **Track down buttons** to change to the desired track.
2. You can also change tracks when the player is in stop mode. Change to the desired track using the **Track up** or **Track down buttons** (e.g. to select track 4 press the Track up button 4 times) The selected track will begin to play as soon as the **Track button** is released.

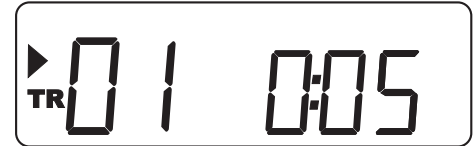
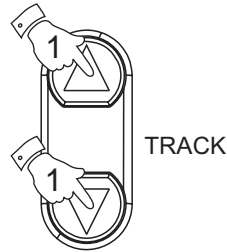

Search function

1. Whilst the CD is playing, press and hold down either the **Track up** or **Track down buttons**. Release the button when the desired part of the track is reached.

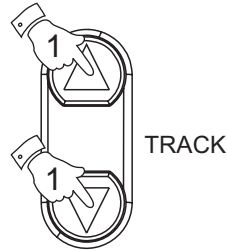

Repeat play

1. Whilst the CD is playing press the **Repeat button** once to repeat the current track. The display will show **REPEAT 1**
2. Press the **Repeat button** again to repeat all tracks on the CD. The display will show **REPEAT ALL**
3. Press the **Repeat button** again to return to normal play.

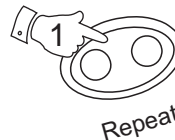

Listening to cassette tapes

Note: This unit is not suitable for recording onto CHROME (IEC II) or METAL (IEC IV) cassettes. For playback any cassette type may be used

1. Slide the **Function switch** to the *Tape* position.
2. Press the **Stop eject key** to open the **Cassette compartment**.
3. Insert a pre-recorded cassette with the tape surface upwards and the side with the desired recording facing towards you.
4. Close the **Cassette compartment**.
5. Depress the **Play key** and adjust the **Volume and Tone controls** to suit your personal taste.
6. Use the **Fast forward** or **Rewind buttons** to locate a specific part of the tape.
7. To stop the tape press the **Stop/Eject button**.

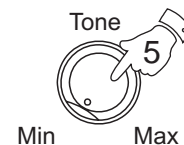
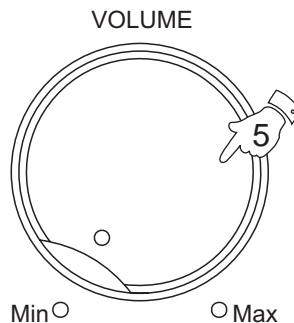
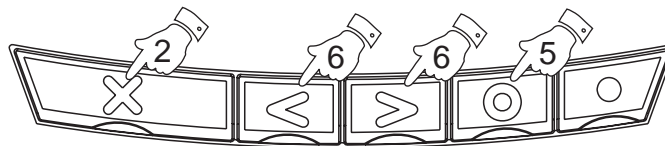
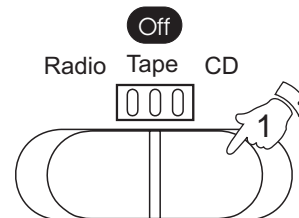

Recording from the Radio

1. Slide the **Function switch** to the *Radio* position.
2. Tune in to the desired station.
3. Adjust the **Volume control** to suit your requirements.
4. Insert a blank cassette with the tape surface uppermost and the side you wish to record on facing towards you.
5. Depress the **Record key** to commence recording.
6. The recording level is set automatically and is not affected by the setting of the **Volume control**.
7. To stop the recording press the **Stop/Eject key**.
8. To switch off your CD radio cassette slide the **Function switch** to the *Tape/Off* position.

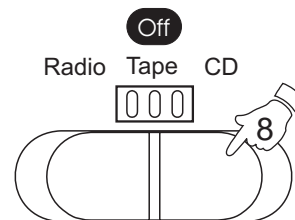
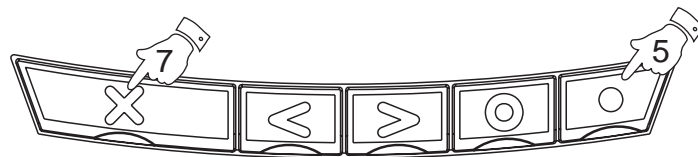
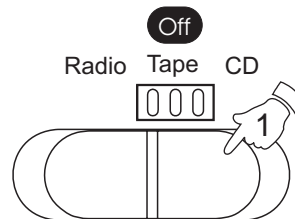

Recording from CD

1. Slide the **Function switch** to the **CD** position.
2. Insert a CD into the compartment. Insert a blank cassette with the tape surface upwards and the side you wish to record on facing towards you.
3. Depress the **Record key** to commence recording. The CD will start automatically (CD syncro start)
4. The recording level is set automatically and is not affected by the setting of the **Volume control**.
5. To stop the recording press the **Stop/Eject key**.

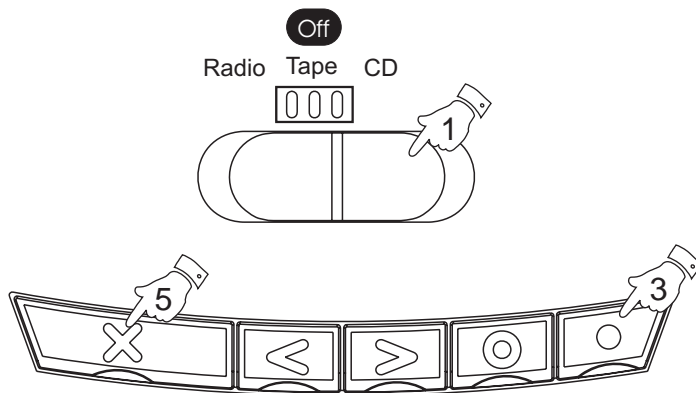

Recording from the internal microphone

1. Slide the **Function switch** to the 'Tape' position.
2. Insert a blank cassette with the tape surface upwards and the side you wish to record on facing towards you.
3. Depress the **Record key** to commence recording.
4. The recording level is set automatically and is not affected by the setting of the **Volume control**.
5. To stop the recording press the **Stop/Eject key**.

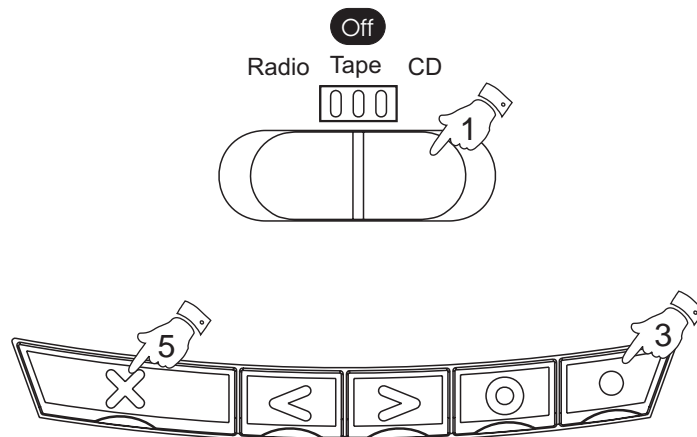

Recording from an external microphone (not included)

When recording from an external microphone the loudspeakers remain connected for monitoring purposes. If you do not wish to hear the recording being made simply rotate the volume control to minimum.

The recording level is set automatically and is not affected by the setting of the **Volume control**.

1. Slide the **Function switch** to the 'Tape' position.
2. Insert a blank cassette with the tape surface upwards and the side you wish to record on facing towards you.
3. Plug the external microphone into the **Microphone socket** located on the left side of the top panel. The internal microphone will be automatically disconnected
4. Depress the **Record key** to commence recording.
5. The recording level is set automatically and is not affected by the setting of the **Volume control**.
6. To stop the recording press the **Stop/Eject key**.

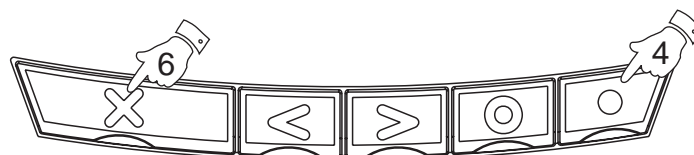
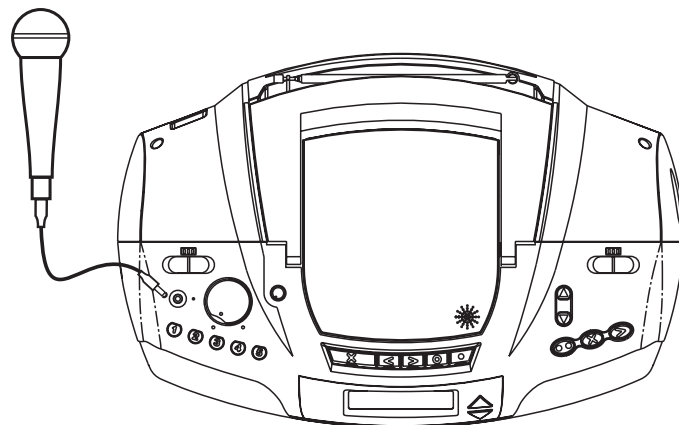
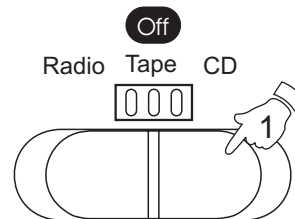

Preventing accidental erasure

1. To safeguard your recordings against accidental erasure, break off the appropriate tab on the cassette as shown .
2. There is one tab for each side of the cassette. This will prevent the **Record button** from being pressed.
3. To restore the cassette to normal, seal the tab openings with a small piece of self-adhesive tape.



Cleaning tape heads

The oxide from magnetic tapes can accumulate on the pinch roller (A) the capstan shaft (B) and also the heads (C and D). This will impair the sound quality.

To clean these parts proceed as follows:-

1. Switch off the power to the unit.
2. Press the **Stop/Eject button**.
3. Press the **Play button** and the heads will be clearly seen.
4. Clean the surfaces (A, B, C, D) with a lint free rag or cotton swab soaked in alcohol. Press the stop/eject button as soon as cleaning is over.

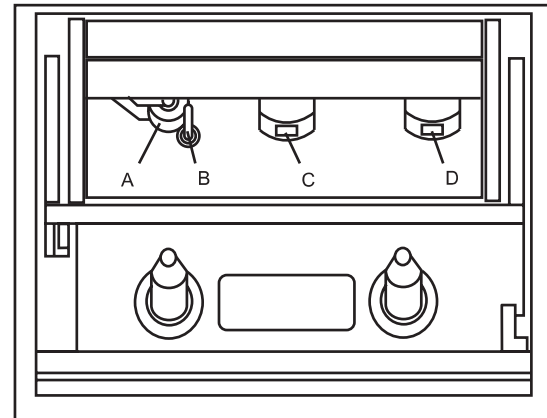

Headphones (not included)

1. A **Headphone Socket** (3.5mm) located on the left hand end of your CD radio cassette is provided for use with either headphones or an earpiece. Inserting the headphone plug automatically mutes the internal loudspeaker.

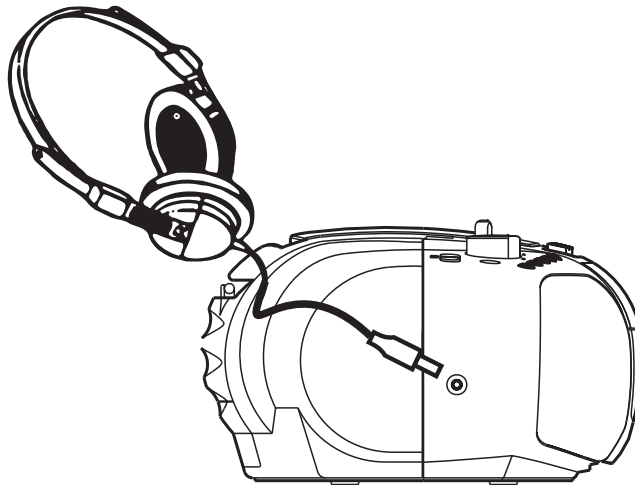

Specifications

Power Requirements

Mains AC 230 volts, 50Hz  only

Batteries 8 x LR14 (C size)

Frequency Coverage

FM 87.5-108MHz

MW 522- 1620kHz

LW 144- 281kHz

Circuit Features

Loudspeaker 2 x 100mm

Output Power 2 x 2.5 Watts

Headphone socket 3.5mm dia

Microphone socket 3.5mm dia

Aerial System FM Telescopic aerial

MW Built-in Ferrite aerial

LW Built-in Ferrite aerial

The Company reserves the right to amend the specification without notice.

Mains supply

Your CD9949 will operate from a supply of AC 230 volts, 50Hz \sim only.

DO NOT cut off the mains plug from this equipment. If the plug fitted is not suitable for the power points in your home or the cable is too short to reach a power point, then obtain an appropriate safety approved extension lead or adaptor. If in doubt consult your dealer.

If nonetheless the mains plug is cut off, remove the fuse and dispose of the plug immediately to avoid a possible shock hazard by inadvertent connection to the mains supply.

If this product is not supplied with a mains plug, or one has to be fitted, then follow the instructions given below:

IMPORTANT. DO NOT make any connection to the larger terminal which is marked with the letter E or by the safety earth symbol \perp or coloured Green or Green-and-yellow.

The wires in the mains lead are coloured in accordance with the following codes :-

BLUE - NEUTRAL

BROWN - LIVE

As these colours may not correspond with the coloured markings identifying the terminals in your plug, proceed as follows:-

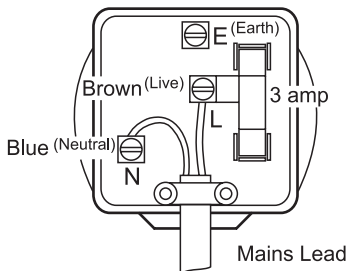

The wire coloured BLUE must be connected to the terminal marked N or coloured BLACK.

The wire coloured BROWN must be connected to the terminal marked L or coloured RED.

Fuse

When replacing the fuse only a 3A ASTA approved to BS1362 type should be used and be sure to re-fit the fuse cover.

IF IN DOUBT - CONSULT A QUALIFIED ELECTRICIAN.

Replacement fuse holders are available from Roberts Radio Technical Services at the address shown on the rear of this manual.

The Nameplate is located on the underside of your CD radio cassette.

Guarantee

This instrument is guaranteed for twelve months from the date of delivery to the original owner against failure due to faulty workmanship or component breakdown, subject to the procedure stated below. Should any component or part fail during this guarantee period it will be repaired or replaced free of charge.

The guarantee does not cover:

1. Damage resulting from incorrect use.
2. Consequential damage.
3. Receivers with removed or defaced serial numbers.

N.B. Damaged or broken telescopic aerials will not be replaced under guarantee.

Procedure:

Any claim under this guarantee should be made through the dealer from whom the instrument was purchased. It is likely that your Roberts' dealer will be able to attend to any defect quickly and efficiently, but should it be necessary the dealer will return the instrument to the company's service department for attention. In the event that it is not possible to return the instrument to the Roberts' dealer from whom it was purchased, please contact Roberts Radio Technical Services department at the address shown on the rear of this booklet before taking further action.

These statements do not affect the statutory rights of a consumer.

ROBERTS RADIO TECHNICAL SERVICES DEPARTMENT

97-99 Worton Road

Isleworth Middlesex

TW7 6EG

Technical Helpline:- 020 8758 0338 *(Mon-Fri)*

Issue 1



Free Manuals Download Website

<http://myh66.com>

<http://usermanuals.us>

<http://www.somanuals.com>

<http://www.4manuals.cc>

<http://www.manual-lib.com>

<http://www.404manual.com>

<http://www.luxmanual.com>

<http://aubethermostatmanual.com>

Golf course search by state

<http://golfingnear.com>

Email search by domain

<http://emailbydomain.com>

Auto manuals search

<http://auto.somanuals.com>

TV manuals search

<http://tv.somanuals.com>