

# ROBERTS

Sound for Generations

*time*  
**Set for life!**

## CR9919

time cube clock radio  
with atomic clock accuracy

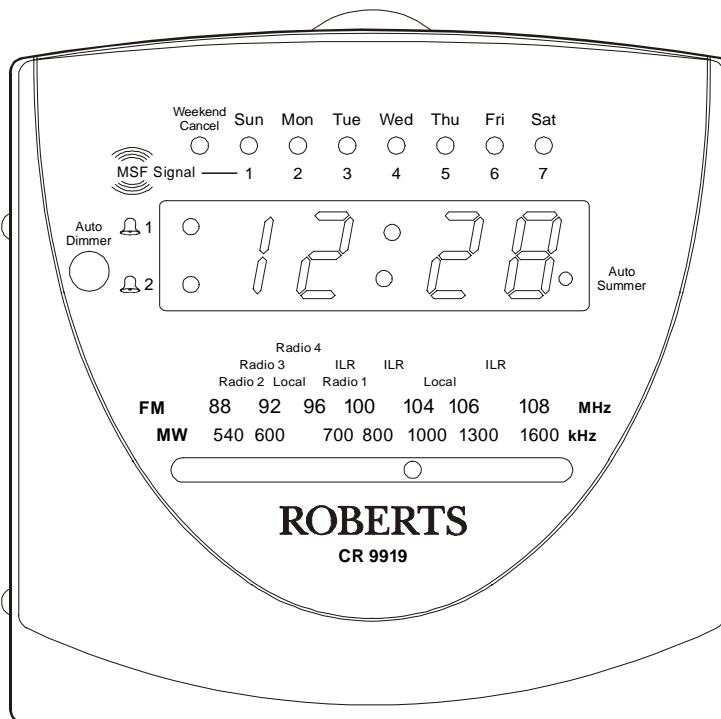

Please read this manual before use

## Controls (top)

1. On/Off button
2. Sleep button
3. Time button
4. Week end cancel button
5. Volume control
6. Headphone socket (on rear)
7. Alarm 2 button
8. Alarm 1 button
9. Forward button
10. Snooze button
11. Reverse button

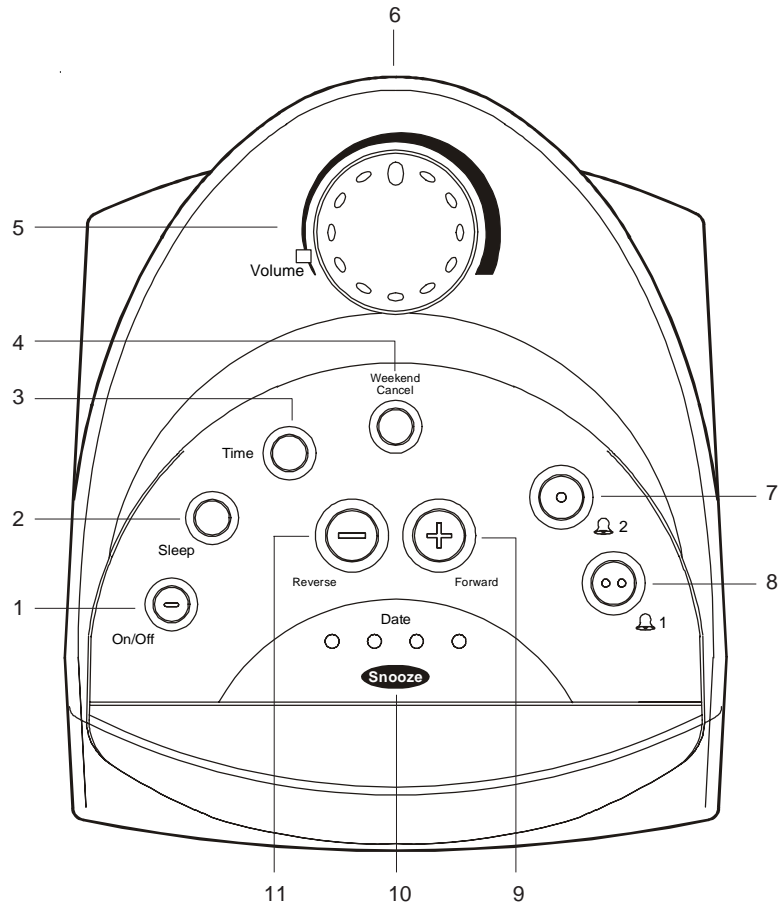

## Controls (front)

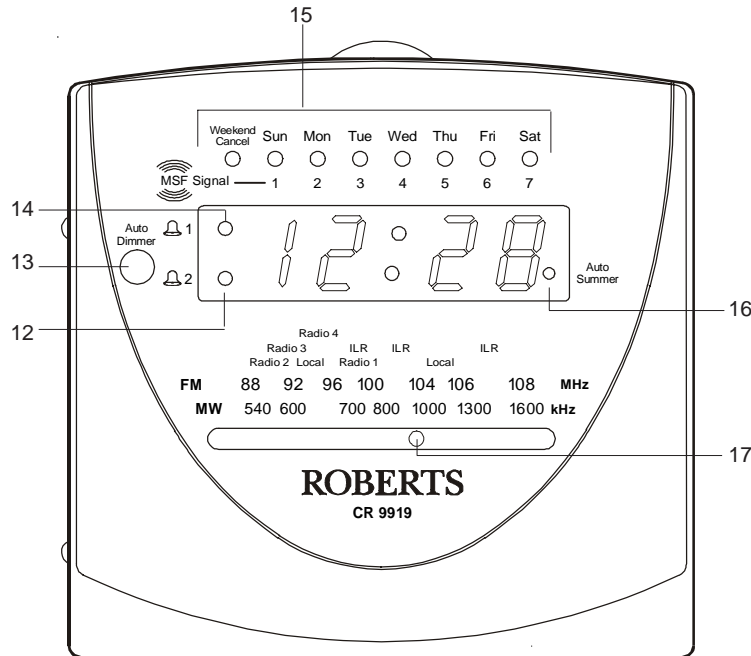

- 12. Alarm 2 indicator
- 13. Auto dimmer
- 14. Alarm 1 indicator
- 15. MSF signal/Day of week indicators
- 16. Auto summer indicator
- 17. LED dial pointer
- 18. Time Capsule

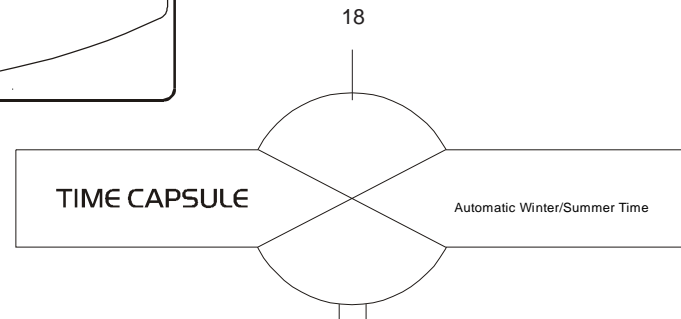

If you need any further advice, please call our Technical Helpline on :-  
020 8758 0338 (Mon-Fri)

Controls (left side)

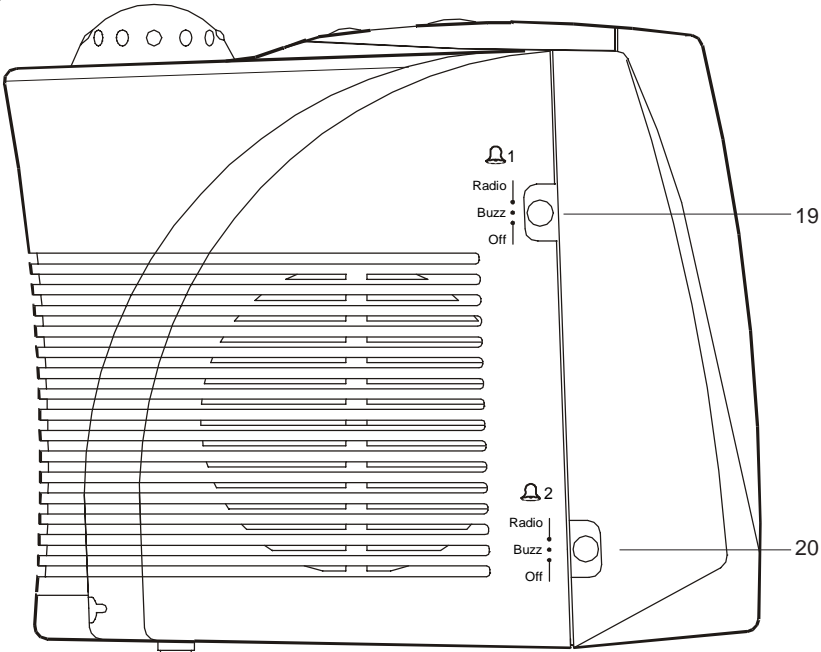

- 19. Alarm 1 function switch
- 20. Alarm 2 function switch

**Controls (right side)**

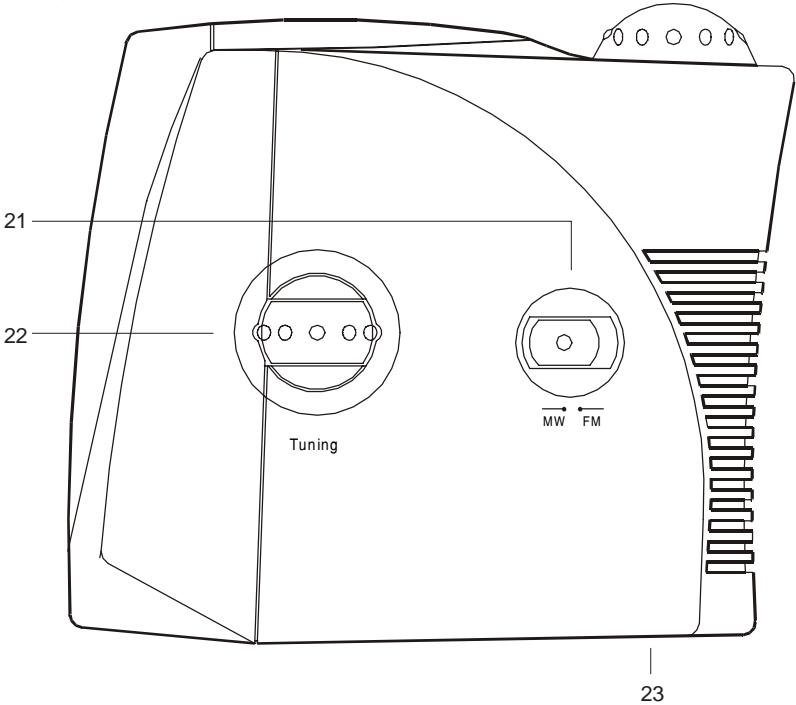

- 21. Waveband switch
- 22. Tuning control
- 23. Battery compartment  
(on underside)

*If you need any further advice, please call our Technical Helpline on :-  
020 8758 0338 (Mon-Fri)*

## Automatic clock setting

1. When switched on the Time Capsule will receive and synchronise your clock radio to one of the most accurate clocks in the world. The signal is received from the official UK standard frequency and time signal transmitter (MSF) located at Rugby in the U.K.

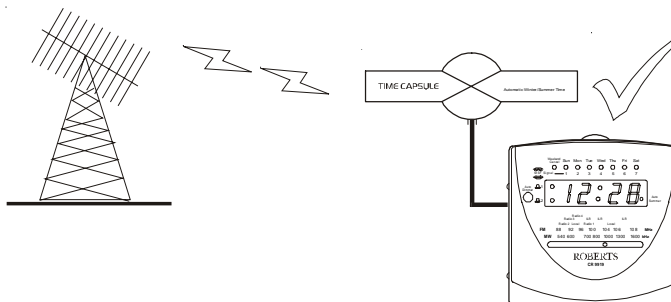

2. ***At certain times of the year the MSF transmitter closes down for maintenance during this time it will be necessary to set the clock manually (see the sections headed Setting the Time and Date Manually). Recorded information on transmitter status can be obtained on 020 8943 6493.***

***Your clock radio will only need to be set manually if the transmitter is closed down when your clock radio is first connected to the mains.***

***At all other times if the transmitter closes down your clock radio will continue to run on its own highly accurate internal quartz crystal time base.***

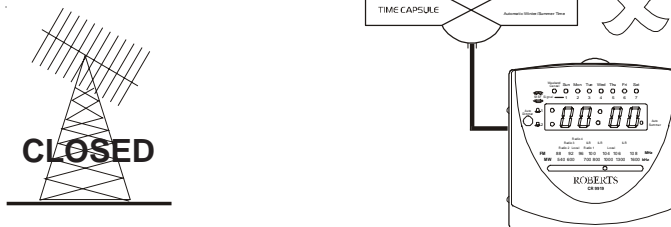

3. Your clock radio will automatically synchronise with the MSF time signal when the transmitter is switched back on. The time setting or synchronisation takes 2 to 3 minutes to complete if the reception of the radio time signal is undisturbed. This process will take longer if the time signal level is very weak (e.g. in locations that are a long distance from the MSF transmitter) or if it is subject to interference from thunderstorms, nearby TV sets, computers or household appliances that are not suppressed, etc.

***In the event of a mains power failure your clock radio will automatically synchronise with the MSF time signal and reset the clock when the mains power is restored.***

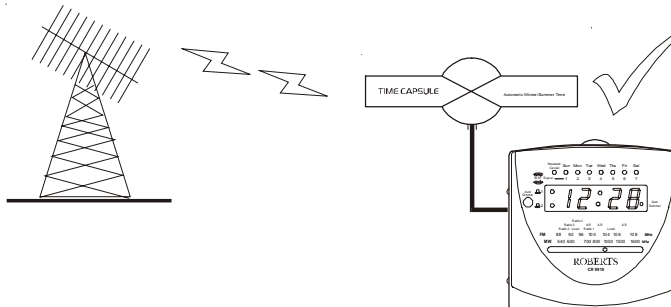

## Switching on

1. Place your clock radio on a flat surface. Plug the mains lead into a wall socket and switch on. **Note your clock radio will not switch on until the clock has been set.**
2. The Time Capsule will automatically activate the Radio Controlled clock and initiate a search for the time signal. When first connected to the mains supply the **MSF signal indicator** shows the MSF signal level. Rotate the Time Capsule or change its position until the highest signal level is obtained.
3. **In most locations the time capsule can be placed behind a bedside cupboard out of sight.** If necessary the Time Capsule can be secured to the cupboard using the double sided tape provided. If a more permanent installation is required the base of the Time Capsule can be snapped open at the split line - the base can then be secured using two small screws. The top section can then be snapped back onto the base.
4. We recommended that your clock radio and Time Capsule are placed as far away as possible from any sources of interference such as computers or televisions, etc.
5. When your Time Capsule is receiving the radio time signal, the seconds digits will appear in the display and the colon will flash once every second in time with the radio time signal. When the time setting process has been completed, the exact time and day of the week will appear in the display. The **MSF signal indicator** becomes the **Day of week** indicator after initial time setting has taken place.
6. Your clock radio will automatically switch from summer to winter time and vice versa by following the radio time signal. The **Automatic summer time indicator** will light up during summer time.

If you need any further advice, please call our Technical Helpline on :-  
020 8758 0338 (Mon-Fri)

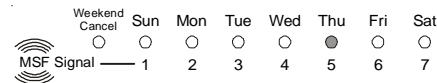
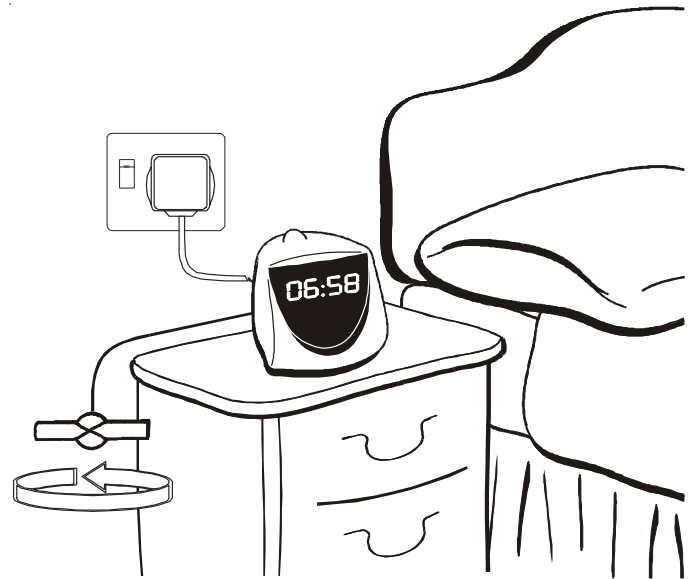

## Setting the time manually

(only necessary if the MSF signal is not available)

1. To set the time, press and hold down the **Time button** and adjust using the **Forward button** or **Reverse button** until the correct time appears. The clock uses a 24 hour display.
2. After setting the time, your clock radio will continue to run on its own internal quartz time base and will automatically synchronise itself with the radio time signal commencing on the 54th minute of every hour. Once synchronisation is achieved the time and date of the radio time signal will be restored and displayed.

Note: Pressing the forward or reverse buttons once will cause the display to move by one digit. Press and hold down the forward or reverse buttons to rapidly change the display backwards or forwards.

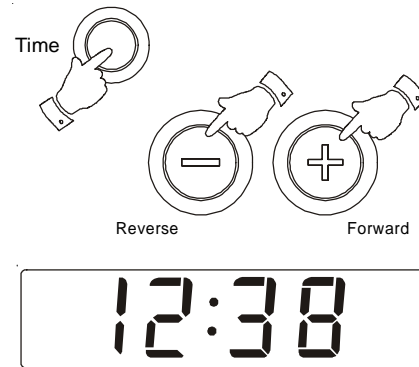

## Setting the date manually

(only necessary if the MSF signal is not available)

1. To set the date, press and hold down the **Date button** and adjust using the **Forward button** or **Reverse button** until the correct date appears.

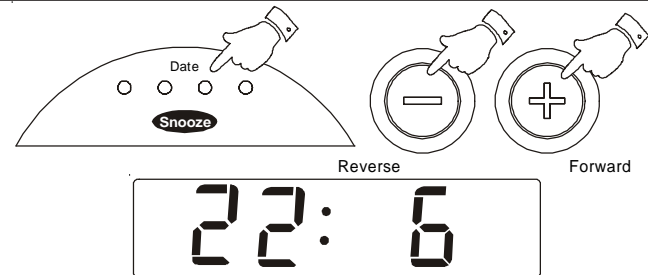

## Setting the year manually

(only necessary if the MSF signal is not available)

1. To set the year, press the **Date button** once to display the date, within 3 seconds press and hold down the **Date button** and adjust the year using the **Forward button** or **Reverse button** until the correct year appears.

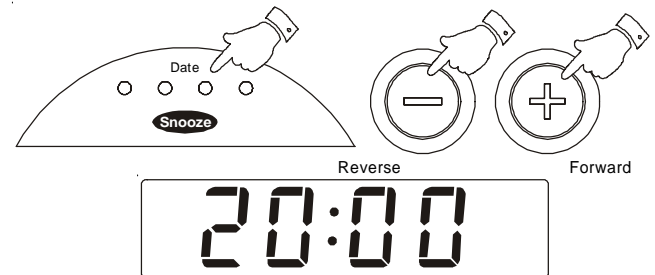



## Listening to the Radio

1. Switch on the radio by pressing the **On/Off button**. The **LED dial pointer** will light up indicating that the radio is switched on.

**Note your clock radio will not switch on until the clock has been set.**

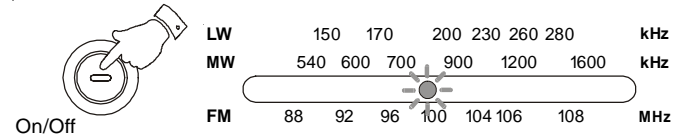

2. Select the required waveband using the **Waveband selector switch**.

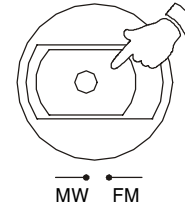

3. Tune in to the desired station by rotating the **Tuning control**. The station frequency is indicated by the **LED dial pointer**.

The **Wire aerial** located on the rear of your clock radio is for FM reception. The wire should be fully extended and positioned for optimum reception.

For MW reception there is a built in ferrite aerial. Rotate your clock radio to the position giving best reception.

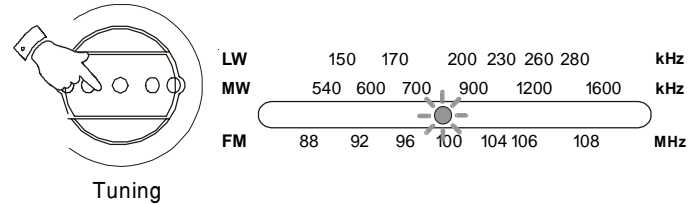

4. Adjust the volume by rotating the **Volume control**.

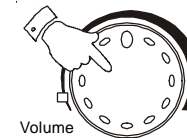

5. The radio can be switched off by pressing the **On/Off button**.

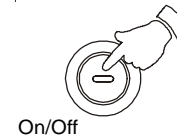

If you need any further advice, please call our Technical Helpline on :-  
020 8758 0338 (Mon-Fri)

## Setting alarm times

Your alarm clock radio has two separate alarms which can be set to activate at different times. The alarms can be set to wake you by either the buzzer or the radio.

In the event of a power failure the backup battery will ensure that the alarm sounds at the preset time.

**Note alarm times cannot be adjusted until the clock has been set.**

### Setting alarm 1

1. Press and hold down the **Alarm 1 button** (🔔 1).
2. Whilst holding down the **Alarm 1 button** (🔔 1) press the **Forward button** or **Reverse button** to set the required alarm time. Release the buttons when the correct alarm time is reached. The clock uses a 24 hour display.

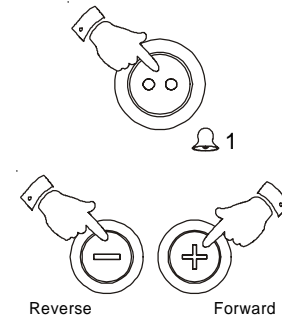

### Setting alarm 2

1. Press and hold down the **Alarm 2 button** (🔔 2).
2. Whilst holding down the **Alarm 2 button** (🔔 2) press the **Forward button** or **Reverse button** to set the required alarm time. Release the buttons when the correct alarm time is reached. The clock uses a 24 hour display.

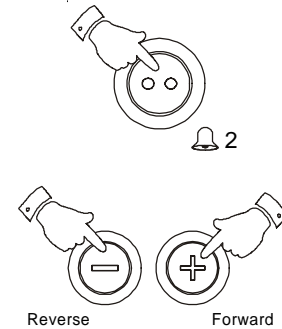

## Checking the Alarm Times

1. To check alarm 1 time, press the **Alarm 1 button** (🔔 1) the display will show alarm 1 time whilst the button is held down.



2. To check alarm 2 time, press the **Alarm 2 button** (🔔 2) the display will show alarm 2 time whilst the button is held down.



## Setting the alarms to wake to buzzer

1. Set the alarm time as previously described.
2. Set the **Alarm 1 function switch** or **Alarm 2 function switch** to the 'Buzz' position. The corresponding **Alarm indicators** will light.
3. The buzzer alarm will sound every day at the preset time for 60 minutes.
4. To turn off the alarm until the next day press the **On/Off button**.
5. To turn off the alarms permanently set the **Alarm 1 function switch** or **Alarm 2 function switch** to the 'Off' position.

To make a distinction between alarm 1 and alarm 2 the alarm signals have a different sound pitch:

Alarm 1 = lower pitch alarm signal

Alarm 2 = higher pitch alarm signal

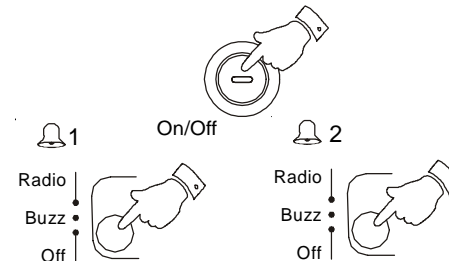
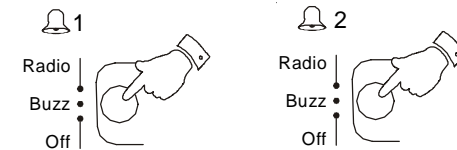

If you need any further advice, please call our Technical Helpline on :-  
020 8758 0338 (Mon-Fri)

## Setting the alarms to wake to radio

1. Set the alarm time as previously described.
2. Set the **Alarm 1 function switch** or **Alarm 2 function switch** to the 'Radio' position. The corresponding **Alarm indicators** will light.
3. Ensure that a station is tuned in and the **Volume control** is set to the required level.
4. The radio alarm will sound every day at the preset time for 60 minutes.
5. To turn off the alarm until the next day press the **On/Off button**.
6. To turn off the alarms permanently set the **Alarm 1 function switch** or **Alarm 2 function switch** to the 'Off' position.

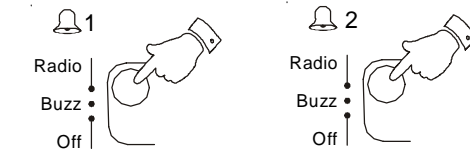

## Snooze control

The radio or buzzer alarms can be silenced for 5 minutes by pressing the **Snooze** button. This sequence can be repeated during the alarm cycle (60 min).



## Sleep timer

The radio can be set to turn off after a preset time has elapsed.

Press and hold down the **Sleep** button until the desired time is reached (maximum 90 minutes in 10 minute steps). The radio will switch off after the sleep time has elapsed. To cancel the sleep function before the preset time has expired, press the **On/Off button**.



## Alarm weekend cancel

The alarms can be automatically cancelled at weekends.

1. To enable the weekend cancel function, press the **Weekend cancel button**. The **Weekend cancel indicator** will light up in the display.
2. Press the **Weekend cancel button** again to turn off the indicator and disable this function.

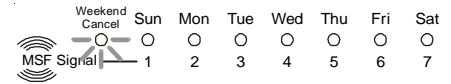

---

## Auto Dimmer

The **Auto Dimmer** located on the left side of the LED display will automatically adjust the intensity of the clock display to suit room brightness.



## Specifications

### Power Requirements

Mains	AC 230 volts, 50Hz  only
Back-up Battery	IEC size 6LR61 (6F22, PP3)

### Frequency Coverage

FM	87.5 - 108MHz
MW	525 - 1610kHz

## Circuit Features

### Loudspeaker

75mm diameter 8 ohms

Output power 350mW

### Aerial System

FM Wire Aerial

MW Built-in Ferrite aerial

### ROBERTS RADIO LIMITED

PO BOX 130  
MEXBOROUGH  
SOUTH YORKSHIRE  
S64 8YT

*The company reserves the right to amend the specification without notice.*

## General

Do not allow this unit to be exposed to water or steam. It is recommended that the FM band be used wherever possible as better results in terms of quality and freedom from interference will usually be obtained than on the MW band.

## Mains supply

The CR9919 will operate from a supply of AC 230volts, 50Hz  $\sim$  only. For your convenience this product is supplied with a plug which is fitted with a fuse of the appropriate rating. If the plug supplied is not suitable for your socket outlet, it should be removed by unscrewing the plug top, the terminal screws, and removing the cable.

The correct style of plug to suit your household together with a correctly rated fuse should be fitted.

IF IN DOUBT - CONSULT A QUALIFIED ELECTRICIAN

**IMPORTANT. DO NOT** make any connection to the larger terminal which is marked with the letter E or by the safety earth symbol  $\perp$  or coloured Green or Green-and-yellow.

The wires in the mains lead are coloured in accordance with the following codes :-

BLUE - NEUTRAL

BROWN - LIVE

As these colours may not correspond with the coloured markings identifying the terminals in your plug, proceed as follows:-

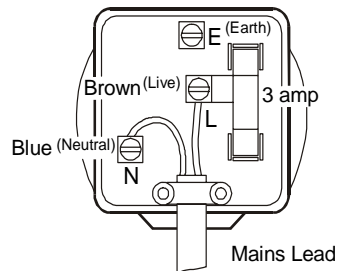

The wire coloured BLUE must be connected to the terminal marked N or coloured BLACK.

The wire coloured BROWN must be connected to the terminal marked L or coloured RED.

If you need any further advice, please call our Technical Helpline on :-  
020 8758 0338 (Mon-Fri)

## Fuse

This apparatus must be protected by a 3A fuse (BS1362) in a 13A plug (BS1363). If another type of plug is used a 5A fuse should be fitted in the plug, adaptor or distribution board.

IF IN DOUBT - CONSULT A QUALIFIED ELECTRICIAN.

## Back-up Battery (not necessary for the unit to function)

Slide the battery cover catch in the direction of the arrow. Remove the battery cover. Fit a 9 volt IEC size 6LR61 (6F22, PP3) or equivalent battery into the compartment. Replace the battery cover.

The time and alarm settings will be retained during a temporary failure of the AC mains supply. **The LED display will not be operational but the Radio and buzzer alarms will continue to operate at their preset times.**

If your clock radio is not to be used for a prolonged period of time, remove the battery to avoid damage by battery leakage.

## (Underside)

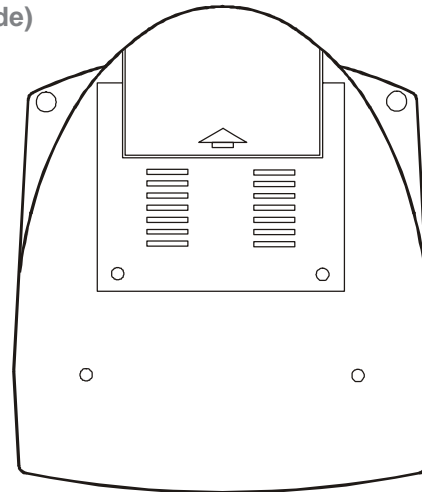

## Guarantee

This instrument is guaranteed for twelve months from the date of delivery to the original owner against failure due to faulty workmanship or component breakdown, subject to the procedure stated below. Should any component or part fail during this guarantee period it will be repaired or replaced free of charge.

The guarantee does not cover:

1. Damage resulting from incorrect use.
2. Consequential damage.
3. Receivers with removed or defaced serial numbers.

Procedure:

Any claim under this guarantee should be made through the dealer from whom the instrument was purchased. It is likely that your Roberts' dealer will be able to attend to any defect quickly and efficiently, but should it be necessary the dealer will return the instrument to the company's service department for attention. In the event that it is not possible to return the instrument to the Roberts' dealer from whom it was purchased, please contact Roberts Radio Technical Services Department at the address shown below before taking further action.

*These statements do not affect the statutory rights of a consumer.*

### **ROBERTS RADIO TECHNICAL SERVICES DEPARTMENT**

97-99 Worton Road  
Isleworth Middlesex  
TW7 6EG

Technical Helpline:- 020 8758 0338 (Mon-Fri)

Issue 1





## Free Manuals Download Website

<http://myh66.com>

<http://usermanuals.us>

<http://www.somanuals.com>

<http://www.4manuals.cc>

<http://www.manual-lib.com>

<http://www.404manual.com>

<http://www.luxmanual.com>

<http://aubethermostatmanual.com>

Golf course search by state

<http://golfingnear.com>

Email search by domain

<http://emailbydomain.com>

Auto manuals search

<http://auto.somanuals.com>

TV manuals search

<http://tv.somanuals.com>