

ROBERTS

Sound for Generations

CR9931

3 Band Auto Time Set Dual Alarm
Clock Radio



Please read this manual before use

Controls

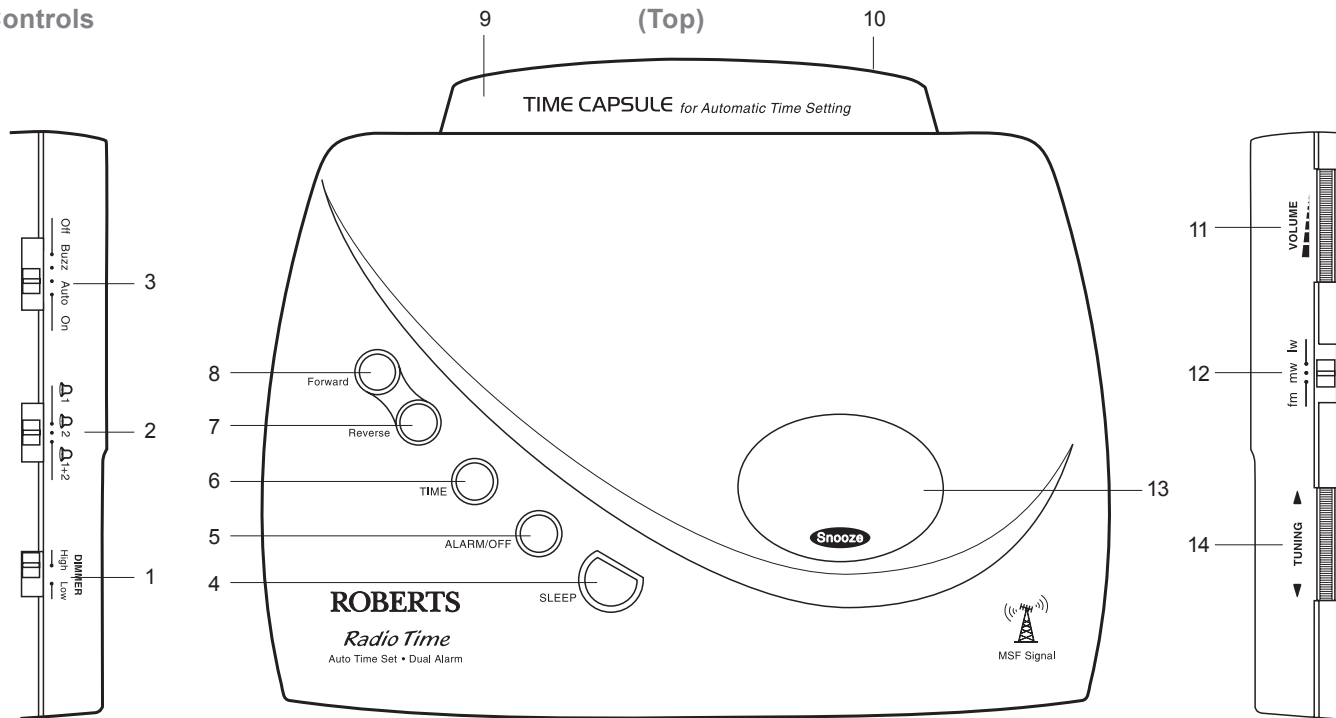

(Left side)

(Right side)

- | | | |
|--------------------------|----------------------|---------------------|
| 1. Dimmer switch | 6. Time set button | 11. Volume control |
| 2. Alarm selector switch | 7. Reverse button | 12. Waveband switch |
| 3. Function switch | 8. Forward button | 13. Snooze button |
| 4. Sleep button | 9. Time capsule | 14. Tuning control |
| 5. Alarm set button | 10. Headphone socket | |

Controls

(Front)

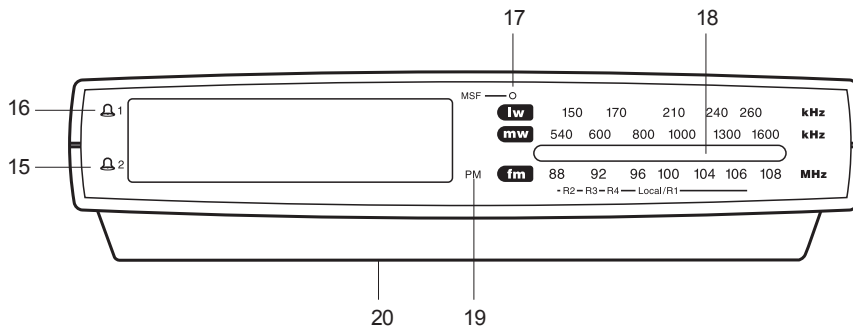

15. Alarm 2 indicator

16. Alarm 1 indicator

17. MSF indicator

18. LED dial pointer

19. PM indicator

20. Battery compartment (on underside)

Automatic clock setting

When you plug in your clock radio for the first time it will receive and synchronise to the official UK standard frequency and time signal transmitter (MSF) located at Rugby in the U.K.

At certain times of the year the MSF transmitter closes down for maintenance during this time it will be necessary to set the clock manually (see the sections headed Setting the time manually). Recorded information on transmitter status can be obtained on 020 8943 6493.

Your clock radio will only need to be set manually if the transmitter is closed down when your clock radio is first connected to the mains. At all other times if the transmitter closes down, your clock radio will continue to run on its own internal time memory.

Switching on

1. Place the unit on a flat surface. Plug the mains lead into a wall socket and switch on.
2. The built in microprocessor will automatically activate the Radio Controlled clock and initiate a search for the time signal. The **MSF indicator** will flash whilst the time is being set.
3. When your clock radio is receiving the radio time signal, the seconds' digits will appear in the display.
4. When the time setting process has been completed (2-4 minutes), the exact time will appear in the display. The **MSF indicator** will stop flashing.
5. **If the time does not set it may be necessary to rotate your clock radio to a position giving better reception of the MSF signal.**
6. It is recommended that your clock radio is placed as far away as possible from any sources of interference such as computers or televisions, etc.
7. Your clock radio can be made to re-synchronise with the radio time signal by pressing and releasing the **Time button** until the **MSF indicator** begins to flash. Synchronisation is complete when the **MSF indicator** stops flashing.

In the event of a mains power failure your clock radio will automatically synchronise with the MSF time signal and reset the clock when the mains power is restored.

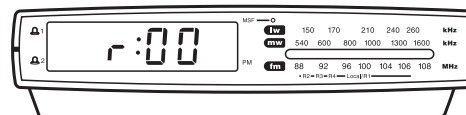
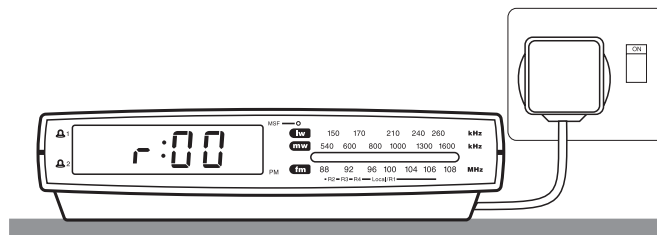

Setting the time manually

1. To set the time, press and hold down the **Time button**.
2. Whilst holding down the **Time Set button** press the **Forward** or **Reverse** buttons to set the time. Release the buttons when the correct time is reached. The clock uses a 12 hour display with a **PM indicator**. Ensure that the correct 12 hour cycle is selected.
3. After setting the time, the CR9931 will continue to run on its own internal time memory and will automatically synchronise itself with the radio time signal commencing at 00:00, 01:00, 02:00, 03:00 and 04:00.

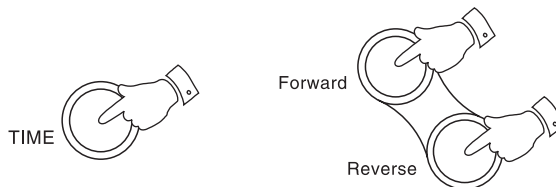

Listening to the Radio

1. Turn on the radio by sliding the **Function switch** to the 'On' position. The **LED dial pointer** will light up indicating that the radio is switched on.
2. Select the required waveband using the **Waveband selector switch**.
3. Tune in to the desired station by rotating the **Tuning control**. The station frequency is indicated by the **LED dial pointer**.

The **Wire aerial** located on the rear of your clock radio is for FM reception. The wire should be fully extended and positioned for optimum reception.

For MW and LW reception there is a built in ferrite aerial. Rotate your clock radio to the position giving best reception.

4. Adjust the volume by rotating the **Volume control**.
5. The radio can be switched off by sliding the **Function switch** to the 'Off' position.

Note: if the radio does not switch off, this may be caused by inadvertent operation of the Sleep button. Press the **ALARM/OFF button** to cancel.

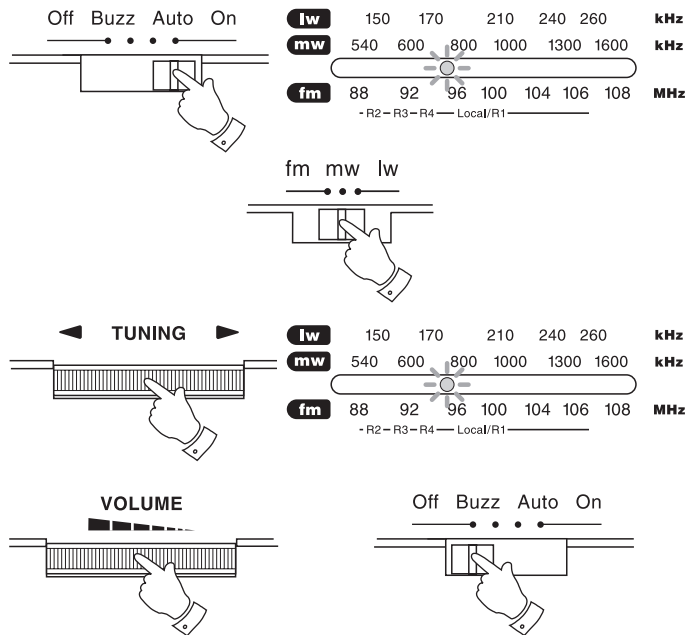

Setting alarm times

The alarms can be set to wake you by either the buzzer or the radio. Your alarm clock radio has 2 separate alarms which can be set to activate at different times.

Setting alarm 1

1. Slide the **Alarm function switch** to the '🔔 1' position.
2. Press and hold down the **ALARM/OFF button**.
3. Whilst holding down the **ALARM/OFF button** press the **Forward** or **Reverse buttons** to set the required alarm time. Release the buttons when the correct alarm time is reached. The clock uses a 12 hour display with a **PM indicator**. Ensure that the correct 12 hour cycle is selected.

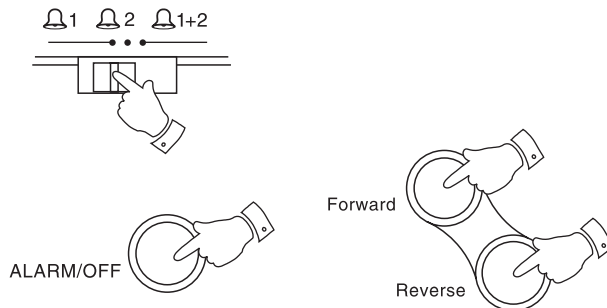

Setting alarm 2

1. Slide the **Alarm function switch** to the '🔔 2' position.
2. Press and hold down the **ALARM/OFF button**.
3. Whilst holding down the **ALARM/OFF button** press the **Forward** or **Reverse buttons** to set the required alarm time. Release the buttons when the correct alarm time is reached. The clock uses a 12 hour display with a **PM indicator**. Ensure that the correct 12 hour cycle is selected.

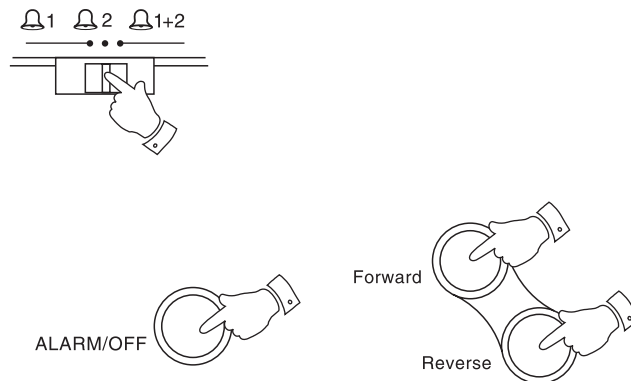

Checking the Alarm Times

1. To check alarm 1 time, set the **Alarm function switch** to the '🔔 1' position.
2. Press the **ALARM/OFF button** to display the alarm 1 time.
3. To check alarm 2 time, set the **Alarm function switch** to the '🔔 2' position.
4. Press the **ALARM/OFF button** to display the alarm 2 time.

Note: The alarm times cannot be checked if the **Alarm function switch** is in the '🔔 1+2' position.

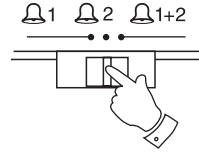
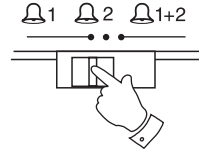

Setting the alarms to wake to buzzer

1. Set the alarm time as previously described.
2. Set the **Function switch** to the 'Buzz' position.
3. Set the **Alarm selector switch** to the '1' or '2' position. The corresponding **Alarm indicators** will light.

The buzzer alarm will sound every day at the preset time for 60 minutes. To turn off the alarm until the next day press the **ALARM/OFF button**. To turn off the alarm permanently set the **Function switch** to the 'Off' position.

4. Setting the alarm selector switch to the '1+2' position will allow two alarm times each day.

e.g. one alarm time for yourself and one alarm time for your partner.

To make a distinction between alarm 1 and alarm 2 the alarm signals have a different sound pitch:

Alarm 1 = higher pitch alarm signal

Alarm 2 = lower pitch alarm signal

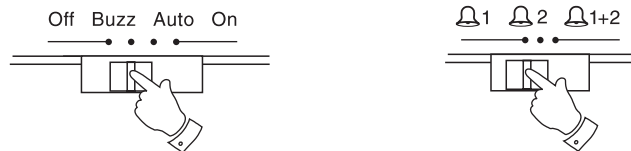

Setting the alarms to wake to radio

1. Set the alarm time as previously described.
2. Set the **Function switch** to the 'Auto' position.
3. Set the **Alarm selector switch** to the '1' or '2' or position. The corresponding **Alarm indicators** will light.

The radio alarm will sound every day at the preset time for 60 minutes. To turn off the alarm until the next day press the **ALARM/OFF button**. To turn off the alarm permanently set the **Function switch** to the 'Off' position.

4. Setting the alarm selector switch to the '1+2' position will allow two alarm times each day.

e.g. one alarm time for yourself and one alarm time for your partner.

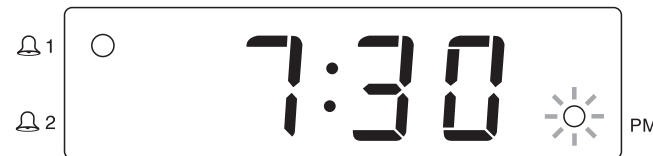
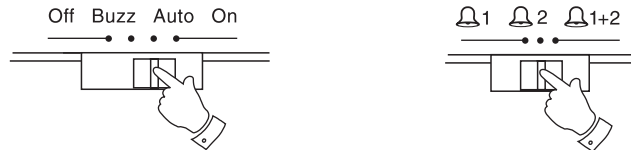

Snooze control

1. The radio or buzzer alarm can be silenced for 9 minutes by pressing the **Snooze** button. This sequence can be repeated during the 60 minute alarm period.

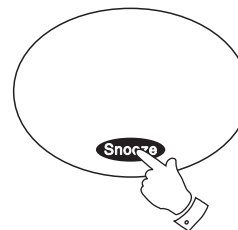

Sleep timer

The radio can be set to turn off after a preset time has elapsed.

1. Press and hold down the **SLEEP** button.
2. Set the sleep time using the **Forward** or **Reverse** buttons (maximum 1 hour 59 minutes in 1 minute steps). The radio will switch off after the sleep time has elapsed.
3. To cancel the sleep function before the preset time has expired, press the **Snooze** button.



Dimmer Switch

The **DIMMER switch** located on the left side of your clock radio will allow you to adjust the intensity of the clock display to suit room brightness.

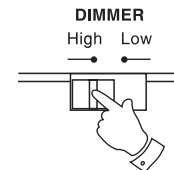

Headphones (on rear)

A **Headphone Socket** (3.5mm) is provided for use with either headphones or an earpiece. Inserting a plug automatically mutes the internal loudspeaker.

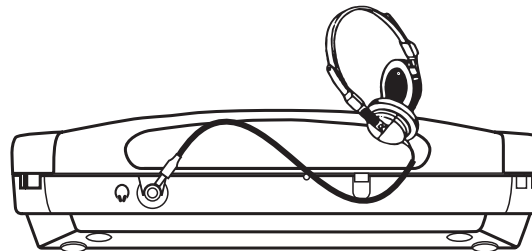

General

Do not allow this unit to be exposed to water or steam. It is recommended that the FM band be used wherever possible as better results in terms of quality and freedom from interference will usually be obtained than on the MW or LW bands.

Mains supply

Your CR9931 will operate from a supply of AC 230volts, 50Hz \sim only. For your convenience this product is supplied with a plug which is fitted with a fuse of the appropriate rating. If the plug supplied is not suitable for your socket outlet, it should be removed by unscrewing the plug top, the terminal screws, and removing the cable. The correct style of plug to suit your household together with a correctly rated fuse should be fitted.

IF IN DOUBT - CONSULT A QUALIFIED ELECTRICIAN

IMPORTANT. DO NOT make any connection to the larger terminal which is marked with the letter E or by the safety earth symbol \perp or coloured Green or Green-and-yellow.

The wires in the mains lead are coloured in accordance with the following codes :-

BLUE - NEUTRAL

BROWN - LIVE

As these colours may not correspond with the coloured markings identifying the terminals in your plug, proceed as follows:-

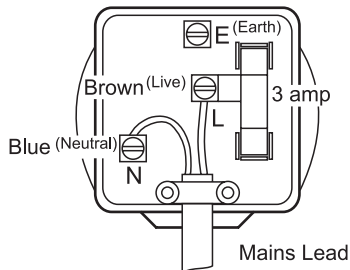

The wire coloured BLUE must be connected to the terminal marked N or coloured BLACK.
The wire coloured BROWN must be connected to the terminal marked L or coloured RED.

Fuse

This apparatus must be protected by a 3A fuse (BS1362) in a 13A plug (BS1363). If another type of plug is used a 5A fuse should be fitted in the plug, adaptor or distribution board.

IF IN DOUBT - CONSULT A QUALIFIED ELECTRICIAN.

Back-up Battery (not necessary for the unit to function)

Slide the battery cover catch in the direction of the arrow. Remove the battery cover. Fit 2 x LR03 (AAA size) or equivalent batteries into the battery box. Replace the battery cover.

The time and alarm settings will be retained during a temporary failure of the AC mains supply. The LED display will not be operational. The display will be extinguished to conserve battery life, but the memory will retain details of the time and alarm time settings.

If your clock radio is not to be used for a prolonged period of time, remove the battery to avoid damage by battery leakage.

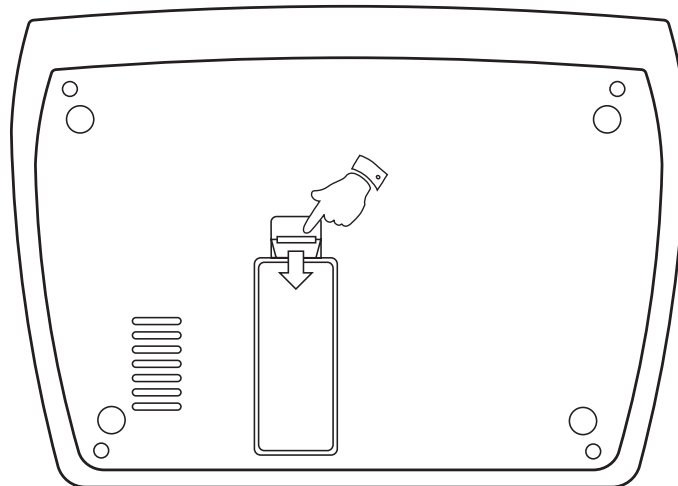

Specifications

Power Requirements

Mains	AC 230 volts, 50Hz  only
Back-up Battery	2 X LR03 (AAA size)

Frequency Coverage

FM	87.5 - 108MHz
MW	525 - 1610kHz
LW	150 - 260kHz

Circuit Features

Loudspeaker	8 ohms
	Output power 350mW
Aerial System	FM Wire Aerial
	MW Built-in Ferrite aerial
	LW Built-in Ferrite aerial

The Company reserves the right to amend the specification without notice.

Guarantee

This clock radio is guaranteed for twelve months from the date of delivery to the original owner against failure due to faulty workmanship or component breakdown, subject to the procedure stated below. Should any component or part fail during this guarantee period it will be repaired or replaced free of charge.

The guarantee does not cover:

1. Damage resulting from incorrect use.
2. Consequential damage.
3. Product with removed or defaced serial numbers.

Procedure: Any claim under this guarantee should be made through the dealer from whom the instrument was purchased. It is likely that your Roberts' dealer will be able to attend to any defect quickly and efficiently but should it be necessary the dealer will return the product to the company's service department for attention. In the event that it is not possible to return the instrument to the Roberts' dealer from whom it was purchased, please contact Roberts Radio Technical Services at the address shown below before taking further action.

These statements do not affect the statutory rights of a consumer.

ROBERTS RADIO TECHNICAL SERVICES

97-99 Worton Road
Isleworth Middlesex
TW7 6EG



Free Manuals Download Website

<http://myh66.com>

<http://usermanuals.us>

<http://www.somanuals.com>

<http://www.4manuals.cc>

<http://www.manual-lib.com>

<http://www.404manual.com>

<http://www.luxmanual.com>

<http://aubethermostatmanual.com>

Golf course search by state

<http://golfingnear.com>

Email search by domain

<http://emailbydomain.com>

Auto manuals search

<http://auto.somanuals.com>

TV manuals search

<http://tv.somanuals.com>