

ROBERTS

Sound for Generations

CR9945

2 Band Auto Set Dual Alarm
Clock Radio



**Controls (top)
shown with Snooze cover
open**

1. Alarm 2 switch.
2. Alarm 1 switch.
3. Alarm 1 button.
4. Time zone button.
5. Down button.
6. Alarm mode button.
7. Year button.
8. Date button.
9. Up button.
10. Time button
11. Alarm 2 button
12. Waveband switch.

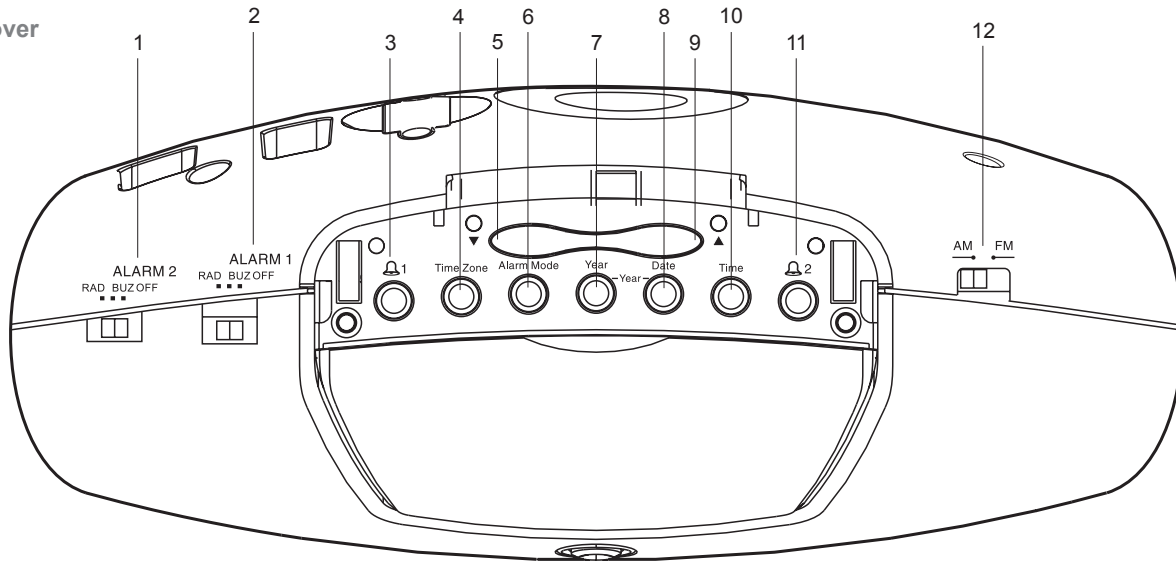

Controls (front)

- 13. Alarm indicator.
- 14. Tuning scale.
- 15. Day of week indicators.
- 16. Time/Date display.
- 17. Low battery indicator.
- 18. Tuning scale
- 19. Sleep button
- 20. On/off button.

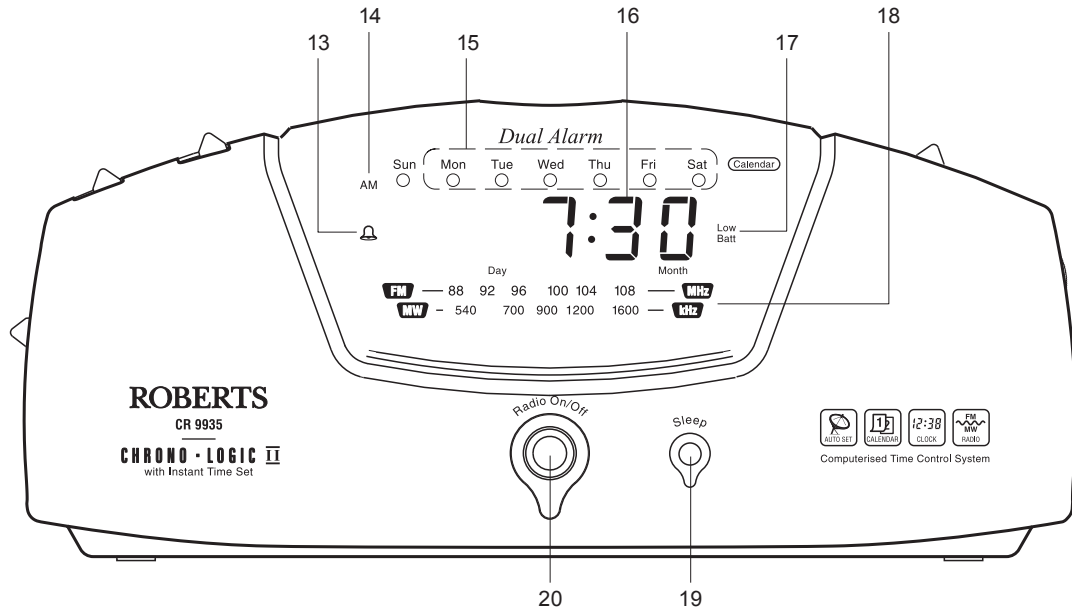

Controls (left and right side)

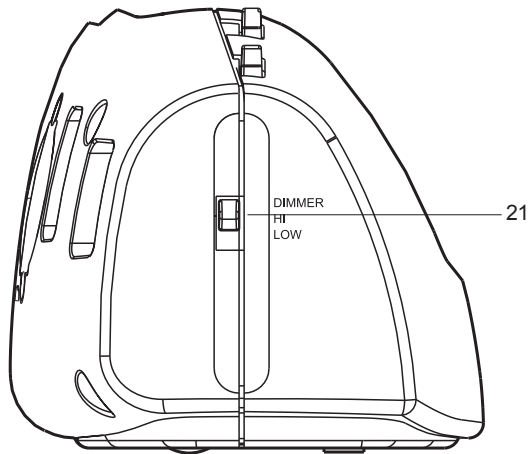

- 21. Dimmer switch.
- 22. Volume control.
- 23. Tuning control.

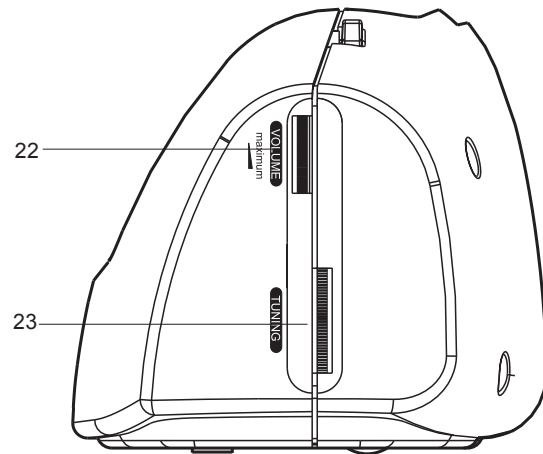

Switching on

1. Place your clock radio on a flat surface. Plug the power cord into the wall socket and switch on.
2. After a few seconds the time, day and date will set automatically. Your clock radio is fitted with a long life back-up battery to maintain the factory set time, day and date. Your clock radio will automatically adjust for summer/winter time.

See section on Backup battery on pages 12 and 13.

Should the time require adjustment follow the procedure shown in the next section.

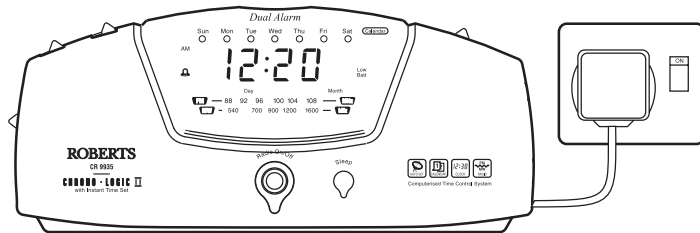

Setting the time

1. Press and hold down the **Time button**.



2. Whilst holding down the **Time Set button** press the **Up or Down buttons** to set the time. Release the buttons when the correct time is reached. The clock uses a 12 hour display with an **AM indicator**. Ensure that the correct 12 hour cycle is selected.

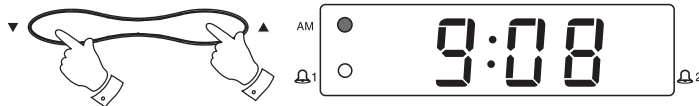

1. To set year hold down both **Year and Date buttons**. The display will change to show year

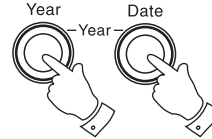

2. Whilst holding down **Year and Date buttons** set correct year using **Up or Down buttons**. When the **Year and Date buttons** are released the display will revert to showing Day/Date



1. To set date hold down the **Date button**.





2. Whilst holding down the **Date button** set correct date using **Up or Down buttons**.



Setting alarm times



Your alarm clock radio has two separate alarms which can be set to activate at different times. The alarms can be set to wake you by either the buzzer or the radio.

Setting alarm 1

1. Press and hold down the  **button**.
2. Whilst holding down the  **button** press the **Up** or **Down** **buttons** to set the alarm time. Release the buttons when the correct alarm time is reached. The clock uses a 12 hour display with an **AM** **indicator**. Ensure that the correct 12 hour cycle is selected.



Setting alarm 2

1. Press and hold down the  **button**.
2. Whilst holding down the  **button** press the **Up** or **Down** **buttons** to set the alarm time. Release the buttons when the correct alarm time is reached. The clock uses a 12 hour display with an **AM** **indicator**. Ensure that the correct 12 hour cycle is selected.



Day/month display





1. Press and hold down the snooze button to display the day/month.
2. Release the snooze button to return to normal time display.



Alarm modes

Your clock radio has three alarm modes for each of the alarms. The alarm modes are Weekdays only - the alarm will switch on Monday to Friday. Weekends only - the alarm will switch on Saturday and Sunday only. Everyday - the alarm will switch on everyday.

Weekday alarm

1. Press and hold down the  1 or  2 **buttons** (depending on which alarm you wish to set mode for)
2. Whilst holding down  1 or  2 **buttons** repeatedly press and release the **Alarm mode button** until Mon to Fri indicators are lit.



Alarm Mode



Sun Mon Tue Wed Thu Fri Sat







7:30

Day

Month

Weekend alarm



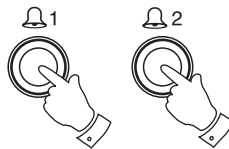

1. Press and hold down the   **buttons** (depending on which alarm you wish to set mode for)
2. Whilst holding down  or  **buttons** repeatedly press and release the **Alarm mode button** until Sat and Sun indicators are lit.

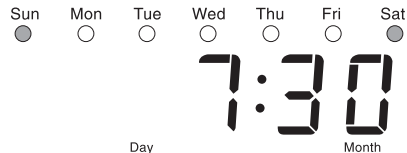

Alarm Mode



Everyday alarm

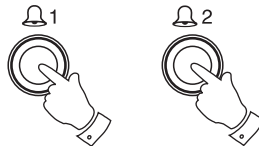

1. Press and hold down the  or  **buttons** (depending on which alarm you wish to set mode for)
2. Whilst holding down  or  **buttons** repeatedly press and release the **Alarm mode button** until all the days of the week indicators are lit.

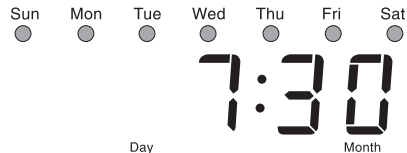

Alarm Mode



Checking alarm times

1. Press and hold down either  **1** or  **2** **buttons**. The display will change from normal time to alarm time - days of the week indicators will show days of the week on which alarm will activate. Release the **Alarm button** to return to normal time

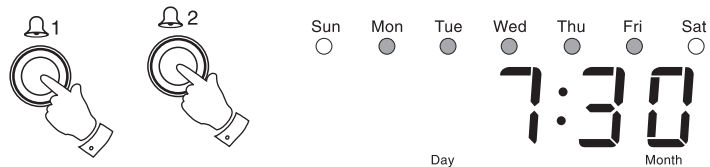

Listening to the radio

1. Switch on the radio by pressing the **On/Off button**. Select the required waveband using the **Waveband switch**.
2. Tune in to the desired station using the **Tuning control**. Adjust volume using the **Volume control**.
3. The **Wire aerial** located on the rear of your clock radio is for FM reception. The wire should be fully extended and positioned for optimum reception.

For MW (AM) reception there is a built in ferrite aerial. Rotate your clock radio to the position giving best reception.

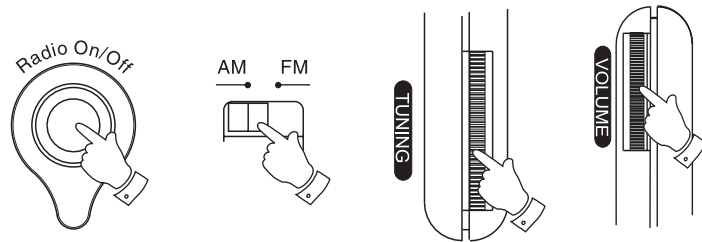

Setting the alarms to wake to buzzer

1. Set the alarm time as previously described. Set the **Alarm 1 or Alarm 2 switch** to the “Buzz” position. The **Alarm indicator** will light.
2. The buzzer alarm will sound every day at the preset time for 1 hour. To switch off the alarm until the next day press the **On/Off button**. To turn off the alarms permanently set the **Alarm 1 or Alarm 2 switch** to the 'Off' position.

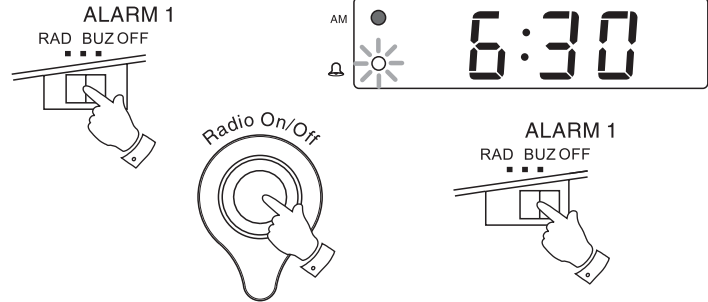

Setting the alarms to wake to radio

1. Set the alarm time as previously described. Set the **Alarm 1 or Alarm 2 switch** to the “Radio” position. The corresponding **Alarm indicators** will light.
2. Ensure that the volume is set to the correct level and the desired station is tuned in.
3. The radio alarm will sound every day at the preset time for 1 hour. To switch off the alarm until the next day press the **On/Off button**. To turn off the alarms permanently set the **Alarm 1 or Alarm 2 switch** to the “Off” position.

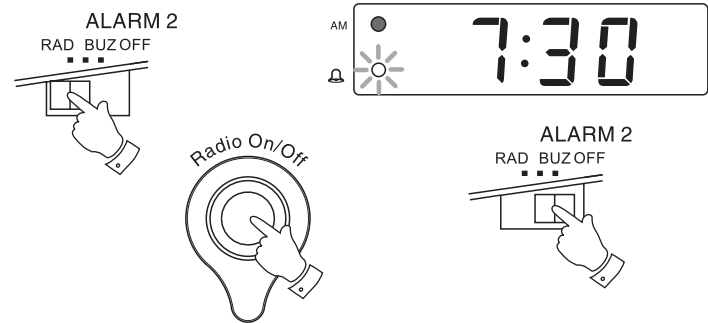

Snooze control

The radio or buzzer alarm can be silenced for 9 minutes by pressing the **Snooze button**. This sequence can be repeated whilst the alarm is sounding.



Sleep timer

You can program your clock radio to play the radio for up to 90 minutes and then switch off.

1. Press the **Sleep button**. The display will show the sleep time.
2. To increase or decrease the amount of time the radio will play before switching off, hold down the **Sleep button** and increase or decrease the sleep time using the **Up or Down buttons** (maximum 90 minutes - minimum 2 minutes).
3. To cancel the sleep timer before the sleep time has elapsed press the Snooze button.

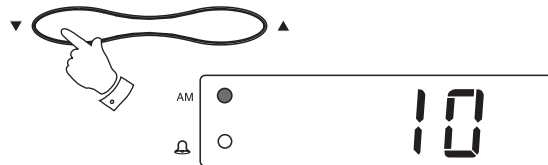

Dimmer switch

The **Dimmer switch** located on the left side of your clock radio will allow you to adjust the intensity of the clock display to suit room brightness.

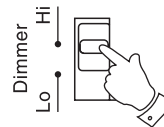

Backup battery

As with all batteries, eventually the built in lithium battery will need to be replaced. A number of factors, such as the length of time between the date your clock radio was manufactured and the date you plugged it in for the first time, determine the amount of time before battery replacement. During this initial storage period the lithium backup battery is supplying power to your clock radio's computer memory. Once you connect your clock radio to the household AC mains supply the battery no longer supplies power to your clock radio's computer memory. A fresh backup battery can supply power to your clock radio's computer memory for 2 years even if it is never connected to a mains supply. If your clock radio was connected to the AC mains supply within a few months after it was manufactured and you experience only short interruptions to the mains supply, your battery may last for up to 2-3 years or even longer. When the power drops below a certain level the *Low battery indicator* will light. When you see this indicator you should change the battery as soon as it is convenient to do so.

See following page for details on battery replacement.



Changing the backup battery

1. Purchase a replacement lithium backup battery type CR2032 or equivalent.
2. Remove the fresh battery from its packaging so that it is ready to install.
3. **Important.** Maintain connection to AC mains supply during battery replacement. This will provide power whilst the original battery is removed.
4. Use a small screwdriver to remove the two small screws securing the battery holder on cabinet back.
5. Remove the battery holder from cabinet.
6. Remove old battery from holder. Replace new battery with + sign facing left side of radio when viewed from cabinet rear.
7. Replace the holder into cabinet back.
8. Refit the two small screws to secure holder and check that the "Batt Low" indicator is not lit.

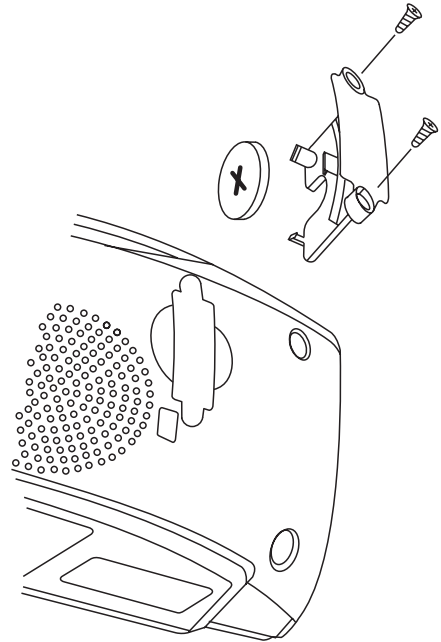

Time Zones

Your clock radio is set up to UK time zone 00 GMT (UTC). Should you wish to take your clock radio to other countries the time zone will need to be reset.

1. Press and hold down the **Time Zone button** - the display will show the time zone currently selected e.g 00.
2. Whilst holding down the **Time Zone button** adjust the time zone using the **Up or Down buttons**. See following table for details of time zones and their Offsets relative to GMT.

Zone	Offset (Hours)	Zone	Offset (Hours)
00	GMT	12	GMT +/-12
01	GMT -1	13	GMT +11
02	GMT -2	14	GMT +10
03	GMT -3	15	GMT +9
04	GMT -4	16	GMT +8
05	GMT -5	16	GMT +7
06	GMT -6	18	GMT +6
07	GMT -7	19	GMT +5
08	GMT -8	20	GMT +4
09	GMT -9	21	GMT +3
10	GMT -10	22	GMT +2
11	GMT -11	23	GMT +1

Time Zone



Specifications

Power Requirements

Mains	AC 230 volts, 50Hz  only
Back-up Battery	1 x CR2032 Lithium

Frequency Coverage

FM	87.5 - 108MHz
MW	525 - 1610kHz

Circuit Features

Loudspeaker	8 ohms
	Output power 250mW
Aerial System	FM Wire Aerial
	MW Built-in Ferrite aerial

The Company reserves the right to amend the specification without notice.

General

Do not allow this unit to be exposed to water or steam. It is recommended that the FM band be used wherever possible as better results in terms of quality and freedom from interference will usually be obtained than on the MW band.

Mains supply

The CR9945 will operate from a supply of AC 230volts, 50Hz \sim only. For your convenience this product is supplied with a plug which is fitted with a fuse of the appropriate rating. If the plug supplied is not suitable for your socket outlet, it should be removed by unscrewing the plug top, the terminal screws and removing the cable.

The correct style of plug to suit your household together with a correctly rated fuse should be fitted.

IF IN DOUBT - CONSULT A QUALIFIED ELECTRICIAN

IMPORTANT. DO NOT make any connection to the larger terminal which is marked with the letter E or by the safety earth symbol \perp or coloured Green or Green-and-yellow.

The wires in the mains lead are coloured in accordance with the following codes :-

BLUE - NEUTRAL

BROWN - LIVE

As these colours may not correspond with the coloured markings identifying the terminals in your plug, proceed as follows:-

The wire coloured BLUE must be connected to the terminal marked N or coloured BLACK.

The wire coloured BROWN must be connected to the terminal marked L or coloured RED.

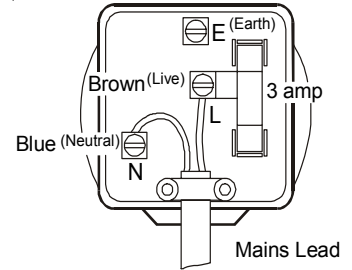

Fuse

This apparatus must be protected by a 3A fuse (BS1362) in a 13A plug (BS1363). If another type of plug is used a 5A fuse should be fitted in the plug, adaptor or distribution board.

IF IN DOUBT - CONSULT A QUALIFIED ELECTRICIAN.

Notes

Guarantee

This radio is guaranteed for twelve months from the date of delivery to the original owner against failure due to faulty workmanship or component breakdown, subject to the procedure stated below. Should any component or part fail during this guarantee period it will be repaired or replaced free of charge.

The guarantee does not cover:

1. Damage resulting from incorrect use.
2. Consequential damage.
3. Product with removed or defaced serial numbers.

Procedure: Any claim under this guarantee should be made through the dealer from whom the instrument was purchased. It is likely that your Roberts' dealer will be able to attend to any defect quickly and efficiently but should it be necessary the dealer will return the instrument to the company's service department for attention. In the event that it is not possible to return the instrument to the Roberts' dealer from whom it was purchased, please contact Roberts Radio Technical Services at the address shown on the rear of this manual before taking further action.

These statements do not affect the statutory rights of a consumer.

ROBERTS RADIO TECHNICAL SERVICES

97-99 Worton Road

Isleworth Middlesex

TW7 6EG

Technical Helpline :- 020 8758 0338 (*Mon-Fri during office hours*)

Issue 2



Free Manuals Download Website

<http://myh66.com>

<http://usermanuals.us>

<http://www.somanuals.com>

<http://www.4manuals.cc>

<http://www.manual-lib.com>

<http://www.404manual.com>

<http://www.luxmanual.com>

<http://aubethermostatmanual.com>

Golf course search by state

<http://golfingnear.com>

Email search by domain

<http://emailbydomain.com>

Auto manuals search

<http://auto.somanuals.com>

TV manuals search

<http://tv.somanuals.com>