

ROBERTS

Sound for Generations

CR9970

Dual Alarm CD Clock Radio



GlowTime 2

Please read this manual before use

Contents

<i>Contents</i>	2	<i>Sleep timer</i>	19
<i>Controls</i>	3-4	<i>Dimmer</i>	20
<i>Switching on and setting the time</i>	5	<i>Changing the back up battery</i>	20
<i>Listening to the radio</i>	6	<i>Specifications</i>	21
<i>Compact discs</i>	7	<i>Circuit features</i>	21
<i>Inserting a CD</i>	8	<i>General</i>	22
<i>Playing a CD</i>	9	<i>Guarantee</i>	23
<i>Selecting a track</i>	10		
<i>Search function</i>	10		
<i>CD repeat mode</i>	11		
<i>Warning</i>	11		
<i>Programmed play</i>	12		
<i>Checking a programme</i>	13		
<i>Erasing a programme</i>	13		
<i>Setting the alarm times</i>	14		
<i>Setting alarm 1</i>	14		
<i>Setting alarm 2</i>	15		
<i>Checking the alarm times</i>	15		
<i>Setting the alarms to wake to buzzer</i>	16		
<i>Setting the alarms to wake to radio</i>	17		
<i>Setting the alarms to wake to CD</i>	18		
<i>Snooze control</i>	19		

**Controls
Front**

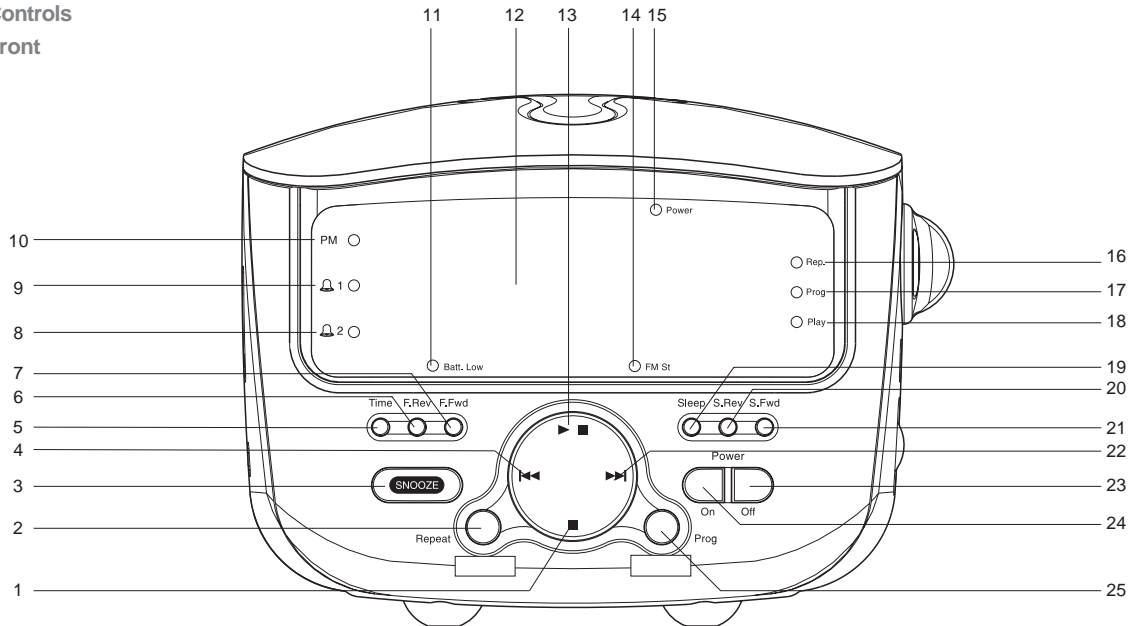

- | | | | | |
|--------------------|----------------------|-------------------------|-----------------------|--------------------|
| 1. Stop button | 6. F.Rev button | 11. Low Battery LED | 16. Repeat indicator | 21. S.Fwd button |
| 2. Repeat button | 7. F.Fwd button | 12. Clock/CD Display | 17. Program indicator | 22. F.Skip button |
| 3. Snooze button | 8. Alarm 2 indicator | 13. Play/Pause button | 18. CD Play indicator | 23. Off button |
| 4. B.Skip button | 9. Alarm 1 indicator | 14. FM Stereo indicator | 19. Sleep Set button | 24. On button |
| 5. Time Set button | 10. PM indicator | 15. Power indicator | 20. S.Rev button | 25. Program button |

Controls

Left hand side

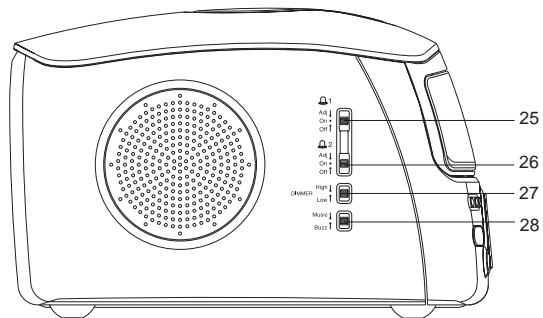

- 25. Alarm 1 function switch
- 26. Alarm 2 function switch
- 27. Dimmer switch
- 28. Alarm Mode switch

Right hand side

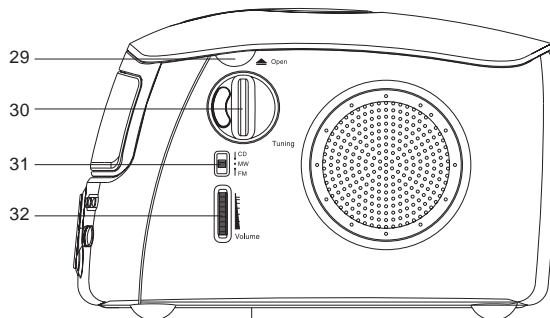

- 29. CD Door handle
- 30. Tuning control
- 31. Function switch
- 32. Volume control
- 33. Battery compartment (on underside)

Switching on and setting the time

Before using your CD clock radio you must first set the correct time.

1. Place the unit on a flat surface. Plug the mains lead into a wall socket and switch on at the wall socket.
2. The clock display will show 12:00. Ensure that the **Alarm 1** and **Alarm 2 function switches** are set to the 'Off' position.
3. Whilst holding down the **Time Set button** press the **F.Fwd button** to increase the time at a fast rate. The **S.Fwd button** will increase the time at a slow rate. The **F.Rev** and **S.Rev** buttons decrease the time at fast and slow rates. Release the buttons when the correct time is reached. The clock uses a 12 hour display with a **PM indicator**. Ensure that the correct 12 hour cycle is selected.

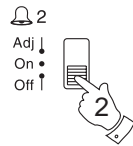
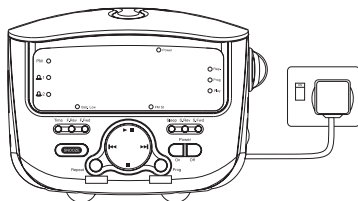

Time

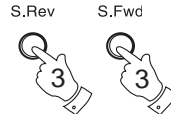
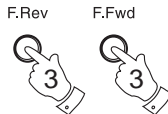

Listening to the Radio

1. Switch on your CD clock radio by pressing the **Power On button**. The **Power indicator** LED will light.

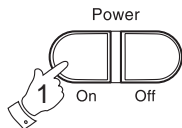

2. Slide the **Function switch** to the required waveband.

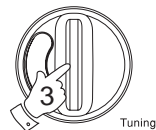

3. Tune in to the desired station by rotating the **Tuning control**. The station frequency is indicated in the dial scale.

The **Wire aerial** located on the rear of your CD clock radio is for FM reception. The wire should be fully extended and positioned for optimum reception.

For MW reception there is a built in ferrite aerial. Rotate your CD clock radio to the position giving best reception.

4. Adjust the volume by rotating the **Volume control**.



5. When the **Function switch** is set to FM and the station being received is an FM Stereo station the **FM Stereo indicator** will light.

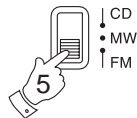

6. The radio can be switched off by pressing the **Power Off button**. The **Power indicator** will switch off.

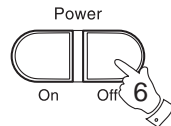

Compact discs

Use only Digital Audio CDs which have the



symbol.

Never write on a CD or attach any sticker to the CD. Always hold the CD at the edge and store it in its box after use with the label facing up.

To remove dust and dirt, breathe on the CD and wipe it with a soft, lint-free cloth in a straight line from the centre towards the edge.

Cleaning agents may damage the CD

Do not expose the CD to rain, moisture, sand, or to excessive heat. (e.g. from heating equipment or in motor cars parked in the sun).

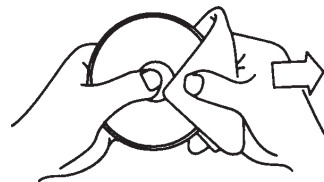

Inserting a CD

1. Press the **Power On button** to switch on your CD clock radio. The **Power indicator** will light.
2. Set the **Function switch** to CD.
3. To open the CD compartment, lift the **CD door** by the handle as shown.
4. Press the CD onto the spindle and close the **CD door**. The CD player will scan the contents of the CD and the number of the first track will appear on the display.

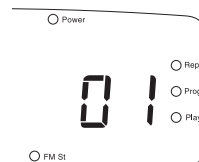
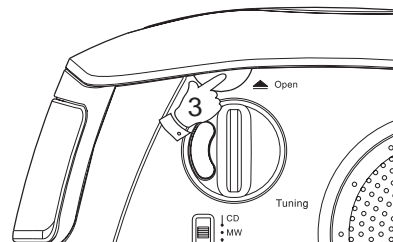
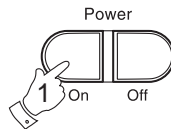

Playing a CD

1. Press the **Play/Pause button** to start playback. The **Play indicator** will light. The display will show the track number.
2. Set the **Volume control** to the required setting.
3. To pause playback press the **Play/Pause button**. The track number and **Play indicator** will flash in the display. To resume playback press the **Play/Pause button** again.
4. To stop playback, press the **CD Stop button**. The display will show the total number of tracks on the CD.
5. To take out the CD, lift the **CD door** by the handle and remove the CD from the spindle. The **CD door** should only be opened when the CD is in Stop mode.

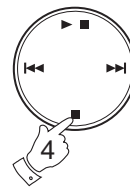
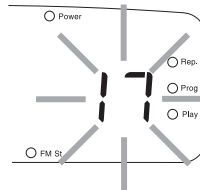
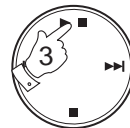
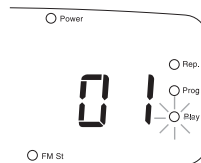
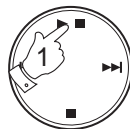

Selecting a track

1. Whilst the CD is playing, press either the **F.skip** or **B.skip** buttons to change to the desired track. You can also skip tracks when the player is in stop mode. Skip to the desired track using the **F.skip** or **B.skip** buttons.
2. Press the **Play/Pause** button to play the selected track.

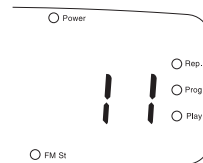
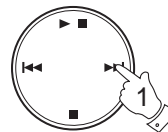
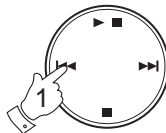

Search function

1. Whilst the CD is playing, press and hold down either the **F.skip** or **B.skip** buttons.
2. Release the button when the desired part of the track is reached.

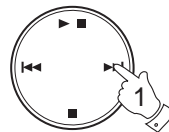
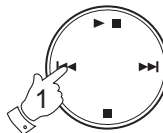

CD repeat mode

1. Whilst the CD is playing press the **Repeat button** once to repeat the current track. The **Repeat indicator** will flash.
2. Press the **Repeat button** again to repeat all tracks on the CD. The **Repeat indicator** will light up.
3. Press the **Repeat button** again to return to normal play. The **Repeat indicator** will switch off.



Warning

CLASS 1 LASER PRODUCT means that the laser's construction makes it inherently safe so that the legally prescribed maximum permissible radiation values can never be exceeded

Caution: Using any equipment or devices other than those described and specified in these operating instructions, or tampering with the unit in any way, can result in dangerous exposure to radiation.

**CLASS 1
LASER PRODUCT**

Programmed play

By programming the player you can play up to 20 tracks in any desired order.

1. Whilst the CD is in Stop mode, press the **Program button**. The display will show '01' and the **Program indicator** will flash.
2. Select the first track you wish to play using the **F.skip** or **B.skip** buttons. The track number will flash on the display. Store this track by pressing the **Program button**.
3. Repeat the above steps until you have completed your program (maximum 20 tracks). Press the **Play/Pause** button to commence play of the selected tracks.

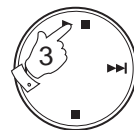
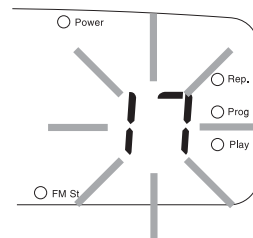
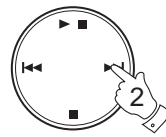
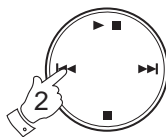

Checking a programme

1. Whilst the CD is in Stop mode, repeatedly press the **Program button** to step through the tracks programmed.

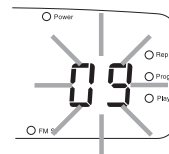

Erasing a programme

1. Programmes are erased by opening the **CD door**, changing position of the **Function switch**, pressing the **Power Off button**, or interrupting the mains supply.

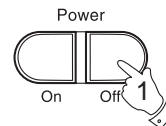

Setting the alarm times

The alarms can be set to wake you by a buzzer, CD or the radio. Your CD clock radio has 2 separate alarms which can be set to activate at different times.

Setting Alarm 1

1. Slide the **Alarm 1 function switch** to the 'Adj' position. Alarm 1 time will show in the display.
2. Press the **F.Fwd button** to increase the time at a fast rate. The **S.Fwd button** will increase the time at a slow rate. The **F.Rev** and **S.Rev** buttons decrease the time at fast and slow rates. Release the buttons when the correct time is reached. The clock uses a 12 hour display with a **PM indicator**. Ensure that the correct 12 hour cycle is selected.
3. Slide the **Alarm 1 function switch** to the 'On' position. The display will revert to showing time and the **Alarm 1 indicator** will light.

Note: Incorrect display will result if both the Alarm function switches are set to the 'Adj' position.

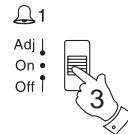

Setting Alarm 2

1. Slide the **Alarm 2 function switch** to the 'Adj' position. Alarm 2 time will show in the display.
2. Press the **F.Fwd button** to increase the time at a fast rate. The **S.Fwd button** will increase the time at a slow rate. The **F.Rev** and **S.Rev** buttons decrease the time at fast and slow rates. Release the buttons when the correct time is reached. The clock uses a 12 hour display with a **PM indicator**. Ensure that the correct 12 hour cycle is selected.
3. Slide the **Alarm 2 function switch** to the 'On' position. The display will revert to showing time and the **Alarm 2 indicator** will light.

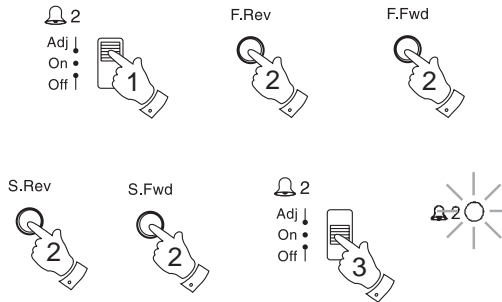

Checking the Alarm Times

1. To check Alarm 1 time, set the **Alarm 1 function switch** to the 'Adj' position. Alarm 1 time will show in the display.
2. Return the **Alarm 1 function switch** to its previous position. The display will revert to showing time.
3. To check Alarm 2 time, set the **Alarm 2 function switch** to the 'Adj' position. Alarm 2 time will flash in the display.
4. Return the **Alarm 2 function switch** to its previous position. The display will revert to showing time.



Note: Incorrect display will result if both the Alarm function switches are set to the 'Adj' position.

Setting the alarms to wake to buzzer

1. Set the alarm time as previously described. Set the **Alarm mode switch** to the 'Buzz' position.
2. Set the **Alarm 1 or Alarm 2 function switch** to the 'On' position. The corresponding **Alarm indicator** will light.
3. Press the **Power Off button** to switch off your CD clock radio, the **Power indicator** will switch off.
4. The buzzer alarm will sound every day at the preset time for 60 minutes. To switch off the alarm until the next day press the **Power Off button**.
5. To switch off the alarms permanently set the **Alarm 1 or Alarm 2 function switch** to the 'Off' position.

Note: Alarm 1 has a low tone Alarm 2 has a high tone.

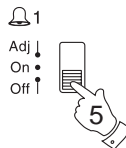
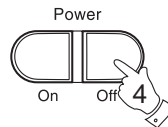
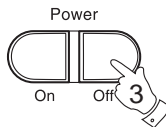
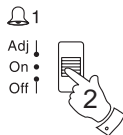
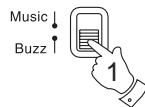

Setting the alarms to wake to radio

1. Set the alarm time as previously described. Set the **Alarm Mode switch** to the 'Music' position.
2. Set the **Alarm 1** or **Alarm 2 function switch** to the 'On' position. The corresponding **Alarm indicator** will light.
3. Select the required waveband using the **Function switch** and ensure that a station is tuned in
4. Set the **Volume control** to the desired level.
5. Press the **Power Off button** to switch off your CD clock radio, the **On indicator** will switch off.
6. The radio alarm will sound every day at the preset time for 60 minutes. To switch off the alarm until the next day press the **Power Off button**.
7. To switch off the alarms permanently set the **Alarm 1 or Alarm 2 function switch** to the 'Off' position.

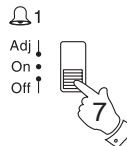
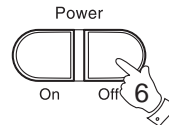
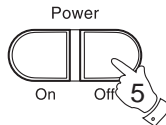
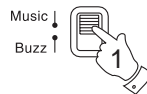

Setting the alarms to wake to CD

1. Set the alarm time as previously described. Set the **Alarm Mode switch** to the 'Music' position.
2. Set the **Alarm 1** or **Alarm 2 function switch** to the 'On' position. The corresponding **Alarm indicator** will light.
3. Set the **Function switch** to the 'CD' position, insert a CD and ensure that the **Volume control** is set to the desired level.



4. Press the **Power Off button** to switch off your CD clock radio, the **Power indicator** will switch off.

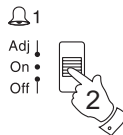

Important: Failure to switch off the unit will result in non operation of the CD at alarm time.

5. The CD will play every day at the preset time for a maximum of 60 minutes. To switch off the alarm until the next day press the **Power Off button**.
6. To switch off the alarms permanently set the **Alarm 1 or Alarm 2 function switch** to the 'Off' position.

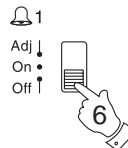
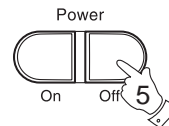
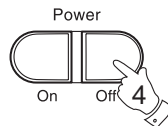

Snooze control

1. The buzzer, CD or radio alarm can be silenced for 7 minutes by pressing the **Snooze** button. This sequence can be repeated during the 60 minute alarm period.



Sleep timer

1. CD or radio playback can be set to switch off automatically after a preset time has elapsed.
2. Whilst holding down the **Sleep Set button** press the **F.Fwd button** to increase the time at a fast rate. The **S.Fwd button** will increase the time at a slow rate. The **F.Rev** and **S.Rev** buttons decrease the time at fast and slow rates. Release the buttons when the correct time is reached (maximum 59 minutes). The **Power indicator** will light up and after a few seconds the radio or CD will play for the selected sleep time.
3. The CD or radio will switch off after the sleep time has elapsed.
4. To cancel the sleep function before the preset time has expired, press the **Off button**.
5. To check remaining sleep time, press and hold the the **Sleep Set button**. The remaining time will appear in the display while the button is pressed.
6. To amend the sleep time after it has been set, press and hold the **Sleep Set button** and press the **F.Fwd**, **S.Fwd**, **F.Rev** or **S.Rev** buttons to increase or decrease the time.

Sleep



S.Rev



S.Fwd



F.Rev



F.Fwd



Power

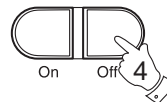

Dimmer

1. The **Dimmer switch**, located on the left side of your clock radio, can adjust the intensity of the clock display to suit room brightness. Slide the **Dimmer switch** to either the **High** or **Low** setting to change the display brightness.

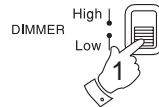

Changing the back up battery

1. If the **Batt. Low LED** illuminates it is necessary to change the back up battery.
2. Release and remove the battery cover (located on the underside of the clock radio), by pressing the catch in the direction of the arrow.
3. Replace the battery with a new one of the same specification, taking note to ensure the correct polarity is observed.
4. Replace the battery cover.
5. The **Batt. Low LED** should now have gone off.

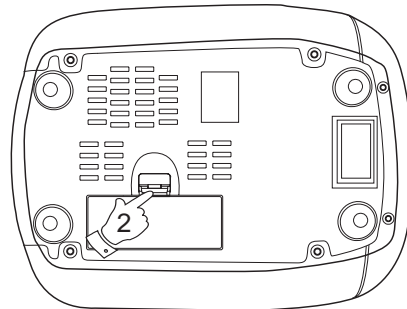

Specifications

Power Requirements

Mains	AC 230 volts, 50Hz  only
Back-up Battery	IEC size 6LR61 (6F22, PP3)

Frequency Coverage

FM	87.5 - 108MHz
MW	525 - 1605kHz

Circuit Features

Loudspeaker	8 ohms
Output power	0.8 Watts
Aerial System	FM Wire Aerial
	MW Built-in Ferrite Aerial



Warning

CLASS 1 LASER PRODUCT means that the laser's construction makes it inherently safe so that the legally prescribed maximum permissible radiation values can never be exceeded

Caution: Using any equipment or devices other than those described and specified in these operating instructions, or tampering with the unit in any way, can result in dangerous exposure to radiation.

The Company reserves the right to amend the specification without notice.

General

Do not allow this unit to be exposed to moisture (e.g. dripping or splashing) or to temperatures exceeding 70 degrees centigrade. It is recommended that the FM band be used wherever possible as better results in terms of quality and freedom from interference will usually be obtained than on the MW band.

Mains supply

The CR9970 will operate from a supply of AC 230volts, 50Hz \sim only. For your convenience this product is supplied with a plug which is fitted with a fuse of the appropriate rating. If the plug supplied is not suitable for your socket outlet, it should be removed by unscrewing the plug top, the terminal screws and removing the cable.

The correct style of plug to suit your household together with a correctly rated fuse should be fitted.

IF IN DOUBT - CONSULT A QUALIFIED ELECTRICIAN

IMPORTANT: DO NOT make any connection to the larger terminal which is marked with the letter E or by the safety earth symbol \perp or coloured Green or Green-and-yellow.

The wires in the mains lead are coloured in accordance with the following codes :-

BLUE - NEUTRAL

BROWN - LIVE

As these colours may not correspond with the coloured markings identifying the terminals in your plug, proceed as follows:-

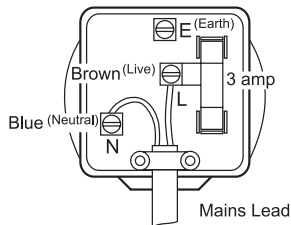

The wire coloured BLUE must be connected to the terminal marked N or coloured BLACK.

The wire coloured BROWN must be connected to the terminal marked L or coloured RED.

Fuse

This apparatus must be protected by a 3A fuse (BS1362) in a 13A plug (BS1363). If another type of plug is used a 5A fuse should be fitted in the plug, adaptor or distribution board.

IF IN DOUBT - CONSULT A QUALIFIED ELECTRICIAN.

Back-up Battery (not necessary for the unit to function)

Slide the battery cover catch in the direction of the arrow. Open the battery cover. Fit a 9 volt IEC size 6LR61 (6F22, PP3) or equivalent battery into the compartment. Observe the correct polarity as shown inside the battery compartment. Replace the battery cover.

The time and alarm settings will be retained during a temporary failure of the AC mains supply. The LED display will not be operational. The display will be extinguished to conserve battery life, but the memory will retain details of the time and alarm time settings.

If your clock radio is not to be used for a prolonged period of time, remove the battery to avoid damage by battery leakage.

The Nameplate is located on the underside of your CD clock radio.

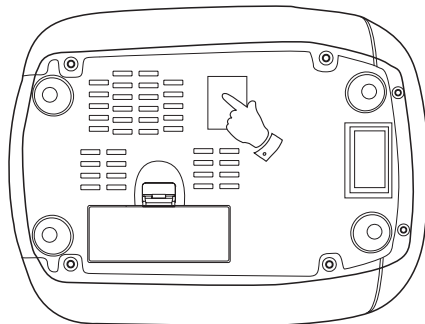

Guarantee

This instrument is guaranteed for twelve months from the date of delivery to the original owner against failure due to faulty workmanship or component breakdown, subject to the procedure stated below. Should any component or part fail during this guarantee period it will be repaired or replaced free of charge.

The guarantee does not cover:

1. Damage resulting from incorrect use.
2. Consequential damage.
3. Receivers with removed or defaced serial numbers.

Procedure:

Any claim under this guarantee should be made through the dealer from whom the instrument was purchased. It is likely that your Roberts' dealer will be able to attend to any defect quickly and efficiently, but should it be necessary the dealer will return the instrument to the company's service department for attention. In the event that it is not possible to return the instrument to the Roberts' dealer from whom it was purchased, please contact Roberts Radio Technical Services department at the address shown on the rear of this manual before taking further action.

These statements do not affect the statutory rights of a consumer.

ROBERTS RADIO TECHNICAL SERVICES

97-99 Worton Road
Isleworth Middlesex
TW7 6EG

Issue 1

Technical Helpline:- 020 8758 0338 (*Mon-Fri*)

Download from www.somanuals.com. All Manuals Search And Download.



Free Manuals Download Website

<http://myh66.com>

<http://usermanuals.us>

<http://www.somanuals.com>

<http://www.4manuals.cc>

<http://www.manual-lib.com>

<http://www.404manual.com>

<http://www.luxmanual.com>

<http://aubethermostatmanual.com>

Golf course search by state

<http://golfingnear.com>

Email search by domain

<http://emailbydomain.com>

Auto manuals search

<http://auto.somanuals.com>

TV manuals search

<http://tv.somanuals.com>