

ROBERTS

Sound for Generations



CR9987

CD Stereo Alarm
Clock Radio

PISA 87

Please read this manual before use

Contents

<i>Contents</i>	1	<i>Radio Data System (RDS)</i>	20
<i>Controls</i>	2-5	<i>Operating your radio using RDS</i>	21
<i>Important Information</i>	6	<i>Display modes</i>	21
<i>Battery operation</i>	6	<i>Traffic announcements (TA)</i>	22
<i>Mains operation</i>	6	<i>Compact discs</i>	23
<i>Display backlight</i>	7	<i>CD-R/CD-RW discs</i>	23
<i>Night light</i>	7	<i>Inserting a CD</i>	24
<i>Automatic plug and play setup</i>	8	<i>Playing a CD</i>	25
<i>Setting the clock automatically</i>	9	<i>Selecting a track</i>	26
<i>Setting the clock/day of week manually</i>	10	<i>Search function</i>	26
<i>Setting the alarm times</i>	11	<i>CD Repeat mode</i>	27
<i>Setting the alarm times to wake to buzzer</i>	11	<i>CD Intro play</i>	27
<i>Setting the alarm times to wake to radio</i>	12	<i>CD Random play</i>	27
<i>Setting the alarm times to wake to CD</i>	13	<i>Programmed play</i>	28
<i>Displaying the alarm time and alarm mode</i>	14	<i>Checking and editing a programme</i>	29
<i>Weekend alarm cancel</i>	14	<i>Erasing a programme</i>	30
<i>Snooze control</i>	15	<i>Headphones</i>	30
<i>Sleep timer</i>	15	<i>General</i>	31
<i>Operating your radio - search tuning</i>	16	<i>Specifications & Circuit features</i>	32
<i>Operating your radio - manual tuning</i>	17	<i>Warning</i>	32
<i>Presetting stations</i>	18	<i>Notes</i>	33
<i>Recalling a preset station</i>	19	<i>Guarantee</i>	34
<i>Last station memory</i>	19		

**Controls
(Top)**

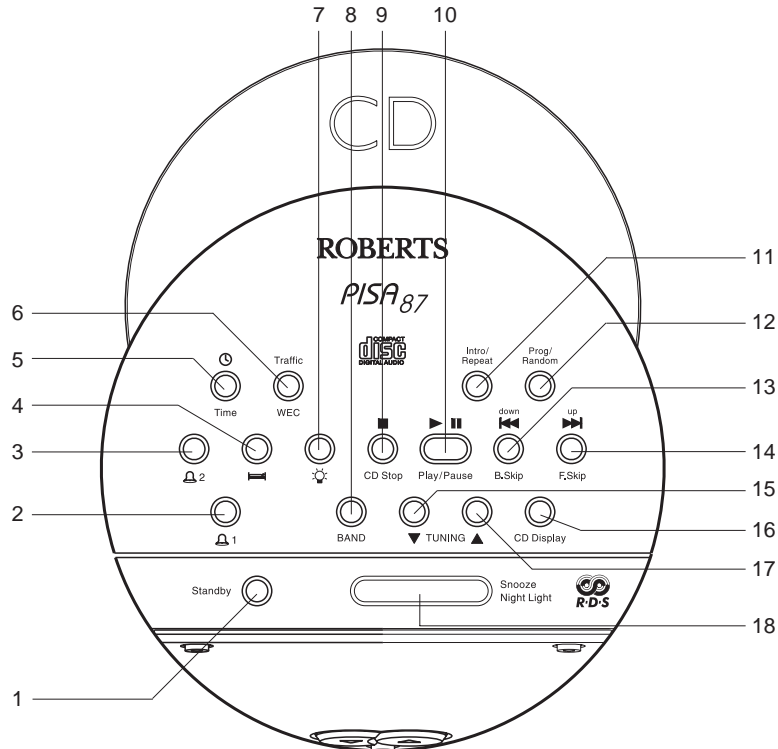

- | | | |
|---------------------------------|--------------------------|------------------------|
| 1. Standby | 7. Display light | 13. Down/B.Skip |
| 2. Alarm 1 | 8. Band selection button | 14. Up/F.Skip |
| 3. Alarm 2 | 9. Stop | 15. Tuning down |
| 4. Sleep | 10. Play/Pause | 16. Display |
| 5. Clock time set | 11. Intro/Repeat | 17. Tuning up |
| 6. Traffic/weekend alarm cancel | 12. Prog/Random | 18. Snooze/Night Light |

**Controls
(Left Side)**

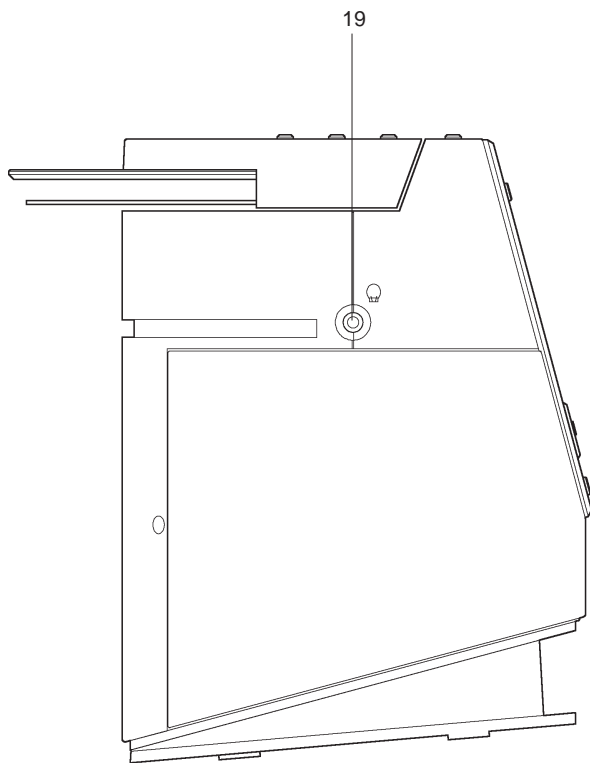

19. Headphone socket

(Right Side)

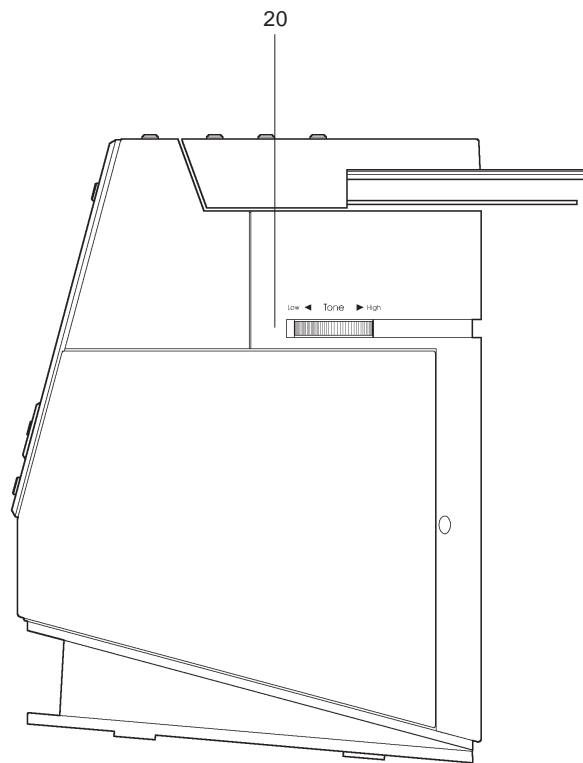

20. Tone control

Controls (Front)

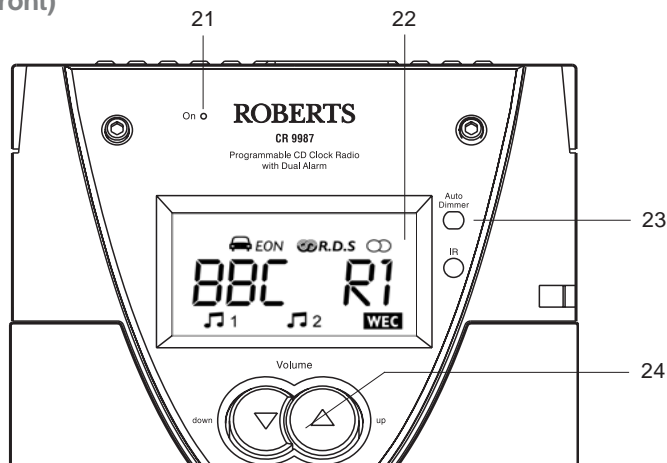

- 21. Power on LED
- 22. Display
- 23. Auto Dimmer
- 24. Volume control
- 25. CD Stop
- 26. B.Skip

(Remote Control)

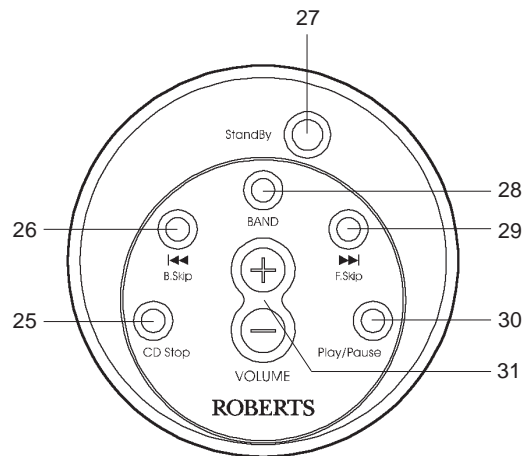

- 27. StandBy
- 28. Band
- 29. F.Skip
- 30. Play/Pause
- 31. Volume

Controls (Display)

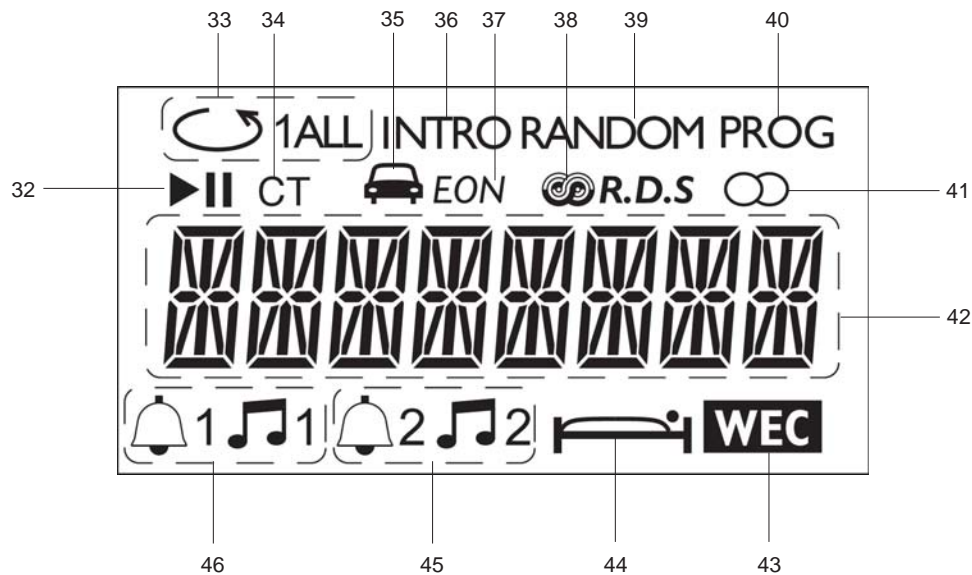

32. CD play/pause indicator
 33. CD repeat indicator
 34. Clock Time indicator
 35. Traffic information indicator
 36. CD track intro indicator

37. Enhanced other networks indicator
 38. RDS indicator
 39. CD random track indicator
 40. Programme indicator
 41. Stereo indicator

41. Frequency, time and text display area
 42. Weekend alarm cancel indicator
 43. Sleep time indicator
 44. Alarm 2 indicators
 45. Alarm 1 indicators

Important Information - please read before use

To assist the auto setup of your clock radio it is recommended that, before connecting your radio to the mains supply, to fully extend the pig tail aerial on the rear of your clock radio and place your clock radio in a position where radio reception is best.

Note: The two LR6 (AA size) batteries provide power for the clock/memory backup and must be fitted at all times.

Battery operation

1. Remove the **Battery cover** on the base of your CD clock radio by pressing the tab on the cover and lifting in the direction of the arrow. Insert 2 x LR6 (AA size) batteries into the spaces in the compartment. Observe the correct battery polarity as shown inside the battery compartment. Replace the battery cover.
2. Remove Battery cover on base of your remote control by rotating the cover to the **Open** position. Insert 2 x LR03 (AAA size) batteries into the spaces in the compartment. Observe the correct battery polarity as shown inside the battery compartment. Replace the battery cover.

Mains Operation

1. Place your radio on a flat surface.
2. Plug the mains plug into a wall socket and switch on the wall socket.

Note: The unit remains connected to the mains even when it is switched off. The unit is only isolated from the mains if the mains plug is removed from the wall socket.

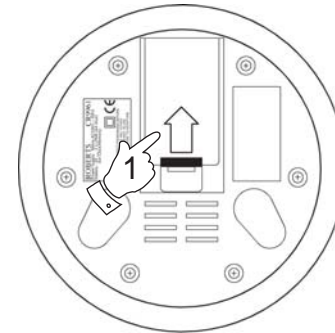

Remote Control

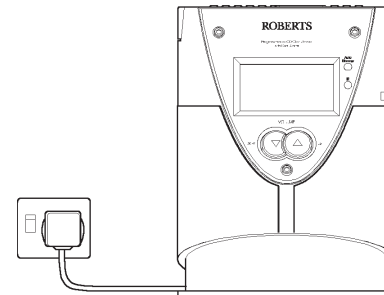
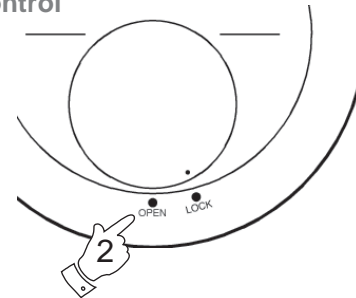

Display backlight

During automatic setup and radio text, the display backlight will remain on. The display back light will be switched on for 10 seconds whenever any button is pressed.

The display backlight can also be set to remain on at 3 different levels, dim, bright and off.

1. Press the **Light button** for dim backlight, press once again for bright backlight and once again for off.



Night light

1. Press the Night Light button to adjust level of night light, press once for dim light press once again for bright light and once again to switch off.

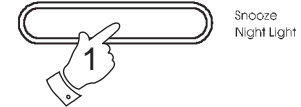

Automatic Plug and Play setup

When your Clock Radio is first connected to the mains supply, or after a power failure (when backup battery is not installed), the Auto setup will proceed as follows:-

- Your radio will show "FM 87.5", then automatically search all wavebands and store stations in presets.
 - Automatically set the time and day of week.
1. Connect to mains (see page 6). Your radio will scan through the FM waveband, storing stations of sufficient strength as presets.

Note: To interrupt the automatic tuning, press the **Prog/Random button** once.

2. Your radio is ready for use when the FM waveband has been fully searched.

After having performed the automatic memory set up process, the display will show a DEMO briefly introducing the RDS features.

3. The Clock Time (CT) indicator will flash in the display whilst time setting is carried out.

Note: To interrupt the automatic time set, or stop the DEMO mode, press any button once.

4. If the first station detected by the automatic setup does not carry CT information your radio will automatically change to another station after 1-2 minutes. This process will repeat until the clock is set.
5. Press the **BAND button** to switch on your radio and press the **up** and **down buttons** to select a preset station. Adjust the volume using the **VOLUME control**. To switch off your radio press the **StandBy button**.

Note:- Auto setup can take up to 5 minutes to complete and is dependent on the signal strength and number of stations in your area. Should Auto setup fail, setting the clock and pre-setting stations can be carried out manually as described in the following sections.

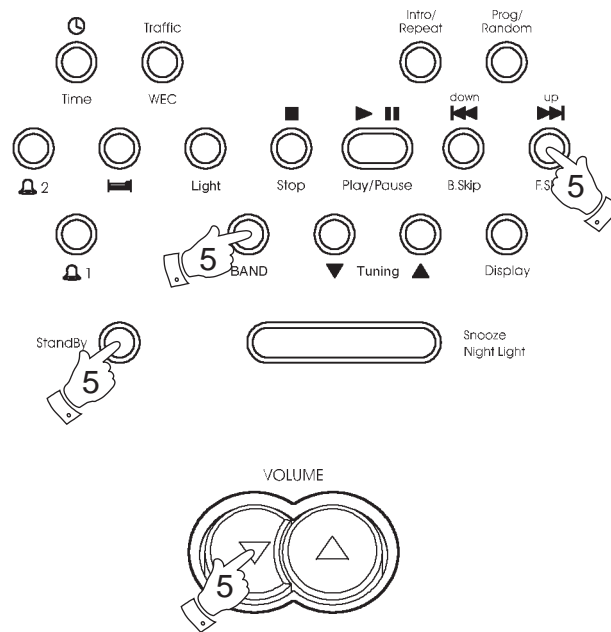
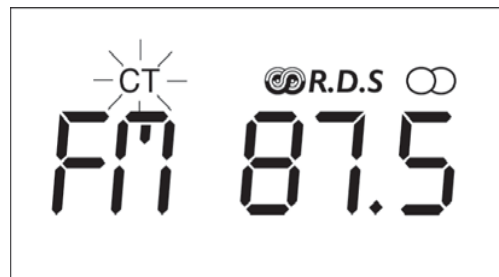

If you need any further advice, please call our Technical Helpline on :-

020 8758 0338 (Mon-Fri)

Download from www.Somanuals.com. All Manuals Search And Download.

Setting the Clock Automatically

The clock time and day of week can be set automatically when receiving an RDS radio station that transmits clock time (CT). The CT information is transmitted once every minute. If the signal has sufficient signal strength the clock will set within one to two minutes.

1. Switch on the radio with the **BAND button** on the CD clock radio or the **BAND button** on the remote control.
2. Select an RDS station using the **Tuning Up/Down buttons**.
3. "CT" will flash in the LCD display indicating that the radio is waiting for an RDS time signal. The "CT" indicator will stop flashing when the time is set.

Note:- If the clock does not set within three to four minutes, the radio station may not be transmitting clock time (CT) information, in this case try another radio station.

The clock time and day of week are updated every time the radio is switched on and whilst listening to an RDS station transmitting clock time (CT) information.

Auto setup can take up to 5 minutes to complete and is dependent on the signal strength and number of stations in your area. Should Auto setup fail, setting the clock and pre-setting stations can be carried out manually as described in the following sections.

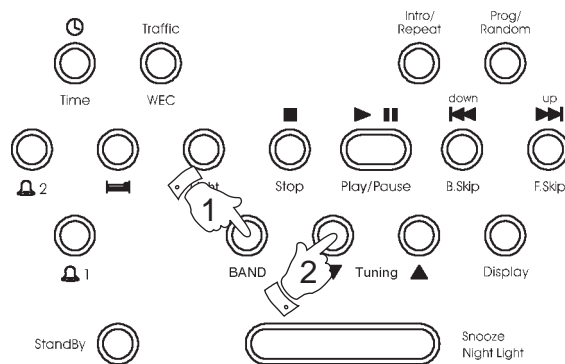

Remote Control

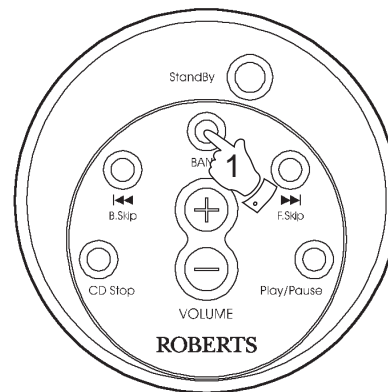

Setting the clock/day of week manually

1. Ensure that the radio is switched off (press StandBy).
2. Press and hold down the **Time button** until the hour digit flashes.
3. Press the **Tuning Up/Down buttons** to set the correct hour.
4. Press the **Time button** to confirm. The minute digit now flashes.
5. Press the **Tuning Up/Down buttons** to set the correct minutes.
6. Press the **Time button** to confirm. The day of week now flashes.
7. Press the **Tuning Up/Down buttons** to set the correct day.
8. Press the **Time button** to confirm/complete the time setting.

Note: The clock uses a 12 hour display

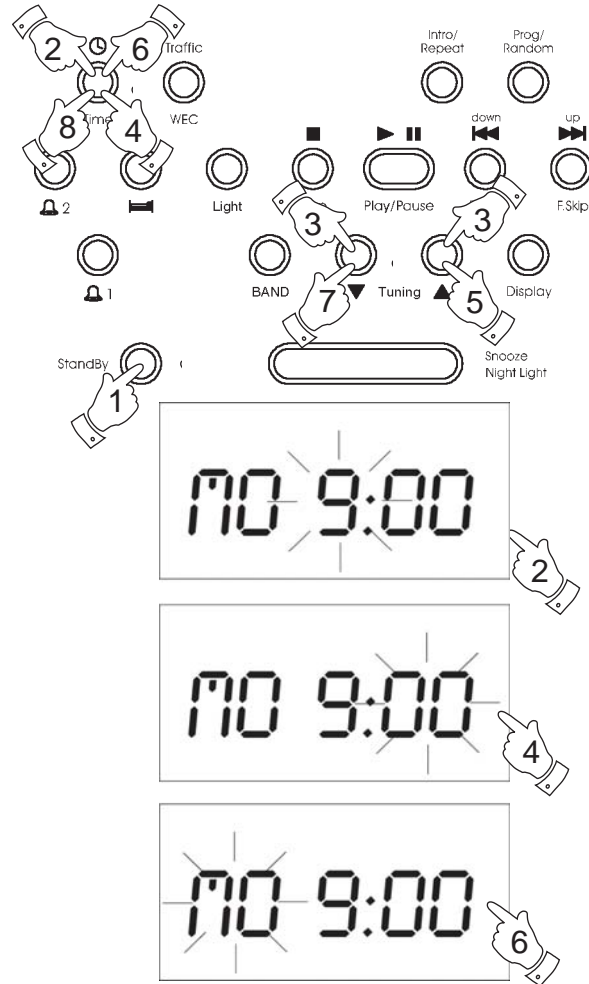

Setting the alarm times

The alarms can be set to wake you by a buzzer, CD or the radio. Your CD clock radio has 2 separate alarms which can be set to activate at different times.

Setting the alarms to wake to buzzer

1. Ensure that the radio is switched off (press **StandBy**).
2. Press and hold down the **Alarm 1 or Alarm 2 button** until the hour digit flashes.
3. Press the **Tuning Up/Down buttons** to set the correct hour.
4. Press the applicable **Alarm button** (1 or 2) to confirm. The minute digit now flashes.
5. Press the **Tuning Up/Down buttons** to set the correct minutes.
6. Press the applicable **Alarm button** (1 or 2) to confirm.
7. Press the **Tuning Up/Down buttons** to select BUZZ.
8. Press the applicable **Alarm button** (1 or 2) to confirm.
9. Press the **Tuning Up/Down buttons** to select alarm volume - H (High), L (Low) or M (Medium).
10. Press the applicable **Alarm button** (1 or 2) to confirm.
11. At the preselected time the buzzer will switch on. The buzzer will switch off automatically after 90 minutes. The buzzer alarm may be switched off for 24 hours by pressing the **StandBy button**.
12. To permanently cancel the buzzer alarm set the alarm time as described, then select OFF using the **Tuning Up/Down buttons**.

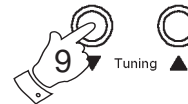
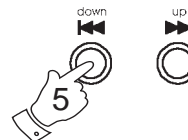
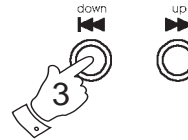

Setting the alarms to wake to radio

1. Ensure that the radio is switched off (press **StandBy**).
2. Press and hold down the **Alarm 1 or Alarm 2 button** until the hour digit flashes.
3. Press the **Tuning Up/Down buttons** to set the correct hour.
4. Press the applicable **Alarm button** (1 or 2) to confirm. The minute digit now flashes.
5. Press the **Tuning Up/Down buttons** to set the correct minutes.
6. Press the applicable **Alarm button** (1 or 2) to confirm.
7. Press the **Tuning Up/Down buttons** to select TUNER.
8. Press the applicable **Alarm button** (1 or 2) to confirm.
9. Press the **Tuning Up/Down buttons** to select alarm volume - H (High), L (Low) or M (Medium).
10. Press the applicable **Alarm button** (1 or 2) to confirm.
11. At the preselected time the radio will switch on. The radio will switch off automatically after 90 minutes. The radio alarm may be switched off for 24 hours by pressing the **StandBy button**.
12. To permanently cancel the radio alarm set the alarm time as described, then select OFF using the **Tuning Up/Down buttons**.

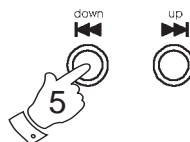
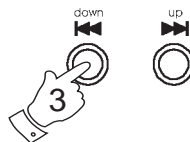

Setting the alarms to wake to CD

1. Ensure that the radio is switched off (press **StandBy**).
2. Press and hold down the **Alarm 1** or **Alarm 2** button until the hour digit flashes.
3. Press the **Tuning Up/Down** buttons to set the correct hour.
4. Press the applicable **Alarm** button (1 or 2) to confirm. The minute digit now flashes.
5. Press the **Tuning Up/Down** buttons to set the correct minutes.
6. Press the applicable **Alarm** button (1 or 2) to confirm.
7. Press the **Tuning Up/Down** buttons to select CD.
8. Press the applicable **Alarm** button (1 or 2) to confirm.
9. Press the **Tuning Up/Down** buttons to select alarm volume - H (High), L (Low) or M (Medium).
10. Press the applicable **Alarm** button (1 or 2) to confirm.
11. At the preselected time the CD will switch on. The CD will switch off automatically after 90 minutes. The CD alarm may be switched off for 24 hours by pressing the **StandBy** button.
12. To permanently cancel the CD alarm set the alarm time as described, then select OFF using the **Tuning Up/Down** buttons.

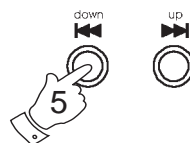
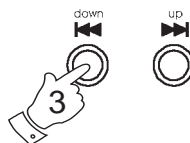

Displaying the alarm time and alarm mode

1. Press either the **Alarm 1** or **Alarm 2 buttons**; the alarm time and alarm mode will be displayed.



Weekend alarm cancel

Your clock radio can be set to automatically cancel alarms at the weekend.

1. **Ensure that your clock radio is switched off (press StandBy).**
3. Press the **Traffic/WEC button** until the **WEC** symbol appears in the display. The alarm will now only sound on weekdays.
4. To switch off the weekend cancel function press the **Traffic/WEC button** until the **WEC** symbol disappears from the display.



Snooze control

1. The radio, buzzer, or CD alarm, can be silenced for 5 minutes by pressing the **Snooze button**. This sequence can be repeated during the 90 minutes alarm period.

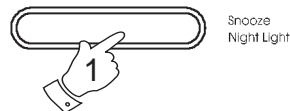

Sleep timer

CD or radio playback can be set to switch off automatically after a preset time has elapsed.

1. Repeatedly press and release the **Sleep button** until the desired time is reached (maximum 90 minutes in 10 minute steps).
The  indicator will light up in the display.
2. The CD or radio will switch off after the sleep time has elapsed.
3. To cancel the sleep function before the preset time has expired, press the **StandBy button**.
4. To check the remaining sleep time, press the **Sleep button** once during time display.



Operating your radio - search tuning

1. Switch on your clock radio by pressing the **BAND** button on the CD clock radio or the **BAND** button on the remote control.
2. Select the required waveband by pressing the **BAND** button on the CD clock radio or the **BAND** button on the remote control. The waveband selected will appear in the display. On FM fully extend the wire aerial from the rear of your clock radio. On MW rotate your radio for best reception.
3. Press and hold down either the **Tuning up** or **Tuning down** buttons until the frequency in the display begins to change rapidly. Release the button.
4. Your radio will scan the selected waveband, stopping each time it finds a station of sufficient strength. Adjust the **VOLUME control** to the required setting.
5. To search for additional stations repeat the above procedure. Search tuning may be stopped by a single press on either the **Tuning up** or **Tuning down** buttons.
6. The tone of your radio can be altered by adjusting the **Tone control** on the right hand side of the unit.
7. Press the **StandBy** button to switch off your radio.

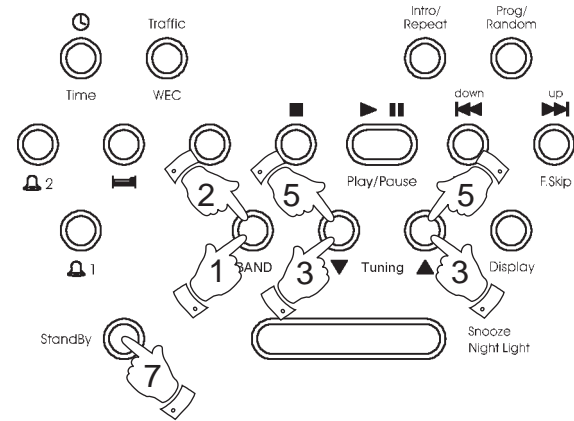

Remote Control

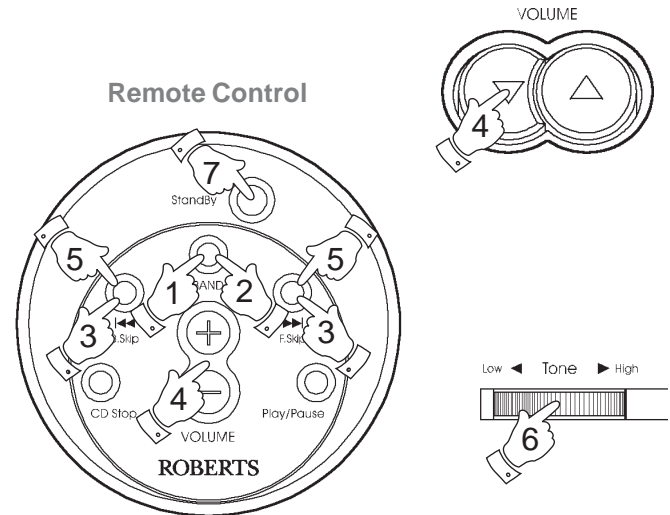

If you need any further advice, please call our Technical Helpline on :-

020 8758 0338 (Mon-Fri)

Download from www.Somanuals.com. All Manuals Search And Download.

Operating your radio - manual tuning

1. Switch on your radio by pressing the **BAND** button on the CD clock radio or the **BAND button** on the remote control.
2. Select the required waveband by pressing the **BAND button**. The waveband selected will appear in the display. On FM fully extend the wire aerial from the rear of your clock radio. On MW rotate your radio for best reception.
3. A single press on either the **Tuning up or Tuning down buttons** will change the frequency up or down. The frequency steps are:- FM 50kHz and MW 9kHz.
4. Adjust the **VOLUME control** to the required level.
5. The tone of your radio can be altered by adjusting the **Tone control** on the right hand side of the unit.
6. Press the **StandBy button** to switch off your radio.

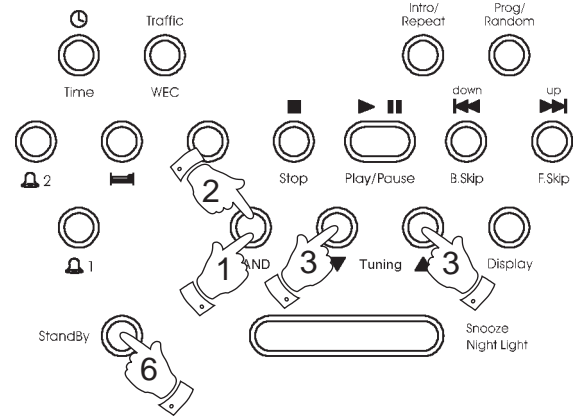
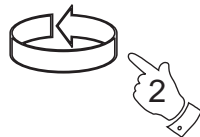
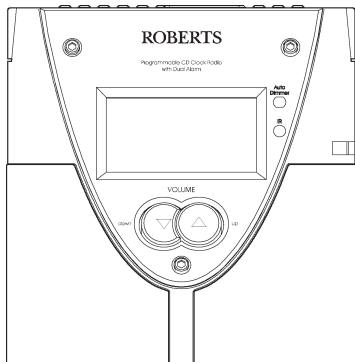

Remote Control

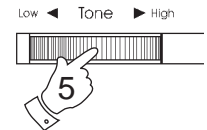
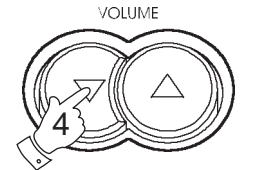
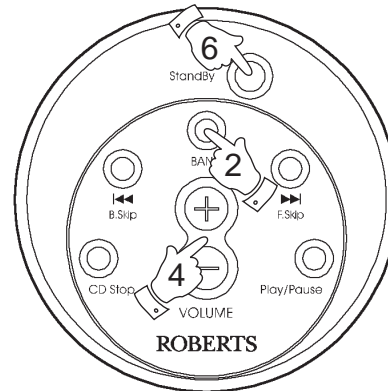

Pre-setting stations

You may store up to 10 different stations on each of the two wavebands giving a total of 20 preset stations.

1. Switch on your radio using the **BAND button** on the CD clock radio or the **BAND button** on the remote control.
2. Select the desired waveband using the **BAND button** on the CD clock radio or the **BAND button** on the remote control.
3. Tune into the required station using one of the tuning methods previously described.
4. Press and release the **Prog/Random button**, the word 'PROG' will flash in the display.
5. Whilst 'PROG' is flashing, press either the **up or down buttons** on the CD clock radio or the **F.Skip or B.Skip buttons** on the remote control to the preset under which you wish to store the station.
6. Press the **Prog/Random button** to store the station. The preset number will now appear under 'PROG' in the display.
7. Repeat the above procedure for the remaining presets
8. Press the **Standby button** to switch off your radio.

Note: Pre-setting of stations can only be carried out whilst 'PROG' is flashing in the display (10 seconds).

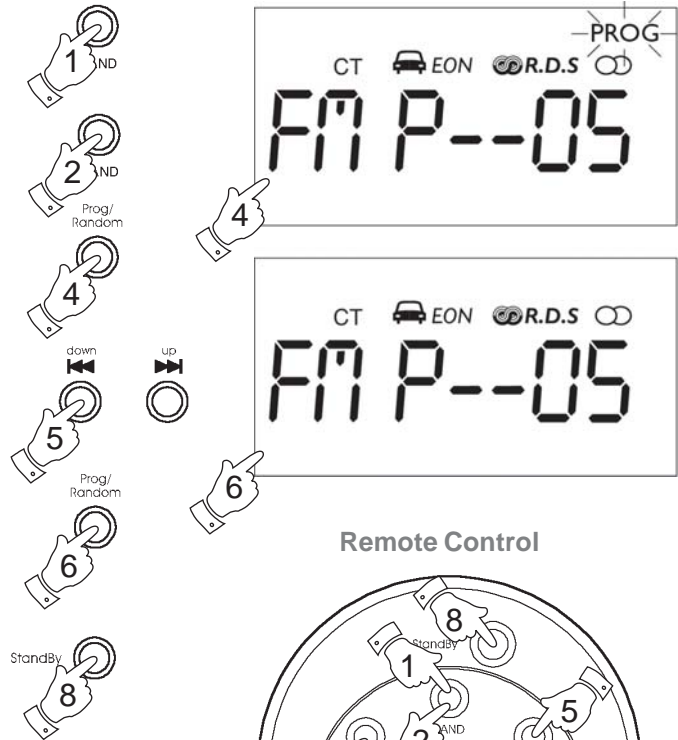

Remote Control

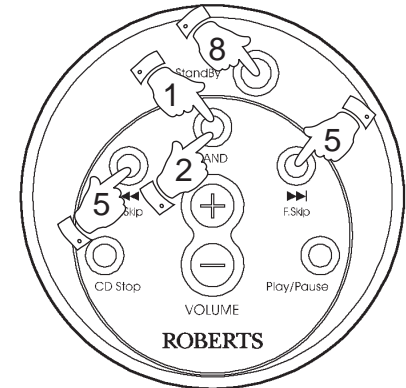

If you need any further advice, please call our Technical Helpline on :-

020 8758 0338 (Mon-Fri)

Download from www.Somanuals.com. All Manuals Search And Download.

Recalling a preset station

1. Switch on your radio using the **BAND button** on the CD clock radio or the **BAND button** on the remote control.
2. Select the desired waveband using the **BAND button** on the CD clock radio or the **BAND button** on the remote control.
3. Press one of the **up or down buttons** on the CD clock radio or the **F.Skip or B.Skip buttons** on the remote control to recall the station.

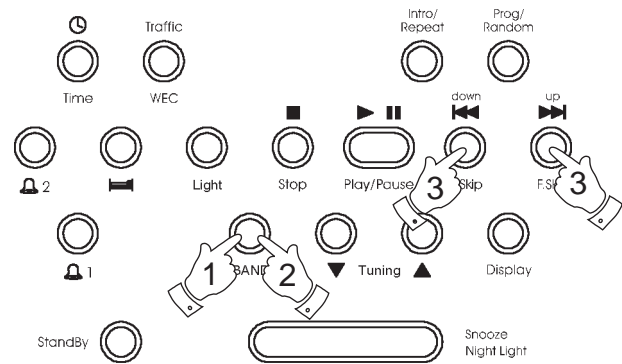

Remote Control

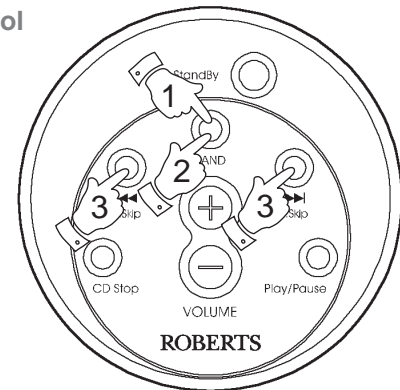

Last station memory

1. Your CD clock radio provides an automatic last station memory function. This function recalls the station that was playing when the radio was switched off.

Radio Data System (RDS)

The **Radio Data System (RDS)** is a system in which inaudible digital information is transmitted in addition to the normal FM radio programme. **RDS** offers several useful features. The following are available on your radio:-

Programme Identification (PI)

This information consists of a code, which is assigned to each individual radio programme to enable it to be distinguished from all others. It is not intended for direct display or access by the user but used internally by the microprocessor.

Programme Service (PS) name

The **Programme Service** name is a text usually consisting of not more than eight alphanumeric characters. It indicates information about the programme being broadcast. A station name or an abbreviation is shown in the display instead of the tuned frequency (Example: *BBC R4*).

Traffic Information System

The **Traffic Programme** identification (**TP**) indicates which **RDS** stations provide traffic information. The **Traffic Announcement** identification (**TA**) indicates traffic information is being broadcast. When **TA** is received, the  symbol will flash and the volume increases slightly.

Enhanced Other Network (EON)

Additional information about other programmes within the same network is transmitted when your broadcasting station is using an **Enhanced Other Network**. The **EON** indicator will be displayed and you will hear traffic flashes of other programmes within the network automatically (if the **Traffic Announcement/EON** function is switched on).

Clock Time (CT) automatic adjustment

The **Clock Time** information transmitted from the broadcasting station can be used for setting and synchronising the clock of your radio automatically. The Auto-Time function can be enabled or disabled by the user.

Note: **RDS** features are available on the **FM** band only.

Operating your radio using RDS (Radio data system)

1. Switch on your radio and select the FM waveband.
2. Tune into a station; the display will indicate frequency for two seconds and then change to show the station name. The  R.D.S symbol will appear in the display.
3. If the station does not carry RDS information only the station frequency will be shown.

Note: the RDS indicator will flash if the signal is too weak for RDS operation.



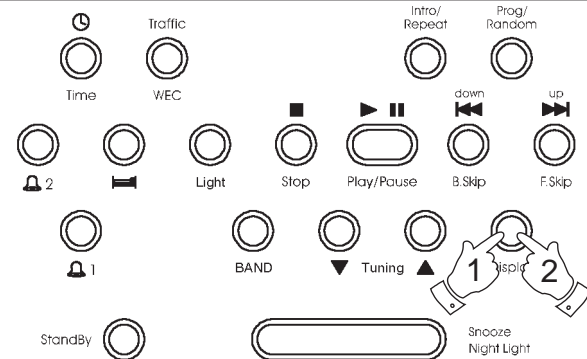

Display Modes

After tuning to an RDS station, the display briefly indicates the stations frequency and then the station name.

1. To display the stations frequency press the **Display button** twice; the display briefly indicates the frequency followed by the station name. If the station is not transmitting an RDS signal or the signal is too weak, station frequency will be displayed instead of station name.
2. To return to time display press the **Display button** once.



Traffic Announcements (TA)

1. Switch on the radio; select the FM waveband and tune to an RDS station. The symbol  **R.D.S** will appear in the display.
 2. Press the **Traffic/WEC button**. If the station provides traffic information the symbol  will appear in the display.
 3. If the station does not provide traffic information the symbol  will not appear and the radio will beep indicating that no traffic information is available.
 4. During traffic announcements the symbol  will flash in the display and the volume will increase slightly.
 5. Press the **Traffic/WEC button** to cancel the Traffic function.
 6. If the station carries Enhanced Other Network information the **EON** symbol will appear in the display. The radio will automatically tune to other stations transmitting traffic information. When the traffic announcement has finished the radio will re-tune to the previously selected station.
 - e.g. If the radio is tuned to a national station such as BBC Radio 4, it will automatically re-tune to any BBC local station broadcasting traffic announcements. When the traffic announcement on the local station is finished the radio will re-tune to the previously selected station.
- Note:** There may be occasions when the station to which you are listening tells the radio to re-tune to a traffic announcement on a local station that is not receivable at your location. Under these circumstances there will be some hiss before the radio re-tunes back to the previously selected station.
7. To switch off traffic information press the **Traffic/WEC button**, the symbol  will be removed from the display.

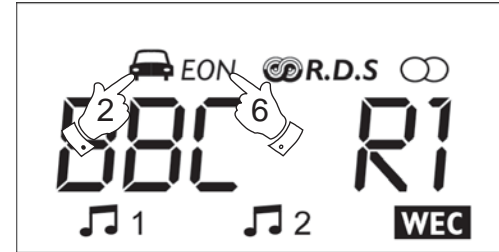

If you need any further advice, please call our Technical Helpline on :-

020 8758 0338 (Mon-Fri)

Download from www.Somanuals.com. All Manuals Search And Download.

Compact discs

Use only Digital Audio CDs which have the  symbol.

Never write on a CD or attach any sticker to the CD. Always hold the CD at the edge and store it in its box after use with the label facing up.

To remove dust and dirt, breathe on the CD and wipe it with a soft, lint-free cloth in a straight line from the centre towards the edge.

Cleaning agents may damage the CD

Do not expose the CD to rain, moisture, sand, or to excessive heat. (e.g. from heating equipment or in motor cars parked in the sun).

CD-R/CD-RW discs

Your CD clock radio can playback CD-DA format audio CD-R/CD-RW discs that have been finalised* upon completion of recording.

Your CD clock radio may fail to playback some CD-R/CD-RW discs due to poor recording of the CD-R/CD-RW disc.

**Finalising enables a CD-R/CD-RW disc to playback on audio CD players such as your CD clock radio.*

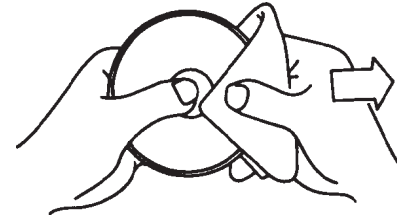

Inserting a CD

1. To switch on your CD clock radio, press the Play/Pause button on either the clock radio or the remote control.
2. To open the CD compartment, lift the **CD door** on the rear edge as shown.
3. Press the CD onto the spindle until it clicks into place. Close the **CD door**. The CD player will scan the contents of the CD, the total number of tracks and total playing time will appear on the display.

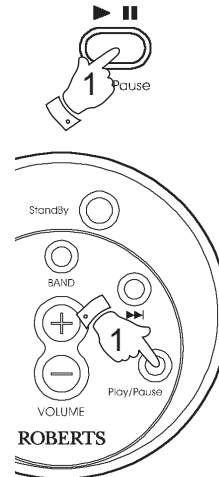

Remote Control

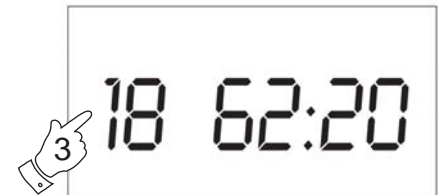
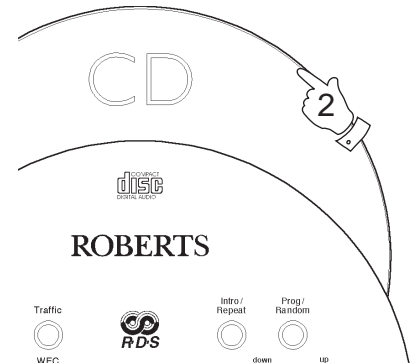

Playing a CD

1. Press the **CD Play/Pause button** to start playback. The display will show '01' and the elapsed playing time.
2. Whilst the CD is playing, press either the **F.Skip** or **B.Skip buttons** to change to the desired track, the track number appears in the display.
3. You can also skip tracks when the player is in stop mode. Skip to the desired track using the **F.Skip** or **B.Skip buttons**.
4. The selected track will play automatically.
5. The tone of your radio can be altered by adjusting the **Tone control** on the right hand side of the unit.
6. To stop playback, press the CD Stop button.
7. To take out the CD, lift the CD door on the rear edge and remove CD from the spindle. The CD door should only be opened when the CD is in Stop mode.

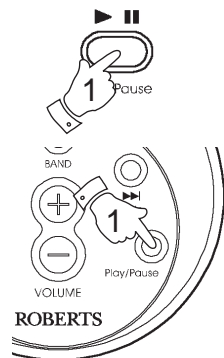

Remote Control

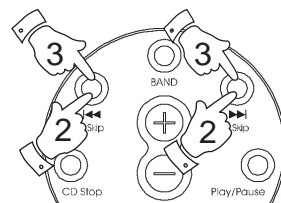

Remote Control

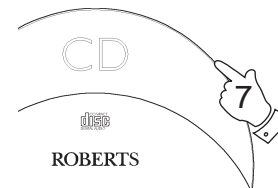
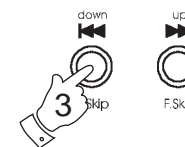
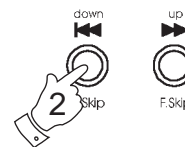
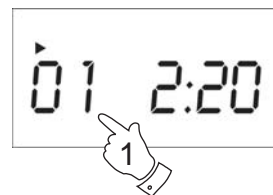
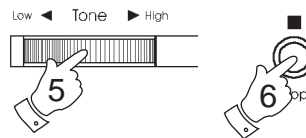

Selecting a track

1. Whilst the CD is playing, press either the **F.Skip** or **B.Skip buttons** to change to the desired track. You can also skip tracks when the player is in stop mode. Skip to the desired track using the **F.Skip** or **B.Skip buttons**
2. Press the **CD Play/Pause button** to play the selected track.

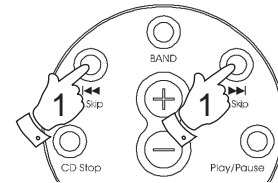
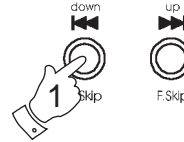

Remote Control

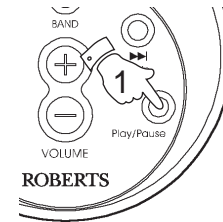

Remote Control

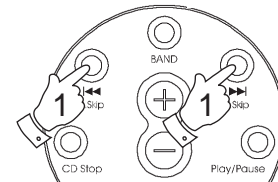
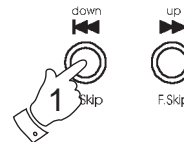

Search function

1. Whilst the CD is playing, press and hold down either the **F.Skip** or **B.Skip buttons**. Release the button when the desired part of the track is reached.



Remote Control

CD repeat mode

1. Whilst the CD is playing press the **Intro/Repeat button** once to repeat the current track. The  indicator will appear in the display.
2. Press the **Intro/Repeat button** again to repeat all tracks on the CD. The  indicator will appear in the display.
3. Press the **Intro/Repeat button** again to return to normal play.



CD Intro play

1. Whilst the CD is in stop mode, press the **Intro/Repeat button** once to play the first 9 seconds of all tracks on the CD. The **INTRO indicator** will appear in the display.
2. Press the **Stop button** to interrupt the intro play.

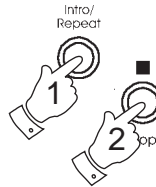

CD random play

1. Whilst the CD is playing, press the **Prog/Random button** to play all tracks on the CD in random order. The **RANDOM indicator** will appear in the display. The tracks are played in random order until all tracks have been played.
2. Press the **Prog/Random button** again to return to normal play. The **RANDOM indicator** will disappear from the display.



Programmed play

By programming the player you can play up to 24 tracks in any desired order.

1. Whilst the CD is in STOP mode, press the **Prog/Random button**. The display will show 'P 01'.
2. Select the first track using the **F.Skip** or **B.Skip buttons**. The track number will flash on the display. Store this track by pressing the **Prog/Random button**.
3. Repeat the above steps until you have completed your program (maximum 24 tracks). Press the **CD Play/Pause** button to commence play of the selected tracks.

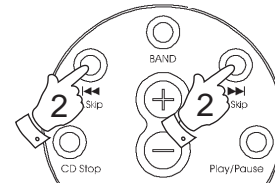
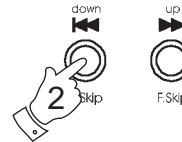

Remote Control

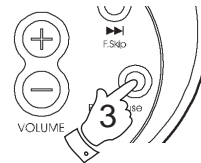

Remote Control

If you need any further advice, please call our Technical Helpline on :-

020 8758 0338 (Mon-Fri)

Download from www.Somanuals.com. All Manuals Search And Download.

Checking and Editing a programme

1. Whilst the CD is in STOP mode, press the **Prog/Random button**. The display will show 'P 01'. Press either the **F.Skip** or **B.Skip buttons**, the display will show the programmed track.
2. The programme can be edited by pressing either the **F.Skip** or **B.Skip buttons** until the desired track is shown. Press the **Prog/Random button** to store the track.

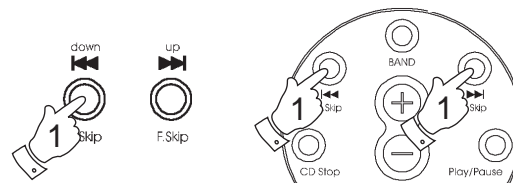
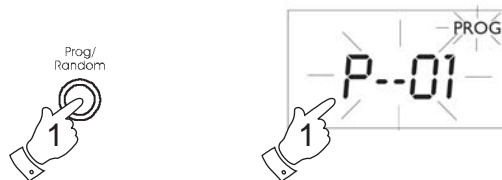

Remote Control

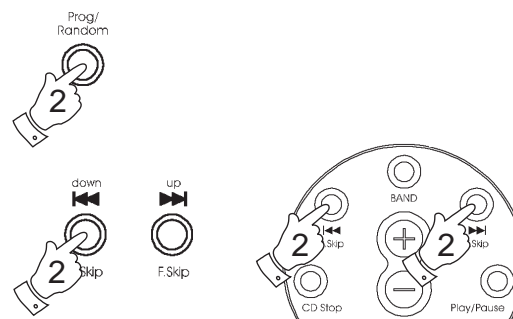

Remote Control

Erasing a programme

This can be done in one of three ways, as detailed below.

1. While programming, press the **Stop button**.
2. Whilst the programme is playing, press the **StandBy button**.
3. Whilst the programme is playing, press the **BAND button** on the CD clock radio or the **BAND button** on the remote control.

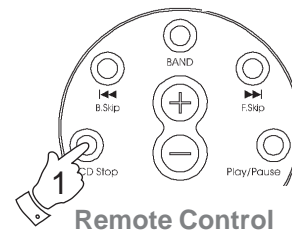

Remote Control

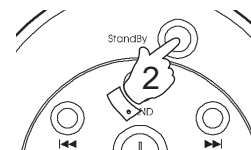

Remote Control

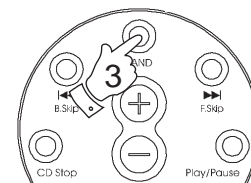

Remote Control

Headphones

1. A **Headphone Socket** (3.5mm) located on the left side of the unit is provided for use with either headphones or an earpiece. Inserting a plug automatically mutes the internal loudspeaker.

If you need any further advice, please call our Technical Helpline on :-

0208758 0338 (Mon-Fri)

Download from www.Somanuals.com. All Manuals Search And Download.

General

Do not allow this unit to be exposed to moisture (e.g. dripping or splashing) or to temperatures exceeding 70 degrees centigrade. It is recommended that the FM band be used wherever possible as better results in terms of quality and freedom from interference will usually be obtained than on the MW band.

Mains supply

The CR9987 will operate from a supply of 230volts, 50Hz \sim AC only. For your convenience this product is supplied with a plug which is fitted with a fuse of the appropriate rating. If the plug supplied is not suitable for your socket outlet, it should be removed by unscrewing the plug top, the terminal screws and removing the cable.

The correct style of plug to suit your household together with a correctly rated fuse should be fitted.

IF IN DOUBT - CONSULT A QUALIFIED ELECTRICIAN

IMPORTANT: DO NOT make any connection to the larger terminal which is marked with the letter E or by the safety earth symbol \perp or coloured Green or Green-and-yellow.

The wires in the mains lead are coloured in accordance with the following codes :-

BLUE - NEUTRAL

BROWN - LIVE

As these colours may not correspond with the coloured markings identifying the terminals in your plug, proceed as follows:-

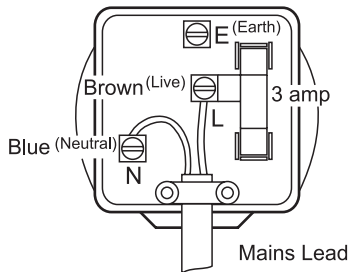

The wire coloured BLUE must be connected to the terminal marked N or coloured BLACK.

The wire coloured BROWN must be connected to the terminal marked L or coloured RED.

Fuse

This apparatus must be protected by a 3A fuse (BS1362) in a 13A plug (BS1363). If another type of plug is used a 5A fuse should be fitted in the plug, adaptor or distribution board.

IF IN DOUBT - CONSULT A QUALIFIED ELECTRICIAN.

Back-up Battery (not necessary for the unit to function)

Slide the battery cover catch in the direction of the arrow. Open the battery cover. Fit 2 x LR6 (AA) size batteries into the compartment. Observe the correct polarity as shown inside the battery compartment. Replace the battery cover.

The time and alarm settings will be retained during a temporary failure of the AC mains supply. The LCD display will not be operational. The display will be extinguished to conserve battery life, but the memory will retain details of the time and alarm time settings.

If your clock radio is not to be used for a prolonged period of time, remove the battery to avoid damage by battery leakage.

(Underside)

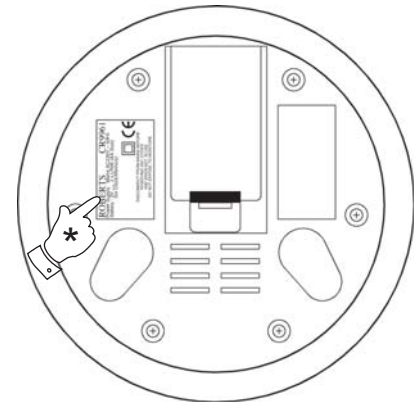

* The name plate is located on the bottom panel.

Specifications

Power Requirements

Mains	230 volts, 50Hz  AC only
Back-up Batteries	2 x LR6 (AA size)
Remote Batteries	2 x LR03 (AAA size)

Frequency Coverage

FM	87.5 - 108MHz
MW	522 - 1620kHz

Circuit Features

Loudspeaker	8 ohms	
Output power	2 x 1 Watt	
Aerial System	FM	Wire Aerial
	MW	Built-in Ferrite Bar aerial

**CLASS 1
LASER PRODUCT**

Warning

CLASS 1 LASER PRODUCT means that the laser's construction makes it inherently safe so that the legally prescribed maximum permissible radiation values can never be exceeded

Caution: Using any equipment or devices other than those described and specified in these operating instructions, or tampering with the unit in any way, can result in dangerous exposure to radiation.

The Company reserves the right to amend the specification without notice.

If you need any further advice, please call our Technical Helpline on :-

02087580338 (Mon-Fri)

Download from www.Somanuals.com. All Manuals Search And Download.

Notes

Guarantee

This instrument is guaranteed for twelve months from the date of delivery to the original owner against failure due to faulty workmanship or component breakdown, subject to the procedure stated below. Should any component or part fail during this guarantee period it will be repaired or replaced free of charge.

The guarantee does not cover:

1. Damage resulting from incorrect use.
2. Consequential damage.
3. Receivers with removed or defaced serial numbers.

Procedure:

Any claim under this guarantee should be made through the dealer from whom the instrument was purchased. It is likely that your Roberts' dealer will be able to attend to any defect quickly and efficiently, but should it be necessary the dealer will return the instrument to the company's service department for attention. In the event that it is not possible to return the instrument to the Roberts' dealer from whom it was purchased, please contact Roberts Radio Technical Services department at the address shown on the rear of this manual before taking further action.

These statements do not affect the statutory rights of a consumer.

If you need any further advice, please call our Technical Helpline on :-

02087580338 (Mon-Fri)

Download from www.somanuals.com. All Manuals Search And Download.

ROBERTS RADIO TECHNICAL SERVICES

97-99 Worton Road
Isleworth Middlesex
TW7 6EG

Technical Helpline:- 020 8758 0338 (*Mon-Fri*)



Free Manuals Download Website

<http://myh66.com>

<http://usermanuals.us>

<http://www.somanuals.com>

<http://www.4manuals.cc>

<http://www.manual-lib.com>

<http://www.404manual.com>

<http://www.luxmanual.com>

<http://aubethermostatmanual.com>

Golf course search by state

<http://golfingnear.com>

Email search by domain

<http://emailbydomain.com>

Auto manuals search

<http://auto.somanuals.com>

TV manuals search

<http://tv.somanuals.com>