

ROBERTS

Sound for Generations

CRD-33

FM RDS/DAB Digital Clock Radio with SD Recording

Gemini 33



DAB

Digital Audio Broadcasting

Please read this manual before use

Contents

Controls	2-5	File playback	27-28
CRD-33 Clock radio features	6	Delete files	29
Using the AC adaptor	7	Alarm mode	30-33
Operation modes	8	Snooze	33
Operating your radio - DAB	9	Buzzer alarm setting.....	33
Selecting a station - DAB	10	Sleep function.....	34
Presetting stations.....	11-12	Nap timer.....	35
Finding new stations - DAB	13	FM Stereo/Mono.....	36
Manual tuning - DAB	13	Software version.....	36
Secondary services - DAB	14	Signal strength display - DAB.....	37
Display modes - DAB	15	System reset	38
Using your radios PausePlus feature	16-17	Setting the clock manually.....	39-40
Dynamic range control (DRC)	18	Auxiliary in socket.....	41
Station order setup - DAB	19-20	Line out socket	41
Operating your radio - search tuning FM.....	21	Headphone socket	42
Manual tuning - FM	22	Backlight for clock and display	43
Display modes - FM.....	23	General.....	44
Using an SD Memory card with your clock radio.....	24	Specifications	45
Recording a radio program - DAB only	24-25	Guarantee	46
SD card format	25-26		
View file space.....	26		

Controls

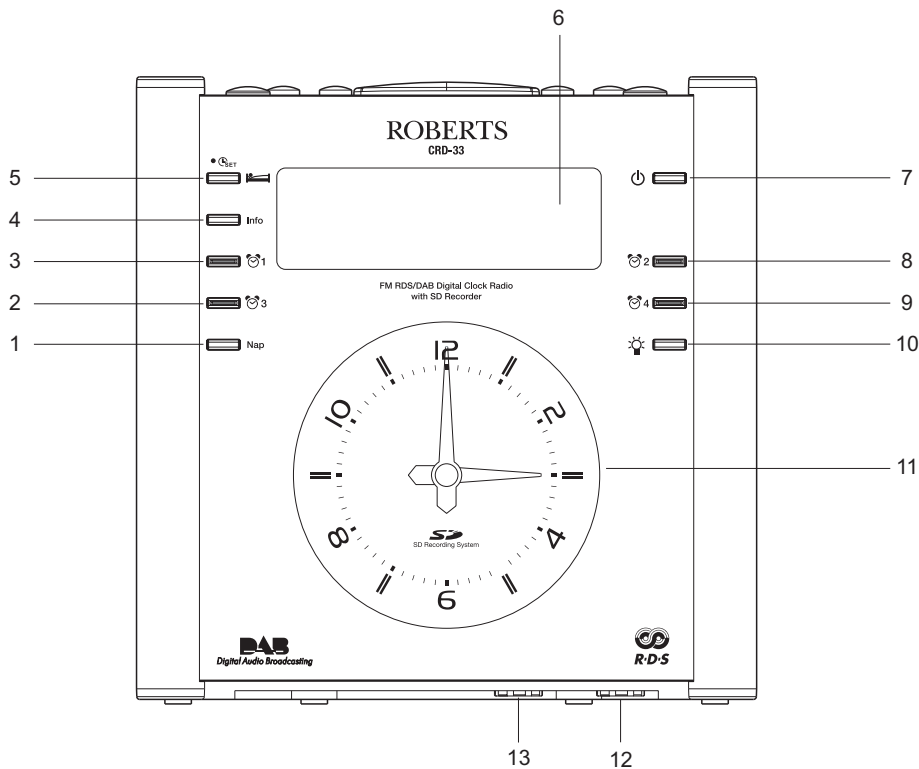

1. Nap timer button
2. Alarm 3 button
3. Alarm 1 button
4. Info button
5. Time Set/Sleep button

6. LCD display
7. Standby button
8. Alarm 2 button
9. Alarm 4 button

10. Backlight button
11. Analogue clock
12. Backlight display level control
13. Alarm level control

Controls (top)

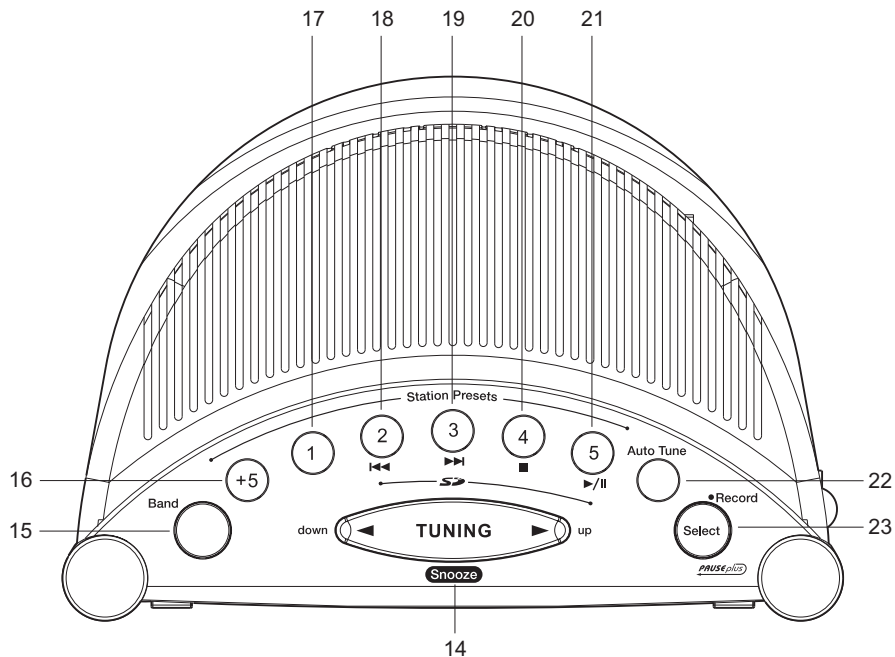

14. Tuning Up / Down / Snooze button

15. Band / Function select button

16. +5 button

17. Preset 1 button

18. Preset 2 / Rewind button

19. Preset 3 / Fastforward button

20. Preset 4 / Stop button

21. Preset 5 / Play / Pause button

22. Auto Tune button

23. Select / Record / PausePlus button

Controls (rear)

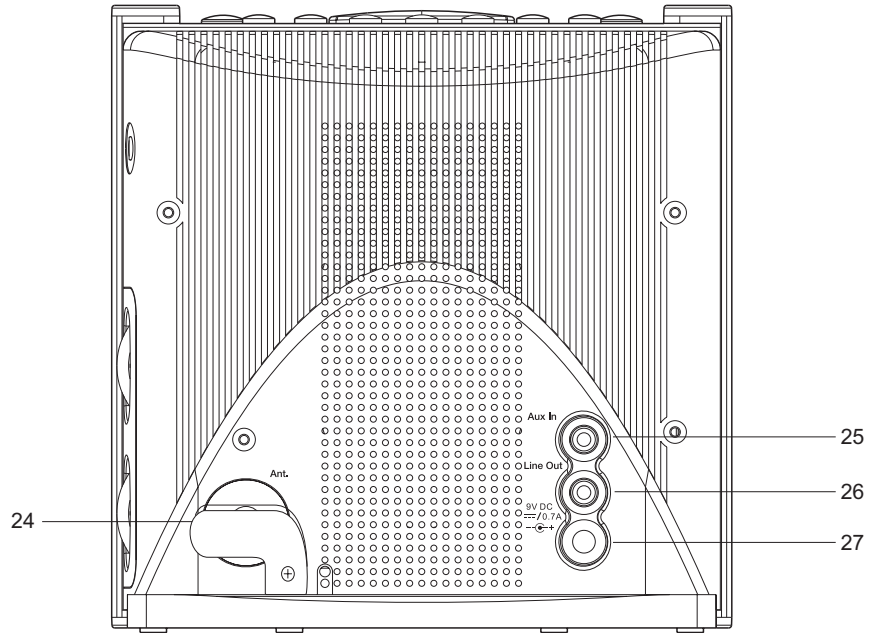

24. FM / DAB wire aerial (behind removable cover plate)

25. Auxiliary in socket

26. Line out socket

27. DC input socket

Controls

Left hand side

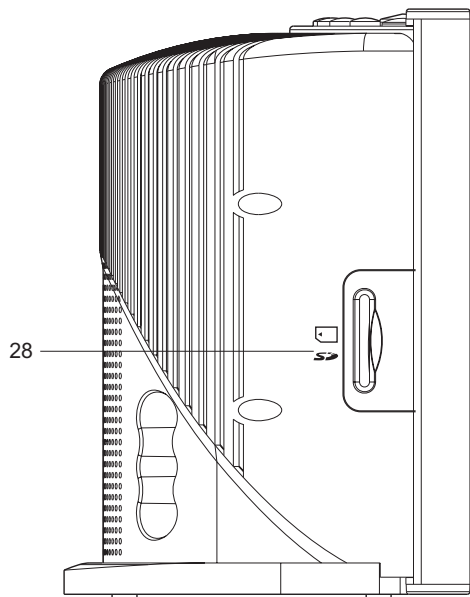

28. SD card slot

Right hand side

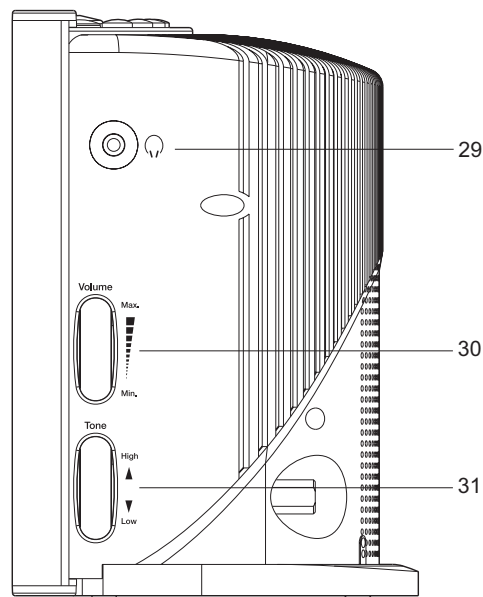

- 29. Headphone socket
- 30. Volume control
- 31. Tone control

CRD-33 clock radio features

The Roberts CRD-33 clock radio provides the following features in an attractive compact unit.

Radio

The CRD-33 can receive DAB, and FM (with RDS) wave bands.

SD slot

The CRD-33 plays MP3 files from an SD card and can also play its own recordings in MP2 format.

One touch instant record

The CRD-33 has a once touch instant record function (recording to SD card).

Auxiliary input

The CRD-33 can be used as an amplifier and loudspeaker system for external MP3 players, mini disc players and similar devices.

Headphone output

A standard 3.5mm headphone socket is provided for private listening.

Line Out socket

A standard 3.5mm Line Out socket is provided for connecting the audio signal to an external amplifier.

Using the AC adaptor

Your clock radio is supplied with a Mains Adaptor.

1. Place your radio on a flat surface.
2. Insert the adaptor plug into the DC socket located on the rear of your radio.
3. Plug the adaptor into a standard 13 amp mains socket outlet.

The AC adaptor should be disconnected from the mains supply and the clock radio when not in use.

- **IMPORTANT:** The mains adaptor is used as the means of connecting the clock radio to the mains supply. The mains socket used for the clock radio must remain accessible during normal use. In order to disconnect the radio from the mains completely, the mains adaptor should be removed from the mains socket outlet completely.

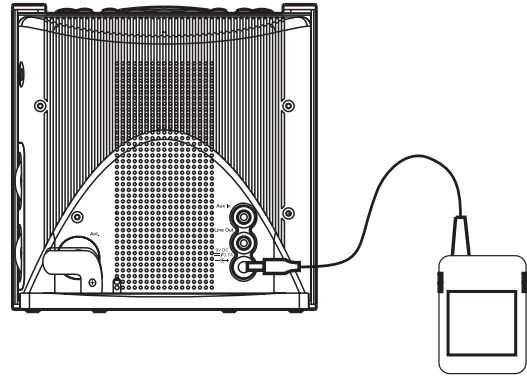

Operation modes

Your radio has 4 operation modes, DAB, FM, Playlist mode and Auxiliary input.

1. Press the **Band button** to change the operation mode between DAB, FM, Playlist and Auxiliary input mode.
- DAB mode is used for listening to Digital Radio broadcasts and for recording programmes to a memory card.
 - FM mode is used for listening to FM radio broadcasts.
 - Playlist mode is used to play back digitally recorded programmes and for listening to MP2 and MP3 files.
 - Auxiliary input mode allows the CRD-33 clock radio to be used as an amplifier and loudspeaker system for external MP3 players, mini disc players and similar devices.



BBC RADIO 7
Jane Jones Pres

88.10MHz FM

Play track
*DAB000.MP2 *

AUX IN

Operating your radio - DAB

1. Place the wire antenna so that it is as straight as possible extending either above or below the radio. The FM/DAB wire antenna is beneath the removable cover plate.
2. Insert the adaptor plug into the DC socket located on the rear of your radio.
3. Plug the adaptor into a standard 13 amp mains socket outlet.
4. The clock radio will then display "Clock not Set...". The clock hands will then move to 12:00. The radio will scan for DAB signals and if a DAB signal is found it will then show the current time and date in the display. The clock hands will then move to show the correct time.
5. If no signal is received the radio will continue to display "Clock not Set". Try repositioning the antenna. Press the **On/Standby button** and the radio will rescan. If a signal is found the radio will then tune to a station and set the clock as soon as the time information is received. If necessary reposition again and press the **Auto tune button** to rescan until stations are found.

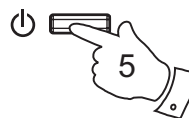
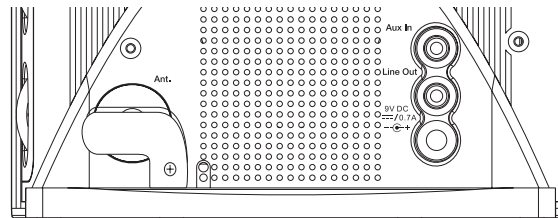

Clock not set.

12:38:08
08-06-2007

Selecting a station - DAB

1. Place the wire antenna so that it is as straight as possible extending either above or below the radio.
2. Press the **Standby button** to switch on your radio.
3. During the clock setting the radio carried out a quick scan of the UK DAB channels. If this was not successful or if you have moved the radio to a different part of the country press the **Auto tune button**. During Autotune, the display will show "Scanning" and as each group of stations is detected the station count will be updated. The top line of the display shows a bargraph indicating progress of the Autotune. When the Autotune is completed the first station (in numeric-alpha order 0...9...A....Z) will be selected.
4. The top line of the display shows the name of the station currently selected. Press the **Tuning up/down buttons** to scroll through the list of available stations. Stop pressing the Tuning up or down buttons when you find the station that you wish to hear.
5. Press and release the **Select button** to select the station. The display may show "Now tuning" while your radio finds the new station.
6. Adjust the **Volume** and **Tone controls** to the required setting.

Note: If after selecting a station the display shows "Not Available" it may be necessary to relocate your radio to a position giving better reception.

Auto Tune

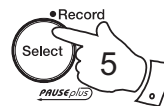
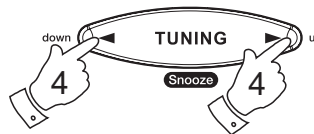

Now tuning...

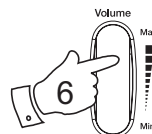

1Xtra
Call us on 0870-

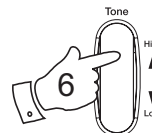

Presetting stations - DAB and FM

There are 10 memory presets on each radio band, DAB and FM.

1. Press the **Standby button** to switch on the radio.
2. Tune to the required station as previously described.
3. Press and hold down the required **Preset button** until the display shows for example, "Preset 1 saved". The station will be saved under the chosen preset button. Repeat this procedure for the remaining presets.
4. Presets 6 to 10 are obtained by pressing and holding +5 button together with the Preset button 1 to 5. e.g. preset 7 can be set by pressing and holding +5 button together with Preset button 2 until the display shows Preset 7 saved.
5. Stations stored in preset memories may be overwritten by following the above procedure.

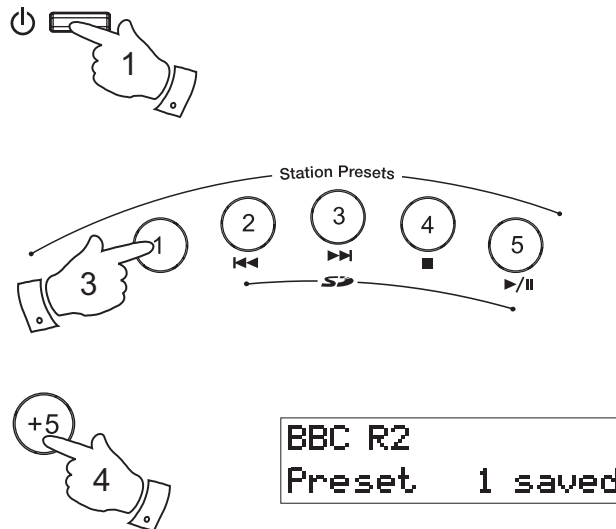

Recalling a preset station - DAB and FM

1. Press the **Standby button** to switch on your radio.
2. Select the required waveband by pressing the **Band button**.
3. Momentarily press the required **Preset button**, your radio will tune to the station stored in preset memory.
4. Presets 6 to 10 are obtained by pressing and holding +5 button and preset button 1 to 5. e.g. preset 7 can be recalled by pressing and holding +5 button followed by pressing and releasing Preset button 2.

Note: If you have not previously stored a preset station and the preset buttons are pressed "Empty preset" will be displayed.

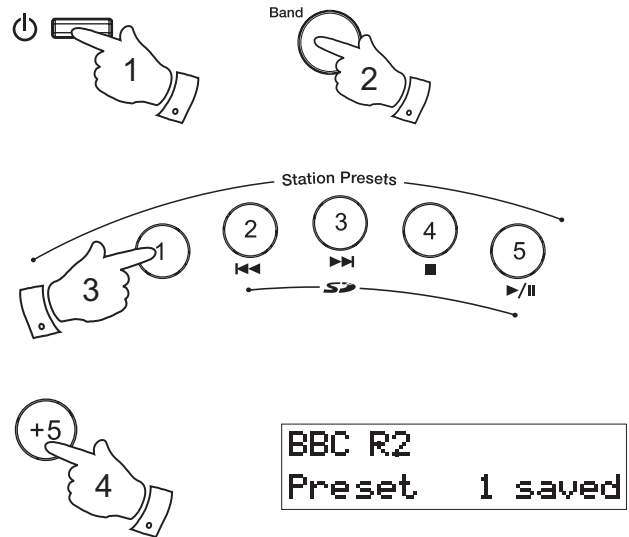

Finding new stations - DAB

As time passes new stations may become available. To find new stations proceed as follows:-

1. Press and release the **Auto Tune button**, the display will show "Quick scan". Your radio will perform a scan of the UK DAB frequencies. As new stations are found the station counter on the right-hand side of the display will increase and stations will be added to the list.
2. To carry out a full scan of the entire DAB Band III frequencies press and hold down the **Auto Tune button** for more than 2 seconds and then release. The display will show "Full scan". As new stations are found the station counter on the right-hand side of the display will increase and stations will be added to the list.



Autotune
Quick scan

Now tuning...



Autotune
Full scan...

Manual tuning - DAB

Manual tuning allows you to tune directly to the various Band III DAB channels. UK DAB stations are currently located in the range 11B to 12D.

1. Press and hold down the **Info button**, "Station order" will appear on the display. Then press the **Tuning Up/Down button** until the display shows "Manual tune". Press and release the **Select button**.
2. Press the **Tuning Up/Down button** to select the required DAB channel.
3. Press and release the **Select button** to select the channel. Any new stations that are found are automatically added to the stored list of stations.
4. Press and release the **Select button** to return to normal tuning mode.

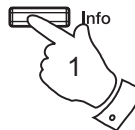

♦ ♦ or SELECT
♦ Station order ♦

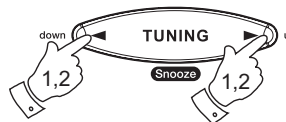

♦ ♦ or SELECT
♦ Manual tune ♦

11C 220.35 MHz



■■■■■
11C EMAP SV

Secondary services - DAB

1. Certain radio stations have one or more secondary services associated with them. If a station has a secondary service associated with it the display will show ">>" next to the station name on the station list. The secondary service will then appear immediately after the primary service when you press the **Tuning Up/Down button**.
2. Press and release the **Select button** to select the station.

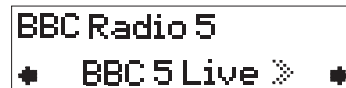
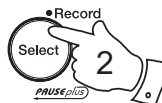
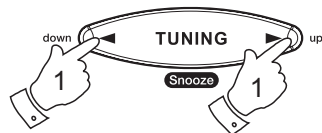

Display modes - DAB

Your radio has seven display modes for DAB listening:-

1. Press the **Info button** to cycle through the various modes.

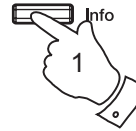

- | | |
|----------------------------|---|
| a. Scrolling text | Displays scrolling text messages such as artist/track name, phone in number, etc. |
| b. Programme type | Displays type of station being listened to e.g. Pop, Classic, News, etc. |
| c. Multiplex name | Displays name of multiplex to which current station belongs. |
| d. Time and date | Displays current time and date. |
| e. Channel and frequency | Displays current channel and frequency. |
| f. Audio type and bit rate | Displays audio type and bit rate. |
| g. Signal strength | Displays signal strength for station being listened to. |

- | | |
|---|--|
| a | |
| b | |
| c | |
| d | |
| e | |
| f | |
| g | |

Using your radio's PausePlus feature - DAB

How many times has your favourite radio station been interrupted by that phone call from a double glazing firm or someone selling that must have item? Sound familiar? Now with a single press of the **Select/Record/PausePlus** button you can put your favourite station on hold while you answer that important call. After the call or other important task is finished simply press the **Select/Record/PausePlus** button to return to your favourite station exactly where you left off so that you never miss a single word.

Radio stations can effectively be put on hold between 5 and 15 minutes depending on the station you are listening to.

Note the PAUSEplus feature only operates on the DAB waveband.

1. To place your radio in PAUSEplus mode simply press and release the **Select/Record/PausePlus** button, the sound from the loudspeaker will be muted. The display will show the "Pause symbol" and the time that you are delayed by.
2. To return to the radio station that you were listening to simply press and release the **Select/Record/PausePlus** button and your radio will continue playing from where you left off.
3. To return to real time press and release the **Preset 4/Stop** button, the display will return to normal radio display.



BBC 7 11 0m 12s
Just a Minute...



BBC 7 1m 12s
Just a Minute...

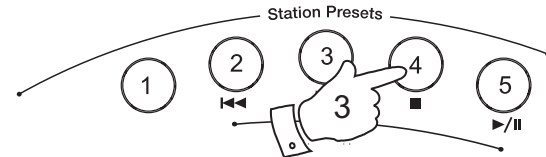

BBC 7
Just a Minute...

PausePlus Rewind and Fastforward - DAB

1. Repeatedly press the **Fastforward or Rewind buttons** to scroll to the item you wish to listen to. Each press moves forwards or backwards 30 seconds.
2. When using your radio's **PAUSEplus** feature the top line of display automatically switches to show the time that you are delayed.

BBC 7 II 0m 12s
Just a Minute...

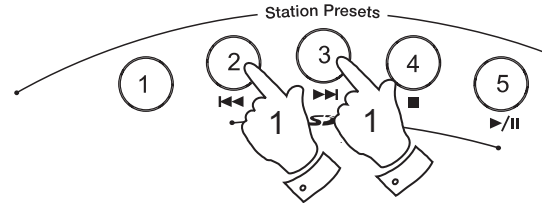

Dynamic Range Control (DRC) settings - DAB

The DRC facility can make quieter sounds easier to hear when your radio is used in a noisy environment.

1. Press the **Standby button** to switch on your clock radio.
2. Press and hold in the **Info button** until display shows "Station order."
3. Press the **Tuning Up/Down button** until the display shows "DRC value".
4. Press and release the **Select button** to enter adjustment mode.
5. Press the **Tuning Up/Down button** to select required DRC setting (default is 0) .
 - DRC 0 DRC is switched off. Broadcast DRC will be ignored.
 - DRC 1/2 DRC level is set to 1/2 that sent by broadcaster.
 - DRC 1 DRC is set as sent by broadcaster.
6. Press and release the **Select button** to confirm the setting. The display will return to radio mode.

Note: Not all DAB broadcasts are able to use the DRC function. If the broadcast does not support DRC, then the DRC setting in the radio will

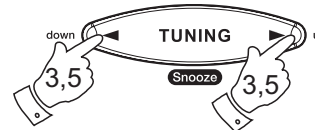
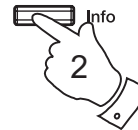
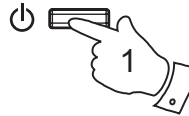

◆ ◆ or SELECT
◆ Station order ◆

◆ ◆ or SELECT
◆ DRC value ◆

DRC0
◆ DRC0 ◆

DRC0
◆ DRC 1/2 ◆

DRC0
◆ DRC 1 ◆

Station order setup - DAB

Your radio has 3 station order settings from which you can choose. The station order settings are, favourite station, alphanumeric and active station.

Note: Your radio default station order is alphanumeric.

1. Press and hold in the **Info button** until "Station order" appears on the display. Press and release the **Select button**.
2. Press the **Tuning Up/Down button** to choose between favourite station, alphanumeric and active station.

Favourite stations

When this setting is switched on, after a period of time the most listened to stations will move to the top of the station list and will be marked with the heart symbol ♥.

Alphanumeric

Press the **Tuning Up/Down button** until "Alphanumeric" appears on the display. Your radio will now select stations in alphanumeric order A....Z 0....9.

Active station

Press the **Tuning Up/Down button** until "Active station" appears on the display. The display will show only those that a signal can be found.

3. Press and release the **Select button** to select the station order setting required.

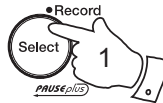
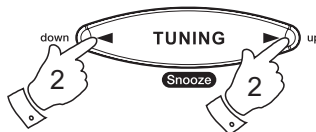
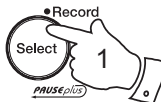
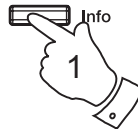

Prune stations - DAB

Some DAB services may stop broadcasting or you may not be able to receive a station. Prune stations will delete the DAB stations from your station list that can no longer be received.

1. Press and hold in the **Info button** until "Station order" appears on the display. Press and release the **Select button**.
2. Press the **Tuning Up/Down button** until "Prune stations" appears on the display. Press and release the **Select button** to select.



◆ ◆ or SELECT
◆ Station order ◆



◆ Prune station ◆

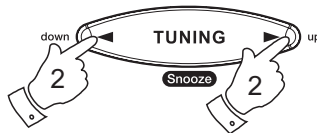

Operating your radio - Search tuning FM

1. Place the wire antenna so that it is as straight as possible extending either above or below the radio.
2. Press the **Standby button** to switch on your radio.
3. Press the **Band button** to select the FM band.
4. Press and immediately release the **Auto tune button**, your radio will scan in an upwards direction (low frequency to high frequency) and stop automatically when it finds a station of sufficient strength.
5. After a few seconds the display will update. The display will show the frequency of the signal found. If the signal is strong enough and there is RDS data present then the radio will display the station name.
6. To find other stations, press and release the **Auto tune button** as before.
7. To scan the FM band in a downwards direction (high frequency to low frequency) press and hold down the **Auto tune button** for 0.5 seconds and then release.
8. When the waveband end is reached your radio will recommence tuning from the opposite waveband end.
9. Adjust the **Volume** and **Tone controls** to the required setting.
10. To switch off your radio press the **Standby button**.

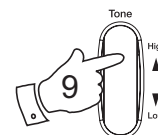
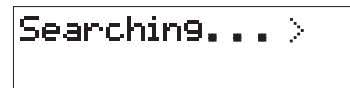
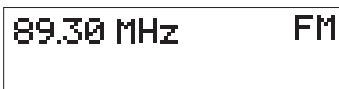
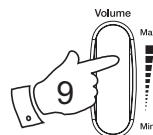
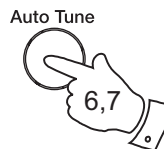
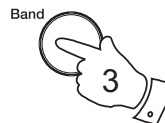
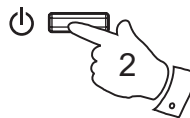

Manual tuning - FM

1. Press the **Standby button** to switch on your radio.
2. Press the **Band button** to select the FM band. Fully extend the wire antenna for FM reception.
3. Press the **Tuning Up/Down button** to tune to a station. The frequency will change in steps of 50 kHz on FM.
4. When the waveband end is reached the radio will recommence tuning from the opposite waveband end.
5. Set the **Volume** and **Tone controls** to the desired settings.
6. To switch off your radio press the **Standby button**.

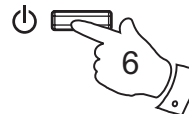
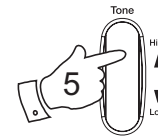
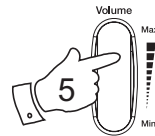
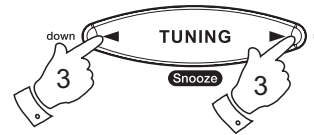
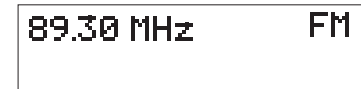
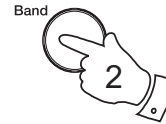
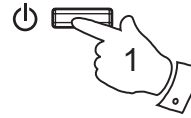

Display modes - FM

Your radio has four display modes for FM listening:-

The Radio Data System (RDS) is a system in which inaudible digital information is transmitted in addition to the normal FM radio programme. RDS offers several useful features. The following are available on your radio:-

1. Press the **Info button** to cycle through the various modes.



a. Frequency Displays the frequency of the station being listened to.

a 89.30 MHz St.FM
89.30 MHz FM

b. Scrolling text Displays scrolling text messages such as artist/track name, phone in number, etc.

b 89.30 MHz St.FM
Just a Minute...

c. Programme Type Displays type of station being listened to e.g. Pop, Classic, News, etc.

c 89.30 MHz St.FM
Easy listening

d. Time and date Displays current time and date.

d 89.30 MHz St.FM
19:17 08-02-2007

Using an SD memory card with your radio

An SD card can be used in your radio for recording, playing back previously recorded radio programs, or playing back MP2 and MP3 files transferred from a PC.

Depending on the radio station a 512MB SD card will give typically 8-16 hours of recording time. If you are using a new SD card ensure that it is formatted correctly (see page 25).

Many different brands and capacities of SD card are available. Your CRD-33 has been tested with a wide range of cards up to 2 GB. However, there are many different card variants available and not all cards can be guaranteed to work in the CRD-33. The CRD-33 **will not work** with cards greater than 2GB capacity or cards which use the High Capacity Secure Digital (HCSD) standard.

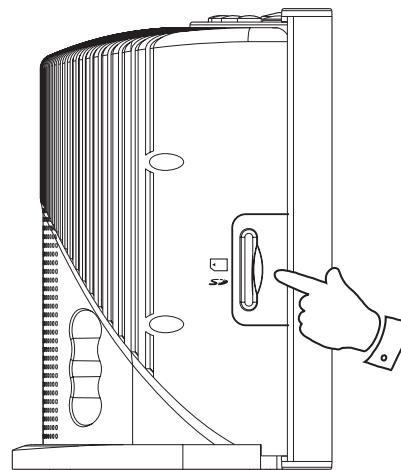

Inserting and removing a card

To insert an SD card into your clock radio, push the card label side forward and gold contacts first into the SD card slot on left hand side of the clock radio until it clicks.

To remove the card push the card in slightly and it will pop out allowing removal.

Note: The SD card should not be removed during a recording as damage or corruption of files on the card may occur.

Recording a Radio program (DAB only)

1. Tune to the DAB station you want to record.
2. Press and hold in the **Select/Record button** to start recording. The record icon ● and "stop recording before power off" will show in the display.

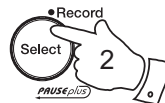

- Press the **Preset 4/Stop button** to stop recording. The recording will be saved on your SD card.

If your radio is not recording correctly check the following:

- The card is the correct format (reformat as described below).
- The card has enough recording space available. (page 26)
- The card has not become corrupted (possibly by removing the card during recording). Reformat the card if necessary.

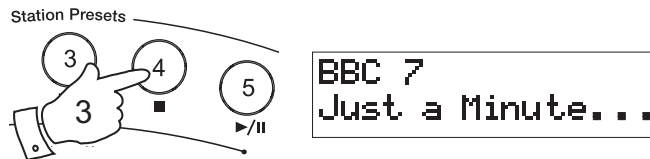

SD Card Format

Formatting your SD card erases any previously recorded files. It also allows an SD card formatted on another device to be re-formatted for use on your radio. The SD card can be formatted in DAB, FM or Playlist mode.

- Insert an SD card into the slot.
- In DAB mode press and hold in the **Info button** and press the **Tuning Up/Down button** until "Memory Card" is shown on display.
If in FM or Playlist mode simply press and hold the **Info button** and "Memory Card" will show on display.

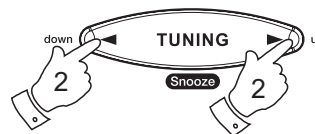
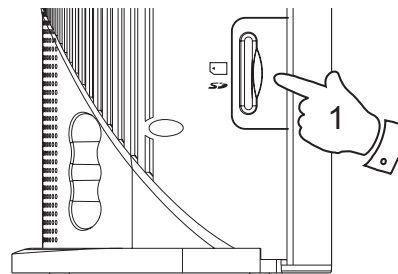

3. Press and release the **Select button**.
 4. Press the **Tuning Up/Down button** until "Format" appears on the lower line display.
 5. Press and release the **Select button** "Confirm format / No" will appear on the display. To format press the **Tuning Up/Down button** until "Yes" appears on the display.
 6. Press and release the **Select button** and "Formatting / Please wait" will appear on the display. Your SD card will be formatted and the display will show "Formatted".
- If you do not wish to format your SD card press the **Tuning Up/Down button** until "No" appears on the display, then press **Select button**.

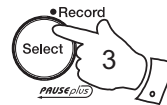

Memory Card
 #Format #

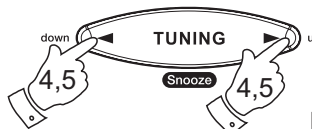

Confirm format
 #Yes #



Formatting
 Formatted

To view space on an SD card

1. In DAB mode press and hold the **Info button** until "Station order" is displayed. Then press the **Tuning Up/Down button** until "Memory Card" is shown on display.

If in FM or Playlist mode simply press and hold the **Info button** and "Memory Card" will show on display.

2. Press and release the **Select button**.
3. Press the **Tuning Up/Down button** until "Remaining... / Free space" appears on the display.

Note: 1MB of space will hold approximately 1-2 minutes of recording.



Confirm format
 #No #

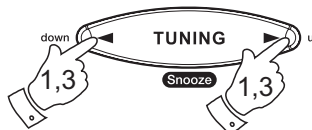

Remaining 23 MB
 #Free space #

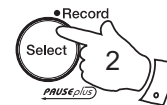

File playback

The playlist mode displays the files on the current memory card. The display will show the current file details.

1. Ensure your SD card is inserted correctly.
2. Press the **Band button** until the Play list mode is selected. "Finding tracks" will be displayed then the current recording or track on your SD card will show on the display.
3. You can scroll through the list using the **Tuning Up/Down button** or the **Fastforward/Rewind buttons**.

To play files

1. Press the **Play/Pause button**.
2. Your playlist recordings will be played in list order from the first selected file.
3. To pause playback press the **Play/pause button**. To resume playback press the **Play/pause button** again.

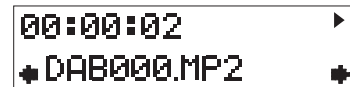
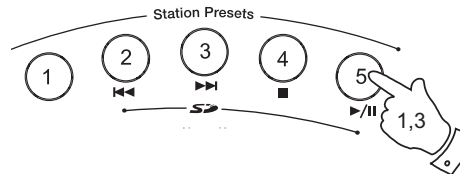
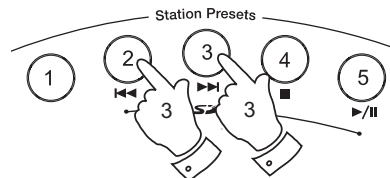
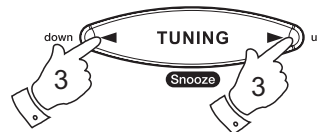
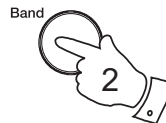

Fastforward files

1. Press the **FastForward button** to skip to the next track.
2. Whilst a track is playing press **Tuning Up/Down button** until the desired part of the track is reached.

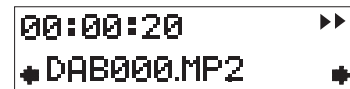
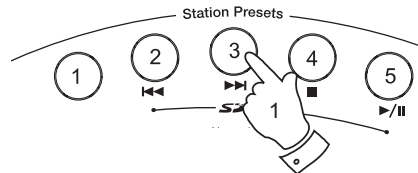

Rewind files

1. Press the **Rewind button** to skip to the previous track.
2. Whilst a track is playing press the **Tuning Up/Down button** until the desired part of the track is reached.

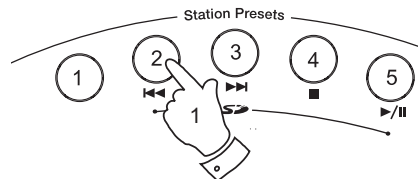

Stop playing files

1. Press the **Stop button** and the track will stop playing and return to the playlist.

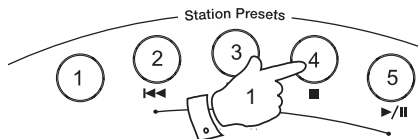

Delete files

- In DAB mode press and hold in the **Info button** and press the **Tuning Up/Down button** until "Memory Card" is shown on display.
If in FM or Playlist mode simply press and hold the **Info button** and "Memory Card" will show on the display.
- Press and release the **Select button**.
- Press the **Tuning Up/Down button** until "Delete track" appears on the display.
- Press and release the **Select button** the display "will show finding tracks" then will return to the list of tracks.
- Either press the **Tuning Up/Down button** or press the **Fastforward or Rewind buttons** to select a track for deletion.
- Press and release the **Select button** the display will show "Confirm delete".
- Press the **Tuning Up/Down button** to select "Yes" on the display.
- Press and release the **Select button** and your file will be deleted from your track list. The radio will return to your track list.

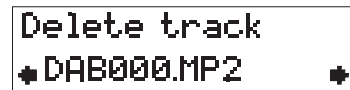
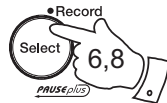
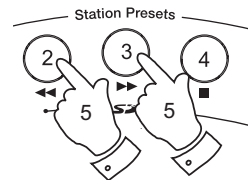
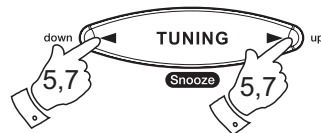
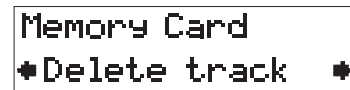
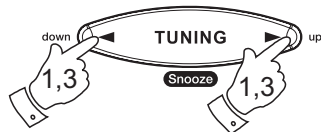

Alarm mode

Your clock radio has four separate alarms which can be set to wake you to radio (DAB, FM), SD card playback, Aux in or beep type alarm. Each alarm can be set to sound once, daily, on weekdays or at weekends. The alarms can be set whether the clock radio is on or in standby mode. In the event of a power interruption your clock radio has a built in memory chip that will maintain all your alarm settings for when the power is restored.

Note: If no buttons are pressed for 5 seconds, the radio will exit the alarm setup.

Note: Alarm times are set using the 24Hr format e.g. 2:30PM is entered as 14:30.

Setting an alarm

1. Press and hold the desired **Alarm button (1 - 4)**.
2. Repeatedly press and release the **Tuning Up/Down buttons** to choose the desired hour for the alarm and then press the **Select button** to confirm the hour setting.
3. Repeatedly press and release the **Tuning Up/Down buttons** to choose the desired minute for the alarm and then press the **Select button** to confirm the minute setting.
4. Repeatedly press and release the **Tuning Up/Down buttons** to choose the desired source for the alarm (DAB, FM, SD card playback, Aux In and Buzzer) and then press the **Select button** to confirm the audio setting.



Alarm 1
Time ♦07♦:00

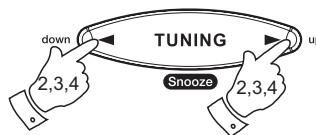

Alarm 1
Time 07:♦30♦

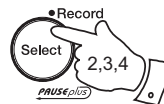

Alarm 1
♦ Buzzer ♦

5. Your alarm can be set to sound once, daily, weekdays and weekends.

- Once - Will sound at one time only.
- Daily - Will sound every day.
- Weekdays - Will sound only on weekdays.
- Weekends - Will sound only on weekends.

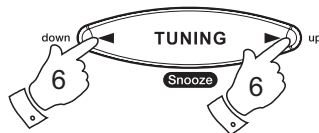

6. Repeatedly press and release the **Tuning Up/Down buttons** to choose the day option and then press and release the **Select button** to confirm the setting.

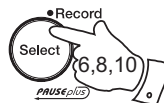

- If setting alarms to daily, weekdays or weekends proceed to point 14.

7. If selecting the alarm to once you will need to set the year, month and day options as described below.

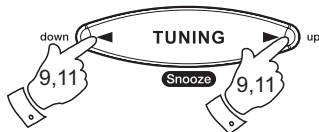

8. Press the **Select button** to enter the alarm year option.

9. Press the **Tuning Up/Down button** to select the correct year.

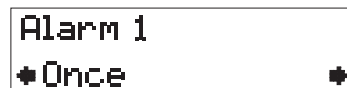

10. Press the **Select button** to enter the alarm month option.

11. Press the **Tuning Up/Down button** to select the correct month.

12. Press the **Select button** to enter the alarm day option.

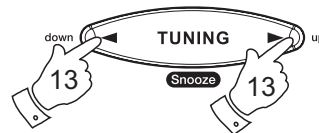

13. Press the **Tuning Up/Down button** to select the correct day.

14. The alarm has now been set and the radio will revert to the previous time or radio display.

Note: When the alarm is set to wake by radio, the last used station will be switched on at the alarm time.

When the alarm activates, if the buzzer alarm is used, the volume will start from minimum and increase in level every few seconds. The alarm will sound for 60 minutes unless cancelled.

The maximum volume of the buzzer alarm is set using the rotary control on the underside of the radio (see page 33).

View the alarm time

1. To view the current setting for one of the alarms repeatedly press and release the relevant **Alarm button**.
2. Each press will show in sequence the alarm time, audio source and day setting.

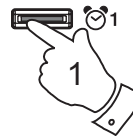

```
Alarm 1
Alarm On  07:30
```

```
Alarm 1
* Buzzer *
```

```
Alarm 1
* Weekdays *
```

To cancel the alarm

1. Whilst an alarm is sounding it can be cancelled for 24 hours by pressing the **Standby button**. The alarm will then be rescheduled as needed according to its settings.

Note: Pressing the **Standby button** once during a radio alarm cancels the alarm but allows the radio to continue playing. Pressing the Standby button a second time will put the radio back into standby mode.

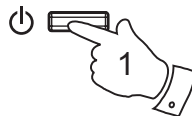

Snooze

1. When the alarm sounds, pressing the **Snooze button** will silence the alarm for five minutes.

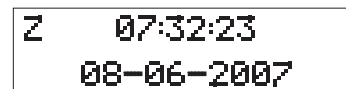
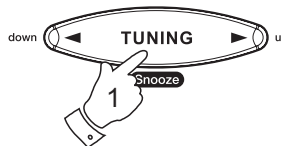

Buzzer alarm setting

1. Turn the **buzzer volume wheel** on the underside of the radio anti-clockwise to lower the buzzer volume. Turn the wheel clockwise to increase the buzzer volume.

Note: When the buzzer sounds, it always starts at a low level and then increases gradually in volume. If you set the volume too low, you may not hear the buzzer sounding.

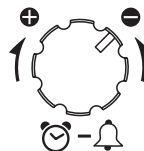

Sleep function

Your clock radio can be set to turn off after a preset time has elapsed. The sleep setting can be adjusted between 15 and 120 minutes.

1. To set the desired sleep time, press the **Sleep button** to enter the sleep setup.
2. Repeatedly press the **Sleep button** to adjust sleep countdown time ranging from 15, 30, 60 90 ,120 and Off. Then press **Select button** to confirm the setting.
3. During countdown period, press **Sleep button** to view countdown time left.
4. Your radio will switch off after the preset sleep time has elapsed.
5. To cancel the sleep function before the preset time has elapsed, either press the **Standby button** to turn the radio off or use the **Sleep button** to show the "Off" option then press **Select button** to confirm.

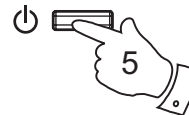
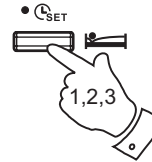

Nap timer

The Nap timer facility allows you to set the radio to wake you after a pre-determined interval (up to 1 hours) without needing to set the alarms.

1. Press and hold the **Nap button**, the current nap time will flash.
2. Repeatedly press and release **Tuning Up or Down buttons** to choose the required Nap time in minutes - 10>20>30>40>50>60>off.
3. When the desired interval is displayed, immediately press and release the **Select button**. The display will show **N** to indicate the nap timer is active.
4. When the selected Nap timer has elapsed, the radio buzzer will sound. To cancel the buzzer press the **Standby button**.

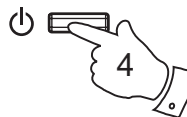
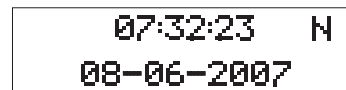
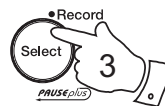
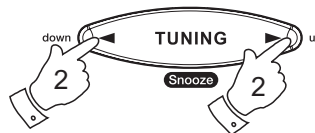

FM Stereo/Mono

1. If a station being received is weak some hiss may be audible. To reduce the hiss press and release in the **Select button** until the display shows "Mono" your radio will switch to mono mode.
2. To return to stereo mode press and release the **Select button** until the display shows "Auto", your radio will switch to stereo mode.



89.30 MHz	FM
Mono	

89.30 MHz	FM
Auto	

Software version

The software display cannot be altered and is just for your reference.

1. To view which software version your radio has press and hold in the **Info button** until "Station order" appears on the display.
2. Press the **Tuning Up/Down button** until the software version shows on the display.

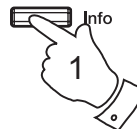

• U.135.5.2	
• Sw Version	•

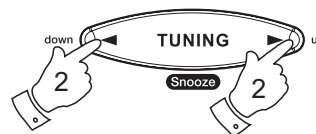

Signal strength display - DAB

1. Press and release the **Info button** until the lower line of the display shows the signal strength.
2. Position your radio and carefully angle the telescopic aerial for best reception using the signal strength display as a guide. Move your radio around and position to give maximum number of black rectangles on signal strength display. The clear unfilled rectangle indicates minimum signal level required for satisfactory reception.

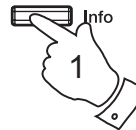

System reset

If your radio fails to operate correctly, or some digits on the display are missing or incomplete carry out the following procedure.

1. Switch on your radio.
2. Press and hold in the **Info button** until "Station order" appears on the display.
3. Press the **Tuning Up/Down button** until the display shows "Factory reset".
4. Press in and release the **Select button**, the display will show "Press SELECT to confirm reset . . .".
5. Press the **Select button** to confirm. A full reset will be performed and all presets and station lists will be erased. A quick scan of UK DAB band III frequencies will be carried out. The clock will be set when the radio receives time information from the DAB radio station.

In case of malfunction due to electrostatic discharge, reset the product (reconnection of power source may be required) to resume normal operation.

If a problem persists our technical staff would be pleased to offer any assistance on operating the radio. Our technical helpline number is 020 8758 0338.

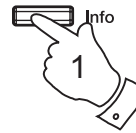

◆ ◆ or SELECT
◆ Station order ◆

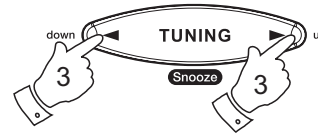

◆ ◆ or SELECT
◆ Factory reset ◆

Press SELECT to
confirm reset...

Autotune
Quick scan

Setting the clock manually

If you are unable to receive DAB broadcasts, the clock may be set manually using the following procedure. Note that the radio may be on or in standby mode when setting the time manually.

1. Press and hold the **Time Set/Sleep button**. "< > or SELECT" will appear on the display with the time setting display.
2. Repeatedly press and release the **Tuning Up/Down buttons** to choose the desired hour and then press and release the **Select button** to confirm the hour setting.
3. Repeatedly press and release the **Tuning Up/Down buttons** to choose the desired minute and then press and release the **Select button** to confirm the minute setting.
4. Repeatedly press and release the **Tuning Up/Down buttons** to choose the desired year and then press and release the **Select button** to confirm the year setting.

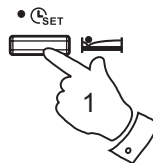

♦ ♦ or SELECT
Time ♦06♦:30

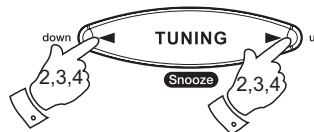

♦ ♦ or SELECT
Time 06:♦30♦

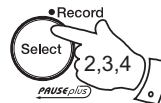

♦ ♦ or SELECT
Year ♦2007♦

5. Repeatedly press and release the **Tuning Up/Down buttons** to choose the desired month and then press and release the **Select button** to confirm the month setting.
6. Repeatedly press and release the **Tuning Up/Down buttons** to choose the desired day and then press and release the **Select button** to confirm the day setting.
7. The clock hands should then set to the selected time, and the digital display will show the correct time and date whenever the radio is in standby mode.

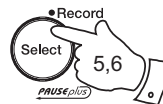
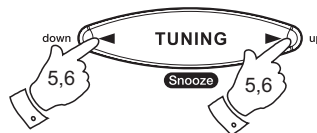

Auxiliary in socket

1. Connect a stereo or mono audio source (ie CD player, iPod, MP3 player) to the **Auxiliary in socket**.
2. Press the **Band button** to select AUX band. "AUX IN" will show on the display.
3. Adjust the **Volume control** for comfortable listening.

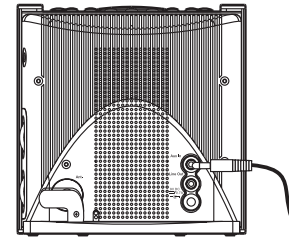
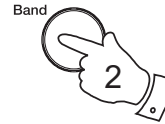

Line out socket

A 3.5mm **Line out socket** located on the left hand end of your radio is provided for connecting the audio signal to an external amplifier. Inserting a line out audio cable will not mute the internal loudspeaker. Set the volume control to the minimum if desired.

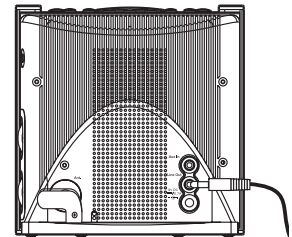
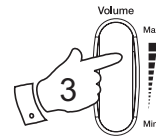

Headphone socket

A 3.5mm **Headphone socket** located on the right hand side of your radio is provided for use with either headphones or an earpiece. Inserting a plug automatically mutes the internal loudspeaker.

IMPORTANT: Excessive sound pressure from earphones and headphones can cause hearing loss.

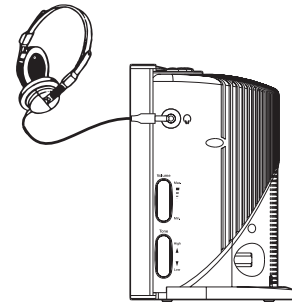

Backlight for clock and display

When you first plug it in your clock radio sets the clock and display backlight to maximum brightness. The backlight button can be used to switch between this and a lower level of illumination which is set using the small adjustment wheel on the underside of the radio.

1. Press and release the **backlight button** to select the alternate setting.
2. Turn the brightness wheel on the underside of the clock radio anti-clockwise to lower the brightness. Turn the wheel clockwise to increase the brightness.
3. Press and release the **backlight button** again to re-select the maximum brightness level if needed.

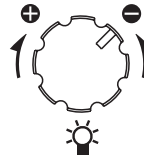
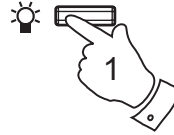

General

Do not allow this radio to be exposed to water, steam or sand. Do not leave your radio where excessive heat could cause damage such as in a parked car where the heat from the sun can build up even though the outside temperature may not seem too high.



The name plate is located underneath your clock radio.

- Your clock radio should not be exposed to dripping or splashing and that no objects filled with liquids, such as vases, shall be placed on the clock radio.
- It is recommended to operate the product such that there is a minimum distance (10cm recommended) to adjacent objects in order to ensure good ventilation.
- The ventilation of the product should not be restricted by covering it or its ventilation openings with items such as newspapers, tablecloths, curtains etc.
- No naked flame sources such as lighted candles should be placed on the product.
- It is recommended to avoid using or storing the product at extremes of temperature. Avoid leaving the unit in cars, on window sills, in direct sunlight etc.

Specifications

Power Requirements

AC adaptor AC 230 volts, 50Hz  only

Frequency Coverage

DAB 174.928 - 239.200MHz

FM 87.50 - 108 MHz

Circuit features

Loudspeaker 10 x 7.5cm elliptical

Output Power 800 mW

Headphone socket 3.5mm dia

Aux in socket 3.5mm dia

Line out 3.5mm dia

Aerial System

DAB and FM Wire antenna

The Company reserves the right to amend the specification without notice

Guarantee

This instrument is guaranteed for twelve months from the date of delivery to the original owner against failure due to faulty workmanship or component breakdown, subject to the procedure stated below. Should any component or part fail during this guarantee period it will be repaired or replaced free of charge.

The guarantee does not cover:

1. Damage resulting from incorrect use.
2. Consequential damage.
3. Receivers with removed or defaced serial numbers.

N.B. Damaged or broken telescopic aerials will not be replaced under guarantee.

Procedure:

Any claim under this guarantee should be made through the dealer from whom the instrument was purchased. It is likely that your Roberts' dealer will be able to attend to any defect quickly and efficiently but should it be necessary the dealer will return the instrument to the Company's service department for attention. In the event that it is not possible to return the instrument to the Roberts' dealer from whom it was purchased, please contact Roberts Radio Technical Services at the address shown below.

These statements do not affect the statutory rights of a consumer.



Issue 1

ROBERTS RADIO TECHNICAL SERVICES

97-99 Worton Road

Isleworth Middlesex

TW7 6EG

Technical Helpline :- 020 8758 0338 (Mon-Fri during office hours)

Website: <http://www.robertsradio.co.uk>



Free Manuals Download Website

<http://myh66.com>

<http://usermanuals.us>

<http://www.somanuals.com>

<http://www.4manuals.cc>

<http://www.manual-lib.com>

<http://www.404manual.com>

<http://www.luxmanual.com>

<http://aubethermostatmanual.com>

Golf course search by state

<http://golfingnear.com>

Email search by domain

<http://emailbydomain.com>

Auto manuals search

<http://auto.somanuals.com>

TV manuals search

<http://tv.somanuals.com>