

ROBERTS

Sound for Generations

DAB / FM RDS digital clock radio
with dock for iPod
model CRD-42

iDream[®]



DAB

Digital Audio Broadcasting

Please read this manual before use

Contents

<i>Controls</i>	2-4	<i>Setting the alarm times</i>	21-23
<i>Remote handset battery replacement</i>	5	<i>To view the alarm settings</i>	24
<i>Using the clock radio for the first time</i>	6	<i>Cancelling alarms</i>	24
<i>Operating your clock radio</i>	7	<i>Snooze function</i>	25
<i>Selecting a station - DAB</i>	8	<i>Sleep function</i>	26
<i>Secondary services - DAB</i>	9	<i>Setting the clock manually</i>	27-28
<i>Display modes - DAB</i>	9-10	<i>To return to auto clock set mode</i>	29
<i>Finding new stations - DAB</i>	11	<i>Clock display</i>	30
<i>Manual tuning - DAB</i>	12	<i>Display backlight dimmer</i>	30
<i>Signal strength display - DAB</i>	12	<i>Software version</i>	31
<i>Dynamic Range Control (DRC) - DAB</i>	13	<i>System reset</i>	32
<i>Operating your radio - FM auto-tune</i>	14	<i>Headphone socket</i>	33
<i>Manual tuning - FM</i>	15	<i>Auxiliary input (Line in) socket</i>	34
<i>Display modes - FM</i>	16	<i>Cautions</i>	35
<i>Presetting stations</i>	17	<i>Specifications</i>	36
<i>Recalling a preset station</i>	18	<i>Circuit features</i>	36
<i>iPod docking</i>	19	<i>Guarantee</i>	38
<i>Navigating your iPod</i>	20		
<i>Playing a file on your iPod</i>	20		
<i>Search function</i>	20		

Controls (Top)

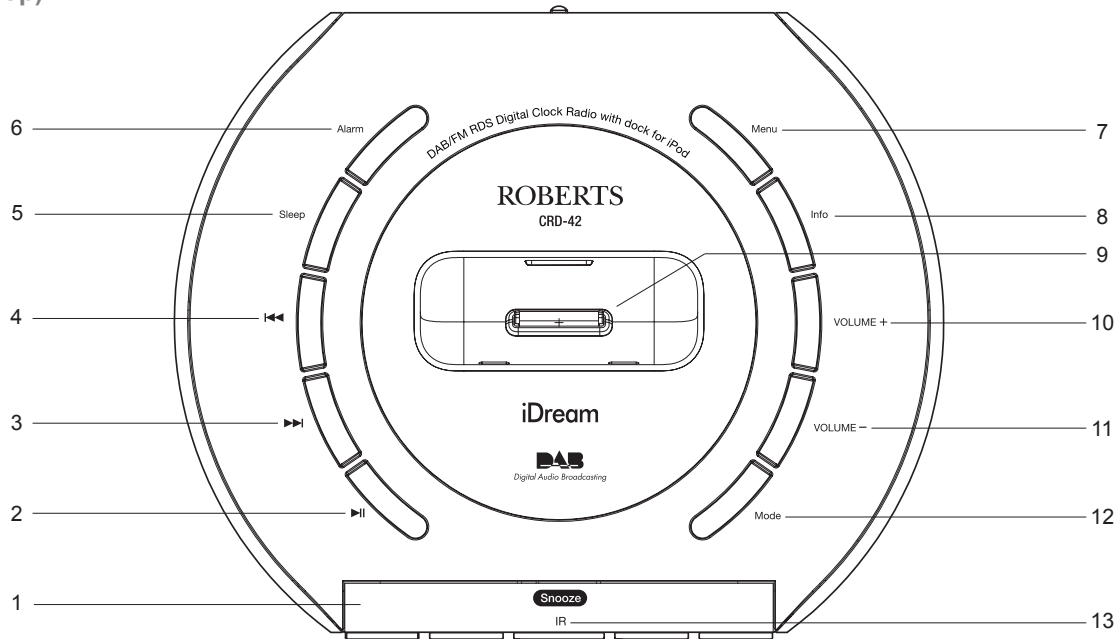

1. Snooze button

2. Play / Pause button

3. Fast-forward button

4. Rewind button

5. Sleep button

6. Alarm button

7. Menu button

8. Info button

9. Dock for iPod

10. Volume Up button

11. Volume Down button

12. Mode button

13. Infra-red sensor (hidden)

Note: For the sake of clarity, the instructions for the use of the controls throughout this instruction manual show the buttons on the remote control. The buttons on the clock radio as shown above can be used if you prefer.

If you need any further advice, please call our Technical Helpline on :-

020 8758 0338 (Mon-Fri)

Download from www.Somanuals.com. All Manuals Search And Download.

Controls (front)

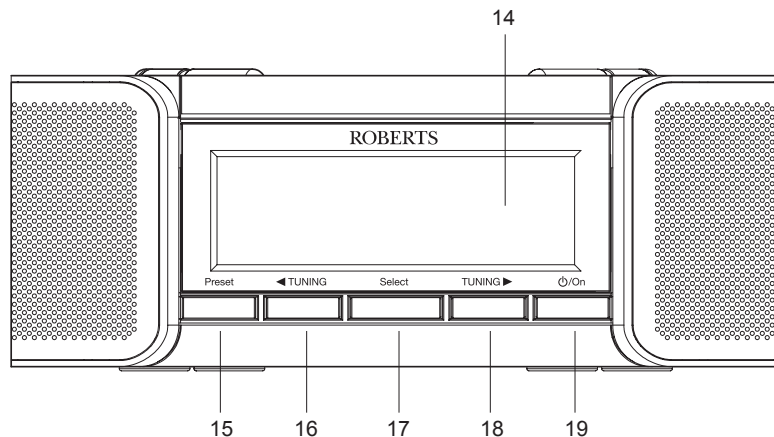

- 14. LCD display
- 15. Preset button
- 16. Tuning Down button
- 17. Select button
- 18. Tuning Up button
- 19. On / Standby button

Controls (rear)

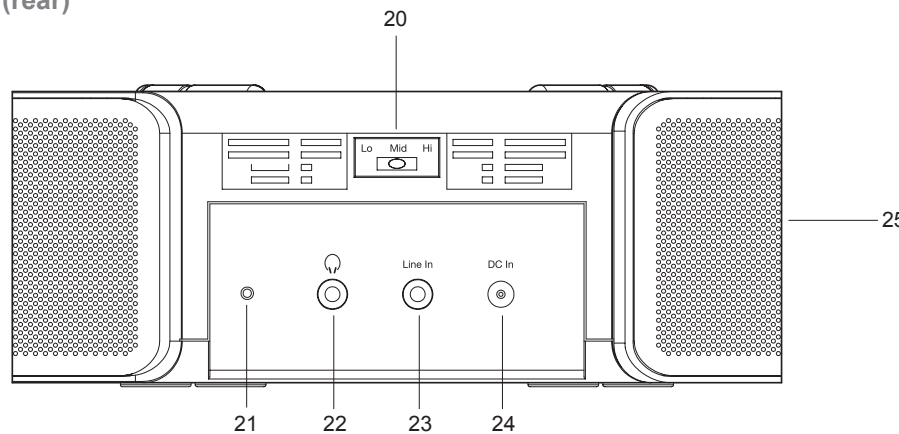

- 20. Dimmer switch
- 21. Wire DAB / FM aerial
- 22. Headphone socket
- 23. Line in (auxiliary input) socket
- 24. DC in socket
- 25. Loudspeakers (x 2)

Controls (remote control)

1. On / Standby button
2. Alarm button
3. Sleep button
4. Play / Pause button
5. Rewind button
6. Preset button
7. Tuning Up button
8. Select button
9. Tuning Down button
10. Info button
11. Snooze button
12. Menu button
13. Volume Down button
14. Volume Up button
15. Fast-forward button
16. Mode button

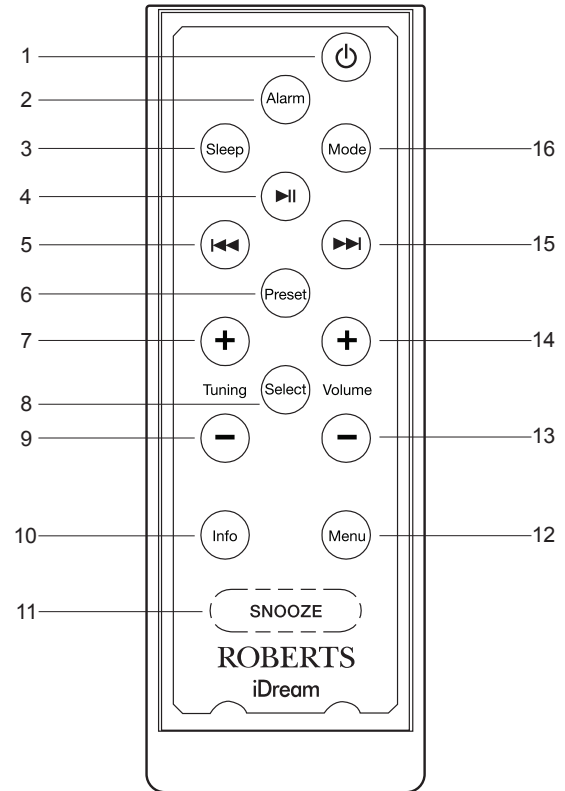

Note: For the sake of clarity, the instructions for the use of the controls throughout this instruction manual show the buttons on the remote control. The buttons on the clock radio can be used if you prefer.

Remote handset battery replacement

1. Remove the battery cover on the rear of your remote control by rotating the cover approximately 45 degrees in an anti-clockwise direction to align the dot on the cover with the "OPEN" marking on the remote control. Gently tap the control to release the cover. If necessary, use a coin in the slot in the cover in order to rotate it.
2. Insert 1 x CR2025 size battery into the compartment with the positive side (marked +) facing towards the battery cover, as shown on the reverse side of the battery cover.
3. Close the battery cover by re-applying the cover to the control in the position marked "OPEN" and then use a coin to rotate the cover clockwise so that there is a slight click and the dot on the cover is aligned with the "LOCK" marking on the remote control.
4. If the remote is not to be used for an extended period of time it is recommended that the battery is removed.

IMPORTANT: The battery should not be exposed to excessive heat such as from direct sunshine, fire or the like. After use, disposable batteries should if possible be taken to a suitable recycling centre. On no account should batteries be disposed of by incineration.

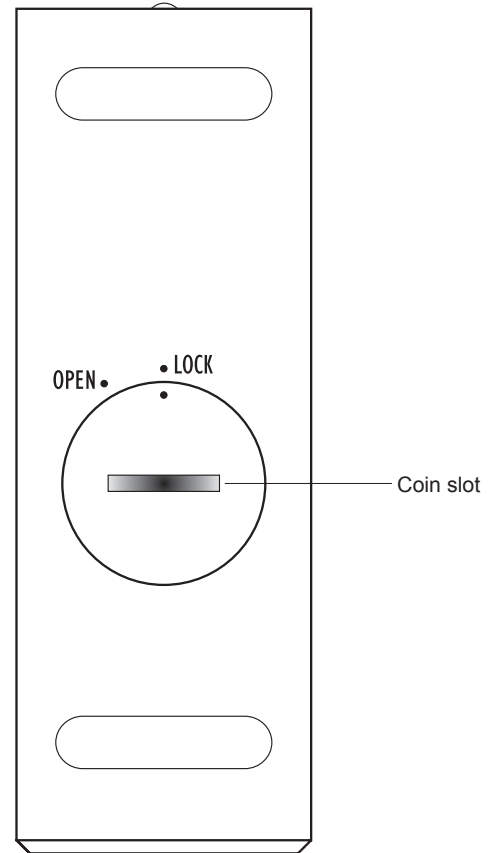

Using the clock radio for the first time

1. Place your clock radio on a flat surface.
2. Fully extend the wire aerial located on the rear of your clock radio. Place the wire antenna so that it is as straight as possible extending either above or below the radio.
3. Insert the adaptor plug into the DC socket located on the rear of your clock radio. Plug the adaptor into a standard 13 amp mains socket outlet. The display will show "ROBERTS" for a few seconds and then the display will then show "SET CLOCK". During this time the radio is scanning to find out which DAB radio stations are available. After a short time the current time will appear on the display.
4. If no stations are found, "NO CLOCK" will be displayed. It may be necessary to relocate your clock radio to a position giving better reception. You should then carry out a scan to find stations as described on page 11.

IMPORTANT: The mains adaptor is used as the means of connecting the radio to the mains supply. The mains socket used for the radio must remain accessible during normal use. In order to disconnect the radio from the mains completely, the mains adaptor should be removed from the mains socket outlet completely.

Characters appearing on the LCD display indicate that the radio is connected to and powered from the mains supply.

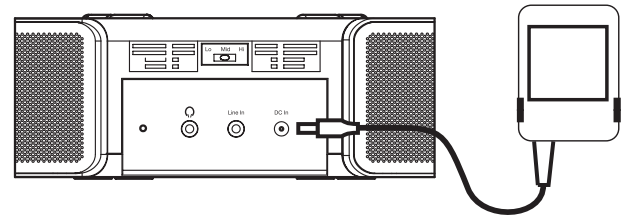

ROBERTS

SETCLOCK

12:38 TU

NO CLOCK

Operating your clock radio

1. Press the **On / Standby button** to switch on your clock radio. The display will show "TUNING" for a few seconds.

When first switched on, the radio will be in DAB mode. After each use the radio will remember the mode used and then switch on in that mode the next time that it is used



2. If the clock radio has been used before, the last used station will be selected.
3. If this is the first time that the radio has been used, then the first station in the list of stations found during scanning will be played. The display will show the station name on the display.
4. If no signals are found then "OFF AIR" will be displayed and it may be necessary to relocate your clock radio to a position giving better reception. You should then carry out a scan to find stations as described on page 11.

- Your clock radio has a indicator  on the display to indicate the strength of the DAB radio signal being received.

Note: When first switched on, the radio will set the volume to a moderately high level, in case the broadcast is very quiet. After you have set the volume using the **Volume Up** or **Down** buttons, the radio will remember the setting that you have applied for the next time that it is used.



Selecting a station - DAB

1. Press the **On / Standby button** to switch on your clock radio. The display will show "TUNING" for a few seconds.
2. Press the **Mode button** to select DAB mode. The display will show the name of the radio station currently selected.
3. Press the **Tuning up** or **down buttons** to step through the list of available stations.
4. When the desired station name appears on the display, press the **Select button** to select the station. The display will show "TUNING" while your radio finds the new station.
5. Adjust the **Volume control** to the required setting.

Note: If after selecting a station the display shows "OFF AIR" it may be necessary to relocate your radio to a position giving better reception.

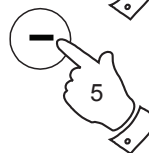
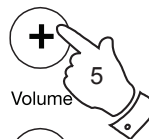
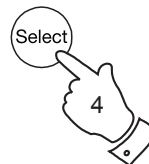
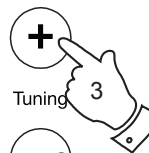
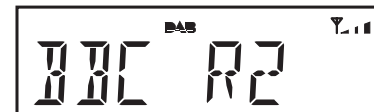
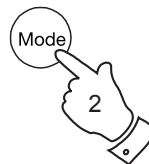

Secondary services - DAB

1. Certain radio stations have one or more secondary services associated with them. If a station has a secondary service associated with it then the secondary service will then appear immediately after the primary service as you press the Tuning Up button.
2. To tune to the secondary service, press and release the **Select button**. Most secondary services do not broadcast continually and if the selected service is not available, the radio will re-tune to the associated primary service.

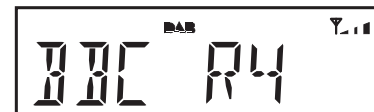
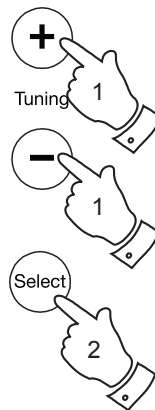

Display modes - DAB

Your radio has a range of display options when in DAB mode:-

1. Press the **Info button** to cycle through the various options.
 - a. Station name Displays the station name being listened to.
 - b. Scrolling text Displays scrolling text messages such as artist/track name, phone in number, etc.
 - c. Programme type Displays the type of station being listened to e.g. Pop, Classic, News, etc.



d. Multiplex Name Displays the name of the DAB multiplex to which the current station belongs.



e. Time and day Displays the current time (24 hour clock) and day of the week.



f. Date Displays the current date.



g. Frequency and channel Displays frequency and channel number for the currently tuned DAB station.



h. Bit rate Displays the digital audio bit rate for the currently tuned DAB station.



i. Signal error Displays the bit error rate for the currently tuned DAB station.

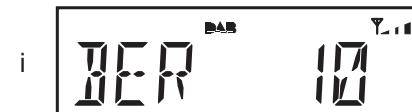

Finding new stations - DAB

From time to time, new DAB radio stations may become available. Or you may have moved to a different part of the country. In this case you may need to cause your radio to scan for new stations.

1. Press and release the **Menu button** so that "MANUAL" shows on the display.
2. Press the **Tuning Up** or **Down buttons** until the display shows "LOC SCAN".
3. Press and release the **Select button**. Your radio will perform a scan of the UK DAB frequencies. As new stations are found, the station counter on the right-hand side of the display will increase and stations will be added to the list.

In countries other than the UK, in order that the radio may find the available stations it is recommended to carry out a full scan of the entire DAB Band III frequencies. In this case proceed as follows.

4. Press and release the **Menu button** the display shows "MANUAL".
5. Press the **Tuning Up** or **Down buttons** until the display shows "FULLSCAN".
6. Press and release the **Select button**. Your radio will perform a full scan of the DAB frequencies. As new stations are found, the station counter on the right-hand side of the display will increase and stations will be added to the list.

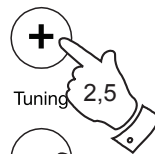
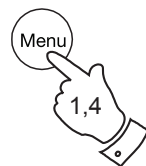

Manual tuning - DAB

Manual tuning allows you to tune your radio to a particular DAB frequency in Band III. Any new stations found will be added to the station list. This function can also be used to assist the positioning the aerial or the radio to optimise reception for a specific channel or frequency. Note that UK DAB stations are located in the range of channels 11B to 12D.

1. Press and release the **Menu button** so that the display shows "MANUAL". Press and release the **Select button** to enter the manual tuning mode.
2. Press the **Tuning Up** or **Down buttons** to select the desired DAB channel. Press and release the **Select button** to tune to the chosen frequency.
3. If a signal is present, this will be indicated on a signal strength display. The minimum signal marker (|) shows the minimum signal strength needed for good DAB reception. The signal indicator chevrons go up or down showing the changing signal strength as you adjust the wire aerial or your clock radio position. Press and release the **Select button** again to return to the normal DAB tuning mode.

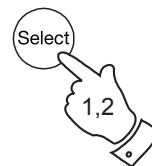
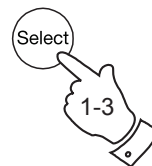
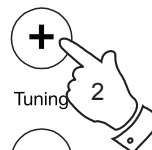
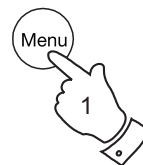

Signal strength display - DAB

1. Press and release the **Select button** to show the signal strength display. The minimum signal marker (|) shows the minimum signal strength needed for good DAB reception. The signal indicator chevrons increase or decrease showing the changing signal strength as you adjust the wire aerial or your clock radio position.
2. Press and release the **Select button** to return to the normal radio display.

If you need any further advice, please call our Technical Helpline on :-

020 8758 0338 (Mon-Fri)

Download from www.Somanuals.com. All Manuals Search And Download.

Dynamic Range Control (DRC) - DAB

The DRC facility can make quieter sounds easier to hear when your radio is used in a noisy environment.

There are three levels of compression:

- DRC 0 No compression applied. (default)
- DRC 1 Maximum compression applied.
- DRC 1/2 Medium compression applied.

1. Press the **Standby button** to switch on your clock radio.
2. Press the **Mode button** to select the DAB band.
3. Press and release the **Menu button** until the display shows "MANUAL."
4. Press the **Tuning Up** or **Down buttons** until "DRC VAL" appears on the display. Then press the **Select button**. The display will show the current DRC value.
5. Press the **Tuning Up** or **Down buttons** to select the required DRC setting (default is 0) .
6. Press and release the **Select button** to confirm the setting. The display will return to the normal radio display.

Note: Not all DAB broadcasts are able to use the DRC function. If the broadcast does not support DRC, then the DRC setting in the radio will have no effect.

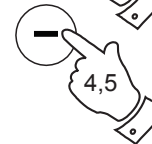
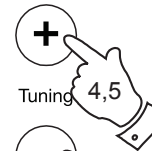
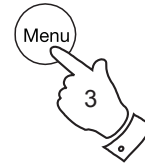
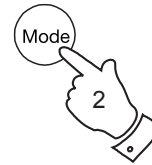

Operating your radio - FM auto-tune

1. Fully extend the wire aerial located on the rear of your clock radio. Place the wire antenna so that it is as straight as possible extending vertically either above or below the radio.
2. Press the **On / Standby button** to switch on your clock radio.
3. Press the **Mode button** to select the FM band.
4. Press and hold down the **Tuning Up button** for 2 - 3 seconds to cause your radio to search from low frequency to high frequency and to stop automatically when it finds a station of sufficient strength.
5. After a few seconds the display will update. The display will show the frequency of the signal found. If the signal is strong enough and there is RDS data present then the radio will display the station name.
6. To find other stations press and hold the **Tuning Up button** as before.
7. Press and hold down the **Tuning Down button** for 2 - 3 seconds to cause your radio to search from high frequency to low frequency and to stop automatically when it finds a station of sufficient strength.
8. When the end of the waveband is reached your radio will recommence tuning from the opposite end of the waveband.
9. Adjust the **Volume** to the required setting.
10. To switch off your clock radio press the **On / Standby button**.

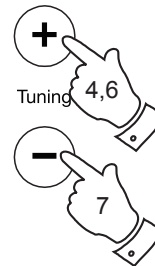
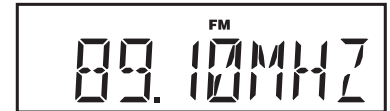
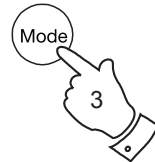

Manual tuning - FM

1. Fully extend the wire aerial located on the rear of your clock radio. Place the wire antenna so that it is as straight as possible extending either above or below the radio.
2. Press the **On / Standby button** to switch on your clock radio.
3. Press the **Mode button** to select the FM band.
4. Press the **Tuning Up** or **Down button** to tune to a station. The frequency will change in steps of 50kHz.
If the radio is tuned to a station of sufficient signal strength with RDS information present, then the display may change to show the station name.
5. When the waveband end is reached the radio will recommence tuning from the opposite waveband end.
6. Set the **Volume** to the desired setting.
7. To switch off your clock radio press the **On / Standby button**.

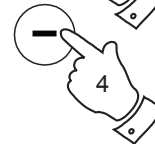
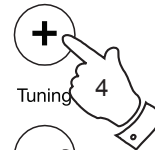
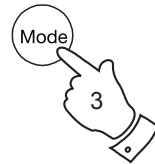

Display modes - FM

Your radio has a range of display options for FM mode:-

The Radio Data System (RDS) is a system in which inaudible digital information is transmitted in addition to the normal FM radio programme. RDS offers several useful features. The following are available on your clock radio.



1. Press the **Info button** to cycle through the various modes.

- | | |
|-------------------|---|
| a. Station name | Displays the name of the radio station being listened to. |
| b. Scrolling text | Displays scrolling text messages such as artist/track name, phone in number, etc. |
| c. Programme type | Displays type of station being listened to e.g. Pop, Classic, News, etc. |
| d. Time and day | Displays the current time and day (24 hour clock format) |
| e. Date | Displays current date. |
| f. Frequency | Displays the frequency of the station being listened to. |

Note: If no RDS information is available, the radio will be unable to display the station name, scrolling text and programme type information.



If you need any further advice, please call our Technical Helpline on :-

020 8758 0338 (Mon-Fri)

Download from www.Somanuals.com. All Manuals Search And Download.

Presetting stations

You may store your preferred DAB and FM radio stations to the preset station memories. There are 20 memory presets in your radio, 10 for DAB and 10 for FM. Presets are remembered by your radio in the event of a power failure.

The procedure for setting presets and using them to tune stations is the same for FM and DAB modes, and is described below.

1. Press the **On / Standby button** to switch on the clock radio.
2. Press the **Mode button** to select the desired waveband.
3. Tune to the required station as previously described.
4. Press and release the **Preset button**. The display will show, for example, "Empty 1" if no station has been stored to that preset.
5. Use the **Tuning Up** or **Down buttons** to select the desired preset station number under which you wish to store the station.
6. Press and hold down the **Preset button** until the display shows, for example, "P1 SAVED". The station will be stored under the chosen preset. Repeat this procedure for the remaining presets.
7. Stations which are have been stored in preset memories may be overwritten by following the above procedure.

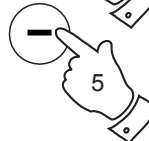
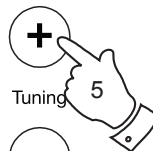
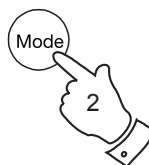

Recalling a preset station

1. Press the **On / Standby button** to switch on the radio.
2. Press the **Mode button** to select the desired waveband.
3. Press and release the **Preset button**. The display will show, for example, "Empty 1" if no station has been stored to that preset. If a preset has been stored, then the display will show either the station name (for DAB stations) or the frequency (for FM stations).
4. Press the **Tuning Up or Down buttons** to select the desired preset station.
5. Press the **Select button**. Your clock radio will tune to the chosen preset station stored in the preset memory.

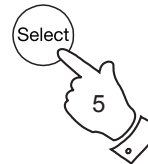
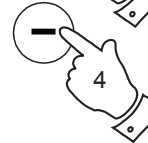
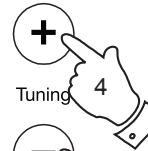
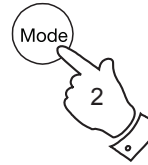

iPod docking

Your clock radio has an iPod dock facility which allows you to play digital audio files and video soundtracks held on your iPod using the clock radio's loudspeakers.

Your radio uses the iPod Universal Dock connector developed for use with iPods. Recent models of iPod are supplied with Universal Dock Adapter inserts which ensure correct alignment of the iPod with the electrical connector. Should you require a Universal Dock Adapter to use your iPod with your clock radio, then please contact an iPod accessories supplier.

Important: To avoid possible damage to your iPod, do not use your iPod with the product without the correct adapter fitted to the radio.

Docking your iPod

1. Place the iPod Universal Dock Adapter into the iPod docking recess so that it is securely seated.
2. Carefully place your iPod onto the Universal Dock connector.
3. Press the **On / Standby button** to switch on your clock radio.
4. To select the iPod mode press the **Mode button** until "IPOD" shows on the display.

Note: Your clock radio is able to recharge your iPod's internal battery. Your iPod will use its backlight settings as configured. If these need changing, use the Settings menu on your iPod.

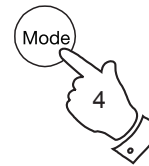
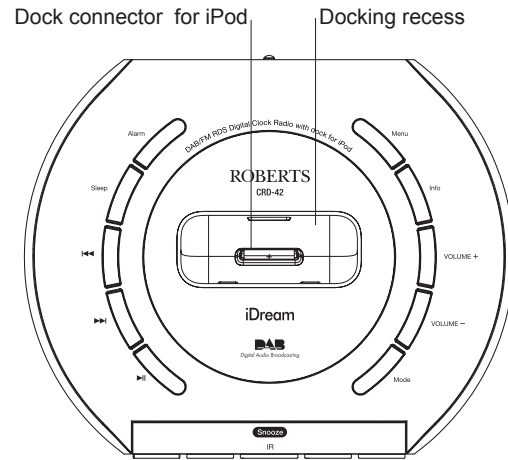

Navigating your iPod

1. To navigate iPod menus to make selections or to change settings, you should use your iPod controls. The clock radio controls can be used for Previous / Next and Play / Pause functions.



Playing a file on your iPod

2. When you have found the required item use the **Play / Pause button** on the radio to start the iPod playing. If you have just docked your iPod, you may need to press the button more than once to ensure that the radio is communication with your iPod.
3. Adjust the volume to the required setting using the **Volume Up and Down buttons** on your clock radio.
4. To pause playback press the **Play / Pause button**. To resume playback press the **Play / Pause button** again.
5. iPods do not have a Stop button (they use the Pause function). To play an alternative selection, use the iPod menus to make the selection using the **Play / Pause button** to stop playing the current item if needed.



Search function

1. While the iPod is playing, press and hold the **Fast-forward or Rewind buttons** to move through the current file or track. Release the button when the desired point in the file or track is reached.
2. Press and release either the **Fast-forward or Rewind buttons** to start playing the next or previous file or track.

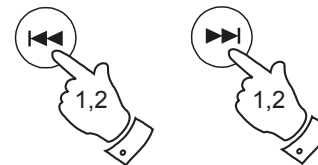

Setting alarm times

Your clock radio has two alarms which can be set to wake you to DAB, FM radio, iPod item or beep type alarm. Each alarm can be set to sound once, daily, on weekdays or at weekends. **The alarms can only be set when your clock radio is switched on and in DAB or FM mode.**

Note: If no buttons are pressed for 7 seconds, your clock radio will exit the alarm setup.

1. Press the **On/Standby button** to switch on the clock radio. If necessary press and release the **Mode button** to put the radio into DAB or FM mode.
2. Press and release the **Alarm button**. The display will show "SET ALM".
3. Press the **Select button** to enter the alarm setup. "Alarm 1" flashes.
4. Press the **Tuning Up or Down buttons** to select the desired alarm number, 1 or 2.
5. Press the **Select button** to enter the setting for the chosen alarm. Press the **Tuning Up or Down buttons** to select ON or OFF. If OFF is selected any current setting for that alarm will be cancelled.
6. Press the **Select button** to cause the alarm hour digits to flash on the display.
7. Press the **Tuning Up or Down buttons** to choose the desired alarm hour.

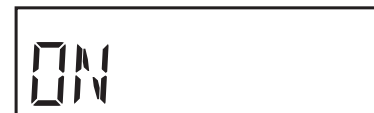
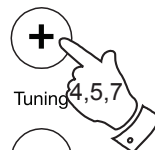

8. Press the **Select button** to enter the hour setting. The alarm minute digits will flash on the display.

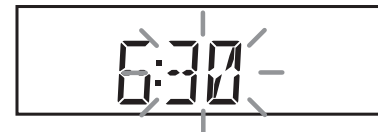
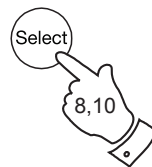

9. Press the **Tuning Up or Down buttons** to choose the desired alarm minute.

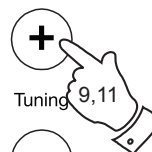

11. Press the **Tuning Up or Down buttons** to choose the desired alarm day option:

- Once - Will sound at one time only
- Daily - Will sound everyday
- Weekdays - Will sound only on weekdays
- Weekends - Will sound only on weekends



• If setting the alarm to once only, continue with step 12 below. Otherwise skip to step 18 on the following page.

12. Press the **Select button** to enter the setting. The alarm year will flash on the display.

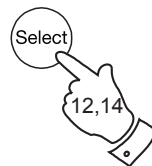

13. Press the **Tuning Up or Down buttons** to choose the alarm year.

14. Press the **Select button** to enter the alarm year setting. The alarm month will flash on the display.

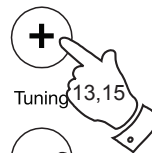

15. Press the **Tuning Up or Down buttons** to choose the alarm month.

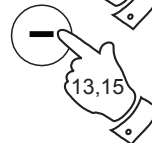

If you need any further advice, please call our Technical Helpline on :-

020 8758 0338 (Mon-Fri)

Download from www.Somanuals.com. All Manuals Search And Download.

16. Press the **Select button** to enter the alarm month setting. The alarm day will flash on the display.

17. Press the **Tuning Up** or **Down buttons** to choose the alarm day.

18. Press the **Select button** to enter the setting. The alarm source option will flash on the display.

19. Repeatedly press the **Tuning Up** or **Down buttons** to choose the desired alarm source (DAB, FM, BUZ, iPod).

20. Press the **Select button** to confirm the alarm settings and return to normal radio mode.

Radio and iPod alarms are indicated in the display by the 🎵 symbol and the corresponding alarm number. Buzzer alarms are indicated by the 🔔 symbol and the corresponding alarm number.

When your clock radio is set to wake by the radio alarm, your clock radio will switch to the last used DAB or FM radio station.

Important: If using your iPod as the source for the alarm, then be sure to dock your iPod. After docking, briefly switch on the clock radio using the **On / Standby button** and then select iPod mode using the **Mode button**. Next, press the **Play / Pause button** two or three times to ensure that the clock radio and your iPod are communicating correctly. Failure to verify this may result in the alarm not being audible if the clock radio is unable to activate your iPod when needed. When ready, put the clock radio back into standby mode using the **On / Standby button**.

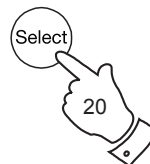
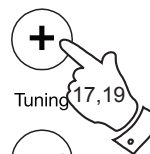
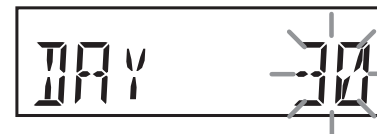
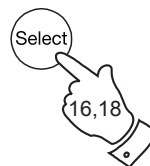

To view the alarm settings

1. Press the **On / Standby button** to switch on the clock radio. If necessary press and release the **Mode button** to put the radio into DAB or FM mode.
2. Press the **Alarm button** to enter the alarm setup.
3. Press the **Select button**, then press the **Tuning Up** or **Down buttons** to view alarms 1 or 2.
4. Press the **Select button** to cycle through each of the settings for the chosen alarm.
You may use the Tuning Up and Down buttons to modify any particular setting if desired, using the Select button to enter the modification.

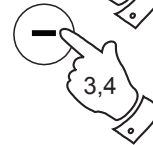
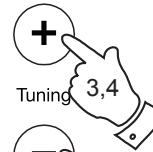

Cancelling alarms

1. While an alarm is sounding it can be cancelled by pressing the **On / Standby button**.



Snooze function

1. When the radio, iPod or buzzer alarm sounds, pressing the **Snooze button** will silence the alarm for the selected number of minutes. The Snooze duration can be adjusted between 5 and 20 minutes in 5 minute increments. The default setting is 5 minutes.

When the Snooze button has been pressed during an alarm, the display will show the Snooze symbol **z^z**. This sequence can be repeated during the 60 minute alarm period.

2. To cancel the Snooze function, press the **On / Standby button**.

To set the snooze time

1. Press the **On/Standby button** to switch on the clock radio. If necessary press and release the **Mode button** to put the radio into DAB or FM mode.
2. To set the snooze to the desired snooze time, press the **Alarm button** to enter the menu setup. "SET ALM" will appear on the display.
3. Press the **Tuning Up** or **Down button** until "SNOOZE" appears on the display. Press and release the **Select button**. "SNOOZE05" will be displayed.
4. Press the **Tuning Up** or **Down buttons** to choose the desired snooze setting from between 5, 10, 15 and 20 minutes.
5. Press the **Select button** to enter the desired snooze duration. The radio will exit the menu options and return to the normal radio display.

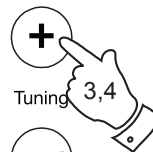
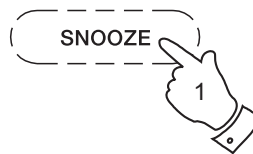

Sleep function

Your clock radio can be set to turn off after a preset time has elapsed. The sleep setting can be adjusted between 5 and 90 minutes in 5 minute increments. Ensure your clock radio is switched On.



1. When using your radio, press the **Sleep button**. "SLEEP" appears on the display.
2. Repeatedly press the **Sleep button** to select desired sleep time. The sleep setting will increase in 5 minute increments from 5 minutes up to 90 minutes. A further press will cause the sleep timer to be set to OFF which will cancel the sleep function.
3. The display will show the sleep timer setting then exit the sleep options. The sleep symbol  will show on the display.
4. Your clock radio will switch off after the preset sleep time has elapsed.
5. To cancel the sleep timer and switch of your radio before the chosen sleep time has elapsed, press the **On / Standby button**.
To cancel the sleep timer without switching off your radio, repeatedly press the **Sleep button** until "OFF" is displayed.



Setting the clock manually

Normally your clock radio will set its clock automatically using the DAB radio signal. If no DAB signal is available and you need to set the time manually, please follow the procedure shown below.

1. Press the **On/Standby button** to switch on the clock radio. If necessary press and release the **Mode button** to put the radio into DAB or FM mode.
2. To set the clock time, press the **Menu button** to enter the setup menu. "MANUAL" will appear on the display.
3. Press the **Tuning Up or Down button** until "CLOCK" appears on the display. Press and release the **Select button**.
4. Press the **Tuning Up or Down button** until "MANU CLK" appears on the display.
5. Press and release the **Select button** to enter the manual setting procedure. The hour digits will then flash on the display.
6. Press the **Tuning Up or Down buttons** to set the desired hour.
7. Press and release the **Select button** to enter the hour setting.
8. The minute digits will then flash on the display. Press the **Tuning Up or Down buttons** to set the desired minute.

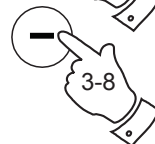
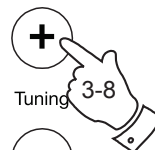
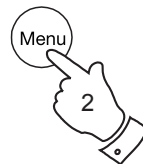

9. Press the **Select button** to enter the minutes setting. The year will then flash on the display.
10. Press the **Tuning Up** or **Down buttons** to change the year as needed.
11. Press the **Select button** to enter the year setting. The month will then flash on the display.
12. Press the **Tuning Up** or **Down buttons** to select the current month.
13. Press the **Select button** to enter the month setting. The day in the month will then flash on the display.
14. Press the **Tuning Up** or **Down buttons** to select the current day.
15. Press the **Select button** to confirm the time setting and return to the normal radio display.

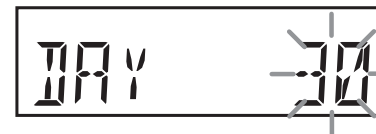
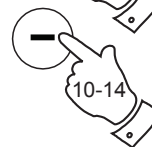
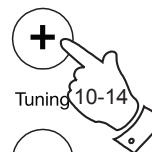
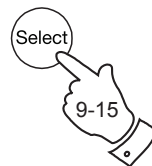

To return to auto clock set mode

1. Press the **On / Standby button** to switch on the clock radio. If necessary press and release the **Mode button** to put the radio into DAB mode.
2. Press and release the **Menu button** to enter the setup menu. "MANUAL" will appear on the display.
3. Press the **Tuning Up or Down button** until "CLOCK" appears on the display. Press and release the **Select button**.
4. Press the **Tuning Up or Down button** until "AUTO CLK" appears on the display. Press and release the **Select button**.
5. The radio will immediately set its time according to the information received with the DAB broadcast. The radio will return to normal radio operation with the time currently displayed.

Note: If you select "AUTO CLK" the current time received will be displayed. If no DAB signal is found, "NO DABCK" will be displayed. You should then either position the radio or its aerial so that a signal can be received, or revert to manual clock mode (see page 27).

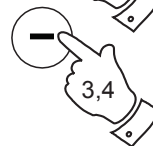
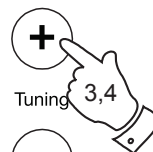
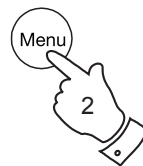

Clock display

1. When your clock radio is in standby mode the time and day will be displayed. The time is always shown using a 24 hour clock format.



Display backlight dimmer

1. In order to adapt the intensity of the display to suit the ambient room lighting, slide the dimmer switch on the rear of your clock radio to select the dimmer brightness from Low, Mid or High settings.

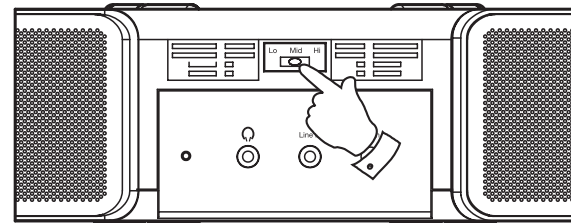

Software version

The software display cannot be altered and is just for your reference. Ensure your clock radio is switched on and in DAB or FM mode.

1. Press and release the **Menu button**.
2. Press the **Tuning Up or Down buttons** until the display shows your clock radios software information.
3. After a few seconds your clock radio will return to the normal radio display mode.

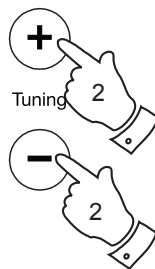
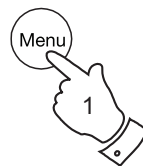

System reset

If your radio fails to operate correctly, or some digits on the display are missing or incomplete carry out the following procedure.

1. Press the **On/Standby button** to switch on the clock radio. If necessary press and release the **Mode button** to put the radio into DAB or FM mode.
2. Press and release the **Menu button**.
3. Press and release the **Tuning Up** or **Down button** until "FACTORY" appears on the display. Press and release the **Select button** so that the display shows "RESET" and then press the **Select button** again.
4. A full reset will be performed. The station list and presets will be erased. Alarms will be cancelled and snooze and sleep timer settings will be set to their default values. The display will show "ROBERTS" and after a few seconds a station scan search will be performed automatically. The display will show progress of the station search, for example ">>>> 18". The number on the right of the display is the number of stations that have been found.

In case of malfunction due to electrostatic discharge, reset the product as above to resume normal operation. If you are not able to perform the reset operation as above, removal and reconnection of the power supply may be required.

If a problem persists our technical staff would be pleased to offer any assistance on operating the radio. Our technical helpline number is 020 8758 0338.

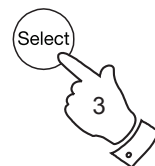
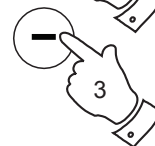
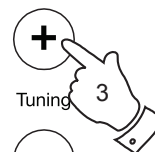
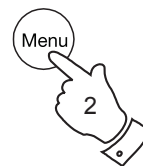

Headphone socket

A 3.5mm stereo **Headphone Socket** located on the rear of your clock radio is provided for use with either headphones or an earpiece. Inserting a plug automatically mutes the internal loudspeaker.

IMPORTANT: Excessive sound pressure from earphones and headphones can cause hearing loss.

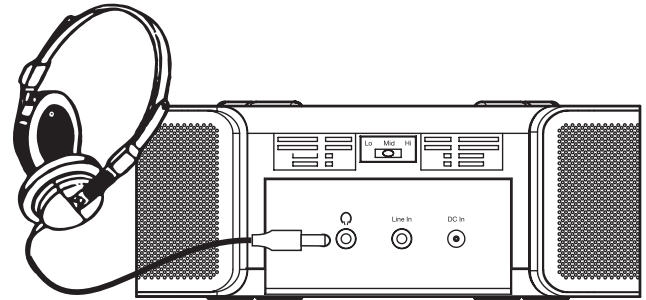

Auxiliary Input (Line in) socket

A 3.5mm stereo **Auxiliary Input socket** is provided on the rear of your clock radio to permit an audio signal to be fed into the unit from an external audio device such as iPod, MP3 or CD player.

1. Press the **Mode button** until "AUX IN" is selected on the display.
2. Connect a stereo or mono audio source (for example, iPod, MP3 or CD player) to the **Auxiliary Input socket** (marked "Line In").
3. Adjust the **Volume control** on your iPod, MP3 or CD player to ensure an adequate signal and then adjust the volume on the clock radio for comfortable listening.

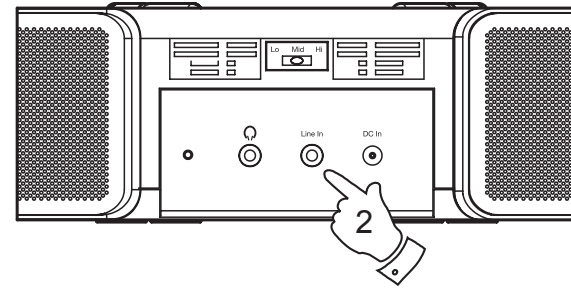

Cautions

Do not allow this clock radio to be exposed to water, steam or sand. Do not leave your clock radio where excessive heat could cause damage such as in a parked car where the heat from the sun can build up even though the outside temperature may not seem too high.

- The name plate is located on the bottom of the unit.



- Your clock radio should not be exposed to dripping or splashing and that no objects filled with liquids, such as vases, shall be placed on the clock radio.
- It is recommended to operate the product such that there is a minimum distance (10cm recommended) to adjacent objects in order to ensure good ventilation.
- The ventilation of the product should not be restricted by covering it or its ventilation openings with items such as newspapers, tablecloths, curtains etc.
- No naked flame sources such as lighted candles should be placed on the product.
- It is recommended to avoid using or storing the product at extremes of temperature. Avoid leaving the unit in cars, on window sills, in direct sunlight etc.

Specifications

Power Requirements

Mains AC 230V  50 Hz (switching adaptor)

Frequency Coverage

FM	87.5-108MHz
DAB	174.928 - 239.200MHz

Circuit Features

Output Power	2 x 2.4 Watt	
Headphone socket	3.5mm dia	
Auxiliary Input socket	3.5mm dia	
Aerial System	FM	Wire aerial
	DAB	Wire aerial

The Company reserves the right to amend the specification without notice.

iPod is a trademark of Apple Inc., registered in the U.S. and other countries.

"Made for iPod" means that an electrical accessory has been designed to connect specifically to iPod and has been certified by the developer to meet Apple performance standards.

Apple is not responsible for the operation of the device or its compliance with safety and regulatory standards.

Guarantee

This instrument is guaranteed for twelve months from the date of delivery to the original owner against failure due to faulty workmanship or component breakdown, subject to the procedure stated below. Should any component or part fail during this guarantee period it will be repaired or replaced free of charge.

The guarantee does not cover:

1. Damage resulting from incorrect use.
2. Consequential damage.
3. Receivers with removed or defaced serial numbers.

Procedure:

Any claim under this guarantee should be made through the dealer from whom the instrument was purchased. It is likely that your Roberts' dealer will be able to attend to any defect quickly and efficiently but should it be necessary the dealer will return the instrument to the Company's service department for attention. In the event that it is not possible to return the instrument to the Roberts' dealer from whom it was purchased, please contact Roberts Radio Technical Services at the address shown on the rear of this manual.

These statements do not affect the statutory rights of a consumer.



ROBERTS RADIO TECHNICAL SERVICES

97-99 Worton Road

Isleworth

Middlesex

TW7 6EG

Technical Helpline: 020 8758 0338 (Mon-Fri during office hours)

Website: <http://www.robertsradio.co.uk>



Issue 1

© 2008 Roberts Radio Limited

Free Manuals Download Website

<http://myh66.com>

<http://usermanuals.us>

<http://www.somanuals.com>

<http://www.4manuals.cc>

<http://www.manual-lib.com>

<http://www.404manual.com>

<http://www.luxmanual.com>

<http://aubethermostatmanual.com>

Golf course search by state

<http://golfingnear.com>

Email search by domain

<http://emailbydomain.com>

Auto manuals search

<http://auto.somanuals.com>

TV manuals search

<http://tv.somanuals.com>