

ROBERTS

Enjoy Listening

STREAMTIME

Internet / FM RDS Clock Radio



Please read this manual before use

Contents

Your clock radio	2-8	<i>Display modes - FM</i>	38
<i>StreamTime Internet Clock Radio and Media Player features</i>	2	<i>Presetting stations - Internet Radio and FM</i>	39
<i>About this instruction manual</i>	3	Clock and Alarms	40-49
<i>Controls and connections</i>	4-6	<i>Manually setting the clock</i>	40-41
<i>Before you can use this product</i>	7	<i>Resetting the clock</i>	41
<i>Display icons</i>	7	<i>Setting the clock format</i>	42
<i>Navigation controls</i>	8	<i>Setting daylight saving time</i>	43
Network configuration	9-11	<i>Setting the time zone</i>	44
<i>Connecting your clock radio to your computer network</i>	9-11	<i>Setting the alarm clock</i>	45-46
Internet Radio mode	12-22	<i>Disabling alarms</i>	47
<i>Internet Radio - the basics</i>	12	<i>To view alarms</i>	47
<i>Operating your radio - Internet Radio mode</i>	13-18	<i>Snooze timer</i>	47
<i>Selecting a radio station by location</i>	13	<i>Sleep timer</i>	48
<i>Selecting a radio station by genre</i>	15	<i>Nap timer</i>	49
<i>Searching for a radio station by name</i>	16	Display and Audio	50-53
<i>Listening to previously broadcast material</i>	17-18	<i>Dimmer</i>	50
<i>Customising your clock radio</i>	19	<i>Language selection</i>	50
<i>Configuring My Stations</i>	20	<i>Audio settings (tone controls)</i>	51
<i>Adding Stations using your clock radio</i>	21	<i>Headphone socket</i>	52
<i>Configuring My Streams</i>	22	<i>Line out socket</i>	52
Media Player mode	23-35	<i>Auxiliary input socket</i>	53
<i>Using Windows Shares</i>	23	Information	54-66
<i>Locate the shared audio files using the clock radio</i>	24-25	<i>Factory reset</i>	54
<i>Setup a windows PC via UPnP server</i>	26-27	<i>Software version</i>	55
<i>Locating and playing media files using UPnP</i>	28-29	<i>Enter network name manually</i>	56
<i>Media selection</i>	30-32	<i>Enter network address manually</i>	57-58
<i>Controlling playback</i>	32-33	<i>Wireless standby mode</i>	59
<i>Clearing the media player queue</i>	33	<i>WiFi strength</i>	60
<i>Playing tracks in the queue repeatedly</i>	34	<i>Signal warning</i>	60
<i>Playing tracks in random order</i>	35	<i>Troubleshooting</i>	61-62
FM mode	36-38	<i>Software update</i>	63
<i>Operating your radio - FM</i>	36	<i>Cautions / Specifications</i>	64
<i>Manual tuning - FM</i>	37	<i>Guarantee</i>	66

STREAMTIME Internet clock radio and Media player features

The Roberts **STREAMTIME** provides the following features in an attractive compact unit:-

- Listen to over 1000 radio stations from around the country, and over 10,000 from around the world.
- Listen to previously broadcast material from the BBC (using listen again)
- 10 radio station presets
- Play your music collection from your computer.
- The Media Player can connect to Windows Shares or UPnP servers (e.g. Windows Media Player 11)
- MP3, WMA, AAC, WAV, AIFF, FLAC, Real Audio and AU audio formats are supported.
- The **STREAMTIME** connects wirelessly to your home computer network.
- Large clock display (with 12 or 24 hour display mode)
- Two alarm timers to wake you to either buzzer, auxiliary input or radio alarm. Each alarm can be set to sound once, everyday, weekly, on weekdays or at weekends.
- Adjustable sleep timer which can be set to turn the sound off after between 10 minutes and 3 hours.
- Easy-to-read 2 line text display with large clock display.
- Adjustable display dimmer.
- Menu displays in major European languages:
English (GB), English (US), French, Spanish, Catalan,
German, Danish, Italian, Dutch, Portuguese, Finnish, Swedish
and Norwegian.
- Auxiliary input to allow your clock radio to be used as an amplifier and loudspeaker system for external MP3 players, CD players, etc.
- Line level output for optional connection to other audio equipment.
- A standard 3.5mm headphone socket is provided for private listening.
- Bass and Treble level adjustment.

About this instruction manual

This instruction manual is split into sections for each of the different operating modes of your Roberts **STREAMTIME** clock radio. There are three main sections - Internet Radio, Media Player (streaming files from a stored library) and FM radio. Each section is clearly identified by the shaded heading in the top right hand corner of each pair of pages.

Before using the Internet Clock Radio and Media Player functions, you will need to connect your clock radio to your computer network using the WiFi connection. This is covered in the section titled **Configuration**.

The **Internet Radio** section describes how to find radio stations to listen to. These can be radio stations that you already know and listen to conventionally, or new stations you may search for. You may set up stations that you like as Favourites so that they are more readily accessible.

The section for the **Media Player** describes the two methods by which the radio can access music files that you may have stored on a computer connected to your network. The use of Shared Folders, or Shared Media (using UPnP) is explained.

The section for **FM Radio** describes how to use the radio to listen to conventional radio broadcasts.

The section titled **Clock and Alarms** describes the different ways by which the clock in the clock radio may be set, as well as explaining the use of the alarms, snooze and sleep timer features.

The **Display and Audio** section shows how to adjust the dimmer, tone controls and to connect your radio to other equipment.

The **Information** section includes troubleshooting, specifications and warranty information.

Configuration

(page 9)

Internet Radio

(page 12)

Media Player

(page 23)

FM Radio

(page 36)

Clock and Alarms

(page 40)

Display and Audio

(page 50)

Information

(page 54)

(Top)

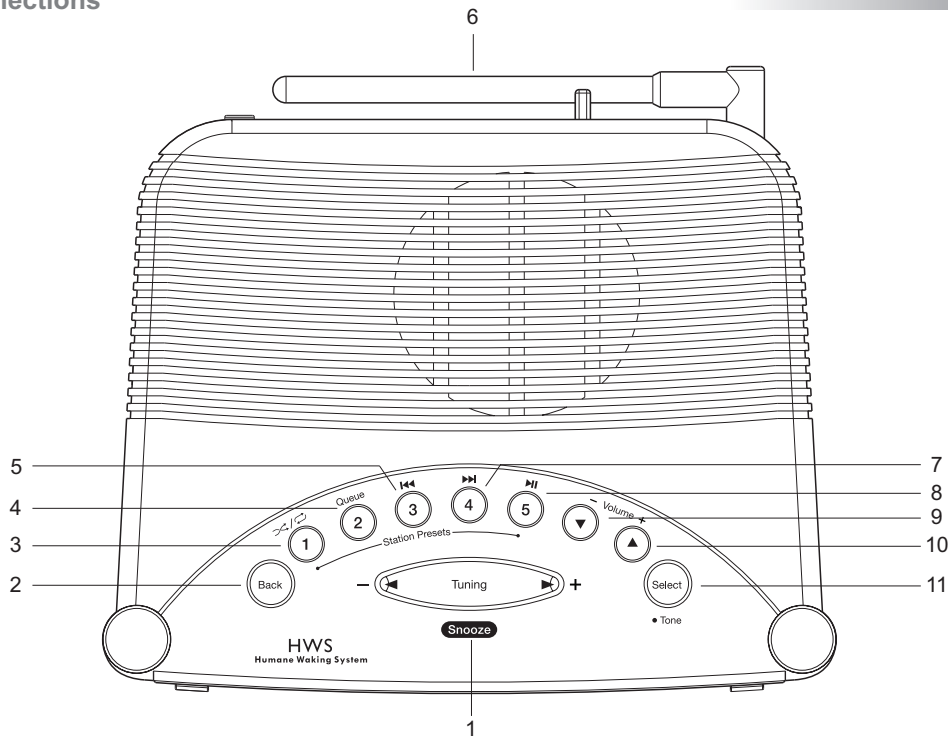

- 1. Tuning Up / Down / Snooze button
- 2. Back button
- 3. Preset 1 / Playmode button
- 4. Preset 2 / Queue button

- 5. Preset 3 / Rewind button
- 6. Wi-Fi Antenna
- 7. Preset 4 / Fast Forward button
- 8. Preset 5 / Play/Pause button

- 9. Volume Down button
- 10. Volume Up button
- 11. Select / Tone button

Controls and connections

(Front)

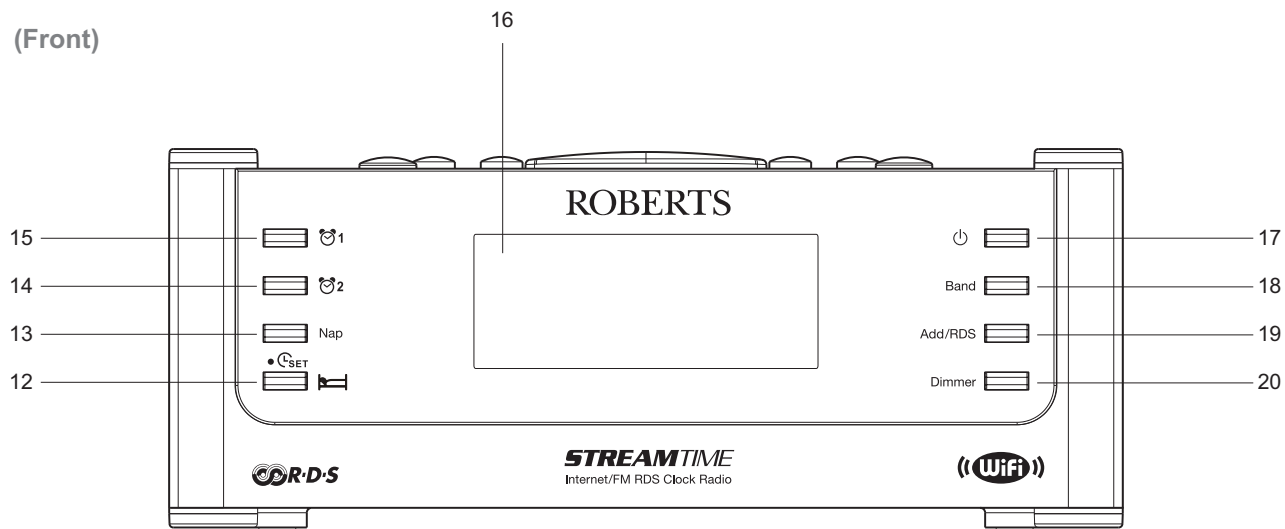

- 12. Time Set / Sleep Timer button
- 13. Nap Timer button
- 14. Alarm 2 button
- 15. Alarm 1 button
- 16. LCD display

- 17. On / Off button
- 18. Band button
- 19. Add / RDS button
- 20. Dimmer button

(Rear)

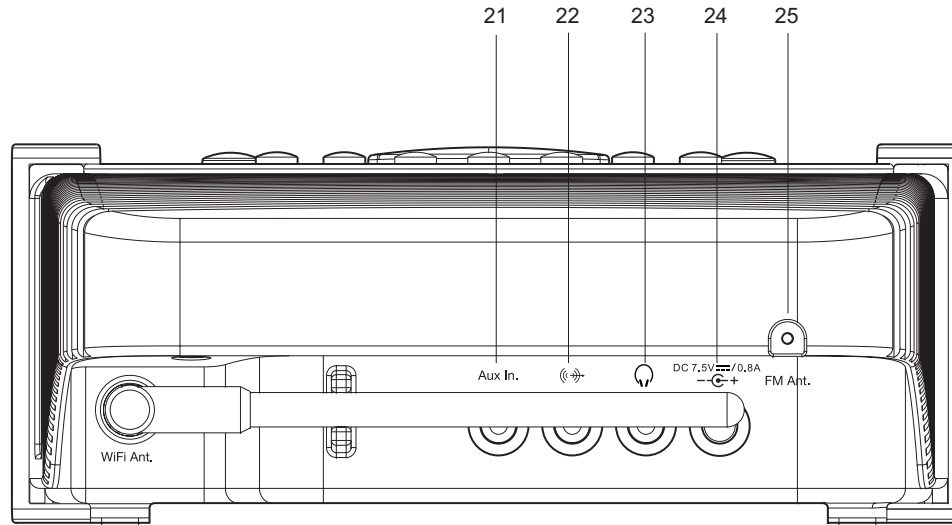

- 21. Auxiliary input socket
- 22. Line output socket
- 23. Headphone socket
- 24. DC input socket
- 25. Wire FM aerial

Before you can use this product

Before you can use your Internet clock radio, you must have the following:

- A broadband Internet connection (not required for FM or Media player functions).
- A wireless access point (Wi-Fi) connected to your broadband Internet Service provider preferably via a router. In many cases the broadband modem, router and wireless access point will be a single combined unit supplied by your Internet Service Provider or bought from a computer store.
- If your wireless network is configured to use Wired Equivalent Privacy (WEP) or Wi-Fi Protected Access (WPA/WPA2) data encryption then you need to know the WEP or WPA key used for encryption so you can get the internet radio to communicate with the network.

The Internet radio will typically work within a 10-20 metre radius from your wireless access point. The actual range achieved will depend upon the building type, other nearby wireless networks, and possible interference sources. FM radio functions can operate wherever the radio is able to receive a suitable broadcast signal.

IMPORTANT: Before you continue, make sure that your wireless access point or router is powered up and working with your broadband Internet service (use your computer to verify this). To get this part of the system working you must read the instructions supplied with the wireless access point or router.

Display icons

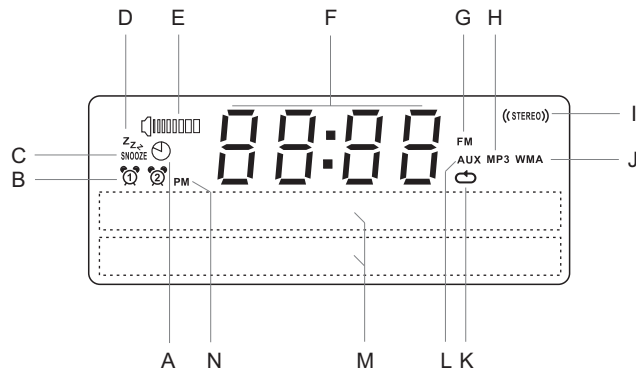

- | | |
|-----------------------------|--------------------------|
| A. Nap timer indicator | H. MP3 indicator |
| B. Alarm 1 and 2 indicators | I. Stereo indicator |
| C. Snooze indicator | J. WMA indicator |
| D. Sleep indicator | K. Repeat indicator |
| E. Speaker indicator | L. Aux input indicator |
| F. Clock digits | M. Two line text display |
| G. FM indicator | N. AM / PM indicator |

Navigation controls

This page describes the basic means of controlling your clock radio. Instructions for each of the operational modes are given in the later sections of this book.

1. Pressing the **On/Off** button brings your radio out of Stand-by mode. Pressing **On/Off** while the radio is in use will put it into Stand-by mode.
2. Pressing the **Band** button gives you access to each of the operating modes in sequence - Internet Radio, Media Player, Auxiliary input and FM radio.
3. Pressing the **Back** button will access the main mode menu system. Alternatively press and hold the **Select/Tone** button 'Off' will show on the display then press the **Tuning Up** or **Down** buttons until 'Mode menu' is displayed. Press and release the **Select** button to enter Main mode menu.
4. Many operations require the user to make a selection from the menu. This is done using the **Tuning Up** or **Down** buttons and the **Select** button. Use the **Tuning Up** or **Down** buttons to highlight the desired menu item then press the **Select** button to select that item.
5. If an error is made when navigating the menus, it is generally possible to go back to a higher level menu by pressing the **Back** button.

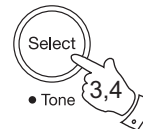
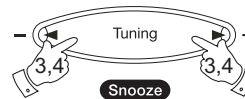
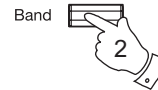
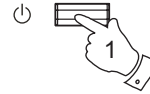

Your clock radio

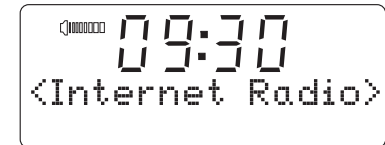

Connecting your clock radio to your computer network

1. Place your clock radio on a flat surface and plug the cable from the mains adaptor into the **DC input socket** located on the rear of your clock radio (marked 'DC') ensuring that the plug is pushed fully into the socket.
2. Plug the mains adaptor into a wall socket and switch on the socket.
IMPORTANT: *The mains adaptor is used as the means of connecting the radio to the mains supply. The mains socket used for the radio must remain accessible during normal use. In order to disconnect the radio from the mains completely, the mains adaptor should be removed from the mains socket outlet completely.*
3. When you apply power, the display on the clock radio will light up and say: 'Roberts Internet Radio'. If no network connection is yet configured, the clock radio will now scan for all available wireless networks and will show 'Scanning'.
4. If the clock radio cannot find a network then the display will say 'No Wireless Networks Found'. If this happens then you will have to get your wireless access point working - please see the instructions supplied with it.
5. When the clock radio finds your wireless network, it displays the Network Name (SSID) for the access point on the screen. This is a name that is allocated to the access point by the person who set up the network - for example: 'My Home Network'.
6. It is possible, and in some locations highly likely, that your clock radio will find more than one wireless access point, in which case you should choose which one you need to connect to.

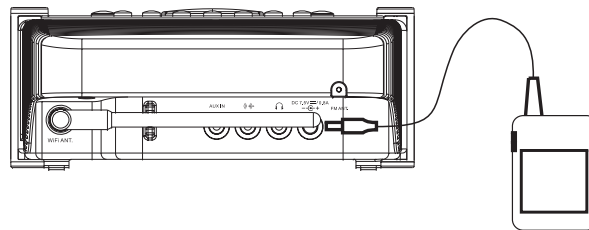

Roberts
Internet Radio

00:00
00:00
Scanning
■■■■■■■■■■

00:00
00:00
Select network
<My home network>

- Press the **Tuning Up or Down** buttons to see the SSID for each access point that the clock radio has found. If your network is shown proceed to step 9.
- If your network is not found, it is possible that it is configured such that the SSID is not broadcast (sometimes referred to as hidden). If this is the case then use the **Back** button and then select 'Enter network name'. This procedure is described page 56, 'Entering the network name manually'. If you know that your network name is not hidden, and it was not found, then either try re-scanning, (press the **Back** button), and if necessary try moving your clock radio to a location closer to your access point / router, or refer to 'Troubleshooting' on page 61.

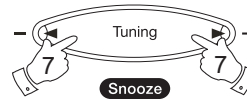

If you make a mistake at any point, use the **Back** button to go back to the previous screen.

- When the SSID for the access point you want to connect to is displayed on the screen, press the **Select** button.
- If your network is not configured to need an encryption code, the screen should say 'Connecting to network', then 'Network OK'. If this is the case then you have successfully connected your clock radio to your network, so please proceed to the section 'Once your clock radio is connected to the network' on the next page.
- If the screen displays either 'Enter WEP key' or 'Enter WPA key', it is because the network is using one of the encryption systems: Wired Equivalent Privacy (WEP) or Wi-Fi Protected Access (WPA). You therefore need to enter the correct WEP or WPA key into the clock radio to allow it to communicate with your wireless network.

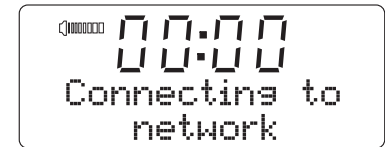
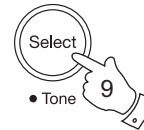

If you do not have the WEP or WPA key, then you should obtain it from the person who set up your network. Some wireless routers may come with an encryption key already set up by the supplier, in which case you should refer to the user documentation provided with it.

WEP keys are 10 or 26 characters long (using 0 - 9, and A - F). Some Wi-Fi access points can also use pass-phrases for WEP but these do not conform to a defined standard and are not supported. WPA keys are usually set up using a pass-phrase of between 8 and 63 characters. Your Internet radio can accept pass-phrases for WPA keys.

If the WEP or WPA key was previously entered and the radio has not had a factory reset the display will show 'Using saved key' and should then connect to the network.

- After 3 seconds, the display goes into the key entry mode. To enter the key, use the **Tuning Up** or **Down** buttons to select each character of the key in turn, when the character is central on the display press the **Select** button after each character. Remember, WEP keys only use the numbers 0 - 9 and letters A - F. WPA keys are sensitive to upper and lower case characters so you must enter them exactly.

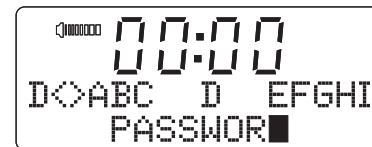
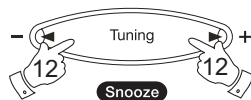

- If you make an error use the **Back** button to delete the character entered.

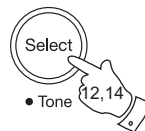

- After the final character of the WEP or WPA key has been entered, centrally locate the 'END' symbol and press the **Select** button. Alternatively the 'END' symbol can be quickly accessed by pressing the **Add/RDS** button. The clock radio should now be able to connect to the network.



- Once your clock radio is connected to the network (and therefore also to the Internet) it will display the time and the main Mode menu. This menu provides access to all major functions of the radio. The time is obtained from the internet by the radio. If the time display is not correct for any reason, it can easily be adjusted later, see page 40 'Manually setting the clock'.

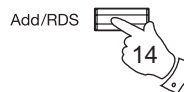

Internet Radio mode

Internet Radio - the basics

Before you can use your clock radio to listen to broadcasts via the internet, it is necessary to have already connected your clock radio to your computer network using the wireless (WiFi) connection. Please see page 9 for details.

There are literally many thousands of broadcasts available via the internet. Your clock radio provides several ways of searching for broadcasts in order to make finding and choosing broadcasts easier. Once you have found radio stations which you like, you may either store them as presets within the clock radio, or add them to a list of your favourite stations which your clock radio can access. The number of presets is limited (there are ten preset buttons on the clock radio), but you can store as many favourites as you like.

You may search for an internet radio station by Location. If you know the name of the station and the country from which a station is broadcast this may be the easiest method to find a station. It is also a great way to experience radio from other parts of the world.

You may also search for an internet radio station by Genre. If you prefer a particular type of music, Blues for example, you may search for a radio station that broadcasts that type of music, and you can see a list of Blues radio stations regardless of location, or taking location into account.

If you know part of the name of an internet radio station, you can enter it into the radio and it will search for stations that match that name. This can be helpful if you are unsure of the location or genre of a particular station.

The **STREAMTIME** clock radio connects to a radio station database which serves many users in many countries. This means that there is a very wide range of programme content available.

Operating your radio - Internet Radio

Selecting a radio station by location

1. Press the **On/Off** button to switch the clock radio on.
2. Repeatedly press the **Band** button until 'Internet Radio' appears on the display.
3. Your clock radio will enter the main Internet Radio menu.
4. Press the **Tuning Up** or **Down** buttons until 'Location' shows on the display. Press the **Select** button. The first continent in the list will be shown.
5. Press the **Tuning Up** or **Down** buttons to scroll through the list of continents. When the desired continent is shown on the display press the **Select** button.
6. The display will show the list of countries within the chosen continent and the number of available stations for that country. If there are many countries you can scroll through the list continually in either direction. This menu is cyclic (so you can go back through the list to quickly access the UK, for example). Press the **Select** button to choose the desired country.
7. The lists are always sorted alphabetically.

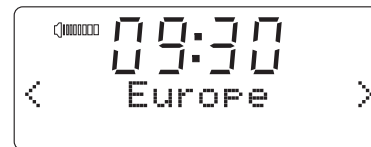
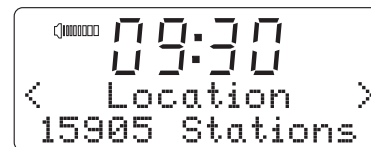
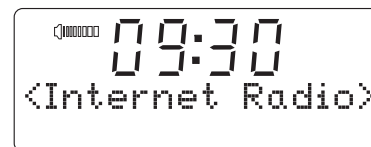
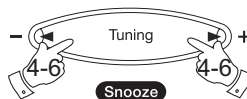
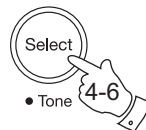
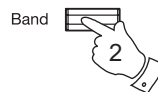
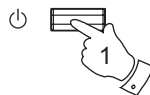

- Press the **Tuning Up** or **Down** buttons to display your chosen radio station and then press the **Select** button to confirm. The display will show 'Connecting' while it finds the new station.
- If the station has on-demand content (that is, it gives the option of listening to programmes which have already been broadcast), see page 17 'Listening to previously broadcast material'.

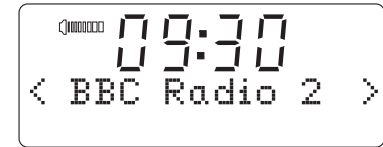
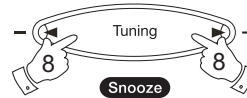

If your clock radio cannot connect to a radio station

Note: If your clock radio is unable to connect to an internet radio station it will generally either display 'Network Error' or 'Stopped'. This can be for many reasons, but typically will be due to one of the following:

- The radio station may not be broadcasting at the present time.

- The radio station may not be able to accommodate any more connections from internet listeners.

- There may be network congestion (either locally or at a distance) which is affecting the reliability of the connection.

If your radio can connect, but the audio is not continuous and the radio keeps having to reconnect, this may be due to the radio station only having limited connection capacity.

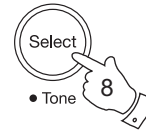

Please also refer to the section Troubleshooting on page 61.

Selecting a radio station by genre

1. Press the **On/Off** button to switch the clock radio on.
2. Repeatedly press the **Band** button until 'Internet Radio' appears on the display.
3. Your clock radio will enter the main Internet Radio menu.
4. Press the **Tuning Up** or **Down** buttons until 'Genre' shows on the display. Press the **Select** button.
5. Press the **Tuning Up** or **Down** buttons to scroll through the list of content types. This menu is normally cyclic - you can scroll the list continually in either direction. When the chosen genre is shown on the display press the **Select** button.
6. The first radio station in the list is then shown. Press the **Tuning Up** or **Down** buttons until the desired station name is displayed.
7. Press the **Select** button to select the station. The display will show 'Connecting' while it finds the new station. If the radio station is unable to connect this may be for one of the reasons explained on page 14.
8. If the station has on-demand content (that is, it gives the option of listening to programmes which have already been broadcast), see page 17 'Listening to previously broadcast material'.

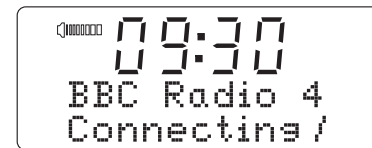
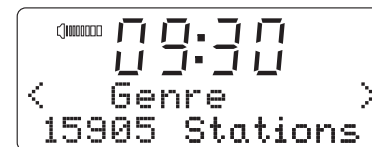
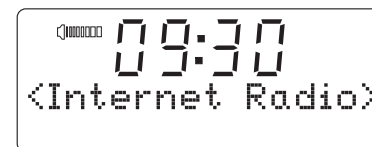
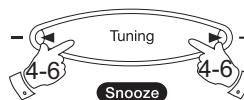
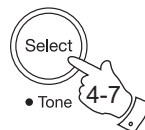
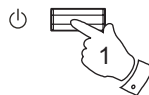

Searching for a radio station by name

There may be occasions when you know the name of a radio station but you do not know the location or genre. This facility allows you to search for the station using a part (or parts) of the radio station name.

1. Press the **On/Off** button to switch the clock radio on.
2. Repeatedly press the **Band** button until 'Internet Radio' appears on the display.
3. Your clock radio will enter the main Internet Radio menu.
4. Press the **Tuning Up or Down** buttons until 'Search' shows on the display. Press the **Select** button.
5. To enter the search word(s) press the **Tuning Up or Down** buttons to display each character for the search in turn, when the character is central on the display press the **Select** button to enter it. If you make an error press the **Back** button to delete the character. After the final character of the search has been entered, use the **Tuning Up or Down** buttons to centrally locate the 'END' symbol on the screen and then press the **Select** button to finish. Alternatively the 'END' symbol can be quickly accessed by pressing the **Add/RDS** button.
6. The radio will search for radio stations that match your search data. If you include a space between two search items the radio will look for station names which include both items. Thus a search for 'ROCK 100' could find a station called '100 Classic Rock Hits' as well as a station called '100.FM Rocks'
7. Press the **Tuning Up or Down** buttons to select the station that you wish to listen to and press the **Select** button to confirm your choice. The display will show 'Connecting...' while it finds the new station.

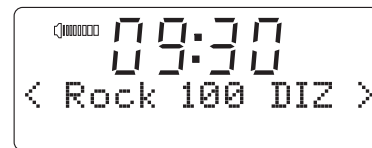
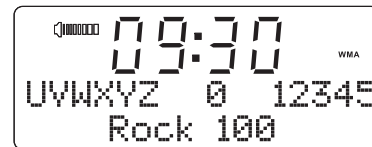
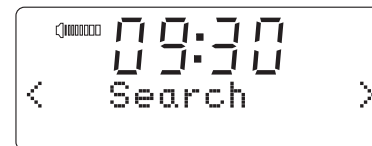
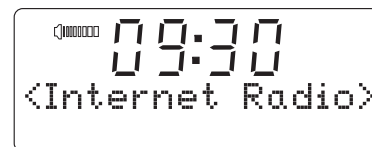
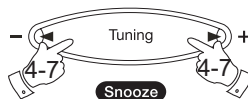
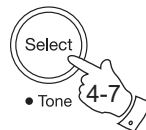
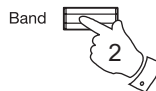
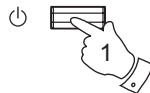

Listening to previously broadcast material

Some radio stations allow you listen to programmes that have already been broadcast. When you select a radio station that has this facility, the station does not start playing immediately, but instead the display shows the options 'Live' and 'On Demand'.

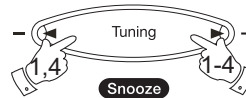

1. Press the **Tuning Up** or **Down** buttons to highlight 'Live' or 'On Demand'.
2. Press and release the **Select** button to select:
 - 'Live' - plays the current output from the station as normal.
 - 'On Demand' - lets you listen to previous broadcasts.

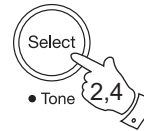

The options will depend on the station you have chosen.

3. When you choose 'On Demand', the display shows the names of the programmes available.
4. Press the **Tuning Up** or **Down** buttons to display the programme that you wish to listen to. Press the **Select** button to select the programme.
5. When you have chosen the programme you want to listen to, either it will start to play, or the display may show a list of days for you to choose from, or it may show you a playback start time of 00:00:00. Note that this is not the time that the original broadcast took place. It is the time after the start of the programme from which the radio will start playing. If a start time is displayed, skip to step 7 on the next page.

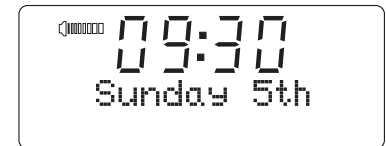
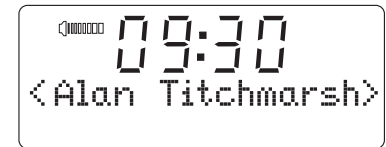
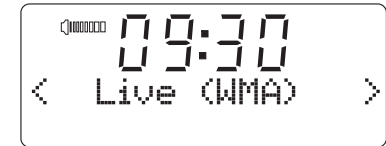
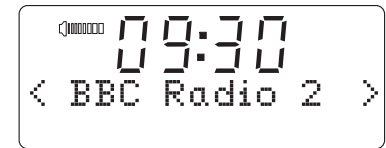

- Press the **Tuning Up** or **Down** buttons to select the day the programme was broadcast. Press the **Select** button to choose the day. The display will then show a programme start time of 00:00:00.
- To listen from the beginning of the programme, press the **Select** button again. Alternatively, Press the **Tuning Up** or **Down** buttons to choose the required start time and then press the **Select** button to start the programme playing.

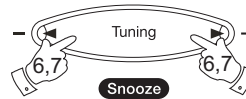

Fast-forward / Rewind broadcasts

Stations which enable you to listen to previously broadcast programmes also allow you to fast-forward and rewind to any point within the programme.

- Press the **Fast-forward** button the elapsed time that the programme has been playing will be displayed and will automatically advance in 30 second increments.
- When the required time into the programme is reached, press the **Select** button.
- Press the **Rewind** button the elapsed time that the programme has been playing will be displayed and will automatically count back in 30 second increments.
- When the required time into the programme is reached, press the **Select** button and the programme will resume from that point.

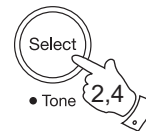
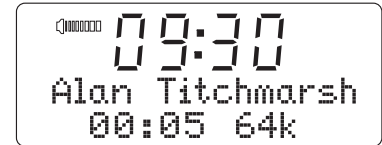
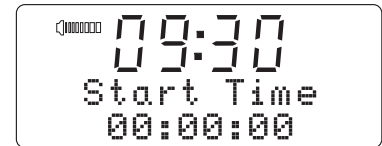
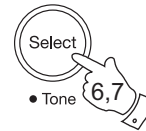

Play / Pause function

When listening to previously broadcast material, it is possible to temporarily pause the programme if needed.

- To pause playback press the **Play/Pause** button. To resume playback press the **Play/Pause** button again.



Customising your clock radio

In addition to storing your favourite radio stations in the radio presets, your radio allows you to create a customised list of stations which can appear in a special menu on the radio called 'My Stuff'.

The **STREAMTIME** uses Internet Radio technology which has been developed by a British company, Reciva Limited, based near Cambridge. Reciva allow you to register your clock radio on their web site, and then to associate a choice of radio stations with your clock radio. These stations can be selected from the large selection already listed. Additionally, if you find a radio station that is not listed then you may also add the Internet address (URL) of the station's audio stream to your selection.

Registering an account on Reciva's website

1. Open the website, <http://radios.reciva.com>, using the Internet browser on your computer. Follow the registration process as described on the site:

Select Settings from the radios menu.

Select Register - the radio will then fetch a registration number

Enter the registration number into the space on the web page

Click on the Submit button.

The next page will ask you to enter a username, password and email address (or just username and password if you have previously registered a radio and wish to add another).

2. To configure your radio, you may need to log in to Reciva's website using your username and password - using your internet browser, go to <http://radios.reciva.com>. You can then choose '**Manage My Stuff**' to be able to edit your stored details for '**My Stations**' and '**My Streams**' - see the following pages in this book. The option '**Manage My Radios**' allows you to add additional radios or remove any of those already registered.

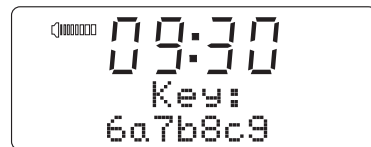
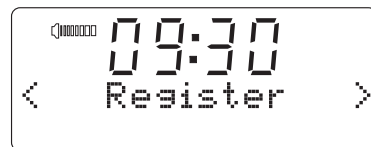

Configuring My Stations

1. Using Reciva's website at <http://radios.reciva.com>, it is possible to search for radio stations that are available in Reciva's stations database. Whenever stations are searched for on the website, they will be displayed in a list of search results together with a link to **Add to My Stations**.
2. Clicking on the **Add to My Stations** link, will add the station to your account's **My Stations** list. This list can be edited by clicking on **My Stations** under the **My Account** section on the website.
3. Once you have Internet stations available in your **My Stations** list, you may play these stations from your Internet Radio. These stations will be available on your radio from the main mode menu item: 'My Stuff > My Stations'.

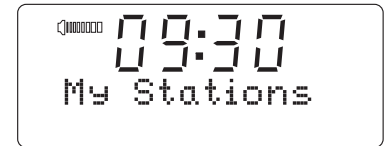
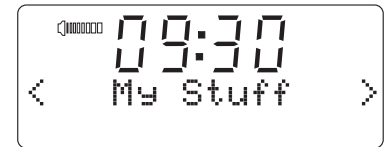

Please note, the **My Stuff** menu item and your personal selection of radio stations (**My Stations**) will only be available on your clock radio once your clock radio has downloaded a new radio stations list. To cause the radio to download a new list of stations immediately, please remove and reconnect the power to your clock radio.

If a radio station is not listed

1. If you want to listen to a particular radio station which is currently not listed in your radio or on Reciva's web site, you can enter a request for them to add the radio station to their database.

Adding stations using your clock radio

If you find a radio station that you like to listen to frequently this may be stored in the My Stations list as described on page 20. That method requires you to use a computer. Once your radio has been registered using the Reciva website page 19 it is also then possible to add stations to the 'My Stations' list directly from the radio by following this simple procedure.

1. Switch on your clock radio and select the 'Internet Radio' mode. Connect the clock radio to the desired radio station using one of the searching methods previously described (searching by Location, Genre, etc).
2. With the chosen radio station playing, press the **Add/RDS** button. The radio will then fetch a menu from Reciva's servers. If the currently playing station is not already in your My Stations selection, then the radio will display 'Add to My Stations'.
3. Press the **Select** button to cause the currently playing radio station to be added to your My Stations selection. The radio will briefly display 'Adding..' followed by ' Station added to My Stations'. You may then choose the radio station using the My Stuff and My Stations menu options on the radio.
4. In order to remove a station from My Stations, you can either use a computer to access Reciva's web site, or once listening to the station press the **Add/RDS** button. The radio will then fetch a menu. Since the station is already stored, the menu will display 'Delete from My Stations'.
5. Press the **Select** button to the cause currently playing radio station to be deleted from your My Stations menu. The radio will briefly display 'Deleting...' followed by 'Deleted from My Stations'.
6. As an alternative to pressing the Select button in steps 3 or 5 to add or delete, the radio may offer additional menu options. For example, pressing the Tuning Up or Down buttons may display 'More Stations like this'. Pressing Select will then allow some additional selection options allowing the possibility of choosing stations of similar style or content, or perhaps from the same location. These menus may be navigated using the Tuning Up and Down buttons in conjunction with the Select and Back buttons, in the normal way. Please note that this menu is flexible and is not directly under Roberts control. Features may be added or changed in the future.

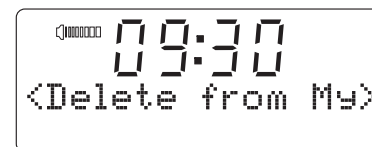
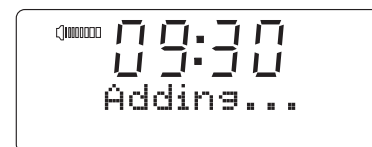
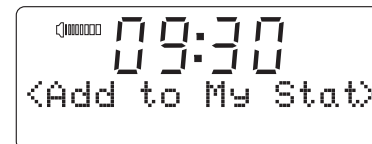
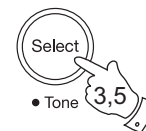
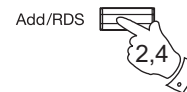

Configuring My Streams

1. Once logged into your Reciva website account, you can add your own Internet radio streams to the **My Streams** section, which is listed under the **My Account** section. Typically, these will be Internet radio stations that you will have found using your computer.
2. Clicking on **My Streams** will prompt you to enter the station's name and its media stream URL. The media stream URL should be a link to a website's actual audio stream. If you have any doubt about locating the media stream URL from a webpage, then please refer to the FAQs section on Reciva's website, <http://radios.reciva.com>.
3. Once you have Internet radio streams available in your **My Streams** list, you may play these stations from your Internet Radio. These stations will be available on your radio from the main mode menu item: 'My Stuff > My Streams'.

Please note, the **My Stuff** menu item and your personal selection of radio streams (**My Streams**) will only be available on your radio once your clock radio has downloaded a new radio stations list. To cause the clock radio to download a new list of stations immediately, please remove and reconnect the power to your clock radio.

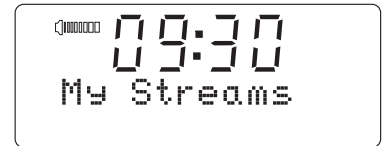
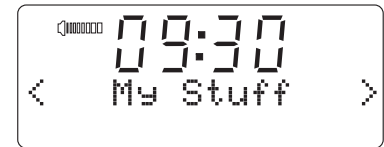

Media Player

The Media Player allows you to play audio files which are stored on a computer on your network. Supported file formats are MP3, WMA, AAC, WAV, FLAC, AIFF, Real Audio, AU and playlists (M3U). Note that the playback of DRM protected content is not supported.

Your radio supports two file access methods. It can connect to folders shared on the network, commonly known as Windows Shares, SMB shares or CIFS. It can also connect with file server applications using the Universal Plug and Play (UPnP) protocol.

All of the supported file types are playable in Windows Shares mode. When using a UPnP server, the playable file types are dependant on the server software used. For example, Microsoft Windows Media Player 11 can serve MP3, WMA and WAV files. To be able to play the other supported file types via UPnP you may need to install additional third-party software.

When using Windows Shares, music selection is by Artist, by Album and optionally by track within an Album. When using a UPnP server, the search and selection criteria are determined by the server, but typically include additional options such as Genre. Many server applications also allow you to access files according to the folders within which they are stored.

Note that the references to 'PC' in this section refer to any computer device that may be sharing content on your network, whether it is a Windows device, an Apple computer, a Linux device, or any other. We use the generic term 'PC' simply because it is short and convenient.

Using Windows Shares

Setting up your Windows PC to allow the clock radio to access your audio files via Windows Shares. If you wish to use UPnP, please turn to page 26.

1. Please ensure that your PC is available on the same network as your Internet radio. Using Windows Explorer, locate the folder where your audio files are stored.
2. Right click on the folder.
3. Select 'Properties'.
4. Click on 'Sharing'.
5. Select 'Share this folder on the network' and 'Allow network users to change my files'.

Please note, do not try to make your 'My Documents' or any of its sub-folders (e.g. 'My Music') shareable.

Please note, it is recommended that you do not try to make your 'My Documents' or any of its sub-folders (e.g. 'My Music') accessible as shares. This is because of the way that these special folders are managed within Windows.

In some cases, especially if you have a Windows PC using third-party security software (not supplied by Microsoft) it may be necessary to configure your computer's firewall software and / or network settings to permit file sharing. If this is necessary please refer to your computers software documentation for further information.

Locate the shared audio files using the clock radio

1. Press the **On/Off** button to switch the clock radio on. Then press the **Band** button until 'Media Player' shows on the display.
2. Your clock radio will enter Media Player menu.
3. Press the **Tuning Up** or **Down** buttons until 'Windows Shares' is displayed, then press the **Select** button.
4. Press the **Tuning Up** or **Down** buttons until 'Scan for PCs' is displayed and press the **Select** button again.
5. The radio will now display 'Finding PCs'. If any PCs are sharing folders on the network they will be shown. When the search is complete, press the **Tuning Up** or **Down** buttons to display the PC which is sharing your files. If your PC does not appear, check its file sharing and firewall settings.
6. Press the **Select** button. The radio will then search the selected PC for shared folders. If the PC's security settings require it, the clock radio may ask for a user name and password. Enter these according to your PC's settings.
7. Press the **Tuning Up** or **Down** buttons until the correct shared folder is displayed and press the **Select** button to confirm the selection.
8. The radio will display 'File Scan' as it scans through the media files in the shared folder. The bottom row of the display will show some file or folder names to indicate that the file scan is in progress. If you have a large number of audio files this could take several minutes to complete.

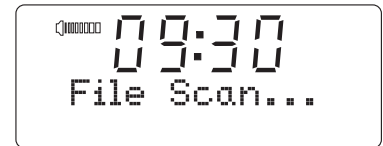
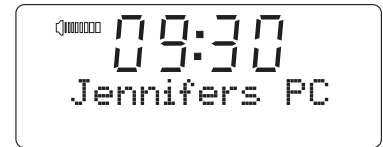
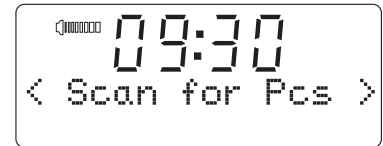
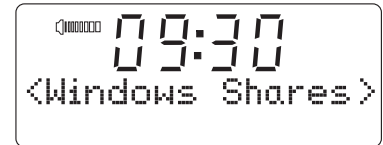
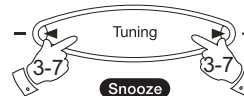
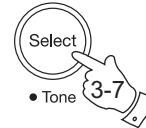
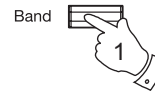
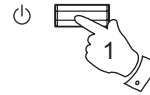

9. Once the clock radio has finished scanning, it will display 'By Album', 'By Artist', etc. Use the **Tuning Up** or **Down** buttons to scroll through the scanned media files, which will now be organised 'By Album', 'By Artist' and 'Playlists' – if available.

Note that the first time the file scan is performed, a file called '.reciva_media_cache' is written to the folder where the audio files are stored. This file is created by the scanning software in order to speed up subsequent file scans.

In the event that your radio cannot connect to your PC or its shared folders it is most likely that your PC's firewall software is blocking access (see the section 'Troubleshooting' on page 61).

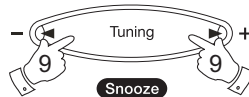

Accessing your audio files via a UPnP server

The recommended way to access your media files is via a UPnP server application. This method offers normally simpler set up and superior file searching compared to the Shared Folders method.

If your computer is running Windows (XP or Vista), then Windows Media Player version 11 includes a UPnP server which will make your files available to your radio. There are other UPnP server solutions available for Windows users who may wish to use an alternative.

If you use an Apple computer running a version of OS X then you may use a third party UPnP server application. Examples include EyeConnect and Twonky Media Server.

If you use a version of the Linux operating system, there are a range of UPnP server applications available.

It is beyond the scope of this instruction book to cover all possible options for UPnP. We explain the use of Microsoft's Windows Media Player since that will be the first choice for the majority of users.

Set up UPnP access on a Windows PC

1. If your PC is running Microsoft Windows XP or Windows Vista then you can use Microsoft's Windows Media Player version 11 to act as your UPnP (Universal Plug and Play) media server. If not already installed on your PC, Windows Media Player 11 may be downloaded from Microsoft's web site and installed by following the instructions detailed in its installation wizard, or by using Microsoft's Windows Update facility.
2. Once installed, Windows Media Player 11 can create a library from all the media files available to it on your PC. To add new media files to the library, select 'File > Add to Library... > Advanced Options', click 'Add' and choose the files you wish to add and click 'OK'.

Selecting Media Sharing in Windows Media Player 11

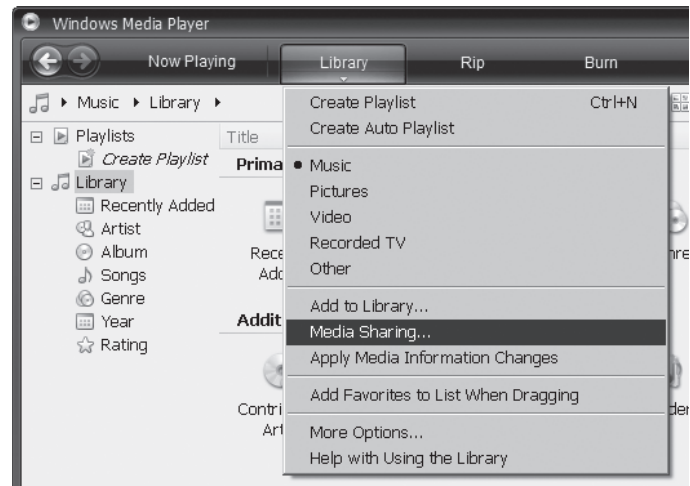

Set up UPnP access on a Windows PC - cont.

You will now need to connect your Internet clock radio to Windows Media Player 11 and configure it to allow access to your media library.

1. Press the **On/Off** button to switch the radio on. Then press the **Band** button as needed until the Media Player' mode display is shown. Your clock radio will enter the main Media Player menu.
2. Press the **Tuning Up** or **Down** buttons until 'UPnP Servers' is displayed and press the **Select** button. The radio will scan for all available UPnP servers. It may take a few seconds for the radio to complete its scan. The radio will display '<Empty>' if no UPnP servers are found.
3. After scanning, select your UPnP server using the **Tuning Up** or **Down** buttons. If you are using WMP 11 as the server, your radio will then normally display 'Unauthorised - Select to retry' at this stage.
4. Your PC may prompt you that there has been a connection to your UPnP server. Whether prompted or not, to allow the radio to access the media files, you will need to click the 'Library' tab in WMP 11 and select the 'Media Sharing...' item to open the 'Media Sharing' window. Make sure the box 'Share my media to:' is ticked.
5. In the 'Media Sharing' window, the radio will be listed as an unknown device. Click on the unknown device shown to select it, then click the 'Allow' button and then click 'OK'.

Note: If you are using Microsoft Windows' firewall software, this should be correctly configured by WMP 11. If you are using third party firewall software you may need to manually configure it to allow your radio and WMP 11 to communicate (see 'Troubleshooting' on page 61).

6. On the clock radio, select the named server again using the **Select** button. If WMP 11 is now able to communicate with your radio you will be presented with some media selection options on the display.

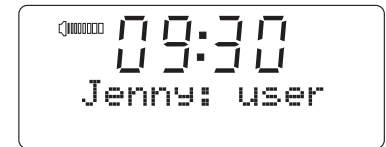
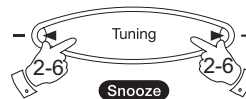
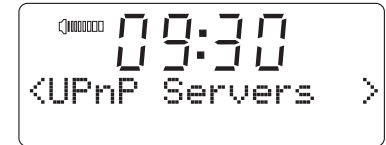
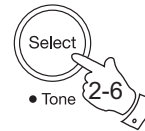
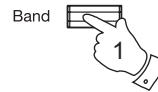

Allowing a device to connect to Windows Media Player 11

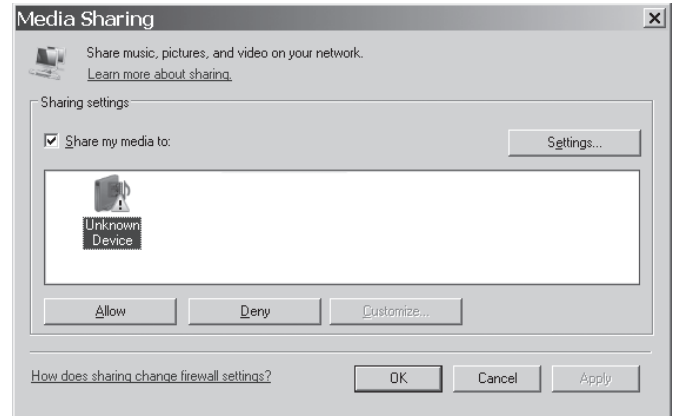

Locating and playing media files when using UPnP

Once the UPnP server has been configured to share media files with your Internet clock radio, you select the files that you wish to play as follows:-

1. Press the **On/Off** button to switch on your clock radio. Then press the **Band** button until 'Media Player' shows on the display.
2. Your clock radio will enter the media player menu.
3. Press the **Tuning Up** or **Down** buttons until 'UPnP Servers' is displayed, then press the **Select** button.
4. The clock radio will scan for all available UPnP servers. Note that it may take a few seconds for the radio to complete its scan, and that before the scan has completed the radio may display 'Empty'. The radio will continue to display 'Empty' if no UPnP servers are found.
5. After a successful scan, press **Tuning Up** or **Down** buttons to display your UPnP server and then press the **Select** button. If the display shows multiple media types, select 'Music'. (Some UPnP servers can serve pictures and video content to suitable devices.)
6. The radio will now list the media categories which are made available by the UPnP server - for example, 'Album', 'Artist' and 'Genre'. Press the **Tuning Up** or **Down** buttons to display which category you wish to browse, then press the **Select** button to confirm your choice.
7. Press the **Tuning Up** or **Down** buttons to display a category and press the **Select** button again. For example, you could select 'Music' and then select 'Albums'.

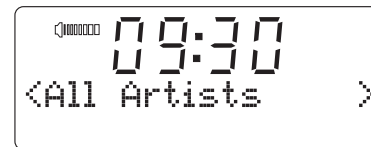
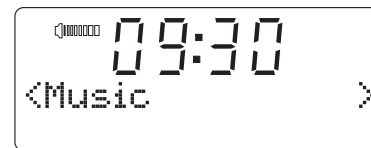
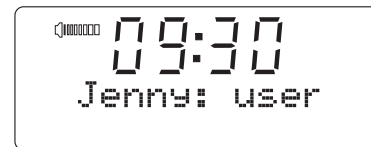
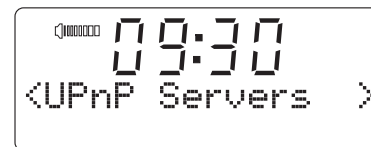
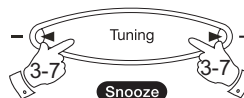
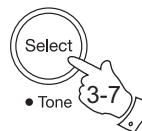
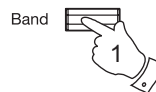
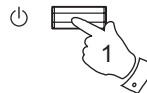

- Press the **Tuning Up** or **Down** buttons to highlight the media files that you wish to play and then press the **Select** button.

Note:

Do not worry if not all of your media appear in the menus immediately. Windows Media Player needs to look inside each file to identify the artist, album and track information from 'tags' embedded in each file. Additionally, Windows Media Player may take time to access the Internet to obtain additional information such as 'album art' which it can display when you examine your music library on your PC.

In UPnP mode the search criteria offered and the file types made available to the clock radio are a function of the UPnP server software installed on your PC. Such software can vary quite widely in its capabilities. Windows Media Player 11 has limited flexibility compared to some UPnP servers, but is generally easy to set up and reliable.

Some third party server applications allow customisation of the search criteria and indexing methods, which can be useful if you have a very large collection of stored music files.

Many UPnP server applications are also capable of sharing pictures and video files to other network connected devices. If this is the case (as it is with Windows Media Player 11) you may see the option of choosing between 'Music', 'Video' and 'Pictures' on your radios menu. Clearly you should only select the 'Music' option. Content offered via the alternative options will not be playable on your clock radio.

- The clock radio will display '[Add to Queue]'. Press the **Select** button and the clock radio will add all the tracks in the album to its queue and begin playing them automatically.

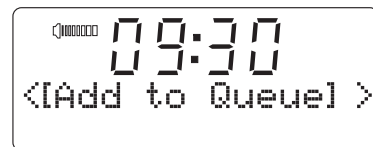
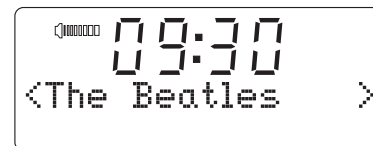
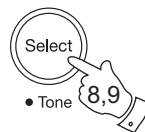
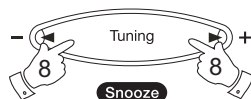

Media selection

Whether you access your files using Windows Shares or using UPnP, the file selection mechanisms are the same. The only difference between the two methods is that when using UPnP you will generally have a wider choice of search criteria, as determined by the UPnP server software on your computer. Some third party server applications allow customisation of the search criteria and indexing methods, which can be useful if you have a very large collection of stored music files.

The selection mechanism allows you to search by a given information type (Album, Artist, etc.) and then to narrow the search, either just to an album or to a particular track within an album. The selected album or track is then added to a queue of tracks to be played. You can add more albums or tracks to the queue while music is playing, or you can jump between tracks in the queue. You can also clear the queue if you wish to make a fresh selection. The searches described here are examples of the possibilities available.

Listening to a complete album

1. Press the **Tuning Up** or **Down** buttons until 'All Artists' is displayed. Press the **Select** button.
2. Press the **Tuning Up** or **Down** buttons until the required artist is displayed. Press the **Select** button.
3. Press the **Tuning Up** or **Down** buttons until the required album name is displayed. Press the **Select** button. '[Add to Queue]' will show on the display.
4. Press the **Select** button. The album will begin playing and all of the tracks in the album will be stored in the queue.

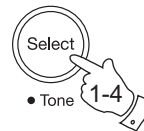
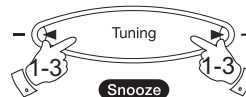

Media Player

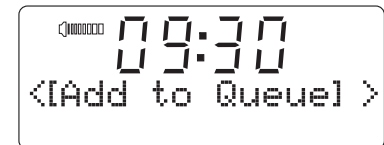
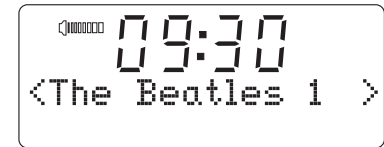
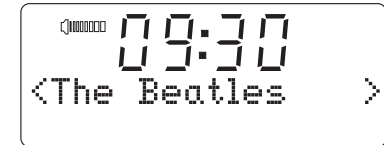
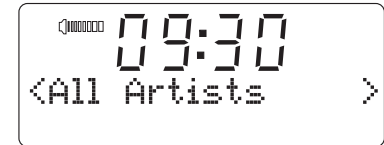
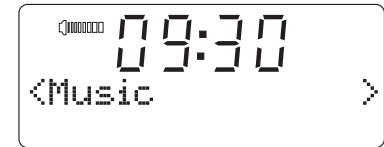

Listening to a single track

1. If you wish to play only a particular track from an album, first choose the album as described in steps 1 - 3 on the preceding page (section 'Listening to a complete album').
2. '[Add to Queue]' will show on the display at the head of a list of tracks.
3. Press the **Tuning Up** or **Down** button until the required track is displayed.
4. Press and release the **Select** button. The track will begin playing.

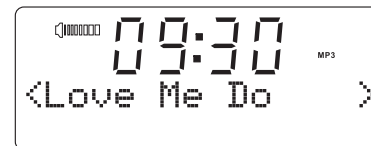
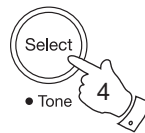
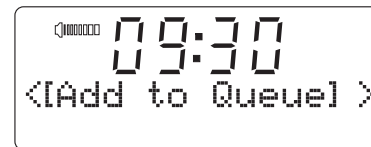
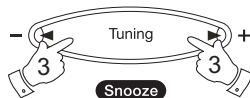

Queuing up albums for playback later

While the Media Player is playing, you may add additional albums or tracks to the media queue.

1. Use the **Tuning Up** or **Down** buttons (with the **back** button as needed) to search for and display the required album.
2. Press the **Select** button to choose the album. The list of tracks for the album will be displayed, headed by '[Add to Queue]'.
3. If needed, press the **Tuning Up** or **Down** buttons so that '[Add to Queue]' is displayed. Press and release the **Select** button. 'Tracks Added to Queue' will be displayed.

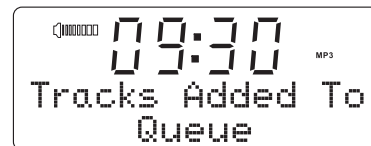
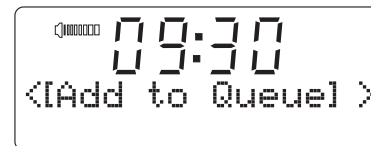
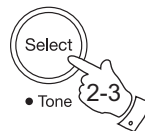
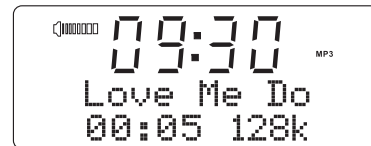
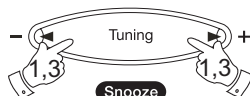

Queuing up tracks for playback later

1. If you wish to add only particular tracks from an album to the queue, first choose the album as described in steps 1 - 3 on the preceding page (section 'Queuing up albums for playback later').
2. Use the **Tuning Up** or **Down** buttons to search for and display the required track.
3. Press the **Select** button. 'Tracks Added To Queue' will show on the display.

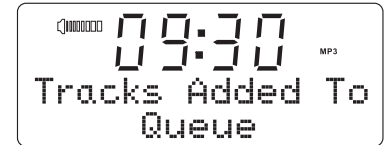
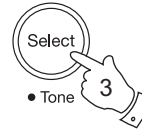
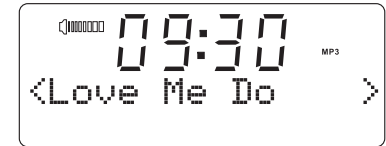
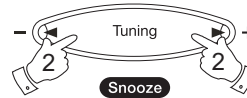

Controlling playback

1. **Press and release** the **Play / Pause** button to pause playback of the current track.
If you press and release the button again, playback will resume from the point where it was paused.
2. Press the **Rewind** button to start playback of the previous track in the queue.
3. Press the **Fast-forward** button to start playback of the next track in the queue.

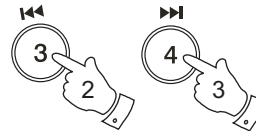

Browsing the list of tracks currently queued up for playback

1. Press the **Queue** button. The currently playing track name will be displayed, along with its position in the queue.
2. Use the **Rewind** or **Fast Forward** buttons to see which tracks are queued up for playback.
3. If you want to jump to a particular track in the queue, press the **Select** button when the required track is displayed. Playback will then continue from the beginning of that track.

Clearing the media player queue

1. When the clock radio is playing repeatedly press the **Back** button to access the Main mode menu.
2. Press the **Tuning Up** or **Down** buttons until 'Media Player' is highlighted on the display then press the **Select** button to enter the Media Player menu.
3. Press the **Tuning Up** or **Down** buttons until 'Clear Queue' is displayed. Press the **Select** button the display will then show 'Queue Cleared' and all tracks will be erased from the media queue.
4. Alternatively, a **long press** of the **Queue** button can be used to clear the queue from any point in the Media Player without any need to navigate the menus. 'Queue cleared' and all tracks will be erased from the media queue.

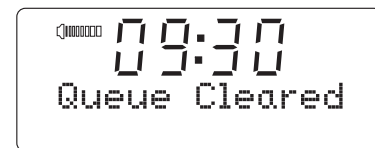
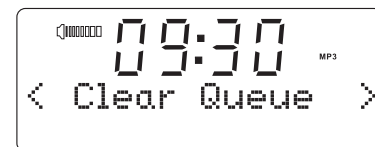
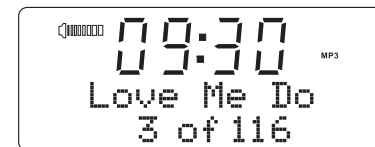
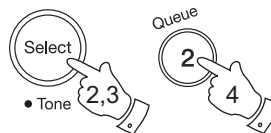
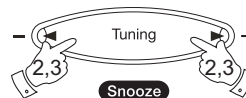
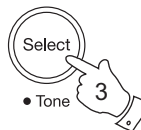
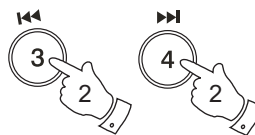
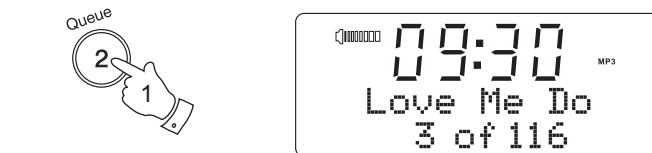

Playing tracks in the queue repeatedly

- When the clock radio is playing press the **Back** button to access the main Mode menu.
 - Press the **Tuning Up** or **Down** buttons until 'Media Player' is highlighted on the display then press the **Select** button to enter the Media Player menu.
 - Press the **Tuning Up** or **Down** buttons until 'Playback Mode' is displayed then press the **Select** button.
 - Press the **Tuning Up** or **Down** buttons until 'Repeat' is highlighted. Press and release the **Select** button. The display will show 'Enable' with a YES / NO option.
 - Press the **Tuning Up** or **Down** buttons to select 'YES', then press the **Select** button to confirm that Repeat mode should be enabled. The repeat indicator will show on the display. If you do not wish to enable Repeat mode select 'NO'.
- If Repeat mode has previously been enabled, then the display will show 'Disable' with a YES / NO option after step 4. Select 'YES' to cancel Repeat mode.
- Alternatively when the clock radio is playing press and release the **Preset 1 / Playmode** button. Press this button until the display shows 'Repeat (ON)'. The repeat indicator will show on the display.
 - To disable the Repeat mode repeatedly press the **Preset 1 / Playmode** button until the display shows 'Repeat (OFF)'. The indicator will be removed from the display.

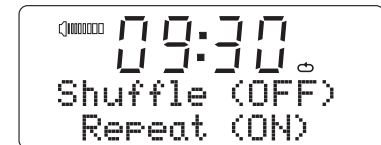
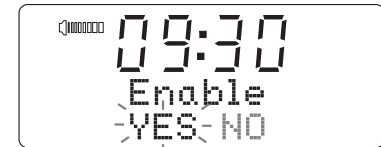
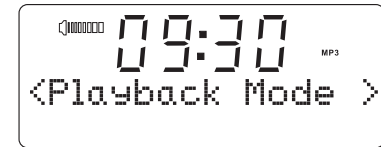
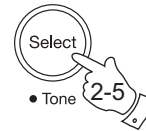
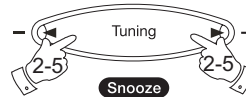

Playing tracks in random order

1. When the clock radio is playing press the **Back** button to access the main Mode menu.
2. Press the **Tuning Up** or **Down** buttons until 'Media Player' is highlighted on the display then press the **Select** button to enter the Media Player menu.
3. Press the **Tuning Up** or **Down** buttons until 'Playback Mode' is displayed then press the **Select** button.
4. Press the **Tuning Up** or **Down** buttons until 'Shuffle' is displayed. Press and release the **Select** button. The display will show 'Enable' with a YES / NO option.
5. Press the **Tuning Up** or **Down** buttons to select 'YES', then press the **Select** button to confirm that Shuffle mode should be enabled. If you do not wish to enable Shuffle mode select 'NO'.

If Shuffle mode has previously been enabled, then the display will show 'Disable' with a YES / NO option after step 4. Select 'YES' to cancel shuffle mode.

6. Alternatively when the clock radio is playing press and release the **Preset 1 / Playmode** button. Press this button until the display shows 'Shuffle (ON)'. Press this button until the display shows 'Shuffle (ON)'. Press this button until the display shows 'Shuffle (ON)'.
7. To disable the Shuffle mode repeatedly press the **Preset 1 / Playmode** button until the display shows 'Shuffle (OFF)'.

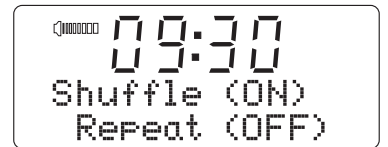
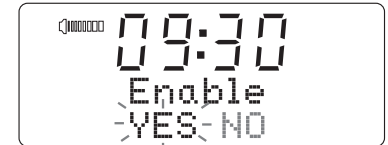
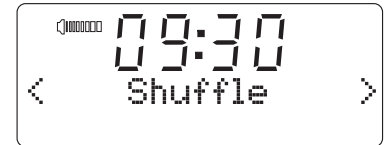
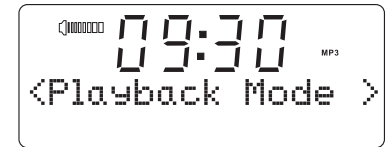
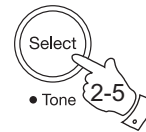
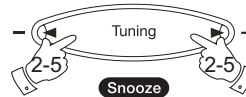

Operating your radio - FM

1. Carefully extend the wire aerial and press the **On/Off** button to switch on your clock radio.
2. Press the **Band** button as needed to select the FM mode display.
3. Press and hold the **Tuning Up** button. The displayed frequency will increase. Your radio will scan up the FM band from the currently displayed frequency and will stop scanning when it finds a station of sufficient strength.
4. The display will show the frequency of the signal which has been found. If RDS information is available, after a few seconds the display will show the radio station name.
If you only hear hiss or interference, simply press the **Tuning Up** button to scan further. Your radio may have found a spurious interference signal.
5. To find more FM stations press the **Tuning Up** button to repeat the scan operation. To scan down in frequency, press and hold the **Tuning Down** button. Your radio will scan down the FM band from the currently displayed frequency and will stop scanning when it finds a signal of sufficient strength.
6. When the end of the waveband is reached your radio will recommence tuning from the opposite end of the waveband.
7. Use the **Volume** buttons to adjust the sound level as needed.

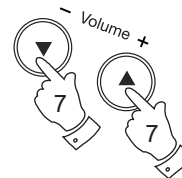
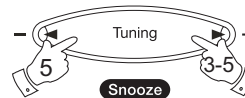
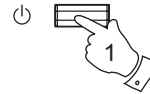

FM Radio

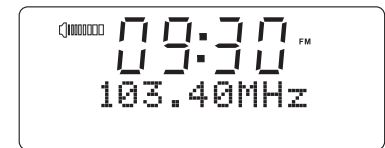
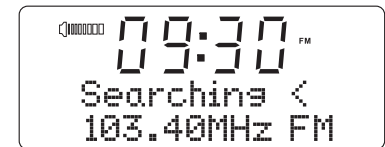
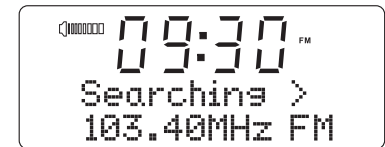

Manual tuning - FM

1. Carefully extend the wire aerial and press the **On/Off** button to switch on your clock radio.
2. Press the **Band** button as needed to select the FM mode display.
3. Press the **Tuning Up** or **Down** buttons to control the frequency that the radio will tune to. The frequency will change in steps of 50kHz. When the end of the waveband is reached the radio will recommence tuning from the opposite end of the waveband.
4. Use the **Volume** buttons to adjust the sound level as needed.
5. To switch off your radio press the **On/Off** button.

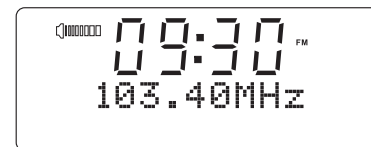
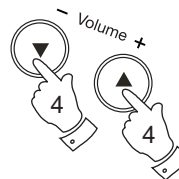
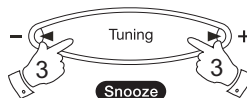
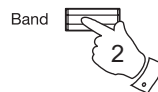
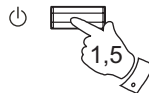

Display modes - FM

Your radio has a range of display options when in FM mode:-

1. Press the **RDS** button to cycle through the different options.
 - a. Text Displays text messages such as the artist or track name, phone in number, traffic alerts, etc.
 - b. Program Type Displays the type of station being listened to such as Pop, Classic, News etc.
 - c. Frequency Displays the frequency of the FM signal.

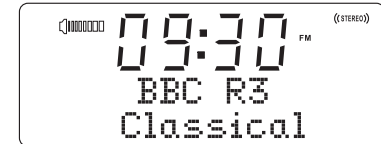
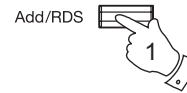

Note: If no RDS information is available, then the radio will only be able to display the frequency. There will be no text or programme type information available under these conditions.

The radio only provides displays when there is information available. So if there is no text, for example, that display is not available.

Presetting stations

There are 5 memory presets each for FM and internet radio. They are used in the same way for each operating mode.

1. Press the **On/Off** button to switch on your clock radio.
2. Tune to the required radio station as previously described.
3. Press and hold down the required **Preset** button until the display shows e.g. Assigned to Preset 2. The station will be stored under the chosen preset button. Repeat this procedure for the remaining presets.
4. Stations stored in preset memories may be overwritten by following the above procedure.

Note: All the radio station presets are preserved in memory when the radio is switched off.

Recalling a preset station - FM and internet radio

1. Press the **On/Off** button to switch on your radio.
2. Select the required waveband by pressing the **Band** button.
3. Momentarily press the required **Preset** button, your radio will tune to the station stored in preset memory.

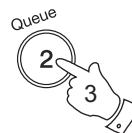
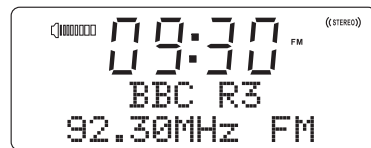
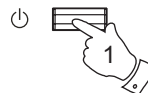
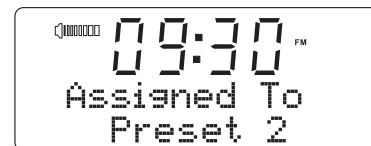
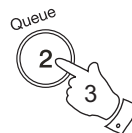
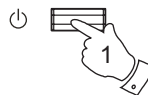

Manually setting the clock

Normally the **STREAMTIME** Internet clock radio will set its clock automatically to UK time after a connection to the Internet has been established. Should you need to set the time manually, please follow this procedure.

1. Press the **On/Off** button to switch the clock radio on.
2. Press and hold the **Clock Set/Sleep** button. 'Set Time/Date' will show on the display. Press the **Select** button to enter the clock setup menu. The hour digits will flash.
3. Press the **Tuning Up** or **Down** buttons to set the correct hour. Press the **Select** button the minute digits will flash.
4. Press the **Tuning Up** or **Down** buttons to set the correct minutes. Press the **Select** button the day digits will flash.
5. Press the **Tuning Up** or **Down** buttons to set the day. Press the **Select** button the month digits will flash.
6. Press the **Tuning Up** or **Down** buttons to set the correct month. Press the **Select** button the year digits will flash.

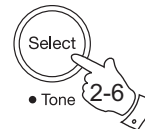
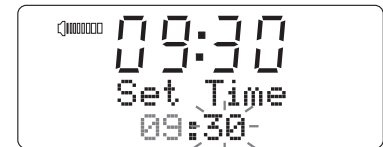
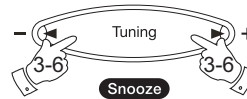
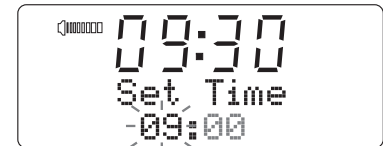
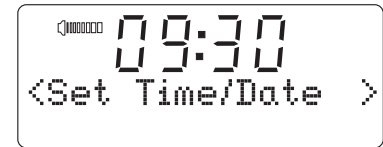
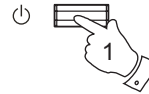

- Press the **Tuning Up** or **Down** buttons to set the correct year.
- Press the **Select** button to confirm the clock setting. The display will show 'Time and Date Set' and will then return to the radio station display.

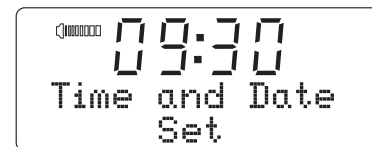
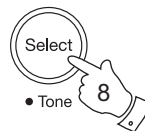
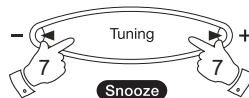

Resetting the clock

Your clock radio has a setting so that you can reset the clock to default settings so that it will set its clock automatically to UK time after a connection to the Internet has been established. To reset the clock, please follow this procedure.

- Press the **On/Off** button to switch the clock radio on.
- Press and hold the **Clock Set/Sleep** button. 'Set Time/Date' will show on the display.
- Press the **Tuning Up** or **Down** buttons until 'Reset Clock' is displayed. Press the **Select** button the clock will be reset to default settings.

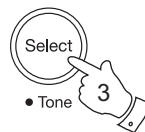
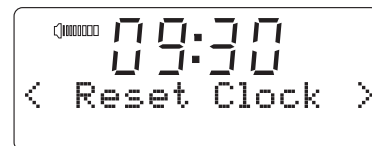
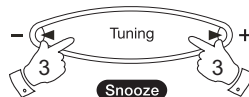
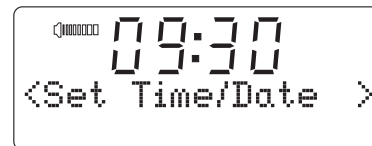

Setting the clock format

The clock display can be set to 12 or 24 hour format. The selected format is then also used when setting the alarms.

1. Press the **On/Off** button to switch the clock radio on.
2. Press and hold the **Clock Set/Sleep** button. 'Set Time/Date' will show on the display.
3. Press the **Tuning Up** or **Down** buttons until 'Clock Format' is displayed. Press the **Select** button to enter clock format menu. The current clock display format will flash.
4. Press the **Tuning Up** or **Down** buttons to select either 12 or 24 hour format.
5. Press the **Select** button to confirm your choice of clock format. The display will confirm the selected hour then revert to the previous menu.

If the 12 hour clock format is chosen, the clock radio will then use the 12 hour clock for the settings of alarms, and will display a 12 hour clock with an AM or PM indicator.

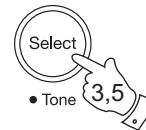
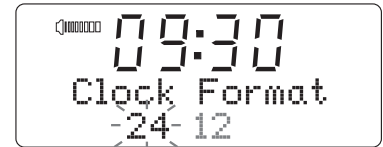
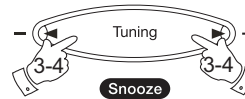
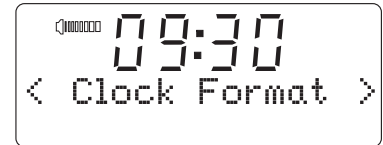
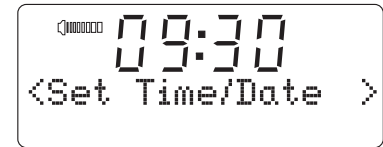
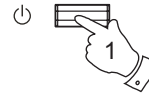

Setting daylight saving time

Normally your radio will use European rules for Daylight Saving Time so that the changes between Greenwich Mean Time and British Summer Time will be handled automatically. If this is not suitable for your location the time change may be configured manually.

These four options are available:

- Auto (EU) - Sets DST by European rules.
- Auto (US) - Sets DST by United States rules.
- Manual - Sets Daylight Saving Time (offset +1 hour)
- None - Cancels Daylight Saving Time.

1. Press the **On/Off** button to switch the clock radio on.
2. Press and hold the **Clock Set/Sleep** button. 'Set Time/Date' will show on the display.
3. Press the **Tuning Up** or **Down** buttons until 'DST' is displayed. Press the **Select** button to enter DST format menu.
4. Press the **Tuning Up** or **Down** buttons to choose either Auto (EU), Auto (US), Manual or None. Press the **Select** button to confirm your choice. The display will return to the radio station display.

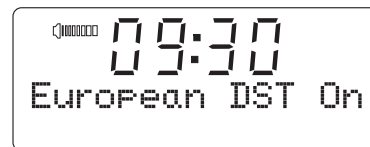
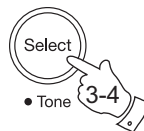
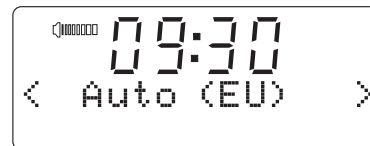
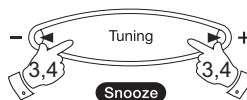
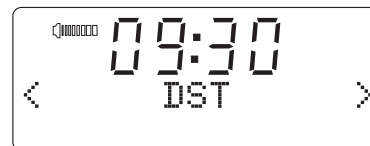
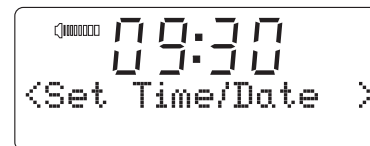
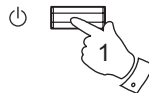

Setting the Time Zone

Your clock radio is set to UK time zone 0 GMT (UTC). Should you wish to take your clock radio to other countries the time zone will need to be reset.

1. Press the **On/Off** button to switch the clock radio on.
2. Press and hold the **Clock Set/Sleep** button. 'Set Time/Date' will show on the display.
3. Press the **Tuning Up** or **Down** buttons until 'Local Time Zone' is displayed. Press the **Select** button to enter time zone format menu.
4. Press the **Tuning Up** or **Down** buttons to adjust the time zone settings. Press the **Select** button to confirm your choice. The display will return to the radio station display.

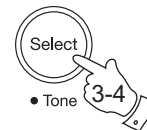
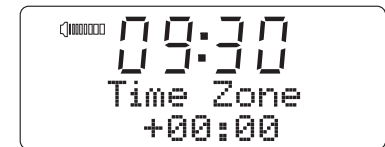
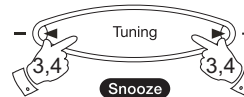
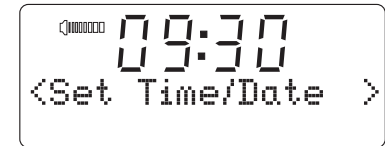
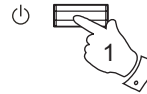

Setting the alarm clock

Your clock radio has two separate alarms which can be set to wake you to buzzer, Auxiliary In, internet radio or FM radio. Each alarm can be set to sound either once, everyday, weekly, weekdays or at weekends. In the event of a power interruption your radio has a built in memory chip that will retain your alarm settings.

Note: If no buttons are pressed for 10 seconds the radio will exit the alarm setup. If you make a mistake at any point, use the **Back** button to go back to the previous screen.

1. Press and hold **Alarm 1** or **Alarm 2** button. 'Enable Alarm' will show on the display and 'YES' will flash. Press the **Select** button to enable the alarm and to enter the alarm setting menu. The Alarm hour will flash on the display.

If you do not wish to enable the Alarm press the **Tuning Up** button until 'NO' is flashing on the display then press the **Select** button. Your clock radio will exit the alarm setup and will show 'Alarm disabled'.

2. Press the **Tuning Up** or **Down** buttons to set the correct hour. Press the **Select** button the minute digits will flash.

3. Press the **Tuning Up** or **Down** buttons to set the correct minutes. Press the **Select** button the alarm frequency option will be displayed.

Once	- will sound at one time only
Everyday	- will sound everyday.
Weekly	- will sound once every week.
Weekdays	- will sound on weekdays only.
Weekends	- will sound on weekends only.

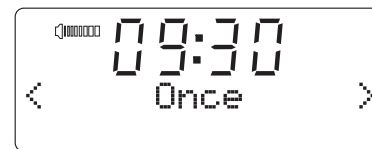
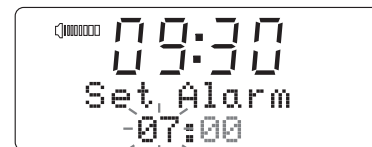
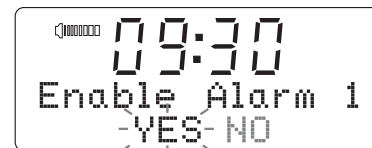
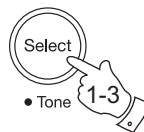
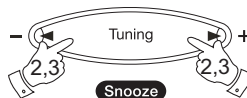
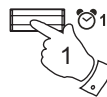

4. Press the **Tuning Up** or **Down** buttons to choose the required alarm frequency option. Press the **Select** button to confirm this selection. If setting the alarm everyday, weekdays or weekends please skip to point 6.
5. Press the **Tuning Up** or **Down** buttons until the required day of the week is displayed. Press the **Select** button to confirm this selection. The clock radio will enter the alarm mode option.
6. The alarm can be set to buzzer, auxiliary input, internet radio or FM radio. The radio station alarm may be set to any of the stations which have been stored as presets or to the station currently listened to. Press the **Tuning Up** or **Down** buttons until the required alarm mode option is displayed.
7. Press the **Select** button to confirm the alarm settings. Your radio will show 'Alarm Set' and will exit the alarm setting menu. Active alarms are shown using small alarm indicators on the playing displays and on the clock display when in standby.

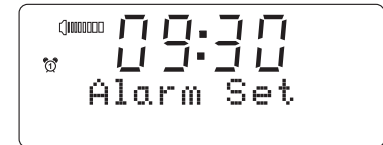
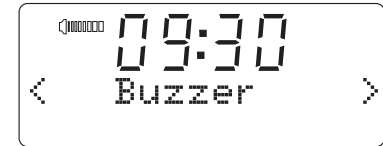
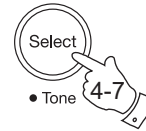
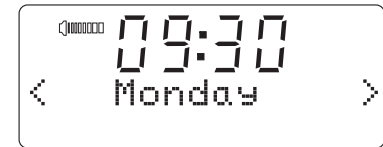
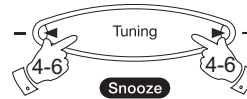

When the alarm sounds

The radio alarm will sound at the selected times for up to 60 minutes unless cancelled. The volume for the radio alarm will be the same as the volume previously used when listening to the radio or media player. If for any reason the radio cannot connect to the requested radio station at the time that the alarm is due, the buzzer alarm will be used instead.

To cancel an alarm, press the **On/Off** button to return to stand-by mode.

The buzzer alarm sounds for 10 minutes and the volume will gradually increase from a low level. If the radio is playing at the time that the buzzer sounds, then the buzzer volume is based on the radio volume setting.

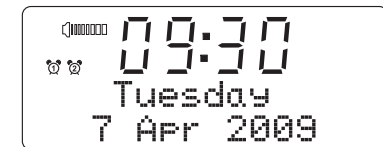
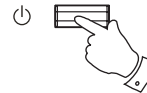

Disabling alarms

1. To Disable a single alarm press and hold **Alarm 1** or **2 button** and press the **Tuning Up** button until 'NO' is flashing on the display. Press the **Select** button to confirm. The display will show 'Alarm disabled'.
2. To Disable all alarms press the **Back** button to enter main mode menu. Press the **Tuning Up** or **Down** buttons until 'Alarm Clock' shows on the display then press the **Select** button to enter menu. 'Set Alarms' will show on the display.
3. Press the **Select** button and then press the **Tuning Up** or **Down** buttons until 'Disable all' is displayed. Press the **Select** button and all alarms will be disabled.

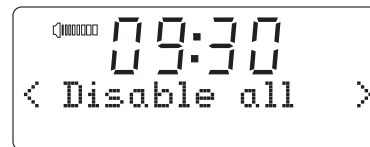
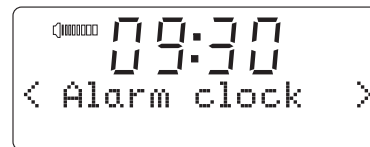
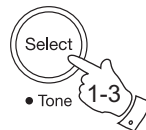
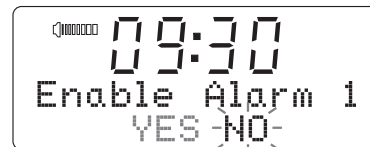
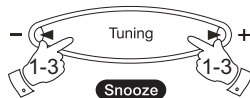

To view alarms

1. To view the current alarm setting press and release either the **Alarm 1** or **2** button and the relevant alarm setting will show on the display.

Snooze timer

1. The buzzer or radio alarm can be silenced for 10 minutes by pressing the **Tuning Up/Down/Snooze** button.
2. While the snooze timer is active the snooze indicator will show on the display.
3. In order to cancel the Snooze timer, press the **On/Off** button.

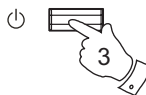
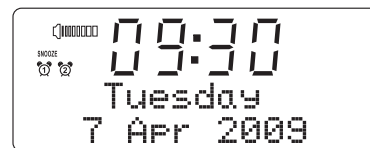
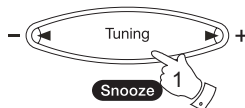

Sleep timer

Your clock radio can be set to turn off after a preset time has elapsed. The sleep setting can be adjusted between 10 minutes to 3 hours.

1. When the radio is playing press and release the **Clock Set/Sleep** button the current sleep setting will be displayed.
2. Repeatedly press the **Clock Set/Sleep** button until the required sleep time setting is selected between 10 minutes and 3 hours or to Off. Press the **Select** button to confirm the setting.
3. Your radio will switch off after the preset time has elapsed. A sleep timer indicator will show on the display.
4. To cancel the sleep time before the preset time has elapsed and to turn off the radio, use the **On/Off** button to turn the radio off manually. To cancel the sleep timer and leave the radio playing, go back into the sleep timer settings (steps 1 to 2 above) and select the Off option in step 2.

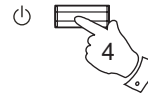
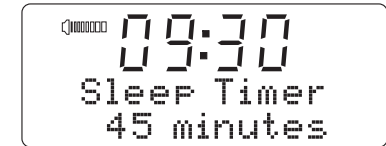
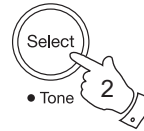
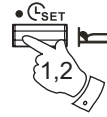

During the last two minutes of the sleep timer period, the radio will gradually reduce the volume before switching off. Alternatively, simply press the On/Off button twice in succession to cancel the timer and switch the radio back on again.

Nap timer

The Nap timer facility allows you to set your clock radio to wake you after a predetermined interval (up to 3 hours) without needing to set the alarms.

1. When the radio is playing press and release the **Nap timer** button the current Nap timer setting will be displayed.
2. Repeatedly press the **Nap timer** button until the required Nap time setting is selected between 10 minutes and 3 hours or to Off. Press the **Select** button to confirm the setting.
3. The Nap Timer indicator will show on the display. When the selected Nap timer has elapsed, the buzzer will sound.
4. To cancel the buzzer press the **On/Off** button. To disable the Nap timer go back into the Nap timer settings (steps 1 to 2 above) and select the Off option in step 2.

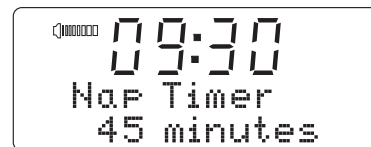
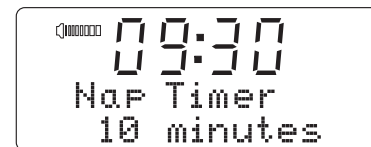
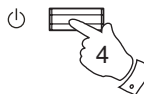
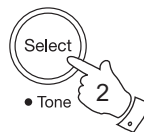

Dimmer

1. In order to adapt the intensity of the display to suit the ambient room lighting, press the Dimmer button on your clock radio to select the desired dimmer brightness or to Off.

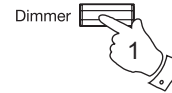

Language selection

This facility allows you to change the display language for the menus.

1. Repeatedly press the **Back** button to enter main mode menu.
2. Press the **Tuning Up** or **Down** buttons until 'Settings' shows on the display then press the **Select** button to enter settings menu.
3. Press the **Tuning Up** or **Down** buttons until 'Language' shows on the display then press the **Select** button to access the list of available languages. (English (GB), English (US), French, Spanish, Catalan, German, Danish, Italian, Dutch, Portuguese, Finnish, Swedish and Norwegian).
4. Press the **Tuning Up** or **Down** buttons until the language you require shows on the display then press the **Select** button to confirm language selection. The clock radio will then restart in the chosen language.

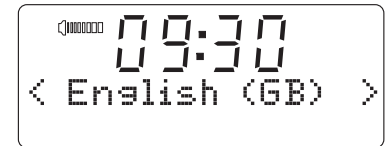
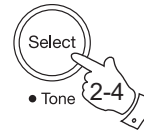
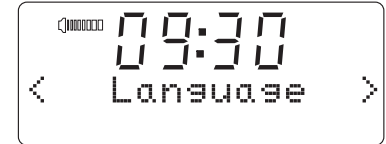
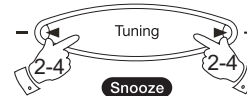

Audio settings (tone controls)

Your clock radio has an Audio Settings menu where the bass and treble characteristics of the sound can be adjusted to your personal taste.

1. When the radio is playing **press and hold** the **Select/Tone** button 'Off' will show on the display. The clock radio will select the Audio menu which allows bass and treble adjustment as well as alternative access to the main Mode Menu.
2. To adjust Bass, press the **Tuning Up** or **Down** buttons until 'Bass' is displayed. Press and release the **Select** button. The display will show the current Bass level. Press the **Tuning Up** or **Down** buttons to set the desired level (between -4 and +4) and press and release the **Select** button to confirm selection.
3. To adjust Treble, press the **Tuning Up** or **Down** buttons until 'Treble' is displayed. Press and release the **Select** button. The display will show the current Treble level. Press the **Tuning Up** or **Down** buttons to set the desired level (between -4 and +4) and press and release the **Select** button to confirm selection.
4. To quickly cancel any bass or treble setting, press the **Tuning Up** or **Down** buttons until 'Flat' is displayed. Press and release the **Select** button and the equalisation levels will be reset.

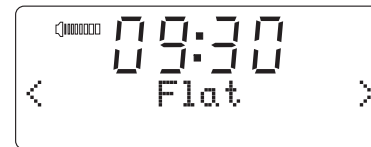
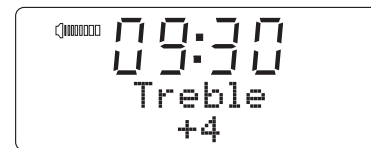
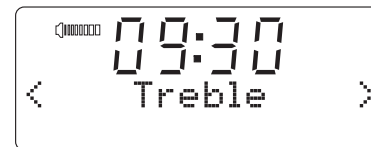
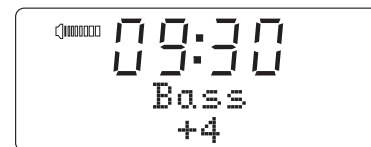
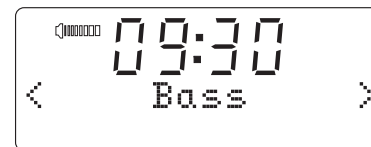
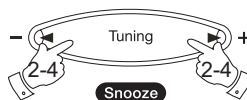
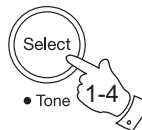

Headphone socket

1. A 3.5mm **Headphone Socket** located on the rear of your clock radio is provided for use with headphones. Inserting a plug automatically mutes the internal loudspeaker.

IMPORTANT: Excessive sound pressure from earphones and headphones can cause hearing loss.

Your clock radio is supplied set up for best audio quality from the built in loudspeaker. If you wish to use headphones you may set the audio settings so as to give best quality when listening via headphones.

1. When the radio is playing press and hold the **Select/Tone** button 'Off' will show on the display. The clock radio will select the Audio menu which allows bass and treble adjustment as well as alternative access to the main Mode menu.
2. To adjust the headphone audio setting, press the **Tuning Up** or **Down** buttons until 'Headphone EQ' is displayed. Press and release the **Select** button. The display will show the current Headphone EQ setting.
3. Press the **Tuning Up** or **Down** buttons to set the headphone EQ to On or to Off. Press the **Select** button to confirm selection.

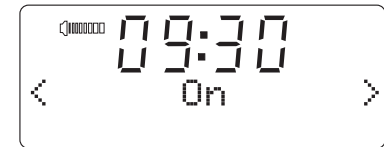
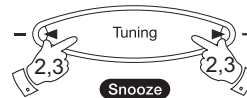
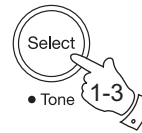
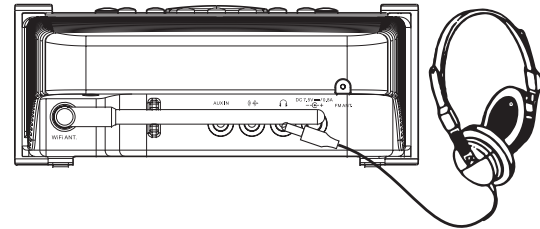

Line out socket (3.5mm Jack)

A 3.5mm **Line Out** socket located on the rear of your clock radio is provided for connecting the audio signal to an external amplifier. Inserting an audio cable into this socket will not mute the internal loudspeaker. Set the volume control on the clock radio to minimum if desired.

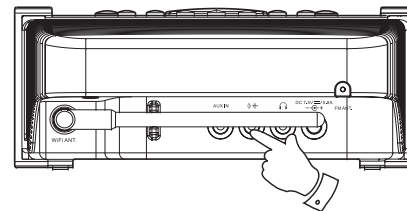

Auxiliary input socket

A 3.5mm **Auxiliary Input** socket located on the rear of your clock radio is provided for connecting the audio signal from an external audio source such as an MP3 or CD player.

1. Connect a stereo lead from the headphone output of your MP3 or CD player to the Aux In socket. Typically this lead will have a 3.5mm stereo plug at both ends.
2. Switch on your clock radio and turn the volume **on the clock radio** to minimum.
3. Press the **Band** button on your clock radio until 'Auxiliary Input' shows on the display.
4. Press 'play' on the connected audio device and adjust the volume using its volume control, leaving the clock radio's volume at minimum.
5. After use, disconnect your player in order to listen to your clock radio conventionally.

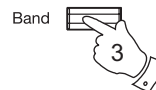
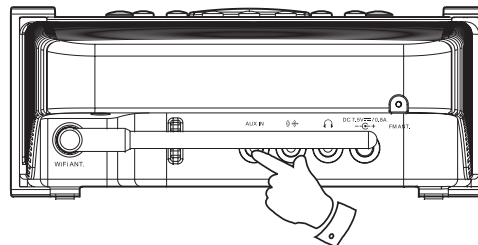

Factory reset

If you wish to completely reset your radio to its initial state this may be performed by following this procedure. By performing a factory reset, all user entered settings will be erased.

1. Access the main mode menu by pressing the **Back** button then press the **Tuning Up** or **Down** buttons until 'Settings' is displayed.
2. Press the **Select** button to enter the Settings menu. Press the **Tuning Up** or **Down** buttons until 'Factory Reset' is displayed.
3. Press the **Select** button 'NO' will flash on the display. Press the **Tuning Up** or **Down** button until 'YES' is flashing on the display to proceed with the system reset.
If you do not wish to carry out a system reset, select 'NO' and then press the Select button. The display will revert to the previous menu.
4. With 'YES' flashing on the display, press the **Select** button. A full reset will be performed. The station list together with any preset stations will be erased and your wireless network connection details will be lost. All configuration settings will be restored to their defaults, the clock and alarms will be reset.

In case of malfunction for any reason, reset the product as described above to resume normal operation. It may be necessary in some cases to disconnect the mains power then reconnect power after 10 seconds.

In case of malfunction due to electrical fast transient (burst), reset the product as above (reconnection of the power source may be required) to resume normal operation.

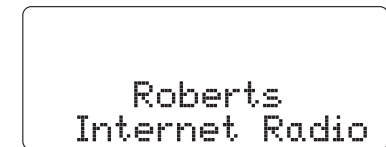
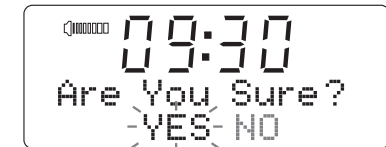
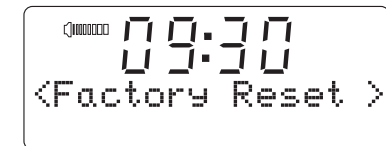
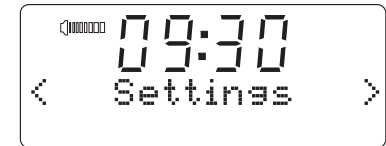
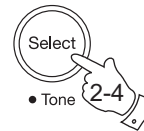
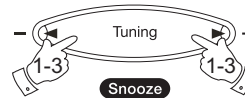

Software version

The software version display is provided for your reference only.

1. Press the **Back** button to enter main mode menu.
2. Press the **Tuning Up** or **Down** buttons until 'Settings' shows on the display then press the **Select** button to enter settings menu.
3. Press the **Tuning Up** or **Down** buttons until 'Version' shows on the display then press the **Select** button. The current software version will be displayed.
4. Press the **Tuning Up** or **Down** buttons to view additional information Serial number and Product code for your clock radio. Press the **Back** button to exit menu.

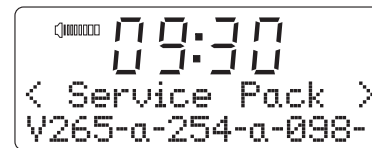
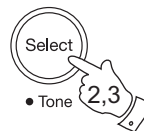
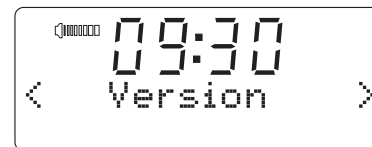
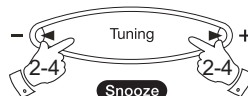

Entering the network name manually

If you need to enter the wifi network name manually into your radio (if the SSID is not being broadcast by your router) then please use the following procedure.

1. From the radios Settings menu, select ' Network' and then 'Enter network name'.
2. To enter the SSID, characters are selected and entered using the **Tuning Up** or **Down** buttons. As you press the buttons, the radio scrolls through the available characters. The central character will be entered when you press the **Select** button.

Do this as needed until the complete network name has been entered. *The SSID setting is sensitive to upper and lower case characters and symbols. You must enter it exactly as set up in your router.*

Press the **'Back'** button to erase a character or key previously entered

Select **'END'** when the SSID is complete

Alternatively the 'END' symbol can be quickly accessed by pressing the **Add/RDS** button.

Select **'Back'** button to cancel and go back to the DNS settings screen

3. The clock radio will then try to connect to the named network. The remainder of the connection procedure should then be followed - see page 10, step 11.

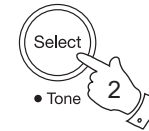
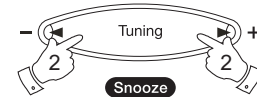

Entering the network address manually

If you do not wish to use DHCP for automatic configuration, or if your network is configured with a hidden SSID, then you will need to enter some network settings manually. (Note - a hidden SSID may prevent casual observers from detecting your network, but it is not recommended as a means of network security).

1. From the radio's Settings menu, select 'Network' and then 'Edit config' menu.
2. The next menu asks whether you wish to use DHCP to configure your network parameters (IP address, subnet mask, gateway address, etc.). Unless you are familiar with networking and related terminology, we recommend that you allow the use of DHCP. Choose 'Auto DHCP - YES' unless you need to specify network details manually.

If you chose 'Auto DHCP - NO' for the connection method, the next step is to set up the IP address.

3. The IP address used should be chosen to be compatible with the settings in your router and must be a unique address on your network. If you are using DHCP for some devices and static (manually configured) IP addresses for others, the IP address used should fall outside the range that the router may allocate using DHCP. Typically, the first three groups of digits will be the same for all devices on your network. To enter the IP address, press the **Tuning Up** or **Down** buttons to set the value for each group of digits and then press the **Select** button to enter the value and to move on to the next group. When the IP address has been entered, the subnet mask should be entered. The subnet mask defines which parts of the IP address are common across your network. For most small networks the subnet mask will be 255.255.255.0 and this is entered in the same way.

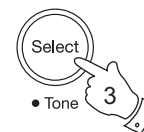
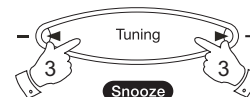

Entering the network address manually cont.

4. The Gateway address is normally the IP address of the router through which the radio connects to the internet and is entered in the same way as the previous addresses.
5. In most installations the DNS settings (DNS = Domain Name Server) will be set to the same IP address as your router. In this case the secondary DNS may be left at zero.

To enter the DNS address, press the **Tuning Up** or **Down** buttons to set the value for each group of digits and then press the control to enter the value and to move on to the next group. Repeat this until all eight groups of digits have been entered.

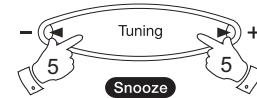

Wireless Standby mode

Your clock radio has a wireless standby mode feature that allows you to choose whether to stay connected to the wireless network when the clock radio is in Standby.

This feature is enabled by default (or after a factory reset) and is intended to minimise the time taken by the radio to start playing when it is switched on.

1. Press the **Back** button to enter main mode menu.
2. Press the **Tuning Up** or **Down** buttons until 'Settings' shows on the display then press the **Select** button to enter settings menu.
3. Press the **Tuning Up** or **Down** buttons until 'Network' shows on the display then press the **Select** button.
4. Press the **Tuning Up** or **Down** buttons until 'Wireless Standby power mode' shows on the display then press the **Select** button. The current setting will flash on the display.
5. Press the **Tuning Up** or **Down** buttons to select 'YES', then press the **Select** button to confirm that you wish to stay connected. If you do not wish to stay connected select 'NO'.

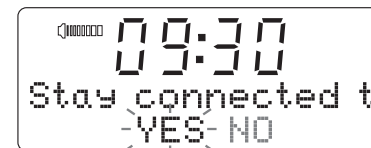
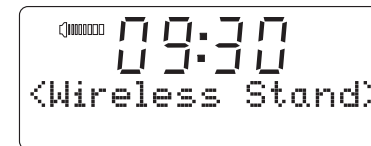
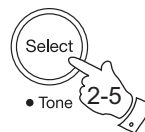
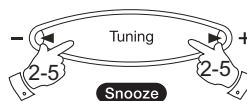

WiFi strength

To check the strength of your WiFi connection follow the procedure below.

1. Press the **Back** button to enter main mode menu.
2. Press the **Tuning Up** or **Down** buttons until 'Settings' shows on the display then press the **Select** button to enter settings menu.
3. Press the **Tuning Up** or **Down** buttons until 'Network' shows on the display then press the **Select** button.
4. Press the **Tuning Up** or **Down** buttons until 'WiFi Strength' shows on the display then press the **Select** button. The current WiFi strength will show on the display.

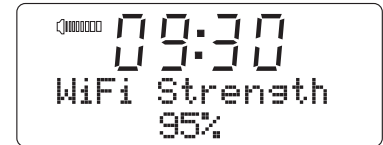
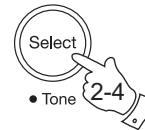
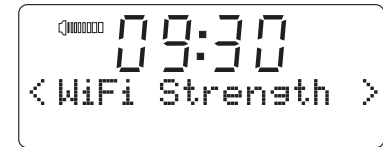
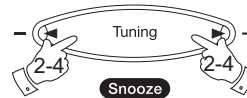

Signal Warning

You can set your clock radio to warn you when the WiFi signal is low.

1. Enter the settings menu.
2. Press the **Tuning Up** or **Down** buttons until 'Network' shows on the display then press the **Select** button.
3. Press the **Tuning Up** or **Down** buttons until 'Signal Warning' shows on the display then press the **Select** button.
4. Press the **Tuning Up** or **Down** buttons to select 'YES', then press the **Select** button to confirm that you wish to enable low signal warning. If you do not wish to enable this feature select 'NO'.

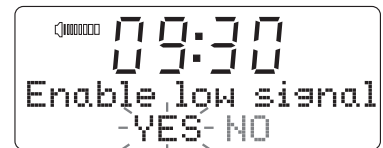
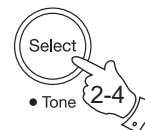
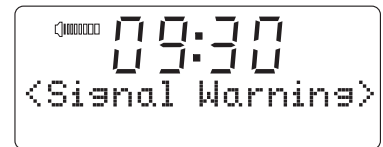
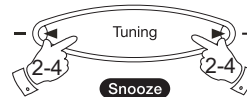

Troubleshooting

If you experience any trouble with your Internet radio, then you may find it useful to visit the help section on our web site at

http://www.robertsradio.co.uk/pages/streamtime_faqs.htm

or on Reciva's website at

<http://radios.reciva.com>

If you have difficulty connecting the radio to your computer network, some of these steps may help to resolve the problem:

1. Confirm that a WiFi connected PC can access the Internet (i.e. can browse the web) using the same network.
2. Check that a DHCP server is available (normally a router function), or that you have configured your radio to use DHCP. Your radio will by default use DHCP. This may be configured using the menu items 'Main mode menu' -> 'Settings' -> 'Network' -> 'Edit config'. You then need to choose 'Auto DHCP - YES' or 'Auto DHCP - NO'. If you enable DHCP then the radio will negotiate with your router (or DHCP server) and will be provided with an IP address as well as the other settings needed. If you wish to set the network configuration manually, refer to paragraph 6.
3. Check that your network's firewall is not blocking any outgoing ports. As a minimum, the radio needs access to UDP and TCP ports 80, 554, 1755, 5000 and 7070. The use of Windows Shares requires access to UDP and TCP ports 135 - 139 and 445. Windows Media Player 11 will allocate a port number for UPnP media sharing and will configure Microsoft's Windows built-in firewall appropriately. Other firewall software may require configuration for UPnP or to allow particular IP addresses to have trusted access.
4. Check that your access point does not restrict connections to particular MAC addresses (sometimes called MAC address filtering).

You can view the radio's MAC address using the menu items 'Main mode menu' -> 'Settings' -> 'Network' -> 'View config' -> 'MAC address'.

A wireless MAC address will typically be of the form

00 : 1F : 1F : xx : xx : xx

5. If you have an encrypted network, check that you have entered the correct encryption key into the radio. Remember that text-format WPA keys are case sensitive. If your radio displays 'Network error' when attempting to connect to an encrypted network, then please ensure that you enter the correct key for the network. If the problem persists, then you may need to re-check your network configuration.
6. If you need to set up your radio's IP address manually, you will need to know low-level details of your network's configuration. Use the menu items 'Main mode menu' -> 'Settings' -> 'Network' -> 'Edit config' -> 'DHCP disable'.

The radio will then prompt you in turn for the

Ethernet IP address

Ethernet Subnet mask

Ethernet Gateway address

Ethernet Primary DNS

Ethernet Secondary DNS

If you are setting up a wireless connection manually you will also need to enter the SSID, the encryption type, and the encryption key.

See page 56 for full details on how to set up your radio's network configuration manually.

If your clock radio can connect to the network successfully, but is unable to play particular internet radio stations, it may be due to one these causes:

1. The station is not broadcasting at this time of the day (remember it may be located in a different time zone, and some stations do not broadcast all day).
2. The station has reached the maximum allowed number of simultaneous listeners.
3. The Internet connection between your clock radio and the server (often located in a different country) is slow. This could be due to internet congestion, either locally or at a distance.
4. The station is not broadcasting any more. The database of radio stations that your radio connects to is frequently updated and checked but may not always be completely accurate.
5. The radio station is broadcasting using an audio format which is not playable by your radio (although the **STREAMTIME** does play the most popular formats used by regular broadcasters).

Try using a PC to play the stream via the broadcaster's web site or via the radio station database web site at <http://radios.reciva.com> If you can play the station with a PC, it may be that the internet feed or local network connection is poor. However, some broadcasters (such as the BBC) provide different data streams for PC users and internet radio listeners, so this test is not always conclusive.

If you cannot play the station via your PC this may indicate that the problem is not necessarily due to your radio, but it could be your network, your internet connection, the broadcaster, or internet congestion.

Software update

From time to time, new software features for your radio may be developed. Your radio has therefore been designed to allow its internal software to be updated using your Internet connection.

You should not attempt to update your clock radio unless it is recommended to you by Roberts Customer Services. Updating the software may remove all network settings, radio station presets and alarm settings from your clock radio.

It is important that you do not attempt this procedure unless you have a good Internet connection and a reliable mains power supply. As the radio connects to your router using a WiFi connection, make sure that this is also reliable before proceeding.

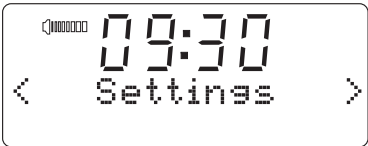
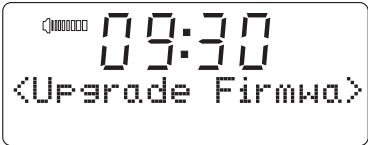
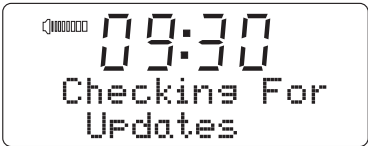
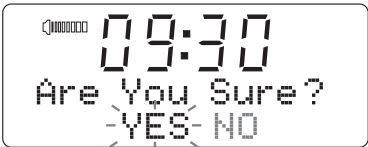
1. The 'Software update' option is accessed via the Settings menu. When you select 'Upgrade Firmware' the radio will display 'checking for updates' if there is a software update your radio will display 'Are you sure?'.

2. Press the **Tuning Up** or **Down** buttons to highlight the 'YES' option if you wish to go through the update process. If there are no updates then the display will show 'No upgrade available'.

3. If you choose to update your radio it will first download the new software and will then reprogram its internal memory. This may take a few minutes depending on the speed of your internet connection.

4. Once the software update is completed, the clock radio will prompt you to press **Select** button to restart and your radio will then restart. You may find that you will need to reconfigure your network connection following an update. You may also need to re-enter all radio station presets, alarm settings, and configuration options.

VERY IMPORTANT: Do not switch off the power to the clock radio until the update operation is complete and the radio has restarted, otherwise the clock radio may become permanently damaged.

General

Do not allow your clock radio to be exposed to water, steam or sand. Do not leave your clock radio where excessive heat could cause damage.

The name plate is located on the rear of the clock radio.



- The clock radio shall not be exposed to dripping or splashing and no objects filled with liquids, such as vases, shall be placed on the clock radio.
- It is recommended to operate the product such that there is a minimum distance (10cm recommended) to adjacent objects in order to ensure good ventilation.
- The ventilation of the product should not be restricted by covering it with items such as newspapers, tablecloths, curtains etc.
- No naked flame sources such as lighted candles should be placed on the product.
- It is recommended to avoid using or storing the product at extremes of temperature. Avoid leaving the unit in cars, on window sills, in direct sunlight etc.

Specifications

Power Requirements

Mains 100 - 240 volts AC, 50 - 60Hz \sim only
(use only adaptor supplied)

Connectivity

Wi-Fi 802.11b and 802.11g supported with WEP and WPA/WPA2 encryption

Compatible with 802.11n routers which offer mixed mode support for 802.11b/g

Circuit features

Loudspeaker 76 mm

Output Power 1 Watt

Headphone socket 3.5mm dia

Auxiliary In socket 3.5mm dia

Line Out socket 3.5mm dia

Aerial System	WiFi	External Wi-Fi Antenna
	FM	Wire aerial

The Company reserves the right to amend the specification without notice.

Software license information

This product contains software licensed under version 2 of the GNU Public License and version 2.1 of the GNU Lesser Public License, The source code for this software is available from: <http://www.reciva.com/gpl/>

This product includes technology owned by Microsoft Corporation and under a licence from Microsoft Licensing, GP. Use or distribution of such technology outside of this product is prohibited without a license from Microsoft Corporation and / or Microsoft Licensing, GP as applicable.

The Roberts **STREAMTIME** Internet clock radio incorporates hardware and software technology which has been developed by Reciva Limited, Cambridge, UK.



This instrument is guaranteed for twelve months from the date of delivery to the original owner against failure due to faulty workmanship or component breakdown, subject to the procedure stated below. Should any component or part fail during this guarantee period it will be repaired or replaced free of charge.

The guarantee does not cover:

1. Damage resulting from incorrect use.
2. Consequential damage.
3. Receivers with removed or defaced serial numbers.

N.B. Damaged or broken aerials will not be replaced under guarantee.

Procedure:

Any claim under this guarantee should be made through the dealer from whom the instrument was purchased. It is likely that your Roberts' dealer will be able to attend to any defect quickly and efficiently but should it be necessary the dealer will return the instrument to the Company's service department for attention. In the event that it is not possible to return the instrument to the Roberts' dealer from whom it was purchased, please contact Roberts Radio Technical Services at the address shown overleaf.

These statements do not affect the statutory rights of a consumer.

ROBERTS RADIO TECHNICAL SERVICES

97-99 Worton Road

Isleworth

Middlesex

TW7 6EG

Technical Helpline :- 020 8758 0338 (Mon-Fri during office hours)

Web site: <http://www.robertsradio.co.uk>



Issue 1

© 2009 Roberts Radio Limited

Download from [Www.Somanuals.com](http://www.Somanuals.com). All Manuals Search And Download.



Free Manuals Download Website

<http://myh66.com>

<http://usermanuals.us>

<http://www.somanuals.com>

<http://www.4manuals.cc>

<http://www.manual-lib.com>

<http://www.404manual.com>

<http://www.luxmanual.com>

<http://aubethermostatmanual.com>

Golf course search by state

<http://golfingnear.com>

Email search by domain

<http://emailbydomain.com>

Auto manuals search

<http://auto.somanuals.com>

TV manuals search

<http://tv.somanuals.com>