

ROBERTS

Sound for Generations

CD9989

MP3 CD Player
with 2 Band Radio



Please read this manual before use

Contents

Contents	1	Erasing a programme	17
Controls	2-4	MP3 Mode	18
Battery operation	5	Playing an MP3 CD	19
Mains operation	5	Selecting albums and files	19
Operating your radio - FM Search tuning	6	Repeating a file	20
Operating your radio - MW Search tuning	7	Repeating all files in an album	20
Operating your radio - manual tuning	8	Repeating all files	20
Presetting radio stations automatically	9	Playing back files in random order	21
Presetting radio stations manually	10	Programming tracks	21
Recalling a preset station	11	Playing a programmed track	22
Last station memory	11	Editing a programme	22
Compact Discs	12	Adding a new file	23
CD-R / CD-RW discs	12	General	24
Inserting a CD	13	Mains supply	24
Playing a CD	13	Fuse	24
Selecting a track	14	Underneath the unit	24
Search function	14	Headphones	24
CD repeat mode	15	Specification	25
CD random mode	15	Circuit features	25
Programmed play	16	MP3 features	25
Editing a programme	16	Notes	25
Checking a programme	17	Guarantee	26

Controls

(Front)

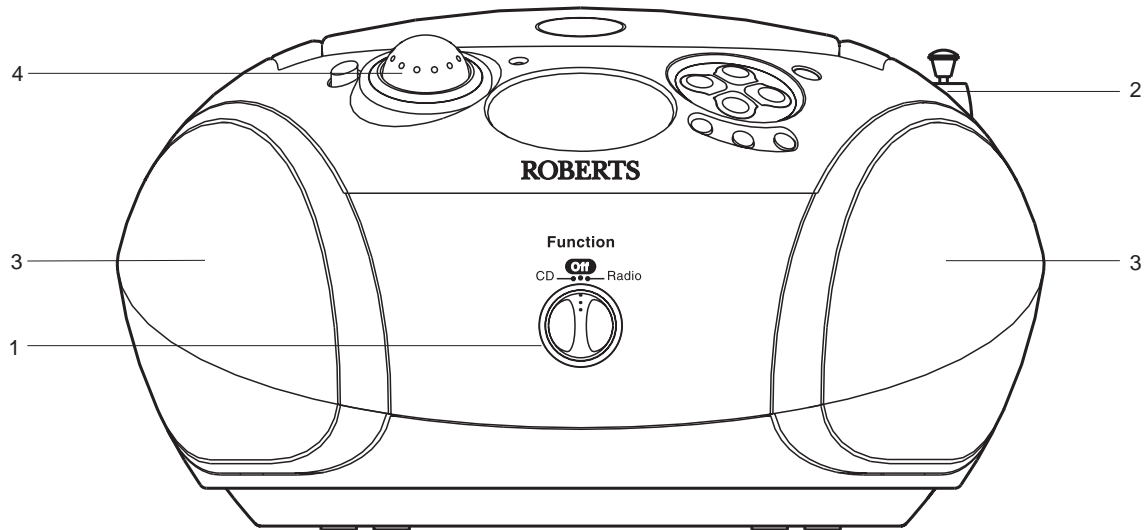

1. Function switch
2. Telescopic aerial
3. Loud speakers
4. Volume control

If you need any further advice, please call our Technical Helpline on :-

020 8758 0338 (Mon-Fri)

Download from www.Somanuals.com. All Manuals Search And Download.

Controls

(Top)

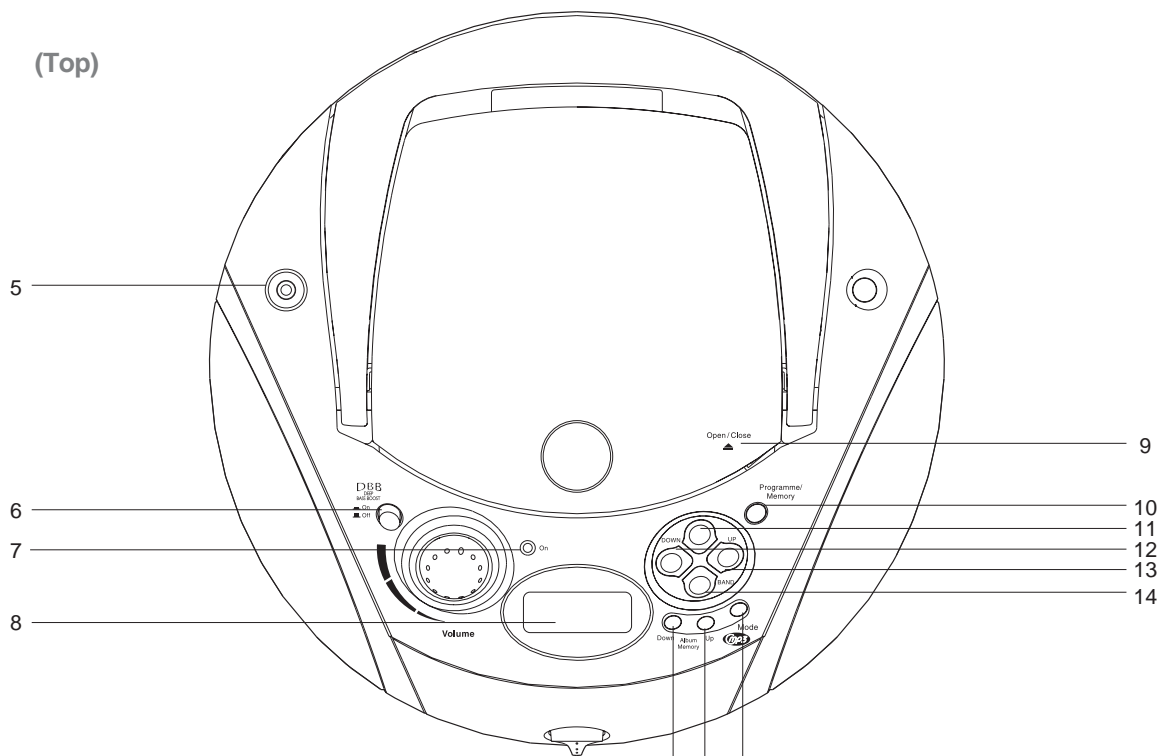

- 5. Headphone socket
- 6. Deep Bass Boost button
- 7. On indicator light
- 8. LCD display

- 9. CD open close
- 10. Programme / Memory button
- 11. Play / Pause button
- 12. Tuning Down / B Skip button

17 16 15

- 13. Tuning Up / F Skip button
- 14. Waveband / Stop button
- 15. Mode button
- 16. Up Album / Memory up button
- 17. Down Album / Memory down button

Controls

(Left side)

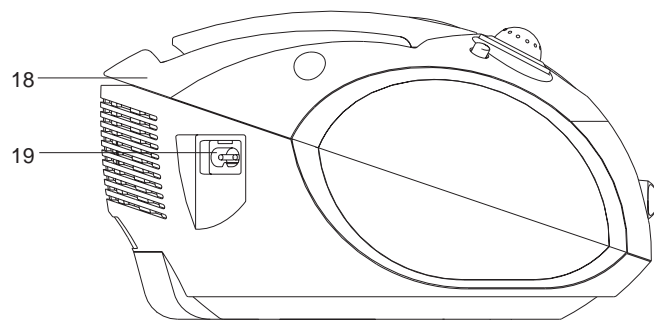

(Right side)

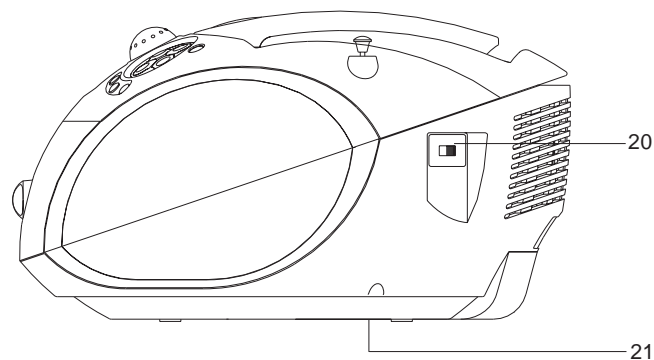

- 18. Handle
- 19. Mains power socket
- 20. FM Mode switch
- 21. Battery compartment

If you need any further advice, please call our Technical Helpline on :-

020 8758 0338 (Mon-Fri)

Download from www.Somanuals.com. All Manuals Search And Download.

Battery operation

1. Slide the battery cover catch in the direction of the arrow. Open the battery cover.
 2. Fit six LR14 (C size) batteries into the spaces in the compartment. Insert 2 x LR6 (AA) batteries into the small spaces in the battery compartment. Back-up batteries are optional, they ensure that stored settings are not lost in case of power failure. Take care to ensure all batteries are inserted with the correct polarity as shown inside the battery compartment. Replace the battery cover.
 3. Reduced power, distortion and a 'stuttering' sound are all signs that the batteries may need replacing. If your MP3 CD radio is not to be used for a prolonged period of time, remove the batteries to avoid damage by battery leakage.
- We recommend for economy that your MP3 CD radio is used on the mains whenever possible with battery operation for occasional or stand-by use only.

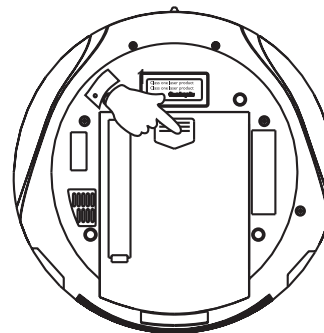

Mains operation

1. Place your MP3 CD radio on a flat surface.
 2. Plug the mains lead into the AC mains socket located towards the rear of the unit ensuring that the plug is pushed fully into the socket.
 3. Plug the other end into a mains wall socket and switch on.
- The unit remains connected to the mains even when it is switched off. The unit is only fully isolated from the mains if the mains plug is removed from the wall socket.

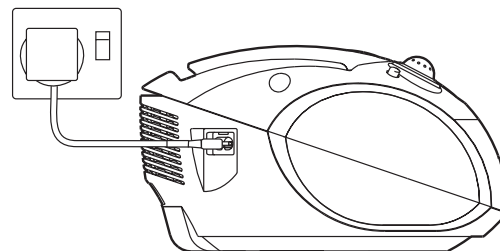

Operating your radio FM - search tuning

1. Switch on your MP3 CD radio by rotating the **Function switch** to the 'Radio' position. The **On indicator** will light.
2. Press the **Waveband button** to the 'FM' position. The FM symbol will appear in the display.
3. The **Telescopic aerial** which is only operational on FM, should be fully extended and positioned for optimum reception.
4. Press and hold the **Tuning Up** or **Down** buttons in for a couple of seconds. Your radio will search in an upwards or downwards direction and stops automatically when it finds a station of sufficient strength.

Search tuning may be stopped by a single press on either the **Tuning Up** or **Down buttons**.

5. Adjust the volume by rotating the **Volume control** to the required level.
6. To receive stereo broadcasts set the **FM Mode switch** located on the rear of the unit to the 'FM Stereo' position. The **FM stereo indicator** ∞ will be displayed. If the station being received is weak some hiss may be audible, to reduce the hiss set the FM Mode switch to the 'FM mono' position to return to mono operation.
7. Press the **DBB button** to activate the Deep Bass Boost system. Press the **DBB button** again to deactivate the Deep Bass Boost system.
8. The radio can be switched off by rotating the **Function switch** to the 'Off' position.

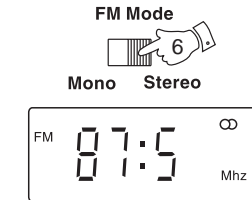
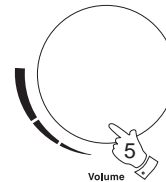
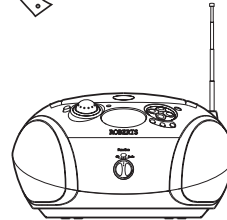
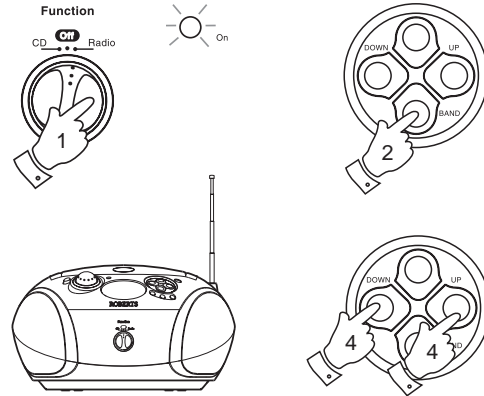

Operating your radio MW - search tuning

1. Switch on your MP3 CD radio by rotating the **Function switch** to the 'Radio' position. The **On indicator** will light.
2. Press the **Waveband button** to the 'MW' position. The MW symbol will appear in the display.
3. To auto-tune press and hold the **Tuning Up** or **Down buttons** in for a couple of seconds. Your radio will search in an upwards or downwards direction and stops automatically when it finds a station of sufficient strength.
Search tuning may be stopped by a single press on either the **Tuning Up** or **Down buttons**.
For MW reception there is a built in ferrite aerial. Rotate the unit to the position giving best reception.
4. Adjust the volume by rotating the **Volume control** to the required level.
5. Press the **DBB button** to activate the Deep Bass Boost system. Press the **DBB button** again to deactivate the Bass Boost system.
6. The radio can be switched off by rotating the **Function switch** to the 'Off' position.

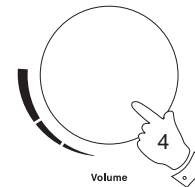
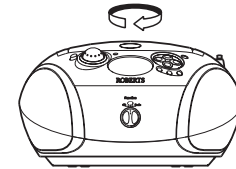
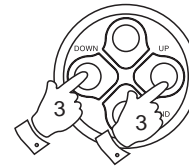
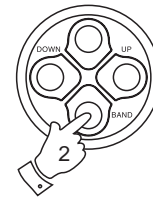
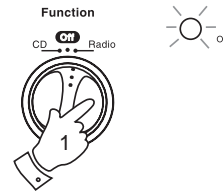

Operating your radio - manual tuning

1. Switch on your MP3 CD radio by rotating the **Function switch** to the 'Radio' position. The **On indicator** will light.
2. Press the **Waveband button** to either the 'FM' or 'MW' position. The band symbol will appear in the display. On FM fully extend the telescopic aerial. On MW rotate your radio for best reception.
3. A single press on either the **Tuning Up** or **Down buttons** will change the frequency up or down. The frequency steps are:- FM 50MHz, MW 9kHz.
4. Adjust the volume by rotating the **Volume control** to the required level.
5. Press the **DBB button** to activate the Deep Bass Boost system. Press the **DBB button** again to deactivate the Bass Boost system.
6. The radio can be switched off by rotating the **Function switch** to the 'Off' position.

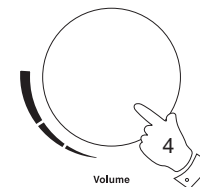
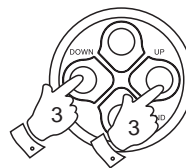
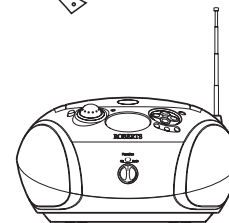
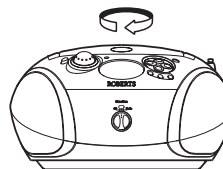
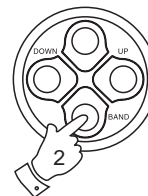
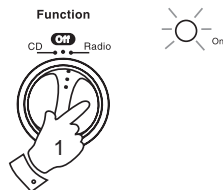

If you need any further advice, please call our Technical Helpline on :-

020 8758 0338 (Mon-Fri)

Download from www.Somanuals.com. All Manuals Search And Download.

Presetting radio stations - automatically

1. Switch on your MP3 CD radio by rotating the **Function switch** to the 'Radio' position. The **On indicator** will light.
2. Press the **Waveband button** to either the 'FM' or 'MW' position. The band symbol will appear in the display. On FM fully extend the telescopic aerial. On MW rotate your radio for best reception.
3. Press and hold the **Programme Memory button** in for several seconds. The memory symbol will flash on the display whilst it is searching. The radio searches for up to 10 radio stations and then stores them automatically in preset positions 1 - 10 and the memory symbol remains on the display.
4. After all ten preset positions have been stored the radio will begin to play the station located in the preset 1 position.

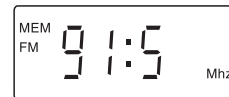
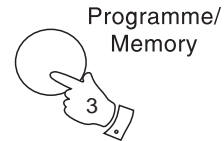
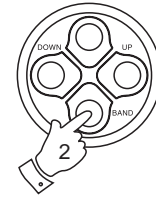
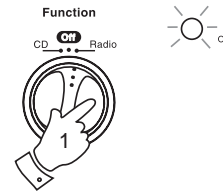

Presetting radio stations - manually

Up to 10 stations on the FM band or MW band can be stored in the preset positions.

1. Switch on your MP3 CD radio by rotating the **Function switch** to the 'Radio' position. The **On indicator** will light.
2. Press the **Waveband button** to either the 'FM' or 'MW' position. The band symbol will appear in the display.
3. Press the **Tuning Up** or **Down buttons** to select desired radio station.
4. Press and release the **Programme Memory** button to activate the memory function. The memory symbol 'MEM' will appear on the display.
5. Whilst 'MEM' is flashing, press the **Memory Up or Down buttons** to select the preset number position where you want to store the station.
6. Press and release the **Programme Memory** button to store the station. The preset number will now appear alongside 'MEM' in the display.
7. Repeat the above procedure for the remaining presets.
8. The radio can be switched off by rotating the **Function switch** to the 'Off' position.

Note: Pre-setting of stations can only be carried out whilst 'MEM' is flashing in the display.

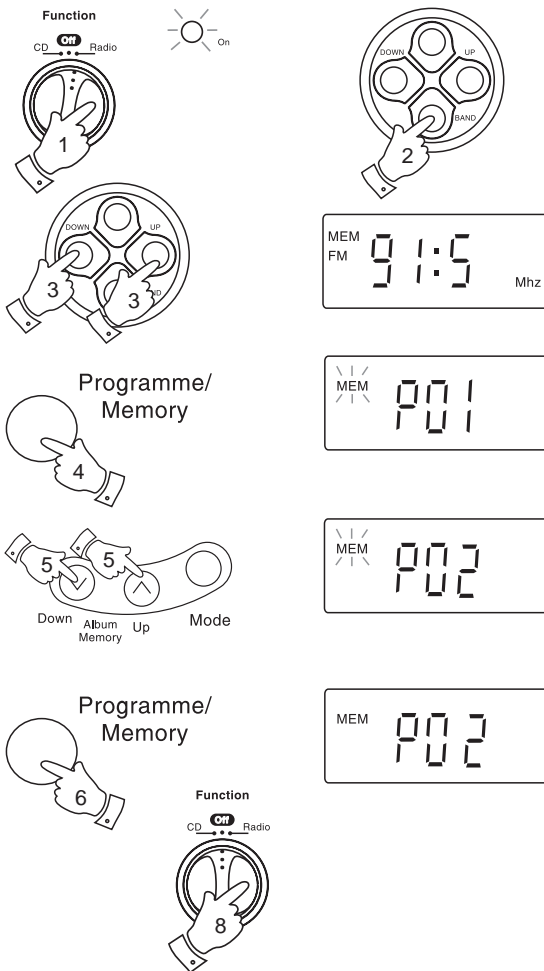

Recalling a preset station

1. Switch on your MP3 CD radio by rotating the **Function switch** to the 'Radio' position. The **On indicator** will light.
2. Press the **Waveband button** to either the 'FM' or 'MW' position. The band symbol will appear in the display.
3. Press the **Memory Up** or **Down buttons** to recall the stored preset station. Use **Memory Up** or **Down buttons** to step through the available stations.

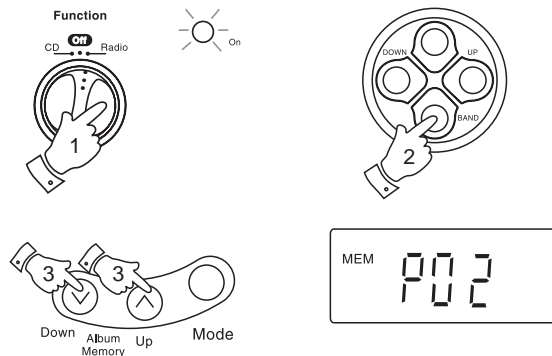

Last station memory

1. Your MP3 CD Radio provides an automatic last station memory function. This function recalls the station that was playing when the radio was switched off.

Compact discs

Use only Digital Audio CDs which have the  symbol.

Never write on a CD or attach any sticker to the CD. Always hold the CD at the edge and store it in its box after use with the label facing up.

To remove dust and dirt, breathe on the CD and wipe it with a soft, lint free cloth in a straight line from the centre towards the edge.

Cleaning agents may damage the CD.

Do not expose the CD to rain, moisture, sand, or to excessive heat. (e.g. from heating equipment or in motor cars parked in the sun).

CD-R/CD-RW discs

Your MP3 CD radio can playback CD-DA format audio CD-R/CD-RW discs that have been finalised* upon completion of recording.

Your MP3 CD radio may fail to playback some CD-R/CD-RW discs due to poor recording of the CD-R/CD-RW disc.

*Finalising enables a CD-R/CD-RW disc to playback on audio CD players such as your MP3 CD radio.

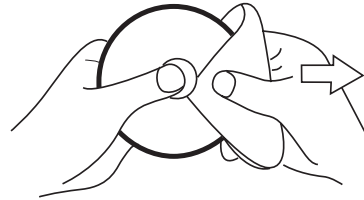

Warning

CLASS 1 LASER PRODUCT means that the laser's construction makes it inherently safe so that the legally prescribed maximum permissible radiation values can never be exceeded.

Caution: Using any equipment or devices other than those described and specified in these operating instructions, or tampering with the unit in any way, can result in dangerous exposure to radiation.

**CLASS 1
LASER PRODUCT**

Inserting a CD

1. Rotate the **Function switch** to the 'CD' position. The **On indicator** will light.
2. If you select a CD and have not inserted a CD, '---' will appear on the display.
3. To open the cd compartment, press on the edge marked Open/Close on the **CD door**.
4. Insert an audio CD, printed side facing up. Press the CD onto the spindle until it clicks into place. Close the door. The CD player will scan the contents of the CD and the total number of tracks will appear on the display.

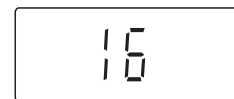
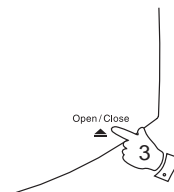
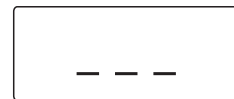
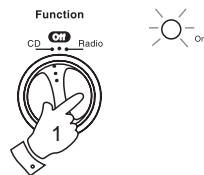

Playing a CD

1. Press the **Play/Pause button** to start playback. The display will show the track number.
2. Set the **Volume** and press the **Deep bass boost button** to the required settings.
3. To pause playback press the **Play/Pause button**. To resume playback press the **Play/Pause button** again.
4. To stop playback, press the **Stop button**. The total number of CD tracks will be displayed.
5. To take out the CD, open the door by pressing on the edge marked **Open/Close**. The CD door should only be opened when the CD is in stop mode.

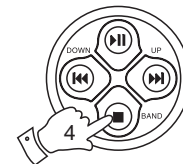
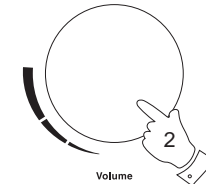
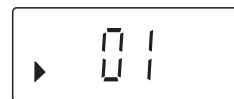
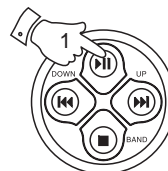

DBB
DEEP
BASS BOOST

— On
■ Off

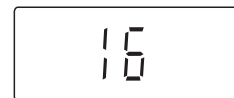
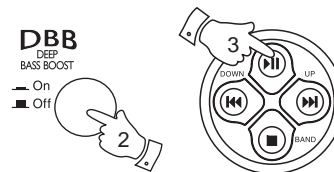

Selecting a track

1. Whilst the CD is playing, press either the **F. Skip** or **B. Skip buttons** to change to the desired track, the track number appears in the display.
2. You can also skip tracks when the player is in stop mode. Skip to the desired track using the **F. Skip** or **B. Skip buttons**. Press and hold the button to make the track numbers cycle, release the button when the desired track is displayed.
3. Press the **Play/Pause button** to play the selected track.

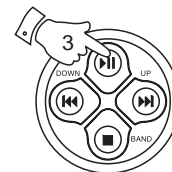
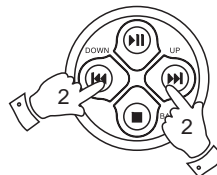
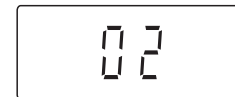
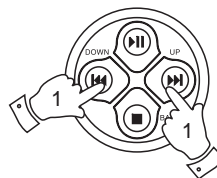

Search function

1. Whilst the CD is playing, press and hold the **F. Skip** or **B. Skip buttons**.
2. Release the button when the desired part of the track is reached.

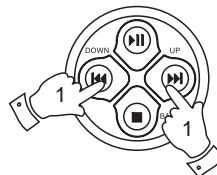

CD Repeat mode

1. Whilst the CD is playing, press the **Mode button** once. The current track is repeated.
2. Press the **Mode button** twice to repeat all tracks on the cd. The repeat indicator will show in the display.
3. Press the **Mode button** again to return to normal play. The repeat indicator will disappear.

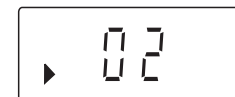
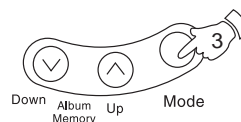
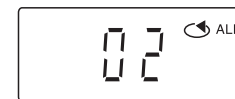
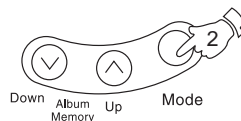
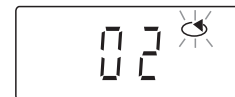
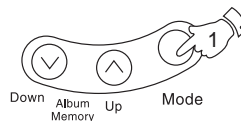

CD Random mode

1. Whilst the CD is in stop mode, repeatedly press the **Mode button** until the random indicator 'RND' appears in the display.
2. Press the **Play/Pause button** to begin random playback. All tracks on the CD will be played back once in random order.
3. To stop random playback, press the **Mode button** again.

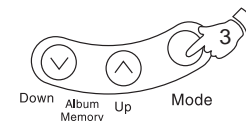
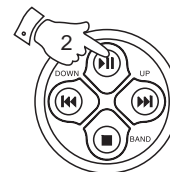
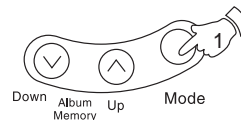

Programmed play

By programming the player you can play up to 20 tracks in any desired order.

1. Whilst the CD is in Stop mode, press the **Programme/Memory button**. The display will flash '00' and 'MEM' flashes on the display.
2. Select the first track using the **F. Skip** or **B. Skip buttons**. The track number will flash on display.
3. Store this track by pressing the **Programme/Memory button**. The display will flash ('00') and 'MEM' will flash on the display.
4. Repeat the above steps until you have completed your programme (maximum 20 tracks). Press the **Play/Pause button** to commence play of selected tracks.
5. To stop the programme, press the **Stop button**. The display will show the total number of tracks.
6. To resume programme play press the **Programme/Memory button**. The display will flash the programmed track.

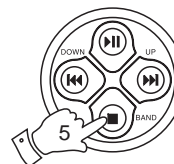
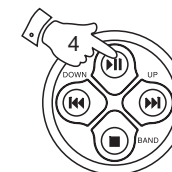
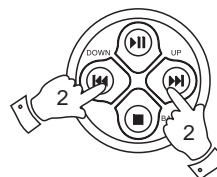
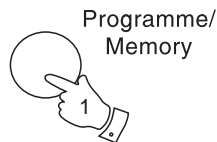

Editing a programme

1. Whilst the CD is in Stop mode, repeatedly press the **Programme/Memory button** to step through the tracks programmed until you find the desired track number. The display will flash the track number ('02') once and 'MEM' will flash.



2. Select a new track using the **F. Skip** or **B. Skip** buttons. The track number will flash on the display.
3. Store the track by pressing **Programme/Memory** button. The display will flash the selected track number ('16'). The new track has been stored in the programme.
4. Press the **Play/Pause** button to play the revised programme tracks.

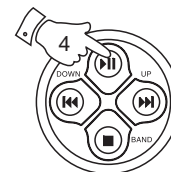
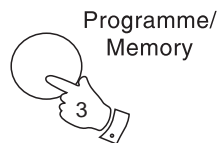
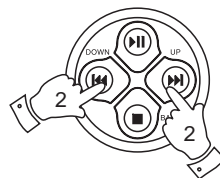

Checking a programme

1. Whilst the CD is in Stop mode, repeatedly press the **Programme/Memory** button to step through the tracks programmed. The display will flash each programmed track number in sequence.
2. Resume play by pressing the **Play/Pause** button.

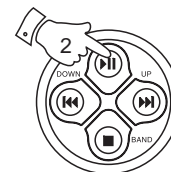
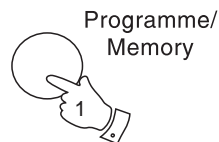

Erasing a programme

1. Whilst the CD is in Stop mode, open the CD door to erase the programme. Programmes are also erased by changing position of the **Function** switch to 'Off' or to the 'Radio' position.

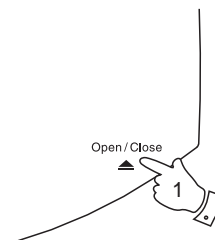

MP3 Mode

The device is suitable for CD-Rs and CD-RWs with MP3 formats, MP3 files must be created at a sampling frequency of 44.1 kHz.

In MP3 mode the terms 'album' and 'file' are very important. 'Album' corresponds to a folder on a PC, 'File' to a PC or a CD-DA track. The device reads MP3 files with a maximum of 255 files per album. An MP3 CD may not contain more than 512 files or albums in total.

The device sorts albums, or the files on an album, by name into alphabetical order. If you wish to order them differently, change the name of the file or album and put a number before the name.

When burning CD-R and CD-RWs with audio files, various problems may arise which could lead to interference in playback. This can be caused by faulty software or hardware settings or by the CD being used. Should such problems arise, contact the customer services of your CD burner or software manufacturer or look for relevant information, for example on the internet. When you are making audio CDs, observe all legal guidelines and ensure that the copyright of third parties is not infringed.

Playing an MP3 CD

- 1 Follow steps for inserting a CD previously. The display will show the album number.
2. Press the **Play/Pause button** to start playback. The display will show the track number.
3. Set the **Volume** and press the **Deep bass boost button** to the required settings.
4. To pause playback press the **Play/Pause button**. To resume playback press the **Play/Pause button** again.
5. To stop playback, press the **Stop button**. The total number of albums will be displayed.
6. To take out the CD, open the door by pressing on the edge marked **Open/Close**. The CD door should only be opened when the CD is in stop mode.

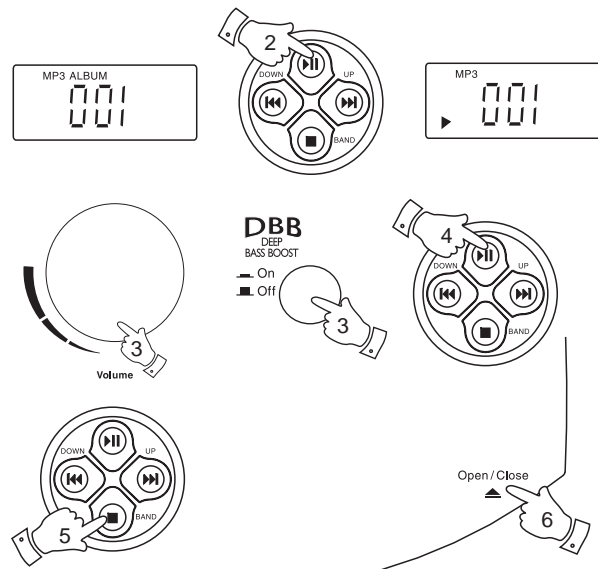

Selecting albums and files

1. Select the album during playback by pressing the **Album/Memory Down** or **Up** button.
2. Select the file you want by pressing **F. Skip** or **B. Skip**. Playback of the selected file starts automatically after a short time.
3. Note: You can also select albums and files in the stop position. However, you must then start playback of the file using the **Play/pause button**. The root album is shown as number '1'. However, you can only select an album if it actually contains MP3 files.

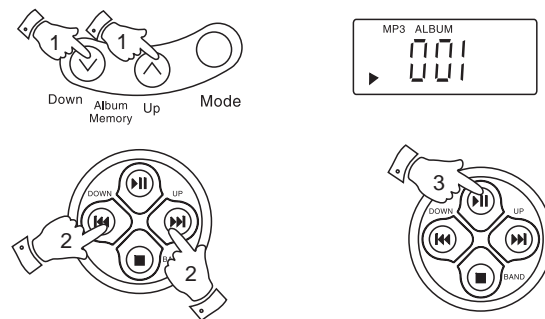

Repeating a file (Repeat 1 file)

1. During playback, press the **Mode button** until the repeat indicator appears on the display.
2. To stop the function, press the **Mode button** until the repeat indicator disappears.

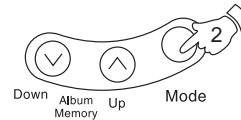
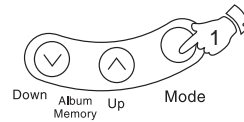

Repeating all files in an album (Repeat album)

1. During playback press the **Mode button** twice. All the files on the current album are played back.
2. To stop the function, press the **Mode button** until the repeat indicator disappears.

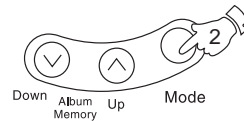
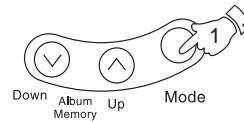

Repeating all files (Repeat all)

1. During playback press the **Mode button** until the 'ALL' indicator appears in the display. The whole CD is played back.
2. To stop the function, press the **Mode button** until the repeat indicator disappears.

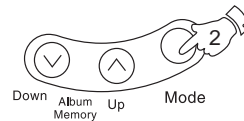
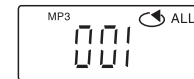
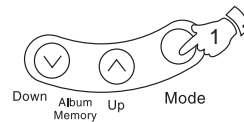

Playing back files in random order

1. In Stop mode, press the **Mode button** until 'RND' appears in the display.
2. Press the **Play/Pause button** to start random playback. All files on the CD are played back once in random order.
3. To stop the function, press the **Mode button** until the random indicator disappears.

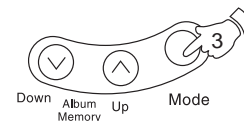
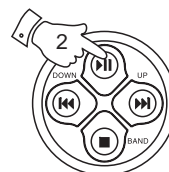
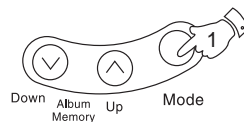

Programming tracks

You can store and then playback up to 20 titles from various albums on the disc in a set order. A file may be stored more than once.

1. Whilst the CD is in stop mode press the **Programme/Memory button**. The display will show '000' for the first preset position. 'MEM' will flash on the display.
2. Select the album by pressing the **Album Memory Up or Down buttons**.
3. Select the file you want by pressing the **F Skip or B Skip** buttons.
4. Press the **Programme/Memory button** to save the file. The display will show '000' for the second preset position and 'MEM' will flash on the display.
5. To save more files repeat steps 2 to 4 above.

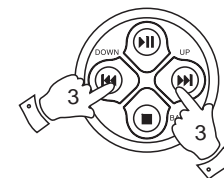
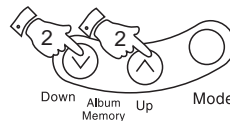
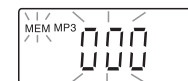
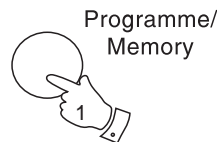

Playing a programmed track

1. Start programmed play by pressing the **Play/Pause button**. Playback begins with the first programmed file.
2. To stop playback press the **Stop button**.
3. To play the programmed track again press the **Programme/Memory button** and then **Play/Pause button**.

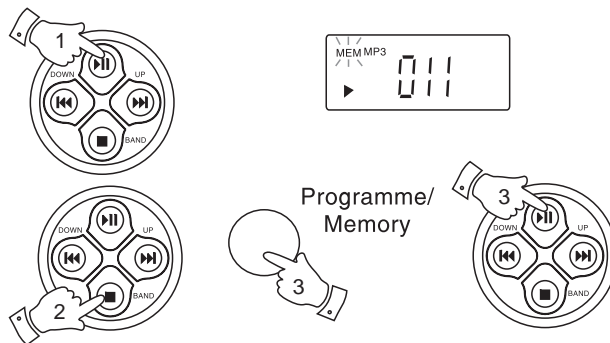

Editing a programme

1. In Stop mode, repeatedly press the **Programme/Memory button** until the file number you require appears in the display.
2. Select the number of the new folder by pressing the **Album/Memory Down** or **Up** buttons.
3. Select the number of the new file or track by pressing the **F. Skip** or **B. Skip** buttons.
4. Press the **Programme/Memory button** to store the new file.

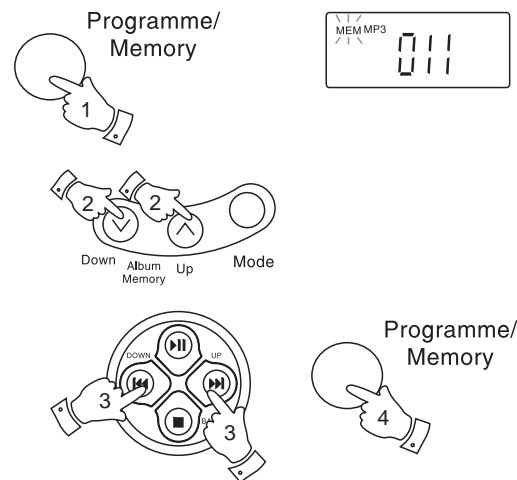

If you need any further advice, please call our Technical Helpline on :-

020 8758 0338 (Mon-Fri)

Download from www.Somanuals.com. All Manuals Search And Download.

Adding a new file

1. In Stop mode, repeatedly press the **Programme/Memory** button until the file number shown is zero.
2. Select the number of the new folder by pressing the **Album/Memory Down** or **Up** buttons.
3. Select the number of the new file or track by pressing the **F. Skip** or **B. Skip** buttons.
4. Press the **Programme/Memory** button to store the file.

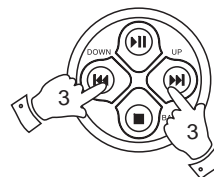
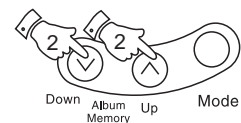
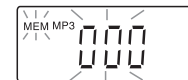

General

Do not allow this unit to be exposed to moisture (e.g. dripping or splashing) or to temperatures exceeding 70 degrees centigrade. It is recommended that the FM band be used wherever possible as better results in terms of quality and freedom from interference will usually be obtained than on the MW band.

Mains supply

The CD9989 will operate from a supply of AC 230volts, 50Hz \sim only.

For your convenience this product is supplied with a plug which is fitted with a fuse of the appropriate rating. If the plug supplied is not suitable for your socket outlet, it should be removed by unscrewing the plug top, the terminal screws, and removing the cable.

The correct style of plug to suit your household together with a correctly rated fuse should be fitted.

IF IN DOUBT - CONSULT A QUALIFIED ELECTRICIAN

IMPORTANT. DO NOT make any connection to the larger terminal which is marked with the letter E or by the safety earth symbol \perp or coloured Green or Green-and-yellow.

The wires in the mains lead are coloured in accordance with the following codes :-

BLUE - NEUTRAL

BROWN - LIVE

As these colours may not correspond with the coloured markings identifying the terminals in your plug, proceed as follows:-

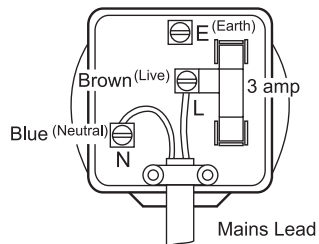

The wire coloured BLUE must be connected to the terminal marked N or coloured BLACK.

The wire coloured BROWN must be connected to the terminal marked L or coloured RED.

If you need any further advice, please call our Technical Helpline on :-
020 8758 0338 (Mon-Fri)

Download from www.Somanuals.com. All Manuals Search And Download.

Fuse

This apparatus must be protected by a 3A fuse (BS1362) in a 13A plug (BS1363). If another type of plug is used a 5A fuse should be fitted in the plug, adaptor or distribution board.

IF IN DOUBT - CONSULT A QUALIFIED ELECTRICIAN.

Underneath

The nameplate is located on the underside of your CD radio.

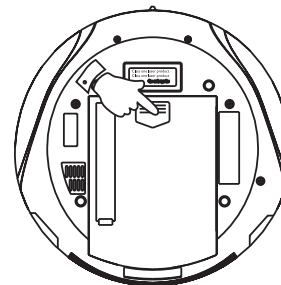

Headphones

A 3.5mm Headphone socket located on the left side of the unit is provided for use with either headphones or an earpiece. Inserting a plug into the socket automatically mutes the internal loudspeaker.

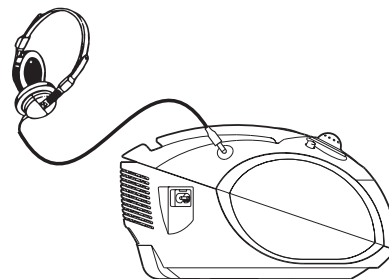

Specifications

Notes:

Power Requirements

Mains	AC 230 volts, 50Hz \sim only
Batteries	6 x LR14 (C size)
Back-up batteries	2 x LR6 (AA) size
Headphone socket	3.5mm diameter

Frequency Coverage

FM	87.5 - 108MHz
MW	522 - 1620 kHz

Circuit features

Output power	2 x 1 Watt
Aerial System	FM Telescopic aerial
	MW Built-in Ferrite bar aerial

MP3 features

Playback format	MPEG 1 layer 3 (MP3)
Sampling frequency	44.1 kHz
File system/file management	ISO 9660 Level 1 compatible

The Company reserves the right to amend the specification without notice.

Guarantee

This instrument is guaranteed for twelve months from the date of delivery to the original owner against failure due to faulty workmanship or component breakdown, subject to the procedure stated below. Should any component or part fail during this guarantee period it will be repaired or replaced free of charge.

The guarantee does not cover:

1. Damage resulting from incorrect use.
2. Consequential damage.
3. Receivers with removed or defaced serial numbers.

Procedure:

Any claim under this guarantee should be made through the dealer from whom the instrument was purchased. It is likely that your Roberts' dealer will be able to attend to any defect quickly and efficiently, but should it be necessary the dealer will return the instrument to the company's service department for attention. In the event that it is not possible to return the instrument to the Roberts' dealer from whom it was purchased, please contact Roberts Radio Technical Services at the address shown on the rear of this manual.

These statements do not affect the statutory rights of a consumer.

If you need any further advice, please call our Technical Helpline on :-

020 8758 0338 (Mon-Fri)

Download from www.somanuals.com. All Manuals Search And Download.

ROBERTS RADIO TECHNICAL SERVICES

97-99 Worton Road
Isleworth Middlesex
TW7 6EG

Technical Helpline:- 020 8758 0338 *(Mon-Fri)*

Issue 1



Free Manuals Download Website

<http://myh66.com>

<http://usermanuals.us>

<http://www.somanuals.com>

<http://www.4manuals.cc>

<http://www.manual-lib.com>

<http://www.404manual.com>

<http://www.luxmanual.com>

<http://aubethermostatmanual.com>

Golf course search by state

<http://golfingnear.com>

Email search by domain

<http://emailbydomain.com>

Auto manuals search

<http://auto.somanuals.com>

TV manuals search

<http://tv.somanuals.com>