

# ROBERTS

## Sound for Generations

# R983

### 3 Band Portable Radio

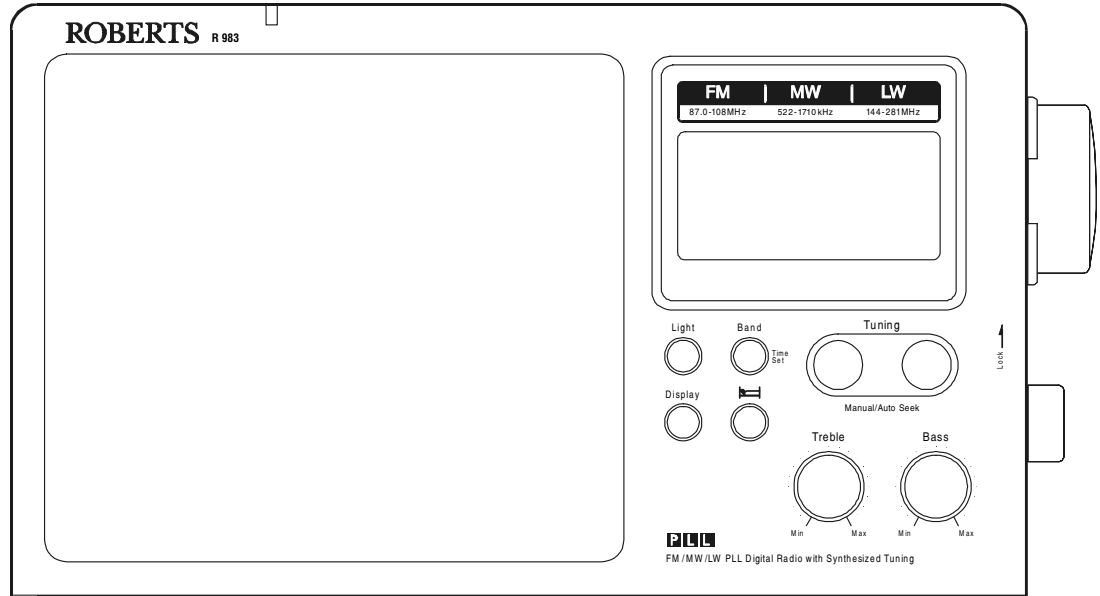

Please read this manual before use

# Controls

(Front)

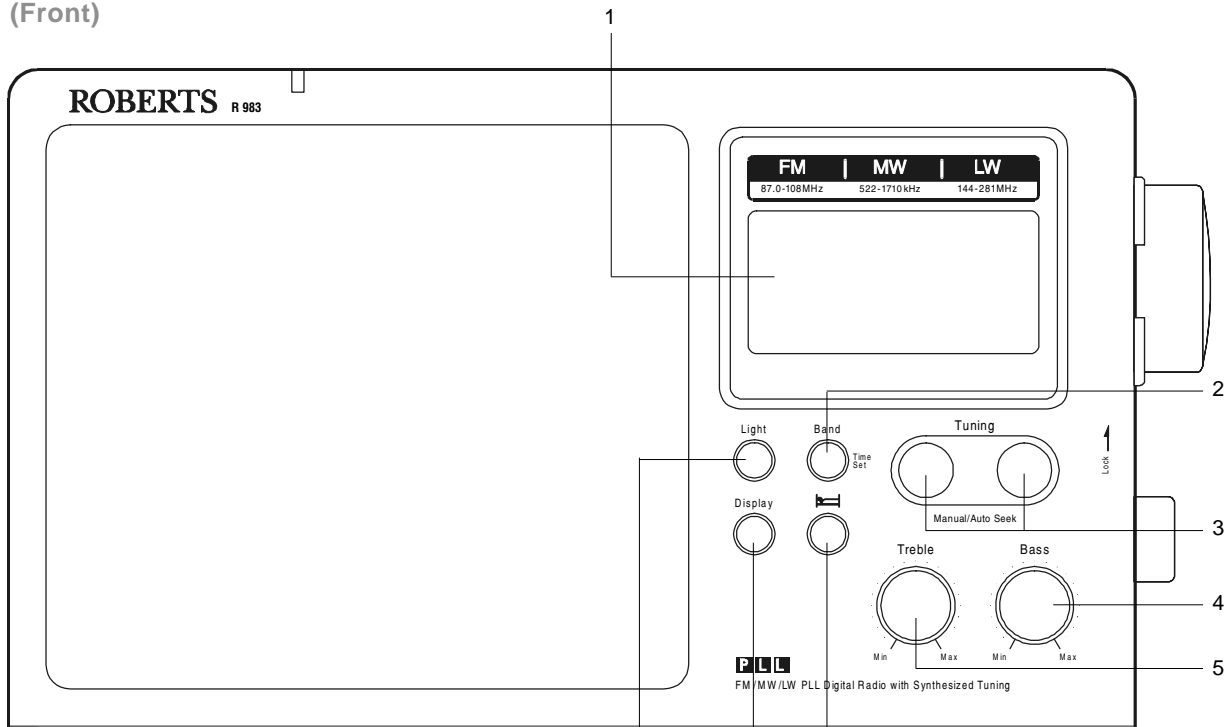

- 1. Liquid crystal display
- 2. Band button
- 3. Tuning up/down buttons
- 4. Bass control

- 5. Treble control
- 6. Sleep button
- 7. Display button
- 8. Light button

## Controls

(Top)

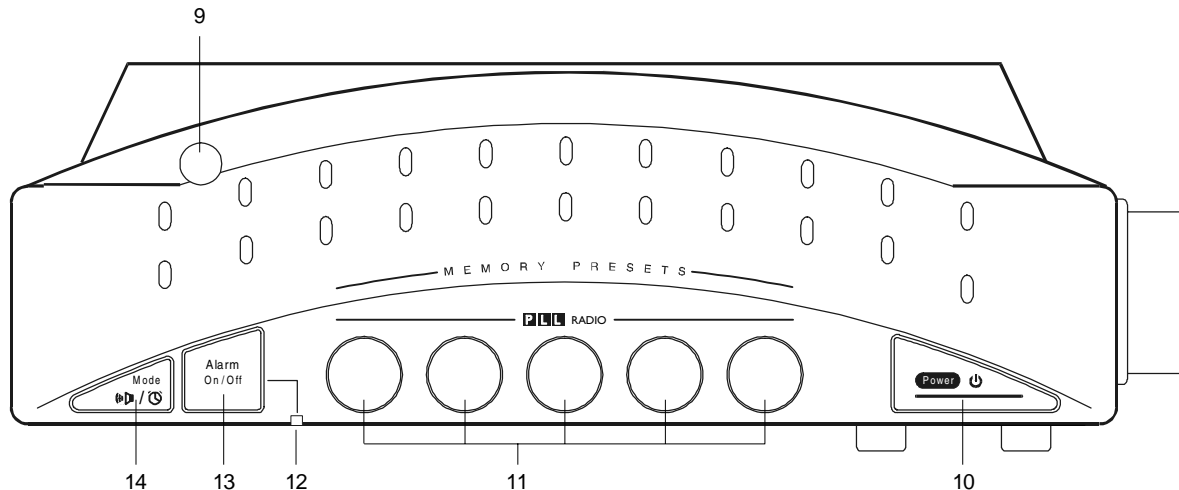

- |                         |                         |
|-------------------------|-------------------------|
| 9. Telescopic aerial    | 12. Alarm on indicator  |
| 10. Power on/off button | 13. Alarm On/Off button |
| 11. Preset buttons      | 14. Alarm mode button   |

If you need any further advice, please call our Technical Helpline on :-

0181 758 0338 (Mon-Fri)

Download from [www.Somanuals.com](http://www.Somanuals.com). All Manuals Search And Download.

## Controls

(Right side)

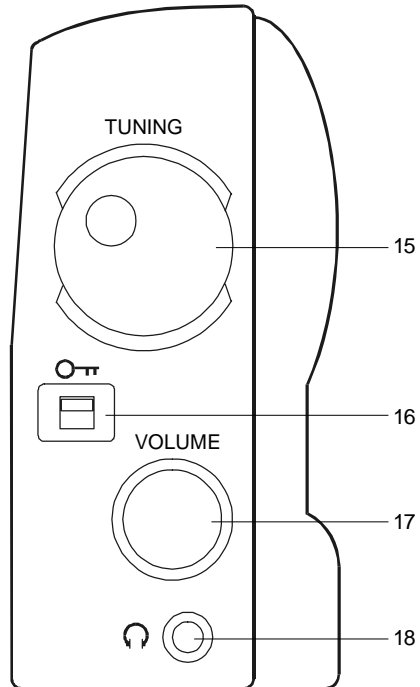

- 15. Tuning control
- 16. Lock Switch
- 17. Volume control
- 18. Headphone socket

## Controls

(Rear)

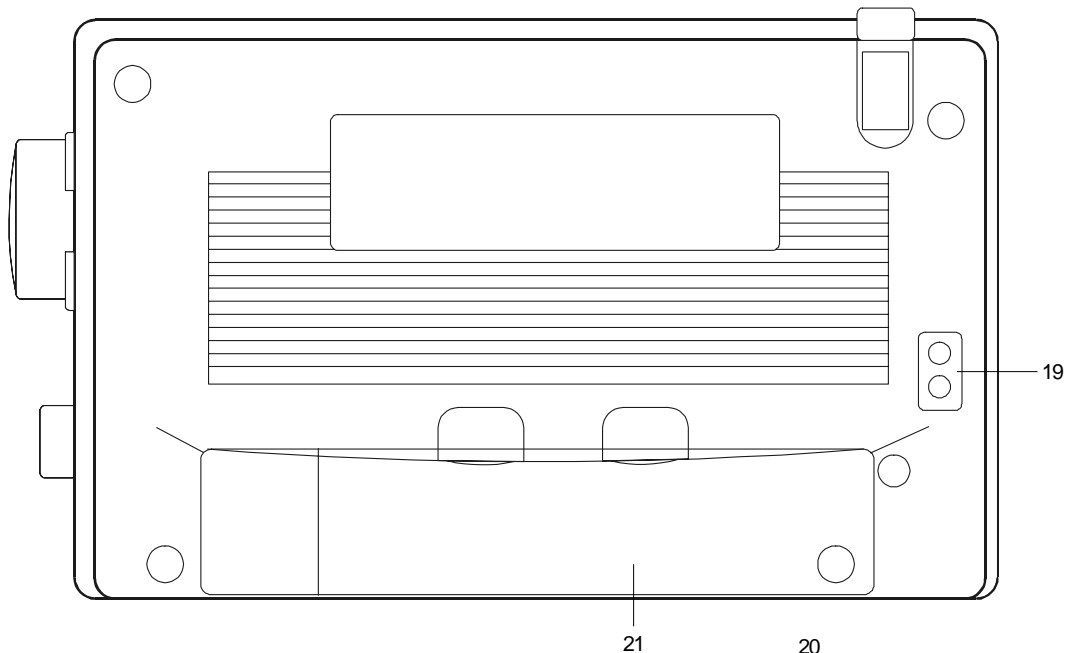

(Underside)

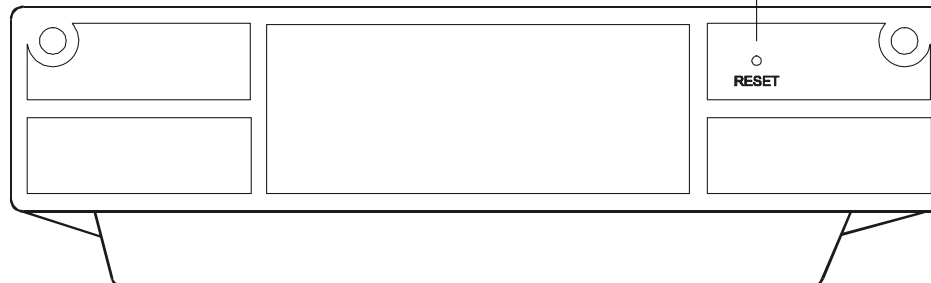

19. Mains socket

20. Reset button

21. Battery compartment

*If you need any further advice, please call our Technical Helpline on :-*

*0181 758 0338 (Mon-Fri)*

Download from [www.Somanuals.com](http://www.Somanuals.com). All Manuals Search And Download.

## Display

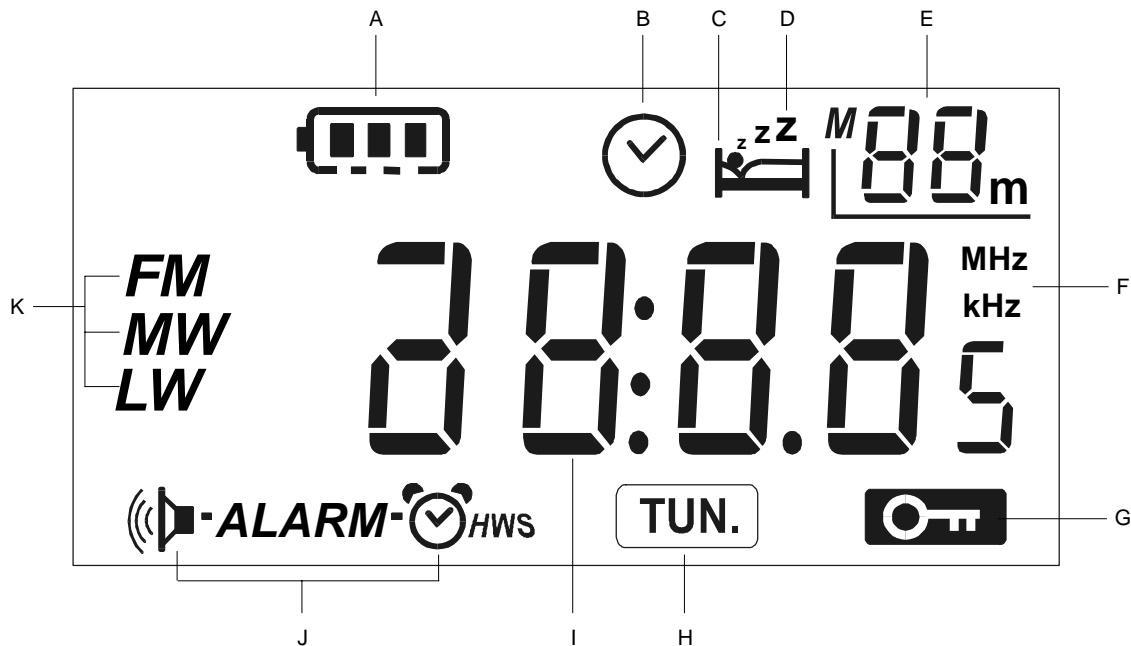

A. Battery level indicator

B. Real time indicator

C. Sleep indicator

D. Snooze indicator

E. Memory/Sleep time indicators

F. Frequency units

G. Key lock indicator

H. Tuning indicator

I. Frequency and clock segments

J. Alarm indicators

K. Waveband indicators



## Battery operation

1. Remove the **Battery cover** on the rear of the unit by pushing the catches in the direction of the arrows.
2. Insert four LR20 (D size) batteries into the spaces in the compartment. Take care to ensure all batteries are inserted with the correct polarity as shown inside the battery compartment. Replace the battery cover.
3. Reduced power, distortion, and a 'stuttering' sound are all signs that the batteries may need replacing.
4. If the radio is not to be used for any extended period of time it is recommended that the batteries are removed from the radio.

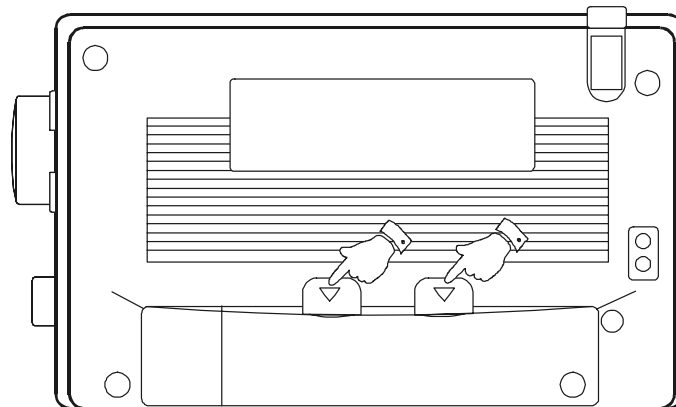
*We would recommend for economy, that the R983 is used on the mains whenever possible with battery operation for occasional or stand-by use only.*



## Battery replacement

1. The battery indicator will appear in the display for 7 seconds after the radio is switched on. The indicator will show  when the batteries are new. The batteries should be replaced when the indicator shows . After removing the batteries you have approximately 3 minutes to replace the batteries after which the clock and memory information will be lost

## Mains operation

1. Place your radio on a flat surface. Plug the mains lead into the **Mains socket** located on the rear of your radio ensuring that the plug is pushed fully into the socket. The batteries will be automatically disconnected.
3. Plug the other end into a wall socket and switch on. The **Display backlight** will light up indicating that the radio is connected to the mains supply.

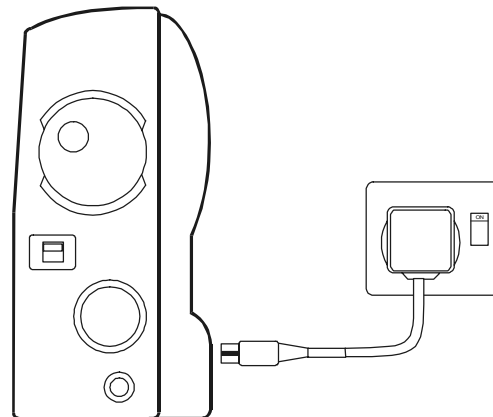

*If you need any further advice, please call our Technical Helpline on :-*

*0181 758 0338 (Mon-Fri)*

Download from [www.Somanuals.com](http://www.Somanuals.com). All Manuals Search And Download.

## Setting the clock

1. The clock will start running when the batteries are installed or when the radio is connected to the mains supply. The display will show **0:00** together with the real time symbol .
2. Ensure that the radio switched off.
3. Press the **Time set button**, the hours digits will flash in the display.
4. Press the **Tuning up/down** buttons to set the required hour.
5. Press the **Time set button**, the minute digits will flash in the display.
6. Press the **Tuning up/down** buttons to set the required minute.
7. Press the **Time set button** to complete time setting.
8. The seconds display will be set to **00**.

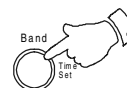
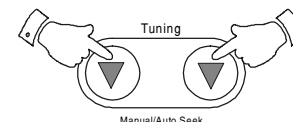
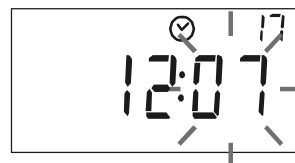
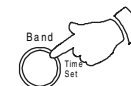
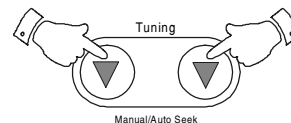
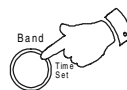
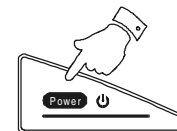



## Operating the radio

1. Your radio is equipped with four tuning methods:- Scan tuning, Rotary tuning, Manual tuning, and Memory preset tuning.

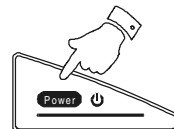

## Scan tuning

1. Press the **Power button** to turn on the radio.
2. Select the required waveband by repeatedly pressing the **Band** button. For the FM waveband fully extend the **Telescopic aerial** and set it at an angle of 45 degrees.
3. Press and hold down either the **Tuning up** or **Tuning down** buttons for more the 0.5 sec to commence scan tuning.
4. The radio will scan the selected waveband and stop automatically when it finds a station of sufficient strength. The tuning indicator **TUN.** will appear in the display.
5. To recommence scan tuning, press and hold down either the **Tuning up** or **Tuning down** buttons for more the 0.5 sec.
6. When the waveband end is reached the radio will bleep and continue tuning from the opposite waveband end.
7. Rotate the **Volume control** clockwise to increase the volume and anticlockwise to decrease the volume. Set the **Bass** and **Treble** controls to the desired settings.
8. To turn off the radio press the **Power button**.

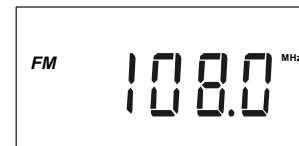
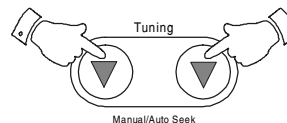
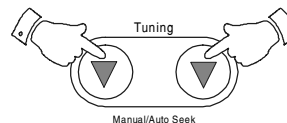
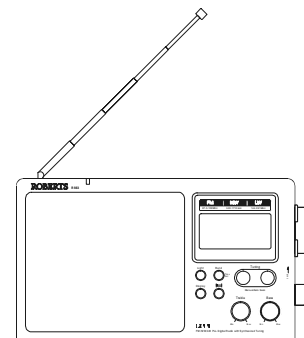
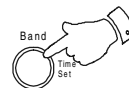

If you need any further advice, please call our Technical Helpline on :-

0181 758 0338 (Mon-Fri)

Download from [www.Somanuals.com](http://www.Somanuals.com). All Manuals Search And Download.

## Manual tuning

1. Press the **Power button** to turn on the radio.
2. Select the required waveband by repeatedly pressing the **Band** button. For the FM waveband fully extend the **Telescopic aerial** and set it at an angle of 45 degrees.
3. A single press on either the **Tuning up** or **Tuning down** buttons will change the frequency in the following increments:-

FM	100kHz
MW	9kHz
LW	9kHz
4. When a station is correctly tuned, the tuning indicator **TUN.** will appear in the display.

note: when the waveband end is reached the radio will bleep and continue tuning from the opposite waveband end.

5. Rotate the **Volume control** clockwise to increase the volume and anticlockwise to decrease the volume. Set the **Bass** and **Treble** controls to the desired settings.
6. To turn off the radio press the **Power button**.

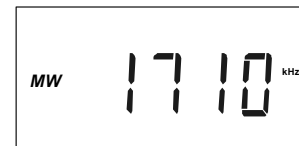
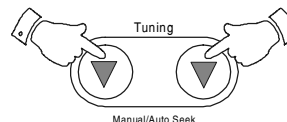
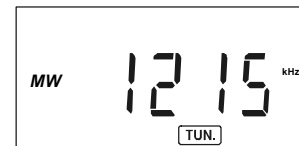
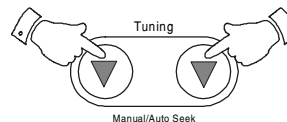
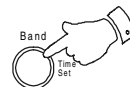
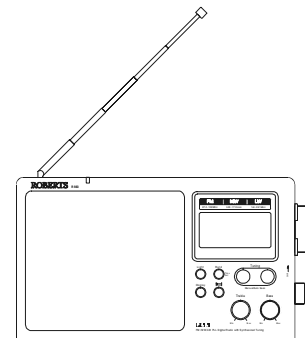
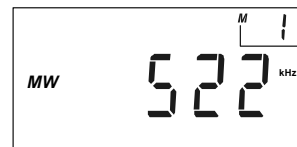

## Rotary tuning

1. Press the **Power button** to turn on the radio.
2. Select the required waveband by repeatedly pressing the **Band** button. For the FM waveband fully extend the **Telescopic aerial** and set it at an angle of 45 degrees.
3. Rotate the **Tuning control** to change the frequency in the following increments:-

FM	50kHz
MW	9kHz
LW	9kHz
4. When a station is correctly tuned, the tuning indicator **TUN.** will appear in the display.

note: when the waveband end is reached the radio will bleep and continue tuning from the opposite waveband end.
5. Rotate the **Volume control** clockwise to increase the volume and anticlockwise to decrease the volume. Set the **Bass** and **Treble** controls to the desired settings.
6. To turn off the radio press the **Power button**.

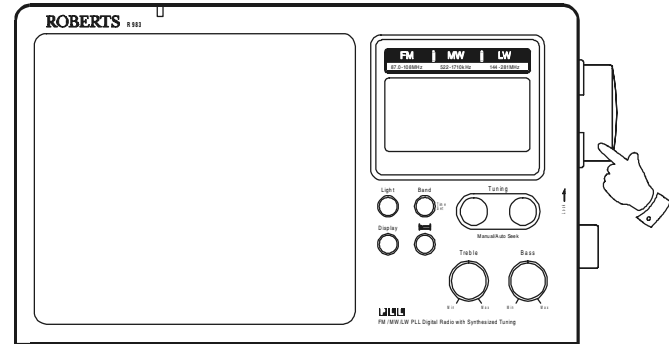
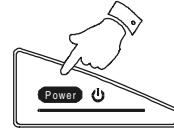

If you need any further advice, please call our Technical Helpline on :-

0181 758 0338 (Mon-Fri)

Download from [www.Somanuals.com](http://www.Somanuals.com). All Manuals Search And Download.

## Storing stations in preset memories

There are 5 memory presets for each waveband.

1. Press the **Power button** to turn on the radio.
2. Tune to the required station using one of the methods previously described.
3. Press and hold down the required preset for until the radio beeps (greater than 2 seconds) The preset number will appear in the display and the station will be stored under the chosen preset button.
4. Repeat this procedure for the remaining presets.
5. Stations stored in preset memories may be overwritten by following the above procedure.

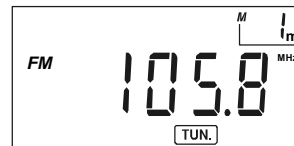
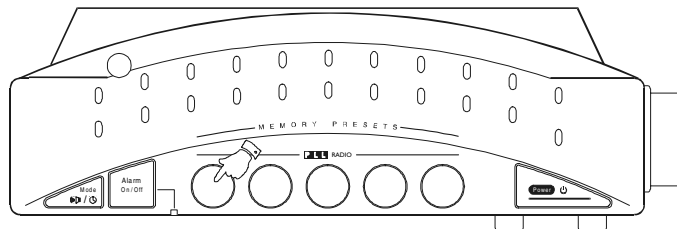

## Recalling stations from preset memories

1. Press the **Power button** to turn on the radio.
2. Select the required waveband by repeatedly pressing the **Band** button.
3. Momentarily press the required **Preset button**, the preset number and station frequency will appear in the display.

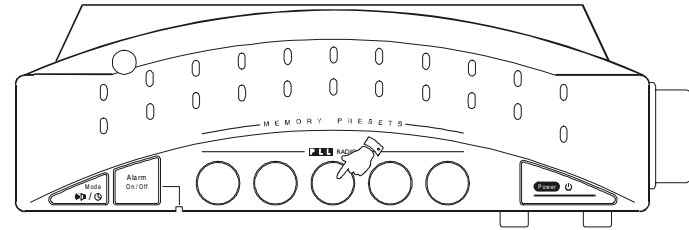
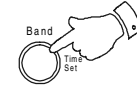
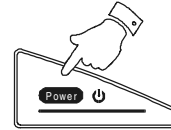

If you need any further advice, please call our Technical Helpline on :-

0181 758 0338 (Mon-Fri)

Download from [www.somanuals.com](http://www.somanuals.com). All Manuals Search And Download.

## Setting the radio alarm

When the radio alarm is selected the radio will turn on and play the last station listened to. The radio alarm will sound for one hour unless turned off by pressing the **Power button**. Pressing the **Power button** whilst the alarm is sounding will cancel the alarm for 24 hours.

1. The radio alarm time can be set with the radio switched on or off.
2. Press and hold down the **Alarm On/Off button** until the hour digits and alarm symbol flash in the display.
3. Repeatedly press the **Alarm mode button** until the display shows **ALARM**.
4. Set the required hour using the **Tuning up/down buttons**.
5. Press the **Time set button**, the minute digits will flash in the display.
6. Set the required minute using the **Tuning up/down buttons**.
7. Press the **Time set button** to complete alarm setting.
8. To permanently cancel the alarm press and hold down the **Alarm On/Off button** until the **ALARM** symbol is removed from the display.

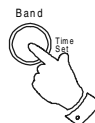
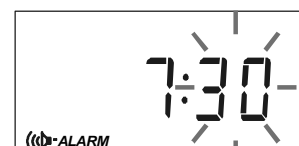
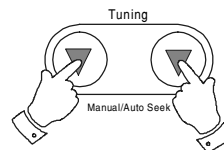
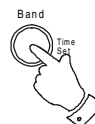
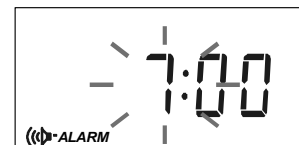
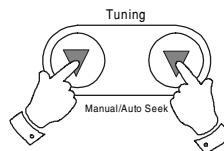
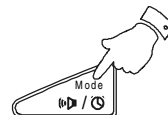
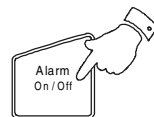

## Setting the HWS (Humane Wake System) alarm

A bleep tone will sound when using the HWS alarm. The alarm bleep will increase in volume every 15 seconds for one minute followed by one minutes silence before repeating the cycle. The HWS alarm will sound for one hour unless turned off by pressing the **Power button**. Pressing the **Power button** whilst the alarm is sounding will cancel the alarm for 24 hours.

1. The HWS alarm time can be set with the radio switched on or off.
2. Press and hold down the **Alarm On/Off button** until the hour digits and alarm symbol flash in the display.
3. Repeatedly press the **Alarm mode button** until the display shows **ALARM-🕒HWS**.
4. Set the required hour using the **Tuning up/down buttons**.
5. Press the **Time set button**, the minute digits will flash in the display.
6. Set the required minute using the **Tuning up/down buttons**.
7. Press the **Time set button** to complete alarm setting.
8. To permanently cancel the alarm press and hold down the **Alarm On/Off button** until the **ALARM-🕒HWS** symbol is removed from the display.

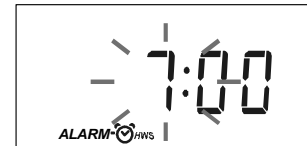
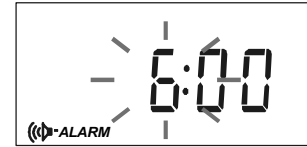
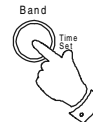
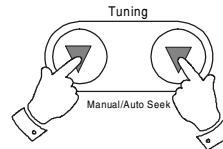
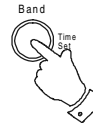
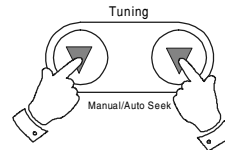
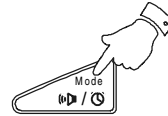
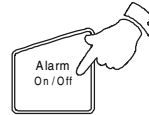

If you need any further advice, please call our Technical Helpline on :-

0181 758 0338 (Mon-Fri)

Download from [www.Somanuals.com](http://www.Somanuals.com). All Manuals Search And Download.



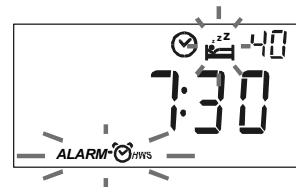

## Snooze function

1. Whilst the alarm is sounding pressing any button (except the **Power** or **Light button**) will activate the snooze function. The Radio or HWS alarms will be silenced for 5 minutes.
2. The Display will flash both the snooze symbol **z z Z** and the alarm symbol . The snooze function can be repeated during the 1 hour that the alarms are active.



## Sleep function

The sleep timer will automatically switch off the radio after a preset time has elapsed.

1. Press and continue to hold down the  button the display will cycle through the available sleep times in the order 90-60-30-15-90. Release the  button when the required sleep time appears in the display. The  symbol will appear in the display and the radio will play the last station selected.
2. To cancel the sleep function, press the **Power button**, the  symbol will disappear and the display will revert to showing real time.

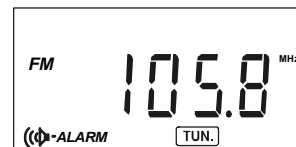

## Display backlight

When the radio is powered via the mains the display backlight will remain illuminated unless turned off by pressing the **Light button**.

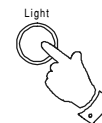

When your radio is powered by batteries pressing the **Light button** will turn on the display backlight and illuminate the display for approximately 2 minutes. The display backlight may be turned off immediately by pressing the **Light button**.





## Lock Switch

The **Lock switch** located on the right-hand side of your radio is used to prevent unintentional operation.

1. Set the **Lock switch** to the up 'locked' position, the  symbol will appear in the display. The **Power** and all other buttons will be disabled. This will prevent accidental operation when the radio is packed in a suitcase. To release the **Lock switch** move the switch to the down 'unlocked' position, the  symbol will be removed from the display.

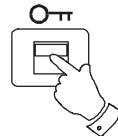

## Headphones socket

A 3.5mm **Headphone Socket** located on the right-hand end of your radio is provided for use with either headphones or an earpiece. Inserting a plug automatically mutes the internal loudspeaker.

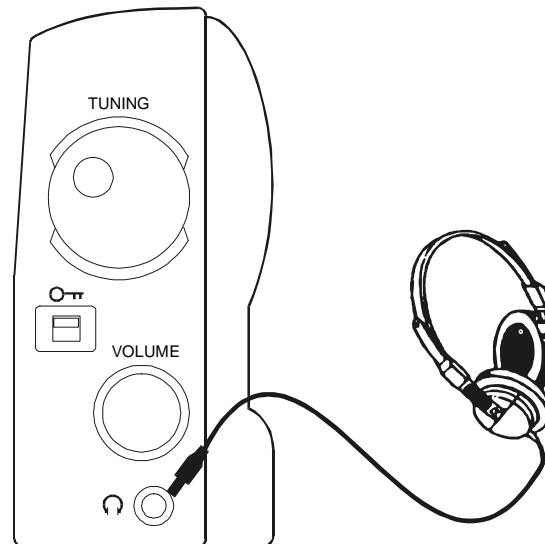

If you need any further advice, please call our Technical Helpline on :-

0181 758 0338 (Mon-Fri)

Download from [www.Somanuals.com](http://www.Somanuals.com). All Manuals Search And Download.

## Reset button

If the radio fails to operate correctly, or some digits on the display are missing or incomplete carry out the following procedure.

1. With the aid of a suitable implement (the end of a paper clip) press the reset button located on the underside of your radio for at least 5 seconds, this will reset the microprocessor, clock time and clear all stations stored in preset memory.

If a problem persists our technical staff would be pleased to help offer any assistance on operating the radio. Our technical helpline number is, 0181 758 0338.

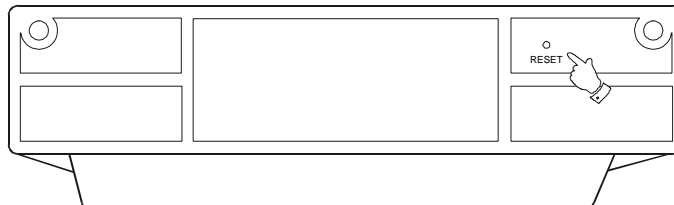

---

## Specifications

### Power Requirements

Mains	AC 230 volts, 50Hz $\sim$ only
Batteries	4 x LR20 (D size)

### Battery Life

Approx. 70 hours of listening for 4 hours a day at normal volume using alkaline cells.

### Frequency Coverage

FM	87.5-108MHz
MW	522-1710kHz
LW	144-279kHz

## Circuit Features

Loudspeaker	125mm 4ohms		
Output Power	Mains 1.8 Watts	Batteries 0.9 Watts	
Headphone socket	3.5mm dia		
Aerial System	FM Telescopic aerial	MW Built-in Ferrite aerial	LW Built-in Ferrite aerial

## General

Do not allow this unit to be exposed to water or steam. It is recommended that the FM band be used wherever possible as better results in terms of quality and freedom from interference will usually be obtained than on the MW or LW bands.

## Mains supply

The R983 will operate from a supply of AC 230 volts, 50Hz  $\sim$  only.

**DO NOT cut off the mains plug from this equipment.** If the plug fitted is not suitable for the power points in your home or the cable is too short to reach a power point, then obtain an appropriate safety approved extension lead or adaptor. If in doubt consult your dealer.

If nonetheless the mains plug is cut off, remove the fuse and dispose of the plug immediately, to avoid a possible shock hazard by inadvertent connection to the mains supply.

If this product is not supplied with a mains plug, or one has to be fitted, then follow the instructions given below:

**IMPORTANT. DO NOT** make any connection to the larger terminal which is marked with the letter E or by the safety earth symbol  $\perp$  or coloured Green or Green-and-yellow.

The wires in the mains lead are coloured in accordance with the following codes :-

BLUE - NEUTRAL

BROWN - LIVE

The wire coloured BLUE must be connected to the terminal marked N or coloured BLACK.

The wire coloured BROWN must be connected to the terminal marked L or coloured RED.

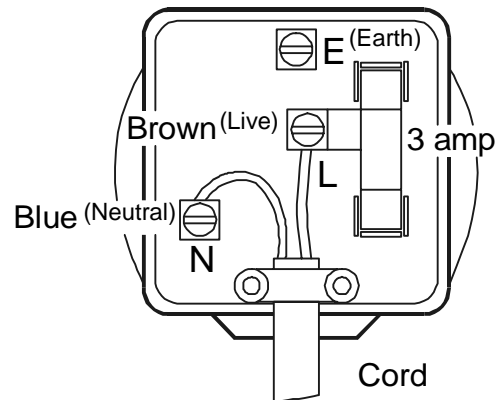

## Fuse

When replacing the fuse only a 3A ASTA approved to BS1362 type should be used and be sure to re-fit the fuse cover.

IF IN DOUBT - CONSULT A QUALIFIED ELECTRICIAN.

Replacement fuse holders are available from Roberts Radio Technical Services Department at the address shown on the rear of this manual.

If you need any further advice, please call our Technical Helpline on :-

0181 758 0338 (Mon-Fri)

Download from [www.Somanuals.com](http://www.Somanuals.com). All Manuals Search And Download.

## Guarantee

This instrument is guaranteed for twelve months from the date of delivery to the original owner against failure due to faulty workmanship or component breakdown, subject to the procedure stated below. Should any component or part fail during this guarantee period it will be repaired or replaced free of charge.

The guarantee does not cover:

1. Damage resulting from incorrect use.
2. Consequential damage.
3. Receivers with removed or defaced serial numbers.

N.B. Damaged or broken telescopic aerials will not be replaced under guarantee.

Procedure:

Any claim under this guarantee should be made through the dealer from whom the instrument was purchased. It is likely that your Roberts dealer will be able to attend to any defect quickly and efficiently, but should it be necessary the dealer will return the instrument to the company's service department for attention. In the event that it is not possible to return the instrument to the Roberts dealer from whom it was purchased, please contact Roberts Radio Technical Services department at the address shown below before taking further action.

*These statements do not affect the statutory rights of a consumer.*

## ROBERTS RADIO TECHNICAL SERVICES DEPARTMENT

97-99 Worton Road  
Isleworth Middlesex  
TW7 6EG

Technical Helpline:- 0181 758 0338 (Mon-Fri)

Issue 1



## Free Manuals Download Website

<http://myh66.com>

<http://usermanuals.us>

<http://www.somanuals.com>

<http://www.4manuals.cc>

<http://www.manual-lib.com>

<http://www.404manual.com>

<http://www.luxmanual.com>

<http://aubethermostatmanual.com>

Golf course search by state

<http://golfingnear.com>

Email search by domain

<http://emailbydomain.com>

Auto manuals search

<http://auto.somanuals.com>

TV manuals search

<http://tv.somanuals.com>