

ROBERTS

Sound for Generations

R9921

Multi-band RDS digital preset world radio

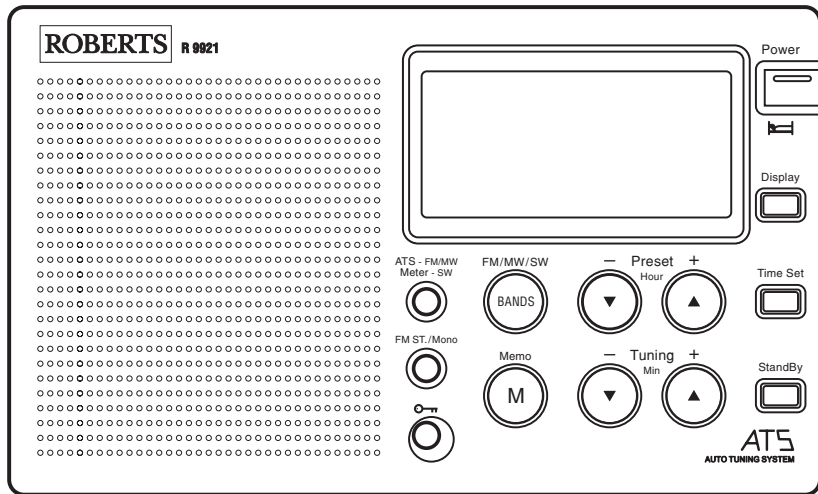

Contents

Features	1	FM mono/stereo button	19
Control locations	2	Setting the sleep timer	19
Display information	4	Display back light	20
Installing batteries	5	Lock button	20
Battery replacement	6	AC adaptor	21
Setting the clock automatically	6	Headphones	22
Setting the clock manually	8	Troubleshooting/reset button	23
Setting the buzzer alarm	9	Specifications	24
Setting the radio alarm	10	Guarantee	25
Search tuning	11		
Manual tuning	12		
MW (AM) tuning step size	13		
Presetting stations	14		
Recalling a preset station	15		
Memory scan	15		
ATS (Automatic Tuning System)	16		
Operating your radio using RDS	17		
Display modes	18		

Features

- Large easy to read Liquid Crystal Display (LCD) showing station name, frequency, time, memory location and function status.
- RDS station name display.
- Twenty seven memory presets offer instant access to your favourite stations on MW, SW and FM.
- Automatic time set via RDS signal.
- ATS (Auto Tuning System) - scans MW and FM bands, automatically storing stations in preset memories.
- Scanning circuit allows you to search for active stations.
- Memory scan - scans preset memories.
- SW meter button offers instant selection of any desired SW band.
- Wake to radio or buzzer alarms.
- Humane wake system - buzzer alarm gradually increases in volume.
- Adjustable sleep timer allows you to fall asleep to music.
- Snooze function - turns off alarm for five minutes.

Controls

1. ATS/SW band select
2. Liquid crystal display.
3. Preset/Hour - button.
4. Preset/Hour + button.
5. Power/Sleep button.
6. Display button.
7. Time set button.
8. Standby button.
9. Tuning/Minute + button
10. Tuning/Minute - button
11. Memory button.
12. Waveband button.
13. Lock button.
14. Stereo/Mono button

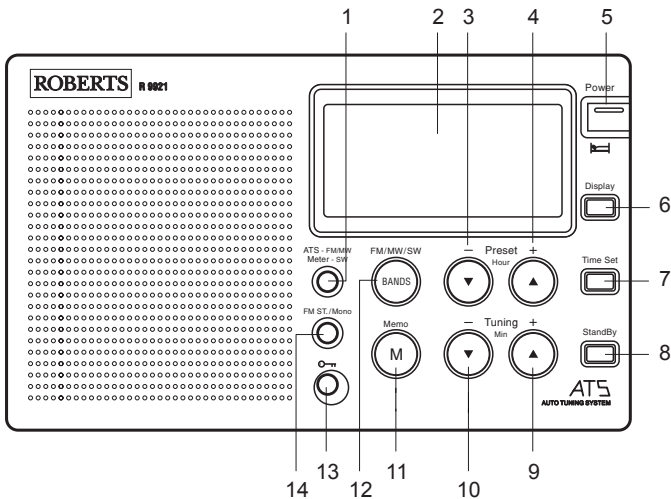

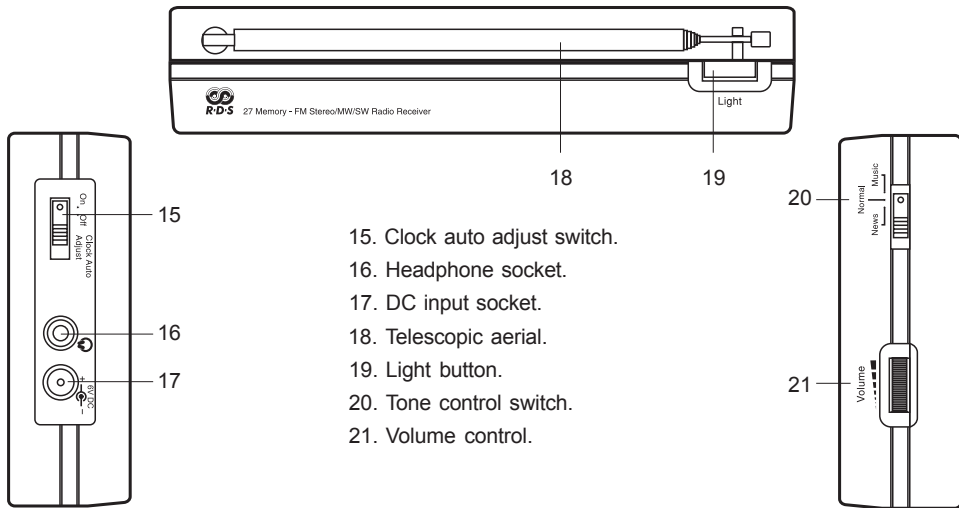

- 15. Clock auto adjust switch.
- 16. Headphone socket.
- 17. DC input socket.
- 18. Telescopic aerial.
- 19. Light button.
- 20. Tone control switch.
- 21. Volume control.

Display

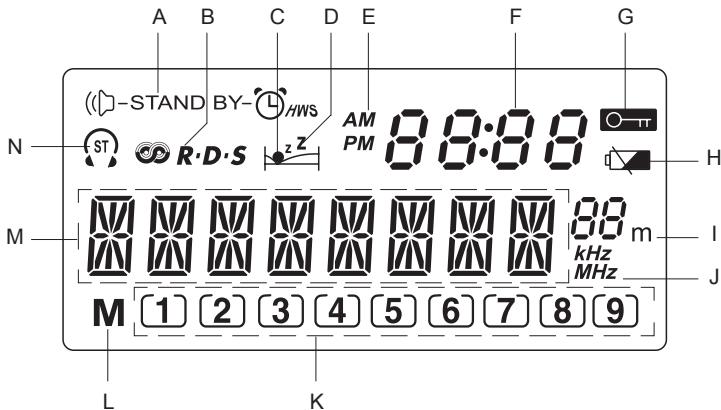

A. Alarm indicators

B. RDS indicator.

C. Sleep time indicator.

D. Snooze indicator.

E. AM/PM indicators.

F. Time.

G. Key lock indicator.

H. Low battery indicator.

I. SW band

J. Frequency units.

K. Memory number.

L. Memory indicator.

M. Frequency and text indicators.

N. Stereo indicator.

Installing batteries

1. Position the radio face down on soft surface.
2. Press the catch as shown and slide in the direction of the arrow.
3. Lift out the battery cover
4. Insert 4 x LR6 (AA) size batteries as shown in the diagram.
5. Replace the battery cover.

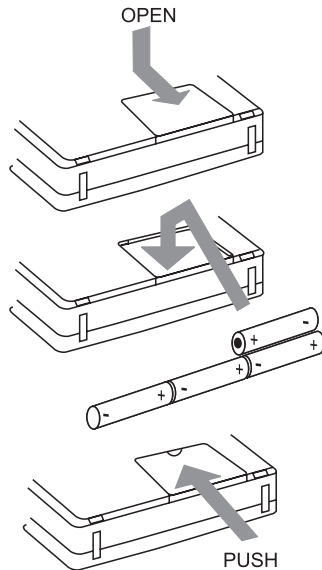

Battery replacement

The battery indicator will appear in the display immediately your radio is switched off. Batteries should be replaced when the indicator shows less than 3. After removing batteries you have approximately 3 minutes to replace the batteries after which clock and memory information will be lost.

When the low battery indicator  appears in display replace batteries immediately.

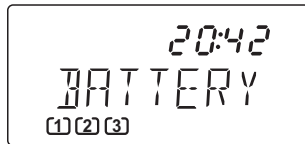

Setting the clock automatically

The clock time can be set automatically when receiving an RDS station that transmits clock time (CT). The CT information is transmitted once every minute. If the station has sufficient signal strength the clock will set within one or two minutes.

1. Switch on the radio with the **Power button**.
2. Select the FM waveband by repeat pressing of the **Bands button**.
3. Fully extend the **Telescopic aerial**.

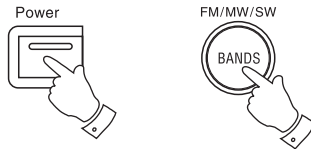

4. Press and hold down the **Tuning up or down buttons** until the frequency in the display begins to change rapidly, release the button.
5. The radio will now start to search the FM waveband and will stop when it finds a station of sufficient strength. If the station is of sufficient strength the **RDS** symbol will light up in the liquid crystal display.
6. Slide the **Clock auto adjust switch** to the 'On' position.
7. The time segments --:-- will flash in the liquid crystal display indicating that the radio is waiting for the RDS time signal. When the time is set the display will show the time. If the clock does not set within three to four minutes, the radio station may not be transmitting clock time (CT) information - try another radio station.
8. When your radio is switched off the **RDS** symbol will remain lit indicating that the time has been set via the RDS signal.

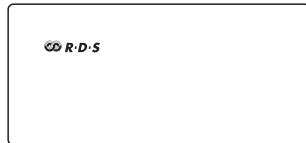
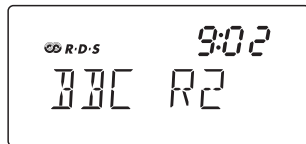
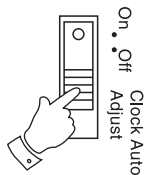
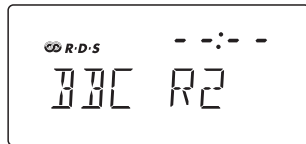
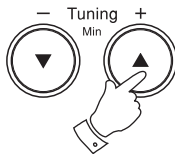

Setting the clock time manually

When batteries are installed for the first time the display will show -- : --.

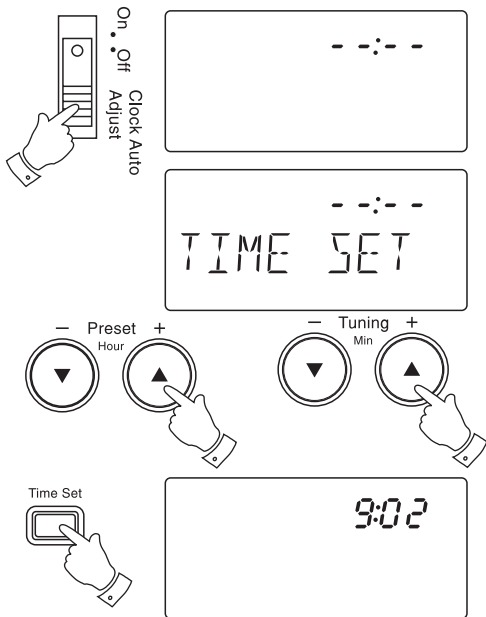

Time can be manually set with the radio switched on or off. The clock uses the 24 hour system e.g. 2:00pm is shown as 14:00.

1. Slide the **Clock auto adjust switch** to the 'Off' position
2. Press and release the **Time set button**, the display will show '**TIME SET**'
3. The clock uses the 24 hour system e.g. 2:00pm is shown as 14:00. Set the correct hour using the **Hour + and - buttons**.
4. Set the correct minute using the **Minute + and - buttons**.
5. Press and release the **Time set button** to complete time setting.
6. The display will show the correct time.



Setting the buzzer alarm

Note: Clock uses 24 hour system.

1. Repeatedly press and release the **Standby button** until the display shows '**Buzzer**'.
2. Whilst the display **STAND BY**  symbol and alarm time are flashing set the required hour using the **Hour + and - buttons**.
3. Set the required minute using the **Minute + and - buttons**. Press and release the **Standby button** to complete alarm setting.
4. At the preselected time the alarm will sound. The alarm may be turned off for 24 hours by pressing the **Power button**.
5. Pressing any other button (except Standby or ) whilst the alarm is sounding will activate the snooze function. The alarm will be silenced for 5 minutes.
6. To permanently cancel the alarm repeatedly press and release the Standby button until the **STAND BY**  symbol is removed from the display.

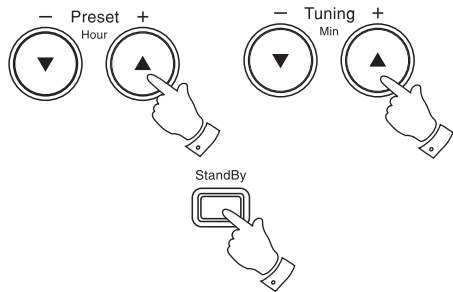
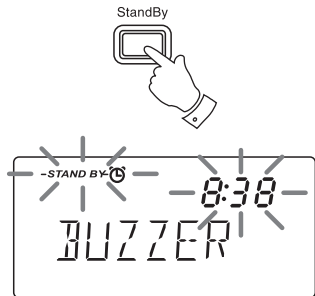

Setting the radio alarm

Note: Clock uses 24 hour system.

1. Repeatedly press and release the **Standby button** until the display shows 'Last CH'.
2. Whilst the display (())-**STAND BY**- symbol is flashing set the required hour using the **Hour + and - buttons**.
3. Set the required minute using the **Minute + and - buttons**. Press and release the **Standby button** to complete alarm setting.
4. At the preselected time the radio will switch on to the last station listened to. The alarm may be turned off for 24 hours by pressing the **Power button**.
5. Pressing any other button (except Standby or (()) whilst the alarm is sounding will activate the snooze function. The alarm will be silenced for 5 minutes.
6. To permanently cancel the alarm repeatedly press and release the Standby button until the (())-**STAND BY**- symbol is removed from the display.

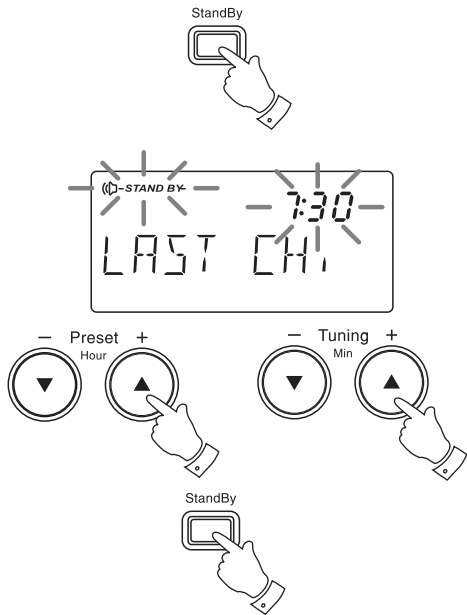

Search tuning

1. Switch on your radio by pressing the **Power button**.
2. Select the required waveband by repeat pressing of the **Bands button**. The waveband selected will appear in the display. On FM and SW fully extend the **Telescopic aerial**. On MW rotate your radio for best reception.
3. Press and hold down either the **Tuning + or - buttons** until the frequency in the display begins to change rapidly. Release the button.
4. Your radio will scan the selected waveband, stopping each time it finds a station of sufficient strength. Adjust the **Volume and Tone controls** to the required settings.
5. On SW direct access to your chosen band can be made by repeatedly pressing the **Meter -SW button**.

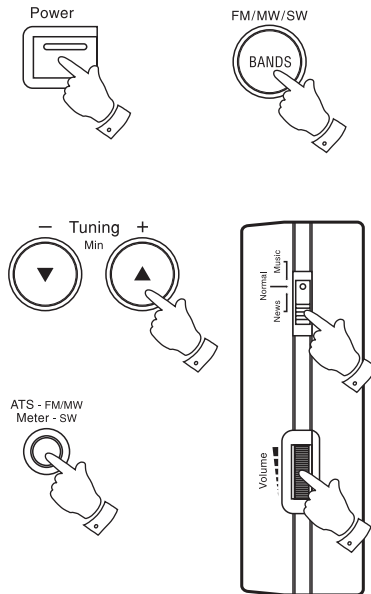

Manual tuning

1. Switch on your radio by pressing the **Power button**.
2. Select the required waveband by repeat pressing of the **Bands button**. The waveband selected will appear in the display. On FM and SW fully extend the **Telescopic aerial**. On MW rotate your radio for best reception.
3. A single press on either the **Tuning + or - buttons** will change the frequency up or down. The frequency steps are:- FM 50kHz, MW 9kHz or 10kHz and SW 5kHz. Adjust the **Volume and Tone controls** to the required settings.
5. On SW direct access to your chosen band can be made by repeatedly pressing the **Meter -SW button**.

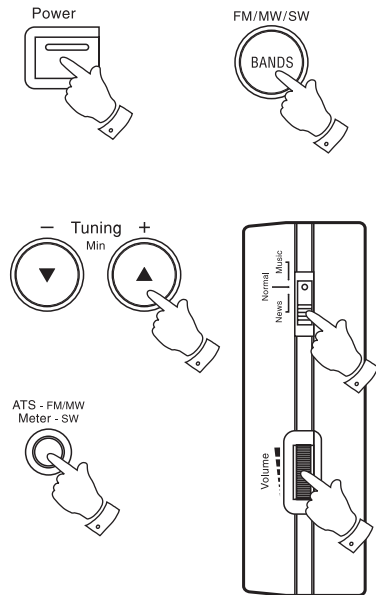

MW (AM) tuning step size

In Europe and other parts of the world MW tuning steps are 9kHz, in America the MW tuning step size is 10kHz.

To change the MW tuning step size from 9kHz to 10kHz proceed as follows:-

1. Switch on your radio and select the MW waveband.
2. Press and hold down the **Display button** until the display shows 10 kHz.
3. Press the **Display button** to confirm the setting.
4. To change back to 9kHz steps - press and hold down the **Display button** until the display shows 9 kHz.
5. Press the **Display button** to confirm the setting.

Power



FM/MW/SW



Display



Display



Presetting stations

You may store up to 9 stations on FM, 9 on MW and 9 on SW giving a total of 27 preset stations.

1. Tune into the required station using one of the tuning methods previously described.
2. Press and release the **Memo button**, the word SAVE -> will appear in the display.
3. Select the preset under which you wish to store the station using the **Preset + and - buttons**.
4. Press and release the **Memo button** to store the station. The preset number will now appear at the bottom of the display.
5. Repeat the procedure for the remaining presets.

Note: Presetting of stations can only be carried out whilst the word SAVE -> is showing in the display (5 seconds).

6. If all the preset memory locations are full pushing the **Memo button** will cause the display to show **'FULL**. If you still want to store a new station press the **Memo button** and continue from step 3.

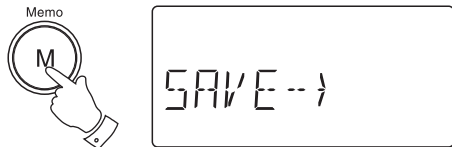

Recalling a preset station

1. Switch on your radio using the **Power button**.
2. Select the desired waveband using the **Bands button**.
3. Press **Preset + or - buttons** to cycle through the available preset stations.

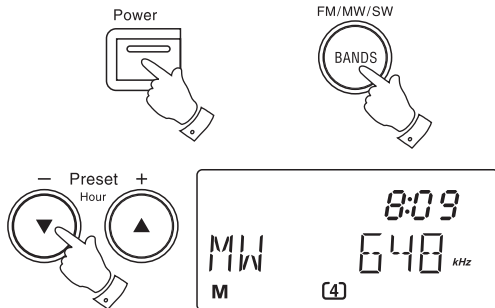

Memory scan

Your radio is equipped with a Memory scan facility.

1. Press and hold down either the **Preset + or - buttons** for at least 2 seconds to start memory scan. Your radio will scan the available memories pausing for a few seconds on each one. To stop memory scan press either the **Preset + or - buttons** when the required preset is reached.

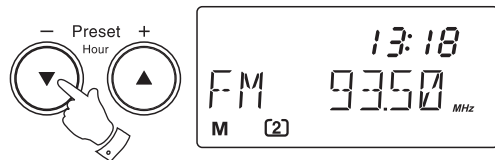

ATS (Automatic Tuning System)

The automatic tuning system will scan the selected waveband and automatically store stations in the memory presets.

note: ATS operates on FM an MW bands only - activating the ATS function will overwrite any stations previously stored in the memory presets

1. Select the required waveband by pressing the **Bands button**.
2. Press and hold down the **ATS button** until frequency digits in the display begin to change rapidly. Your radio will scan the selected waveband and automatically store stations in memory presets.

FM/MW/SW



ATS - FM/MW
Meter - SW



ATS

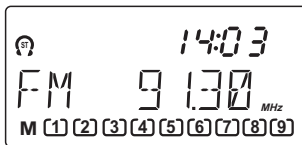

Operating your radio using RDS (Radio data system)

The **Radio Data System (RDS)** is a system in which inaudible digital information is transmitted in addition to the normal FM radio programme.

1. Switch on your radio and select the FM waveband.
2. Tune into a station, the display will indicate frequency for a few seconds and then change to show the station name. The **RDS** symbol will appear in the display
3. If the station does not carry RDS information only the station frequency will be shown.

Note: the **RDS** indicator will flash if the signal is too weak for RDS operation.

Power



FM/MW/SW

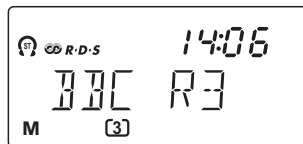
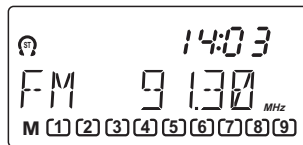

Display Modes (FM only)

1. Whilst tuned to a station displaying its RDS station name, you can change between station name and frequency by pressing and releasing the **Display button**.
2. The display will show the stations frequency for approximately 5 seconds before reverting to showing station name

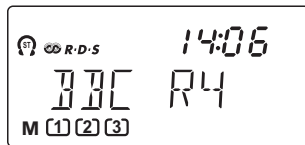
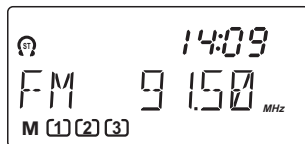
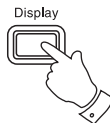
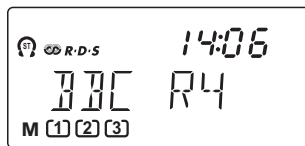

FM stereo/mono button (FM only)

1. If the station being received is weak some hiss may be audible, to reduce the hiss press the **FM ST/Mono button** to switch to mono mode. The stereo indicator will be removed from the display.
2. Press the **FM ST/Mono button** to return to FM stereo operation.

Note: FM stereo is only available when using earphone/headphones

FM ST./Mono



Setting the sleep timer

Your radio can be set to turn off after a preset time has elapsed.

1. Ensure that your radio is switched off.
2. Press and hold down the **Power button** until the desired time is reached (maximum 90 minutes in 15 minute steps). The radio will switch off after the sleep time has elapsed.
3. To cancel the sleep function before the preset time has expired, press the **Power button**.

Power

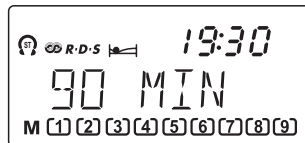

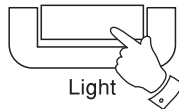

Display backlight

1. Pressing the **Light button** will switch on the display backlight and illuminate the display for approximately 7 seconds.



Lock button

The **Lock button** is used to prevent unintentional operation.

1. Press the **Lock button**, the  symbol will appear in the display. The **Power** and all other buttons will be disabled. This will prevent accidental operation when the radio is packed in a suitcase.
2. To release the lock function press the **Lock button**, the  symbol will be removed from the display.

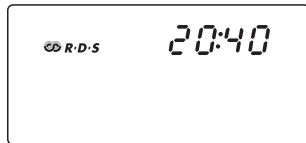
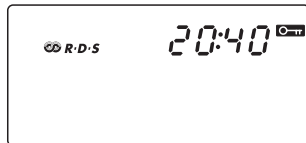

Using an AC adaptor (not included)

The AC adaptor for use with the R9921 should provide 6 volts DC output at 300mA centre pin negative (Roberts type PU6-B).

Insert the adaptor plug into the DC socket (18) on the left side of the radio. Plug the adaptor into a standard 13A mains socket outlet. Whenever the adaptor is used the batteries are automatically disconnected.

The AC adaptor should be disconnected from the mains supply when not in use.

We would recommend for economy that the R9921 be used via an AC adaptor whenever possible with battery operation for occasional or stand-by use only.

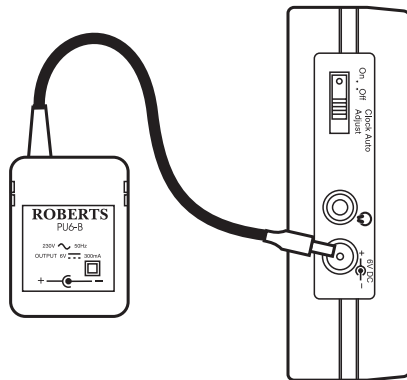

Headphones

Headphones or earphones for use with your radio should be stereo and fitted with a 3.5mm stereo jack plug. Insert the headphone plug into the  socket on the left side of the radio. When the headphones are plugged in the loudspeaker is automatically disconnected.

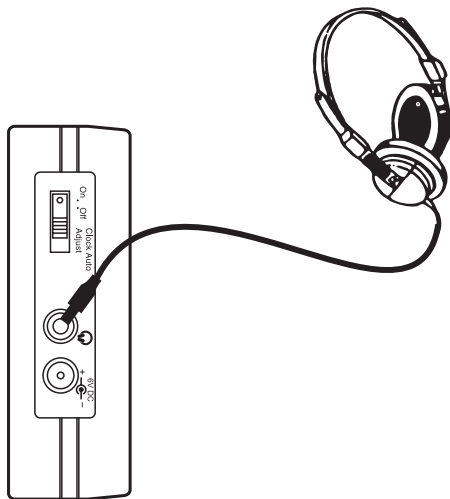

Troubleshooting/Reset button

If your radio fails to operate correctly, or some digits on the display are missing or incomplete carry out the following procedure.

1. Switch off the radio and remove the batteries.
2. With the aid of a suitable implement (the end of a paper clip) press the reset button located in the battery compartment for at least 5 seconds, this will reset the microprocessor, clock time and clear all stations stored in preset memory.

If a problem persists our technical staff would be pleased to help offer any assistance on operating the radio. Our technical helpline number is: 020 8758 0338.

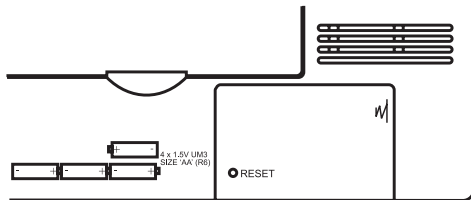

Specifications

Power requirements

DC 6.0V  @ 300mA
centre pin negative

Batteries 4 x IEC size LR6 (AAsize)

Battery Life Approx. 20hrs of listening when used for 4 hours a day at normal volume using alkaline batteries.

Loudspeaker: 8 ohms

Output power: 250mW.

Sockets

Headphone socket 3.5mm dia stereo.

DC input socket 6.0 volts centre pin negative.

Frequency Range

FM 87.5 - 108.0MHz

MW 522 - 1710kHz

or 520 - 1710KHz

SW 5.90 - 17.90MHz

49m 5.90 - 6.20MHz

41m 7.10 - 7.35MHz

31m 9.40 - 9.90MHz

25m 11.60 - 12.10MHz

21m 13.57 - 13.87MHz

19m 15.10 - 15.80MHz

16m 17.48 - 17.90MHz

The company reserves the right to amend the specification without notice.

Guarantee

This radio is guaranteed for twelve months from the date of delivery to the original owner against failure due to faulty workmanship or component breakdown, subject to the procedure stated below. Should any component or part fail during this guarantee period it will be repaired or replaced free of charge.

The guarantee does not cover:

1. Damage resulting from incorrect use.
2. Consequential damage.
3. Receivers with removed or defaced serial numbers.

N.B. Damaged or broken telescopic aerials will not be replaced under guarantee.

Procedure: Any claim under this guarantee should be made through the dealer from whom the instrument was purchased. It is likely that your Roberts' dealer will be able to attend to any defect quickly and efficiently but should it be necessary the dealer will return the instrument to the company's service department for attention. In the event that it is not possible to return the instrument to the Roberts' dealer from whom it was purchased, please contact Roberts Radio service department at the address shown on the rear of this manual before taking further action.

These statements do not affect the statutory rights of a consumer.



Issue 3

ROBERTS RADIO TECHNICAL SERVICES DEPARTMENT

97-99 Worton Road
Isleworth Middlesex

TW7 6EG

Technical Helpline :- 020 8758 0338 (*Mon-Fri during office hours*)

Website: <http://www.robertsradio.co.uk>

Download from [Www.Somanuals.com](http://www.Somanuals.com). All Manuals Search And Download.



Free Manuals Download Website

<http://myh66.com>

<http://usermanuals.us>

<http://www.somanuals.com>

<http://www.4manuals.cc>

<http://www.manual-lib.com>

<http://www.404manual.com>

<http://www.luxmanual.com>

<http://aubethermostatmanual.com>

Golf course search by state

<http://golfingnear.com>

Email search by domain

<http://emailbydomain.com>

Auto manuals search

<http://auto.somanuals.com>

TV manuals search

<http://tv.somanuals.com>