

ROBERTS

Sound for Generations

R9969

PLL Synthesised World Radio



travelling lite 3

Please read this manual before use

Contents

<i>Contents</i>	2	<i>Setting the reception sensitivity</i>	16
<i>Controls</i>	3-6	<i>Special features of SW reception</i>	17
<i>Installing the batteries</i>	7	<i>Connecting the external SW antenna</i>	17
<i>Switching on and setting the clock</i>	8	<i>SSB reception</i>	18
<i>Setting local time 1</i>	8	<i>Alarm mode - displaying the alarm time</i>	19
<i>Setting local time 2</i>	9	<i>Alarm with signal tone</i>	19
<i>Setting and storing radio stations</i>	10	<i>Alarm with radio station</i>	20
<i>Tuning radio stations directly</i>	10	<i>Cancelling the alarm for the day</i>	21
<i>Tuning radio stations manually (1)</i>	10	<i>Cancelling alarm stand-by</i>	21
<i>Tuning radio stations manually (2)</i>	11	<i>Sleep timer mode</i>	21
<i>Saving radio stations at preset positions</i>	11	<i>Setting the sleep timer</i>	21
<i>Storing shortwave (SW) stations</i>	12	<i>Deactivating the sleep timer</i>	22
<i>Automatic station search</i>	12	<i>Additional functions - displaying local time 1 or 2</i>	22
<i>Deleting preset stations</i>	13	<i>Setting various function modes</i>	23
<i>Calling up stored radio stations</i>	14	<i>Switching on the back lighting for the display</i>	24
<i>Checking stored radio stations</i>	14	<i>Disabling and enabling the buttons</i>	24
<i>Changing preset positions</i>	15	<i>Disabling and enabling the fine tuning dial</i>	24
<i>Adjusting the volume</i>	15	<i>Deleting all settings</i>	25
<i>Adjusting the tone</i>	15	<i>Specifications</i>	26
<i>Listening with headphones</i>	16	<i>Guarantee</i>	27
<i>Switch between stereo and mono reception</i>	16		

CONTROLS

Controls - Front

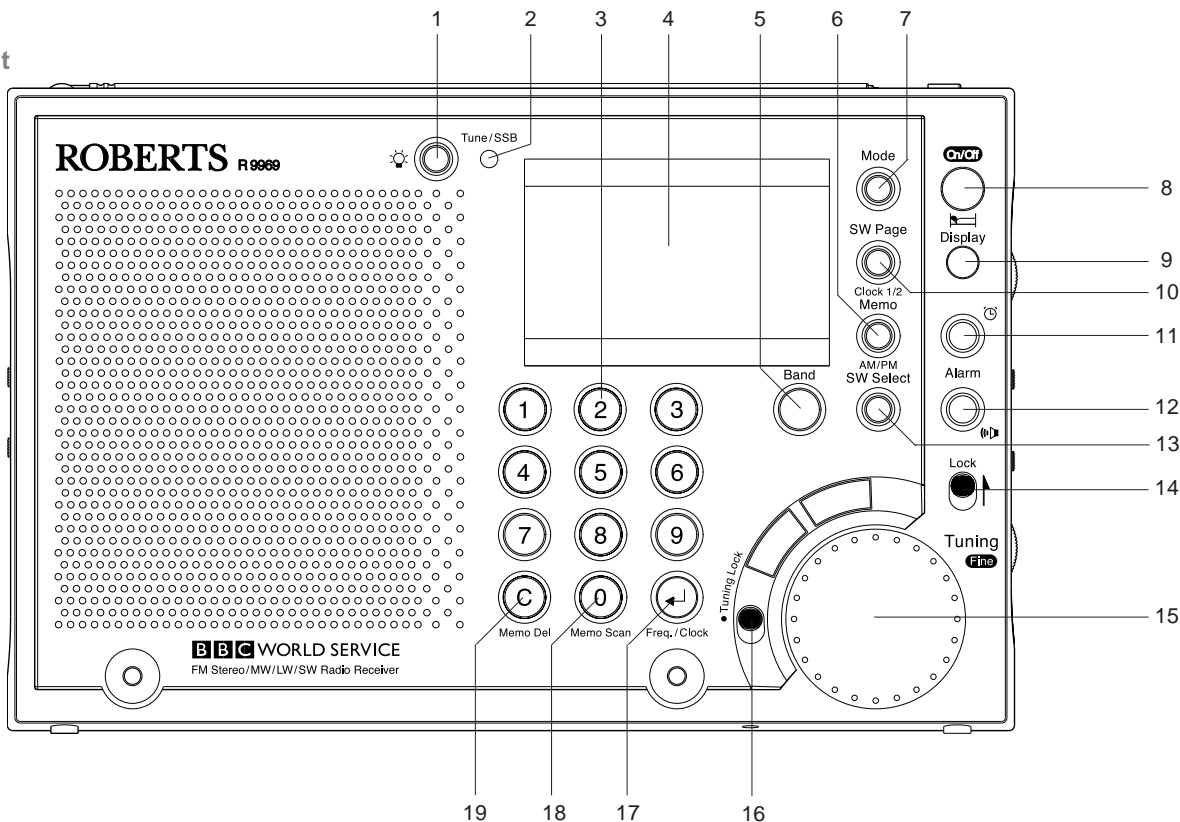

- | | | | | |
|-----------------------------|-------------------|------------------------------|------------------------|------------------------|
| 1. Light | 5. Band selection | 9. Display button | 13. SW Select button | 17. Freq./Clock button |
| 2. Tune/SSB LED | 6. Memo AM/PM | 10. SW Page Clock 1/2 button | 14. Lock switch | 18. Memo Scan button |
| 3. 1 to 9 Numerical buttons | 7. Mode | 11. Signal Alarm button | 15. Fine tuning dial | 19. Memo Del button |
| 4. Display | 8. On/Off Sleep | 12. Radio Alarm button | 16. Tuning lock switch | |

If you need any further advice, please call our Technical Helpline on :-

020 8758 0338 (Mon-Fri)

Download from www.Somanuals.com. All Manuals Search And Download.

Controls Right side

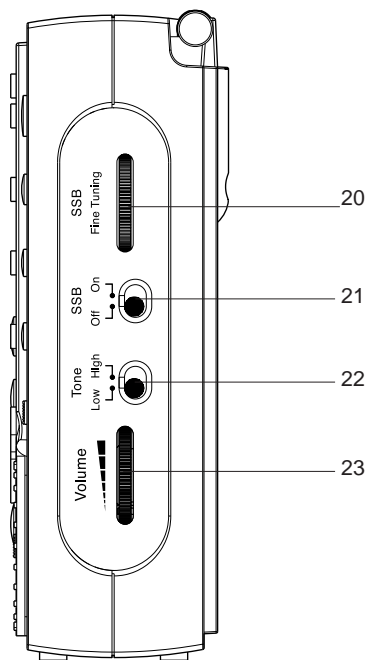

- 20. SSB Fine Tuning
- 21. SSB On/Off
- 22. Tone (low/high)
- 23. Volume

Left side

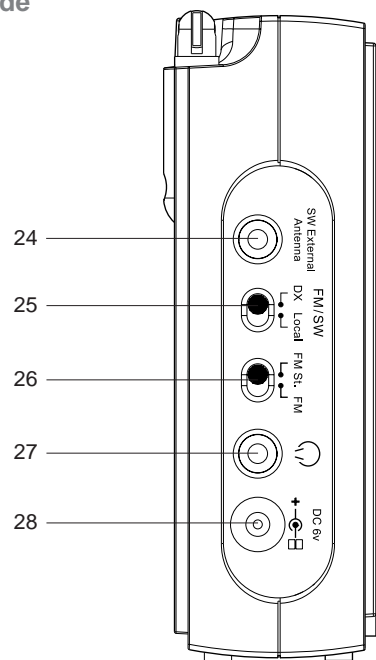

- 24. SW External Antenna
- 25. FM/SW DX./Local
- 26. FM St./FM
- 27. Headphone socket
- 28. DC 6 V socket for mains adapter (not supplied)

Controls
Top

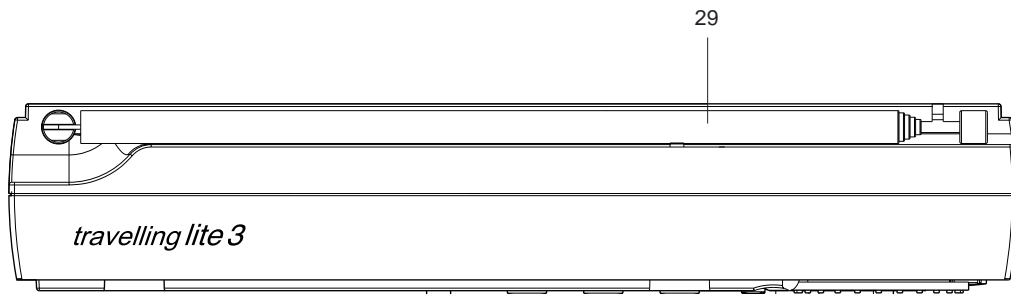

29. Antenna

Bottom

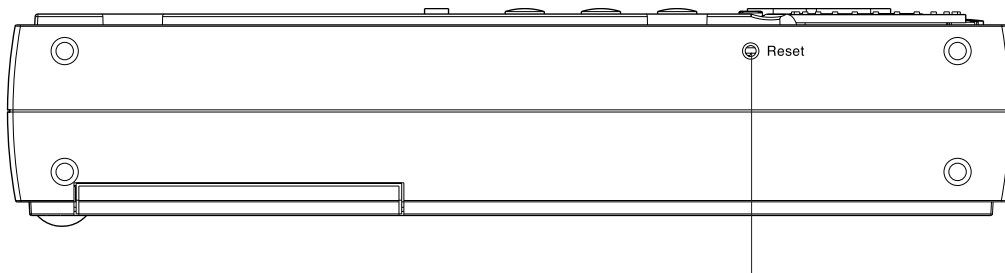

30. Reset button

Controls
Back

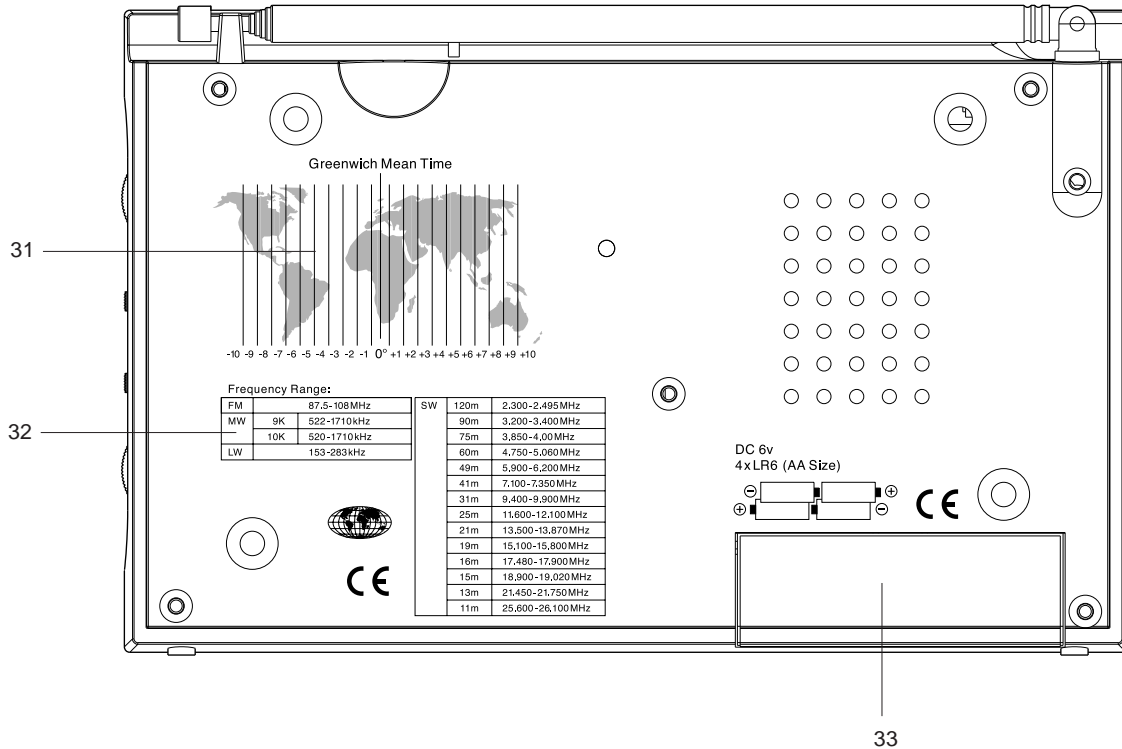

- 31. Map of world time zones
- 32. Frequency scale
- 33. Battery compartment

Installing the batteries

4 x 1.5V, LR6 (AA size) type batteries are required.

1. Open the battery compartment on the back of your receiver by pressing the marking and opening the lid.
2. Insert the batteries into the compartment. Make sure the (+) and (-) ends of the batteries are positioned as shown on the rear of the receiver.
3. Close the battery compartment cover.

Note: When the batteries are low, the battery level icon flashes in the display. Each time the radio is switched off the battery charge indicator appears for seven seconds. If the charge level falls below 2 the batteries must be changed. If the batteries are not replaced within 3 minutes all stored settings will be lost.

Remove the batteries if the receiver is not going to be used for an extended period of time. The manufacturer accepts no liability for damage resulting from used batteries.

Environmental note: Batteries, including those which contain no heavy metal, may not be disposed of with household waste. Please dispose of used batteries in an environmentally sound manner.

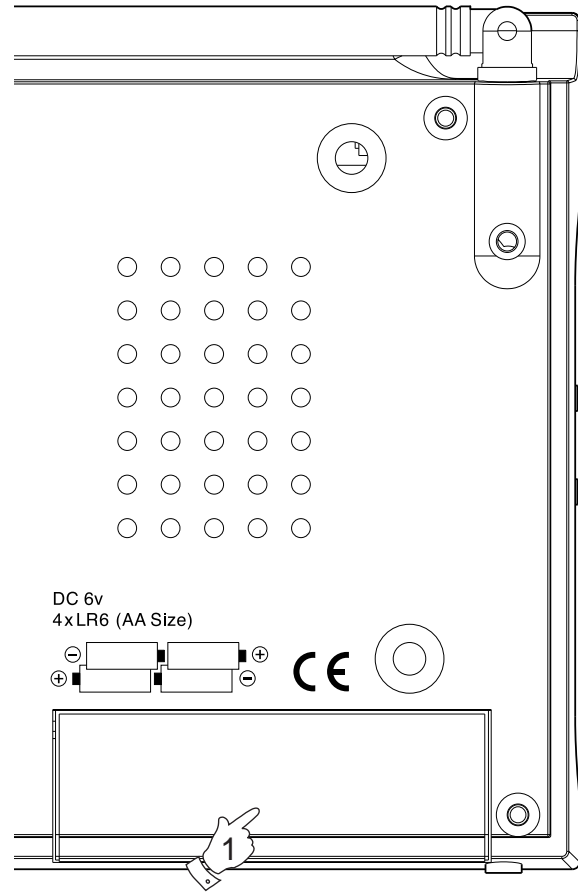

Switching on and setting the clock

Before setting the clock make sure that the local time zone is known. There are 24 time zones based on a standard time zone called the UTC (Universal Time Co-ordinated), previously known as GMT (Greenwich Mean Time), as shown in the diagram on the back of the receiver.

Two different local times can be set, local time '1' and local time '2'.

Setting local time 1

When the receiver is first switched on the display indicates that the clock has to be set. The digital display will show '0:00' and the local time '1' symbol will be shown.

Note: If you are operating the receiver in the 12-hour format, AM and PM can be set by pressing the **Memo AM/PM button**.

1. Place the receiver on a flat surface. Make sure that the batteries have been inserted correctly, or if using mains power, plug the mains lead into a wall socket and switch on at the wall socket.
2. Press down and hold the **Freq./Clock button** until the display indicates the time can be set. The digital display will show '-:--' and the local time '1' symbol will flash.

Note: If the radio is switched on, press the **Display button** to switch the display to the clock.

3. Enter the time using the numerical buttons '1 0' in the correct sequence.

Note: If the digits are entered incorrectly, a signal sounds and 'Err' flashes briefly in the display. The time will have to be entered again.

4. Press the **Freq./Clock button** to confirm the entry.

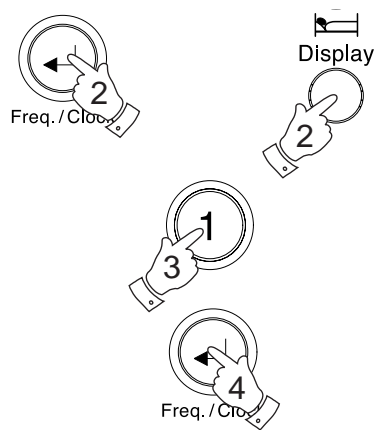

Setting local time 2

1. Press the **SW Page Clock 1/2 button**. The display flashes for local time '2'.
2. To set the display to local time '2' press the **Freq./Clock button**.
3. Press down and hold the **Freq./Clock button** until the display indicates the time can be set. The digital display will show ':-:--' and the local time '2' symbol will flash.
4. Enter the time using the numerical buttons '1 0' in the correct sequence.

SW Page



Setting and storing radio stations

1. Switch on the radio by pressing the **On/Off Sleep button**.
2. Press the **Band button** to select the required waveband (FM, SW, MW or LW).
There are various ways to set radio stations and store them at preset positions.
3. If short wave is selected, the frequency band can be selected by pressing the **SW select button**.



Tuning radio stations directly

1. Press the **Freq./Clock button**.
2. Enter the frequency using the numerical buttons.
3. Press the **Freq./Clock button** to confirm the entry.



Tuning radio stations manually (1)

1. Tune in to the desired station by turning the **Fine tuning dial**. The display will show the frequency in 100 or 200 kHz increments (FM), in 9 or 10 kHz increments (MW), in 3 kHz increments (LW) or in 5 kHz increments (SW).
2. To fine tune to the station, briefly push in and turn the **Fine tuning dial**. The display will show frequency changes in 50 kHz increments (FM) or 1 kHz increments (MW, LW and SW).

Note: The word STEP is displayed whilst in fine tune mode.

3. To return to the original mode, push the **Fine tuning dial** again.

Note: The word STEP is removed from the display.

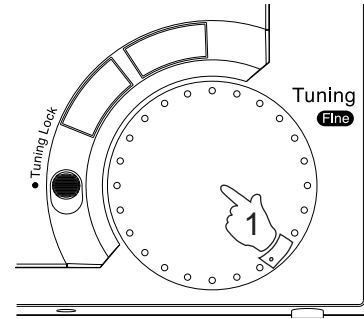

Tuning radio stations manually (2)

1. Press the arrow buttons until you reach the desired station
or
Hold down one of the arrow buttons until the frequency changes to a rapid run-through.
The automatic search stops at the next station with a strong signal.

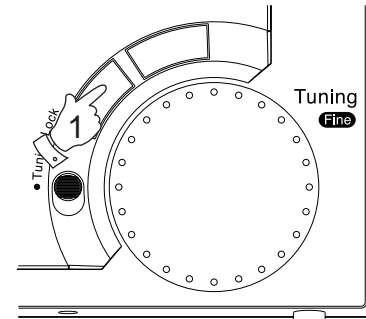

Saving radio stations at preset positions

You can store up to 45 radio stations; 18 on two memory levels for short wave frequencies, and nine each on FM, MW and LW frequencies.

1. Select the frequency band and the radio station.
2. Press the **Memo AM/PM button**.
3. Press the **Freq./Clock button** to store the radio station. The station is then stored on preset position 1.

Repeat the process for additional stations.

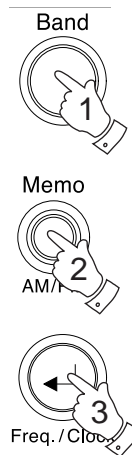

Storing short wave (SW) stations

The short wave band is divided into frequency bands of different lengths. Therefore up to 18 SW stations can be stored on two memory levels.

1. Save short wave stations as previously described.
2. Once nine stations are stored on one memory level M1, press **SW Page Clock 1/2 button** to switch to the second memory level.
3. Store the remaining nine stations as described above.

Note: If you try to store more than 18 stations and press **Memo AM/PM button**, 'FULL' appears in the display.

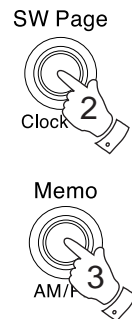

Automatic station search

This function allows an automatic search and store of nine stations in each of the FM, MW and LW bands (not SW). The search starts at the lowest frequency in the selected wave band, and stores the nine stations with the strongest signals. After the search has finished, a signal sounds.

1. To start the search, press both **Arrow buttons** at the same time and hold them down until a signal is heard. The display indicates the stored number.

Note: When you start the search, all the previously stored stations are deleted. During the search, the display shows the progress, but not the stations found.

2. The search can be stopped by pressing the **On/Off button**.
You can reorganise the preset stations using '**MODE 50 or 51**' (see page 23).

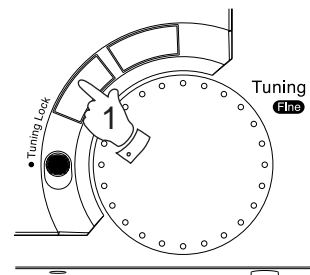

Deleting preset stations

1. Enter the preset station using the numerical buttons '**1 to 0**'. The frequency and the preset number will be displayed.
2. Press the **Memo AM/PM button**. The selected preset station flashes.
3. Press the **C Memo Del button** to delete the station.



Calling up stored radio stations

1. Select the station using the numerical buttons '**1...0**' for the preset number.
2. To call up preset numbers 10 to 18 in the SW band, press the **SW Page Clock 1/2 button** to switch to the second memory level.

Note: For FM reception, pull out the telescopic antenna and tilt it until the best signal is received. For short wave reception (SW), the antenna should be upright. For medium wave and long wave reception, align the internal antenna by turning the receiver.

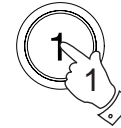

SW Page



Checking stored radio stations

All the stored radio stations in a wave band can be called up automatically for seven seconds (memory scan).

1. With the radio playing, press the **Memo Scan button**. The device starts with the current preset station and then changes to the next one. When you reach the desired station, press the **Memo Scan button** to stop the function.



Changing preset positions

1. Enter the preset station you want to change using the numerical buttons **'1...0'**.
2. Press the **Memo AM/PM button** and the selected preset position flashes.
3. Enter the new preset position using the numerical buttons **'1...0'**. A signal sounds and the preset positions are changed.

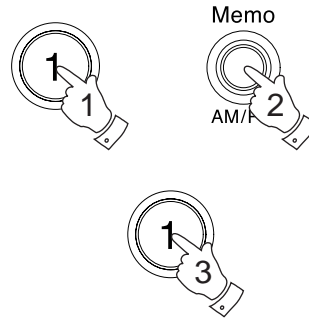

Adjusting the volume

1. Adjust the volume using the **Volume** control on the right hand side of the receiver.

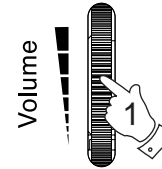

Adjusting the tone

1. Adjust the tone using the **Tone low/high** switch on the right hand side of the receiver.

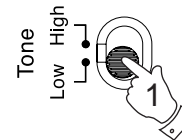

Listening with Headphones

1. A **Headphone Socket** (3.5mm) located on left side of the receiver is provided for use with either headphones or an earpiece. Inserting a plug automatically mutes the internal loudspeaker.

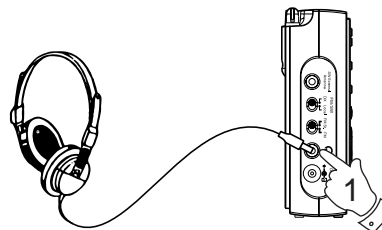

Switching between stereo and mono reception

FM stereo reception is only available with headphones.

1. Connect the headphones and select an FM station.
2. Set the **FM St./FM** switch on the left side of the device to stereo. The display indicates stereo has been selected.
3. If the reception of the station is weak in FM stereo, move the **FM St./FM** switch to mono. The stereo symbol disappears from the display.

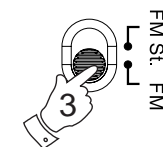
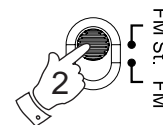

Setting the reception sensitivity

1. If the sensitivity is too high, set the **DX./Local** switch (on the left hand of the receiver) to **DX**.
2. If the signal is too strong, and is causing distortion, move the **DX./Local** switch to **Local** (low sensitivity).

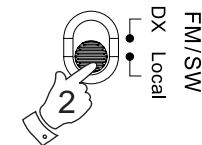
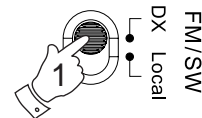

Special features of SW reception

Short wave reception

Your radio can receive signals in a number of frequency bands. It is easy to get used to tuning to stations in the FM, MW and LW bands, since they are always on the same frequencies.

Unfortunately, this is not always the case with short wave stations. Due to atmospheric conditions, short wave stations must frequently broadcast on different wavelengths. Most short wave bands are available all over the world and can be used by international broadcasters. At present these are the only wavelengths which provide listeners with direct reception over long distances.

If you want to listen to a particular SW station, the precise frequency and wavelength need to be known. Many short wave stations will send broadcasting schedules which give the information required. This information is also available on the Internet.

Connecting the external SW antenna

To improve short wave reception the external SW antenna supplied can be connected.

1. Insert the plug of the antenna cable into the **SW External Antenna** socket on the left hand side of the receiver.

Note: Unroll and align the antenna to achieve the best reception. If there is interference, move the **DX./Local** switch to **Local**.

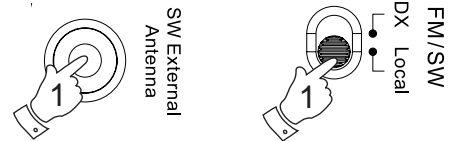

SSB reception (for example for radio hams and shipping)

Some short wave stations broadcast Morse code for shipping using continuous waves (CW). Voice signals, for example amateur radio, is normally broadcast on the single side band (SSB).

1. Select the SW waveband using the **Band button**.
2. Select the frequency band using the **SW Select button**.
3. Set the **SSB On/Off** switch on the right hand side of the receiver to **'ON'**. The **Tune/SSB** LED changes to light up red.
4. Slowly turn the **'SSB Fine Tuning'** dial on the right hand of the receiver until you achieve a clear reception. If an SSB station is received, the **'Tune/SSB'** LED lights up orange.

Note: For fine tuning, the **Fine Tuning Dial** can also be pressed.

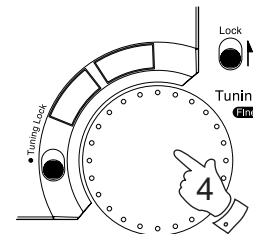
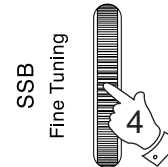
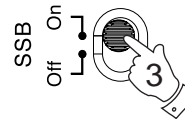

Alarm mode

Displaying the alarm time

1. Press the appropriate **Alarm button** (signal tone or radio). The last setting will be displayed or the radio symbol will flash.

Note: The display will return to the current time after 7 seconds.



Alarm with signal tone

1. With the radio switched off, press the **Alarm button** (signal tone). The last alarm set flashes.



2. Enter the alarm time using the numerical buttons '1...0'.

3. Press the **Freq./Clock button** to confirm the entry. The alarm time entered stays lit.

The receiver switches on with the signal tone at the set time (alarm duration 1 hour). The signal tone increases in volume for one minute, stops for a minute and starts again.

4. Press the **On/Off Stop button** to switch off the alarm.



Alarm with radio station

1. Press the **On/Off Sleep button** to switch on the receiver.
2. Select the frequency band and the radio station.
3. Adjust the alarm volume using the **Volume** dial.
4. Press the **Display button** to switch the display to the clock.
5. Press the **Alarm button** (radio station). The last alarm time set flashes.
6. Enter the alarm time using the numerical buttons '1...0'.
7. Press the **Freq./Clock button** to confirm the entry. The alarm time entered stays lit.
8. Press the **On/Off Sleep button** to switch off the alarm.
 - The device switches the radio on at the set time (alarm duration 1 hour).

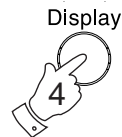
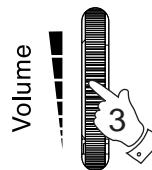

Cancelling the alarm for the day

1. Press the **On/Off Sleep button** while the alarm is sounding. The alarm (signal tone or radio) stops, but the alarm function remains activated for the next day at the set time.



Cancelling alarm stand-by

1. Press the appropriate **Alarm button** (signal tone or radio).
2. To deactivate the alarm, press the **C Memo Del button**.

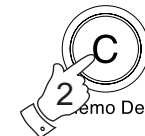

Sleep timer mode

The receiver has an adjustable sleep-timer, which can be set to 15, 30, 60, 90 or 120 minutes.

Setting the sleep timer

1. With the radio playing, press and hold down the **On/Off Sleep button**. The sleep times will flash in sequence 60...30...15...120...90.
2. To set the desired switch-off time, release the **On/Off Sleep button**.



Deactivating the sleep timer

1. To deactivate the sleep timer, press the **On/Off Sleep button** to switch off the radio.



Additional functions

Displaying local time 1 or 2

If two local times are set, local time '1' is normally displayed.

1. To temporarily change from local time '1' to local time '2', press the **SW Page Clock 1/2 button**. The display will show local time '2' for 7 seconds then return to local time '1'.
2. To permanently change from local time '1' to local time '2', press the **SW Page Clock 1/2 button** and then the **Freq./Clock button**.
3. To permanently change from local time '2' to local time '1', press the **SW Page Clock 1/2 button** and then the **Freq./Clock button**.



SW Page



SW Page

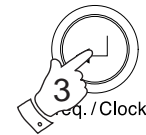

Setting various function modes

Using the **Mode button** and a two-digit code, which you enter using the numerical buttons '1---0', you can change various functions:

	Code	Function	Code	Function
MODE *	10	FM frequency change in 100 kHz steps	11	FM frequency change in 200 kHz steps
MODE *	20	MW frequency change in 9 kHz steps	21	MW frequency change in 10 kHz steps
MODE *	30	Time display in 12 hour format	31	Time display in 24 hour format
MODE *	40	Signal tone off	41	Signal tone on
MODE *	50	Arrange stations in sequence from low to high frequency range	51	Arrange stations in sequence from low to high frequency range

To change the various function modes.

1. Press the **Mode button**.
2. Enter the desired code, shown in the table using the numbered buttons '1---0'.
3. Press the **Freq./Clock button** to confirm.

Mode



Mode



Switching on the back lighting for the display

1. Press the **Light button** to switch on the display lighting for 7 seconds.
2. Press the **Light button** to switch off the display lighting.



Disabling and enabling the buttons

1. To disable the buttons, move the **Lock button** to the red dot.
2. To enable the buttons, move the **Lock button** to the opposite position.



Disabling and enabling the fine tuning dial

To prevent the frequency being changed accidentally, the 'Fine tuning dial' can be disabled.

1. To disable the dial, move the **Tuning Lock button** to the red dot.
2. To enable the dial, move **Tuning Lock button** to the opposite position.

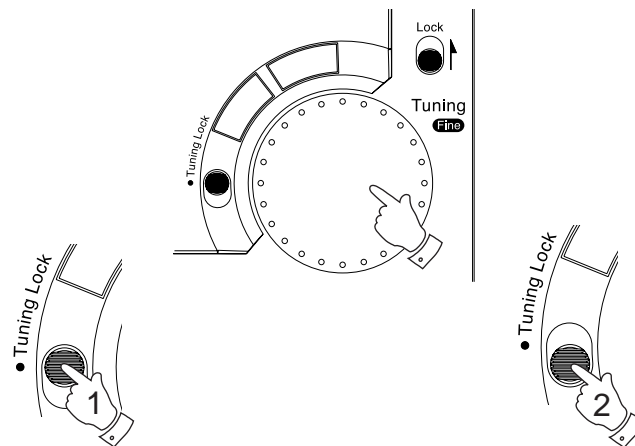

Deleting all settings

The receiver can be reset to its original state. All settings are lost when you do this.

1. Press the **Reset button** on the bottom of the device using a suitable implement such as a paper clip. All settings are deleted.



Specifications

Power supply

Battery operation	4 x 1.5V LR6 (AA size)
Mains operation	6V (200 mA) mains adapter, DC
Output	300 mW 10% THD

Frequency bands

FM	87.5 - 108 MHz
MW	520 - 1710 kHz or 522 - 1710 kHz
LW	153 - 283 kHz
SW 1 - 14	

Antennas

Telescopic antenna	FM and SW
Ferrite rod antenna	MW and LW

120 m	2.3 - 2,495 MHz
90 m	3.2 - 3.4 MHz
75 m	3.85 - 4.0 MHz
60 m	4.75 - 5.06 MHz
49 m	5.9 - 6.2 MHz
41 m	7.1 - 7.35 MHz
31 m	9.4 - 9.99 MHz
25 m	11.6 - 12.1 MHz
21 m	13.5 - 13.87 MHz
19 m	15.1 - 15.8 MHz
16 m	17.48 - 17.9 MHz
15 m	18.9 - 19.02 MHz
13 m	21.45 - 21.75 MHz
11 m	25.6 - 26.1 MHz

Sockets

DC socket	Dia. 4.0 mm, 6V (200 mA) centre pin negative
Headphone jack	Dia. 3.5 mm stereo, 2 x 32 impedance
SW antenna socket	Dia. 3.5 mm mono

Dimensions and weight

W x H x D	184 mm x 120 mm x 40 mm
Weight	510 g

Guarantee

This receiver is guaranteed for twelve months from the date of delivery to the original owner against failure due to faulty workmanship or component breakdown, subject to the procedure stated below. Should any component or part fail during this guarantee period, it will be repaired or replaced free of charge.

The guarantee does not cover:

1. Damage resulting from incorrect use.
2. Consequential damage.
3. Receivers with removed or defaced serial numbers.
4. Telescopic aerials.

Procedure:

Any claim under this guarantee should be made through the dealer from whom the receiver was purchased. It is likely that your Roberts' dealer will be able to attend to any defect quickly and efficiently, but should it be necessary the dealer will return the instrument to the company's service department for attention. In the event that it is not possible to return the instrument to the Roberts' dealer from whom it was purchased, please contact Roberts Radio Technical Services department at the address shown on the rear of this manual before taking further action.

These statements do not affect the statutory rights of a consumer.

If you need any further advice, please call our Technical Helpline on :-

020 8758 0338 (Mon-Fri)

Download from www.somanuals.com. All Manuals Search And Download.

ROBERTS RADIO TECHNICAL SERVICES

97-99 Worton Road
Isleworth Middlesex
TW7 6EG

Issue 1

Technical Helpline:- 020 8758 0338 (*Mon-Fri*)

Download from www.somanuals.com. All Manuals Search And Download.



Free Manuals Download Website

<http://myh66.com>

<http://usermanuals.us>

<http://www.somanuals.com>

<http://www.4manuals.cc>

<http://www.manual-lib.com>

<http://www.404manual.com>

<http://www.luxmanual.com>

<http://aubethermostatmanual.com>

Golf course search by state

<http://golfingnear.com>

Email search by domain

<http://emailbydomain.com>

Auto manuals search

<http://auto.somanuals.com>

TV manuals search

<http://tv.somanuals.com>