

ROBERTS

Enjoy Listening

DAB/FM RDS Digital Sound System
with dock for iPod

SOUND 66



DAB

Digital Audio Broadcasting

Please read this manual before use

Contents

<i>Controls</i>	2-4	<i>To view the alarm settings</i>	25
<i>Remote handset battery replacement</i>	5	<i>Cancelling alarms</i>	25
<i>Using the sound system for the first time</i>	6	<i>Snooze function</i>	26
<i>Operating your sound system</i>	7	<i>Sleep function</i>	27
<i>Selecting a station - DAB</i>	8	<i>Setting the clock manually</i>	28-29
<i>Secondary services - DAB</i>	9	<i>To return to auto clock set mode</i>	30
<i>Display modes - DAB</i>	9-10	<i>Equaliser function</i>	31-34
<i>Finding new stations - DAB</i>	11	<i>Mute function</i>	34
<i>Manual tuning - DAB</i>	12	<i>Clock display</i>	35
<i>Signal strength display - DAB</i>	12	<i>Display backlight dimmer</i>	35
<i>Dynamic Range Control (DRC) - DAB</i>	13	<i>Software version</i>	35
<i>Operating your sound system - FM auto-tune</i>	14	<i>Stereo / Mono setting - FM</i>	36
<i>Manual tuning - FM</i>	15	<i>System reset</i>	37
<i>Display modes - FM</i>	16	<i>Headphone socket</i>	38
<i>Presetting stations</i>	17	<i>Auxiliary input (Line in) socket</i>	38
<i>Recalling a preset station</i>	18	<i>Line output socket</i>	39
<i>iPod docking</i>	19	<i>USB socket for software upgrade</i>	39
<i>Navigating your iPod</i>	20	<i>Cautions</i>	40
<i>Playing a file on your iPod</i>	20	<i>Specifications</i>	40
<i>Search function</i>	21	<i>Circuit features</i>	40
<i>Setting the alarm times</i>	22-24	<i>Guarantee</i>	42

Controls (Top)

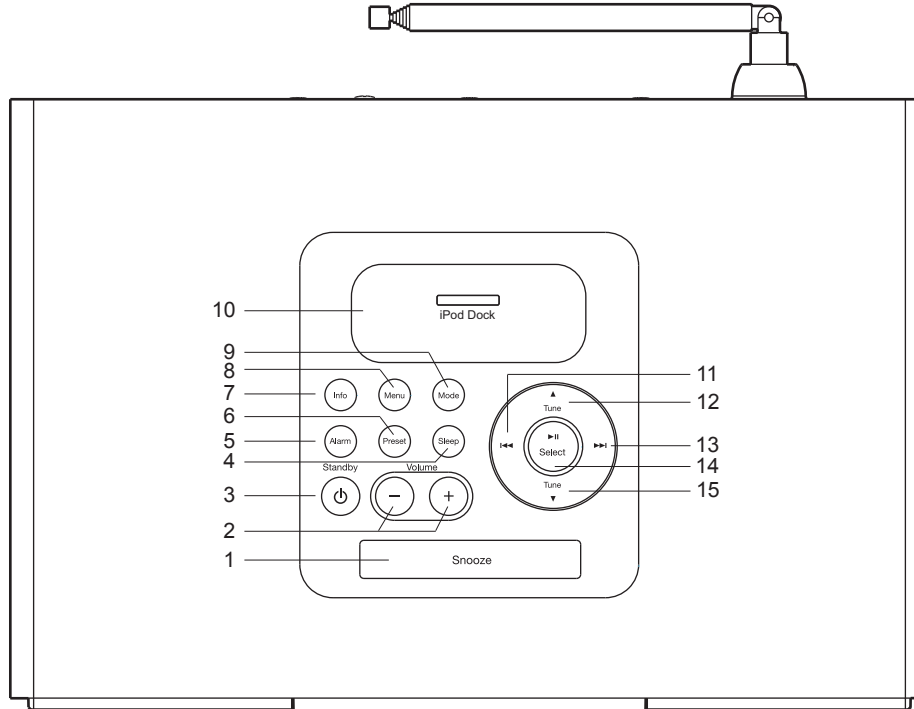

- | | | |
|-----------------------------|--|----------------------------------|
| 1. Snooze button | 6. Preset button | 11. Rewind button |
| 2. Volume Up / Down buttons | 7. Info button | 12. Tuning Up button |
| 3. On / Standby button | 8. Menu button | 13. Fast-forward button |
| 4. Sleep button | 9. Mode button (DAB,FM,iPod or Aux in) | 14. Select / Play / Pause button |
| 5. Alarm button | 10. Cover for iPod dock connector | 15. Tuning Down button |

Controls (front)

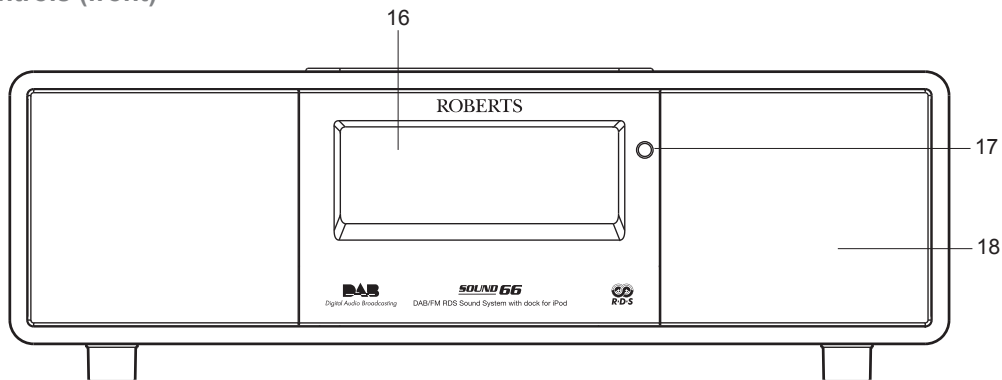

- 16. LCD display
- 17. Infra-red sensor
- 18. Speakers x 2

Controls (rear)

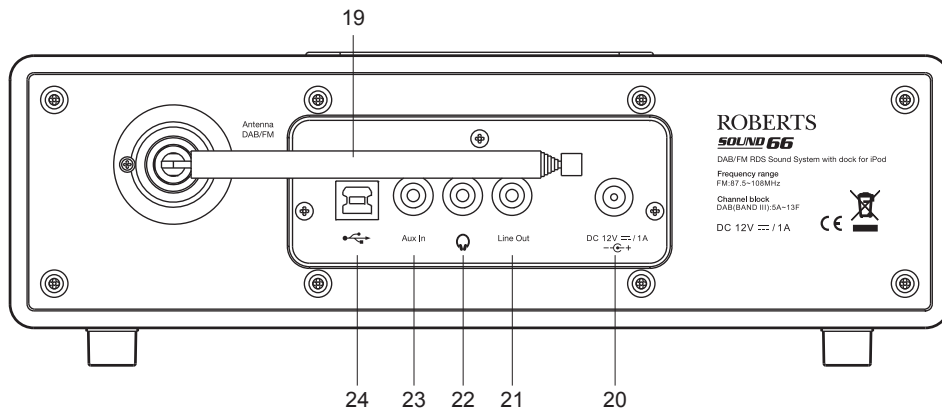

- 19. Telescopic aerial
- 20. DC in socket
- 21. Line output socket
- 22. Headphone socket
- 23. Auxiliary input socket
- 24. USB socket (for software upgrades)

Controls (remote control)

1. On / Standby button
2. iPod button
3. FM button
4. DAB button
5. Mute button
6. Auxiliary in button
7. Tuning Up button
8. Menu button
9. Play / Pause button
10. Rewind button
11. Tuning Down button
12. Sleep button
13. Light button
14. Snooze button
15. Alarm button
16. Equaliser (EQ) button
17. Info button
18. Fast-forward button
19. Preset button
20. Select button
21. Volume Up / Down buttons

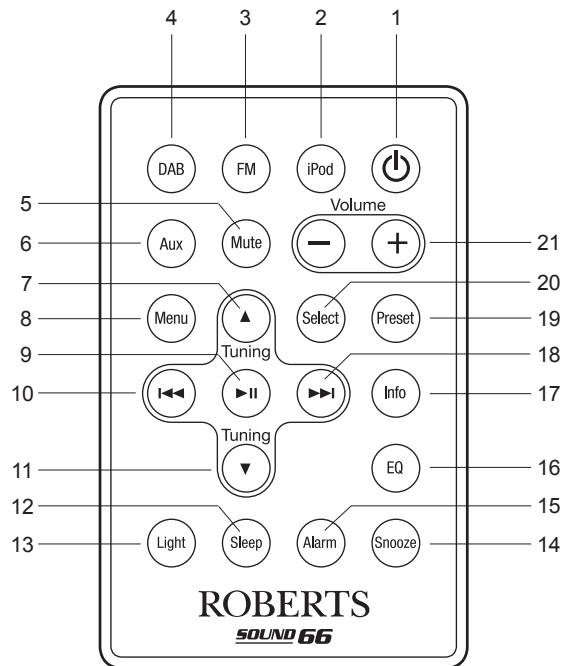

Note: For the sake of clarity, the instructions for the use of the controls throughout this instruction manual show the buttons on the remote control. The buttons on the sound system can be used if you prefer. However the mute, display backlight dimmer and some iPod control functions are only available when using the remote control.

Please note: The mode button on the sound system will access the DAB, FM, iPod and Auxiliary input modes.

Remote handset battery replacement

1. With the aid of the end of a paper clip slide the catch to the right hand side.
2. Remove the battery holder by pushing the holder in the direction shown.
3. Remove the battery from holder.
4. Replace the battery (CR2032 or equivalent) ensuring that the positive side of the battery faces you with the holder positioned as shown.
5. Replace the battery holder.

If the remote is not to be used for an extended period of time it is recommended that the battery is removed.

IMPORTANT: The battery should not be exposed to excessive heat such as sunshine, fire or the like. After use, disposable batteries should if possible be taken to a suitable recycling centre. On no account should batteries be disposed of by incineration.

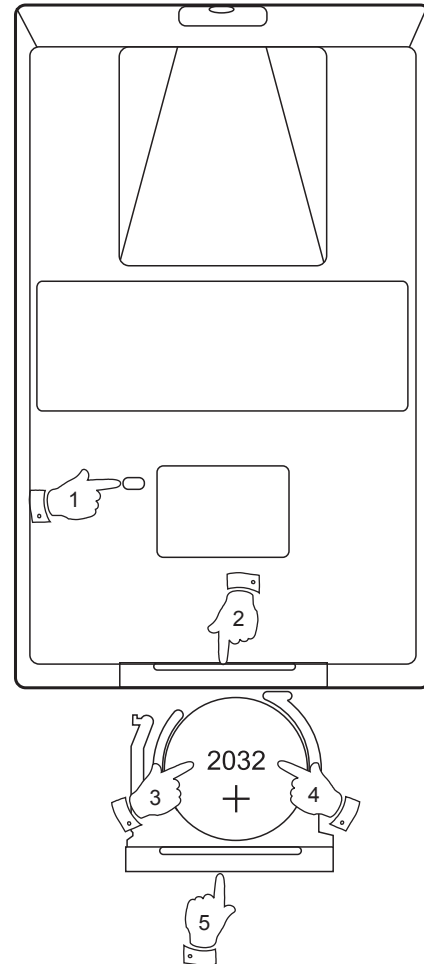

Using the sound system for the first time

1. Place your sound system on a flat surface.
2. Fully extend the telescopic aerial. The aerial should be fully extended and positioned vertically for optimum reception.
3. Insert the adaptor plug into the DC socket located on the rear of your sound system. Plug the adaptor into a standard 13 amp mains socket outlet. The display will show "ROBERTS" for a few seconds and then the display will then show "SET CLOCK". After a short time the current time will appear on the display.
4. If no stations are found, "NO CLOCK" will be displayed. It may be necessary to relocate your sound system to a position giving better reception. You should then carry out a scan to find stations as described on page 11.

IMPORTANT: The mains adaptor is used as the means of connecting the sound system to the mains supply. The mains socket used for the sound system must remain accessible during normal use. In order to disconnect the sound system from the mains completely, the mains adaptor should be removed from the mains socket outlet completely.

Characters appearing on the LCD display indicate that the sound system is connected to and powered from the mains supply.

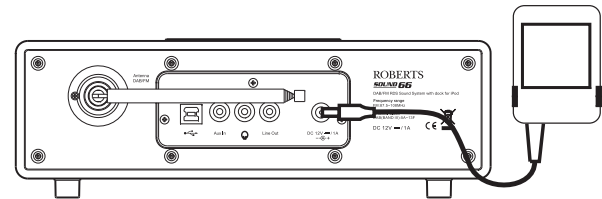

Operating your sound system

1. Press the **On / Standby button** to switch on your sound system.
When first switched on, the sound system will be in DAB mode. After each use the sound system will remember the mode used and then switch on in that mode the next time that it is used.
2. If the sound system has been used before, the last used station will be selected.
3. If this is the first time that the sound system has been used a quick scan of the Band III DAB channels will be carried out. The first station in the list of stations found during scanning will be played. The display will show the station name.
4. During the scanning process the display will show progress of the station search for example ">>>> 18". The number on the right of the display is the number of stations that have been found. When the scan is completed the first station (in numeric-alpha order 0....9, A....Z) will be selected.
5. If no signals are found then "OFF AIR" will be displayed and it may be necessary to relocate your sound system to a position giving better reception. You should then carry out a scan to find stations as described on page 11.
 - Your sound system has an indicator  on the display to indicate the strength of the DAB radio signal being received.

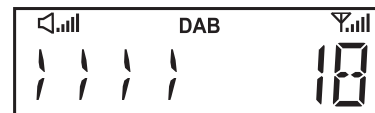

Note: When first switched on, the radio will set the volume to a moderately high level, in case the broadcast is very quiet. After you have set the volume using the **Volume Up** or **Down buttons**, the radio will remember the setting that you have applied for the next time that it is used.

Selecting a station - DAB

1. Press the **On / Standby button** to switch on your sound system. The display will show "TUNING" for a few seconds.
2. Press the **DAB button** to select DAB mode. The display will show the name of the radio station currently selected.
3. Press the **Tuning Up or Down buttons** to step through the list of available stations.
4. When the desired station name appears on the display, press the **Select button** to select the station. The display will show "TUNING" while your sound system finds the new station.
5. Adjust the **Volume** to the required setting.

Note: If after selecting a station the display shows "OFF AIR" it may be necessary to relocate your sound system to a position giving better reception.

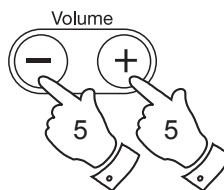
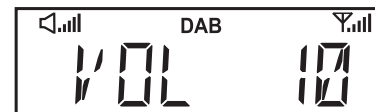
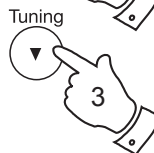
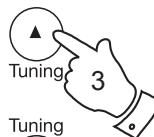
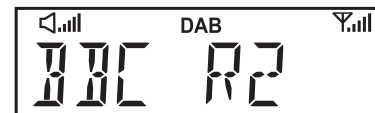

Secondary services - DAB

1. Certain radio stations have one or more secondary services associated with them. If a station has a secondary service associated with it then the secondary service will then appear immediately after the primary service as you press the **Tuning Up button**.
2. To tune to the secondary service, press and release the **Select button**. Most secondary services do not broadcast continually and if the selected service is not available, the radio will re-tune to the associated primary service.

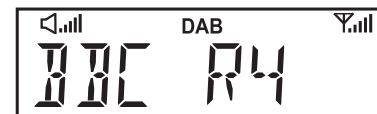

Display modes - DAB

Your radio has a range of display options when in DAB mode:-

1. Press the **Info button** to cycle through the various options.



- | | |
|-------------------|---|
| a. Station name | Displays the station name being listened to. |
| b. Scrolling text | Displays scrolling text messages such as artist/track name, phone in number, etc. |
| c. Programme type | Displays the type of station being listened to e.g. Pop, Classic, News, etc. |

d. Multiplex Name Displays the name of the DAB multiplex to which the current station belongs.



e. Time Displays the current time (24 hour clock).



f. Date Displays the current date.



g. Frequency & channel Displays frequency and channel number for the currently tuned DAB station.



h. Bit rate Displays the digital audio bit rate for the currently tuned DAB station.

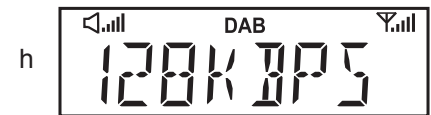

i. Signal error Displays the bit error rate for the currently tuned DAB station.



Finding new stations - DAB

As time passes new stations may become available. To find new stations proceed as follows.

1. Press and release the **Menu button**. "EQ" shows on the display.
2. Press the **Tuning Up** or **Down buttons** until the display shows "SCAN".
3. Press and release the **Select button**. Your radio will perform a scan of the Band III DAB channels. As new stations are found, the station counter on the right-hand side of the display will increase and stations will be added to the list.

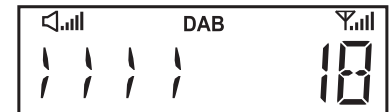
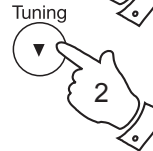
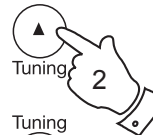

Manual tuning - DAB

Manual tuning allows you to tune your sound system to a particular DAB frequency in Band III. Any new stations found will be added to the station list. This function can also be used to assist the positioning of the aerial or the sound system to optimise reception for a specific channel or frequency. Note that UK DAB stations are located in the range of channels 11B to 12D.

1. Press and release the **Menu button** "EQ" will show on the display.
2. Press the **Tuning Up** or **Down buttons** until the display shows "MANUAL". Press and release the **Select button** to enter the manual tuning mode.
3. Press the **Tuning Up** or **Down buttons** to select the desired DAB channel. Press and release the **Select button** to tune to the chosen frequency.
4. If a signal is present, this will be indicated on a signal strength display. The minimum signal marker (|) shows the minimum signal strength needed for good DAB reception. The signal indicator chevrons go up or down showing the changing signal strength as you adjust the telescopic aerial or your sound system position. Press and release the **Select button** again to return to the normal DAB tuning mode.

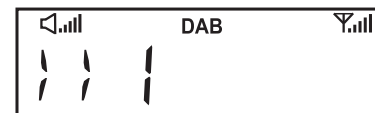
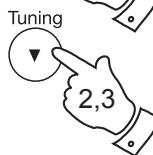
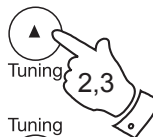

Signal strength display - DAB

1. Press and release the **Select button** to show the signal strength display. The minimum signal marker (|) shows the minimum signal strength needed for good DAB reception. The signal indicator chevrons increase or decrease showing the changing signal strength as you adjust the telescopic aerial or your sound system position.
2. Press and release the **Select button** to return to the normal radio display.



Dynamic Range Control (DRC) - DAB

Dynamic range control (also known as DRC) can make quieter sounds easier to hear when your sound system is used in a noisy environment.

There are three levels of compression:

DRC 0 No compression applied. (default)

DRC 1 Maximum compression applied.

DRC 1/2 Medium compression applied.

1. Press the **On / Standby button** to switch on your sound system.
2. Press the **DAB button** to select the DAB band.
3. Press and release the **Menu button** the display will show "EQ."
4. Press the **Tuning Up** or **Down buttons** until "DRC VAL" appears on the display. Then press the **Select button**. The display will show the current DRC value.
5. Press the **Tuning Up** or **Down buttons** to select the required DRC setting (default is 0).
6. Press and release the **Select button** to confirm the setting. The display will return to the normal radio display.

Note: Not all DAB broadcasts are able to use the DRC function. If the broadcast does not support DRC, then the DRC setting in the sound system will have no effect.

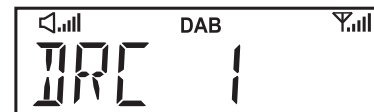
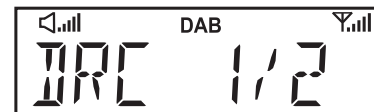
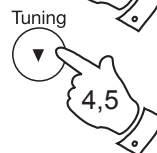
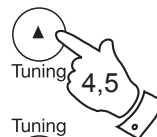

Operating your sound system - FM auto-tune

1. Fully extend the telescopic aerial. The aerial should be fully extended and positioned vertically for optimum reception.
2. Press the **On / Standby button** to switch on your sound system.
3. Press the **FM button** to select the FM band.
4. Press and hold down the **Tuning Up button** for 2 - 3 seconds to cause your radio to search from low frequency to high frequency and to stop automatically when it finds a station of sufficient strength.
5. After a few seconds the display will update. The display will show the frequency of the signal found. If the signal is strong enough and there is RDS data present then the radio will display the station name.
6. To find other stations press and hold the **Tuning Up button** as before.
7. Press and hold down the **Tuning Down button** for 2 - 3 seconds to cause your radio to search from high frequency to low frequency and to stop automatically when it finds a station of sufficient strength.
8. When the end of the waveband is reached your radio will recommence tuning from the opposite end of the waveband.
9. Adjust the **Volume** to the required setting.
10. To switch off your sound system press the **On / Standby button**.

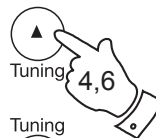

Note:

If you find that FM reception is poor, try repositioning the Telescopic aerial fully extend and position vertically for optimum reception. If you find that an FM broadcast has a lot of background hiss, this may often be reduced by setting the radio into Mono reception mode for the current FM station. Please refer to the section "Stereo / Mono setting - FM" on page 36 for further details.

Manual tuning - FM

1. Fully extend the telescopic aerial. The aerial should be fully extended and positioned vertically for optimum reception.
2. Press the **On / Standby button** to switch on your sound system.
3. Press the **FM button** to select the FM band.
4. Repeatedly press and release the **Tuning Up or Down buttons** to tune to a station. The frequency will change in steps of 50kHz.
If the radio is tuned to a station of sufficient signal strength with RDS information present, then the display may change to show the station name.
5. When the waveband end is reached the radio will recommence tuning from the opposite waveband end.
6. Adjust the **Volume** to the required setting.
7. To switch off your sound system press the **On / Standby button**.

Note:

If you find that FM reception is poor, try repositioning the Telescopic aerial fully extend and position vertically for optimum reception.

If you find that an FM broadcast has a lot of background hiss, this may often be reduced by setting the radio into Mono reception mode for the current FM station. Please refer to the section "Stereo / Mono setting - FM" on page 36 for further details.

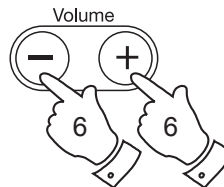
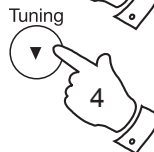
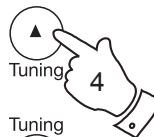

Display modes - FM

Your sound system has a range of display options for FM mode:-

The Radio Data System (RDS) is a system in which inaudible digital information is transmitted in addition to the normal FM radio programme. RDS offers several useful features. The following are available on your sound system.



1. Press the **Info button** to cycle through the various modes.

- | | |
|-------------------|---|
| a. Station name | Displays the name of the radio station being listened to. |
| b. Scrolling text | Displays scrolling text messages such as artist/track name, phone in number, etc. |
| c. Programme type | Displays type of station being listened to e.g. Pop, Classic, News, etc. |
| d. Time | Displays the current time (24 hour clock format) |
| e. Date | Displays current date. |
| f. Frequency | Displays the frequency of the station being listened to. |

Note: Your radio will display "NO TEXT" if there is no scrolling text and "NO PTY" if there is no programme type information.



Presetting stations

You may store your preferred DAB and FM radio stations to the preset station memories. There are 20 memory presets in your sound system, 10 for DAB and 10 for FM. Presets are remembered by your sound system in the event of a power failure.

The procedure for setting presets and using them to tune stations is the same for FM and DAB modes, and is described below.

1. Press the **On / Standby button** to switch on the sound system.
2. Press the **DAB** or **FM button** to select the desired waveband.
3. Tune to the required station as previously described.
4. Press and release the **Preset button**. The display will show, for example, "Empty 1" if no station has been stored to that preset.
5. Use the **Tuning Up** or **Down buttons** to select the desired preset station number under which you wish to store the station.
6. Press and hold down the **Preset button** until the display shows, for example, "P1 SAVED". The station will be stored under the chosen preset. Repeat this procedure for the remaining presets.
7. Stations which have been stored in preset memories may be overwritten by following the above procedure.

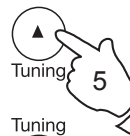

Recalling a preset station

1. Press the **On / Standby button** to switch on the sound system.
2. Press the **DAB** or **FM button** to select the desired waveband.
3. Press and release the **Preset button**. The display will show, for example, "Empty 1" if no station has been stored to that preset. If a preset has been stored, then the display will show either the station name (for DAB stations) or the frequency (for FM stations).
4. Press the **Tuning Up** or **Down buttons** to select the desired preset station.
5. Press the **Preset button**. Your radio will tune to the chosen preset station stored in the preset memory.

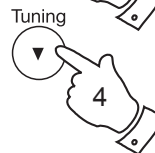
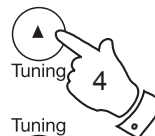

iPod docking

Your sound system has an iPod dock facility which allows you to play digital audio files and video soundtracks held on your iPod using the sound system's loudspeakers.

Your sound system uses the iPod Universal Dock connector developed for use with most iPods. Recent models of iPod are supplied with Universal Dock Adapter inserts which ensure correct alignment of the iPod with the electrical connector. Earlier models of iPod were not supplied with the necessary inserts and so your Sound 66 is supplied with inserts type 1-7. Should you require an insert to use your iPod with your sound system, then please contact an iPod accessories supplier.

Important: To avoid possible damage to your iPod, do not use your iPod with the product without the correct adapter fitted to the sound system.

Docking your iPod

1. Ensure that the sound system is in standby. Carefully remove the iPod dock connector cover from the top of your sound system.
2. Place the iPod docking Adapter (see above) into the iPod docking recess so that it is securely seated.
3. Carefully place your iPod onto the Universal Dock connector.
4. Press the **On / Standby button** to switch on your sound system.
5. To select the iPod mode press the **iPod button** until "IPOD" shows on the display. If it was previously playing, your iPod will switch on and continue playing from where it was previously stopped.

Note: Your sound system is able to recharge your iPod's internal battery. Recharging does not take place while your sound system is using DAB or FM radio. Your iPod will use its backlight settings as configured. If these need changing, use the Settings menu on your iPod.

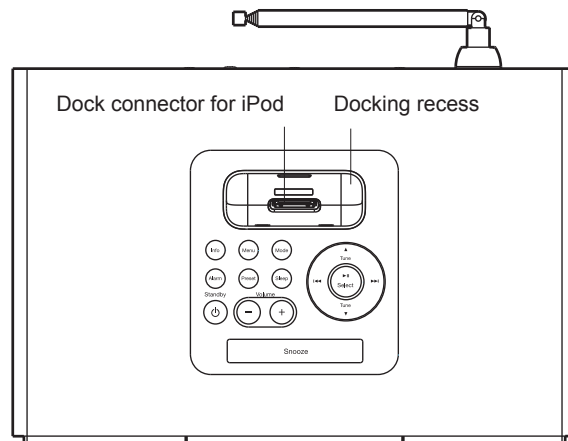

Navigating your iPod

Please note: Some of the iPod control functions are only available using the remote control or via the iPod's own controls. Not all iPods support remote menu navigation (for example, iPod nano 6th generation).

1. Use the **Menu button** to navigate to higher level menus on your iPod.
2. Use the **Tuning Up or Down buttons** as required to move up or down a menu screen on your iPod.
3. Press the **Select button** to choose the highlighted on screen menu item. If this item is a lower level menu item, you may then navigate further using the **Tuning Up or Down** and **Select buttons**.

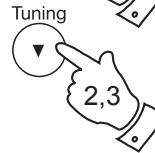
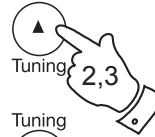

Playing a file on your iPod

1. When you have found the required item use the **Play / Pause button** on the sound system to start the iPod playing. If you have just docked your iPod, you may need to press the button more than once to ensure that the sound system is in communication with your iPod.
2. Adjust the volume to the required setting using the **Volume Up and Down buttons** on your sound system.
3. To pause playback press the **Play / Pause button**. To resume playback press the **Play / Pause button** again.
4. iPods do not have a Stop button (they use the Pause function). To play an alternative selection, use the iPod menus to make the selection using the **Play / Pause button** to stop playing the current item if needed.



Search function

1. While the iPod is playing, press and hold the **Fast-forward** or **Rewind buttons** to move through the current file or track. Release the button when the desired point in the file or track is reached.
2. Press and release either the **Fast-forward** or **Rewind buttons** to start playing the next or previous file or track.



Setting alarm times

Your sound system has two alarms which can be set to wake you to DAB, FM radio, iPod item or beep type alarm. Each alarm can be set to sound once, daily, on weekdays or at weekends. The alarms may be set while the unit is in Standby mode or while playing.

Note: If no buttons are pressed for several seconds, your sound system will exit the alarm setup.

1. If required press the **On / Standby button** to switch on the sound system.
2. Press and release the **Alarm button** "SET ALM" will appear on the display. Press the **Select button** to enter alarm setup.
3. "Alarm 1" flashes on the display.
4. Press the **Tuning Up** or **Down buttons** to select the desired alarm number, 1 or 2.
5. Press the **Select button** to enter the setting for the chosen alarm. Press the **Tuning Up** or **Down buttons** to select ON or OFF. If OFF is selected any current setting for that alarm will be cancelled.
6. Press the **Select button** to cause the alarm hour digits to flash on the display.
7. Press the **Tuning Up** or **Down buttons** to choose the desired alarm hour.

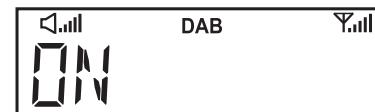
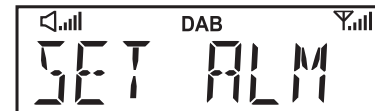
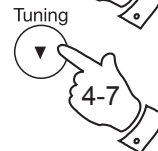
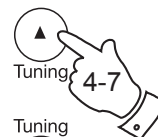

8. Press the **Select button** to enter the hour setting. The alarm minute digits will flash on the display.



9. Press the **Tuning Up** or **Down buttons** to choose the desired alarm minute.

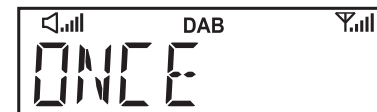
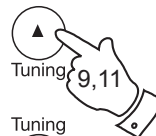

11. Press the **Tuning Up** or **Down buttons** to choose the desired alarm day option:

- Once - Will sound at one time only
- Daily - Will sound everyday
- Weekdays - Will sound only on weekdays
- Weekends - Will sound only on weekends

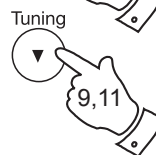

• If setting the alarm to once only, continue with step 12 below. Otherwise skip to step 18 on the following page.

12. Press the **Select button** to enter the setting. The alarm year will flash on the display.

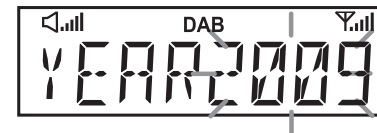

13. Press the **Tuning Up** or **Down buttons** to choose the alarm year.

14. Press the **Select button** to enter the alarm year setting. The alarm month will flash on the display.

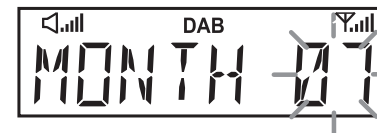
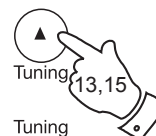

15. Press the **Tuning Up** or **Down buttons** to choose the alarm month.

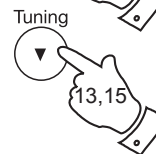

16. Press the **Select button** to enter the alarm month setting. The alarm day will flash on the display.

17. Press the **Tuning Up** or **Down buttons** to choose the alarm day.

18. Press the **Select button** to enter the setting. The alarm source option will flash on the display.

19. Repeatedly press the **Tuning Up** or **Down buttons** to choose the desired alarm source (DAB, FM, iPod, BUZ).

20. Press the **Select button** to confirm the alarm settings and return to normal radio mode.

Radio, Buzzer and iPod alarms are indicated in the display by the  symbol and the corresponding alarm number.

When your sound system is set to wake by the radio alarm, your sound system will switch to the last used DAB or FM radio station.

When the alarm activates the alarm will start softly and gradually increase in level.

For DAB, FM or iPod alarm you may adjust the volume while the alarm is active. Without intervention the volume will gradually increase up to a mid level.

Important: If using your iPod as the source for the alarm, then be sure to dock your iPod. After docking, briefly switch on the sound system using the **On / Standby button** and then select iPod mode using the **iPod button**. Next, press the **Play / Pause button** two or three times to ensure that the sound system and your iPod are communicating correctly. Failure to verify this may result in the alarm not being audible if the sound system is unable to activate your iPod when needed. When ready, put the sound system back into standby mode using the **On / Standby button**.

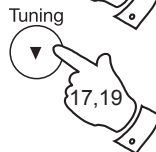
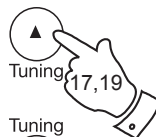
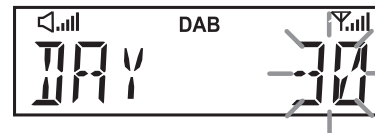

To view the alarm settings

1. Press the **Alarm button** "SET ALM" will show on the display. Press the **Select button** to enter the alarm setup.
2. Press the **Tuning Up** or **Down buttons** to view alarms 1 or 2.
3. Press the **Select button** to cycle through each of the settings for the chosen alarm.

You may use the Tuning Up and Down buttons to modify any particular setting if desired, using the Select button to enter the modification.

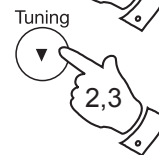
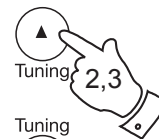
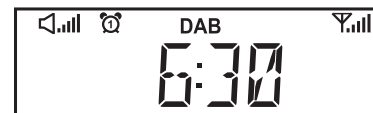

Cancelling alarms

1. While an alarm is sounding it can be cancelled by pressing the **On / Standby button**.



Snooze function

1. When the radio, iPod or buzzer alarm sounds, pressing the **Snooze button** will silence the alarm for the selected number of minutes. The Snooze duration can be adjusted between 5 and 20 minutes in 5 minute increments. The default setting is 5 minutes.

When the Snooze button has been pressed during an alarm, the Snooze symbol z^z will flash. This sequence can be repeated during the 60 minute alarm period.

2. To cancel the Snooze function, press the **On / Standby button**.

To set the snooze time

1. Press the **On / Standby button** to switch on the sound system. If necessary press and release the **DAB** or **FM button** to put the sound system into DAB or FM mode.
2. To set the snooze to the desired snooze time, press and release the **Menu button**.
3. Press the **Tuning Up** or **Down buttons** until "CLOCK" appears on the display. Then press the **Select button**.
4. Press the **Tuning Up** or **Down buttons** until "SNOOZE" appears on the display. Press and release the **Select button**.
5. Press the **Tuning Up** or **Down buttons** to choose the desired snooze setting from between 5, 10, 15 and 20 minutes.
6. Press the **Select button** to enter the desired snooze duration. The sound system will exit the menu options and return to the normal radio display.

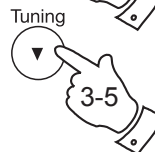
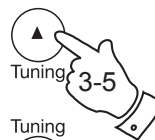
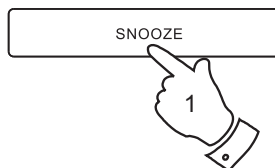

Sleep function

Your sound system can be set to turn off after a preset time has elapsed. The sleep setting can be adjusted between 5 and 90 minutes in 5 minute increments. Ensure your sound system is switched On.

1. When using your sound system, press the **Sleep button**. "SLEEP" appears on the display.
2. Repeatedly press the **Sleep button** to select desired sleep time. The sleep setting will increase in 5 minute increments from 5 minutes up to 90 minutes. A further press will cause the sleep timer to be set to OFF which will cancel the sleep function.
3. Press the **Select button**. The display will show the sleep timer setting then exit the sleep options. The sleep symbol $z z z$ will show on the display.
4. Your sound system will switch off after the preset sleep time has elapsed.
5. To cancel the sleep timer and switch off your sound system before the chosen sleep time has elapsed, press the **On / Standby button**.
To cancel the sleep timer without switching off your sound system, repeatedly press the **Sleep button** until "OFF" is displayed.

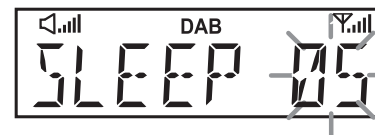

Setting the clock manually

Normally your sound system will set its clock automatically using the DAB radio signal. If no DAB signal is available and you need to set the time manually, please follow the procedure shown below.

1. Press the **On / Standby button** to switch on the sound system. If necessary press and release the **DAB** or **FM button** to put the sound system into DAB or FM mode.
2. To set the clock time, press the **Menu button** to enter the setup menu.
3. Press the **Tuning Up** or **Down buttons** until "CLOCK" appears on the display. Press and release the **Select button**.
4. Press the **Tuning Up** or **Down buttons** until "MANU CLK" appears on the display.
5. Press and release the **Select button** to enter the manual setting procedure. The hour digits will then flash on the display.
6. Press the **Tuning Up** or **Down buttons** to set the desired hour.
7. Press and release the **Select button** to enter the hour setting.
8. The minute digits will then flash on the display. Press the **Tuning Up** or **Down buttons** to set the desired minute.

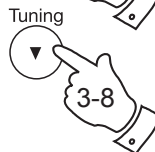
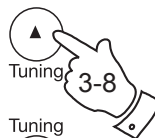

9. Press the **Select button** to enter the minutes setting. The year will then flash on the display.

10. Press the **Tuning Up** or **Down buttons** to change the year as needed.

11. Press the **Select button** to enter the year setting. The month will then flash on the display.

12. Press the **Tuning Up** or **Down buttons** to select the current month.

13. Press the **Select button** to enter the month setting. The day in the month will then flash on the display.

14. Press the **Tuning Up** or **Down buttons** to select the current day.

15. Press the **Select button** to confirm the time setting and return to the normal radio display.

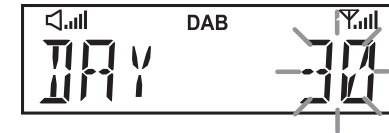
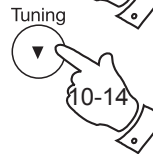
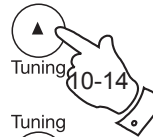
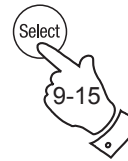

To return to auto clock set mode

1. Press the **On / Standby button** to switch on the sound system. If necessary press and release the **DAB button** to put the sound system into DAB mode.
2. Press and release the **Menu button** to enter the setup menu.
3. Press the **Tuning Up or Down buttons** until "CLOCK" appears on the display. Press and release the **Select button**.
4. Press the **Tuning Up or Down buttons** until "AUTO CLK" appears on the display. Press and release the **Select button**.
5. The sound system will immediately set its time according to the information received with the DAB broadcast. The sound system will return to normal radio operation with the time currently displayed.

Note: If you select "AUTO CLK" the current time received will be displayed. If no DAB signal is found, "NO CLOCK" will be displayed. You should then either position the sound system or its aerial so that a signal can be received, or revert to manual clock mode (see page 28).

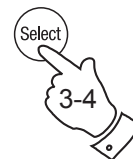
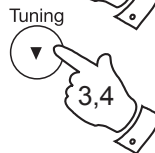
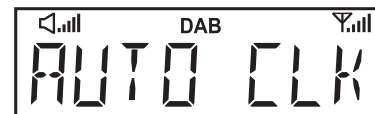
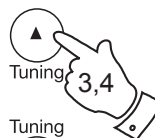

Equalizer function using remote control

The sound on your sound system can be adjusted to suit your personal taste for the material that you are listening to. The sound system has six preset equalizer modes. Alternatively, you may set the treble and bass levels to your own preferences.



1. Press the **Equalizer button** to cycle through the various modes.
 - a. Flat - no tone modification is applied
 - b. Jazz
 - c. Rock
 - d. Classic
 - e. Pop
 - f. News
 - g. Treble - tone setting may be adjusted
 - h. Bass - tone setting may be adjusted



Treble control

2. Press the **Equalizer button** to cycle through the modes until "TREB" appears on the display. The current treble setting will be shown on the display.
3. To adjust the treble setting press and release the **Rewind** or **Fast-forward buttons** until the desired level is displayed.
4. If you wish also to adjust the bass, then press the **Equalizer button** once more as described in step 5. Alternatively press the **Select button** to revert to the play mode display.

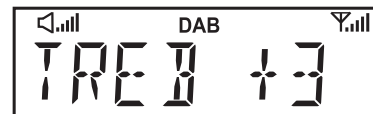

Bass control

5. Press the **Equalizer button** to cycle through the modes until "BASS" appears on the text display. The current bass setting will be shown on the display.
 6. To adjust the bass setting press and release the **Rewind or Fast-forward buttons** until the desired level is displayed.
 7. Press the **Select button** to revert to the play mode display.
- To quickly cancel the effect of the treble or bass settings press the **Equaliser button** until "Flat" appears on the display. The treble and bass settings will be remembered for the next time that you wish to adjust them.



Equalizer function using the sound system

1. Press the **On / Standby button** to switch on your sound system.
2. Press and release the **Menu button** "EQ" will show on the display.
3. Press and release the **Select button** to enter the EQ setup menu.
4. Press the **Tuning Up or Down buttons** to cycle through the various modes.
 - a. Flat - no tone modification is applied
 - b. Jazz
 - c. Rock
 - d. Classic
 - e. Pop
 - f. News
 - g. Treble - tone setting may be adjusted
 - h. Bass - tone setting may be adjusted

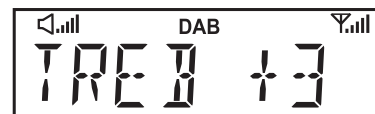
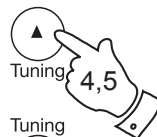
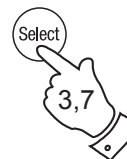

Treble control

5. Press the **Tuning Up or Down buttons** to cycle through the modes until "TREB" appears on the display. The current treble setting will be shown on the display.
6. To adjust the treble setting press and release the **Rewind or Fast-forward buttons** until the desired level is displayed.
7. If you wish also to adjust the bass, then press the **Tuning Up or Down buttons** once more as described in step 8. Alternatively press the **Select button** to revert to the play mode display.



Bass control

- Press the **Tuning Up** or **Down buttons** to cycle through the modes until "BASS" appears on the display. The current bass setting will be shown on the display.
 - To adjust the bass setting press and release the **Rewind** or **Fast-forward buttons** until the desired level is displayed.
 - Press the **Select button** to revert to the play mode display.
- To quickly cancel the effect of the treble or bass settings press the **Tuning Up** or **Down buttons** until "Flat" appears on the display. The treble and bass settings will be remembered for the next time that you wish to adjust them.

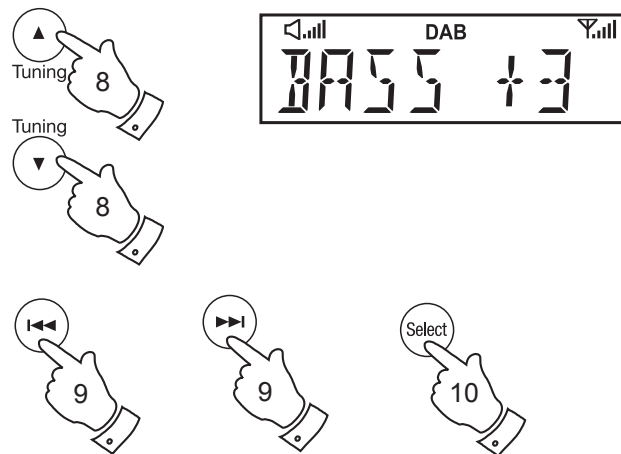

Mute function (Remote control only)

Pressing the Mute button will mute the output from the loudspeakers.

- Press the **Mute button** to mute the sound output. The speaker volume symbol on the display will disappear.
- Press the **Mute button** again or one of the **Volume buttons** to un-mute the sound output.



Clock display

1. When your sound system is in standby mode the time will be displayed.
The time is always shown using a 24 hour clock format.



Display backlight dimmer (Remote control only)

1. In order to adapt the intensity of the display to suit the ambient room lighting, Press the **Light button** (on the remote control) to select the dimmer brightness from Low, Mid, High or OFF settings.



Software version

The software display cannot be altered and is just for your reference. Ensure your sound system is switched on and in DAB or FM mode.

1. Press and release the **Menu button** to enter the setup menu.
2. Press the **Tuning Up** or **Down buttons** until "VERSION" appears on the display.
3. Press the **Select button** to view software information.
4. Press the **Menu button** to return to normal radio display mode.

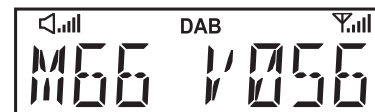
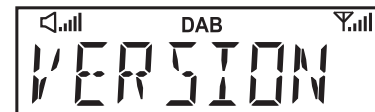
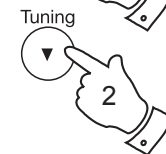
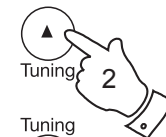

Stereo / Mono setting - FM

Your sound system will play stereo FM broadcasts in stereo provided that the received signal is of adequate strength. However, as a stereo signal becomes weaker the audio signal will become poorer. It may be preferable to force the sound system to play the station in mono in order to reduce the level of background hiss.

1. Press the **On / Standby button** to switch on your sound system.
2. Tune to the required FM radio station as previously described (see pages 14, 15).
3. Press and release the **Select button** until the display shows "MONO". While this setting is engaged, the radio will play the current station in mono whether listening via headphones or the loudspeaker.

The Mono override is a temporary setting and is applied to the currently tuned station only. It is cancelled automatically by tuning to another radio station.

4. If you wish to cancel the Mono override while listening to the currently tuned radio station, press and release the **Select button** until the display shows "AUTO". The radio will then play the current station in stereo if the signal is sufficiently strong.



System reset

If your sound system fails to operate correctly, or some digits on the display are missing or incomplete carry out the following procedure.

1. Press the **On / Standby button** to switch on the sound system. Ensure your Sound 66 is in DAB or FM mode.
2. Press and release the **Menu button**.
3. Press and release the **Tuning Up or Down buttons** until "FACTORY" appears on the display. Press and release the **Select button** so that the display shows "RESET" and then press the **Select button** again.
4. A full reset will be performed. The station list and presets will be erased. Alarms will be cancelled and snooze and sleep timer settings will be set to their default values. The display will show "ROBERTS" and after a few seconds a station scan search will be performed automatically. The display will show progress of the station search, for example ">>>> 18". The number on the right of the display is the number of stations that have been found.

In case of malfunction due to electrostatic discharge, reset the product as above to resume normal operation. If you are not able to perform the reset operation as above, removal and reconnection of the power supply may be required.

If a problem persists our technical staff would be pleased to offer any assistance on operating the sound system. Our technical helpline number is 020 8758 0338.

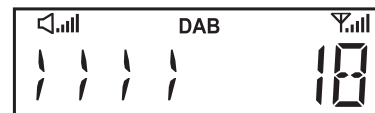
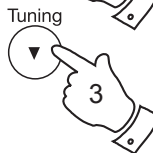
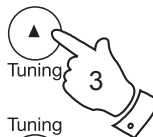

Headphone socket

A 3.5mm stereo **Headphone Socket** located on the rear of your sound system is provided for use with either headphones or an earpiece. Inserting a plug automatically mutes the internal loudspeaker.

IMPORTANT: Excessive sound pressure from earphones and headphones can cause hearing loss.

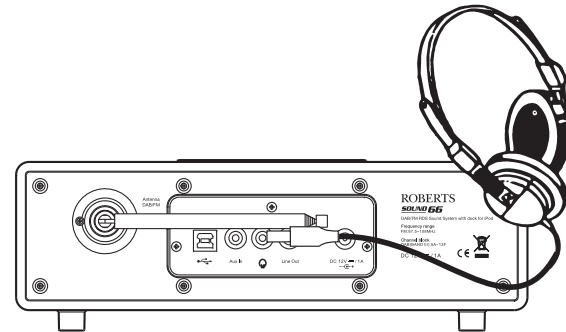

Auxiliary Input (Line in) socket

A 3.5mm stereo **Auxiliary Input socket** is provided on the rear of your sound system to permit an audio signal to be fed into the unit from an external audio device such as iPod, MP3 or CD player.

1. Connect a stereo or mono audio source (for example, iPod, MP3 or CD player) to the **Auxiliary Input socket** (marked "Aux In").
2. Press the **Aux button** until "AUX IN" is selected on the display.
3. Adjust the **Volume control** on your iPod, MP3 or CD player to ensure an adequate signal and then adjust the volume on the sound system for comfortable listening.

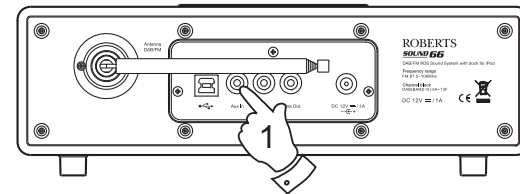

Line out socket (3.5mm Jack)

A 3.5mm **Line Out** socket located on the rear of your sound system is provided for connecting the audio signal to an external amplifier. Inserting an audio cable into this socket will not mute the internal loudspeaker. Set the volume control on the sound system to minimum if desired.

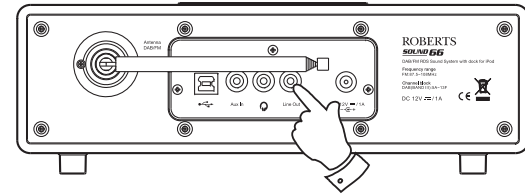

USB socket for software upgrade

Software updates for your **Sound 66** may be available in the future. If you register your product at www.robertsradio.co.uk/register and include a valid e-mail address you will receive notification of software updates.

As software updates become available software and information on how to update your sound system can be found at www.robertsradio.co.uk/support

Cautions

Do not allow this sound system to be exposed to water, steam or sand. Do not leave your sound system where excessive heat could cause damage such as in a parked car where the heat from the sun can build up even though the outside temperature may not seem too high. It is recommended that the DAB band be used wherever possible as better results in terms of quality and freedom from interference will usually be obtained than on the the FM band.

- The name plate is located on the rear of the unit.



- Your sound system should not be exposed to dripping or splashing and that no objects filled with liquids, such as vases, shall be placed on the sound system.
- It is recommended to operate the product such that there is a minimum distance (10cm recommended) to adjacent objects in order to ensure good ventilation.
- The ventilation of the product should not be restricted by covering it or its ventilation openings with items such as newspapers, tablecloths, curtains etc.
- No naked flame sources such as lighted candles should be placed on the product.
- It is recommended to avoid using or storing the product at extremes of temperature. Avoid leaving the unit in cars, on window sills, in direct sunlight etc.

Specifications

Power Requirements

Mains AC 100 ~ 240V 50/60Hz (Adaptor)

Frequency Coverage

FM	87.5-108MHz
DAB	174.928 - 239.200MHz

Circuit Features

Output Power 2 x 2.5 Watts

Headphone socket 3.5mm dia

Auxiliary Input socket 3.5mm dia

Line Output socket 3.5mm dia

Aerial System	FM	Telescopic aerial
	DAB	Telescopic aerial

The Company reserves the right to amend the specification without notice.

iPod is a trademark of Apple Inc., registered in the U.S. and other countries.

"Made for iPod" means that an electrical accessory has been designed to connect specifically to iPod and has been certified by the developer to meet Apple performance standards.

Apple is not responsible for the operation of the device or its compliance with safety and regulatory standards.

Guarantee

This instrument is guaranteed for twelve months from the date of delivery to the original owner against failure due to faulty workmanship or component breakdown, subject to the procedure stated below. Should any component or part fail during this guarantee period it will be repaired or replaced free of charge.

The guarantee does not cover:

1. Damage resulting from incorrect use.
2. Consequential damage.
3. Receivers with removed or defaced serial numbers.

N.B. Damaged or broken telescopic aerials will not be replaced under guarantee.

Procedure:

Any claim under this guarantee should be made through the dealer from whom the instrument was purchased. It is likely that your Roberts' dealer will be able to attend to any defect quickly and efficiently but should it be necessary the dealer will return the instrument to the Company's service department for attention. In the event that it is not possible to return the instrument to the Roberts' dealer from whom it was purchased, please contact Roberts Radio Technical Services at the address shown overleaf.

These statements do not affect the statutory rights of a consumer.

ROBERTS RADIO TECHNICAL SERVICES

97-99 Worton Road
Isleworth
Middlesex
TW7 6EG

Technical Helpline :- 020 8758 0338 (Mon-Fri during office hours)

Web site: <http://www.robertsradio.co.uk>



Issue 2

© 2010 Roberts Radio Limited



Free Manuals Download Website

<http://myh66.com>

<http://usermanuals.us>

<http://www.somanuals.com>

<http://www.4manuals.cc>

<http://www.manual-lib.com>

<http://www.404manual.com>

<http://www.luxmanual.com>

<http://aubethermostatmanual.com>

Golf course search by state

<http://golfingnear.com>

Email search by domain

<http://emailbydomain.com>

Auto manuals search

<http://auto.somanuals.com>

TV manuals search

<http://tv.somanuals.com>