

# CD-2e

## SD/CD RECORDER

## Owner's Manual



Before using this unit, carefully read the sections entitled: "USING THE UNIT SAFELY" and "IMPORTANT NOTES" (Page 8–10; Page 11–13). These sections provide important information concerning the proper operation of the unit. Additionally, in order to feel assured that you have gained a good grasp of every feature provided by your new unit, Owner's Manual should be read in its entirety. The manual should be saved and kept on hand as a convenient reference.

Copyright © 2007 ROLAND CORPORATION

All rights reserved. No part of this publication may be reproduced in any form without the written permission of ROLAND CORPORATION.

Roland International Web Site: <http://www.Roland.com/>

**For the U.K.**

**IMPORTANT:** THE WIRES IN THIS MAINS LEAD ARE COLOURED IN ACCORDANCE WITH THE FOLLOWING CODE.

BLUE: NEUTRAL  
BROWN: LIVE

As the colours of the wires in the mains lead of this apparatus may not correspond with the coloured markings identifying the terminals in your plug, proceed as follows:

The wire which is coloured BLUE must be connected to the terminal which is marked with the letter N or coloured BLACK.

The wire which is coloured BROWN must be connected to the terminal which is marked with the letter L or coloured RED.

Under no circumstances must either of the above wires be connected to the earth terminal of a three pin plug.

# Check the Included Items

The CD-2e includes the following items. Please take a moment to confirm that all of these items have been included with the CD-2e. If you find that any item is missing, contact the nearest authorized Roland distributor in your country.

**CD-2e**



**Owner's Manual**



**Quick Start**  
("Record Your Performance and Create a CD!")



**Remote controller**



**Application Guide**



**AC Adaptor/Power cord**

\* The shape of the power cord's plug varies depending on the country.



**SD memory card**

\* The SD memory card contains sample songs.



**Blank CD-R disc**



**Battery for remote controller (CR2025)**



\* Copyright law prohibits you from using the sample songs on the included SD memory card for any purpose other than personal enjoyment without permission from the copyright owner. Without such permission, you may not duplicate this data or make derivative works using it.

# Table of Contents

## Checking and Preparations

<b>USING THE UNIT SAFELY</b> .....	<b>8</b>
<b>IMPORTANT NOTES</b> .....	<b>11</b>
<b>Panel Descriptions</b> .....	<b>14</b>
<b>Media Usable for Recording</b> .....	<b>20</b>
<b>Turning the Power On and Off</b> .....	<b>21</b>
Using the Dedicated AC Adaptor .....	21
Using Batteries .....	22
<b>Preparing an SD Memory Card</b> .....	<b>24</b>
<b>Preparing a CD</b> .....	<b>27</b>
<b>Preparing the Remote Control</b> .....	<b>29</b>
Installing Batteries in the Remote Control .....	29
Using the Remote Control .....	29
<b>Menu Operations</b> .....	<b>31</b>
<b>About Easy Guide</b> .....	<b>34</b>

## Recording to SD/CD-R/CD-RW

<b>Before You Start Recording</b> .....	<b>35</b>
<b>Recording Acoustic Instruments or Vocals</b> .....	<b>36</b>
Recording with the Internal Mics .....	36
Connecting an External Mic for Recording .....	39
<b>Recording an Electronic Instrument</b> .....	<b>42</b>
<b>Recording a Cassette or MD</b> .....	<b>44</b>
<b>Recording Karaoke</b> .....	<b>46</b>
<b>Layering your Performance onto an SD Memory Card Song and Recording It</b> .....	<b>49</b>
<b>Convenient Functions for Recording</b> .....	<b>52</b>
Automatically Starting Recording When Audio is Detected .....	52
Assigning Song Numbers While Recording (Marker) .....	54
Preventing Loud Sounds from Distorting (Limiter) .....	57
Inserting a Count before Recording Begins (Count-in) .....	58

## Listening

<b>Listening to a CD/ Listening to an SD Memory Card</b> .....	<b>60</b>
<b>Convenient Functions for Playback</b> .....	<b>62</b>
Changing the Key of the Playback .....	62
Making Fine Adjustments to the Playback Pitch (Pitch) .....	63
Enjoying Simple Karaoke (Center Cancel) .....	64
Repeatedly Playing Tracks (1 Track/All Repeat) .....	65
A-B Repeat Playback .....	66
Slowing Down or Speeding Up Playback .....	67
Adding Reverberation (Reverb) .....	68
Muting the Sound of the Speakers .....	69













## Deleting

<b>Deleting Songs from an SD Memory Card</b> .....	<b>70</b>
Deleting Songs Individually .....	70
Erasing All Tracks .....	71
Deleting an Unwanted Region at the Beginning of the Song (Trim In) .....	72
Deleting an Unwanted Region at the End of the Song (Trim Out) .....	74
<b>Erasing Tracks from a CD-RW Disc</b> .....	<b>76</b>
Deleting One Song at a Time (Only the Last Song) .....	76
Erasing All Tracks .....	77
Removing Finalization .....	78







<b>Creating a CD</b>	Selecting Songs from an SD Memory Card to Create a CD.....	79
	Making a CD-R/RW Disc for Playback on Another CD Player (Finalize)...	83
	Creating a Duplicate of an Original Music CD (Backup).....	84
<b>Editing</b> an SD memory card	Moving a Song .....	87
	Dividing a Track .....	88
	Joining Songs .....	90
	Maximizing the Volume of a Song .....	91
<b>Viewing Information</b> and Screen display	Viewing the Remaining Recording/Playback Time .....	92
	Viewing Information about an SD Memory Card .....	93
	Viewing Information about a CD-R/RW Disc .....	94
	Adjusting the Readability of the Screen (Contrast).....	95
	Automatically Dimming the Screen (Backlight Timer) .....	96
<b>Convenient Functions</b> for practicing	Changing the Screen Display Language .....	97
	Sounding the Metronome .....	98
	Tuning Your Instrument (Tuner Function).....	100
	Changing the Tuner's Reference Pitch .....	101
<b>Advanced Uses</b>	Listening to a Guide Tone While Tuning .....	102
	Returning the Menu Settings to their Factory-Set Condition (Factory Reset) .....	103
	Formatting an SD Memory Card .....	104
	Adjusting the Left/Right Volume Balance of the Internal Mics.....	105
	Reversing the Stereo Field of the Internal Mics.....	106
<b>Appendices</b>	Connecting External Speakers.....	108
	Troubleshooting .....	110
	Messages .....	117
	Setting Items in Easy Guide.....	119
	Specifications .....	121
	Recommended SD Memory Card .....	122
	Recommended CD-R/RW Disc Manufacturers .....	123
Index .....	124	
	Information .....	129

# List of Common Tasks

## Recording

- Automatically start new songs at silent spaces when recording from a cassette or MD  **Page 56** (Auto Marker)
- Automatically start recording when a performance begins  **Page 52**  
(Automatically Recording)
- Let the CD-2e adjust the input level  **Page 38** (Auto Level)
- Sound a count before recording begins  **Page 58** (Count-in)
- Record your vocal along with karaoke backing  **Page 46** (Overdubbing)
- Overdub-record  **Page 49** (Overdubbing)
- Make a well-balanced recording of an ensemble  **Page 105**  
(Internal Mics Balance)
- Record without distortion  **Page 57** (Limiter)
- Return a CD-RW disc to a recordable state  **Page 78** (Unfinalize)
- Check how much recording time is left  **Page 92** (Remaining Time)
- Check the capacity of the currently inserted SD memory card  **Page 93** (Card Information)
- Check the capacity of the currently inserted CD-R/RW disc  **Page 94** (Disc Information)

## Deleting

- Delete a song from an SD memory card  **Page 70** (One Track)  
 **Page 71** (All Tracks)
- Delete a song from a CD-RW disc  **Page 76** (Last Track)  
 **Page 77** (All Tracks)
- Delete unwanted silence before or after a song  **Page 72** (Trim In)  
 **Page 74** (Trim Out)
- Protect an important song from accidental erasure  **Page 25** (Protect Switch)

## Listening

- Listen to the same phrase repeatedly 👉 Page 66 (A-B Repeat)

---

- Listen to a song repeatedly 👉 Page 65 (Repeat)

---

- Listen to a song at different speeds 👉 Page 67 (Speed)

---

- Use a commercial music CD for karaoke 👉 Page 64 (Center Cancel)

---

- Resume playback where you last stopped 👉 Page 61 (Resume)

---

- Apply reverb 👉 Page 68 (Reverb)

---

- Boost a softly recorded song to maximum volume 👉 Page 91 (Normalize)

---

## Creating a CD

- Make a duplicate of an original music CD you created 👉 Page 84 (Backup)

---

- Complete a CD 👉 Page 83 (Finalize)

---

## Others

- Use the CD-2e where there's no AC power 👉 Page 22 (Batteries)

---

- Extend battery life 👉 Page 96 (Backlight Timer)

---

- Connect speakers to listen 👉 Page 108 (External Speakers)

---

- Restore the CD-2e to its factory-set condition 👉 Page 103 (Factory Reset)

---

- Change the metronome's sound or tempo 👉 Page 98 (Metronome)

---

- Tune your instrument 👉 Page 100 (Tuner)



---



- Use the remote controller 👉 Page 29 (Remote Control)

---







# USING THE UNIT SAFELY

## INSTRUCTIONS FOR THE PREVENTION OF FIRE, ELECTRIC SHOCK, OR INJURY TO PERSONS

About  WARNING and  CAUTION Notices







 <b>WARNING</b>	Used for instructions intended to alert the user to the risk of death or severe injury should the unit be used improperly.
 <b>CAUTION</b>	Used for instructions intended to alert the user to the risk of injury or material damage should the unit be used improperly. * Material damage refers to damage or other adverse effects caused with respect to the home and all its furnishings, as well to domestic animals or pets.

About the Symbols







	The  symbol alerts the user to important instructions or warnings. The specific meaning of the symbol is determined by the design contained within the triangle. In the case of the symbol at left, it is used for general cautions, warnings, or alerts to danger.
	The  symbol alerts the user to items that must never be carried out (are forbidden). The specific thing that must not be done is indicated by the design contained within the circle. In the case of the symbol at left, it means that the unit must never be disassembled.
	The  symbol alerts the user to things that must be carried out. The specific thing that must be done is indicated by the design contained within the circle. In the case of the symbol at left, it means that the power-cord plug must be unplugged from the outlet.

### ALWAYS OBSERVE THE FOLLOWING

#### **WARNING**

- Before using this unit, make sure to read the instructions below, and the Owner's Manual. 
- Do not open (or modify in any way) the unit or its AC adaptor. 
- Do not attempt to repair the unit, or replace parts within it (except when this manual provides specific instructions directing you to do so). Refer all servicing to your retailer, the nearest Roland Service Center, or an authorized Roland distributor, as listed on the "Information" page. 
- Never use or store the unit in places that are:
  - Subject to temperature extremes (e.g., direct sunlight in an enclosed vehicle, near a heating duct, on top of heat-generating equipment); or are 
  - Damp (e.g., baths, washrooms, on wet floors); or are 
  - Humid; or are
  - Exposed to rain; or are
  - Dusty; or are
  - Subject to high levels of vibration.
- Make sure you always have the unit placed so it is level and sure to remain stable. Never place it on stands that could wobble, or on inclined surfaces. 

#### **WARNING**

- Be sure to use only the AC adaptor supplied with the unit. Also, make sure the line voltage at the installation matches the input voltage specified on the AC adaptor's body. Other AC adaptors may use a different polarity, or be designed for a different voltage, so their use could result in damage, malfunction, or electric shock. 
- Use only the attached power-supply cord. Also, the supplied power cord must not be used with any other device. 
- Do not excessively twist or bend the power cord, nor place heavy objects on it. Doing so can damage the cord, producing severed elements and short circuits. Damaged cords are fire and shock hazards! 
- This unit, either alone or in combination with an amplifier and headphones or speakers, may be capable of producing sound levels that could cause permanent hearing loss. Do not operate for a long period of time at a high volume level, or at a level that is uncomfortable. If you experience any hearing loss or ringing in the ears, you should immediately stop using the unit, and consult an audiologist. 
- Do not allow any objects (e.g., flammable material, coins, pins); or liquids of any kind (water, soft drinks, etc.) to penetrate the unit.   





**⚠ WARNING**

- Immediately turn the power off, remove the AC adaptor from the outlet, and request servicing by your retailer, the nearest Roland Service Center, or an authorized Roland distributor, as listed on the "Information" page when:
  - The AC adaptor, the power-supply cord, or the plug has been damaged; or
  - If smoke or unusual odor occurs
  - Objects have fallen into, or liquid has been spilled onto the unit; or
  - The unit has been exposed to rain (or otherwise has become wet); or
  - The unit does not appear to operate normally or exhibits a marked change in performance.

---

- In households with small children, an adult should provide supervision until the child is capable of following all the rules essential for the safe operation of the unit. 

---

- Protect the unit from strong impact. (Do not drop it!) 



---

- Do not force the unit's power-supply cord to share an outlet with an unreasonable number of other devices. Be especially careful when using extension cords—the total power used by all devices you have connected to the extension cord's outlet must never exceed the power rating (watts/amperes) for the extension cord. Excessive loads can cause the insulation on the cord to heat up and eventually melt through. 

---

- Before using the unit in a foreign country, consult with your retailer, the nearest Roland Service Center, or an authorized Roland distributor, as listed on the "Information" page. 



---

- Batteries must never be recharged, heated, taken apart, or thrown into fire or water.   



---

- Keep lithium batteries out of reach of small children. If a child has accidentally swallowed a battery, see a doctor immediately. 

---

- Lithium batteries must never be recharged, heated, taken apart, or thrown into a fire or water.   



---

- Never expose batteries to excessive heat such as sunshine, fire or the like. 

**⚠ CAUTION**

- The unit and the AC adaptor should be located so their location or position does not interfere with their proper ventilation. 

---

- Always grasp only the plug on the AC adaptor cord when plugging into, or unplugging from, an outlet or this unit. 

---

- At regular intervals, you should unplug the AC adaptor and clean it by using a dry cloth to wipe all dust and other accumulations away from its prongs. Also, disconnect the power plug from the power outlet whenever the unit is to remain unused for an extended period of time. Any accumulation of dust between the power plug and the power outlet can result in poor insulation and lead to fire. 

---

- Try to prevent cords and cables from becoming entangled. Also, all cords and cables should be placed so they are out of the reach of children. 

---

- Never climb on top of, nor place heavy objects on the unit. 

---

- Never handle the AC adaptor or its plugs with wet hands when plugging into, or unplugging from, an outlet or this unit. 

---

- Before moving the unit, disconnect the AC adaptor and all cords coming from external devices. 

---

- Before cleaning the unit, turn off the power and unplug the AC adaptor from the outlet. 

---

- Whenever you suspect the possibility of lightning in your area, disconnect the AC adaptor from the outlet. 

Checking / Preparations

Recording

Listening

Deleting

Creating a CD

Editing an SD







Information / Display

Convenient Functions

Advanced Uses

Appendices

**⚠ CAUTION**

- If used improperly, batteries may explode or leak and cause damage or injury. In the interest of safety, please read and observe the following precautions (Page 22, 29).   

  - Carefully follow the installation instructions for batteries, and make sure you observe the correct polarity. 
  - Avoid using new batteries together with used ones. In addition, avoid mixing different types of batteries.
  - Remove the batteries whenever the unit is to remain unused for an extended period of time.
  - If a battery has leaked, use a soft piece of cloth or paper towel to wipe all remnants of the discharge from the battery compartment. Then install new batteries. To avoid inflammation of the skin, make sure that none of the battery discharge gets onto your hands or skin. Exercise the utmost caution so that none of the discharge gets near your eyes. Immediately rinse the affected area with running water if any of the discharge has entered the eyes.
  - Never keep batteries together with metallic objects such as ballpoint pens, necklaces, hairpins, etc.
  - Before use, carefully read the cautions printed on the battery as well as the owner's manual that accompanies the battery.
- 
- Used batteries must be disposed of in compliance with whatever regulations for their safe disposal that may be observed in the region in which you live. 
- 
- Use only the specified type (model no.CR2025) of lithium battery (Page 29). Be sure to insert it as directed (to ensure correct polarity). 
- 
- Used lithium batteries must be disposed of in compliance with whatever regulations for their safe disposal that may be observed in the region in which you live. 
- 
- Keep any battery for remote controller you may remove and the included SD memory card in a safe place out of children's reach, so there is no chance of them being swallowed accidentally. 
-

# IMPORTANT NOTES

In addition to the items listed under “USING THE UNIT SAFELY” on page 8–10, please read and observe the following:

## Power Supply: Use of Batteries

- Do not connect this unit to same electrical outlet that is being used by an electrical appliance that is controlled by an inverter (such as a refrigerator, washing machine, microwave oven, or air conditioner), or that contains a motor. Depending on the way in which the electrical appliance is used, power supply noise may cause this unit to malfunction or may produce audible noise. If it is not practical to use a separate electrical outlet, connect a power supply noise filter between this unit and the electrical outlet.
- The AC adaptor will begin to generate heat after long hours of consecutive use. This is normal, and is not a cause for concern.
- The use of an AC adaptor is recommended as the unit’s power consumption is relatively high. Should you prefer to use batteries, please use the alkaline type.
- When installing or replacing batteries, always turn off the power on this unit and disconnect any other devices you may have connected. This way, you can prevent malfunction and/or damage to speakers or other devices.
- Before connecting this unit to other devices, turn off the power to all units. This will help prevent malfunctions and/or damage to speakers or other devices.

## Placement

- Using the unit near power amplifiers (or other equipment containing large power transformers) may induce hum. To alleviate the problem, change the orientation of this unit; or move it farther away from the source of interference.
- This device may interfere with radio and television reception. Do not use this device in the vicinity of such receivers.
- Noise may be produced if wireless communications devices, such as cell phones, are operated in the vicinity of this unit. Such noise could occur when receiving or initiating a call, or while conversing. Should you experience such problems, you should relocate such wireless devices so they are at a greater distance from this unit, or switch them off.
- Do not expose the unit to direct sunlight, place it near devices that radiate heat, leave it inside an enclosed vehicle, or otherwise subject it to temperature extremes. Excessive heat can deform or discolor the unit.
- When moved from one location to another where the temperature and/or humidity is very different, water droplets (condensation) may form inside the unit. Damage or malfunction may result if you attempt to use the unit in this condition. Therefore, before using the unit, you must allow it to stand for several hours, until the condensation has completely evaporated.

## Placement (continued)

- Depending on the material and temperature of the surface on which you place the unit, its rubber feet may discolor or mar the surface. You can place a piece of felt or cloth under the rubber feet to prevent this from happening. If you do so, please make sure that the unit will not slip or move accidentally.

## Maintenance

- For everyday cleaning wipe the unit with a soft, dry cloth or one that has been slightly dampened with water. To remove stubborn dirt, use a cloth impregnated with a mild, non-abrasive detergent. Afterwards, be sure to wipe the unit thoroughly with a soft, dry cloth.
- Never use benzene, thinners, alcohol or solvents of any kind, to avoid the possibility of discoloration and/or deformation.

## Additional Precautions

- Please be aware that the contents of memory can be irretrievably lost as a result of a malfunction, or the improper operation of the unit. To protect yourself against the risk of losing important data, we recommend that you periodically save a backup copy of important data you have stored in a CD-R/RW disc.
- Unfortunately, it may be impossible to restore the contents of data that was stored on an SD memory card or CD-R/RW disc once it has been lost. Roland Corporation assumes no liability concerning such loss of data.
- Use a reasonable amount of care when using the unit’s buttons, sliders, or other controls; and when using its jacks and connectors. Rough handling can lead to malfunctions.
- Never strike or apply strong pressure to the display.
- When connecting / disconnecting all cables, grasp the connector itself—never pull on the cable. This way you will avoid causing shorts, or damage to the cable’s internal elements.
- To avoid disturbing your neighbors, try to keep the unit’s volume at reasonable levels. You may prefer to use headphones, so you do not need to be concerned about those around you (especially when it is late at night).
- When you need to transport the unit, package it in the box (including padding) that it came in, if possible. Otherwise, you will need to use equivalent packaging materials.

## Handling SD memory cards

- Do not remove the SD memory card while the CD-2e is powered up. Doing so may damage the data stored on the SD memory card.
- Carefully insert the SD memory card all the way in—until it is firmly in place.

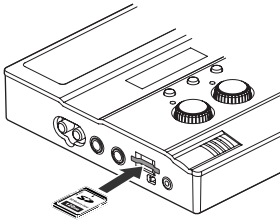

- Never touch the terminals of the SD memory card. Also, avoid getting the terminals dirty.
- SD memory cards are constructed using precision components; handle the cards carefully, paying particular note to the following.
  - To prevent damage to the cards from static electricity, be sure to discharge any static electricity from your own body before handling the cards.
  - Do not touch or allow metal to come into contact with the contact portion of the cards.
  - Do not bend, drop, or subject cards to strong shock or vibration.
  - Do not keep cards in direct sunlight, in closed vehicles, or other such locations (storage temperature: -25 to 85° C).
  - Do not allow cards to become wet.
  - Do not disassemble or modify the cards.
- Please read the documentation that is included with your memory cards.

## Handling the CD-R/RW drive

- Install the unit on a solid, level surface in an area free from vibration.
- Never use the emergency eject hole to open the disc tray while the this unit is operating.
- Remove any disc from the drive before powering up or down.
- To avoid the risk of malfunction and/or damage, insert only discs with  into the CD-R/RW drive. Never insert any other type of disc. Avoid getting paper clips, coins, or any other foreign objects inside the drive.

## Handling CD-R/RW Discs

- Don't use unusually shaped discs, such as heart-shaped or octagonal discs. Doing so may damage the CD-2e.
- Do not bend the disc.
- Do not drop or stack discs.
- Do not place heavy objects on a disc, or subject it to strong physical shock.
- Hold a disc by inserting a finger in the center hole and pressing your thumb against the outer edge. Be careful not to get fingerprints on, or scratch the recording surface of, the disc (the green surface).

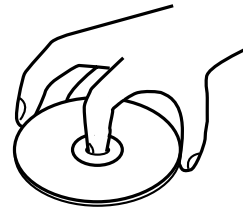

- Do not use in dusty areas.
- Do not leave the disc in direct sunlight or an enclosed vehicle.
- Do not keep the disc in the CD-R/RW drive for a long time.
- To protect the disc, keep it in its original case.
- Do not use CDs that have a CD label or sticker affixed to them. You may be unable to remove the CD, or it may cause the CD-2e to malfunction.
- When writing a title on the label surface of the disc, use a soft-tipped writing implement such as a felt pen.
- Wipe the disc with a soft and dry cloth radially from inside to outside. Do not wipe along the circumference.

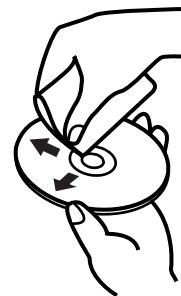

- Keep your discs clean using a commercially available CD cleaner. Do not use benzene, record cleaner spray or solvents of any kind.
- Please read the documentation that is included with your CD-R/RW discs.

## Copyright

- Recording, duplication, distribution, sale, lease, performance, or broadcast of copyrighted material (musical works, visual works, broadcasts, live performances, etc.) belonging to a third party in part or in whole without the permission of the copyright owner is forbidden by law.
- This product can be used to record or duplicate audio material without being limited by certain technological copy-protection measures. This is due to the fact that this product is intended to be used for the purpose of producing original music, and is therefore designed so that material that does not infringe copyrights belonging to others (for example, your own original works) can be recorded or duplicated freely.
- Do not use this unit for purposes that could infringe on a copyright held by a third party. We assume no responsibility whatsoever with regard to any infringements of third-party copyrights arising through your use of this unit.

## About the License Agreement

- The CD-2e's CD-writing functionality, and its backing-up functionality are designed to allow you to reproduce material to which you have copyright, or material which the copyright owner has granted you permission to copy. Accordingly, reproduction of Music CD or other copyrighted material without permission of the copyright owner avoiding technical prohibiting features of second-generation and later copying like SCMS or others constitutes copyright infringement and may incur penalties even in case such reproduction is for your own personal use and enjoyment (private use). Consult a copyright specialist or special publications for more detailed information on obtaining such permission from copyright holders.

\* The SD logo (  ) and SDHC logo (  ) are trademarks.

\* All product names mentioned in this document are trademarks or registered trademarks of their respective owners.

\* Fugue © 2007 Kyoto Software Research, Inc. All rights reserved.



# Panel Descriptions

## Top Panel

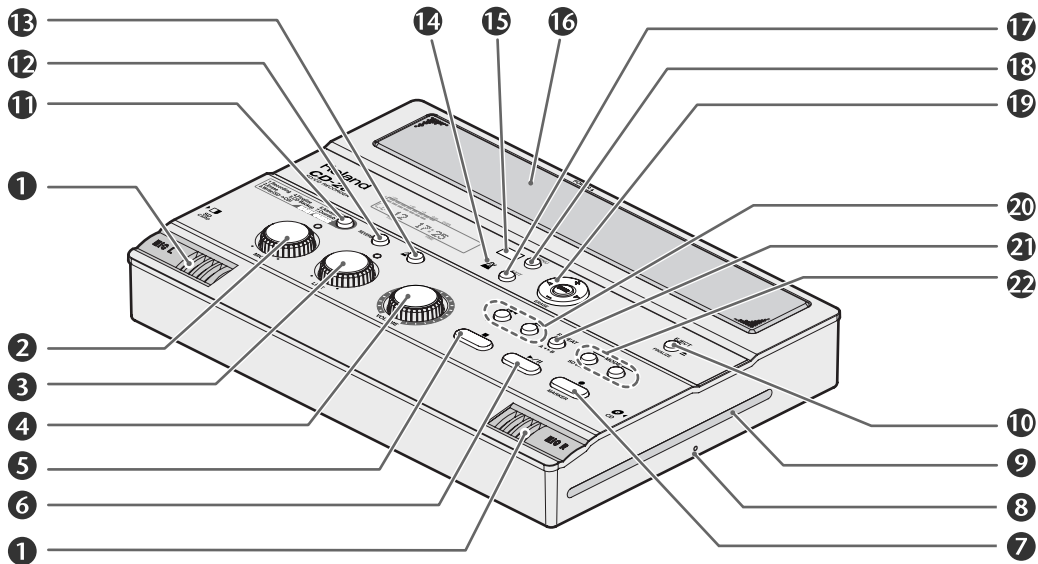

### 1 MIC L/MIC R

This is a stereo pair of mics built into the CD-2e. You can use these mics to record.

☞ "Recording with the Internal Mics" (Page 36)

### 2 [MIC] Knob

This adjusts the input level of the internal mics and the EXT MIC jack.

If the input sound is too loud, the peak indicator above the [MIC] knob will light. 

\* If you turn the [MIC] knob all the way to the left, no sound will be input from the internal mics or the EXT MIC jack.

\* If the [MIC LEVEL] switch is in the "AUTO" position (Page 38), the input level will be set automatically, and you won't be able to adjust the input level using the [MIC] knob.

☞ "Recording with the Internal Mics" (Page 36),  
"Connecting an External Mic for Recording" (Page 39)

### 3 [LINE] Knob

This adjusts the input level of the LINE IN jack.

If the input sound is too loud, the peak indicator above the [LINE] knob will light. 

\* If you turn the [LINE] knob all the way to the left, no sound will be input from the LINE IN jacks.

☞ "Recording an Electronic Instrument" (Page 42),  
"Recording a Cassette or MD" (Page 44)

### 4 [VOLUME] Knob

This knob adjusts the volume of the internal speakers and the headphones.

☞ "Listening to a CD/ Listening to an SD Memory Card" (Page 60)

### 5 [■ (Stop)] Button

This button stops playback or recording.

☞ "Listening to a CD/ Listening to an SD Memory Card" (Page 60)

### 6 [▶/|| (Play)] Button

- This button starts playback or recording.

- During playback or recording, you can press this button to pause. Press it once again to resume playback or recording from the location at which you paused.

- If you pause recording, the next track will be started at the point you resumed recording.

☞ "Listening to a CD/ Listening to an SD Memory Card" (Page 60)

### 7 [● (Record)] Button

- Press this button to enter recording-standby mode.

- During recording, you can press this button to assign a track number.

☞ "Press the [● (Record)] button to Assign a Song number" (Page 54)

**8 Emergency Eject Hole**

You can use this to remove the CD in case of emergency. Normally, it is not used.

🔊 “If you are unable to eject the disc” (Page 28)

**9 CD Slot**

This is where you insert a CD.

🔊 “Inserting a CD” (Page 27)

**10 [EJECT( ▲ )] Button**

Press this to eject the CD.

🔊 “Removing a CD” (Page 28)

- \* If an unfinalized CD-R/RW disc is inserted, a message asking whether you want to finalize the disc before ejecting will appear when you press the [EJECT( ▲ )] button.

🔊 “Making a CD-R/RW Disc for Playback on Another CD Player (Finalize)” (Page 83)

**11 [EASY GUIDE] Button**

This button accesses the Easy Guide screen. Here you can record or create a CD by following the on-screen instructions.

🔊 “About Easy Guide” (Page 34)

**12 [REVERB] Button**

This button lets you turn reverb on or off, and adjust the reverb depth.

🔊 “Adding Reverberation (Reverb)” (Page 68)

**13 [  (Metronome)] Button**

This turns the metronome on/off.

🔊 “Sounding the Metronome” (Page 98)

**14 Metronome Indicator**

This will blink if the metronome is on.

🔊 “Sounding the Metronome” (Page 98)

**15 Remote Sensor**

This receives data from the remote control.

🔊 “Using the Remote Control” (Page 29)

**16 Stereo Speakers**

These are a pair of stereo speakers built into the CD-2e.

**17 [EXIT] Button**

- After you’ve modified the setting for a menu item, press this to return to the audio source display.
- Press this to answer “no” to messages shown in the display.

**18 [MENU] Button**

This button accesses the menu screen. Here you can make settings for recording/playback, and settings for the CD-2e itself.

🔊 “Menu Operations” (Page 31)

**19 Function Button**

This button is used mainly to perform menu operations.

🔊 “Menu Operations” (Page 31)

**● [ ◀ ] [ ▶ ] Buttons (Left/Right)**

These buttons select menu items from a menu screen.

- \* From the audio source display, pressing the [ ◀ ] [ ▶ ] buttons will access a screen where you can specify the playback level of the player (SD/CD).

🔊 “Recording Karaoke” (Page 46), “Layering Your Performance onto an SD Memory Card Song and Recording It” (Page 49)

**● [ + ] [ - ] Buttons (Up/Down)**

These buttons modify the value of a menu item.

- \* From the audio source display, pressing the [ - ] button will access a screen where you can confirm whether you want to delete the song.

🔊 “Deleting Songs Individually” (Page 70), “Deleting One Song at a Time (Only the Last Song)” (Page 76)

**● [ENTER] Button (Center)**

- This button confirms a menu item and displays a screen where you can edit that item.
- Press this to answer “yes” to messages shown in the display.

**20 [ ◀◀ ] [ ▶▶ ] Buttons**

- You can use these buttons to jump to the beginning of the preceding or the following track. During playback, the [ ◀◀ ] button takes you back to the beginning of the currently playing track.
  - While stopped, press and hold these buttons to rapidly move to the beginning of the track.
  - During playback, press and hold one of these buttons to rewind or fast-forward.
  - While paused, press and hold these buttons to rapidly rewind or fast-forward.
- 🔊 “Listening to a CD/ Listening to an SD Memory Card” (Page 60)

**21 [REPEAT] Button**

This button repeatedly plays back the region you specify.

🔊 “A-B Repeat Playback” (Page 66)

**22 MODE Button**

These buttons select the audio source. The selected button will light.

[SD CARD] button	Selects “SD memory card” as the audio source.
[CD] button	Selects “CD” as the audio source.

## Display

The display shows information or messages related to the operation you're performing, such as when you're making various settings or editing tracks.

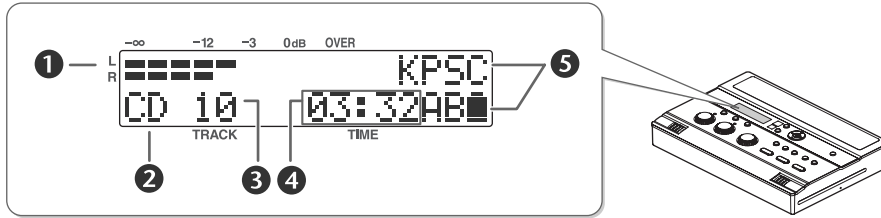

### 1 LEVEL Meter

This indicates the volume level of the track that's playing or the instrument or mic that's being input.

### 2 Source Name Indicator

This indicates the name of the currently selected audio source.

### 3 TRACK Indicator

This indicates the track number.

### 4 TIME Indicator

This indicates the elapsed playback or recording time.

You can switch the time information that's shown here

☞ "Viewing the Remaining Recording/Playback Time" (Page 92)

### 5 Symbol Indicators

K	Displayed when the key is being altered. ☞ Page 62
P	Displayed when the playback pitch is being altered. ☞ Page 63
S	Displayed when the playback speed is being altered. ☞ Page 67
C	Displayed when the Center Cancel function is on. ☞ Page 64
R1	Displayed during one-track repeat playback. ☞ Page 65
RA	Displayed during all-track repeat playback. ☞ Page 65
AB	Displayed during A-B repeat playback. ☞ Page 66
■	This is shown if the CD-2e is running on batteries. It indicates the remaining battery power.

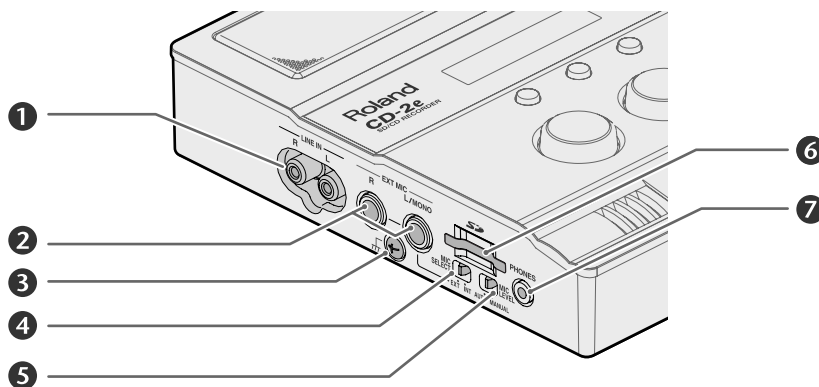

## Side Panel

**1 LINE IN Jacks**

Connect an electronic piano, keyboard, cassette deck, etc. to these jacks.

☞ "Recording an Electronic Instrument" (Page 42),  
"Recording a Cassette or MD" (Page 44)

**2 EXT MIC Jacks (R jack, L/MONO jack)**

Connect external mics to these jacks.

If you're using only one mic, connect it to the L/MONO jack.

☞ "Connecting an External Mic for Recording" (Page 39)

**3 Grounding Terminal**

Connect this to an external electrical ground.

Depending on the circumstances of a particular setup, you may experience a discomfiting sensation, or perceive that the surface feels gritty to the touch when you touch this device, microphones connected to it, or the metal portions of other objects, such as guitars. This is due to an infinitesimal electrical charge, which is absolutely harmless. However, if you are concerned about this, connect the ground terminal (see figure) with an external ground. When the unit is grounded, a slight hum may occur, depending on the particulars of your installation. If you are unsure of the connection method, contact the nearest Roland Service Center, or an authorized Roland distributor, as listed on the "Information" page

**Unsuitable places for connection**

- Water pipes (may result in shock or electrocution)
- Gas pipes (may result in fire or explosion)
- Telephone-line ground or lightning rod (may be dangerous in the event of lightning)

**4 [MIC SELECT] Switch**

This selects the mic(s) to be used for recording.

Switch setting	Explanation
INT (internal)	Record using the internal mics.
EXT (external)	Record using an external mic.

☞ "Recording with the Internal Mics" (Page 36),  
"Connecting an External Mic for Recording" (Page 39)

**5 [MIC LEVEL] Switch**

This selects how the mic input level is to be adjusted.

Switch position	Explanation
MANUAL	The [MIC] knob will adjust the mic's input level.
AUTO	The mic input level will be adjusted automatically. Operating the [MIC] knob will not affect the input level.

☞ "Recording Acoustic Instruments or Vocals" (Page 36),  
"Adjusting the Input Level Automatically (Auto Level Function)" (Page 38)

**6 SD Card Slot**

You can insert an SD memory card here.

☞ "Preparing an SD Memory Card" (Page 24)

**7 PHONES Jack**

You can connect a set of headphones to this jack.

\* If headphones are connected, there will be no sound from the speakers.

☞ Step 4 on "Recording with the Internal Mics" (Page 36)

Rear Panel/ Bottom Panel

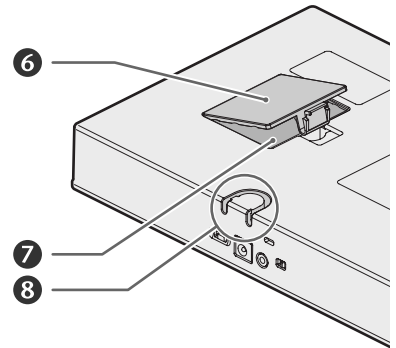
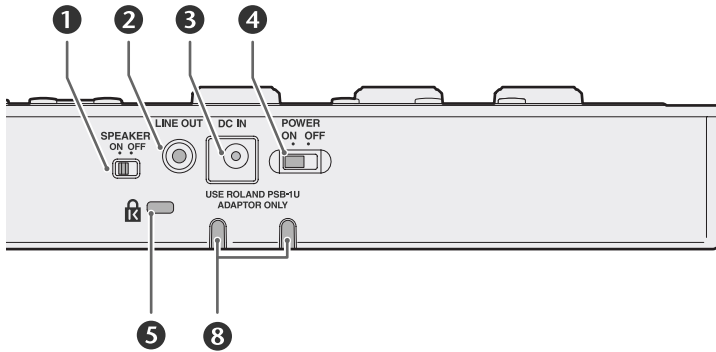

**1 [SPEAKER] Switch**

Specifies whether or not sound is to be produced by the internal speakers.

Switch position	Explanation
ON	Sound will be heard from the internal speakers.
OFF	The internal speakers will be muted.

☞ "Muting the Sound of the Speakers" (Page 69)

**2 LINE OUT Jack**

Use this jack to output analog audio signals to an external speaker system or electronic piano.

☞ "Connecting External Speakers" (Page 108)

You can choose the audio signal that will be output from the LINE OUT jack.

☞ "Selecting the Audio Source that's Sent from the LINE OUT Jack" (Page 109)

**3 AC Adaptor Connector**

Connect the dedicated AC adaptor (included) here.

☞ "Using the Dedicated AC Adaptor" (Page 21)

**4 [POWER] Switch**

This turns the power on/off.

Switch position	Explanation
ON	Power is on.
OFF	Power is switched off.

☞ "Using the Dedicated AC Adaptor" (Page 21), "Using Batteries" (Page 22)

**5 Security Slot (🔒)**

You can attach a commercially available security lock here. For details, refer to the following website: <http://www.kensington.com/>

**6 Battery Cover**

☞ "Using Batteries" (Page 22)

**7 Battery Compartment**

Install batteries here if you want to operate the CD-2e on batteries.

If you're using the dedicated AC adaptor, it's not necessary to install batteries.

☞ "Using Batteries" (Page 22)

**Note**

You must turn off the power before performing the following operations.

- Switching from operation with the dedicated AC adaptor to battery operation
- Switching from battery operation to operation with the dedicated AC adaptor

**8 Cord Hook**



Use this cord hook to fasten the cord of the dedicated AC adaptor (included) so that it doesn't become accidentally unplugged.

☞ "Using the Dedicated AC Adaptor" (Page 21)

## Remote Control



Performs record/playback operations for the CD or SD memory card. These have the same function as the buttons on the CD-2e itself.

### Adjusting the volume

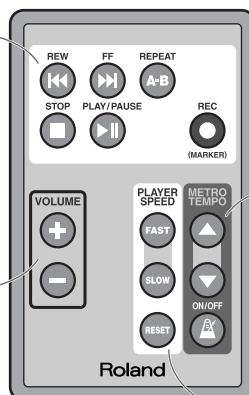

-  Higher volume.
-  Lower volume.



### Metronome settings

-  Makes the metronome tempo faster.
-  Makes the metronome tempo slower.
-  Turns the metronome on/off.

### Playback speed settings

-  Makes the playback faster.
-  Makes the playback slower.
-  Returns to the original playback speed.

### Note

The [VOLUME] knob of the CD-2e itself does not move when you adjust the volume from the remote control. This may cause the actual volume to no longer match the position of the [VOLUME] knob.

If you're using headphones, use the [VOLUME] knob of the CD-2e itself to lower the volume before you start listening. This will help prevent high volume from damaging your hearing.





### Important

For details on installing batteries in the remote control and using the remote control, refer to "Preparing the Remote Control" (Page 29).

# Media Usable for Recording

As its recording media, the CD-2e uses ① SD memory cards, ② CD-R discs, and ③ CD-RW discs. The functions available for editing or deleting songs (tracks) after recording will differ according to the media you use.

The table below shows the functions available for each type of media.

CD-2e function		Media			
		SD memory card	CD-R disc	CD-RW disc	Music CD
			8x speed supported	4x/8x speeds supported	
					
Recording	Conventional recording	✓	✓	✓	
	Overdubbing	✓			
Playback		✓	✓	✓	✓
Edit tracks		✓			
Delete tracks		✓		✓	
Cancel finalization				✓	
Create an original music CD			✓	✓	
Backup an original music CD			✓	✓	

\* For a list of recommended SD memory cards, refer to "Recommended SD Memory Card" (Page 122).

\* For a list of recommended CD-R/RW disc manufacturers, refer to "Recommended CD-R/RW Disc Manufacturers" (Page 123).

\* In order for a CD-R/RW disc recorded on the CD-2e to be playable on another CD player, an operation called "finalizing" (Page 83) must be performed on that disc.

\* We cannot guarantee that a music CD created on the CD-2e will play on all CD players. Depending on your CD player's support for CD-R/RW discs, music CDs you create may or may not play correctly.

## Differences between CD-R discs and CD-RW discs

Unlike conventional music CDs, both of these discs allow recording.

A song recorded on a CD-R (Compact Disc Recordable) disc cannot be erased later.

You should use CD-R discs in the following cases.

- To record an important performance
- To create a CD from songs you've recorded on an SD memory card
- To back up an original music CD

CD-RW (Compact Disc ReWritable) discs allow you to erase a song you've recorded. Songs can be erased one by one starting at the last-recorded song, or you can erase all songs in a single operation.

CD-RW discs can be recorded and erased approximately 1,000 times.

You should use CD-RW discs in the following cases.

- To record your practicing
- To make a "sketchpad" of your musical ideas

# Turning the Power On and Off

You can operate the CD-2e either from a household electrical outlet or using six AA batteries (sold separately).

## Using the Dedicated AC Adaptor

If you're using the dedicated AC adaptor, batteries are not required.

### 1 Connect the power

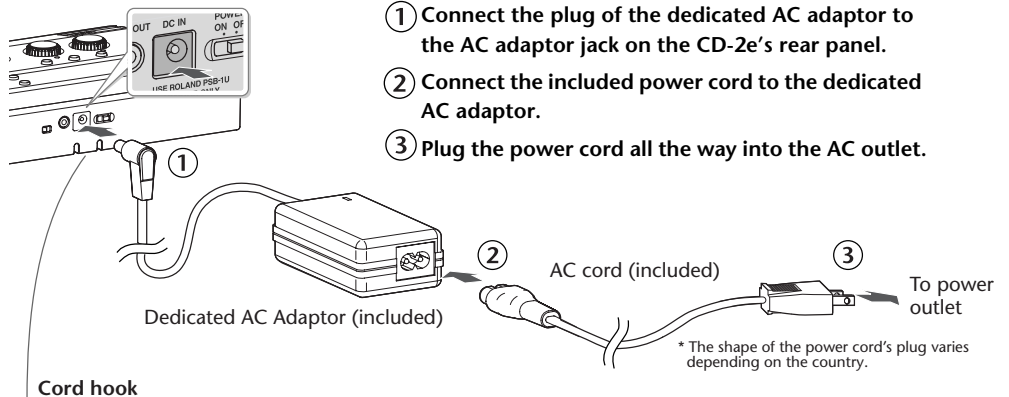

Cord hook

Bottom of the CD-2e

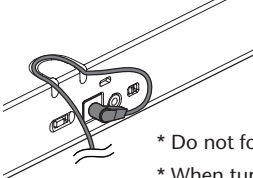

The CD-2e's rear panel has a slot and cord hook for securing the cord of the dedicated AC adaptor. Use the cord hook to fasten the AC adaptor cord so that it won't be pulled out accidentally.

\* Do not force the cord into the slot. Doing so may break it.

\* When turning the CD-2e upside down, place stacks of newspapers or magazines to support the four corners (or two sides) so that stress is not placed on the buttons or knobs, possibly damaging them. Also, handle the CD-2e with care, and avoid dropping it.

### 2 On the CD-2e's rear panel, move the [POWER] switch to the "ON" position.

When the power is turned on, the screen will light.

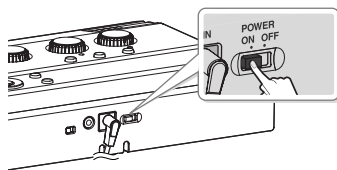

## Turning the power off

### 1 On the CD-2e's rear panel, move the [POWER] switch to the "OFF" position.

## Using Batteries

### Note

If you're operating the CD-2e on batteries, you won't be able to perform CD-related operations such as recording, playing, or writing songs, etc.

### Batteries to use

AA alkaline batteries

\* You cannot use zinc-carbon batteries or rechargeable batteries (such as rechargeable nickel metal hydride batteries).

### 1 Turn the power off.

Disconnect all cables from the CD-2e.

### 2 Turn the CD-2e upside down and remove the battery cover.

\* When turning the CD-2e upside down, place stacks of newspapers or magazines to support the four corners (or two sides) so that stress is not placed on the buttons or knobs, possibly damaging them. Also, handle the CD-2e with care, and avoid dropping it.

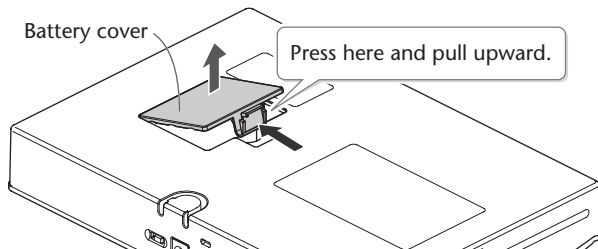

### 3 Install six AA alkaline batteries.

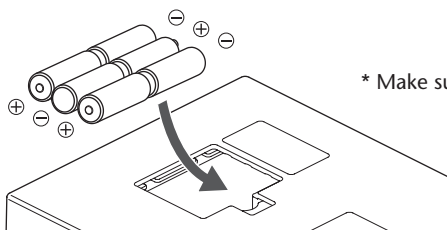

\* Make sure that the “+” and “-” are oriented correctly.

### 4 Close the battery cover and turn the CD-2e right side up.

### 5 On the CD-2e's rear panel, set the [POWER] switch to the “ON” position.

When the power is turned on, the screen will light.

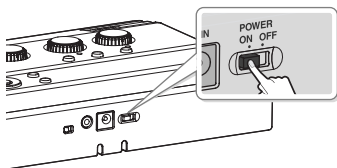

## Turning the power off

- 1 On the CD-2e's rear panel, set the [POWER] switch to the "OFF" position.

### Remaining battery indicator

If you're operating the CD-2e on batteries, the battery indicator will be shown on the screen.

If you continue use the CD-2e when the batteries are low, the display will indicate "Battery Low," and eventually the power will turn off.

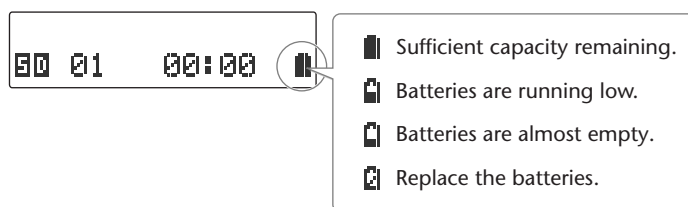

\* The remaining battery indicator is only an approximation.

### Battery life

Continuous use	Approximately 6 hours
----------------	-----------------------

- \* The battery life given here is only an approximation. It will vary depending on the frequency and conditions of use.

#### Note

You must turn off the power before performing the following operations.

- Switching from operation with the dedicated AC adaptor to battery operation
- Switching from battery operation to operation with the dedicated AC adaptor

#### Important

- If you want to use batteries, disconnect the dedicated AC adaptor. The batteries will not be used as the power supply if the dedicated AC adaptor is connected.
- Don't mix new batteries with partially-used batteries, and don't mix batteries of differing types.
- If you won't be using the CD-2e for an extended period of time, remove the batteries to prevent possible leaking damage.

# Preparing an SD Memory Card

Here's how to prepare an SD memory card for recording. For details on recommended SD memory cards, refer to "Recommended SD Memory Card" (Page 122).

## Inserting an SD Memory Card

- 1 Insert the SD memory card into the SD card slot on the CD-2e's side panel.

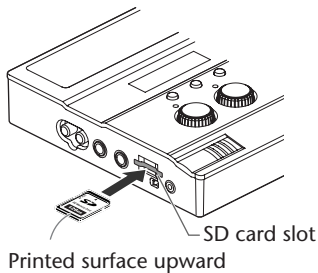

With the printed surface of the SD memory card facing upward, insert the card until it clicks into position.

- \* Make sure that the SD memory card is oriented correctly. Forcing it in the wrong way may damage the CD-2e or the SD memory card.

Displayed screen	Status of the SD memory card
<p>Audio source</p>	Nothing has been recorded yet.
<p>Total number of tracks      Total playback time</p>	A song has been recorded. * If the SD memory card has already been recorded, the total number of songs and the total playback time will be displayed when the SD memory card information is loaded.
<p>Unknown Format Format?</p>	This SD memory card cannot be used by the CD-2e in its current state. * If this message is shown, you'll need to format the card before using it with the CD-2e. For details, refer to the section on the following page entitled "If the screen indicates 'Not CD-2e Format'."



### About the protect switch

SD memory cards have a protect switch.

If the protect switch is in the "LOCK" position, you won't be able to write to the card, and the songs on the card will be protected.

If a protected SD memory card is inserted in the CD-2e, you won't be able to record on that card. Nor will you be able to edit or delete songs, or format the card.

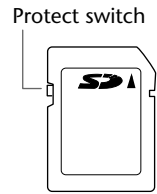

### If the screen indicates "Unknown Format"

In some cases when you insert an unused SD memory card that you purchased at a consumer electronic retailer, or an SD memory card that has been used with a computer or digital camera, the screen may indicate "Unknown Format. Format?"

In order to use this SD memory card with the CD-2e, you'll need to format the card. Proceed as follows to format the card.

#### Note

- While formatting is in progress, you must never turn off the power or remove the SD memory card.
- When you format an SD memory card, any data that was on that card will be erased. Data that's been lost in this way cannot be recovered. Please make sure that you really want to format the card.

#### 1 To begin formatting, press the [ENTER] button.

```
Unknown Format
Format?
```

#### 2 If you're sure you want to proceed, press the [ENTER] button.

(If you decide to cancel, press the [EXIT] button.)

```
You'll Lose Data
Really Sure?
```

The screen will indicate "Processing...", and the card will be formatted. When formatting is completed, you're returned to the audio source screen.

## Removing an SD Memory Card

 **Note**

Do not remove the SD memory card while the CD-2e is powered up. Doing so may damage the data stored on the SD memory card.

- 1 Turn the power off** (☞ Page 21, 23).
- 2 Gently press the SD memory card inward, and then release your finger.**  
When the memory card pops part of the way out, pull it all the way out.

# Preparing a CD

Here's how to prepare a CD-R/RW disc for recording or a music CD for playback. For recommended manufacturers of CD-R/RW discs, refer to "Recommended CD-R/RW Disc Manufacturers" (Page 123).

## Inserting a CD

### Note

Do not use CDs that have a CD label or sticker affixed to them. You may be unable to remove the CD, or it may cause the CD-2e to malfunction.

- 1** Insert the CD into the CD slot located on the side of the CD-2e. Insert the CD until it's pulled in automatically.

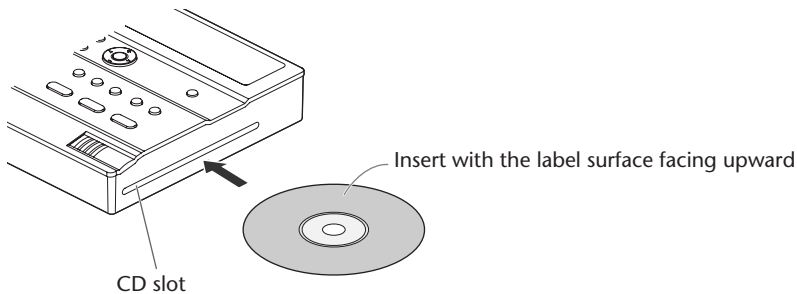

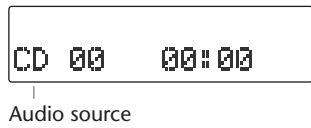
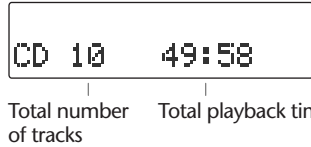
Screen display	CD status
 <p>CD 00 00:00 Audio source</p>	Nothing has been recorded yet.
 <p>CD 10 49:58 Total number of tracks   Total playback time</p>	Songs have been recorded (or written). * In the case of an already-recorded (or written) CD-R/RW disc or music CD, the total number of songs and the total playback time will be displayed once the CD information has been read.

## Removing a CD

### 1 Press the [EJECT(▲)] button.

After the CD has been ejected, pull it all the way out.

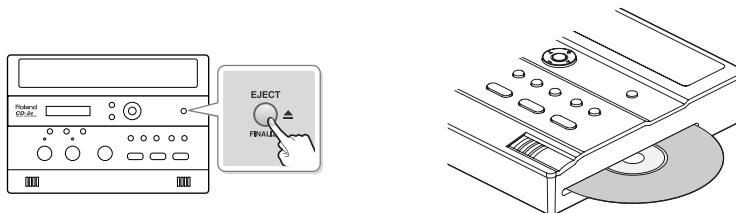

### If the screen shows “Finalize Are You Sure?”

Finalize  
Are You Sure?

If the CD-R/RW disc has not been finalized, a message will ask “Finalize Are You Sure?” If you don’t want to finalize the disc for playing on other CD players, press the [EXIT] button and remove the disc after it’s been ejected.

For details on finalizing, refer to “Making a CD-R/RW Disc for Playback on Another CD Player (Finalize)” (Page 83).

Finalize	Response
Yes	<b>Press the [ENTER] button.</b> The CD-RW disc will be finalized and then ejected.
No	<b>Press the [EXIT] button.</b> The CD-R/RW disc will be ejected.

### If you are unable to eject the disc

If pressing the [EJECT(▲)] button does not eject the disc, you can use the emergency eject hole to forcibly eject the CD.

\* Before using the emergency eject hole to eject the CD, you must turn off the power of the CD-2e.

#### 1 Turn off the power. (☞ Page 21)

#### 2 Insert a thin wire (such as a straightened paper clip) into the emergency eject hole.

Insert and remove the wire repeatedly until the CD comes out.

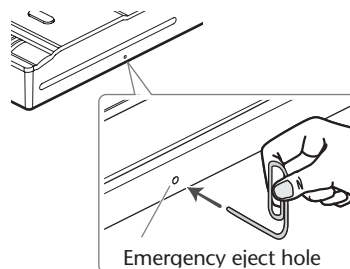

# Preparing the Remote Control

## Installing Batteries in the Remote Control

Install a coin-type lithium battery (included) in the remote control.

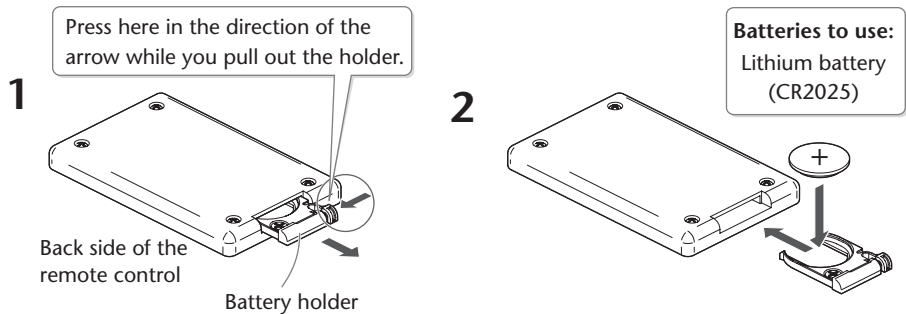

- \* Use only the specified type (model no.CR2025) of lithium battery. Be sure to insert it as directed to ensure correct polarity.



- 1 Pull out the battery holder.**
- 2 Insert a lithium battery (CR2025) as shown in the illustration.**
- 3 Replace the battery holder.**  
Push it inward until it clicks into place.

## Using the Remote Control

Point the remote control toward the CD-2e's sensor, and operate it within the specified operating range.

When the remote sensor detects a remote control operation, the [ENTER] button will blink.

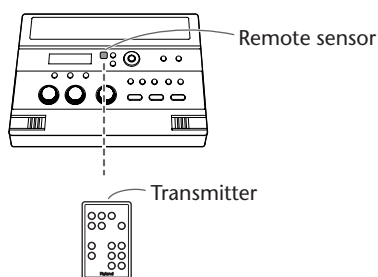

### Remote control operating range

Distance: 5 meters  
Angle: 45 degrees or less

- \* Even if the remote control is within range, it may not work if there is an obstruction between it and the remote sensor, or if the angle is excessive.
- \* The battery life will depend on the conditions of use. When the battery runs down, the operating angle will become narrower. Replace the battery if this occurs.
- \* If you won't be using the remote control for an extended period of time, remove the battery.
- \* If a spotlight or other strong light is directed at the remote sensor, it will be less responsive.

### Disabling remote control operation

If you want to prevent inadvertent operation of the remote control, you can disable remote operation.

- 1 Press the [MENU] button to access the menu screen, and choose "Remote Control."



- ① Press the [MENU] button to access the menu screen.
- ② Use the [ < ] [ > ] buttons to choose "Remote Control."
- ③ Press the [ENTER] button to confirm your choice.

- 2 Use the [+] [-] buttons to turn the remote control operation on/off.



Value	Explanation
Off	Remote operation will be disabled (off).
On (factory setting)	Remote operation will be enabled (on).

- 3 Press the [EXIT] button twice.  
You're returned to the audio source screen.

# Menu Operations

When you press the [MENU] button, the menu screen will appear. In the menu screen you can make settings for recording/playback, and settings for the CD-2e itself.

You can't access the menu screen during recording-standby mode or recording. Also, there are some settings that cannot be made while the CD-2e is running on batteries or is playing back.

For details on each setting, refer to "List of Settings" on the following page.

## 1 Press the [MENU] button to access the menu screen.

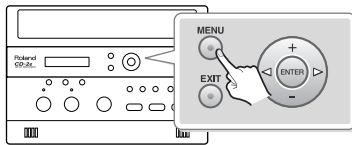

## 2 Use the [ < ] [ > ] buttons to choose the item you wish to set.

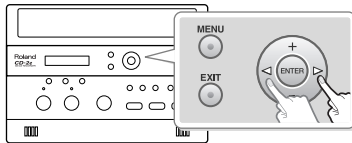

## 3 Press the [ENTER] button to confirm your choice.

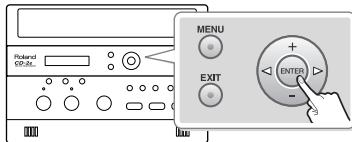

\* You can use the [+] [-] buttons to switch the display between categories.



## 4 Use the [+] [-] buttons to change the value.

\* Some items, such as SD memory card editing, do not have a value.

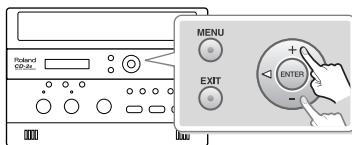

## 5 Press the [EXIT] button twice.

Pressing the [EXIT] button once will take you back to the menu screen.

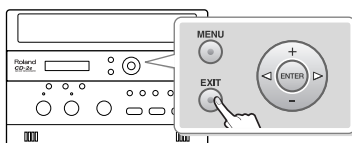

## List of Settings

- \* The default value (factory setting) is printed in bold characters.
- \* The ✓ symbol in the “Battery” or “Playback” column indicates a setting that can be made while the CD-2e is running on batteries or playing back.

Category	Setting (details)	Values	Battery	Playback	Reference page
RECORDING	<b>Auto Rec Start</b> (Automatically initiates recording when audio input is detected.)	<b>Off</b> , -48dB, -36dB, -24dB, -12dB, -6dB	✓	✓	Page 52
	<b>Auto Marker</b> (Automatically adds a song number while recording.)	<b>Off</b> , Level, Time	✓	✓	Page 55 Page 56
	<b>Auto Marker Lvl</b> (Specifies the audio level that will be considered to be silence when automatically adding song numbers during recording.)	<b>-60dB</b> , -54dB, -48dB, -42dB, -36dB, -30dB, -24dB	✓	✓	Page 55
	<b>Auto Marker Time</b> (Specifies the time interval at which song numbers will automatically be added during recording.)	<b>2min</b> –15min	✓	✓	Page 56
	<b>Count-in (Beat)</b> (Inserts a count-in at the beginning of recording.)	<b>Off</b> , 1–16	✓	✓	Page 58
PLAYBACK	<b>Key</b> (Changes the key at which the song plays.)	-6- <b>0</b> +5	✓	✓	Page 62
	<b>Pitch</b> (Adjusts the pitch at which the song plays.)	-100- <b>0</b> +100	✓	✓	Page 63
	<b>Speed</b> (Makes the playback speed slower/faster.)	50- <b>100</b> -125	✓	✓	Page 67
	<b>Repeat</b> (Repeatedly plays one song or all songs.)	<b>Off</b> , 1 Track, All Tracks	✓	✓	Page 65
	<b>Center Cancel</b> (Eliminates the center of the stereo sound image.)	<b>Off</b> , On	✓	✓	Page 64
	<b>Resume</b> (Remembers the location at which the song was stopped, and resumes playback from that point the next time.)	<b>Off</b> , On	✓	✓	Page 61
SD CARD	<b>Erase One?</b> (Deletes the selected song.)	—	✓		Page 70
	<b>SD Erase All?</b> (Deletes all songs.)	—	✓		Page 71
	<b>Move?</b> (Moves the song.)	—	✓		Page 87
	<b>Trim In?</b> (Deletes silence from the beginning of the song.)	—	✓		Page 72
	<b>Trim Out?</b> (Deletes silence from the end of the song.)	—	✓		Page 74
	<b>Divide?</b> (Divides the song in two.)	—	✓		Page 88
	<b>Combine?</b> (Joins two songs into a single song.)	—	✓		Page 90
	<b>Normalize?</b> (Maximizes the volume of the entire song.)	—	✓		Page 91
	<b>Overdub CD→SD?</b> (Layers a performance or vocal onto a CD song.)	—			Page 46



Category	Setting (details)	Values	Battery	Playback	Reference page
SD CARD	<b>Overdub SD→SD?</b> (Records another performance or vocal onto a song you recorded on an SD memory card.)	—	✓		Page 49
	<b>Format?</b> (Formats the SD memory card.)	—	✓		Page 104
	<b>Card Info</b> (Displays information about the SD memory card.)	—	✓		Page 93
CD-R/RW	<b>Erase Last?</b> (Deletes the last song from the CD-RW disc.)	—			Page 76
	<b>CD Erase All?</b> (Deletes all songs from the CD-RW disc.)	—			Page 77
	<b>Unfinalize?</b> (Removes finalization from the CD-RW disc.)	—			Page 78
	<b>Make Backup?</b> (Backs up an original music CD.)	—			Page 84
	<b>Write (SD→CD)?</b> (Creates a CD from the selected songs of the SD memory card.)	—			Page 79
	<b>Disc Info</b> (Displays information about the CD-R/RW disc.)	—			Page 94
METRONOME	<b>Sound</b> (Specifies the metronome sound.)	Off, <b>Bell</b> , Click, Voice	✓	✓	Page 98
	<b>Tempo</b> (Specifies the metronome tempo.)	0–4–7, ♩, ♪, ♫	✓	✓	Page 98
	<b>Beat</b> (Specifies the timing of the metronome's accented beats.)	20–120–250	✓	✓	Page 99
TUNER	<b>Tuner/Tone?</b> (Activates the tuner or sounds a tuning reference tone.)	"Pitch" 435–440–445	✓		Page 101
		"Tone" A3–A4–A5	✓		Page 102
Audio	<b>LINE OUT Select</b> (Specifies the audio source that will be output from the LINE OUT jack.)	<b>Mix</b> , MIC, LINE, SD/CD	✓		Page 109
	<b>Limiter</b> (Automatically adjusts the input level during recording so that loud sounds will not cause distortion.)	Off, <b>On</b>	✓		Page 57
	<b>EXT MIC Sens</b> (Adjusts the sensitivity of the external mic.)	Low, <b>High</b>	✓		Page 41
	<b>INT MIC Balance</b> (Adjusts the left/right volume balance of the internal mics.)	L50–C–R50	✓		Page 105
	<b>INT MIC Exchange</b> (Exchanges the left and right channels of the internal mics.)	<b>Off</b> , On	✓		Page 106
DISPLAY	<b>Contrast</b> (Adjusts the visibility of the characters in the screen.)	1–5–8	✓	✓	Page 95
	<b>Backlight Timer</b> (Specifies the time until the screen will be dimmed.)	<b>Off</b> , 2 sec, 5 sec, 10 sec, 20 sec	✓	✓	Page 96
SYSTEM	<b>Remote Control</b> (Enabled/disables remote control operation.)	Off, <b>On</b>	✓	✓	Page 30
	<b>Factory Reset?</b> (Returns the menu settings to their factory-set state.)	—	✓		Page 103
	<b>Language ( ゲンゴ )</b> (Selects the screen display language.)	<b>EN English</b> , JP ニホンゴ ES Español, DE Deutsch FR Français, IT Italiano	✓		Page 97

# About Easy Guide

Easy Guide is a convenient function that lets you operate the CD-2e simply by following the on-screen instructions without having to open the owner's manual.

## 1 Press the [EASY GUIDE] button.

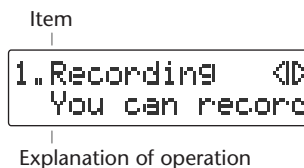
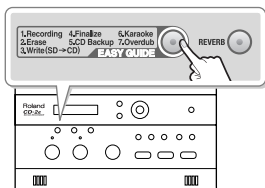

## 2 Use the [ < ] [ > ] buttons to select the item for which you want to see an operation guide.

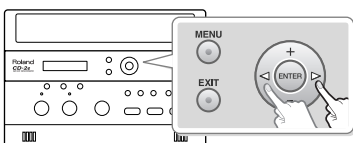

Easy Guide is available for the following seven operations.

Item	Explanation
1. Recording	Record a vocal or instrumental performance to either an SD memory card or a CD-R/RW disc.
2. Erase	Erase a track on either an SD memory card or a CD-RW disc.
3. Write (SD→CD)	Create a music CD by writing tracks from an SD memory card to a CD-R/RW disc.
4. Finalize	Make a CD-R/RW disc playable in a conventional CD player.
5. CD Backup	Make a backup of your original music CD.
6. Karaoke	While playing back a music CD you can add your own vocal, and record the combined result on an SD memory card.
7. Overdub	While playing back a previously recorded performance from an SD memory card, you can layer (or overdub) another vocal or instrumental performance and record the combined result to a new track.

## 3 Press the [ENTER] button to confirm your choice.

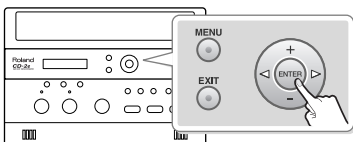

## 4 Operate the CD-2e as directed by the screen.

If you change your mind during a procedure, press the [EXIT] button.

For details on items that need to be set in the screens appearing in Easy Guide, refer to "Setting Items in Easy Guide" (Page 119).

# Before You Start Recording

## Minimum Recording Time for One Track

Each track on a music CD must be at least four seconds long. Since the CD-2e creates music CDs from the songs you record, it does not allow you to record a track that's less than four seconds long.

Pressing [■ (Stop)] or [▶/|| (Pause)] will not stop recording if less than four seconds have passed since you began recording. Moreover, you cannot assign a track number (Page 54) in such cases.

## In Case Your Performance is Not Recordable

Further recording is not possible once you've reached the maximum recordable time or the maximum number of songs that can be recorded.

- If there is no more recordable time, the message "SD Card Full" or "CD Disc Full" will appear.
- If the maximum number of tracks have already been recorded, the message "SD Track Full" or "CD Track Full" will appear.

This message goes away when you press the [ENTER] button.

If you're using an SD memory card or a CD-RW disc, you can erase unwanted songs (Page 70, 76) and then continue recording.

## When Recording on an SD memory card

### Recording Modes and Maximum Recording Times

Capacity	Maximum recording time (approx.)
64 MB	5 minutes
128 MB	11 minutes
256 MB	23 minutes
512 MB	46 minutes
1 GB	93 minutes
2 GB	190 minutes
4 GB	373 minutes
8 GB	763 minutes

\* The maximum times given above are approximate. The actual time may be slightly less depending on how tracks have been edited.

\* You can view the remaining time in the display.  Page 92, "Viewing the Remaining Recording/Playback Time"

### Recording Time for One Track (One Song)

The maximum length of one track is 74 minutes.

If a recording exceeds 74 minutes, a new track division will automatically be created.

### The Number of Recording Tracks

A maximum of 99 tracks can be recorded on one SD memory card.

## When Recording on a CD-R/RW disc

**You must use the dedicated AC adaptor when recording on a CD-R/RW disc.**

### Maximum Recording Times

Capacity	Maximum recording time
650 MB	approximately 74 minutes
700 MB	approximately 80 minutes

\* The maximum times given above are approximate. The actual time may be slightly less depending on the number of tracks that are recorded.

\* You can view the remaining time in the display.  Page 92, "Viewing the Remaining Recording/Playback Time"

### Types of Discs that You Can Record

CD-R discs	<ul style="list-style-type: none"><li>• Blank CD-R discs</li><li>• Partially recorded (not yet finalized) CD-R discs</li></ul>
CD-RW discs	<ul style="list-style-type: none"><li>• Blank CD-RW discs</li><li>• Partially recorded (not yet finalized) CD-RW discs</li></ul>

\* "Blank disc" refers to an "empty" disc on which nothing has been recorded or stored.

### The Number of Recording Tracks

A maximum of 99 tracks can be recorded on one CD-R/RW disc.

### Recorded Songs

When you record on a CD-R/RW disc, a blank space of two seconds will automatically be added at the end of each track (song).

### Finalization

"Finalization" is a process that can be applied to a CD-R/RW disc so that it will be playable by a conventional CD player. Once a CD-R disc or CD-RW disc has been finalized, it can be played back as a music CD in a CD player that supports CD-R or CD-RW playback.

For more information, refer to "Making a CD-R/RW Disc for Playback on Another CD Player (Finalize)" (Page 83).

\* No further songs can be recorded on a CD-R/RW disc that has been finalized.

If you're using a CD-RW disc, you can remove the finalization and add additional material.  Page 78, "Removing Finalization"

# Recording Acoustic Instruments or Vocals

## Recording with the Internal Mics

The internal mics are stereo mics. Sound picked up by the mic on the left side of the CD-2e is recorded on the left channel (L), while sound from the mic on the right side is recorded on the right channel (R).

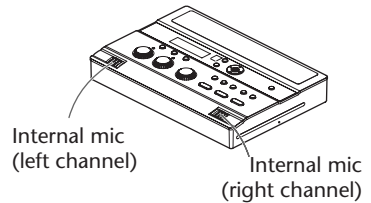

### If you're recording to an SD memory card

- 1 Turn on the power. (☞ Page 21, 22)
- 2 Insert the SD memory card. (☞ Page 24)
- 3 Set the audio source to "SD."  
Press the [SD CARD] button so it's lit.

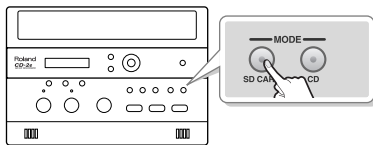

### If you're recording to a CD-R/RW disc

- 1 Turn on the power. (☞ Page 21)
- 2 Insert the CD. (☞ Page 27)
- 3 Set the audio source to "CD."  
Press the [CD] button so it's lit.

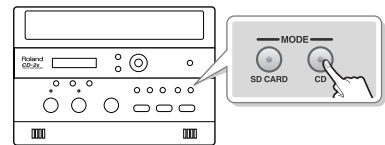

- 4 If you want to listen to the recorded audio while you record, connect headphones to the PHONES jack located on the side of the CD-2e.  
The sound received by the internal mics will not be heard from the internal speakers. You'll need to use headphones if you want to monitor the sound being recorded.

\* Use the [VOLUME] knob to adjust the headphone volume.

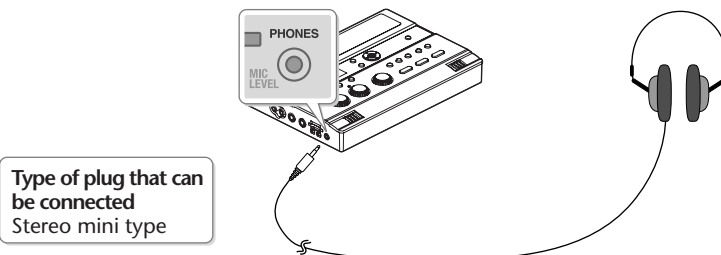

- 5 On the CD-2e's side panel, set the [MIC SELECT] switch to the "INT" (internal mic) position.

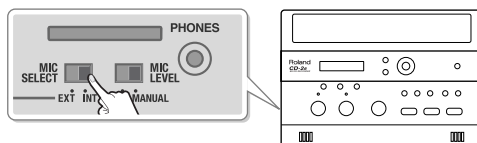

## 6 Adjust the input level of the internal mics.

① On the CD-2e's left side, set the [MIC LEVEL] switch to its "MANUAL" position.

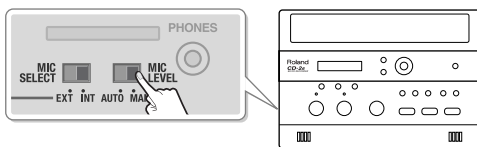

② Turn the [MIC] knob to adjust the input level of the internal mics.

Adjust the loudness of the sound you're recording. Since you're not using the line input, turn the [LINE] knob all the way to the left (off).

While producing the sound that you'll actually be recording, turn the [MIC] knob to adjust the input level.

Adjust the level so that the peak indicator located above the [MIC] knob lights briefly at the loudest moments of the performance or vocal you'll be recording.

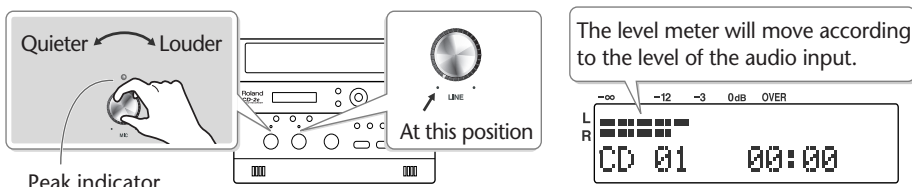

### The input level and the recorded result

- **If the input level is high** There is a limit on the level that the CD-2e is able to record. The peak indicator will light to indicate that the audio input has exceeded this limit (i.e., the input is too loud). If you record even though the peak indicator is lit, the recorded audio will be distorted.
- **If the input level is too low** The recorded audio will not be distorted, but the playback will not be as loud as it should be.

## 7 Press the [● (Record)] button to enter recording-standby mode.

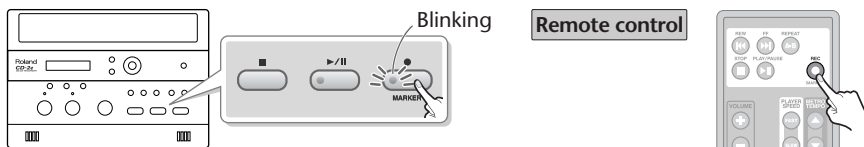

## 8 Press the [▶/II (Play)] button to begin recording.

Start your performance.

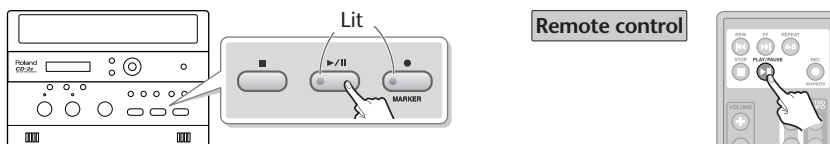

## 9 Press the [■ (Stop)] button to stop recording.

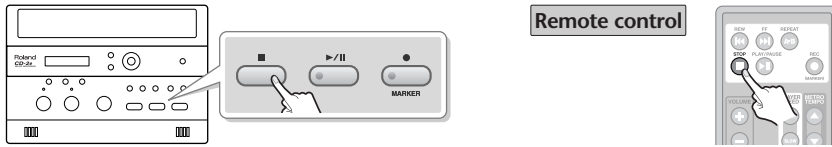

The recorded song will be added to the end of the SD memory card or CD-R/RW disc. If you want to listen to the song you recorded, press the [▶/II (Play)] button immediately after you stop recording.

### Important

- Since the CD-2e is equipped with highly-sensitive mics, undesired sounds such as the operating noise of the CD-R/RW drive or the sound of buttons being pressed may be recorded inadvertently. If you notice such problems, you can try lowering the input level of the internal mics.  
If you're recording to an SD memory card, no CD-R/RW drive operating noise will be recorded.
- Depending on where the CD-2e is positioned in relation to the sound source, the recorded sound may not be evenly distributed between the left and right speakers. In such cases, you can adjust the left/right volume balance of the internal mics and record your performance again. For details, refer to "Adjusting the Left/Right Volume Balance of the Internal Mics" (Page 105).
- When turning the [MIC] knob, you may hear a faint noise when the input level changes, but this is not a malfunction.
- If you've finished recording a CD-R/RW disc and would like to play that disc on another CD player, you'll need to execute the "Finalize" operation. You can finalize the CD-R/RW disc when ejecting it. For details, refer to "Making a CD-R/RW Disc for Playback on Another CD Player (Finalize)" (Page 83).

### Adjusting the Input Level Automatically (Auto Level Function)

The Auto Level function can adjust the input level automatically during recording in response to the loudness of the audio signal. Auto Level is particularly suitable for recordings that are mainly of human voices, such as a conference or lecture.

To use the Auto Level function, make the following settings in Step 6-① on Page 37. In this case, the input level will be adjusted automatically, so you won't need to perform Step 6-②.

**In Step 6, set the [MIC LEVEL] switch located on the CD-2e's side panel to its "AUTO" (automatic) position.**

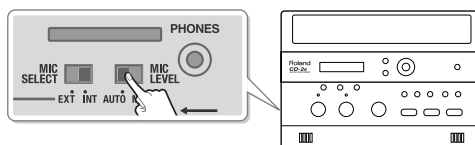

Switch setting	Explanation
MANUAL	Record at the input level determined by the [MIC] knob.
AUTO	Turn on the Auto Level function. The input level will be adjusted automatically. The input level will not change even if you turn the [MIC] knob.

## Connecting an External Mic for Recording

You can connect a dynamic mic for recording. Dynamic mics are highly durable, and are suitable for recording instruments or vocals. They also have the advantage of not requiring a power supply.

\* Condenser mics are not supported.



### If you're recording to an SD memory card

- 1 Turn on the power. (☞ Page 21, 22)
- 2 Insert the SD memory card. (☞ Page 24)
- 3 Set the audio source to "SD." Press the [SD CARD] button so it's lit.

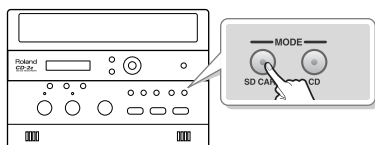

### If you're recording to a CD-R/RW disc

- 1 Turn on the power. (☞ Page 21)
- 2 Insert the CD. (☞ Page 27)
- 3 Set the audio source to "CD." Press the [CD] button so it's lit.

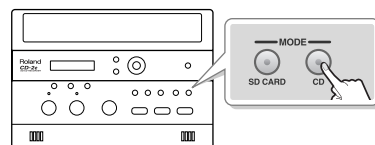

- 4 Connect your mic to the EXT MIC jack located on the CD-2e's side panel.

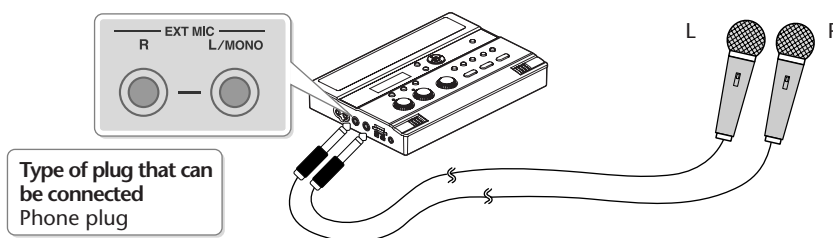

When connecting one mic (monaural)	When connecting two mics (stereo)
Connect the mic to the L/MONO jack. * If you connect it to the R jack, only the right channel (R) will be recorded.	The sound from the mic connected to the L/MONO jack will be recorded on the left channel (L), and the sound from the mic connected to the R jack will be recorded on the right channel (R).

- 5 On the CD-2e's side panel, set the [MIC SELECT] switch to its "EXT" (external mic) position.

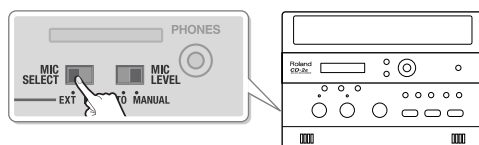

Checking / Preparations  
 Recording  
 Listening  
 Deleting  
 Creating a CD  
 Editing an SD  
 Information / Display  
 Convenient Functions  
 Advanced Uses  
 Appendices

## 6 Adjust the input level of the external mic.

- ① On the CD-2e's left side, set the [MIC LEVEL] switch to its "MANUAL" position.

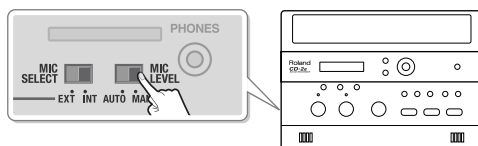

- ② Turn the [MIC] knob to adjust the input level of the external mics.

Adjust the loudness of the sound you're recording. Since you're not using the line input, turn the [LINE] knob all the way to the left (off).

While producing the sound that you will actually be recording, turn the [MIC] knob to adjust the input level.

Adjust the level so that the peak indicator located above the [MIC] knob lights briefly at the loudest moments of the performance or vocal you'll be recording.

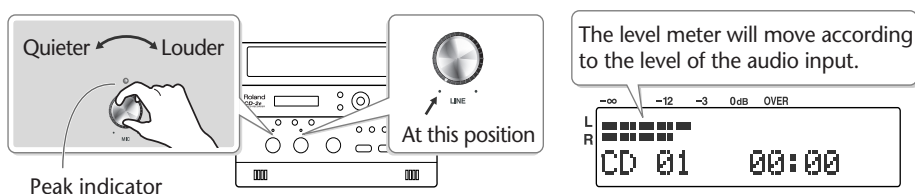

- \* If sound from the speakers enters the mic, you won't be able to adjust the level correctly. While adjusting the level, either turn the [VOLUME] knob all the way down or set the [SPEAKER] switch located on the side of the CD-2e to its "OFF" position, so no sound will be produced. Use headphones if you want to monitor the sound that's being recorded.

If the sound from the microphone distorted even though you've turned the [MIC] knob down, you can decrease the external mic sensitivity. At the factory settings, the external mic sensitivity is set to "High." If the level meter does not move sufficiently, change this setting to "Low." For details, refer to the text box "Selecting the external mic sensitivity" on Page 41.

## 7 Press the [● (Record)] button to enter recording-standby mode.

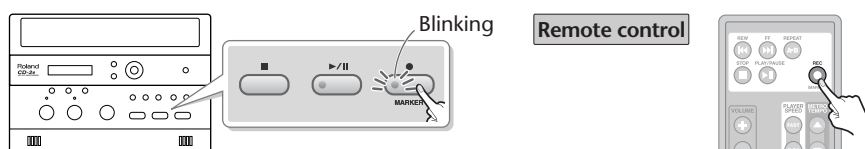

## 8 Press the [▶/|| (Play)] button to begin recording.

Start your performance.

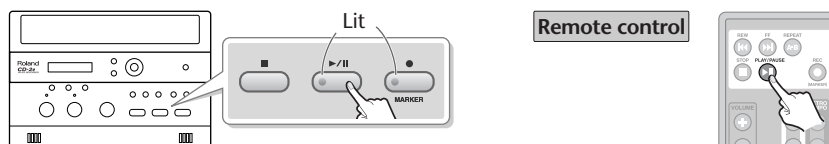



## 9 Press the [■ (Stop)] button to stop recording.

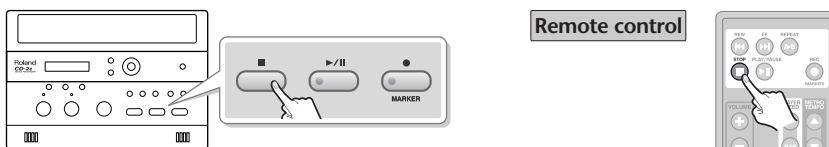

The recorded song will be added to the end of the SD memory card or CD-R/RW disc. If you want to listen to the song you recorded, press the [▶/II (Play)] button immediately after you stop recording.

### Important

- Sound will not be produced from the speakers while in recording-standby mode or while recording. If you want to listen to the sound that's being recorded, you'll need to use headphones. (Refer to Step 4 on Page 36.)
- If you hear acoustic feedback (a squealing sound) while using the mic, try changing the direction of the mic, moving it away from the speakers, or lowering the volume.
- When turning the [MIC] knob, you may hear a faint noise when the input level changes, but this is not a malfunction.
- If you've finished recording a CD-R/RW disc and would like to play that disc on another CD player, you'll need to execute the "Finalize" operation. You can finalize the CD-R/RW disc when ejecting it. For details, refer to "Making a CD-R/RW Disc for Playback on Another CD Player (Finalize)" (Page 83).

### Selecting the external mic sensitivity

You can set the sensitivity as appropriate for the external mic you're using.

#### 1 Press the [MENU] button to access the menu screen, and choose "EXT MIC Sens."



- ① Press the [MENU] button to access the menu screen.
- ② Use the [◀][▶] buttons to choose "EXT MIC Sens."
- ③ Press the [ENTER] button to confirm your choice.

#### 2 Use the [+] [-] buttons to change the external mic sensitivity setting.



Value	Explanation
Low	Lowers the sensitivity of the external mic. If the movement of the level meter does not decrease when you adjust the input level, select the "Low" setting.
High (factory setting)	Raises the sensitivity of the external mic. If the movement of the level meter does not increase when you adjust the input level, select the "High" setting.

#### 3 Press the [EXIT] button twice.

You're returned to the audio source screen.

# Recording an Electronic Instrument

Here's how to connect an electronic instrument such as a digital piano or keyboard, and record your performance.

## If you're recording to an SD memory card

- 1 Turn on the power. (☞ Page 21, 22)
- 2 Insert the SD memory card. (☞ Page 24)
- 3 Set the audio source to "SD."  
Press the [SD CARD] button so it's lit.

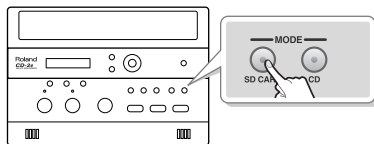

## If you're recording to a CD-R/RW disc

- 1 Turn on the power. (☞ Page 21)
- 2 Insert the CD. (☞ Page 27)
- 3 Set the audio source to "CD."  
Press the [CD] button so it's lit.

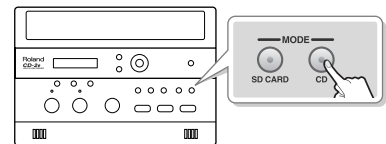

- 4 Connect the CD-2e's LINE IN jacks to your electronic instrument (digital piano, keyboard, etc.).

Use audio cables to connect the CD-2e's LINE IN jacks to the output jacks of your electronic musical instrument.

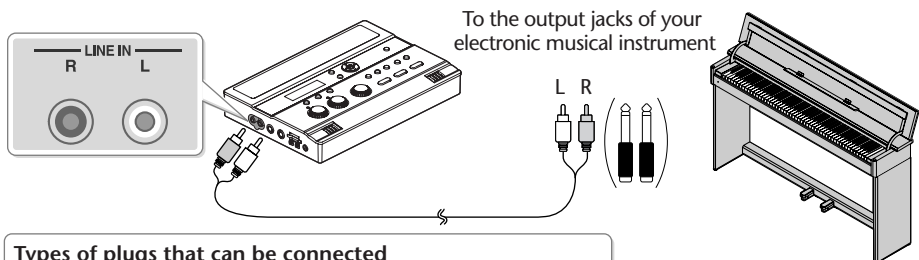

### Types of plugs that can be connected

CD-2e: RCA phono type

Electronic musical instrument: RCA phono type or phone type

\* Refer to the owner's manual of your electronic musical instrument for the appropriate type of plug to use.

- 5 Turn the [LINE] knob to adjust the input level at the LINE IN jacks.

Adjust the loudness of the sound you're recording. Since you're not using the mic input, set the [MIC LEVEL] switch to the "MANUAL" position, and then turn the [MIC] knob all the way to the left (off).

While producing the sound that you will actually be recording, turn the [LINE] knob to adjust the input level.

Adjust the level so that the peak indicator located above the [LINE] knob lights briefly at the loudest moments of the performance you'll be recording.

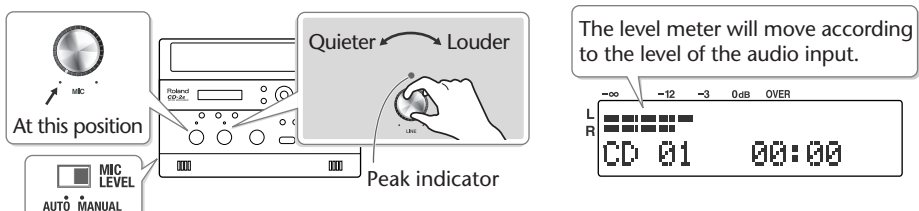

## 6 Press the [● (Record)] button to enter recording-standby mode.

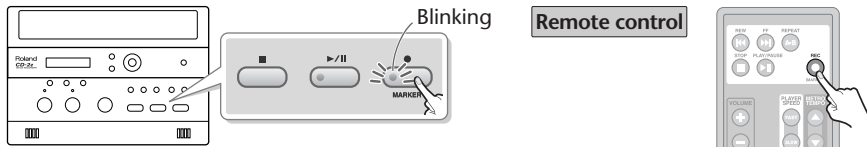

## 7 Press the [▶/II (Play)] button to begin recording.

Start your performance.

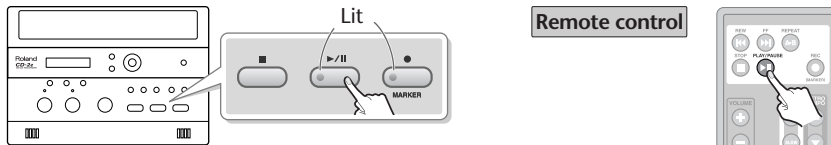

## 8 Press the [■ (Stop)] button to stop recording.



The recorded song will be added to the end of the SD memory card or CD-R/RW disc. If you want to listen to the song you recorded, press the [▶/II (Play)] button immediately after you stop recording.

### Important

- Sound will not be produced from the speakers while in recording-standby mode or while recording. If you want to listen to the sound that's being recorded, you'll need to use headphones. (Refer to Step 4 on Page 36.)
- When turning the [LINE] knob, you may hear a faint noise when the input level changes, but this is not a malfunction.
- If you've finished recording a CD-R/RW disc and would like to play that disc on another CD player, you'll need to execute the "Finalize" operation. You can finalize the CD-R/RW disc when ejecting it. For details, refer to "Making a CD-R/RW Disc for Playback on Another CD Player (Finalize)" (Page 83).
- If you want to record your performance on an electronic piano together with your voice, make connections as shown in this illustration so that the sound from the mic will also be output from the speakers of the electronic piano.

With this setup, set LINE OUT Select to "MIC" to prevent a feedback loop from occurring between the CD-2e and the electronic piano. For details, refer to "Selecting the Audio Source that's Sent from the LINE OUT Jack" (Page 109).

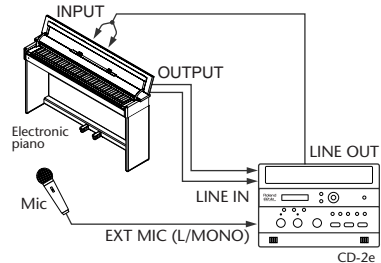

# Recording a Cassette or MD

Here's how to record the sound from a cassette or MD.

## If you're recording to an SD memory card

- 1 Turn on the power. (☞ Page 21, 22)
- 2 Insert the SD memory card. (☞ Page 24)
- 3 Set the audio source to "SD."  
Press the [SD CARD] button so it's lit.

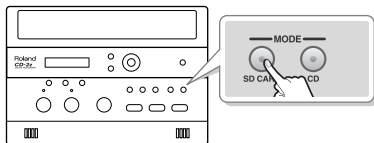

## If you're recording to a CD-R/RW disc

- 1 Turn on the power. (☞ Page 21)
- 2 Insert the CD. (☞ Page 27)
- 3 Set the audio source to "CD."  
Press the [CD] button so it's lit.

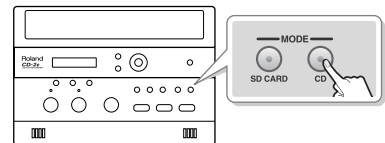

- 4 Connect your audio device (e.g., cassette deck) to the CD-2e's LINE IN jacks.

Use audio cables to connect the CD-2e's LINE IN jacks to the output jacks of your audio device (e.g., cassette deck).

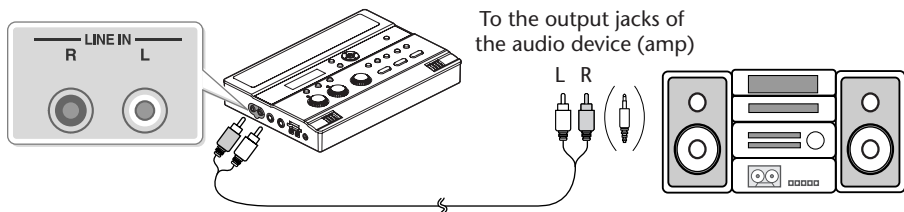

### Types of plugs that can be connected

CD-2e: RCA phono type  
Audio device: RCA phono type  
\* Portable players use a stereo mini type jack

- 5 Turn the [LINE] knob to adjust the input level at the LINE IN jacks.

Adjust the loudness of the sound you're recording. Since you're not using the mic input, set the [MIC LEVEL] switch to the "MANUAL" position, and then turn the [MIC] knob all the way to the left (off).

While playing the song to be recorded, turn the [LINE] knob to adjust the input level. Adjust the level so that the peak indicator located above the [LINE] knob lights briefly during the loudest passages of the song that's being recorded.

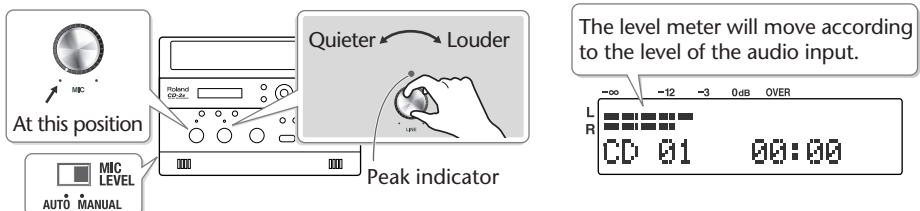

## 6 Press the [● (Record)] button to enter recording-standby mode.

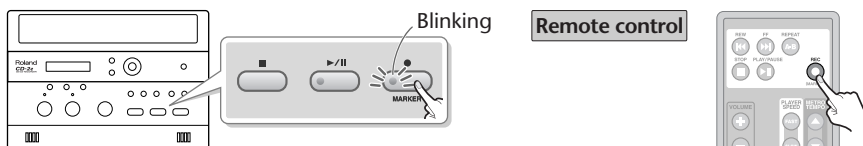

## 7 Press the [▶/II (Play)] button to begin recording.

Start your performance.

## 8 Play back your audio device (e.g., cassette deck).

The song being played will be recorded.

## 9 Press the [■ (Stop)] button to stop recording.

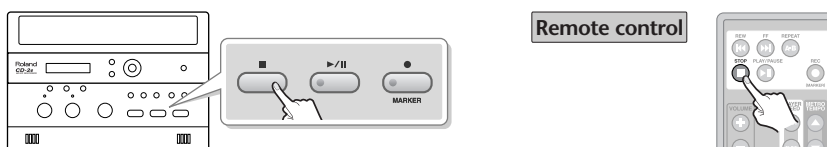

The recorded song will be added to the end of the SD memory card or CD-R/RW disc. If you want to listen to the song you recorded, press the [▶/II (Play)] button immediately after you stop recording.

### Important

- Sound will not be produced from the speakers while in recording-standby mode or while recording. If you want to listen to the sound that's being recorded, you'll need to use headphones. (Refer to Step 4 on Page 36.)
- When turning the [LINE] knob, you may hear a faint noise when the input level changes, but this is not a malfunction.
- If you've finished recording a CD-R/RW disc and would like to play that disc on another CD player, you'll need to execute the "Finalize" operation. You can finalize the CD-R/RW disc when ejecting it. For details, refer to "Making a CD-R/RW Disc for Playback on Another CD Player (Finalize)" (Page 83).

# Recording Karaoke

Here's how the sound from a karaoke CD and the sound of your voice from a mic can be recorded together to an SD memory card (i.e., overdubbing that adds your voice or performance to a song from CD).

The CD-2e provides a Center Cancel function, which lets you use a commercial CD as a simple karaoke source. For details, refer to "Enjoying Simple Karaoke (Center Cancel)" (Page 64).

\* In order to perform this operation, you'll need the included, dedicated AC adaptor.

- 1 Turn on the power.** (☞ Page 21)
- 2 Insert the SD memory card for recording.** (☞ Page 24)
- 3 Prepare your external mic.**

- ① Connect your mic to the EXT MIC L/MONO jack on the CD-2e's side panel.**

\* If you connect your mic to the R jack, it will only be recorded on the right channel (R).

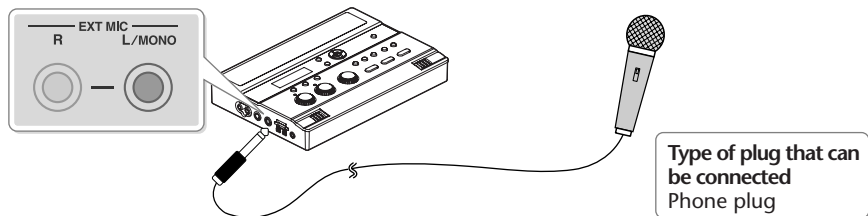

- ② On the CD-2e's side panel, set the [MIC SELECT] switch to its "EXT" (external mic) position.**

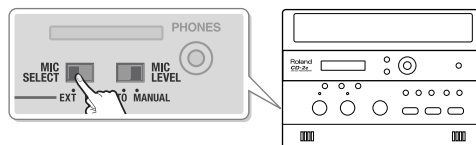

- ③ On the CD-2e's left side, set the [MIC LEVEL] switch to its "MANUAL" position.**

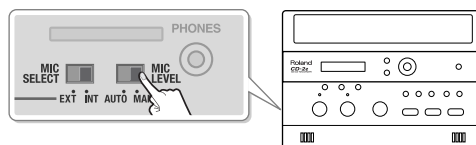

## 4 Prepare your karaoke CD.

- ① Insert the karaoke CD** (☞ Page 27).
- ② Press the [CD] button so it's lit, and set the audio source to "CD."**

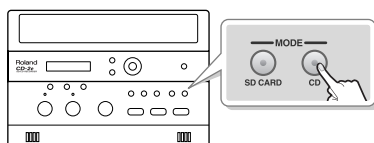

- ③ Use the [◀◀] [▶▶] buttons to select the song that you want to record.**

## 5 Adjust the CD's playback level and the mic's input level.

Adjust the levels to obtain the desired volume balance between the CD and the mic.

- \* If sound from the speakers enters the mic, you won't be able to adjust the level correctly. While adjusting the level, either turn the [VOLUME] knob all the way down or set the [SPEAKER] switch located on the side of the CD-2e to the "OFF" position, so no sound will be produced. Use headphones if you want to monitor the sound that's being recorded.

- ① Press the [▶/|| (Play)] button to play back the CD.
- ② Press the [◀] or [▶] button to access the SD/CD Level setting screen.
- ③ Use the [+] [-] buttons to adjust the CD's playback level ("SD/CD Level").



\* If you don't press the [+] [-] buttons for five seconds, you'll automatically be returned to the audio source display.

Value (units: dB)	Explanation
-6-0 (factory setting)-6	Decreasing this value will lower the playback level. Increasing it will raise the playback level. "0" is the CD's original playback level.

- ④ Turn the [MIC] knob to adjust the input level of the external mics.

As a guideline, adjust the level so that the level meter's "-3 dB" indicator lights briefly when the CD audio and mic audio are heard together.

Adjust the loudness of the sound you're recording. Since you're not using the line input, turn the [LINE] knob all the way to the left (off).

When you've finished adjusting the level, press the [■ (Stop)] button to stop the CD playback.

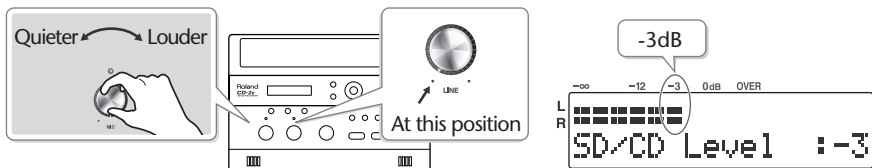

## 6 Press the [MENU] button to access the menu screen, and choose "Oberdub CD→SD?"

- ① Press the [MENU] button to access the menu screen.
- ② Use the [◀] [▶] buttons to choose "Oberdub CD→SD?"

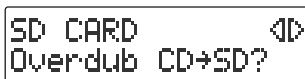

- ③ Press the [ENTER] button to confirm your choice.

The CD-2e will be in recording-standby mode.

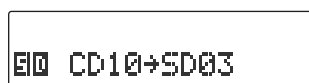

CD song number to record      Recording-destination song number on the SD memory card

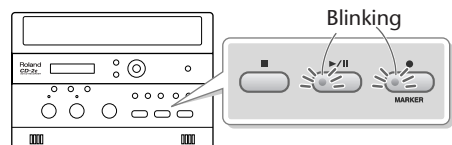

## 7 Press the [▶/II (Play)] button to begin recording.

The music CD track you selected in Step 4- ③ begins playing, and recording on the SD memory card begins simultaneously. Record your vocal or instrumental performance.

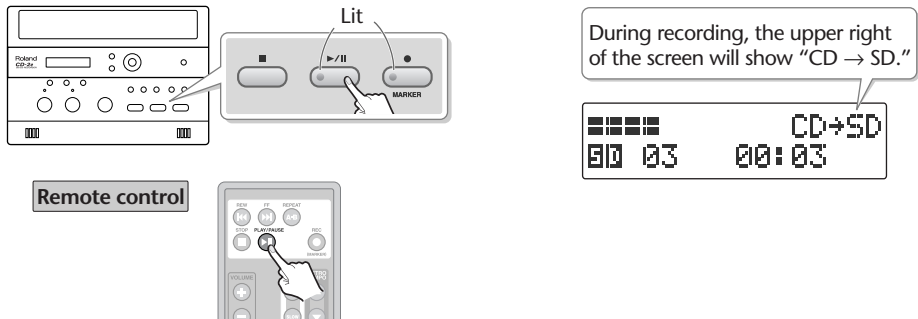

When CD playback stops at the end of the song, recording will also end automatically. If you want to stop recording in the middle of the song, press the [■ (Stop)] button. The recorded song will be added to the end of the SD memory card. If you want to listen to the song you recorded, press the [▶/II (Play)] button immediately after you stop recording.

### Important

- "Key" (Page 62), "Pitch" (Page 63), and "Speed" (Page 67) settings will automatically revert to the values of the original song only during recording. When recording ends, these settings will return to the values you specified.
- Sound will not be produced from the speakers while in recording-standby mode or while recording. If you want to listen to the sound that's being recorded, you'll need to use headphones. (Refer to Step 4 on Page 36.)
- If you hear acoustic feedback (a squealing sound) while using the mic, try changing the direction of the mic, moving it away from the speakers, or lowering the volume.
- When turning the [MIC] knob, you may hear a faint noise when the input level changes, but this is not a malfunction.
- The playback level ("SD/CD Level") setting is common to the CD and the SD memory card. When you turn off the power, this setting will return to "0."



# Layering Your Performance onto an SD Memory Card Song and Recording It

Here's how you can play back a recorded performance from an SD memory card, add a vocal or a performance of another instrument, and re-record the combined result onto the SD memory card (overdubbing a vocal or other performance onto an SD memory card song). Since you can perform and overdub each part separately, this allows you to record your piano performance, and then sing along to add a vocal to your performance.

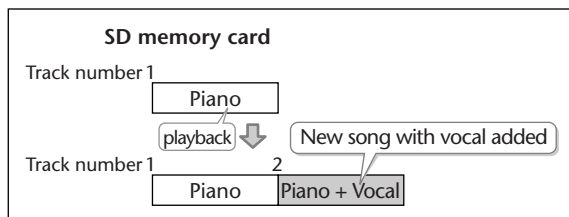

All audio received via the external mics, internal mics, and line input can be overdubbed with a song on the SD memory card. Make settings as appropriate for your instruments and your setup.

- 1 Turn on the power. (☞ Page 21, 22)
- 2 Insert the SD memory card. (☞ Page 24)
- 3 Make preparations for recording.

If you're using the internal mics	☞ Make preparations as described in Steps 5 on Page 36.
If you're using an external mic	☞ Make preparations as described in Steps 4–5 on Page 39.
If you're using the line inputs	☞ Make preparations as described in Steps 4 on Page 42.

## 4 Prepare your SD memory card.

- ① Press the [SD CARD] button so it's lit, and set the audio source to "SD."

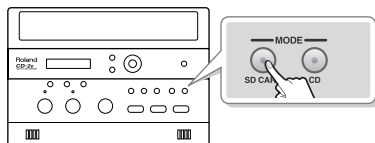

- ② Use the [ ⏪ ] [ ⏩ ] buttons to select the song that you want to record.

## 5 Adjust the playback level of the SD memory card and the input level of the audio input.

Adjust each level to obtain the appropriate volume balance between the SD memory card audio and the audio input.

- ① Press the [▶/II (Play)] button to play back the SD memory card.
- ② Press the [◀] or [▶] button to access the SD/CD Level setting screen.
- ③ Use the [+] [-] buttons to adjust the SD memory card's playback level ("SD/CD Level").



\* If you don't press the [+] [-] buttons for five seconds, you'll automatically be returned to the audio source display.

Value (units: dB)	Explanation
-6-0 (factory setting)-6	Decreasing this value will lower the playback level. Increasing it will raise the playback level. "0" is the playback level of the original song.

- ④ Adjust the input level of the audio input.

Adjust the levels so that the level meter briefly reaches the "-3 dB" indicator when the audio from the SD memory card and the audio from the external source are being input simultaneously.

When you've finished adjusting the level, press the [■ (Stop)] button to stop the SD memory card playback.

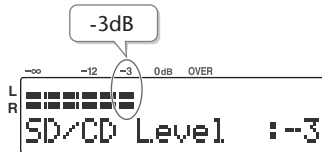

### Using the internal mics

🔊 Make adjustments as described in Step 6 of Page 37.

### Using the external mics

🔊 Make adjustments as described in Step 6 of Page 40.

### Using the line inputs

🔊 Make adjustments as described in Step 5 of Page 42.

## 6 Press the [MENU] button to access the menu screen, and choose "Oberdub SD→SD?"

- ① Press the [MENU] button to access the menu screen.
- ② Use the [◀] [▶] buttons to choose "Oberdub SD→SD?"

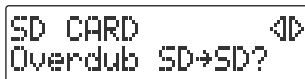

- ③ Press the [ENTER] button to confirm your choice.

The CD-2e will be in recording-standby mode.

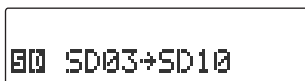

Song to record      Recording-destination song number

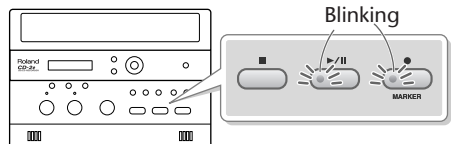

## 7 Press the [ ▶/II (Play)] button to begin recording.

When the SD memory card song you selected in Step 4- ② begins playing, recording on the SD memory card will begin simultaneously. Start your performance.

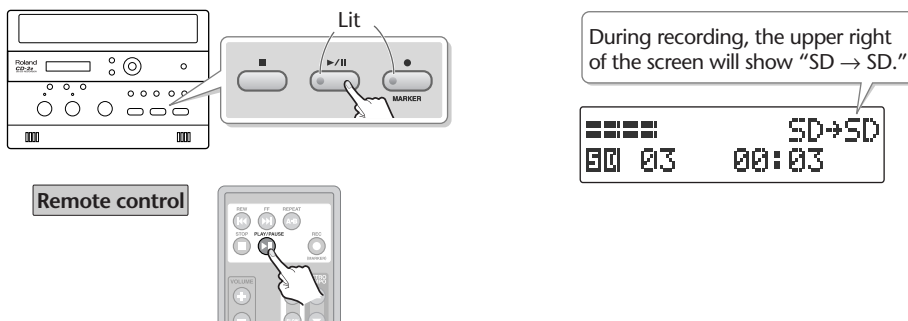

## 8 Press the [ ■ (Stop)] button to stop recording.

The recorded song will be added to the end of the SD memory card. If you want to listen to the song you recorded, press the [ ▶/II (Play)] button immediately after you stop recording.

### Important

- “Key” (Page 62), “Pitch” (Page 63), and “Speed” (Page 67) settings will automatically revert to the values of the original song only during recording. When recording ends, these settings will return to the values you specified.
- Sound will not be produced from the speakers while in recording-standby mode or while recording. If you want to listen to the sound that’s being recorded, you’ll need to use headphones. (Refer to Step 4 on Page 36.)
- The playback level (“SD/CD Level”) setting is common to the CD and the SD memory card. When you turn off the power, this setting will return to “0.”
- If you decide to stop recording midway through the track, press the [ ■ (Stop)] button.

# Convenient Functions for Recording

## Automatically Starting Recording When Audio is Detected

When the CD-2e is in recording-standby mode and it detects audio input that exceeds the specified level, recording will start automatically.

- 1 Press the [MENU] button to access the menu screen, and choose "Auto Rec Start."



- ① Press the [MENU] button to access the menu screen.
- ② Use the [ < ] [ > ] buttons to choose "Auto Rec Start."
- ③ Press the [ENTER] button to confirm your choice.

- 2 Use the [+] [-] buttons to change the value that specifies the level at which recording will begin automatically.

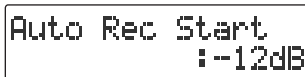

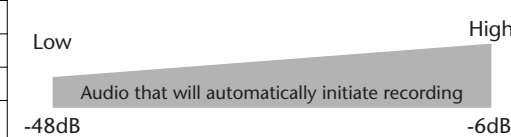
Value	Explanation
Off (factory setting)	Recording will start when you press [ ▶/II (Play)] during recording standby.
-48dB	
-36dB	
-24dB	
-12dB	
-6dB	

When you're setting the input level, it's a good idea to check how the level meter moves at the beginning of the performance. To avoid losing any of the beginning of your performance, set this trigger level lower than the level at which the performance begins.

- 3 Press the [EXIT] button twice.  
You're returned to the audio source screen.  
This completes preparations for automatically initiating recording.

When you make settings for automatic recording, the procedure for starting to record will be as follows.

## 1 Press the [ ● (Record)] button.

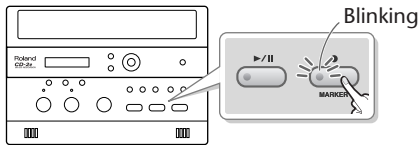

## 2 Press the [ ▶/II (Play)] button.

The CD-2e will be in recording-standby mode.



## 3 Start performing.

When the CD-2e detects audio, recording will begin automatically.

- \* In order to avoid losing any audio at the beginning of the performance, recording will actually begin up to 0.5 seconds earlier than the point at which audio exceeding the specified level is detected.

## 4 Press the [ ■ (Stop)] button to stop recording.

The recorded song will be added to the SD memory card or to the end of the CD-R/RW disc.

### Important

- Recording will pause when you press the [ ▶/II (Play)] button. When audio is detected once again, recording will begin automatically. The point at which recording is resumed will be the next song.
- Automatic recording will not work if you've specified a count-in (Page 58).

## Assigning Song Numbers While Recording (Marker)

During recording, you can assign a song number so that the subsequent material will be recorded as the next song. You can assign song numbers in the following three ways.

Assigning song numbers	Reference page
① Press the [ ● (Record)] button to assign the song number	This page
② Automatically assign song numbers at fixed intervals	Page 55
③ Assign track numbers when silence is detected	Page 56

### Important

- You can't delete a track number once it's been assigned.
- You can assign track numbers only during recording.
- You can't assign a new track number less than four seconds after assigning the previous track number.
- You can assign up to 98 track numbers (99 tracks).
- When you assign a track number to a CD-R/RW disc, two seconds of silence is automatically inserted in front of the new track number.

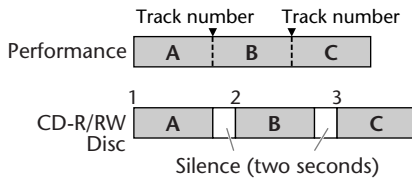

- If you're assigning song numbers to a CD-R/RW disc, you can't assign a new song number while the message at right is displayed.

CD REC MARKER  
Processing... ⌂

\* Recording will continue even while this message is displayed.

### Press the [ ● (Record)] Button to Assign a Song Number

This lets you assign a song number whenever you like during recording. If several songs are being recorded in succession, such as during a live performance, you can assign a track number to each song while you continue recording.

#### 1 At the point where you want to assign a track number during recording, press the [ ● (REC)] button.

The track number is incremented, and the material that follows will be recorded on the new track.

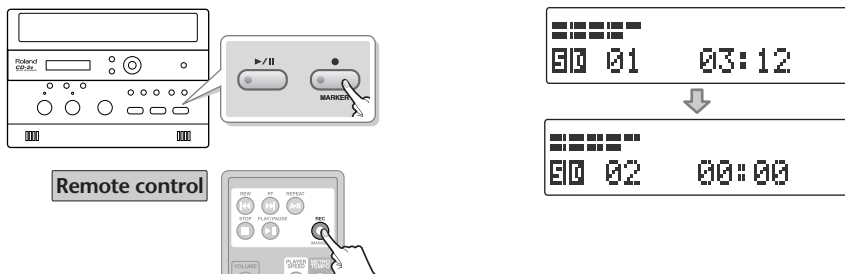

## Automatically Assigning a Song Number at Fixed Intervals

When making a long recording such as a lecture, you can automatically assign track numbers at fixed time intervals to divide the recording into tracks. If you've assigned track numbers, it will be easier to find a desired location in the recording.

### 1 Specify how the song numbers will be assigned.

```
RECORDING  <>
Auto Marker
```

```
Auto Marker
: Time
```

- ① Press the [MENU] button to access the menu screen.
- ② Use the [ < ] [ > ] buttons to choose "Auto Marker."
- ③ Press the [ENTER] button to confirm your choice.
- ④ Use the [+] [-] buttons to specify the desired "Time."

Value	Explanation
Off	Song numbers will not be assigned automatically.
Time	Song numbers will be automatically assigned at the specified interval (units of minutes) during recording.
Level	Song numbers will be automatically assigned when silence is detected during recording.

### 2 Specify the time interval at which song numbers will be assigned.

```
RECORDING  <>
Auto Marker Time
```

```
Auto Marker Time
: 5min
```

- ① Press the [EXIT] button to return to the menu screen.
- ② Use the [ < ] [ > ] buttons to choose "Auto Marker Time."
- ③ Press the [ENTER] button to confirm your choice.
- ④ Use the [+] [-] buttons to change the value to the interval of time at which you want to assign song numbers.

Value (units: Minutes)	Explanation
2 minutes (factory setting)–15 minutes	Specifies the time interval (minutes) at which song numbers will be assigned.

### 3 Press the [EXIT] button twice.

You're returned to the audio source screen.

Subsequently, when you begin recording, track numbers will automatically be assigned at every time interval you've specified in Step 2.

To defeat this setting, choose "Off" in Step 1.

## Assigning Track Numbers When Silence is Detected

If a period of silence lasting longer than one second is detected during recording, recording will automatically pause. Then, when audio exceeding the specified level is subsequently detected, a song number will be assigned and recording will automatically resume.

This function is convenient when you're recording songs from a cassette tape or a MD, since the songs will automatically be divided at regions of silence.

### 1 Specify how the song numbers will be assigned.

```
RECORDING  ◀▶
Auto Marker
```

```
Auto Marker
#Level
```

- ① Press the [MENU] button to access the menu screen.
- ② Use the [◀][▶] buttons to choose "Auto Marker."
- ③ Press the [ENTER] button to confirm your choice.
- ④ Use the [+] [-] buttons to specify the desired "Level."

Value	Explanation
Off	Song numbers will not be assigned automatically.
Time	Song numbers will be automatically assigned at the specified interval (units of minutes) during recording.
Level	Song numbers will be automatically assigned when silence is detected during recording.

### 2 Specify the audio level that will be considered to be silence.

```
RECORDING  ◀▶
Auto Marker Lvl
```

```
Auto Marker Lvl
#-30dB
```

- ① Press the [EXIT] button to return to the menu screen.
- ② Use the [◀][▶] buttons to choose "Auto Marker Lvl."
- ③ Press the [ENTER] button to confirm your choice.
- ④ Use the [+] [-] buttons to specify the audio level that will be considered to be silence.

Value	Explanation
-60dB (factory setting)	Audio below the specified level will be considered to be silence.  
-54dB	
-48dB	
-42dB	
-36dB	
-30dB	
-24dB	

### 3 Press the [EXIT] button twice.

You're returned to the audio source screen.

Now when you start recording, and a region of audio below the level specified in Step 2 continues for longer than one second, the next song number will be assigned automatically.

To defeat this setting, choose "Off" in Step 1.



## Preventing Loud Sounds from Distorting (Limiter)

This function automatically adjusts the input level so that the audio will not distort even when unexpectedly loud sounds are received while recording.

- 1 Press the [MENU] button to access the menu screen, and choose "Limiter."



- ① Press the [MENU] button to access the menu screen.
- ② Use the [ < ] [ > ] buttons to choose "Limiter."
- ③ Press the [ENTER] button to confirm your choice.

- 2 Use the [+] [-] buttons to turn the limiter on/off.



Value	Explanation
Off	The limiter is off.
On (factory setting)	The limiter is on.

- 3 Press the [EXIT] button twice.  
You're returned to the audio source screen.

## Inserting a Count before Recording Begins (Count-in)

You can sound a count before recording begins. Hearing a count can help you practice the timing or tempo of your performance before you actually start recording.

- 1 Press the [  (Metronome) ] button to turn on the metronome.

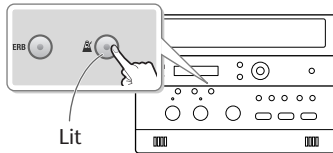

- 2 Specify the sound, tempo, and time signature of the count.

The sound, tempo, and time signature of the count will be the same as specified by the metronome settings. For details, refer to Steps 2–4 of “Sounding the Metronome” (Page 98).

- 3 Press the [MENU] button to access the menu screen, and choose “Count-in (Beat).”

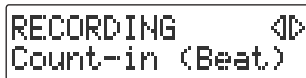

- ① Press the [MENU] button to access the menu screen.
- ② Use the [ < ] [ > ] buttons to choose “Count-in (Beat).”
- ③ Press the [ENTER] button to confirm your choice.

- 4 Use the [+] [-] buttons to adjust the value that specifies how many count notes will be sounded before recording begins.

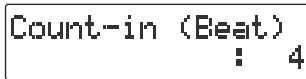

Value	Explanation
Off (factory setting)	No count-in will sound.
1–16	The specified number of count-in beats will sound.

- 5 Press the [EXIT] button twice.

You’re returned to the audio source screen.

If you've specified a count-in, the procedure for starting to record will be as follows.

## 1 Press the [● (Record)] button.

The CD-2e will be in recording-standby mode.

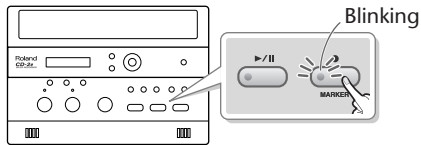

## 2 Press the [▶/II (Play)] button.

The specified number of counts will be sounded, and then recording will begin.

The count will not be played through the speakers. You'll need to use headphones to hear the count.



\* The metronome will continue sounding even after recording begins.

# Listening to a CD/ Listening to an SD Memory Card

\* In order to play a CD, you'll need to use the dedicated AC adaptor, which was included with the CD-2e.

## Listening to a CD

- 1 Turn on the power.
- 2 Insert the CD.
- 3 Set the audio source to "CD."  
Press the [CD] button so it's lit.

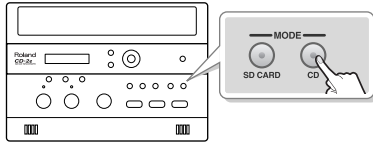

## Listening to an SD memory card

- 1 Turn on the power.
- 2 Insert the SD memory card.
- 3 Set the audio source to "SD."  
Press the [SD CARD] button so it's lit.

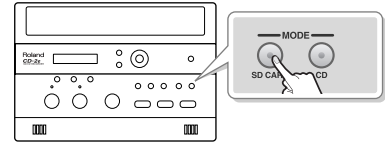

- 4 Press the [▶/II (Play)] button to start playback.

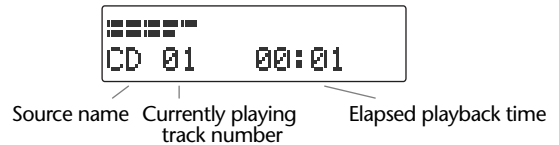
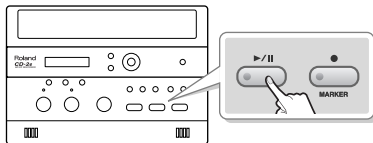

- 5 Turn the [VOLUME] knob to adjust the volume.

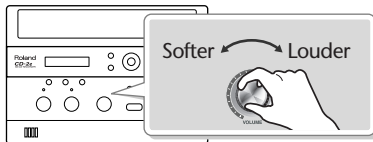

If you don't need the mic or line input, you should turn down the input level to the minimum position.

**Mic input** Set the [MIC LEVEL] switch to the "MANUAL" position, and turn the [MIC] knob all the way to the left (off).

**Line input** Turn the [LINE] knob all the way to the left (off).

To do this	Perform this action
Stop playback	Press the [■ (Stop)] button. If you press this button while stopped, you will return to the first track.
Pause playback	Press the [▶/II (Play)] button. Press it once again to resume playback from the point at which you paused.
Go to the beginning of a track (Skip)	Press the [◀◀] button. Each time you press this button, you go back by one track. If you press this button during playback, you will return to the beginning of the track that was playing. Press the [▶▶] button. Each time you press this button, you advance to the next track.
Skip between songs at high-speed	While stopped, press and hold the [◀◀] or [▶▶] button.
Rewind/ fast-forward (Search)	During playback, press and hold. [◀◀] button: Rewind. [▶▶] button: Fast-forward.
High-speed rewind/ fast-forward	While paused, press and hold the [◀◀] or [▶▶] button.

Remote operations .....

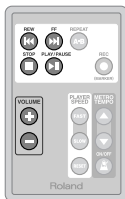

- Song cue, rewind/fast-forward
- Song stop/play (pause)

Adjusting the volume

- Higher volume.
- Lower volume.

**Note**

The [VOLUME] knob of the CD-2e itself does not move when you use the remote control to adjust the volume. This will mean that the position of the [VOLUME] knob may not match the actual volume.

**Continuing Playback from When You Stopped a Song (Resume Function)**

If you press the [ ■ (Stop)] button during playback, the CD-2e can remember the position at which you paused, and will resume playback from that location the next time you start playback. This is called the Resume function.

- 1** Press the [MENU] button to access the menu screen, and choose "Resume."



- ① Press the [MENU] button to access the menu screen.
- ② Use the [ < ] [ > ] buttons to choose "Resume."
- ③ Press the [ENTER] button to confirm your choice.

- 2** Use the [+] [-] buttons to turn the Resume function on/off.



Value	Explanation
Off (factory setting)	The Resume function will be off.
On	The Resume function will be on. The CD-2e will remember the position at which playback was stopped.

- 3** Press the [EXIT] button twice.  
You're returned to the audio source screen.

**Operation When Resume is On**

After pressing the [ ■ (Stop)] button to halt playback, you can press the [ ▶/|| (Play)] button to re-start playback from the location at which you stopped.

If after pressing the [ ■ (Stop)] button to stop playback, you then press the [ ■ (Stop)] button or eject the SD memory card or CD, the Resume function, which had remembered the location at which you stopped, will be cancelled.

# Convenient Functions for Playback

## Changing the Key of the Playback

This adjusts the key (pitch) of the playback sound in semitone steps. This can be useful in situations like the following.

- You want to practice flute along with an accompaniment CD that was created for alto sax.
- You want to sing along with a karaoke CD at a key that's easier for you to sing.

### 1 Press the [MENU] button to access the menu screen, and choose "Key."



- ① Press the [MENU] button to access the menu screen.
- ② Use the [ < ] [ > ] buttons to choose "Key."
- ③ Press the [ENTER] button to confirm your choice.

### 2 Use the [+] [-] buttons to adjust the value, changing the key.

If you press the [ > ] button, the value will return to "0."



Value	Explanation
-6-0 (factory setting)+5	Decreasing the value by one will lower the overall pitch of the song by a semitone. Increasing the value by one will raise the overall pitch of the song by a semitone. A setting of "0" is the original key of the song.

\* If you change the key setting during playback, the audio will be interrupted momentarily.

### 3 Press the [EXIT] button twice.

You're returned to the audio source screen.

#### The Key icon



The "K" icon is displayed if you've changed the key setting.

The "K" symbol will disappear if you set the "Key" to "0" in Step 2. When you turn off the power, the Key setting will return to "0."

## Making Fine Adjustments to the Playback Pitch (Pitch)

This adjusts the pitch of the playback sound in one-cent steps. One cent is 1/100th of a semitone.

Sometimes when you are practicing your instrument along with a CD, you may have difficulty because the CD playback is pitched slightly different than your instrument. In such cases, you can adjust the CD playback pitch to match your instrument.

When you're using an instrument that is not easily tuned, such as an acoustic piano, you can adjust the pitch of the CD so that it matches your instrument.

### 1 Press the [MENU] button to access the menu screen, and choose "Pitch."



- ① Press the [MENU] button to access the menu screen.
- ② Use the [ < ] [ > ] buttons to choose "Pitch."
- ③ Press the [ENTER] button to confirm your choice.

### 2 Use the [+] [-] button to adjust the Pitch setting.

If you press the [ > ] button, the value will return to "0."

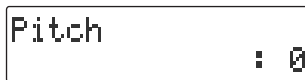

\* If you change the pitch setting during playback, the audio will be interrupted momentarily.

Value (units: Cents)	Explanation
-100-0 (factory setting)+100	Lowering the value will lower the overall pitch of the song. Raising the value will raise the overall pitch of the song. A setting of "0" is the original pitch of the song.

If you have a CD that was recorded at a reference pitch of A=440 Hz, and you want to play it back at a reference pitch of A=442 Hz, you would set Pitch to "+8."

Refer to the table at right.

Frequency of A4 after adjustment	Pitch setting
438Hz	-8 (cents)
439Hz	-4 (cents)
440Hz	0
441Hz	+4 (cents)
442Hz	+8 (cents)

### 3 Press the [EXIT] button twice.

You're returned to the audio source screen.

#### The Pitch icon

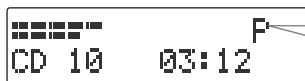

The "P" icon is displayed if you've changed the pitch setting.

The "P" symbol will disappear if you set the "Pitch" to "0" in Step 2. When you turn off the power, the Pitch setting will return to "0."

## Enjoying Simple Karaoke (Center Cancel)

This function cancels the portion of the sound that is heard in the center of its stereo image, such as the main vocal or lead guitar, making it less audible. This lets you use a commercially available CD as a simple karaoke source, giving you an easy way to enjoy karaoke or to practice singing or playing an instrument.

- 1 Press the [MENU] button to access the menu screen, and choose "Center Cancel."



- 1 Press the [MENU] button to access the menu screen.
- 2 Use the [ < ] [ > ] buttons to choose "Center Cancel."
- 3 Press the [ENTER] button to confirm your choice.

- 2 Use the [+] [-] buttons to turn Center Cancel on/off.



Value	Explanation
Off (factory setting)	Center Cancel will be off.
On	Center Cancel will be on. Sounds heard in the stereo center during playback will be eliminated.

- 3 Press the [EXIT] button twice.  
You're returned to the audio source screen.

### The Center Cancel icon



The "C" icon is displayed when Center Cancel is on.

If you turn "Center Cancel" off in Step 2, the "C" symbol will disappear. When you turn off the power, the Center Cancel setting will return to the "off" state.

#### Important

You may fail to obtain the desired effect if the song has deep reverb, or if the sounds you want to eliminate are not positioned in the center.



## Repeatedly Playing Tracks (1 Track/All Repeat)

You can have a favorite track (or all tracks) play back repeatedly.

- 1 Press the [MENU] button to access the menu screen, and choose "Repeat."



- 1 Press the [MENU] button to access the menu screen.
- 2 Use the [ < ] [ > ] buttons to choose "Repeat."
- 3 Press the [ENTER] button to confirm your choice.

- 2 Use the [+] [-] buttons to change the Repeat Playback setting.



Value	Explanation
Off (factory setting)	Repeat Playback will be off.
1 Track	One-track repeat. The currently playing track, or any track you play subsequently, will play back repeatedly.
All Tracks	All repeat. All tracks will play repeatedly. If you select this during playback, all tracks will play repeatedly, starting with the currently playing track.

- 3 Press the [EXIT] button twice.

You're returned to the audio source screen.

### The Repeat icons

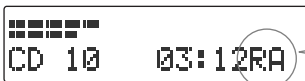

The following icon is displayed if you've specified Repeat Playback.

**R1**                      **RA**  
 (1 track repeat)              (All repeat)

The "R1" or RA symbol will disappear if you set the "Repeat" to "Off" in Step 2.

#### Important

The Repeat Playback setting will be turned "Off" if you operate the [REPEAT] button.

## A-B Repeat Playback

You can have a specified section play back repeatedly.

Repeatedly listening to a section of a song is convenient when you're practicing your instrument along with the song, or learning the song by ear.

- 1 During playback, press the [REPEAT] button at the point where you want Repeat Play to start.**

The starting point (A) of A-B Repeat playback is registered, and the Point A icon blinks.

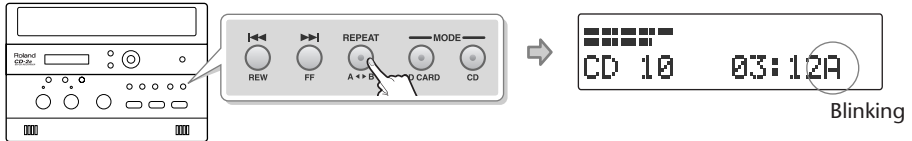

- 2 Press the [REPEAT] button once again at the point where you want A-B Repeat to end.**

The end point (B) of A-B Repeat playback is registered, and the A-B region will play back repeatedly.



- 3 To defeat A-B Repeat, press the [REPEAT] button while A-B Repeat playback is occurring.**

If you press the [■ (Stop)] button to stop playback, A-B Repeat playback will also be cancelled.

### Remote operations



Register the start/end points for A-B Repeat.

## Slowing Down or Speeding Up Playback

You can make the playback speed slower or faster. Changing the playback speed will not affect the pitch.

This is useful when you are learning a song by ear and want to hear it slowly, or if you want to quickly listen to a song that you recorded.

### 1 Press the [MENU] button to access the menu screen, and choose "Speed."



- ① Press the [MENU] button to access the menu screen.
- ② Use the [ < ] [ > ] buttons to choose "Speed."
- ③ Press the [ENTER] button to confirm your choice.

### 2 Use the [+] [-] buttons to adjust the playback speed.

If you press the [ > ] button, the value will return to "100."



\* If you change the speed setting during playback, the audio will be interrupted momentarily.

Value (units: %)	Explanation
50 (1/2 speed)–100 (factory setting)–125 (1.25x normal speed)	Decreasing this value will slow down the playback, and increasing it will speed up the playback. A setting of "100" is the original playback speed of the song.

### 3 Press the [EXIT] button twice.

You're returned to the audio source screen.

Remote operations .....



- Makes the playback speed faster.
- Makes the playback speed slower.
- Restores the original playback speed.

### The Speed icon

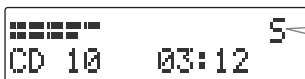

The "S" icon is displayed if you've changed the speed setting.

The "S" symbol will disappear if you set the "Speed" to "100" in Step 2. When you turn off the power, the Speed setting will return to "100."

#### Important

Slowing down the playback speed to an extreme extent may change the tonal character or cause the audio to not play back smoothly.

## Adding Reverberation (Reverb)

This function adds reverberation (reverb) to the audio played back from an SD memory card or CD, creating the impression that the performance is occurring in a concert hall or other real-world acoustic environment.

### 1 Use the [REVERB] button to select the depth of reverb.

Pressing the [REVERB] button cycles through the following settings.

Play back from the SD memory card or CD, and check the reverb depth.

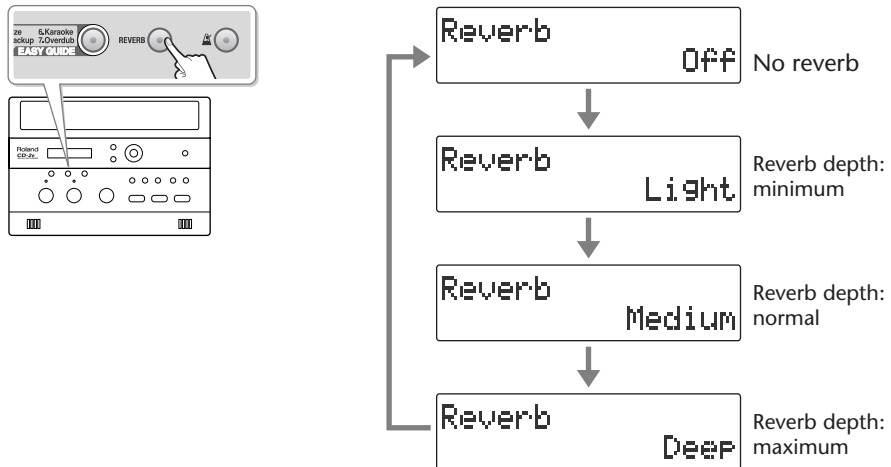

### 2 Press the [EXIT] button.

You're returned to the audio source screen.

- \* If you don't press the [REVERB] button for five seconds, you'll automatically be returned to the audio source display.

#### Important

- The [REVERB] button will light if reverb is being added.
- Reverb is not added to sound from an external input source such as the built-in mic or an external mic.

## Muting the Sound of the Speakers

If you don't want sound to be heard from the speakers, set the [SPEAKER] switch located on the rear of the CD-2e to its "OFF" position.

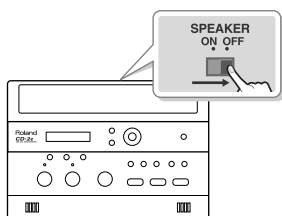

### Important

Even if the [SPEAKER] switch is in the "ON" position (so that sound is produced), sound will not be heard from the speakers during recording-standby mode or during recording. This is to prevent sound produced by the speakers from being picked up and recorded by the internal mic or an external mic.

# Deleting Songs from an SD Memory Card

## Deleting Songs Individually

Here's how to delete a single, selected song.

When you delete a song, subsequent songs will be moved forward, incrementing their song numbers.

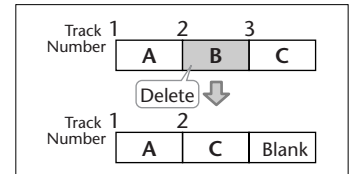

- 1** Insert the SD memory card that you want to edit, and press the [SD CARD] button.  
SD becomes the audio source.
- 2** Use the [◀◀] or [▶▶] button to select the track you want to erase.
- 3** Press the [MENU] button to access the menu screen, and choose "Erase One?"

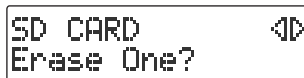

- ① Press the [MENU] button to access the menu screen.
- ② Use the [◀] [▶] buttons to choose "Erase One?"
- ③ Press the [ENTER] button to confirm your choice.

- 4** If you're sure you want to proceed, press the [ENTER] button.  
(If you decide to cancel, press the [EXIT] button.)

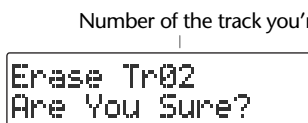

The display will show "Processing..." and the song will be deleted. When the deletion is completed, you're returned to the audio source screen.

### Note

Once you delete a song, you cannot recover the recorded content. Use this operation with care.

### Important

- If you select the song you want to delete in Step 2 and then press the [-] button, the message screen of Step 4 will appear immediately. This lets you skip the step of selecting the menu item.
- Deletion is not possible if the SD memory card's write protect switch (Page 25) is in the "LOCK" position.

## Erasing All Tracks

Here's how to delete all songs from the SD memory card.

- 1 Insert the SD memory card that you want to edit.
- 2 Press the [MENU] button to access the menu screen, and choose "SD Erase All?"



SD CARD  
SD Erase All? ◀▶

- ① Press the [MENU] button to access the menu screen.
- ② Use the [◀] [▶] buttons to choose "SD Erase All?"
- ③ Press the [ENTER] button to confirm your choice.

- 3 If you're sure you want to proceed, press the [ENTER] button.



SD Erase All  
Are You Sure?

- 4 If you're still sure you want to proceed, press the [ENTER] button.  
(If you decide to cancel, press the [EXIT] button.)



SD Erase All  
Really Sure?

The display will show "Processing," and all songs will be deleted. When the deletion is completed, you're returned to the audio source screen.

### Note

Once you delete a song, you cannot recover the recorded content. Use this operation with care.

### Important

Deletion is not possible if the SD memory card's write protect switch (Page 25) is in the "LOCK" position.

## Deleting an Unwanted Region at the Beginning of the Song (Trim In)

If you start recording slightly ahead of the beginning of the performance so as to avoid missing anything, there will be some unwanted silence at the beginning of the song. You can delete this unwanted silence so that you will hear sound as soon as the song starts playing.

- 1** Insert the SD memory card that you want to edit, and press the [SD CARD] button.

SD becomes the audio source.

- 2** Use the [◀◀] or [▶▶] button to select the track you want to edit.

- 3** Press the [MENU] button to access the menu screen, and choose "Trim In?"

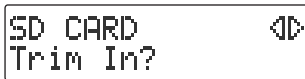

① Press the [MENU] button to access the menu screen.

② Use the [◀][▶] buttons to choose "Trim In?"

③ Press the [ENTER] button to confirm your choice.

- 4** Press the [▶/|| (Play)] button to play back the selected song.

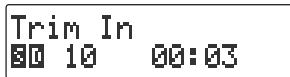

Number of the track you're editing

- 5** When you come to the point that you want to be the beginning of the song (the Start Point), press the [● (Record)] button.

Four seconds of sound preceding the Start Point will play repeatedly.

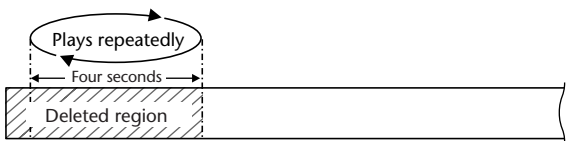

**Start Point**—this will be the beginning of the song after editing.

- 6** Use the [+] or [-] button to precisely adjust the Start Point.

Adjust the Start Point so that you no longer hear the beginning of the song.

Button	Explanation
[+] button	Moves the Start Point backward.
[-] button	Moves the Start Point forward.



**7** Press the [ENTER] button.

**8** If you're sure you want to proceed, press the [ENTER] button.

(If you decide to cancel, press the [EXIT] button.)

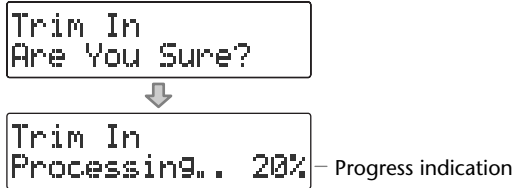

The display will show “Processing...”, and the unwanted beginning of the song will be deleted. When the deletion is completed, you're returned to the audio source screen.

#### Note

The deleted region cannot be recovered. Use this operation with caution.

#### Important

- You can't specify Start Point locations that would cause the edited song to be less than four seconds long.
- The Trim In editing process will take a certain amount of time. In general, the time will be approximately half the playback time of the song. For example, in order to edit a four-minute song, it will take approximately two minutes for the editing process to be completed.
- The Trim In editing operation requires free space equal to the size of the song you're editing. For example, if you're editing a five-minute song, you won't be able to execute this operation unless you have at least five minutes of recording time remaining.
- This operation cannot be performed if the SD memory card's write protect switch (Page 25) is in the “LOCK” position.

## Deleting an Unwanted Region at the End of the Song (Trim Out)

If you stop recording slightly after the end of the performance so as to avoid missing anything, there will be some unwanted silence at the end of the song. You can delete this unwanted silence so that the song contains only the performance itself.

- 1** Insert the SD memory card that you want to edit, and press the [SD CARD] button.

SD becomes the audio source.

- 2** Use the [◀◀] or [▶▶] button to select the track you want to edit.

- 3** Press the [MENU] button to access the menu screen, and choose "Trim Out?"

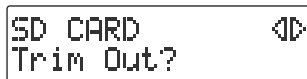

- 1** Press the [MENU] button to access the menu screen.

- 2** Use the [◀][▶] buttons to choose "Trim Out?"

- 3** Press the [ENTER] button to confirm your choice.

- 4** Press the [▶/|| (Play)] button to play back the selected song.

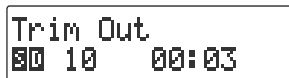

Number of the track you're editing

- 5** When you come to the point that you want to be the end of the song (the End Point), press the [● (Record)] button.

(If the song is long, you can fast-forward until you're near the desired End Point.)

Four seconds of sound following the End Point will play repeatedly.



End Point—this will be the end of the song after editing.

- 6** Use the [+] or [-] button to precisely adjust the End Point.

Adjust the End Point so that you no longer hear the end of the song.

Button	Explanation
[+] button	Moves the End Point backward.
[-] button	Moves the End Point forward.

**7** Press the [ENTER] button.

**8** If you're sure you want to proceed, press the [ENTER] button.

(If you decide to cancel, press the [EXIT] button.)

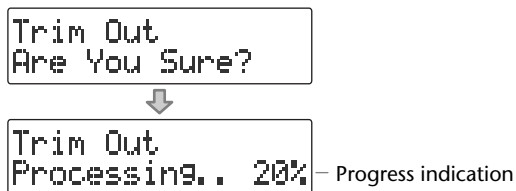

The display will show "Processing...", and the unwanted end of the song will be deleted. When the deletion is completed, you're returned to the audio source screen.

#### Note

The deleted region cannot be recovered. Use this operation with caution.

#### Important

- You can't specify End Point locations that would cause the edited song to be less than four seconds long.
- The Trim Out editing process will take a certain amount of time. In general, the time will be approximately half the playback time of the song. For example, in order to edit a four-minute song, it will take approximately two minutes for the editing process to be completed.
- The Trim Out editing operation requires free space equal to the size of the song you're editing. For example, if you're editing a five-minute song, you won't be able to execute this operation unless you have at least five minutes of recording time remaining.
- This operation cannot be performed if the SD memory card's write protect switch (Page 25) is in the "LOCK" position.

# Erasing Tracks from a CD-RW Disc

## Deleting One Song at a Time (Only the Last Song)

Here's how to erase the last track recorded on a CD-RW disc.

\* In order to perform this operation, you'll need the included, dedicated AC adaptor.

- 1 Insert the CD-RW disc that you want to edit.
- 2 Press the [MENU] button to access the menu screen, and choose "Erase Last?"



```
CD-R/RW  <=>
Erase Last?
```

- ① Press the [MENU] button to access the menu screen.
- ② Use the [ < ] [ > ] buttons to choose "Erase Last?"
- ③ Press the [ENTER] button to confirm your choice.

- 3 If you're sure you want to proceed, press the [ENTER] button.  
(If you decide to cancel, press the [EXIT] button.)



```
Erase Last
Are You Sure?
```



```
Erase Last
Processing... 1:12
```

Count-down (min:sec)

The display will show "Processing...", and the last song will be deleted.

During this process, a timer is displayed, counting down the time until the operation is completed.

### Note

Once you delete a song, you cannot recover the recorded content. Use this operation with care.

### Important

- You can't erase tracks from a CD-R disc.
- If you want to erase a track from a CD-RW disc that's been finalized (Page 83), you'll need to first remove finalization.  "Removing Finalization" (Page 78)
- If you press the [-] button after Step 1, the message screen of Step 3 will appear immediately. This lets you skip having to choose a menu item.



## Erasing All Tracks

Here's how to erase all tracks from the CD-RW disc.

- \* In order to perform this operation, you'll need the included, dedicated AC adaptor.

- 1 Insert the CD-RW disc that you want to edit.
- 2 Press the [MENU] button to access the menu screen, and choose "CD Erase All?"



- ① Press the [MENU] button to access the menu screen.
- ② Use the [ < ] [ > ] buttons to choose "CD Erase All?"
- ③ Press the [ENTER] button to confirm your choice.

- 3 If you're sure you want to proceed, press the [ENTER] button.



- 4 If you're still sure you want to proceed, press the [ENTER] button. (If you decide to cancel, press the [EXIT] button.)





Count-down (min:sec)

The display will show "Processing," and all songs will be deleted. During this process, a timer is displayed, counting down the time until the operation is completed. When the deletion is completed, you're returned to the audio source screen.

### Note

Once you delete a song, you cannot recover the recorded content. Use this operation with care.

### Important

- You can't erase tracks from a CD-R disc.
- If the CD-R/RW disc has been finalized (Page 83), finalization will automatically be removed when you erase all tracks.

## Removing Finalization

You can remove finalization from a CD-RW disc (Page 83) so that the disc can once again be used for recording. Removing finalization will not erase the recorded tracks.

\* In order to perform this operation, you'll need the included, dedicated AC adaptor.

**1** Insert the CD-RW disc that you want to edit, and press the [CD] button. CD becomes the audio source.

**2** Press the [MENU] button to access the menu screen, and choose "Unfinalize?"



- ① Press the [MENU] button to access the menu screen.
- ② Use the [ < ] [ > ] buttons to choose "Unfinalize?"
- ③ Press the [ENTER] button to confirm your choice.

**3** If you're sure you want to proceed, press the [ENTER] button. (If you decide to cancel, press the [EXIT] button.)



Count-down (min:sec)

The display will show "Processing...", and finalization will be removed from the disc.

During this process, a timer is displayed, counting down the time until the operation is completed.

When finalization has been removed, you're returned to the audio source screen.

### Important

You can't remove finalization from a CD-R disc.

# Selecting Songs from an SD Memory Card to Create a CD

Here's how selected songs from an SD memory card can be written to a CD-R/RW disc to create a music CD.

\* In order to perform this operation, you'll need the included, dedicated AC adaptor.

- 1 Insert the SD memory card that contains the songs you want to turn into a music CD.
- 2 Press the [MENU] button to access the menu screen, and choose "Write (SD→CD)?"



CD-R/RW  
Write(SD→CD)?

- ① Press the [MENU] button to access the menu screen.
- ② Use the [ < ] [ > ] buttons to choose "Write (SD→CD)?"
- ③ Press the [ENTER] button to confirm your choice.

- 3 When you see this screen, insert a blank or un-finalized CD-R/RW disc.



Write(SD→CD)  
Insert Disc

- 4 The CD-2e asks whether you want to write all of the songs.

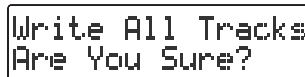

Write All Tracks  
Are You Sure?

\* This message won't appear if it's not possible for all of the songs on the SD memory card to be written to the CD-R/RW disc. (Proceed to Step 5.)

**If you want to write all songs**

- ① Press the [ENTER] button.

Proceed to **Step 7**.

**If you want to write selected songs**

- ① Press the [EXIT] button.

Proceed to **Step 5**.

- 5 Select the song that you want to write to the CD-R/RW disc.

SD memory card track number



SD01 → CD01

CD track number

- ① Using the [ <<< ] [ >>> ] or [ + ] [ - ] buttons to select the desired song.

If you want to audition the selected song, press the [ ▶/|| (Play) ] button. To stop playback, press the [ ■ (Stop) ] button.



SD01 → CD02

- ② Press the [ENTER] button to confirm the song to be written.

\* To select additional tracks, repeat Step 5.

CD track number increases

- 6 When you've selected all of the tracks that you want to write to the CD-R/RW disc, press the [ > ] button.

## 7 If you're sure you want to proceed, press the [ENTER] button.

(If you decide to cancel, press the [EXIT] button.)

```
Write(SD→CD)
Are You Sure?
```

## 8 Use the [+] [-] buttons to specify the Finalize setting.

\* For details on "Finalize," refer to the text box "What's finalization?" on Page 83.

```
Finalize
: No
```

Value	Explanation
Yes	When writing is finished, the disc will be finalized to complete the music CD. No further data can be written to a CD-R/RW disc that has been finalized, even if space remains on the disc. However, if you're using a CD-RW disc, you can remove the finalization and add additional material.  "Removing Finalization" (Page 78)
No	The disc will not be finalized when writing is finished. After the tracks have been written, you will still be able to add more tracks if space remains on the disc. If you don't finalize at this point, you can still finalize later to complete your music CD.  "Making a CD-R/RW Disc for Playback on Another CD Player (Finalize)" (Page 83)

## 9 Write to the CD-R/RW disc.

### If you selected Finalize "Yes"

- 1 Press the [ENTER] button.  
(If you decide to cancel writing, press the [EXIT] button.)
- 2 If you're sure you want to proceed, press the [ENTER] button.  
(If you want to return to Step 8, press the [EXIT] button.)

```
Finalize
Are You Sure?
```

↓ Indicates the progress relative to the total number of songs

```
Write(SD→CD) 1/1
Processing.. 12%
```

↑ Indicates the progress for each song

The display will show "Processing..." and writing to the CD-R/RW disc will begin. When writing is completed, the display will show "Finalize..." and the finalization process will begin. Please wait.

When all processing has been completed, the CD-R/RW will be ejected. **Your music CD is now ready.**

### If you selected Finalize "No"

- 1 Press the [ENTER] button.  
(If you decide to cancel writing, press the [EXIT] button.)

Indicates the progress relative to the total number of songs

```
Write(SD→CD) 1/1
Processing.. 12%
```

↑ Indicates the progress for each song

The display will show "Processing..." and writing to the CD-R/RW disc will begin. Please wait.

When all processing has been completed, the CD-R/RW will be ejected.



## 10 The CD-2e asks whether you want to create another identical CD.

Write Completed  
Another Disc?

### If you want to create another identical CD

- ① Press the [ENTER] button.
- ② When you see this screen, insert a blank or un-finalized CD-R/RW disc.

Write(SD→CD)  
Insert Disc

Return to **Step 7** and continue the procedure.

### If you are finished writing

- ① Press the [EXIT] button to end the procedure.  
You're returned to the audio source screen.

### Important

- We cannot guarantee that a music CD created on the CD-2e will play on all CD players. Depending on your CD player's support for CD-R/RW discs, music CDs you create may not play correctly.
- Two seconds of silence are automatically inserted between tracks on the CD-R/RW disc when you create a music CD.
- The time required for writing will be approximately half the total playback time of the songs being written. For example, if you're writing songs that total twenty minutes of playback time, the process will require approximately ten minutes.

### If you want to create a music CD containing songs from more than one SD memory card

If the CD-R/RW disc has not been finalized, you can add tracks from another SD memory card. If you want to create a music CD using tracks from more than one SD memory card, simply keep adding tracks to a CD-R/RW disc and finalize (Page 83) the disc when you're finished.

\* You must turn off the power before exchanging SD memory cards (Page 26).

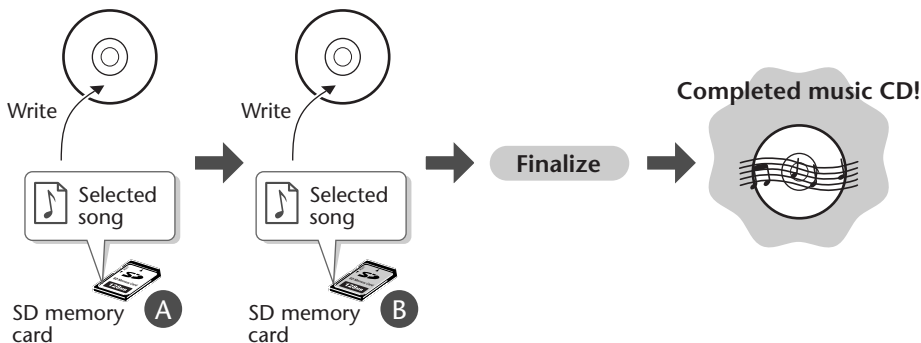

### Creating a music CD from songs recorded on an EDIROL R-09

#### “WAV 16-bit” and “44.1 kHz” is supported

If you want to create a music CD using songs that were recorded on an EDIROL R-09, you must set the R-09’s recording mode to “WAV 16-bit” and sampling frequency to “44.1 kHz” before you record.

#### Requirements for songs (files) that can be recognized

Even if a song was recorded with a recording mode of “WAV 16-bit” and a sampling frequency of “44.1 kHz,” the CD-2e will not recognize it unless it satisfies the following conditions.

- Track length must be longer than four seconds.
  - Track title must not contain double-byte characters (e.g., Japanese).
  - Track (file) must be located in the root directory of the SD memory card.
- \* The CD-2e is able to display and play back a maximum of 99 tracks.

#### File name display

If the song was recorded on the R-09, the song name (file name) will be displayed in Step 5 of Page 79.

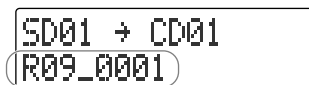

### Creating a music CD of a song that won’t fit on a single CD-R/RW disc

Even if a song recorded on the R-09 is too large to fit on a single CD-R/RW disc, it can automatically be divided across multiple CD-R/RW discs.

If you want to automatically divide a large song and write it across multiple discs, make the following setting in Step 5 on Page 79.

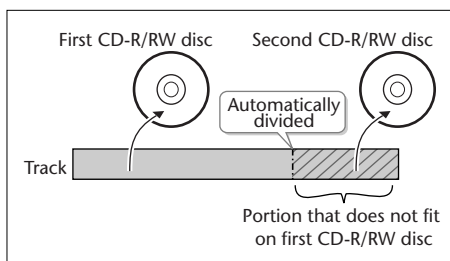

#### ① In Step 5 (Page 79), specify the large song as the “first” of the songs you want to write.

The song will be divided automatically only if the song you specify as the first song is larger than a single CD-R/RW disc. In this case, you won’t be able to specify additional songs to be added. After the first CD-R/RW disc has been ejected, the message “Insert Disc” will appear. Insert another CD-R/RW disc. When the disc is detected, writing will begin automatically. Continue inserting additional CD-R/RW discs as directed by the messages that appear. When all the data has been written, the message “Write Completed. Another Disc?” will appear. Continue with the procedure from Step 10 of Page 81.

- \* CD-R/RW discs that have no more space on them after the track has been written will be finalized automatically. For example, if a track is divided across two discs, as in the example shown in the illustration at the upper right, the first CD-R/RW disc will be finalized automatically.

# Making a CD-R/RW Disc for Playback on Another CD Player (Finalize)

## What's finalization?

Finalization is the process of writing final information (the number of songs, the song numbers, the playback times, etc.) to a CD-R/RW disc. When you "finalize" a CD-R/RW disc that was recorded or written by the CD-2e, that disc will be playable as a music CD in another CD player.

After finalization, it will no longer be possible to record or write additional material to that disc. You should finalize the disc when you have completed your music CD and don't need to write or record any more data.

\* In order to perform this operation, you'll need the included, dedicated AC adaptor.

- 1** Insert the CD-R/RW disc that you want to finalize.
- 2** Press the [EJECT (▲)] button.
- 3** If you're sure you want to proceed, press the [ENTER] button. (If you decide not to finalize the disc, press the [EXIT] button.)

```
Finalize
Are You Sure?
```



```
Finalize
Processing. . 1:12
```

 – Count-down (min:sec)

The disc is finalized. During this process, a timer is displayed, counting down the time until finalization is completed.

When finalization is completed, the CD-R/RW disc is ejected. Your music CD is now ready.

### Important

- We cannot guarantee that a music CD created on the CD-2e will play on all CD players. Depending on your CD player's support for CD-R/RW discs, music CDs you create may not play correctly.
- With a CD-RW disc, you can remove the finalization so that you'll again be able to record or write to that disc. 📖 "Removing Finalization" (Page 78)

# Creating a Duplicate of an Original Music CD (Backup)

Here's how to back up an original music CD you created, making an identical copy of your original music CD.

\* In order to perform this operation, you'll need the included, dedicated AC adaptor.

## Workflow to Back up CDs

- ① When copying a music CD, the CD tracks are stored temporarily on an SD memory card.
- ② The temporary tracks on the SD memory card are written to a blank CD-R/RW disc.  
(The CD-R/RW disc will be finalized automatically.)

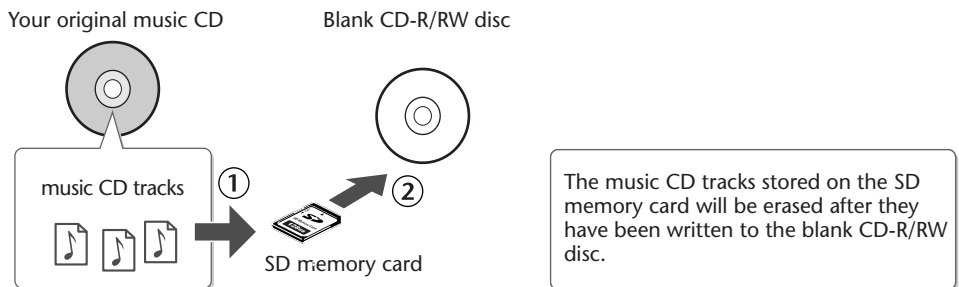

### 1 Insert an SD memory card to hold the music CD tracks.

The music CD's tracks will be stored up to the amount of free space available on the SD memory card. You may not be able to copy an entire CD if there's not enough free space remaining. If you use an SD memory card with 700 MB or more of free space, you will be able to copy an entire music CD.

### 2 Press the [MENU] button to access the menu screen, and choose "Make Backup?"

```
CD-R/RW  <>
Make Backup?
```

- ① Press the [MENU] button to access the menu screen.
- ② Use the [ < ] [ > ] buttons to choose "Make Backup?"
- ③ Press the [ENTER] button to confirm your choice.

### 3 When you see this screen, insert the music CD that you want to back up.

```
Make Backup
Insert Master CD
```

```
Make Backup 10/13
Reading CD. 20%
```

— Indicates the progress relative to the total number of songs  
— Indicates the progress for each song

When the music CD has been detected, the display will show "Reading CD" and the song data from the music CD will be written to the SD memory card.

When the song data has been written, the music CD will be ejected. Remove the CD.

**4** When you see this screen, insert a blank CD-R/RW disc.

```
Make Backup
Insert Blank CD
```

**5** If you're sure you want to proceed, press the [ENTER] button.

(If you decide to cancel, press the [EXIT] button.)

```
Make Backup
Are You Sure?
```



```
Make Backup10/13
Processing.. 20%
```

Indicates the progress relative to the total number of songs  
Indicates the progress for each song

The display will show "Processing...", and the backup will begin. When the backup is finished, the CD-R/RW disc will be ejected.

**6** The CD-2e asks whether you want to create another identical CD.

```
Make Backup
Another Disc?
```

**If you want to create another identical CD**

- 1 Press the [ENTER] button.
- 2 When you see this screen, insert a blank or appendable CD-R/RW disc.

```
Make Backup
Insert Blank CD
```

Return to **Step 5** and continue the procedure.

**If you are finished backing up**

- 1 Press the [EXIT] button to end the procedure.  
You're returned to the audio source screen.  
Play back the newly written CD-R/RW disc (Page 60) to verify that it was written correctly.

 **Important**

- You can't back up a CD-R/RW disc that has not been finalized (Page 83).
- Backing up a music CD will require some time for processing to be completed. The time required for backup will be approximately equal to the total playback time of the CD. For example, it will take approximately twenty minutes to back up a twenty-minute CD.

Checking / Preparations  
 Recording  
 Listening  
 Deleting  
 Creating a CD  
 Editing an SD  
 Information / Display  
 Convenient Functions  
 Advanced Uses  
 Appendices

**If the screen shows "Tr ##/xx Tr. Are You Sure?" (Step 3)**

The music CD's tracks will be written as far as the free space on the SD memory card allows. This means that if the SD memory card contains less free space than the amount of data from the music CD, you won't be able to record all of the tracks.

In this case, the message "Copy ##/xx Tr. Are You Sure?" will appear. This indicates that of the total number of tracks (xx), only Track 1 through Track ## will be copied

Number of tracks to be copied/total number of tracks on CD

COPY 10/13 Track  
Are You Sure?

Verify the number of tracks for recording, and press the [ENTER] button to continue the procedure. If you decide to cancel, press the [EXIT] button.

**If the display shows "Short of Capa" (Step 4)**

If the capacity of the CD-R/RW disc is less than the amount of data stored on the SD memory card, the message "Short Of Capa" will appear, and the CD-R/RW disc will be ejected.

Please insert a CD-R/RW disc with more writable space.

**If the screen shows "Obey Copyright?" (Step 3)**

Carefully read the section "About copyright" on the back cover of the owner's manual, and if you consent to the terms and want to continue the procedure, press the [ENTER] button. If you decide to cancel the procedure, press the [EXIT] button.

**If the screen shows "Obey License?" (Step 3)**

Carefully read the section "License agreement" on the back cover of the owner's manual, and if you consent to the terms and want to continue the procedure, press the [ENTER] button. If you decide to cancel the procedure, press the [EXIT] button.

# Moving a Song

This operation moves a song by changing the order of the songs.

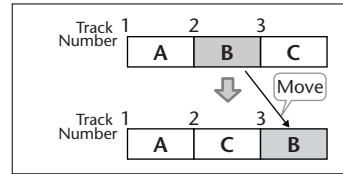

- 1** Insert the SD memory card that you want to edit, and press the [SD CARD] button.  
SD becomes the audio source.
- 2** Use the [◀◀] [▶▶] buttons to select the song that you want to move.
- 3** Press the [MENU] button to access the menu screen, and choose “Move?”

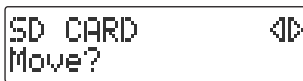

- ① Press the [MENU] button to access the menu screen.
- ② Use the [◀] [▶] buttons to choose “Move?”
- ③ Press the [ENTER] button to confirm your choice.

- 4** Select the move destination.

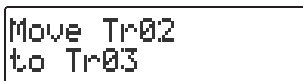

Number of the track  
at the move destination

- ① Use the [+] [-] buttons to select the move-destination song number.
- ② Press the [ENTER] button to confirm your choice.

In the example screen shown here, the song will be moved so it becomes the third song.

- 5** If you're sure you want to proceed, press the [ENTER] button.  
(If you decide to cancel, press the [EXIT] button.)

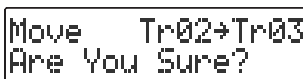

The display will show “Processing...”, and the song will be moved. When the move is completed, you're returned to the audio source screen.

## Important

This operation cannot be performed if the SD memory card's write protect switch (Page 25) is in the “LOCK” position.

# Dividing a Track

This operation divides a song into two songs.

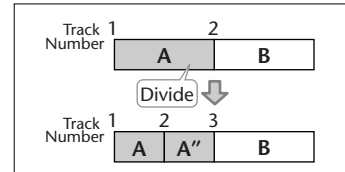

- 1** Insert the SD memory card that you want to edit, and press the [SD CARD] button.  
SD becomes the audio source.
- 2** Use the [◀◀] or [▶▶] button to select the track you want to edit.
- 3** Press the [MENU] button to access the menu screen, and choose “Divide?”

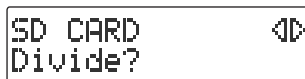

- ① Press the [MENU] button to access the menu screen.
- ② Use the [◀][▶] buttons to choose “Divide?”
- ③ Press the [ENTER] button to confirm your choice.

- 4** Press the [▶/|| (Play)] button to play back the selected song.



Number of the track you're editing

- 5** At the approximate location at which you want to divide the song (the dividing point), press the [● (Rec)] button.  
(If the song is long, you can fast-forward until you're near the desired point.)  
The four seconds starting immediately before the dividing point will be played repeatedly.
- 6** Use the [+] [-] buttons to make detailed adjustments to the dividing point.

Button	Explanation
[+] button	Moves the Dividing Point backward.
[-] button	Moves the Dividing Point forward.

- 7** Press the [ENTER] button.



## 8 If you're sure you want to proceed, press the [ENTER] button.

(If you decide to cancel, press the [EXIT] button.)

```
Divide
Are You Sure?
```



```
Divide
Processing.. 20%
```

— Progress indication

The display will show “Processing...”, and the song will be divided. When the division is completed, you're returned to the audio source screen.

### Important

- This editing process will take a certain amount of time. In general, the time will be approximately half the playback time of the song. For example, in order to edit a four-minute song, it will take approximately two minutes for the editing process to be completed.
- Dividing a song will require free space equal to the size of the song you're editing. For example, if you're editing a five-minute song, you won't be able to execute this operation unless you have at least five minutes of recording time remaining.
- You can't edit a track that is shorter than eight seconds.
- You can't specify Dividing Point locations that would cause the edited song to be less than four seconds long.
- This operation cannot be performed if the SD memory card's write protect switch (Page 25) is in the “LOCK” position.

# Joining Songs

This operation join two songs, making them into a single song. The song will be joined with the following song.

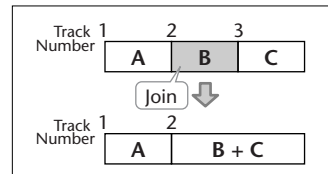

- 1 Insert the SD memory card that you want to edit, and press the [SD CARD] button.**  
SD becomes the audio source.
- 2 Use the [◀] [▶] buttons to select the song you want to join.**  
This song will be joined with the song that follows it.
- 3 Press the [MENU] button to access the menu screen, and choose "Combine?"**

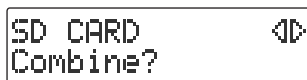

- ① Press the [MENU] button to access the menu screen.
- ② Use the [◀] [▶] buttons to choose "Combine?"
- ③ Press the [ENTER] button to confirm your choice.

- 4 If you're sure you want to proceed, press the [ENTER] button.**  
(If you decide to cancel, press the [EXIT] button.)

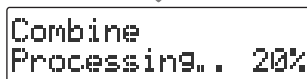
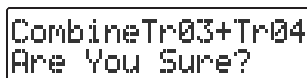

Progress indication

The display will show "Processing..." and the songs will be joined. When the operation is completed, you're returned to the audio source screen.

## Important

- This editing process will take a certain amount of time. The time required for this operation will be approximately half the playback time of two songs you're joining. For example, if you're joining a five-minute song and a three-minute song, processing will take approximately four minutes.
- Joining two songs will require free space equal to the size of the two songs being joined. For example, if you're joining a five-minute song and a three-minute song, you won't be able to execute this operation unless you have at least eight minutes of recording time remaining.
- This operation cannot be performed if the SD memory card's write protect switch (Page 25) is in the "LOCK" position.

# Maximizing the Volume of a Song

This operation raises the volume of the entire song as high as possible without causing the sound to distort. If the sound was recorded at too low a level, you can use this to increase the volume.

- 1 Insert the SD memory card that you want to edit, and press the [SD CARD] button.**  
SD becomes the audio source.
- 2 Use the [◀◀] or [▶▶] button to select the track you want to edit.**
- 3 Press the [MENU] button to access the menu screen, and choose "Normalize?"**

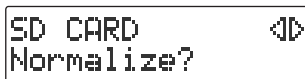

```
SD CARD  ◀▶
Normalize?
```

- ① Press the [MENU] button to access the menu screen.
- ② Use the [◀] [▶] buttons to choose "Normalize?"
- ③ Press the [ENTER] button to confirm your choice.

- 4 If you're sure you want to proceed, press the [ENTER] button.**  
(If you decide to cancel, press the [EXIT] button.)

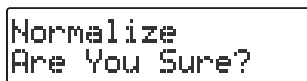

```
Normalize
Are You Sure?
```

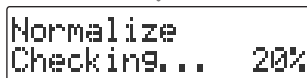

```
Normalize
Checking... 20%
```

— Progress indication

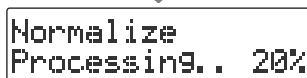

```
Normalize
Processing.. 20%
```

— Progress indication

The display will show "Processing..." and the volume of the song will be raised. When the operation is completed, you're returned to the audio source screen.

- \* If the volume of the song has already been maximized, the display will indicate "Checking...", and then the editing process will end.

## Important

- This editing process will take a certain amount of time. The time required for this operation will be approximately 1.5 times the playback time of the song. For example, if you apply this operation to a four-minute song, processing will take approximately six minutes.
- Maximizing the volume of a song will require free space equal to the size of the song you're editing. For example, if you're editing a five-minute song, you won't be able to execute this operation unless you have at least five minutes of recording time remaining.
- This operation cannot be performed if the SD memory card's write protect switch (Page 25) is in the "LOCK" position.

# Viewing the Remaining Recording/Playback Time

Here's how to switch the time information shown in the screen. You can view the remaining time that can be recorded on an SD memory card or CD-R/RW disc, or the time remaining in a song.

Press the [ENTER] button to switch between the available choices for the time indicator, as follows.

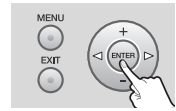

## During recording or recording standby

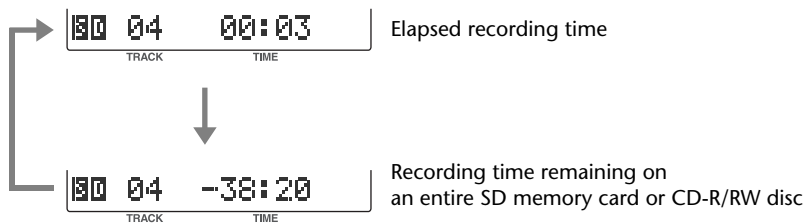

## During playback or while stopped

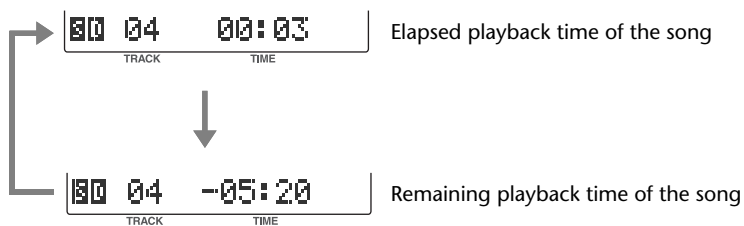

### Important

You can also check the remaining recording time by viewing information about the SD memory card or CD-R/RW disc. For details, refer to the following pages.

- ☞ Page 93, "Viewing Information about an SD Memory Card"
- ☞ Page 94, "Viewing Information about a CD-R/RW Disc"

# Viewing Information about an SD Memory Card

Here's how to view information such as the capacity of an SD memory card and the remaining time for recording.

- 1 Press the [MENU] button to access the menu screen, and choose "Card Info."**

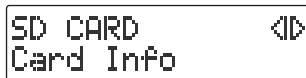

SD CARD      <|>  
Card Info

- ① Press the [MENU] button to access the menu screen.
- ② Use the [ < ] [ > ] buttons to choose "Card Info."
- ③ Press the [ENTER] button to confirm your choice.

- 2 View the information.**



Card Info 512MB  
Remain 150:22

— Total capacity of the SD memory card  
— Remaining recording time

- 3 Press the [EXIT] button twice.**  
You're returned to the audio source screen.

# Viewing Information about a CD-R/RW Disc

Here's how to view information such as the capacity of a CD-R/RW disc and the remaining time for recording.

- 1 Press the [MENU] button to access the menu screen, and choose "Disc Info."**



```
CD-R/RW  <|>
Disc Info
```

- ① Press the [MENU] button to access the menu screen.
- ② Use the [ < ] [ > ] buttons to choose "Disc Info."
- ③ Press the [ENTER] button to confirm your choice.

- 2 View the information.**



```
Disc Info 700MB
Remain    68:22
```

— Total capacity of the CD-R/RW disc  
— Remaining recording time

- 3 Press the [EXIT] button twice.**  
You're returned to the audio source screen.

## Important

The total capacity and remaining recording time are not shown for a finalized (Page 83) CD-R/RW disc or a music CD.

# Adjusting the Readability of the Screen (Contrast)

Depending on the temperature or other conditions, the characters in the screen may become difficult to read. In such cases, you can adjust the contrast for best readability.

- 1 Press the [MENU] button to access the menu screen, and choose "Contrast."

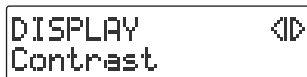

- ① Press the [MENU] button to access the menu screen.
- ② Use the [ < ] [ > ] buttons to choose "Contrast."
- ③ Press the [ENTER] button to confirm your choice.

- 2 Use the [+] [-] buttons to adjust the contrast of the screen.

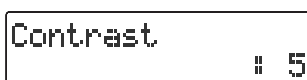

Value	Explanation
1-5 (factory setting)-8	Decreasing the value will lighten the screen. Increasing the value will darken the screen.

- 3 Press the [EXIT] button twice.  
You're returned to the audio source screen.

## Important

You can also adjust the screen contrast by holding down the [MENU] button and using the [+] [-] buttons.

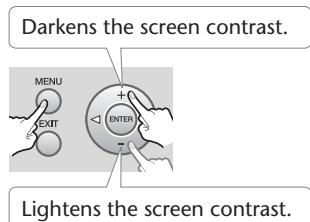

# Automatically Dimming the Screen (Backlight Timer)

If you're operating the CD-2e on batteries (Page 22), you can set this function so that the screen will automatically be dimmed to conserve batteries after no operation has been performed for a certain length of time.

\* This setting is effective only when the CD-2e is running on batteries. The screen will not dim if you're using the dedicated AC adaptor (Page 21).

## 1 Press the [MENU] button to access the menu screen, and choose "Backlight Timer."

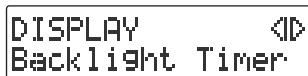

DISPLAY <D>  
Backlight Timer

① Press the [MENU] button to access the menu screen.

② Use the [ < ] [ > ] buttons to choose "Backlight Timer."

③ Press the [ENTER] button to confirm your choice.

## 2 Use the [+] [-] buttons to specify the time after which the backlight will automatically be dimmed.



Backlight Timer  
# 5 sec

Value	Explanation
Off (factory setting)	The backlight will always remain lit.
2 Sec	The backlight will automatically go dark when the specified time has elapsed following an operation.
5 Sec	
10 Sec	
20 Sec	

## 3 Press the [EXIT] button twice.

You're returned to the audio source screen.



# Changing the Screen Display Language

You can switch the screen display between various languages. You can choose from English, Japanese, Spanish, German, French, and Italian.

- 1 Turn off the power.**
- 2 Refer to the table below, and while holding down the button that corresponds to the desired screen display language, turn on the power.**  
For example, if you want to set the screen display language to "French," hold down the [REVERB] button and turn on the power. When the screen appears, release the button.

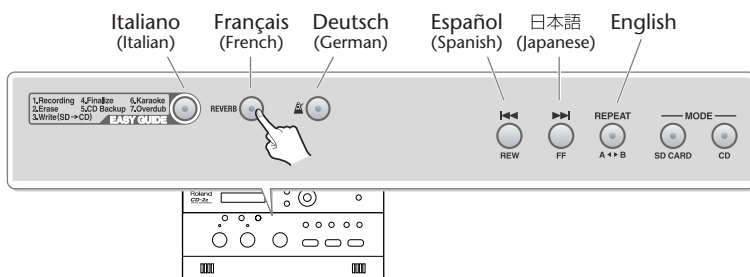

Display language	Button	Screen that appears when you switch power on
English	[REPEAT] button	Language EN English
Japanese	[▶▶] button	日本語 JP 日本語
Spanish	[◀◀] button	Idioma ES Español
German	[🎵 (Metronome)] button	Sprache DE Deutsch
French	[REVERB] button	Langue FR Français
Italian	[EASY GUIDE] button	Lingua IT Italiano

- 3 Turn the power off, then on again.**

After this, the screen display will be in the language you selected in Step 2.

## Important

You can also change the display language using the "Language" menu item.





Value	Explanation
EN English (factory setting)	English
JP ニホンゴ	Japanese
ES Español	Spanish
DE Deutsch	German
FR Français	French
IT Italiano	Italian

# Sounding the Metronome

The CD-2e has built-in metronome—a convenient feature for practicing an instrument.

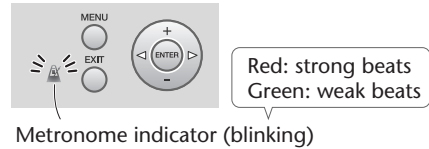
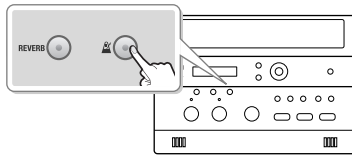
## 1 Press the [ (Metronome)] button to turn the metronome on.



If the metronome is on, the [  (Metronome)] button will light. At the same time, the metronome's indicator will start blinking on the beat.

When you press the [  (Metronome)] button once again, the metronome will turn off (unlit).

## 2 Setting the sound.



① Press the [MENU] button to access the menu screen.

② Use the [ < ] [ > ] buttons to choose "Sound."

\* If you press the [MENU] button while the metronome is on, a screen where you can select the metronome sound will immediately appear.

③ Press the [ENTER] button to confirm your choice.



④ Use the [+/-] buttons to select the desired metronome sound.

Value	Explanation
Click	An electronic sound will mark the beats.
Bell (factory setting)	A bell will mark the beats.
Voice	A human voice (English) will count the beats
Off	There will be no sound; the metronome indicator will blink to mark the beats.

## 3 Setting the tempo.



① Press the [EXIT] button to return to the menu screen.

② Use the [ < ] [ > ] buttons to choose "Tempo."

③ Press the [ENTER] button to confirm your choice.



④ Use the [+/-] buttons to specify the metronome tempo.

If you press the [ > ] button, the value will return to "120."

Value	Explanation
♩ = 20–120 (factory setting)–250	Specifies the number of quarter-notes in one minute. Decreasing this value will make the tempo slower. Increasing this value will make the tempo faster.

## 4 Specifying which beats are emphasized.

METRONOME   
Beat



① Press the [EXIT] button to return to the menu screen.

② Use the [ < ] [ > ] buttons to choose "Beat."

③ Press the [ENTER] button to confirm your choice.

Beat : 4

④ Use the [+ ] [- ] buttons to specify the timing at which the metronome will mark the strong beats.

Value	Explanation
0	No beats are emphasized.
1	Every beat is emphasized.
2	Every second beat is emphasized.
3	Every third beat is emphasized.
4 (factory setting)	Every fourth beat is emphasized.
5	Every fifth beat is emphasized.
6	Every sixth beat is emphasized.
7	Every seventh beat is emphasized.
	Each beat is divided into a triplet, and an emphasized beat will sound at the beginning of each triplet.
	Each beat is divided into sixteenth notes, and an emphasized beat will sound on the sixteenth note at the beginning of each beat.

\*  (a quarter-note) will be counted as one beat.

\* If you've selected "Voice" as the "Sound" setting, there will be no accent on the strong beats.

## 5 Press the [EXIT] button twice.

You're returned to the audio source screen.

### Important

- The metronome sound will not be audible during recording standby or while recording. If you want to hear the metronome, you'll need to use headphones.
- The metronome cannot be used while overdubbing a performance with a music CD. (📖 Page 46).

### Remote operations .....



Specify the metronome tempo.

 Make the tempo faster.

 Make the tempo slower.

 Turn the metronome on/off.

# Tuning Your Instrument (Tuner Function)

You can tune your instrument using the chromatic tuner function, which detects the name of the note in semitone steps.

- 1 Set the [MIC SELECT] switch located on the side of the CD-2e to the "INT" (internal mic) position.

This allows you to tune by inputting the sound of your instrument via the internal mic.

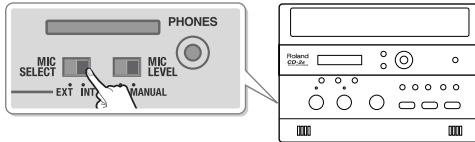

- 2 Press the [MENU] button to access the menu screen, and choose "Tuner/Tone?"



- 1 Press the [MENU] button to access the menu screen.
- 2 Use the [ < ] [ > ] buttons to choose "Tuner/Tone?"
- 3 Press the [ENTER] button to confirm your choice.

- 3 Watch the tuner screen, and play a note on the instrument you want to tune.



Note Name

The name of the note closest to the pitch you played will appear in the tuner screen. Tune your instrument so that the desired note name appears.

If the tuner does not respond, make sure that the [MIC] knob's level is raised.

- 4 Tune the instrument so that the left and right tuning guides are both displayed.

When your instrument is within  $\pm 50$  cents of the correct pitch, a tuning guide will appear in the screen. This indicates the distance between the displayed note name and the pitch your instrument is actually producing.



Tuning guides

Tune your instrument so that the left and right guides are visible.

When only the right guide is displayed:

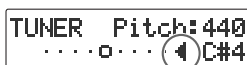

The pitch is above the displayed note name (i.e., sharp).

When only the left guide is displayed:



The pitch is below the displayed note name (i.e., flat).

- 5** When you're finished using the tuner, press the [EXIT] button twice.  
You're returned to the audio source screen.

### Important

- The tuner can also use an external mic. If you want to use an external mic, set the [MIC SELECT] switch to the "EXT" (external mic) position.
- You can't play back or record while using the tuner.
- If you don't want to hear sound while you're tuning, you can turn down the [VOLUME] knob or set the [SPEAKER] switch located on the back of the CD-2e to the "OFF" position so that the sound is muted.

## Changing the Tuner's Reference Pitch

You can calibrate the CD-2e's Tuner to another instrument or tuning standard by adjusting its "reference pitch."

The reference pitch is the frequency of the A4 note. This is the pitch of the middle A note on a piano.

- 1** Press the [MENU] button to access the menu screen, and choose "Tuner/Tone?"



- ① Press the [MENU] button to access the menu screen.
- ② Use the [ < ] [ > ] buttons to choose "Tuner/Tone?"
- ③ Press the [ENTER] button to confirm your choice.

- 2** Use the [+] [-] buttons to adjust the reference pitch as desired.



Value (units: Hz)	Explanation
435–440 (factory setting)–445	Decreasing this value will lower the pitch. Increasing this value will raise the pitch.

- 3** Press the [EXIT] button twice.  
You're returned to the audio source screen.

## Listening to a Guide Tone While Tuning

As a tuning aid, you can have the CD-2e sound a guide tone from the internal speakers.

- 1 Press the [MENU] button to access the menu screen, and choose "Tuner/Tone?"



- ① Press the [MENU] button to access the menu screen.
- ② Use the [ < ] [ > ] buttons to choose "Tuner/Tone?"
- ③ Press the [ENTER] button to confirm your choice.

- 2 While the tuner screen is displayed, press the [ENTER] button.  
(The tuner screen and the guide tone screen will alternate each time you press the [ENTER] button.)

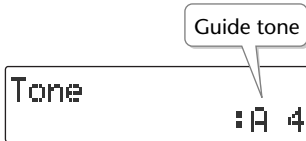

You'll hear the guide tone shown in the screen.

- 3 Use the [+] [-] buttons to select the name of the note you want to use as the guide tone.

Value	Explanation
A3-A4 (factory setting)-A5	You can choose one of 25 chromatic notes in the range A3-A5.

- 4 Tune your instrument to the guide tone.
- 5 To stop the guide tone, press the [EXIT] button twice.  
You're returned to the audio source screen.

### Important

The reference pitch for the guide tone can be adjusted in the Tuner screen ( Page 101).

# Returning the Menu Settings to their Factory-Set Condition (Factory Reset)

This operation returns all settings you've made in the menus to their factory-set condition (Factory Reset).

If the CD-2e does not operate as you expect even when you follow the steps in this manual, you may wish to execute the Initialize operation.

## 1 Press the [MENU] button to access the menu screen, and choose "Factory Reset?"



SYSTEM  
Factory Reset?

- ① Press the [MENU] button to access the menu screen.
- ② Use the [ < ] [ > ] buttons to choose "Factory Reset?"
- ③ Press the [ENTER] button to confirm your choice.

## 2 If you're sure you want to proceed, press the [ENTER] button. (If you decide to cancel, press the [EXIT] button.)



Factory Reset  
Are You Sure?

The display will show "Processing..." and the factory reset will be executed. When the factory reset is completed, you're returned to the audio source screen.

### Important

For the default value of each setting, refer to "List of Settings" on Page 32.

# Formatting an SD Memory Card

If an SD memory card has been used on a computer or other device, and any data remains on that SD memory card, there will be correspondingly less available recording time. By formatting the SD memory card, you can erase all data from the card, ensuring that the full capacity of the card will be available for recording.

## Note

- Never turn off the power or remove the SD memory card while formatting is in progress.
- When you format an SD memory card, all data stored on that card will be erased. Content lost in this way cannot be recovered. Please use this operation with caution.

**1** Insert the SD memory card that you want to format.

**2** Press the [MENU] button to access the menu screen, and choose "Format?"

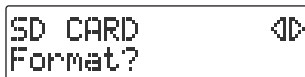

```
SD CARD  <|>
Format?
```

① Press the [MENU] button to access the menu screen.

② Use the [ < ] [ > ] buttons to choose "Format?"

③ Press the [ENTER] button to confirm your choice.

**3** If you're sure you want to proceed, press the [ENTER] button.



```
Format
Are You Sure?
```

**4** If you're still sure you want to proceed, press the [ENTER] button.  
(If you decide to cancel, press the [EXIT] button.)



```
You'll Lose Data
Really Sure?
```

The screen will show "Processing...", and the card will be formatted. When formatting is completed, you're returned to the audio source screen.

## Important

You can't format an SD memory card if its write protect switch (Page 25) is in the "LOCK" position.



# Adjusting the Left/Right Volume Balance of the Internal Mics

When recording via the internal mics (Page 36), the recorded sound may not be even in volume between the left and right sides, depending on where the CD-2e is located.

In such cases, you can adjust the left/right volume balance of the internal mics to compensate for the position in which the CD-2e is placed.

- 1** On the side panel of the CD-2e, set the [MIC SELECT] switch to the "INT" (internal mic) position.
- 2** Press the [MENU] button to access the menu screen, and choose "INT MIC Balance."



- ① Press the [MENU] button to access the menu screen.
- ② Use the [ < ] [ > ] buttons to choose "INT MIC Balance."
- ③ Press the [ENTER] button to confirm your choice.

- 3** While producing sound, adjust the left/right volume balance by using the [+] [-] buttons to change the value.

Adjust this setting so that the "L" and "R" level meters move by approximately the same amounts.



Value	Explanation
L50-C (factory setting)-R50	Increasing the "L" value will increase the volume of the input from the left internal mic. With a setting of "L50," no sound will be input from the right internal mic. Conversely, increasing the "R" value will increase the volume of the input from the right internal mic. With a setting of "R50," no sound will be input from the left internal mic. With the "C" (center) setting, the left/right volume balance will be equal.

- 4** Press the [EXIT] button twice.  
You're returned to the audio source screen.

# Reversing the Stereo Field of the Internal Mics

When using the internal mics (Page 36), the sound from the mic at the left side of the CD-2e will be recorded on the left channel (L), and the sound from the right mic will be recorded on the right channel (R).

If, as shown in the illustration below, the internal mics are pointed toward the performer on stage, the orientation of the internal mics will be reversed in comparison to the ears of the listeners, causing the recorded sound to be heard with a reversed stereo field.

In such cases, you can exchange the left and right channels of the internal mics. This way, the performance will be recorded just as you heard it.

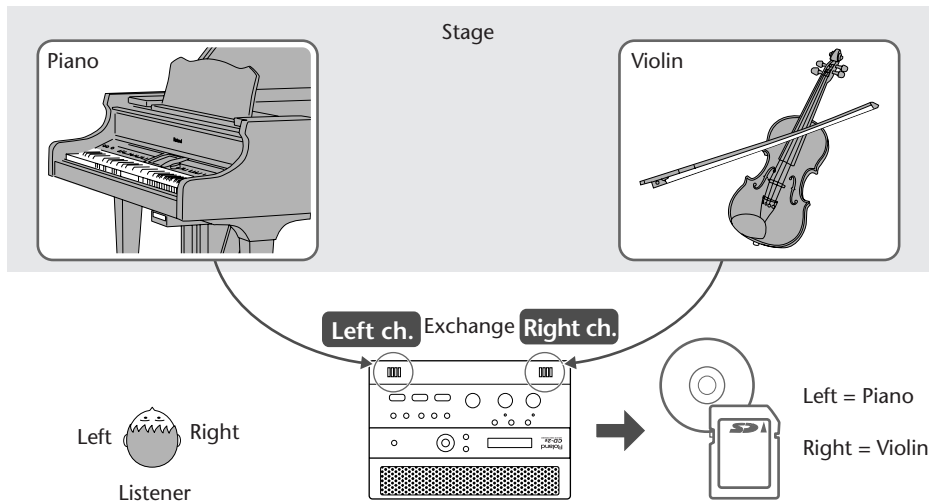

If you're recording your own performance, simply leave the setting as it is.

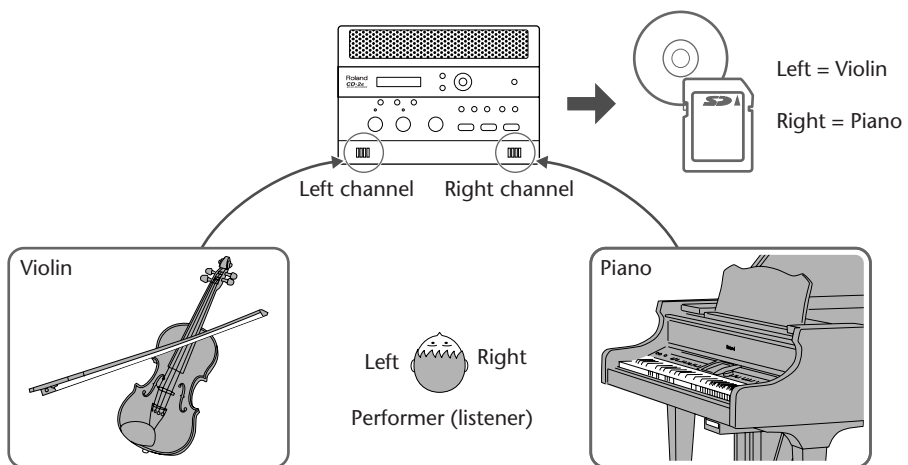

Here's how to exchange the right and left channels of the internal mics.

**1** Press the [MENU] button to access the menu screen, and choose "INT MIC Exchange."



- ① Press the [MENU] button to access the menu screen.
- ② Use the [ < ] [ > ] buttons to choose "INT MIC Exchange."
- ③ Press the [ENTER] button to confirm your choice.

**2** Use the [+] [-] buttons to change the setting, specifying whether you want the left and right channels to be exchanged for the internal mics.

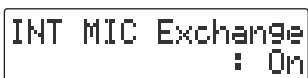

Value	Explanation
On	The left and right channels will be exchanged for the internal mics.
Off (factory setting)	The left and right channels will not be exchanged for the internal mics.

**3** Press the [EXIT] button twice.

You're returned to the audio source screen.

**Important**

- If you have exchanged the left and right channels of the internal mics, the L/R indication of the level meter will be the opposite of the "L" "R" indications.
- You can't exchange the left and right channels of a recorded song.



# Connecting External Speakers

You can connect external speakers to the LINE OUT jack and use them to listen to playback from the CD-2e or the sound received at its inputs. If you connect the LINE OUT jack to the input jack of your digital piano, you'll be able to listen to the sound using the built-in speakers of your digital piano.

## Note

You must turn on the power using the following procedure. If you fail to observe this procedure, you risk causing malfunction or speaker damage.

### 1 Turn off the power of the CD-2e.

- \* To prevent acoustic feedback, set the [MIC LEVEL] switch to the "MANUAL" position, and then turn the [MIC] knob all the way to the left so that it's off.

### 2 Minimize the volume of the external speakers (or digital piano) you'll be connecting, and turn off the power.

### 3 Connect the CD-2e's rear panel LINE OUT jack to your external speakers (or digital piano).

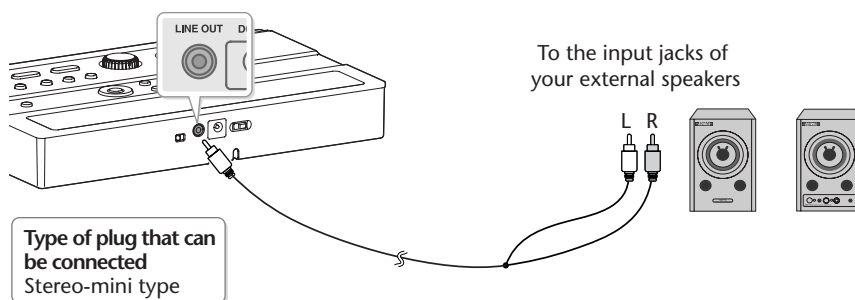

### 4 Turn on the power of the CD-2e.

### 5 Turn on the power of your external speakers (or digital piano).

### 6 Turn the [VOLUME] knob to adjust the output level of the LINE OUT jack. Adjust the volume of your external speakers (or digital piano).

## Important

- You can use external speakers that have a built-in amplifier (e.g., EDIROL MA-7A).
- If you hear acoustic feedback (a squealing sound) while using the mic, try changing the direction of the mic, moving it away from the speakers, or lowering the volume.

## Selecting the Audio Source that's Sent from the LINE OUT Jack

You can choose the audio source that is output from the LINE OUT jack.

- 1 Press the [MENU] button to access the menu screen, and choose "LINE OUT Select."



- ① Press the [MENU] button to access the menu screen.
- ② Use the [ < ] [ > ] buttons to choose "LINE OUT Select."
- ③ Press the [ENTER] button to confirm your choice.

- 2 Use the [+] [-] buttons to choose the audio source that will be output from the LINE OUT jack.

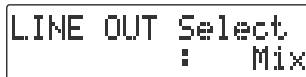

Value	Explanation
Mix (factory setting)	The audio of all sources is mixed and output.
MIC	The audio from the EXT MIC jacks or the CD-2e's internal mics is output.
LINE	The audio from the LINE IN jacks is output.
SD/CD	The audio from the SD memory card or CD is output.

- 3 Press the [EXIT] button twice.  
You're returned to the audio source screen.

# Troubleshooting

If you suspect a malfunction, please check the following points. If this does not resolve the problem, contact a nearby Roland Service Center.

## Power Supply

Problem	Cause and Action	See Page
The power does not turn on when you move the [POWER] switch to the "ON" position.	● <b>Could you be using an AC adaptor other than the included one?</b> → Use included dedicated AC adaptor.	21
	● <b>Could the AC adaptor plug have been disconnected from the CD-2e's AC adaptor jack? Could the power cord have been disconnected from the AC outlet or the dedicated AC adaptor's connector?</b> → Firmly reconnect the dedicated AC adaptor and power cord.	21
	● <b>Could the remaining battery power be insufficient?</b> → Once the battery runs low, the power may not turn on. Install fresh batteries.	23
	● <b>Are the batteries installed in the correct orientation?</b> → Check the "⊕" and "⊖" orientation of the batteries, and install them correctly.	22

## Screen

Problem	Cause and Action	See Page
The screen is difficult to read	● <b>Depending on the location or environment in which the CD-2e is placed, the screen may be difficult to read.</b> → Readjust the display contrast.	95
The screen goes dark	● <b>If you're using batteries, the Backlight Timer setting will dim the screen when you haven't operated the CD-2e for a specified length of time.</b> → Turn the Backlight Timer "Off."	96
Unreadable characters appear on the screen	● <b>Could you have specified the wrong screen display language?</b> → Select the appropriate screen display language.	97

## Problems with the Sound

Problem	Cause and Action	See Page
No sound	<ul style="list-style-type: none"> <li>● <b>Could the connections be incorrect?</b> → Make the correct connections.</li> </ul>	39, 42, 44
	<ul style="list-style-type: none"> <li>● <b>Could the power on the connected equipment (mic, digital piano, etc.) be switched off?</b> → Turn on the power.</li> </ul>	—
	<ul style="list-style-type: none"> <li>● <b>Could the volume of the connected device be turned down?</b> → Raise the volume of the connected device.</li> </ul>	—
	<ul style="list-style-type: none"> <li>● <b>Could headphones be plugged in?</b> → Unplug the headphones.</li> </ul>	—
	<ul style="list-style-type: none"> <li>● <b>Is the volume set to the minimum?</b> → Use the [VOLUME] knob to raise the volume.</li> </ul>	60
	<ul style="list-style-type: none"> <li>● <b>Could the speakers be muted ([SPEAKER] switch in the “OFF” position)?</b> → Set the [SPEAKER] switch to the “ON” position to disable speaker muting.</li> </ul>	69
	<ul style="list-style-type: none"> <li>● <b>Could the [ ● (Recording)] button be blinking or lit?</b> → In recording-standby mode or while recording, there will be no sound from the speakers, regardless of the position of the [SPEAKER] switch. Use headphones if you want to monitor the sound during recording.</li> </ul>	—
The input source (audio source) is not output	<ul style="list-style-type: none"> <li>● <b>Could the input level be turned down?</b> → If you’ve connected external mics, turn the [MIC] knob to raise the input level. → If you’re inputting audio via the LINE IN jacks, turn the [LINE] knob to raise the input level.</li> </ul>	40 42, 44
	<ul style="list-style-type: none"> <li>● <b>Could the [MIC SELECT] switch be in the “INT” position?</b> → If the [MIC SELECT] switch is in the “INT” position, the sound from the internal mics will be recorded. The sound from the internal mics won’t be heard from the speakers. Use headphones if you want to monitor the sound of the internal mics.</li> </ul>	36
	<ul style="list-style-type: none"> <li>● <b>Could the [MIC SELECT] switch be set incorrectly?</b> → If you want to record using the internal mics, set the switch to “INT.” → If you want to use external mics for your recording, set the switch to “EXT.”</li> </ul>	36 39







- Checking / Preparations
- Recording
- Listening
- Deleting
- Creating a CD
- Editing an SD
- Information / Display
- Convenient Functions
- Advanced Uses
- Appendices

## Problems with the Sound (continued)

Problem	Cause and Action	See Page
<b>Insufficient volume from a device connected to the EXT MIC (L/MONO, R) /LINE IN jacks</b>	<ul style="list-style-type: none"> <li>● <b>Could you be using a connection cable that contains an internal resistor?</b> → Use a connection cable—such as one from the Roland PCS series— that does not contain an internal resistor.</li> </ul>	—
	<ul style="list-style-type: none"> <li>● <b>Could the external mic’s sensitivity be set to “Low”?</b> → If the sound from the external mic is still not loud enough even after you’ve adjusted the input level, set the “EXT MIC Sens” to “High.”</li> </ul>	41
<b>The sound recorded via the internal mics is not loud enough</b>	<ul style="list-style-type: none"> <li>● <b>Have you adjusted the input level of the internal mics?</b> → Turn the [MIC] knob to raise the input level of the internal mics.</li> </ul>	37
<b>The recorded sound is noisy or distorted</b>	<ul style="list-style-type: none"> <li>● <b>Is the input level adjusted appropriately?</b> → Adjust the input level so that the peak indicator lights briefly when loud sounds are input.</li> </ul>	37, 40, 42, 44
	<ul style="list-style-type: none"> <li>● <b>Could the input level be raised for a jack to which no device is connected?</b> → Even if no device is connected, we recommend that you turn down the input level—turn the knob all the way to the left—for everything other than the audio source you’re recording.</li> </ul>	—
	<ul style="list-style-type: none"> <li>● <b>Could the [MIC SELECT] switch be in the “INT” position?</b> → Even though you thought you were recording using an external mic, a noisy recording may indicate that you were actually recording through the internal mics. If you want to record using an external mic, set the [MIC SELECT] switch to the “EXT” position.</li> </ul>	39
	<ul style="list-style-type: none"> <li>● <b>Is the output level set correctly?</b> → If you raise the output level too high, noise or distortion may occur in the sound from the internal speakers. Turn the [OUTPUT LEVEL] knob to adjust the volume.</li> </ul>	60
<b>An unwanted effect is applied to the sound</b>	<ul style="list-style-type: none"> <li>● <b>Could you have selected a reverb?</b> → Turn the reverb “Off.”</li> </ul>	68
<b>Volume changes are not recorded correctly according to the actual performance</b>	<ul style="list-style-type: none"> <li>● <b>Could the [MIC LEVEL] switch be set to the “AUTO” position?</b> → The “AUTO” position is suitable for recording human voices at a meeting or lecture, and may be unsuitable for recording an instrumental performance. Change the setting to “MANUAL,” and turn the [MIC] knob to adjust the input level.</li> </ul>	38



## CD-Related Problems







Problem	Cause and Action	See Page
Can't insert a CD	<ul style="list-style-type: none"> <li>● <b>Could you be using batteries?</b> If you're operating the CD-2e on batteries, no CD-related operations can be performed. → Use the dedicated AC adaptor.</li> </ul>	21
Normal playback does not work	<ul style="list-style-type: none"> <li>● <b>Is the audio source set to "CD"?</b> → Press the [CD] button to choose "CD" as the audio source.</li> </ul>	60
	<ul style="list-style-type: none"> <li>● <b>Could the CD be upside down?</b> → Insert the CD with the label facing upward.</li> </ul>	27
	<ul style="list-style-type: none"> <li>● <b>Could you have inserted a CD on which nothing has been recorded?</b> → Insert a different disc.</li> </ul>	—
	<ul style="list-style-type: none"> <li>● <b>Could you be using repeat playback?</b> → Turn the repeat setting "Off" so that the  or  symbol is not shown.</li> </ul>	65
	<ul style="list-style-type: none"> <li>● <b>Could you be using A-B Repeat playback?</b> → Press the [REPEAT] button to get the A-B Repeat icon () to disappear. → Alternatively, press the [■ (Stop)] button to stop playback. A-B Repeat playback will be defeated.</li> </ul>	66
	<ul style="list-style-type: none"> <li>● <b>Could the playback speed have been changed?</b> → Set the Speed setting to "0" so that the Speed icon () disappears.</li> </ul>	67
	<ul style="list-style-type: none"> <li>● <b>Could the Pitch setting have been changed?</b> → Set the Pitch setting to "0" so that the Pitch icon () disappears.</li> </ul>	63
	<ul style="list-style-type: none"> <li>● <b>Could the Key setting have been changed?</b> → Set the Key setting to "0" so that the Key icon () disappears.</li> </ul>	62
	<ul style="list-style-type: none"> <li>● <b>Could Center Cancel be turned "On"?</b> → Set Center Cancel to "Off" so that the Center Cancel icon () disappears.</li> </ul>	64
	<ul style="list-style-type: none"> <li>● <b>Could the CD be damaged?</b> → Try playing a different CD.</li> </ul>	—
<ul style="list-style-type: none"> <li>● <b>Could the [▶/   (Play)] button be blinking?</b> → If the button is blinking, the CD is paused. Press the [▶/   (Play)] button to defeat pause.</li> </ul>	60	
Insufficient playback volume	<ul style="list-style-type: none"> <li>● <b>Could the CD playback level be turned down?</b> → Use SD/CD Level to raise the playback level.</li> </ul>	47

- Checking / Preparations
- Recording
- Listening
- Deleting
- Creating a CD
- Editing an SD
- Information / Display
- Convenient Functions
- Advanced Uses
- Appendices

## CD-Related Problems (continued)

Problem	Cause and Action	See Page
Can't record	<ul style="list-style-type: none"> <li>● <b>Could the CD be upside down?</b> → Insert the CD with the label facing upward.</li> </ul>	27
	<ul style="list-style-type: none"> <li>● <b>Could you be attempting to record on a CD-R/RW disc that has already been finalized?</b> → Use a blank or un-finalized CD-R/RW disc. → If you want to record on a CD-R/RW disc that has already been finalized, you'll need to remove finalization so that the disc can be recorded to again.</li> </ul>	— 78
	<ul style="list-style-type: none"> <li>● <b>Is it possible that the maximum recordable time or number of tracks (maximum of 99 tracks) has already been exceeded?</b> → If there are unwanted tracks on the disc, delete them before you continue recording. (This is only possible on a CD-RW disc.)</li> </ul>	76
	<ul style="list-style-type: none"> <li>● <b>Could you be attempting to record or erase a CD-RW disc more times than it is capable of?</b> → A CD-RW disc can be recorded and erased approximately 1,000 times.</li> </ul>	—
	<ul style="list-style-type: none"> <li>● <b>Could you be attempting to record an extremely short performance?</b> → You can't record for less than four seconds.</li> </ul>	35
	<ul style="list-style-type: none"> <li>● <b>Are you using a generic CD-R/RW disc?</b> → Use a CD-R/RW disc from a recommended manufacturer.</li> </ul>	123
After recording, the CD won't play back on a conventional CD player	<ul style="list-style-type: none"> <li>● <b>Did you finalize the disc after recording?</b> → Execute the Finalize operation.</li> </ul>	83
	<ul style="list-style-type: none"> <li>● <b>Is your CD player able to play back CD-R or CD-RW discs?</b> → If your CD player does not support CD-R or CD-RW discs, they may not play back correctly.</li> </ul>	—
The disc tray will not open	<ul style="list-style-type: none"> <li>● <b>Is the CD-2e powered up?</b> → Turn on the power of the CD-2e. → If a power failure has occurred, you can use the emergency eject hole to open the disc tray manually.</li> </ul>	21 28
CD-R/RW drive produces significant mechanical noise when operating	<ul style="list-style-type: none"> <li>● <b>Could you be using a high-speed compatible CD-RW disc?</b> → If you're using a high-speed compatible CD-RW disc, performing the following operations will cause the disc to rotate at high speed, producing a greater level of mechanical noise. This is not a malfunction.                             <ul style="list-style-type: none"> <li>• When you stop recording</li> <li>• When you delete a track</li> <li>• When you assign a song number</li> <li>• When you finalize</li> </ul> </li> </ul> <p>If you find the mechanical operating noise of the CD-R/RW drive objectionable, please use an 8x compatible CD-R disc or a 1-4x compatible CD-RW disc.</p>	—

## SD Memory Card-Related Problems

Problem	Cause and Action	See Page
<b>The SD memory card is not detected</b>	<ul style="list-style-type: none"> <li>● <b>Could the SD memory card be of a capacity that is not supported?</b> → Check the capacity of the SD memory card, and use a card of a capacity supported by the CD-2e.</li> </ul>	122
	<ul style="list-style-type: none"> <li>● <b>Is the SD memory card inserted all the way into the slot?</b> → Make sure that the card is oriented correctly, and that it's pushed all the way into the slot.</li> </ul>	24
	<ul style="list-style-type: none"> <li>● <b>Could you have turned off the power while recording, or could the SD memory card have been subjected to a strong impact?</b> → It's possible that the data has been damaged. Reformat the SD memory card.</li> </ul>	104
<b>Normal playback does not work</b>	<ul style="list-style-type: none"> <li>● <b>Is the audio source set to "SD"?</b> → Press the [SD CARD] button to choose "SD" as the audio source.</li> </ul>	60
	<ul style="list-style-type: none"> <li>● <b>Could you have inserted an SD memory card on which nothing has been recorded?</b> → Insert a different SD memory card.</li> </ul>	—
	<ul style="list-style-type: none"> <li>● <b>Could you be using repeat playback?</b> → Turn the repeat setting "Off" so that the  or  symbol isn't shown.</li> </ul>	65
	<ul style="list-style-type: none"> <li>● <b>Could you be using A-B Repeat playback?</b> → Press the [REPEAT] button to get the A-B Repeat icon () to disappear. → Alternatively, press the [■ (Stop)] button to stop playback. A-B Repeat playback will be defeated.</li> </ul>	66
	<ul style="list-style-type: none"> <li>● <b>Could the playback speed have been changed?</b> → Set the Speed setting to "0" so that the Speed icon () disappears.</li> </ul>	67
	<ul style="list-style-type: none"> <li>● <b>Could the Pitch setting have been changed?</b> → Set the Pitch setting to "0" so that the Pitch icon () disappears.</li> </ul>	63
	<ul style="list-style-type: none"> <li>● <b>Could the Key setting have been changed?</b> → Set the Key setting to "0" so that the Key icon () disappears.</li> </ul>	62
	<ul style="list-style-type: none"> <li>● <b>Could Center Cancel be turned "On"?</b> → Set the Center Cancel to "Off" so that the Center Cancel icon () disappears.</li> </ul>	64
	<ul style="list-style-type: none"> <li>● <b>Could the [▶/   (Play)] button be blinking?</b> → If the button is blinking, the CD is paused. Press the [▶/   (Play)] button to defeat pause.</li> </ul>	60

- Checking / Preparations
- Recording
- Listening
- Deleting
- Creating a CD
- Editing an SD
- Information / Display
- Convenient Functions
- Advanced Uses
- Appendices

## SD Memory Card-Related Problems (continued)









Problem	Cause and Action	See Page
Insufficient playback volume	<ul style="list-style-type: none"> <li>● <b>Could the SD memory card playback level be turned down?</b> → Use SD/CD Level to raise the playback level.</li> </ul>	50
Can't record	<ul style="list-style-type: none"> <li>● <b>Is the SD memory card inserted all the way into the slot?</b> → Make sure that the card is oriented correctly, and that it's pushed all the way into the slot.</li> </ul>	24
	<ul style="list-style-type: none"> <li>● <b>Could you be attempting to record an extremely short performance?</b> → You can't record for less than four seconds.</li> </ul>	35
	<ul style="list-style-type: none"> <li>● <b>Is it possible that the maximum recordable time or number of tracks (maximum of 99 tracks) for the card has been exceeded?</b> → If there are unwanted tracks on the card, delete them before you continue recording.</li> </ul>	70
	<ul style="list-style-type: none"> <li>● <b>Could the SD memory card be protected?</b> → Slide the protect switch away from the "LOCK" position.</li> </ul>	25

# Messages

If a message is displayed, refer to the following list and take the appropriate action.

Messages for which the upper line of the screen shows "-- ERROR!--" will disappear when you press the [ENTER] button.



Message	Content	Action
<b>Battery Low</b>	The batteries are running low.	Install fresh batteries as soon as possible.
<b>Blank Disc</b>	The CD-R/RW disc is blank (empty).	Use a CD-R/RW disc that isn't blank.
<b>CD Disc Busy</b>	The disc could not be read/written in time.	If this appears during playback, use an unscratched disc. If this appears during recording, use a recommended brand of CD-R/RW disc.  Page 123
<b>CD Disc Full</b>	The CD-R/RW disc is full. No more tracks can be recorded.	Record on another CD-R/RW disc. In the case of a CD-RW disc, you can increase the amount of free space by deleting the last song.  Page 76
<b>CD Track Full</b>	You've reached the maximum number of 99 tracks that can be recorded on a disc. No more tracks can be recorded.	Record on another CD-R/RW disc. In the case of a CD-RW disc, you can increase the amount of free space by deleting the last song.  Page 76
<b>CD Read Failed</b>	Failed to read a disc.	Use a disc that isn't scratched.
<b>CD Write Failed</b>	Failed to write a CD-R/RW disc.	Use a recommended brand of CD-R/RW disc.  Page 123
<b>Count-in REC</b>	Recording will begin after a count-in.	—
<b>Divide Multiple</b>	The track will be divided for writing on multiple discs.	—
<b>Finalized Disc</b>	The disc is an already-finalized CD-R/RW disc or a music CD.	Use an unfinalized CD-R/RW disc.
<b>Improper Disc</b>	The disc is an inappropriate type for the operation you're attempting to perform.	Use a disc that's appropriate for the operation.
<b>Improper File</b>	This song cannot be edited on the CD-2e.	—
<b>Last SD Track</b>	When joining songs, you selected the last song in the SD memory card. The songs cannot be joined because there's no following song.	Select a song other than the last song, and then execute the join operation.
<b>Locked SD Card</b>	Since the protect switch of the SD memory card is in the LOCK position, songs cannot be recorded or edited.	Slide the protect switch of the SD memory card away from the "LOCK" position.
<b>No SD Tracks</b>	The SD memory card does not contain any songs to edit or write to the CD.	—
<b>Not A CD-RW</b>	The disc is not a CD-RW disc.	Use a CD-RW disc.
<b>Not Finalize</b>	The CD-R/RW disc to be backed up hasn't been finalized.	Please finalize the CD-R/RW disc that you want to back up.
<b>Now Playing..</b>	The operation cannot be performed because playback's in progress.	—
<b>Now Recording</b>	The operation cannot be performed because recording's in progress.	—

Message	Content	Action
<b>Only 1 SD Track</b>	Since there's only one song in the SD memory card, you can't move or join songs.	—
<b>Please Wait</b>	Preparations for playback are being made. Please wait.	—
<b>Power Down</b>	The batteries are depleted. The CD-2e cannot be operated.	Please install fresh batteries.
<b>REC Too Short</b>	You can't stop recording because the elapsed recording time has not reached four seconds. The track number can't be assigned because the location selected is less than four seconds after the previous track number.	Each recording must be longer than four seconds.  Assign track numbers at intervals of four seconds or greater.
<b>SD Can't Format</b>	Failed to format the card.	Use a different card.
<b>SD Card Busy</b>	The SD memory card couldn't be read/written in time.	Use a recommended brand of SD memory card.  Page 122
<b>SD Card Full</b>	The card is full. No more tracks can be recorded.	Delete unwanted tracks to increase the free space.  Page 70
<b>SD No Enough Mem</b>	The card doesn't have enough free space for the operation.	Delete unwanted tracks to increase the free space.  Page 70
<b>SD Read Failed</b>	Failed to read an SD memory card.	Turn off the power, and re-insert the SD memory card. Please format the SD memory card. Use a recommended brand of SD memory card.  Page 122
<b>SD Track Full</b>	You've reached the maximum number of tracks (99) that can be recorded on an SD memory card. No more tracks can be recorded.	Delete unwanted tracks to increase the free space.  Page 70
<b>SD Was Removed</b>	The SD memory card was removed while reading or writing.	Turn the power off, and then on again; if normal operation doesn't resume, format the card.  Page 104
<b>SD Write Failed</b>	Failed to write an SD memory card.	Use a recommended brand of SD memory card.  Page 122
<b>Short Of Capa</b>	You can't assign an SD track that exceeds the available CD-R/RW disc space.	Either use another CD-R/RW disc, or assign a smaller SD track.
<b>Tr is Too Short</b>	You can't trim in (out) or divide because a track can't be shorter than four seconds.	—
<b>Unknown Disc</b>	The disc cannot be used with the CD-2e.	Confirm that the disc can be used.  Page 20, 123
<b>Unsupported SD</b>	The CD-2e is unable to use this SD memory card.	Use a different card.
<b>Use AC Adaptor</b>	You attempted to perform a CD-related operation without using the dedicated AC adaptor.	Please use the dedicated AC adaptor.
<b>Waiting Signal..</b>	Waiting for audio input to trigger recording.	To begin recording, input an audio signal.  Page 53

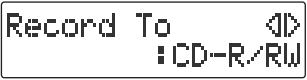

# Setting Items in Easy Guide

This section explains items that you can set in the screens appearing in Easy Guide.

## 1. Recording

Displayed screen	Explanation
	Select the media to be used for recording. CD-R/RW      Choose this if you're recording on a CD-R/RW disc. <hr/> SD Card      Choose this if you're recording on an SD memory card.
	Select what you want to record. Easy INT MIC      Choose this if you're making a test recording using the internal mics. <hr/> Acoustic Inst      Choose this if you're recording an acoustic instrument (e.g., piano, guitar, string instrument, or wind instrument). <hr/> Vocal      Choose this if you're recording a vocal. <hr/> Digital Piano      Choose this if you're recording an electronic musical instrument (e.g., digital piano or synthesizer). <hr/> Cassette Tape      Choose this if you're recording from a cassette tape or a MD. <hr/> Speech      Choose this if you're recording a conference.

## 2. Erase

Displayed screen	Explanation
	Select the media that you want to erase. CD-RW      Choose this if you're erasing tracks from a CD-R/RW disc. <hr/> SD Card      Choose this if you're erasing tracks from an SD memory card.
	Select how the songs are to be erased. All Tracks      All songs will be erased. <hr/> Last Track      The last song on the CD-RW disc will be erased. <hr/> 1 Track      The selected song will be erased. <hr/> * If you're using an SD memory card, you can choose "All Tracks" or "1 Track." * If you're using a CD-RW disc, you can choose "All Tracks" or "Last Track."



### 3. Write (SD→CD)

Displayed screen	Explanation						
	Select whether or not the disc is to be finalized once writing is complete. <table border="0"> <tr> <td>Yes</td> <td>When writing has been completed, the disc will be finalized to complete your music CD.</td> </tr> <tr> <td colspan="2"><hr/></td> </tr> <tr> <td>No</td> <td>The disc will not be finalized when writing has been completed.</td> </tr> </table>	Yes	When writing has been completed, the disc will be finalized to complete your music CD.	<hr/>		No	The disc will not be finalized when writing has been completed.
Yes	When writing has been completed, the disc will be finalized to complete your music CD.						
<hr/>							
No	The disc will not be finalized when writing has been completed.						

### 6. Karaoke

Displayed screen	Explanation						
	Select whether or not the Center Cancel (Page 64) is to be applied. <table border="0"> <tr> <td>On</td> <td>Center Cancel will be on. Sounds heard from the center during playback will be eliminated.</td> </tr> <tr> <td colspan="2"><hr/></td> </tr> <tr> <td>Off</td> <td>Center Cancel will be off.</td> </tr> </table>	On	Center Cancel will be on. Sounds heard from the center during playback will be eliminated.	<hr/>		Off	Center Cancel will be off.
On	Center Cancel will be on. Sounds heard from the center during playback will be eliminated.						
<hr/>							
Off	Center Cancel will be off.						

### 7. Overdub

Displayed screen	Explanation																		
	Select the media to be used for recording. <table border="0"> <tr> <td>CD-R/RW</td> <td>Choose this if you're recording on a CD-R/RW disc.</td> </tr> <tr> <td colspan="2"><hr/></td> </tr> <tr> <td>SD Card</td> <td>Choose this if you're recording on an SD memory card.</td> </tr> </table>	CD-R/RW	Choose this if you're recording on a CD-R/RW disc.	<hr/>		SD Card	Choose this if you're recording on an SD memory card.												
CD-R/RW	Choose this if you're recording on a CD-R/RW disc.																		
<hr/>																			
SD Card	Choose this if you're recording on an SD memory card.																		
	Select what you want to record. <table border="0"> <tr> <td>Easy INT MIC</td> <td>Choose this if you're making a test recording using the internal mics.</td> </tr> <tr> <td colspan="2"><hr/></td> </tr> <tr> <td>Acoustic Inst</td> <td>Choose this if you're recording an acoustic instrument (e.g., piano, guitar, string instrument, or wind instrument).</td> </tr> <tr> <td colspan="2"><hr/></td> </tr> <tr> <td>Vocal</td> <td>Choose this if you're recording a vocal.</td> </tr> <tr> <td colspan="2"><hr/></td> </tr> <tr> <td>Digital Piano</td> <td>Choose this if you're recording an electronic musical instrument (e.g., digital piano or synthesizer).</td> </tr> <tr> <td colspan="2"><hr/></td> </tr> <tr> <td>Cassette Tape</td> <td>Choose this if you're recording from a cassette tape or a MD.</td> </tr> </table>	Easy INT MIC	Choose this if you're making a test recording using the internal mics.	<hr/>		Acoustic Inst	Choose this if you're recording an acoustic instrument (e.g., piano, guitar, string instrument, or wind instrument).	<hr/>		Vocal	Choose this if you're recording a vocal.	<hr/>		Digital Piano	Choose this if you're recording an electronic musical instrument (e.g., digital piano or synthesizer).	<hr/>		Cassette Tape	Choose this if you're recording from a cassette tape or a MD.
Easy INT MIC	Choose this if you're making a test recording using the internal mics.																		
<hr/>																			
Acoustic Inst	Choose this if you're recording an acoustic instrument (e.g., piano, guitar, string instrument, or wind instrument).																		
<hr/>																			
Vocal	Choose this if you're recording a vocal.																		
<hr/>																			
Digital Piano	Choose this if you're recording an electronic musical instrument (e.g., digital piano or synthesizer).																		
<hr/>																			
Cassette Tape	Choose this if you're recording from a cassette tape or a MD.																		



# Specifications

<b>Recorder Part</b>	Tracks	2 (Stereo)																								
	Sampling Rate	44.1 kHz																								
	Signal Processing	AD/DA conversion: 24 bits																								
	Recording Mode	SD Memory Card: WAV (44.1 kHz, 16 bits) CD-R, CD-RW: Audio CD																								
	Recording Media	SD Memory Card (supports 64 MB–8 GB, SDHC format compatible) CD-R, CD-RW																								
	Recording Time (unit: min)	CD-R or CD-RW disc <table border="1" data-bbox="532 426 906 513"> <thead> <tr> <th>Disc Capacity</th> <th>Recording Time</th> </tr> </thead> <tbody> <tr> <td>650 MB</td> <td>74</td> </tr> <tr> <td>700 MB</td> <td>80</td> </tr> </tbody> </table> SD Memory Card <table border="1" data-bbox="532 562 906 817"> <thead> <tr> <th>Card Capacity</th> <th>Recording Time</th> </tr> </thead> <tbody> <tr> <td>64 MB</td> <td>5</td> </tr> <tr> <td>128 MB</td> <td>11</td> </tr> <tr> <td>256 MB</td> <td>23</td> </tr> <tr> <td>512 MB</td> <td>46</td> </tr> <tr> <td>1 GB</td> <td>93</td> </tr> <tr> <td>2 GB</td> <td>190</td> </tr> <tr> <td>4 GB</td> <td>373</td> </tr> <tr> <td>8 GB</td> <td>763</td> </tr> </tbody> </table> * Each recording time is an approximate estimate including some errors. * In case that there are plural files, the sum of recording time would be shorter than above. * Maximum recording time of one song is 74 minutes.	Disc Capacity	Recording Time	650 MB	74	700 MB	80	Card Capacity	Recording Time	64 MB	5	128 MB	11	256 MB	23	512 MB	46	1 GB	93	2 GB	190	4 GB	373	8 GB	763
	Disc Capacity	Recording Time																								
	650 MB	74																								
	700 MB	80																								
	Card Capacity	Recording Time																								
64 MB	5																									
128 MB	11																									
256 MB	23																									
512 MB	46																									
1 GB	93																									
2 GB	190																									
4 GB	373																									
8 GB	763																									
Recording Songs	Up to 99 songs on a single SD Memory Card, CD-R, or CD-RW																									
<b>Input/Output</b>	Audio Input	Internal Stereo Microphone EXT MIC Input L/MONO, R Jack: 1/4 inch phone type LINE Input Jacks (L, R): RCA phono type																								
	Audio Output	Internal Stereo Speaker PHONES Jack: Stereo miniature phone type Line Out Jack: Stereo miniature phone type																								
	Frequency Response	20 Hz–20 kHz (+0dB/-2dB)																								
	Nominal Input Level (variable)	EXT MIC Input L/MONO, R Jack: -51– -14 dBu (maximum -2 dBu) LINE Input Jacks (L, R): -24– 0 dBu (maximum +12 dBu)																								
	Nominal Output Level	Line Output Jack: -10 dBu (maximum +2 dBu)																								
	Input Impedance	EXT MIC Input L/MONO, R Jack: 20 k ohms Line Input Jacks (L, R): 9 k ohms																								
	Output Impedance	Line Output Jack: 1 k ohms Phones Jack: 22 ohms																								
	Recommended Load Impedance	Line Output Jack: 10 k ohms or greater Phones Jack: 32 ohms																								
<b>Others</b>	Display	16 characters, two lines (backlit LCD)																								
	Dimensions	267 (W) x 183 (D) x 46 (H) mm 10-9/16 (W) x 7-1/4 (D) x 1-13/16 (H) inches																								
	Weight	1.1 kg 2 lbs 6 oz																								
	Power Supply	AC Adaptor (PSB-1U), Dry battery LR6 (AA) type (alkaline) x 6																								
	Current Draw	540 mA Expected battery life under continuous use: Alkaline dry cell batteries: approximately 6 hours * The time may vary according to usage conditions, batteries used, and type of SD memory card used.																								
	Accessories	Owner's Manual, Quick Start, Application Guide, AC Adaptor (PSB-1U), Power Cord, SD Memory Card, CD-R Disc (Blank media), Remote Controller, Battery for Remote Controller (CR2025)																								

\* 0 dBu = 0.775 V rms

\* In the interest of product improvement, the specifications and/or appearance of this unit are subject to change without prior notice.

# Recommended SD Memory Card

Roland recommends the following SD memory cards, which have been confirmed to work with the CD-2e.

Brand Name	Model Name
<b>8GB (SDHC memory card)</b>	
PQI	QSDH6-8GB
<b>4GB (SDHC memory card)</b>	
Kingston	SD2/4GBFE
<b>2GB (SD memory card)</b>	
Kingston	SD/2GBFE
Lexar	SD2GB-231
Transcend	TS2GSD150
<b>1GB (SD memory card)</b>	
Lexar	SD1GB-231
SanDisk	SDSDB-1024-J60
SanDisk	SDSDH-1024-903
Transcend	TS1GSDC
Transcend	TS1GSD80
<b>512MB (SD memory card)</b>	
Lexar	SD512-231
Transcend	TSS12MSDC

(As of September 27, 2007)

- \* Though all of the cards listed above performed properly in our testing, some of them may not work due to differences in inherent manufacturer design specifications and your operating environment. We cannot guarantee the operation of all the models listed above.
- \* All compatibility testing was done in Japan, using SD memory cards available to the Japanese market. As such, be advised that the listed SD memory cards may not be available outside of Japan.
- \* Refer to the Roland website for details on the SD memory cards that can be used with the CD-2e. Up-to-date information about cards that are known to work are provided on the website.

<http://www.Roland.com/>

# Recommended CD-R/RW Disc Manufacturers

Roland recommends CD-R/RW discs made by the following manufacturers, which have been confirmed to work with the CD-2e.

## CD-R Discs

Recommended Manufacturers	Capacity	Supported writing speeds
TAIYO YUDEN Co.,Ltd.	650MB	Use CD-R discs that support 8x speed. Example: 2-48x speed, 1-32x speed
Mitsubishi Chemical Corp.	700MB	
Hitachi Maxell, Ltd.		
TDK Corp.		
Imation Corp.		

(As of September 27, 2007)

- \* Although all of the discs above functioned properly in our tests, there may be cases in which they will not operate correctly.

## CD-RW Discs

Recommended Manufacturers	Capacity	Supported writing speeds
Mitsubishi Chemical Corp.	650MB 700MB	Use CD-RW discs that support 4x speed or 8x speed. Example: Multi-speed CD-RW discs: 1-4x speed, 4x speed High-speed CD-RW discs: 4-10x speed, 4-12x speed

(As of September 27, 2007)

- \* Although all of the discs above functioned properly in our tests, there may be cases in which they will not operate correctly.
- \* CD-RW discs that support ultra-speed or ultra-speed plus cannot be used.

# Index

## Numerics

1 Track Repeat ..... 65

## A

Adjusting the readability of the screen ..... 95  
All Repeat ..... 65  
Auto Level ..... 38  
Auto Marker ..... 55, 56  
Auto Marker Lvl ..... 56  
Auto Marker Time ..... 55  
Auto Rec Start ..... 52  
Automatically recording ..... 52

## B

Backing up ..... 84  
Backlight Timer ..... 96  
Batteries  
    Backlight Timer ..... 96  
    battery life ..... 23  
    remaining indication ..... 23  
Beat (metronome) ..... 99  
Blank disc ..... 35

## C

Card Info ..... 93  
CD  
    Emergency eject hole ..... 28  
    Inserting ..... 27  
    Removing ..... 28  
    writing ..... 79  
CD Erase All? ..... 77  
CD-R/RW disc  
    Information ..... 94  
    Recommended manufacturers ..... 123  
Center Cancel ..... 64  
Chromatic tuner ..... 100  
Contrast ..... 95  
Count-in ..... 58  
Count-in (Beat) ..... 58

Creating a CD

R-09 ..... 82

## D

Deleting

    a track ..... 70  
    all tracks (CD-RW) ..... 77  
    all tracks (SD) ..... 71  
    region at the beginning of the song (SD) .. 72  
    region at the end of the song (SD) ..... 74  
    the last track (CD-RW) ..... 76  
    Trim In (SD) ..... 72  
    Trim Out (SD) ..... 74  
Disc Info ..... 94  
Divide ..... 88

## E

Easy Guide ..... 34, 119  
Editing an SD memory card  
    Divide ..... 88  
    Erasing a song ..... 70  
    Erasing all songs ..... 71  
    formatting ..... 104  
    Join ..... 90  
    Moving ..... 87  
    Normalize ..... 91  
    Trim In ..... 72  
    Trim Out ..... 74  
Erase Last? ..... 76  
Erase One? ..... 70  
Erasing ..... *See* Deleting  
EXT MIC Sens ..... 41  
External mic ..... 39  
    Sensitivity ..... 41  
External speakers ..... 108

## F

Factory Reset ..... 103  
Finalize ..... 28, 83  
    removing ..... 78  
Format ..... 25, 104

- G**
- Guide tone ..... 102
- I**
- Information
- CD-R/RW disc ..... 94
  - SD memory card ..... 93
- Input Level
- External mics ..... 40
  - Internal mics ..... 37
  - LINE IN jacks ..... 42, 44
- Inserting
- CD ..... 27
  - SD memory card ..... 24
- INT MIC Balance ..... 105
- INT MIC Exchange ..... 107
- Internal mics
- reversing the stereo field ..... 106
  - volume balance ..... 105
- K**
- Karaoke ..... 46, 64
- Key ..... 62
- L**
- Language ..... 97
- Limiter ..... 57
- LINE IN ..... 42, 44
- LINE OUT ..... 108
- LINE OUT Select ..... 109
- M**
- Make Backup? ..... 84
- Marker ..... 54, 55, 56
- Menu
- Factory Reset ..... 103
  - List of settings ..... 32
  - Operations ..... 31
- Metronome ..... 98
- Mic
- External mic ..... 39
  - Internal mics ..... 36
- Moving ..... 87
- Muting ..... 69
- N**
- Normalize ..... 91
- O**
- Oberdub CD→SD? ..... 47
- Oberdub SD→SD? ..... 50
- Overdubbing ..... 46, 49
- P**
- Pitch ..... 63
- Playback
- 1 Track Repeat ..... 65
  - A-B Repeat ..... 66
  - All Repeat ..... 65
  - Center Cancel ..... 64
  - changing the key ..... 62
  - changing the pitch ..... 63
  - changing the playback speed ..... 67
- Playback Level ..... 47, 50
- Playback speed ..... 67
- Power on/off
- batteries ..... 22
  - dedicated AC adaptor ..... 21
- Protect switch (SD) ..... 25

**R**

R-09 .....	82
Recommended manufacturers	
CD-R/RW disc .....	123
SD memory card .....	122
Recording	
Adjusting the input level automatically .....	38
Maximum recording times .....	35
Overdubbing .....	46, 49
Recording a Cassette or MD .....	44
Recording an electronic instrument .....	42
Recording karaoke .....	46
Remaining recording time .....	92
Using the external mics .....	39
Using the internal mics .....	36
Reference pitch .....	101
Remaining time .....	92
Remote Control .....	30
Remote control operation	
disabling .....	30
installing a battery .....	29
operating range .....	29
Removing	
CD .....	28
SD memory card .....	26
Repeat .....	65
Reset .....	103
Resume .....	61
Reverb .....	68

**S**

Screen display language .....	97
SD Erase All? .....	71
SD memory card	
Information .....	93
Inserting .....	24
Protect switch .....	25
Recommended manufacturers .....	122
Removing .....	26
SD/CD Level .....	47, 50
Sensitivity (external mic) .....	41

**Settings**

Factory Reset .....	103
List .....	32
Song numbers .....	54, 55, 56
Sound (metronome) .....	98
Speakers	
connecting .....	108
muting .....	69
Speed .....	67

**T**

Tempo (metronome) .....	98
Time indication .....	92
Track numbers .....	54, 55, 56
Trim In .....	72
Trim Out .....	74
Tuner .....	100
Tuner/Tone? .....	100

**U**

Unfinalize? .....	78
-------------------	----

**V**

Viewing information .....	93, 94
Volume balance .....	105

**W**

Write (SD→CD)? .....	79
Writing (creating a CD) .....	79

...MEMO...

Checking / Preparations

Recording

Listening

Deleting

Creating a CD

Editing an SD

Information / Display

Convenient Functions

Advanced Uses

Appendices

...MEMO...



# Information

When you need repair service, call your nearest Roland Service Center or authorized Roland distributor in your country as shown below.

## AFRICA

### EGYPT

AI Fanny Trading Office  
9, EBN Hagar Al Askalany  
Street,  
ARD El Golf, Heliopolis,  
Cairo 11341, EGYPT  
TEL: 20-2-417-1828

### REUNION

Maison FO - YAM Marcel  
25 Rue Jules Hermann,  
Chaudron - BP79 97 491  
Ste Clotilde Cedex,  
REUNION ISLAND  
TEL: (0262) 218-429

### SOUTH AFRICA

T.O.M.S. Sound & Music  
(Pty)Ltd.  
2 ASTRON ROAD DENVER  
JOHANNESBURG ZA 2195,  
SOUTH AFRICA  
TEL: (011)417 3400

Paul Bothner(Pty)Ltd.  
Royal Cape Park, Unit 24  
Londonderry Road, Ottery 7800  
Cape Town, SOUTH AFRICA  
TEL: (021) 799 4900

## ASIA

### CHINA

Roland Shanghai Electronics  
Co.,Ltd.  
5F. No.1500 Pingliang Road  
Shanghai 200090, CHINA  
TEL: (021) 5580-0800

Roland Shanghai Electronics  
Co.,Ltd.  
(BEIJING OFFICE)  
10F. No.18 3 Section Anhuaxili  
Chaoyang District Beijing  
100011 CHINA  
TEL: (010) 6426-5050

### HONG KONG

Tom Lee Music Co., Ltd.  
Service Division  
22-32 Pun Shan Street, Tsuen  
Wan, New Territories,  
HONG KONG  
TEL: 2415 0911

### Parsons Music Ltd.

8th Floor, Railway Plaza, 39  
Chatham Road South, T.S.T,  
Kowloon, HONG KONG  
TEL: 2333 1863

### INDIA

Rivera Digitec (India) Pvt. Ltd.  
411, Nirman Kendra  
Mahalaxmi Flats Compound  
Off. Dr. Edwin Moses Road,  
Mumbai-400011, INDIA  
TEL: (022) 2493 9051

### INDONESIA

PT Citra IntiRama  
Jl. Cideng Timur No. 15J-150  
Jakarta Pusat  
INDONESIA  
TEL: (021) 6324170

### KOREA

Cosmos Corporation  
1461-9, Seocho-Dong,  
Seocho Ku, Seoul, KOREA  
TEL: (02) 3486-8855

### MALAYSIA

Roland Asia Pacific Sdn. Bhd.  
45-1, Block C2, Jalan PUJ 1/39,  
Dataran Prima, 47301 Petaling  
Jaya, Selangor, MALAYSIA  
TEL: (03) 7805-3263

### VIET NAM

Suoi Nhap Company, Ltd  
370 Cach Mang Thang Tam St.  
Dist.3, Ho Chi Minh City,  
VIET NAM  
TEL: 9316540

## PHILIPPINES

G.A. Yupango & Co. Inc.  
339 Gil J. Puyat Avenue  
Makati, Metro Manila 1200,  
PHILIPPINES  
TEL: (02) 899 9801

## SINGAPORE

SWEE LEE MUSIC  
COMPANY PTE. LTD.  
150 Sims Drive,  
SINGAPORE 387381  
TEL: 6846-3676

## TAIWAN

ROLAND TAIWAN  
ENTERPRISE CO., LTD.  
Room 5, 9th. No. 112 Chung  
Shan N. Road Sec.2, Taipei,  
TAIWAN, R.O.C.  
TEL: (02) 2561 3339

## THAILAND

Theera Music Co., Ltd.  
330 Soi Veng NakornKasem,  
New Road, Sumpantawongse,  
Bangkok 10100, THAILAND  
TEL: (02) 224-8821

## AUSTRALIA/ NEW ZEALAND

AUSTRALIA/  
NEW ZEALAND  
Roland Corporation  
Australia Pty.,Ltd.  
38 Campbell Avenue  
Dee Why West. NSW 2099  
AUSTRALIA

For Australia  
Tel: (02) 9982 8266  
For New Zealand  
Tel: (09) 3098 715

## CENTRAL/LATIN AMERICA

### ARGENTINA

Instrumentos Musicales S.A.  
Av.Santa Fe 2055  
(1123) Buenos Aires  
ARGENTINA  
TEL: (011) 4508-2700

### BARBADOS

A&B Music Supplies LTD  
12 Webster Industrial Park  
Wildely, St.Michael, Barbados  
TEL: (246)430-1100

### BRAZIL

Roland Brasil Ltda.  
Rua San Jose, 780 Sala B  
Parque Industrial San Jose  
Cotia - Sao Paulo - SP, BRAZIL  
TEL: (011) 4615 5666

### CHILE

Comercial Fancy II S.A.  
Rut.: 96.919.420-1  
Nataliel Cox #739, 4th Floor  
Santiago - Centro, CHILE  
TEL: (02) 688-9540

### COLOMBIA

Centro Musical Ltda.  
Cra 43 B No 25 A 41. Bododega 9  
Medellin, Colombia  
TEL: (574)3812529

### COSTA RICA

JUAN BANSBACH Instrumentos  
Musicales  
Ave.L. Calle 11, Apartado  
10237,  
San Jose, COSTA RICA  
TEL: 258-0211

## CURACAO

Zeelandia Music Center Inc.  
Orionweg 30  
Curacao, Netherland Antilles  
TEL:(305)5926866

## DOMINICAN REPUBLIC

Instrumentos Fernando Giraldez  
Calle Proyecto Central No.3  
Ens.La Esperilla  
Santo Domingo,  
Dominican Republic  
TEL:(809) 683 0305

## ECUADOR

Mas Musica  
Rumichaca 822 y Zaruma  
Guayaquil - Ecuador  
TEL:(593-4)2302364

## EL SALVADOR

OMNI MUSIC  
75 Avenida Norte y Final  
Alameda Juan Pablo II,  
Edificio No.4010 San Salvador,  
EL SALVADOR  
TEL: 262-0788

## GUATEMALA

Casa Instrumental  
Calzada Roosevelt 34-01,zona 11  
Ciudad de Guatemala  
Guatemala  
TEL:(502) 599-2888

## HONDURAS

Almacen Pajaro Azul S.A. de CV.  
BO.Paz Barahona  
3 Ave.11 Calle S/O  
San Pedro Sula, Honduras  
TEL: (504) 553-2029

## MARTINIQUE

Musique & Son  
Z.L. Les Mangle  
97232 Le Lamantin  
Martinique F.W.I.  
TEL: 596 596 426860

## Gigamusik SARL

10 Rte De La Folie  
97200 Fort De France  
Martinique F.W.I.  
TEL: 596 596 715222

## MEXICO

Casa Veerkamp, s.a. de cv.  
Av. Toluca No. 323, Col. Olivar  
de los Padres 01780 Mexico  
D.F. MEXICO  
TEL: (55) 5668-6699

## NICARAGUA

Bansbach Instrumentos  
Musicales Nicaragua  
Altamira D'Este Calle Principal  
de la Farmacia 5ta Avenida  
1 Cuadra al Lago #803  
Managua, Nicaragua  
TEL: (505)277-2557

## PANAMA

SUPRO MUNDIAL, S.A.  
Boulevard Andrews, Albrook,  
Panama City, REP. DE  
PANAMA  
TEL: 315-0101

## PARAGUAY

Distribuidora De  
Instrumentos Musicales  
J.E. Olear y ESQ. Manduvira  
Asuncion PARAGUAY  
TEL: (595) 21 492147

## PERU

Audionet  
Distribuciones Musicales SAC  
Juan Fanningo 530  
Miraflores  
Lima - Peru  
TEL: (511) 4461388

## TRINIDAD

AMR Ltd  
Ground Floor  
Maritime Plaza  
Bartarata Trinidad W.I.  
TEL: (868) 638 6385

## URUGUAY

Todo Musica S.A.  
Francisco Acuna de Figueroa  
1771  
C.P.: 11.800  
Montevideo, URUGUAY  
TEL: (02) 924-2335

## VENEZUELA

Instrumentos Musicales  
Allegro,C.A.  
Av.las industrias edf.Guitar  
import  
#7 zona Industrial de Turumo  
Caracas, Venezuela  
TEL: (212) 244-1122

## EUROPE

### AUSTRIA

Roland Elektronische  
Musikinstrumente HmbH.  
Austrian Office  
Eduard-Bodem-Gasse 8,  
A-6020 Innsbruck, AUSTRIA  
TEL: (0512) 26 44 260

### BELGIUM/FRANCE/ HOLLAND/ LUXEMBOURG

Roland Central Europe N.V.  
Houtstraat 3, B-2260, Oevel  
(Westerlo) BELGIUM  
TEL: (014) 575811

### CROATIA

ART-CENTAR  
Degenova 3.  
HR - 10000 Zagreb  
TEL: (1) 466 8493

### CZECH REP.

CZECH REPUBLIC  
DISTRIBUTOR S.r.o  
Votstnova 247/16  
CZ - 180 00 PRAHA 8,  
CZECH REP.  
TEL: (2) 830 20270

### DENMARK

Roland Scandinavia A/S  
Nordhavnsvej 7, Postbox 880,  
DK-2100 Copenhagen  
DENMARK  
TEL: 3916 6200

### FINLAND

Roland Scandinavia As, Filial  
Finland  
Elanonttie 5  
FIN-01510 Vantaa, FINLAND  
TEL: (09) 68 24 020

### GERMANY

Roland Elektronische  
Musikinstrumente HmbH.  
Oststrasse 96, 22844  
Norderstedt, GERMANY  
TEL: (040) 52 60090

### GREECE/CYPRUS

STOLLAS S.A.  
Music Sound Light  
155, New National Road  
Patras 26442, GREECE  
TEL: 2610 435400

### HUNGARY

Roland East Europe Ltd.  
Warehouse Area "DEPO" Pf.83  
H-2046 Torokbalint,  
HUNGARY  
TEL: (23) 511011

### IRELAND

Roland Ireland  
G2 Calmout Park, Calmout  
Avenue, Dublin 12  
Republic of IRELAND  
TEL: (01) 4294444

### ITALY

Roland Italy S. p. a.  
Viale delle Industrie 8,  
20020 Arese, Milano, ITALY  
TEL: (02) 937-78300

## NORWAY

Roland Scandinavia Avd.  
Kontor Norge  
Lilleakerveien 2 Postboks 95  
Lilleaker N-0216 Oslo  
NORWAY  
TEL: 2273 0074

## POLAND

ROLAND POLSKA SP. Z O.O.  
UL. Gibraltarska 4,  
PL-03 664 Warszawa  
POLAND  
TEL: (022) 679 4419

## PORTUGAL

Roland Iberia, S.L.  
Portugal Office  
Cais das Pedras, 8/9-1 Dto  
4050-465, Porto, PORTUGAL  
TEL: (022) 62 608 00 60

## ROMANIA

FBS LINES  
Piata Libertatii 1,  
535000 Gheorgheni,  
ROMANIA  
TEL: (066) 364 609

## RUSSIA

MuTek  
Dorozhnaya ul.3,korp.6  
117 545 Moscow, RUSSIA  
TEL: (095) 981-4967

## SLOVAKIA

DVAN Acoustic s.r.o.  
Považská 18.  
SK - 940 01 Nové Zámky  
TEL: (035) 6424 330

## SPAIN

Roland Iberia, S.L.  
Paseo Garcia Faria, 33-35  
08005 Barcelona SPAIN  
TEL: 93 493 91 00

## SWEDEN

Roland Scandinavia A/S  
SWEDISH SALES OFFICE  
Danvik Center 28, 2 tr.  
S-131 30 Nacka SWEDEN  
TEL: (08) 702 00 20

## SWITZERLAND

Roland (Switzerland) AG  
Landstrasse 5, Postfach,  
CH-4452 Zämko,  
SWITZERLAND  
TEL: (061) 927-8383

## UKRAINE

EURHYTHMICS Ltd.  
P.O.Box 37'-a  
Nedecy Str. 30  
UA - 89600 Mukachevo,  
UKRAINE  
TEL: (03131) 414-40

## UNITED KINGDOM

Roland (U.K.) Ltd.  
Atlantic Close, Swansea  
Enterprise Park, SWANSEA  
SA7 9PJ,  
UNITED KINGDOM  
TEL: (01792) 702701

## MIDDLE EAST

### BAHRAIN

Moon Stores  
No.1231&1249 Rumaytha  
Building Road 3931, Manama  
339 BAHRAIN  
TEL: 17 813 942

### IRAN

MOCO INC.  
No.41 Nike St, Dr.Shariyati Ave.,  
Roberoy Cerah Mirdamad  
Tebran, IRAN  
TEL: (021) 285-4169

### ISRAEL

Haliit P. Greenspoon & Sons  
Ltd.  
8 Retzif Ha'alia Hashnita St.  
Tel-Aviv-Yafo ISRAEL  
TEL: (03) 6823666

## JORDAN

MUSIC HOUSE CO. LTD.  
FREDDY FOR MUSIC  
P. O. Box 922846  
Amman 11192 JORDAN  
TEL: (06) 5692696

## KUWAIT

EASA HUSAIN AL-YOUSIFI  
& SONS CO.  
Abdullah Salem Street,  
Safat, KUWAIT  
TEL: 243-6399

## LEBANON

Chahine S.A.L.  
George Zeidan St., Chahine  
Bldg., Achrafieh, P.O.Box: 16-  
5857  
Beirut, LEBANON  
TEL: (01) 20-1441

## OMAN

TALENTZ CENTRE L.L.C.  
Malatan House No.1  
Al Noor Street, Ruwi  
SULTANATE OF OMAN  
TEL: 2478 3443

## QATAR

Al Emadi Co. (Badie Studio &  
Stores)  
P.O. Box 62, Doha, QATAR  
TEL: 4423-554

## SAUDI ARABIA

ADawlah Industrial  
Electronics APL  
Corniche Road, Aldossary  
Bldg., 1st Floor, Alkhabar,  
31952 SAUDI ARABIA

P.O.Box 2154, Alkhabar 31952  
SAUDI ARABIA  
TEL: (03) 898 2081

## SYRIA

Technical Light & Sound  
Center  
Rawda, Abdul Qader Zajzari St.  
Bldg. No. 21, P.O.BOX 13520,  
Damasco, SYRIA  
TEL: (011) 223-5384

## TURKEY

ZUHAL DIS TICARET A.S.  
Galip Delek Cad. No.37  
Beyoglu - Istanbul / TURKEY  
TEL: (0212) 249 85 10

## U.A.E.

Zak Electronics & Musical  
Instruments Co. L.L.C.  
Zabeel Road, Al Sherooq Bldg.,  
No. 14, Ground Floor, Dubai,  
U.A.E.  
TEL: (04) 3360715

## NORTH AMERICA

### CANADA

Roland Canada Ltd.  
(Head Office)  
5480 Parkwood Way  
Richmond B. C., V6V 2M4  
CANADA  
TEL: (604) 270 6626

### Roland Canada Ltd.

(Toronto Office)  
170 Admiral Boulevard  
Mississauga On L5T 2N6  
CANADA  
TEL: (905) 362 9707

### U. S. A.

Roland Corporation U.S.  
5100 S. Eastern Avenue  
Los Angeles, CA 90040-2938,  
U. S. A.  
TEL: (323) 890 3700

As of May 1, 2007 (ROLAND)

## For EU Countries



- UK** This symbol indicates that in EU countries, this product must be collected separately from household waste, as defined in each region. Products bearing this symbol must not be discarded together with household waste.
- DE** Dieses Symbol bedeutet, dass dieses Produkt in EU-Ländern getrennt vom Hausmüll gesammelt werden muss gemäß den regionalen Bestimmungen. Mit diesem Symbol gekennzeichnete Produkte dürfen nicht zusammen mit dem Hausmüll entsorgt werden.
- FR** Ce symbole indique que dans les pays de l'Union européenne, ce produit doit être collecté séparément des ordures ménagères selon les directives en vigueur dans chacun de ces pays. Les produits portant ce symbole ne doivent pas être mis au rebut avec les ordures ménagères.
- IT** Questo simbolo indica che nei paesi della Comunità europea questo prodotto deve essere smaltito separatamente dai normali rifiuti domestici, secondo la legislazione in vigore in ciascun paese. I prodotti che riportano questo simbolo non devono essere smaltiti insieme ai rifiuti domestici. Ai sensi dell'art. 13 del D.Lgs. 25 luglio 2005 n. 151.
- ES** Este símbolo indica que en los países de la Unión Europea este producto debe recogerse aparte de los residuos domésticos, tal como esté regulado en cada zona. Los productos con este símbolo no se deben depositar con los residuos domésticos.
- PT** Este símbolo indica que nos países da UE, a recolha deste produto deverá ser feita separadamente do lixo doméstico, de acordo com os regulamentos de cada região. Os produtos que apresentem este símbolo não deverão ser eliminados juntamente com o lixo doméstico.
- NL** Dit symbool geeft aan dat in landen van de EU dit product gescheiden van huishoudelijk afval moet worden aangeboden, zoals bepaald per gemeente of regio. Producten die van dit symbool zijn voorzien, mogen niet samen met huishoudelijk afval worden verwijderd.
- DK** Dette symbol angiver, at i EU-lande skal dette produkt opsamles adskilt fra husholdningsaffald, som defineret i hver enkelt region. Produkter med dette symbol må ikke smides ud sammen med husholdningsaffald.
- NO** Dette symbolet indikerer at produktet må behandles som spesialavfall i EU-land, iht. til retningslinjer for den enkelte regionen, og ikke kastes sammen med vanlig husholdningsavfall. Produkter som er merket med dette symbolet, må ikke kastes sammen med vanlig husholdningsavfall.
- SE** Symbolen anger att i EU-länder måste den här produkten kasserars separat från hushållsavfall, i enlighet med varje regions bestämmelser. Produkter med den här symbolen får inte kasserars tillsammans med hushållsavfall.
- FI** Tämä merkintä ilmaisee, että tuote on EU-maissa kerättävä erillään kotitalousjätteistä kunkin alueen voimassa olevien määräysten mukaisesti. Tällä merkinnällä varustettuja tuotteita ei saa hävittää kotitalousjätteiden mukana.
- HU** Ez a szimbólum azt jelenti, hogy az Európai Unióban ezt a terméket a háztartási hulladéktól elkülönítve, az adott régióban érvényes szabályozás szerint kell gyűjteni. Az ezzel a szimbóllummal ellátott termékeket nem szabad a háztartási hulladék közé dobni.
- PL** Symbol oznacza, że zgodnie z regulacjami w odpowiednim regionie, w krajach UE produktu nie należy wyrzucać z odpadami domowymi. Produktów opatrzonych tym symbolem nie można utylizować razem z odpadami domowymi.
- CZ** Tento symbol udává, že v zemích EU musí být tento výrobek sbírán odděleně od domácího odpadu, jak je určeno pro každý region. Výrobky nesoucí tento symbol se nesmí vyhazovat spolu s domácími odpady.
- SK** Tento symbol vyjadruje, že v krajinách EÚ sa musí zber tohto produktu vykonávať oddelene od domového odpadu, podľa nariadení platných v konkrétnej krajine. Produkty s týmto symbolom sa nesmú vyhazovať spolu s domovým odpadom.
- EE** See sümbol näitab, et EL-i maades tuleb see toode olemprügiti eraldi koguda, nii nagu on igas piirkonnas määratletud. Selle sümboliga märgitud tooteid ei tohi ära visata koos olmeprügiga.
- LT** Šis simbolis rodo, kad ES šalyse šis produktas turi būti surenkamas atskirai nuo buitinių atliekų, kaip nustatyta kiekviename regione. Šiuo simboliu paženklinoti produktai neturi būti išmetami kartu su buitinėmis atliekomis.
- LV** Šis simbols norāda, ka ES valstīs šo produktu jāievāc atsevišķi no mājsaimniecības atkritumiem, kā noteikts katrā reģionā. Produkts ar šo simbolu nedrīkst izmest kopā ar mājsaimniecības atkritumiem.
- SI** Ta simbol označuje, da je treba proizvod v državah EU zbirati ločeno od gospodinskih odpadkov, tako kot je določeno v vsaki regiji. Proizvoda tem znakom ni dovoljeno odlagati skupaj z gospodinskimi odpadki.
- GR** Το σύμβολο αυτό υποδηλώνει ότι στις χώρες της Ε.Ε. το συγκεκριμένο προϊόν πρέπει να συλλέγεται χωριστά από τα υπόλοιπα οικιακά απορρίμματα, σύμφωνα με όσα προβλέπονται σε κάθε περιοχή. Τα προϊόντα που φέρουν το συγκεκριμένο σύμβολο δεν πρέπει να απορρίπτονται μαζί με τα οικιακά απορρίμματα.

## For China

### 有关产品中所含有害物质的说明

本资料就本公司产品中所含的特定有害物质及其安全性予以说明。

本资料适用于 2007 年 3 月 1 日以后本公司所制造的产品。

#### 环保使用期限



此标志适用于在中国国内销售的电子信息产品，表示环保使用期限的年限。所谓环保使用期限是指在自制造日起的规定期限内，产品中所含的有害物质不致引起环境污染，不会对人体、财产造成严重的不良影响。环保使用期限仅在遵照产品使用说明书，正确使用产品的条件下才有效。不当的使用，将会导致有害物质泄漏的危险。

#### 产品中有毒有害物质或元素的名称及含量

部件名称	有毒有害物质或元素					
	铅(Pb)	汞(Hg)	镉(Cd)	六价铬(Cr(VI))	多溴联苯(PBB)	多溴二苯醚(PBDE)
外壳(壳体)	×	○	○	○	○	○
电子部件(印刷电路板等)	×	○	×	○	○	○
附件(电源线、交流适配器等)	×	○	○	○	○	○

○：表示该有毒有害物质在该部件所有均质材料中的含量均在 SJ/T11363-2006 标准规定的限量要求以下。  
 ×：表示该有毒有害物质至少在该部件的某一均质材料中的含量超出 SJ/T11363-2006 标准规定的限量要求。  
 因根据现有的技术水平，还没有什么物质能够代替它。

For EU Countries

## Apparatus containing Lithium batteries

### ADVARSEL!

Lithiumbatteri - Eksplosionsfare ved fejlagtig håndtering.  
Udskiftning må kun ske med batteri af samme fabrikat og type.  
Levér det brugte batteri tilbage til leverandøren.

### ADVARSEL

Eksplosjonsfare ved feilaktigt skifte av batteri.  
Benytt samme batteritype eller en tilsvarende type anbefalt av apparatfabrikanten.  
Brukte batterier kasseres i henhold til fabrikantens instruksjoner.

### CAUTION

Danger of explosion if battery is incorrectly replaced.  
Replace only with the same or equivalent type recommended by the manufacturer.  
Discard used batteries according to the manufacturer's instructions.

### VARNING

Explosionsfara vid felaktigt batteribyte.  
Använd samma batterityp eller en ekvivalent typ som rekommenderas av apparattillverkaren.  
Kassera använt batteri enligt fabrikantens instruktion.

### VAROITUS

Paristo voi räjähtää, jos se on virheellisesti asennettu.  
Vaihda paristo ainoastaan laitevalmistajan suosittelemaan tyyppiin. Hävitä käytetty paristo valmistajan ohjeiden mukaisesti.

For EU Countries



This product complies with the requirements of European Directive 89/336/EEC.

For the USA

## FEDERAL COMMUNICATIONS COMMISSION RADIO FREQUENCY INTERFERENCE STATEMENT

This equipment has been tested and found to comply with the limits for a Class B digital device, pursuant to Part 15 of the FCC Rules. These limits are designed to provide reasonable protection against harmful interference in a residential installation. This equipment generates, uses, and can radiate radio frequency energy and, if not installed and used in accordance with the instructions, may cause harmful interference to radio communications. However, there is no guarantee that interference will not occur in a particular installation. If this equipment does cause harmful interference to radio or television reception, which can be determined by turning the equipment off and on, the user is encouraged to try to correct the interference by one or more of the following measures:

- Reorient or relocate the receiving antenna.
- Increase the separation between the equipment and receiver.
- Connect the equipment into an outlet on a circuit different from that to which the receiver is connected.
- Consult the dealer or an experienced radio/TV technician for help.

This device complies with Part 15 of the FCC Rules. Operation is subject to the following two conditions:

- (1) this device may not cause harmful interference, and
- (2) this device must accept any interference received, including interference that may cause undesired operation.

Unauthorized changes or modification to this system can void the users authority to operate this equipment.  
This equipment requires shielded interface cables in order to meet FCC class B Limit.

For Canada

### NOTICE

This Class B digital apparatus meets all requirements of the Canadian Interference-Causing Equipment Regulations.

### AVIS

Cet appareil numérique de la classe B respecte toutes les exigences du Règlement sur le matériel brouilleur du Canada.

## Copyright

- Recording, duplication, distribution, sale, lease, performance, or broadcast of copyrighted material (musical works, visual works, broadcasts, live performances, etc.) belonging to a third party in part or in whole without the permission of the copyright owner is forbidden by law.
- This product can be used to record or duplicate audio material without being limited by certain technological copy-protection measures. This is due to the fact that this product is intended to be used for the purpose of producing original music, and is therefore designed so that material that does not infringe copyrights belonging to others (for example, your own original works) can be recorded or duplicated freely.
- Do not use this unit for purposes that could infringe on a copyright held by a third party. We assume no responsibility whatsoever with regard to any infringements of third-party copyrights arising through your use of this unit.

## About the License Agreement

- The CD-2e's CD-writing functionality, and its backing-up functionality are designed to allow you to reproduce material to which you have copyright, or material which the copyright owner has granted you permission to copy. Accordingly, reproduction of Music CD or other copyrighted material without permission of the copyright owner avoiding technical prohibiting features of second-generation and later copying like SCMS or others constitutes copyright infringement and may incur penalties even in case such reproduction is for your own personal use and enjoyment (private use). Consult a copyright specialist or special publications for more detailed information on obtaining such permission from copyright holders.



## Free Manuals Download Website

<http://myh66.com>

<http://usermanuals.us>

<http://www.somanuals.com>

<http://www.4manuals.cc>

<http://www.manual-lib.com>

<http://www.404manual.com>

<http://www.luxmanual.com>

<http://aubethermostatmanual.com>

Golf course search by state

<http://golfingnear.com>

Email search by domain

<http://emailbydomain.com>

Auto manuals search

<http://auto.somanuals.com>

TV manuals search

<http://tv.somanuals.com>