

Roland®





SOUND SPACE PROCESSOR

RSS-10

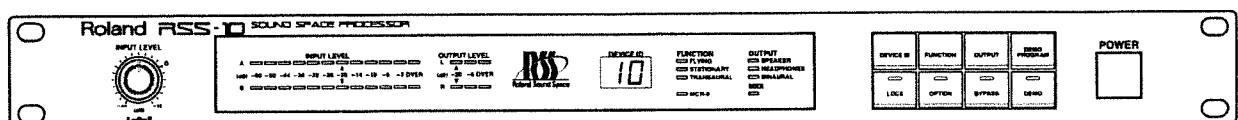
Owner's Manual



	CAUTION RISK OF ELECTRIC SHOCK DO NOT OPEN	
ATTENTION : RISQUE DE CHOC ELECTRIQUE NE PAS OUVRIR		
<p>CAUTION: TO REDUCE THE RISK OF ELECTRIC SHOCK, DO NOT REMOVE COVER (OR BACK). NO USER-SERVICEABLE PARTS INSIDE. REFER SERVICING TO QUALIFIED SERVICE PERSONNEL.</p>		



The lightning flash with arrowhead symbol, within an equilateral triangle, is intended to alert the user to the presence of uninsulated "dangerous voltage" within the product's enclosure that may be of sufficient magnitude to constitute a risk of electric shock to persons.



The exclamation point within an equilateral triangle is intended to alert the user to the presence of important operating and maintenance (servicing) instructions in the literature accompanying the product.

INSTRUCTIONS PERTAINING TO A RISK OF FIRE, ELECTRIC SHOCK, OR INJURY TO PERSONS.

IMPORTANT SAFETY INSTRUCTIONS SAVE THESE INSTRUCTIONS

WARNING - When using electric products, basic precautions should always be followed, including the following:

1. Read all the instructions before using the product.
2. Do not use this product near water — for example, near a bathtub, washbowl, kitchen sink, in a wet basement, or near a swimming pool, or the like.
3. This product should be used only with a cart or stand that is recommended by the manufacturer.
4. This product, either alone or in combination with an amplifier and headphones or speakers, may be capable of producing sound levels that could cause permanent hearing loss. Do not operate for a long period of time at a high volume level or at a level that is uncomfortable. If you experience any hearing loss or ringing in the ears, you should consult an audiologist.
5. The product should be located so that its location or position does not interfere with its proper ventilation.
6. The product should be located away from heat sources such as radiators, heat registers, or other products that produce heat.
7. The product should be connected to a power supply only of the type described in the operating instructions or as marked on the product.
8. The power-supply cord of the product should be unplugged from the outlet when left unused for a long period of time.
9. Care should be taken so that objects do not fall and liquids are not spilled into the enclosure through openings.
10. The product should be serviced by qualified service personnel when:
 - A. The power-supply cord or the plug has been damaged; or
 - B. Objects have fallen, or liquid has been spilled onto the product; or
 - C. The product has been exposed to rain; or
 - D. The product does not appear to operate normally or exhibits a marked change in performance; or
 - E. The product has been dropped, or the enclosure damaged.
11. Do not attempt to service the product beyond that described in the user-maintenance instructions. All other servicing should be referred to qualified service personnel.

For the USA

GROUNDING INSTRUCTIONS

This product must be grounded. If it should malfunction or breakdown, grounding provides a path of least resistance for electric current to reduce the risk of electric shock.

This product is equipped with a cord having an equipment-grounding conductor and a grounding plug. The plug must be plugged into an appropriate outlet that is properly installed and grounded in accordance with all local codes and ordinances.

DANGER: Improper connection of the equipment-grounding conductor can result in a risk of electric shock. Check with a qualified electrician or serviceman if you are in doubt as to whether the product is properly grounded. Do not modify the plug provided with the product — if it will not fit the outlet, have a proper outlet installed by a qualified electrician.

For the U.K.

IMPORTANT: THE WIRES IN THIS MAINS LEAD ARE COLOURED IN ACCORDANCE WITH THE FOLLOWING CODE.

BLUE: NEUTRAL
BROWN: LIVE

As the colours of the wires in the mains lead of this apparatus may not correspond with the coloured markings identifying the terminals in your plug, proceed as follows:

The wire which is coloured BLUE must be connected to the terminal which is marked with the letter N or coloured BLACK.

The wire which is coloured BROWN must be connected to the terminal which is marked with the letter L or coloured RED.

Under no circumstances must either of the above wires be connected to the earth terminal of a three pin plug.

The product which is equipped with a THREE WIRE GROUNDING TYPE LINE PLUG must be grounded.

CHECKING THE PACKAGE

Please open the RSS-10 package and check if all the following was supplied:

1. RSS-10 1
2. AC Cord 1
3. Macintosh Version Application Disk 1
4. Windows Version Application Disk 1
5. Owner's Manual for the RSS-10 1
6. Owner's Manual for RSS-FX (Macintosh version) 1
7. Owner's Manual of RSS-Stage (Macintosh version) 1
8. Owner's Manual for RSS-FX (Windows version) 1
9. Owner's Manual of RSS-Stage (Windows version) 1
10. Demonstration Play Chart (RSS-10 Demo Table) 1
11. Template for the MCR-8 1 set (2 pieces)

INTRODUCTION

Thank you, and congratulations on your choice of the Roland RSS-10 Sound Space Processor. To ensure proper operation, and years of trouble-free service, please take the time to read through this Owner's Manual before starting out.

If you are going to control the RSS-10 using the supplied applications (RSS-Stage and RSS-FX), please read the Owner's Manuals for those applications as well.

© 1995 Roland Corporation

All right reserved. No part of this publication may be reproduced in any form without the written permission of Roland Corporation.

FEATURES

Four different processors that create three-dimensional sound field are built into the RSS-10, in a 1-U size.

The RSS-10 includes four different processors: Distance Processor, Reverb Processor, Binaural Processor and Transaural Processor, which can create a realistic three-dimensional sound field.

Newly developed Binaural Processor

The newly developed Binaural Processor allows you to attain more realistic presence, and directionality for the sound source, because it simulates even the reflections from the floor surface.

RSS Reverb Processor

The Reverb Processor makes it possible to control parameters such as Room Size and Reverb Time. And, since the direction of the reflected sounds is also taken into account, you can obtain reverberation which conveys the position of the sound source.

Integrated External Control Ports

The three-dimensional sound field can be controlled with external MIDI messages. Since the RSS-10 also features a serial port, it can be controlled from a computer. It also can be controlled by the MCR-8 Multi Controller.

TABLE OF CONTENTS

CHECKING THE PACKAGE	3
INTRODUCTION.....	4
FEATURES.....	5
TABLE OF CONTENTS	6
IMPORTANT NOTES	8
POWER SUPPLY	8
PLACEMENT	8
MAINTENANCE	8
ADDITIONAL PRECAUTIONS	8
BEFORE USING DISKS	8
APPLICATIONS AND CONTROLLERS FOR THE RSS-10	9
THE OUTLINE OF THE RSS SYSTEM	10
What is the RSS System	10
Sense of movement in the RSS System	11
FUNCTION MODES	12
STATIONARY Mode	12
FLYING Mode	12
TRANSAURAL Mode	12
OUTPUT MODES	13
SPEAKER Mode	13
HEADPHONES Mode	13
BINAURAL Mode	13
DELAY MODES	14
ABSOLUTE DELAY Mode	14
RELATIVE DELAY Mode	14
PANEL DESCRIPTION.....	15
<Front Panel>	15
<Rear Panel>	15
ADJUSTING THE INPUT LEVEL.....	16

SETTING THE RSS-10	17
Changing the Device ID Numbers (1 to 64)	17
Changing the Function Modes (FLYING, STATIONARY, TRANSAURAL)	17
Changing the Output Modes (SPEAKER, HEADPHONES, BINAURAL)	17
Selecting the MCR-8 Mode	18
Lock Function (ON/OFF)	18
Bypass Function (ON/OFF)	18
Demo Play	19
Baud Rate Setting (19, 38)	20
Setting the Speaker Angle (12, 24, 30, 36, 48, 60, 72, 84)	20
HOW TO OPERATE THE RSS-10 USING THE MCR-8	21
Setting up the MCR-8	21
Initial Settings	21
Initial Settings for the RSS-10	21
Initial Settings for the MCR-8	21
Operating the RSS-10's control panel using the MCR-8	22
Changing the Function Modes	22
Changing the Output Modes	22
Demo Play	22
ON/OFF of Bypass	22
CONTROLLING THE THREE-DIMENSIONAL SOUNDS USING THE MCR-8 ..23	
Setting the Position of the Sound Source	23
CONNECTIONS	25
Example Setup 1: The easiest way to benefit from the RSS-10	25
Example Setup 2: The most practical and easiest way	26
Example Setup 3: Controlling the RSS-10 using the MCR-8	27
Example Setup 4: How to control the RSS-10 using a computer and the supplied application ..	28
Multi-track Binaural Mixing System	31
Sound FX Authoring System	31
LOCATION OF THE DEVICES AND LISTENER	32
When recorded in the Speaker Mode	32
When recorded in the Headphones Mode	34
EFFECTIVE USE OF THE RSS SYSTEM	35
Notes in monitoring	35
Sense of Sound Localization	35
When Using Effects Devices	36
MIDI Implementation Chart	38
SPECIFICATIONS	39
INDEX	40
Information	42

IMPORTANT NOTES

In addition to the items listed under Safety Precautions inside the front cover, please read and observe the following:

POWER SUPPLY

Before connecting this unit to other devices, turn off the power to all units; this will help prevent damage or malfunction.

Do not use this unit on the same power circuit with any device that will generate line noise; an electric motor or variable lighting system for example.

PLACEMENT

Using the unit near power amplifiers (or other equipment containing large power transformers) may induce hum.

This device may interfere with radio and television reception. Do not use this device in the vicinity of such receivers.

MAINTENANCE

For everyday cleaning wipe the unit with a soft, dry cloth or one that has been slightly dampened with water. To remove stubborn dirt, use a mild, non-abrasive detergent. Afterwards, be sure to wipe the unit thoroughly with a soft, dry cloth.

Never use benzene, thinners, alcohol or solvents of any kind, to avoid the possibility of discoloration and/or deformation.

ADDITIONAL PRECAUTIONS

Protect the unit from strong impact.

A small amount of heat will radiate from the unit during normal operation.

Before using the unit in a foreign country, consult with qualified service personnel.

BEFORE USING DISKS

Handling Floppy Disks

Floppy disks contain a magnetic storage medium (much like magnetic recording tape). Please observe the following when handling floppy disks:

- Never touch the magnetic medium inside the disk.
- Do not subject floppy disks to temperature extremes (eg., direct sunlight in an enclosed vehicle). Recommended temperature range: 10 to 50°C.
- Do not expose floppy disks to strong magnetic fields, such as those generated by loudspeakers.

Floppy disks contain a 'write protect' tab which can protect the disk from accidental erasure. It is recommended that the tab be kept in the 'PROTECT' position and moved to the 'WRITE' position only when you wish to write new data onto the disk.

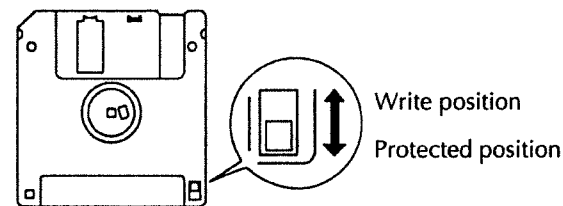

All important data should be copied onto backup disk(s). This provides a complete duplicate of the data should the original disk(s) be lost or damaged.

The identification label should be firmly fixed to the disk. Should the label come loose while the disk is in the drive, it may be difficult to remove the disk.

Put the disk back into its case for storage.

APPLICATIONS AND CONTROLLER FOR THE RSS-10

The RSS-10 is a component that can create a three-dimensional sound field. To make the best use of the RSS-10, it is supplied with two software applications (RSS-Stage and RSS-FX), and a template that is provided for using the optional Multi Controller MCR-8.

Using the supplied RSS-Stage application, you can control up to sixteen RSS-10s at the same time. This enables multitrack binaural mixing, with the localized sound images of up to 32 channels on an assumed stage. We believe that it provides new possibilities for recording engineers who have been dissatisfied with conventional types controlled by volume or pan. It is also possible to convert binaural signals to stereo signals using the RSS-10.

Another application, RSS-FX, allows you to use up to four RSS-10s and control the movement of the four MIDI sound modules in real-time. For example, it can faithfully reproduce the take-off sound of a jet plane, or the sound of a mosquito flying around. It should prove to be a great help for sound effects specialists who have had difficulties finding the most appropriate effect sound from a library, and have been dissatisfied with the quality.

The RSS-10 contains demonstration data which makes use of the effects of the RSS system. There are 99 different demonstrations. Interesting special effects sounds can easily be created using these demonstrations, or together with another MIDI device.

Using the optional Multi Controller MCR-8, almost all the functions featured in the RSS-10 can be controlled without using a computer. The movement window of a sound source, however, cannot be programmed.

To make a program that controls the RSS-10 from a computer via serial ports, you need to purchase the RSS-10 Programmers Kit.

THE OUTLINE OF THE RSS SYSTEM

What is the RSS System

To reproduce three-dimensional sounds in the RSS System, the directions are controlled with "Azimuth" and "Elevation," and the sense of distance is controlled with the "Distance" parameter. Sound created by this method is what is known as Binaural sound. Binaural sound is sound recorded using a dummy-head microphone. When you hear Binaural sound through headphones, it sounds so realistic, it seems as if you were actually listening to the performance at the place where it was recorded. This, however, would not sound as realistic if played by a stereo speaker system. The RSS-10 can convert Binaural sound to a format that can be listened to with an equivalent amount of realism and presence even when played by a stereo speaker system.

The sound we normally hear allows us to perceive the distance from the sound source because it is a combination of two different types of sounds—the direct sound that reaches our ears directly, and the reflected sound, which reaches us after reflecting off various objects. This can be easily demonstrated by the fact that you cannot sense the distance at all when hearing sound in an anechoic chamber (where no reverberation at all occurs). To reproduce a reflecting sound, you must consider the actual conditions in the room, and simulate how the things in the room will affect the sound reflections. The processing speed of today's computers, however, cannot handle this. The RSS System produces a sense of distance for the sound by assuming that you hear the sound over an imaginary floor, at a certain height.

Sense of movement in the RSS System

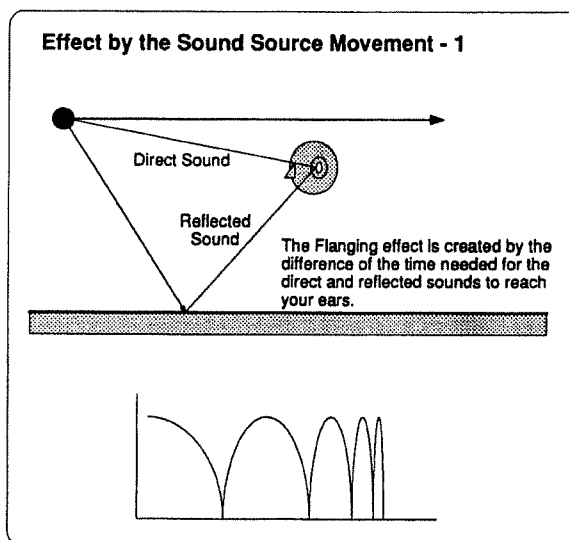

The sound reflected from the floor reaches your ears slightly later than the direct sound. The mixed sound of the direct sound and the slightly delayed reflected sound will have a unique tone. Actually, the sounds we hear are such sounds. If you try to hear some sound in a room with your head moving up and down, you can notice the change of the sound. The same effect can be recognized by the taking off sound of a jet plane. This is called the flanging effect, and it can be created in the RSS System.

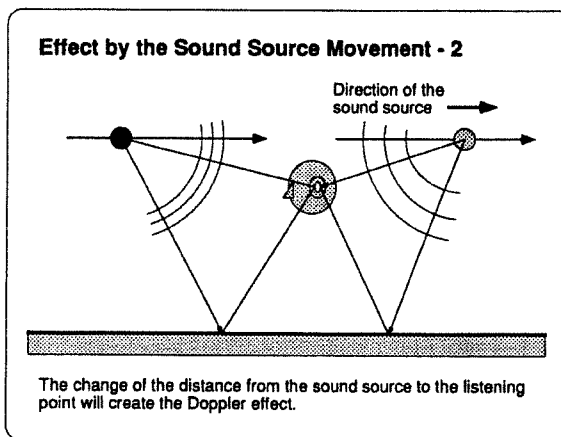

A Doppler effect is created by moving the sound source. For example, imagine that an ambulance is passing by in front of you. As it comes closer, the siren will sound higher, yet it will suddenly sound lower when it has gone away. This is called the Doppler effect. The Doppler effect, however, cannot be noticed clearly when the sound source is moving slowly. The RSS System allows you to add the Doppler effect according to the movement of the sound source.

FUNCTION MODES

The RSS-10 features the following three Function Modes.

STATIONARY Mode

This mode is for positioning the sound image to a certain place. One RSS-10 can position three-dimensional sound images for two channels. Using the supplied RSS-Stage, up to 16 RSS-10s can be controlled at the same time. That is, 32 channels worth of sound images can be positioned at certain places on an assumed stage.

**** In the Stationary Mode, if you move the sound image positions while entering a sound, noise may be heard. This is quite natural and is not the sign of trouble.***

FLYING Mode

This mode is for moving the sound image in real-time. By using one RSS-10, one channel of three-dimensional sound image can be shifted. Using the supplied RSS-FX, up to 4 RSS-10s can be controlled at the same time, allowing the shifting of 4 channels of sound according to the specified curve.

TRANSAURAL Mode

This mode is for converting the Binaural sound to the format that matches the playback device. This mode, therefore, is used for converting the Binaural sound recorded with a dummy-head microphone or created by using the RSS-10 to the speaker playback format. The output format is determined by the Output Mode.

OUTPUT MODES

You can select one of the three Output Modes that determine the format of the signal to be output through the Output Jack on the RSS-10.

SPEAKER Mode

This mode allows you to output the signal in the format for normal stereo speaker playback.

HEADPHONES Mode

This mode allows you to output the signal in the format for headphone playback. The binaural sound can be heard as three-dimensional sound through headphones even when being output in the Binaural Mode. To obtain an enhanced effect, however, you should output in the Headphones Mode.

BINAURAL Mode

In this mode, the Binaural sound will be output as is.

**** The Binaural sound is the basic signal format handled in the RSS System. Once the Binaural sound is converted to signals for stereo speakers or stereo headphones, it cannot be returned to the original Binaural sound. Therefore, you should save the three-dimensional sound created in the RSS System while it is in the Binaural sound format.***

DELAY MODES

You can select whether or not to use the Doppler effect.

ABSOLUTE DELAY Mode

If you want the Doppler effect to occur by moving the sound source, select the ABSOLUTE DELAY Mode. When this mode is selected, the delay time added to the sound will differ depending on the distance between the sound source and your ears. The change of the sound pitch caused by the Doppler effect will also differ.

RELATIVE DELAY Mode

If you do not want the Doppler effect to occur by moving the sound source, select the RELATIVE DELAY Mode. When this mode is selected, no delay is caused in the sound.

PANEL DESCRIPTION

<Front Panel>

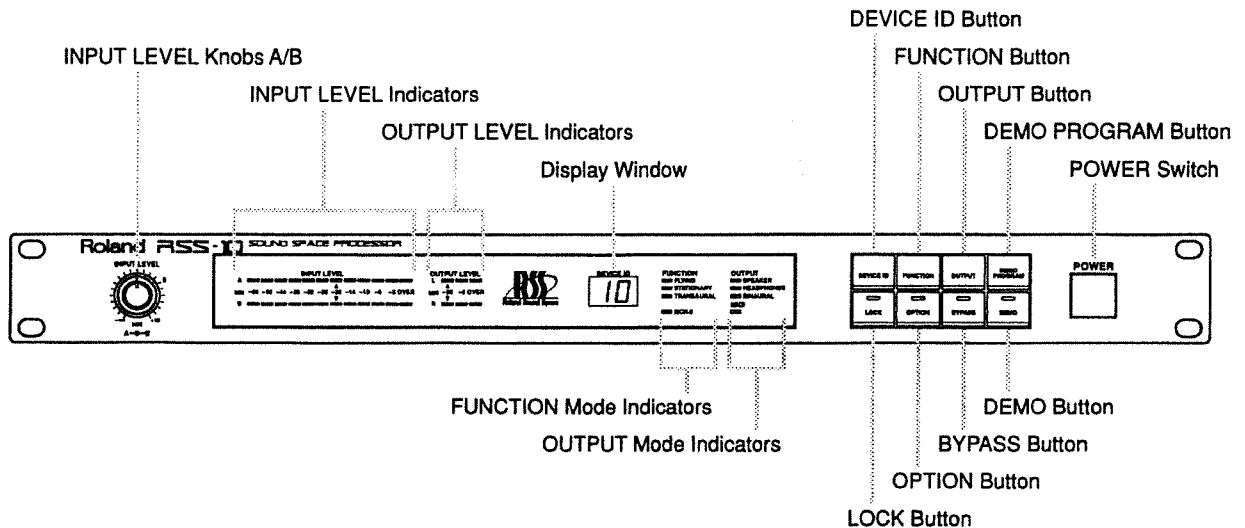

<Rear Panel>

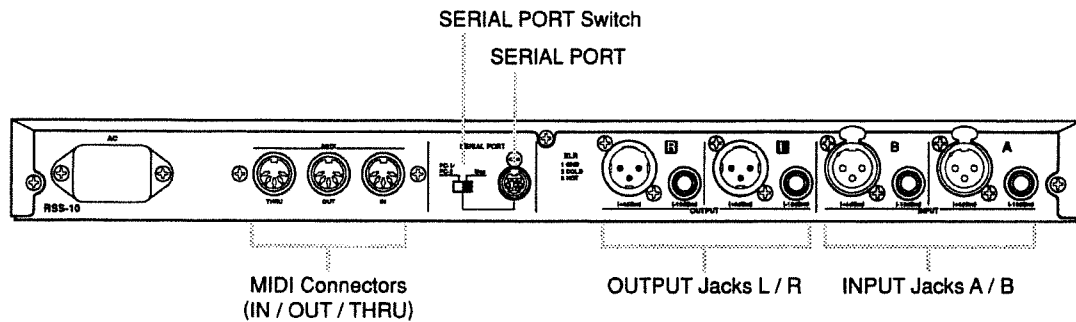

*** The following shows the pinout for the XLR Connectors. To set up an external unit with the RSS-10, check the pin assignments for the unit.**

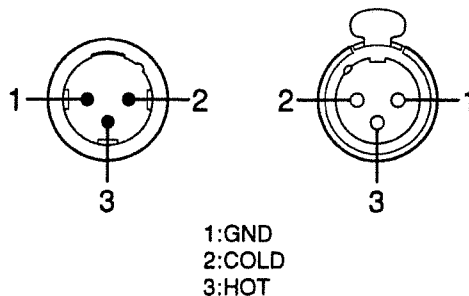

ADJUSTING THE INPUT LEVEL

Feed a signal into the RSS-10, then set the Input Level Knobs so that "OVER" in the Input Level Indicators and the Output Level Indicators are just short of lighting. The Input Level Knobs allow you to control the right and left channels independently.

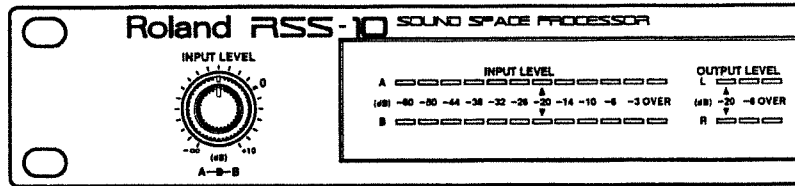

<NOTE>

The Input Level Indicators indicate the input level of the internal processor and can be adjusted using the Input Level Knobs. The Output Level Indicators indicate the output level of the internal processor. The output level will differ depending on the directions of the sound sources, or the depth of the reverb effect, so you must be careful about the input level adjustment.

SETTING THE RSS-10

The RSS-10 allows you to set the following functions.

** In the following description, the buttons on the panel are enclosed with [] such as [DEVICE ID].*

Changing the Device ID Numbers (1 to 64)

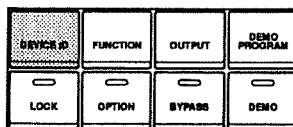

The Device ID Numbers are for distinguishing RSS-10s — by applications on a computer, such as RSS-Stage or RSS-FX. You must set the numbers to match those set for the application. To change the Device ID numbers, press [DEVICE ID]. Pressing the button will increase the number (1 comes after 64).

The number you set here will remain stored even after the RSS-10 is switched off.

Changing the Function Modes (FLYING, STATIONARY, TRANSAURAL)

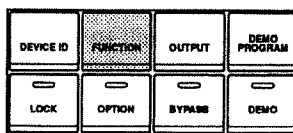

You can see the current Function Mode by means of the Function Mode Indicators. To change the Function Modes, press [FUNCTION]. Pressing the button will call the modes in sequence.

** For details on the Function Modes, see "FUNCTION MODES" on page 12.*

Changing the Output Modes (SPEAKER, HEADPHONES, BINAURAL)

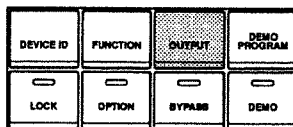

You can see the current Output Mode in the Output Mode Indicators. To change the Output Modes, press [OUTPUT]. Pressing the button will call the Output Modes in sequence.

** For details on the Output Modes, see "OUTPUT MODES" on page 13.*

Selecting the MCR-8 Mode

To control the RSS-10 with the Multi Controller MCR-8, select the MCR-8 Mode by taking the following procedure. To cancel the MCR-8 Mode, simply repeat the same procedure. The mode you select here will be retained even when the RSS-10 is switched off.

** The MRC-8 Mode has been preprogrammed from the manufacturer.*

(PROCEDURE)

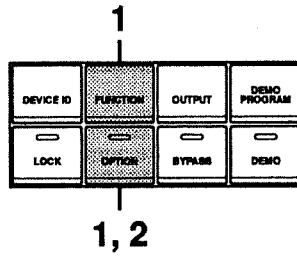

1. Press [OPTION] and make sure that the indicator is lit. Then press [FUNCTION] once. "MCR-8" in the Function Mode Indicators will light, showing that the RSS-10 is set to the MCR-8 Mode, and is controllable with the MCR-8.
2. Press [OPTION], and the indicator will go out. The indicator will go out after a few seconds, even without pressing [OPTION].

Lock Function (ON/OFF)

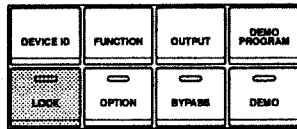

The Lock function is provided to protect the current settings on the panel from the accidental loss that may occur through pressing buttons by mistake. When the Lock function is turned on, the current settings will not change even by pressing the other buttons.

To turn on the Lock function, press [LOCK] for more than two seconds. The indicator will be lit and the current setting will be locked.

To turn off the Lock function, press [LOCK] again for more than two seconds. The indicator will go out.

Bypass Function (ON/OFF)

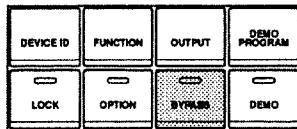

If you wish to output an exact copy of the signal input to the RSS System, turn on the Bypass function. To turn on the Bypass function, simply press [BYPASS]. When the Bypass function is turned on, the indicator will be lit. To turn off the Bypass function, press the button again.

Demo Play

The RSS-10 provides 99 different demonstrations. Each demonstration contains settings or actions created by the RSS System. By playing the demonstration data for the special effect sounds, or together with a different MIDI device, you can easily create very interesting effects. The demonstrations can be started by receiving Note On messages.

** For details on the effect of each Demonstration, see [Demonstration Play Chart (RSS-10 Demo Table)] (on a different sheet).*

<Using a MIDI Keyboard>

Demonstration effects can be applied at the right moments while playing a keyboard.

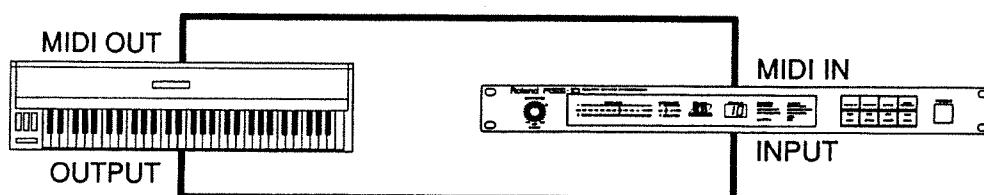

While you press a key on a MIDI keyboard, the specified demo effect can be obtained. For example, if you select [Helicopter Sound] on the MIDI keyboard, then select a demonstration which has the image to move from the right to the left, you can obtain an effect whereby a helicopter seems to fly by, from right to left.

(PROCEDURE)

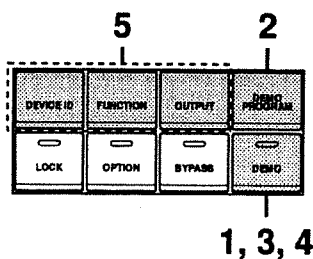

1. Press [DEMO].
The indicator of the button flashes and the Demo Mode is selected. The Display Window shows the current Demo Number.
2. To select a different Demo Number, press [DEMO PROGRAM].
Each time you press the button, the Demo Numbers will be called in sequence.
3. Press [DEMO], and the indicator lights and the demonstration will start.
4. To stop the demonstration, press [DEMO].
5. To leave the Demo Play mode, press [DEVICE ID], [FUNCTION] or [OUTPUT] button.

Baud Rate Setting (19, 38)

To connect an external device to the Serial Port on the RSS-10, you must set the Baud Rate (speed for data transfer) so it is compatible with the external device being connected. The Baud rate was set to 38.4 kbps on the RSS-10 when it was shipped. To change it to 19.2 kbps, perform the following procedure. The baud rate you set here will be retained even when the RSS-10 is switched off.

(PROCEDURE)

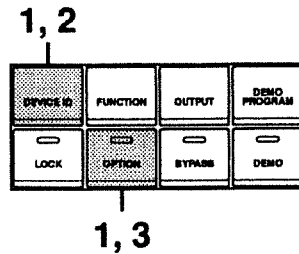

1. Press [OPTION] and make sure that the indicator is lit. Then press [DEVICE ID] once. The current baud rate is shown in the Display Window.
2. While the baud rate is being displayed, press [DEVICE ID] to change to a different baud rate.
3. Press [OPTION], and the indicator will go out. The indicator will go out after waiting for a few seconds, even without pressing [OPTION].

Setting the Speaker Angle (12, 24, 30, 36, 48, 60, 72, 84)

When the Output Mode is set to SPEAKER, you can set the speaker angle of the RSS-10 depending on the angle of the speakers location. The value represents the extent of the angle from the listening position to the center position and the speaker. The default is 30 degrees. If you wish to set a different angle, do as follows. The angle you set here will be retained even while the RSS-10 is switched off.

(PROCEDURE)

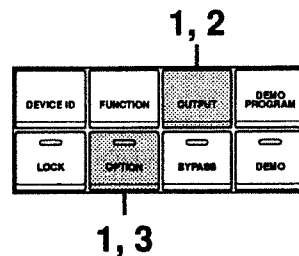

1. Press [OPTION] and make sure that the indicator is lit. Then press [OUTPUT] once. The speaker angle currently selected is shown in the Display Window.
2. Press [OUTPUT] to change to the desired speaker angle.
3. Press [OPTION], and the indicator will go out. The indicator will go out after a few seconds, even without pressing [OPTION].

HOW TO OPERATE THE RSS-10 USING THE MCR-8

By connecting the Multi Controller MCR-8 (optional) to the RSS-10, the RSS-10 can be controlled using the MCR-8. To use the MCR-8, read the following explanation carefully.

** The RSS-10 comes with a Template that shows how the controller of the MCR-8 correspond to the parameters of the RSS-10. You can put the Template on the MCR-8.*

Setting up the MCR-8

To set up the MCR-8 to the RSS-10, do as follows:

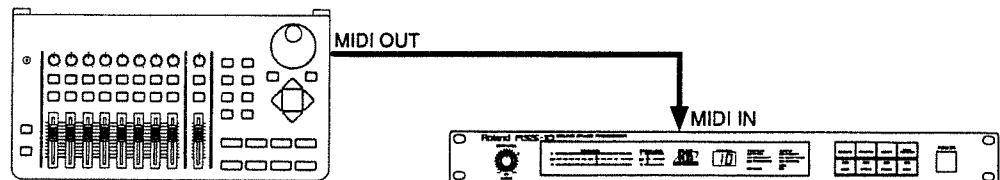

Initial Settings

To control the RSS-10 from the MCR-8, set each device as follows:

Initial Settings for the RSS-10

Function Mode Setting

Set the Function Mode on the RSS-10 to "MCR-8 Mode."

** You do not need to change the Serial Port Switch and Baud Rate.*

Initial Settings for the MCR-8

Setting the Computer Switch

Set the Computer Switch on the MCR-8 to "MIDI."

Setting the Mode Switch

Set the Mode Switch on the MCR-8 to "MODE 4."

Operating the RSS-10's control panel using the MCR-8

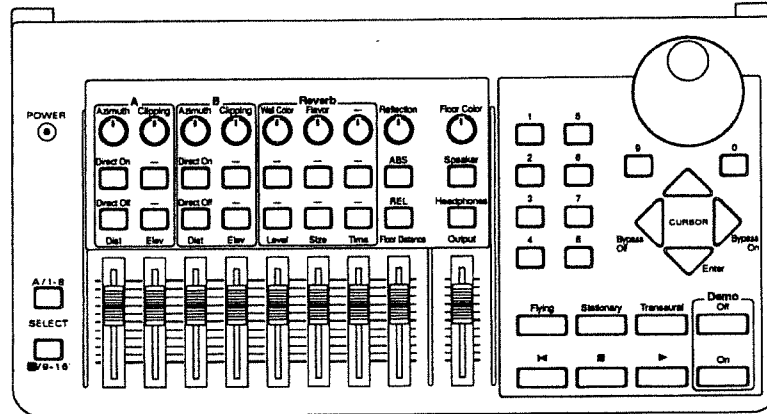

Changing the Function Modes

Change the Function Modes using [Flying], [Stationary] and [Transaural] buttons.

Changing the Output Modes

Change the Output Modes using [Speaker] and [Headphones] buttons.

Demo Play

To play demonstration data, press [Demo On] to turn to the Demo Play mode. To return to the Function Mode, press [Demo Off].

To change Demo Numbers, use [F1-F8, DEC, INC] as 0-9 numerical keys. First, specify the number, then press [Enter].

To start playing the demonstration data you have selected, press [PLAY (▶)].

To stop playing, press [STOP (■)].

To reset to the beginning of the demonstration play, press [RESET (◀)].

*** If you stop playing with [STOP (■)] then press [PLAY (▶)], the demonstration will resume from where it was stopped.**

ON/OFF of Bypass

The Bypass function can be turned on or off using the [Bypass On] and [Bypass Off] buttons.

CONTROLLING THE THREE-DIMENSIONAL SOUNDS USING THE MCR-8

The parameters that control three-dimensional sounds correspond to the knobs/sliders/buttons on the MCR-8 as follows. Please move the knob/slider/button that corresponds to the parameter you wish to control.

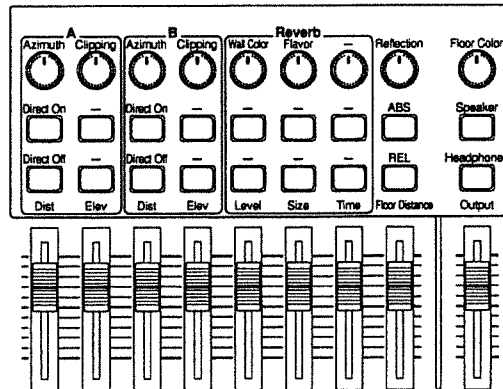

Setting the Position of the Sound Source

The position of the sound source can be set with the directions and distance. The STATIONARY Mode allows you to set two positions A and B separately, while the FLYING Mode allows only channel A.

1-1 Dist (Distance) (the distance to the sound source)

This sets the distance from the ear position to the sound source. The changes in the distance that occur as a result of the fader's movement are predetermined.

1-2 Elev (Elevation) (the upper and lower directions of the sound source)

This sets the upper and lower directions (180° vertically) from the ear position to the sound source.

1-3 Azimuth (Azimuth) (horizontal directions of the sound source)

This sets the horizontal directions (360° horizontally) from the ear position to the sound source.

1-4 Direct On/Off (Direct On/Off) (On/Off of the direct sound, including the floor reflection)

This turns on or off the direct sound, including the floor reflection, but leaves the reverberation unaffected.

1-5 Clipping (Clipping Area)

Theoretically speaking, as the sound source is moved closer to your ears, the sound will be infinitely louder. This, however, is impossible in reality. The volume is set so there is a limit, beyond which it will not become higher even though the sound source has become closer. The area with a radius at this distance is called the Clipping Area. A shorter radius will make the volume of the sound much smaller even by removing the sound source only slightly from your ears. If most sounds are at a distance, the overall volume may be too low. If this happens, you must make the Clipping Area larger.

1-6 Level (Reverb Level)

This sets the ratio of the reverberation to the direct sound. Normally, set the fader to its maximum or slightly lower than that.

1-7 Size (Room Size)

The Room Size is the approximate size of the space where the sound will reverberate. Set it to suit your taste as you listen to the sound.

<Note>

The Reverb Time is restricted depending on the Room Size selected. If the current Reverb Time exceeds the maximum range by changing the Room Size, the Reverb Time will be automatically changed to the highest or lowest value of the maximum range. For example, if the Room Size is set to 100 m, the Reverb Time will be restricted to above 1.0 second. When the Room Size is 1 m, the Reverb Time will be restricted to lower below 4.0 seconds.

1-8 Time (Reverb Time)

Reverb Time is the approximate time for the sound to start reverberating until it fades out. Adjust it to suit your taste as you actually listen to the sound.

<NOTE>

The Reverb Time is restricted to a certain time depending on the Room Size selected. However, if the Reverb Time exceeds the maximum level of the current Room Size, the setting of the Room Size will be automatically changed.

1-9 Wall Color (Wall Color)

Wall Color simulates the tonal changes in a sound that occur while sound reflected from walls is reverberating. Set it to suit your taste while you actually listen to the sound.

1-10 Flavor (Flavor Type)

Flavor Type is a parameter related to the reverb tone. When you input various sounds created from the same source into several RSS-10s and mix them, the reverberant sounds may interfere with each other and produce an odd sound orientation. Should this occur, set the Flavor Type on each RSS-10 to a different value. The Flavor Type changes the tone only subtly, and therefore will have no effect if you adjust it in situations other than the above.

1-11 Floor Distance (Floor Distance)

This determines the distance from your ears to the sound source.

1-12 Floor Color (Floor Color)

The tone of the sound reflected from a floor differs depending on the material of the floor. Set it to suit your taste.

1-13 Reflection (Reflection) (Coefficient of the floor reflection)

This sets the ratio of the floor reflection. Set it to suit your taste.

1-14 ABS/REL (Delay Mode) (Delay Mode)

This sets the Delay Mode. For details, see "DELAY MODES" on page 14.

1-15 (Speaker) (Headphone) (Output Mode)

This sets the Output Mode. For details, see "OUTPUT MODES" on page 13.

1-16 (Output) (Output Level)

This sets the output level. Normally, it should be set to its maximum.

CONNECTIONS

The RSS-10 can be set up in various ways depending on how you wish to use the system or what devices (scale) you wish to use in the total system. The following shows example setups.

** To connect other RSS-10s using the MIDI THRU connector on the RSS-10, do not use more than four units. If you wish to connect more than four RSS-10s, use the ROLAND MIDI PATCHER /MIXER A-880 (optional), etc.*

Example Setup 1 The easiest way to benefit from the RSS-10

What to prepare:

RSS-10
Sound Source (e.g., CD player)
Amplifier
Speakers

Connections

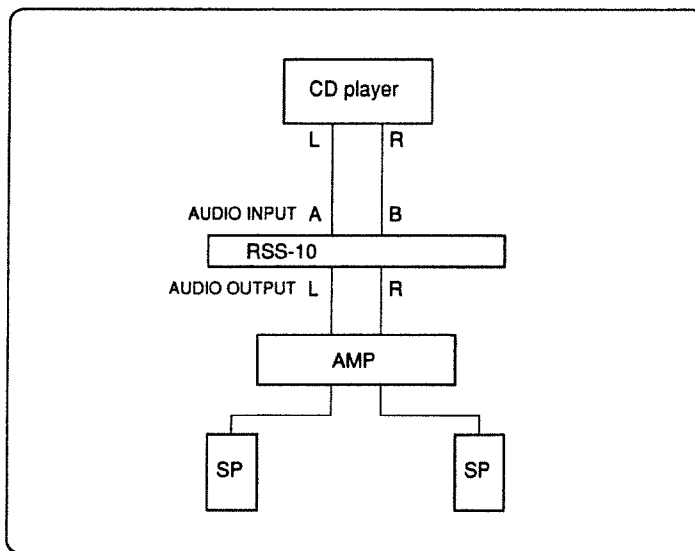

Basic Operational Test

1. When you have finished all the necessary setups, turn down the volume on the amplifier, then switch on the units.
2. Switch on the Bypass Button on the RSS-10 (the indicator is lit).
3. Play the sound source and adjust the Input Level Knob as you watch the Input Level Indicators on the RSS-10.
4. Increase the volume of the amplifier slowly to adjust the volume. The sound being played here has no effect.
5. Turn off the Bypass Button on the RSS-10. The created sound takes on reverberations just like the one in a large hall. This is the sound of the default settings.

Procedure

Press the Demo Button then select a Demo Program. Press the Demo Button again to start the demonstration.

You can try various actions by following the Demo Play procedure on page 19. Refer to the supplied "Demonstration Play Chart (RSS-10 Demo Table)."

Example Setup 2 The most practical and easiest way

What to prepare

RSS-10
S-760 (S-770, S-750 or SP-700 will do)
CD-ROM Drive
Amplifier
Speakers

Connections

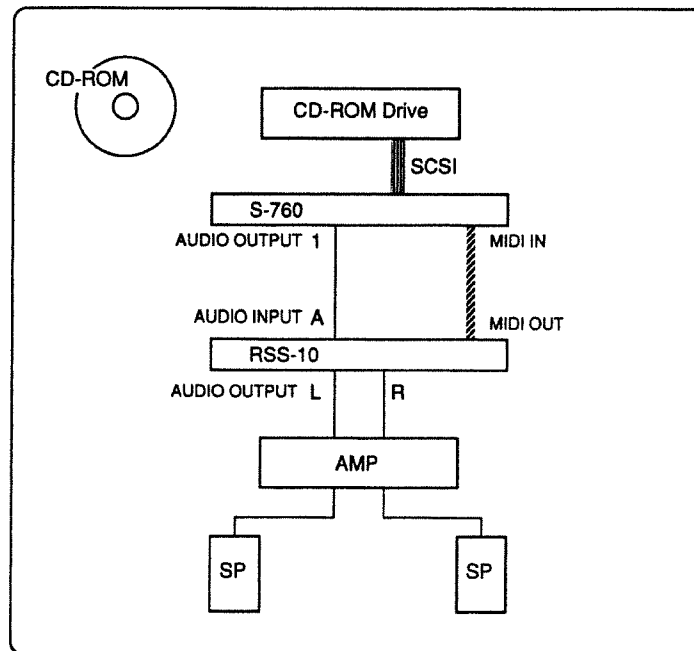

Procedure

1. When you have finished all the necessary setups, turn down the volume of the amplifier, then switch on the units.
2. Load "SFX DEMO" into the S-760 sampler, then set it to the Performance Mode. (Read the S-760's owner's manual).
3. Set the Input Level Knob of the RSS-10 to the basic point (0) provisionally.
4. Select a Demo Program, then press the Demo Button to start playing the demonstration.
5. Increase the volume of the amplifier slowly and set the desired volume.
6. As you watch the Input Level Indicators on the RSS-10, adjust the Input Volume.

You can try various actions by following the Demo Play procedure on page 19. Refer to the supplied "Demonstration Play Chart (RSS-10 Demo Table)."

Example Setup 3 Controlling the RSS-10 using the MCR-8

What to prepare

In addition to those prepared for Example Setup 1 or 2,

MCR-8
Supplied Template for the MCR-8

Connections

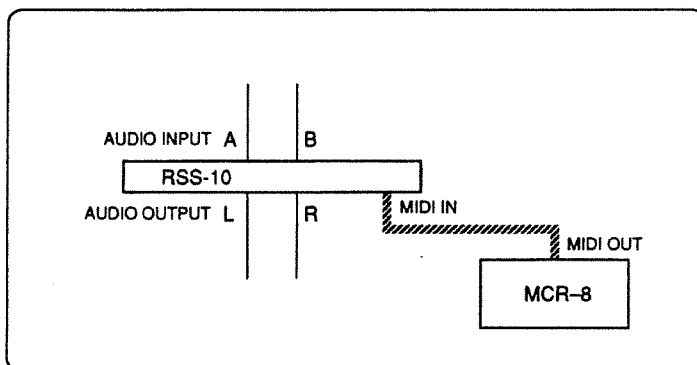

Basic Operational Test

1. When you have finished all the necessary connections, turn down the volume of the amplifier, then switch on the units.
2. Make sure that the indicator of MCR-8 on the panel of the RSS-10 is lit. The MCR-8 should be set to Mode 4. (See the owner's manual of the MCR-8).
3. Put the Template for the MCR-8 onto the MCR-8, then press any button. For example, pressing the Function Mode Selection button on the MCR-8 will automatically change the indicators on the RSS-10 accordingly.

Procedure

Now, you can control the RSS-10 using the MCR-8. For a detailed explanation, see "HOW TO OPERATE THE RSS-10 USING THE MCR-8" on page 21.

Example Setup 4 How to control the RSS-10 using a computer and the supplied application

What to prepare

In addition to what was prepared for Example Setup 1 or 2,
Apple Macintosh computer or a computer compatible with Microsoft Windows
Connection cable for the computer and RSS-10 or MIDI Interface and MIDI cable

There are two methods for connecting the computer to the RSS-10. One is via MIDI and the other is through the Serial Port.

To connect via MIDI, you must prepare the specific interface for the computer you use. To connect through the Serial Port, you need a connection cable.

Connection cables are optionally available: RSC-15AT (IBM compatible), RSC-15N (NEC), and RSC-15APL (Macintosh).

Connections

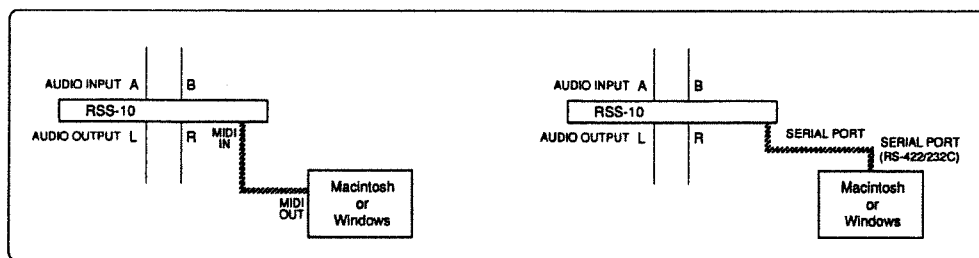

Basic Operational Test

1. When you have finished all the necessary connections, turn down the volume of the amplifier then switch on the units.
2. Install the supplied application and re-boot the system.
3. Some sample files are stored on the supplied disk. Open one of them.
4. Using the application, get the MIDI Indicator on the RSS-10 to start flashing.
5. Adjust the volume of the amplifier, then follow the owner's manual of the application.

There are various ways for connecting a computer to the RSS-10 as follows:

To connect directly with a Macintosh computer

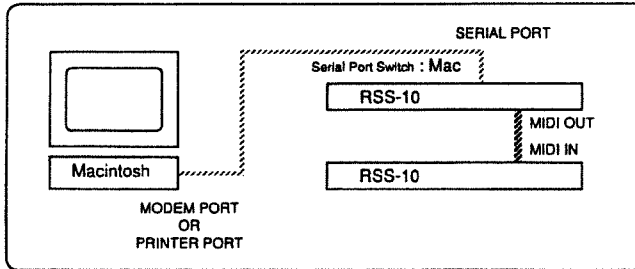

To connect the Macintosh via a MIDI Interface

This type of connection is used for synchronizing to a video device with time code. The MIDI interface to be used for this connection should support the use of SMPTE time code.

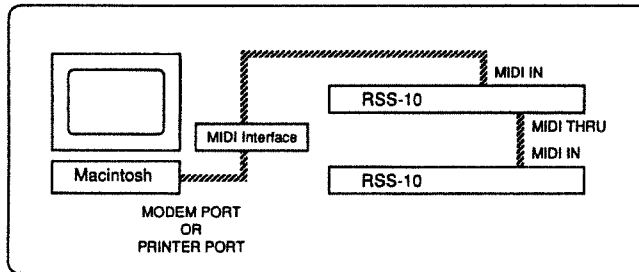

To connect a Windows computer

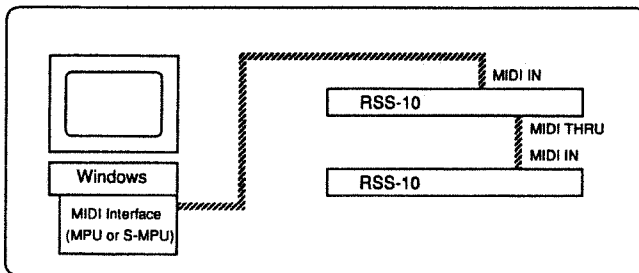

For this connection, you need a MIDI processing unit of the Roland MPU Series or S-MPU series. You need the S-MPU for synchronization to a video device with time code.

<Multi-track Binaural Mixing System>

The following shows a setup example for controlling several RSS-10s using the RSS-Stage application. This setup allows you to place the individual sounds while connected to each RSS-10 separately.

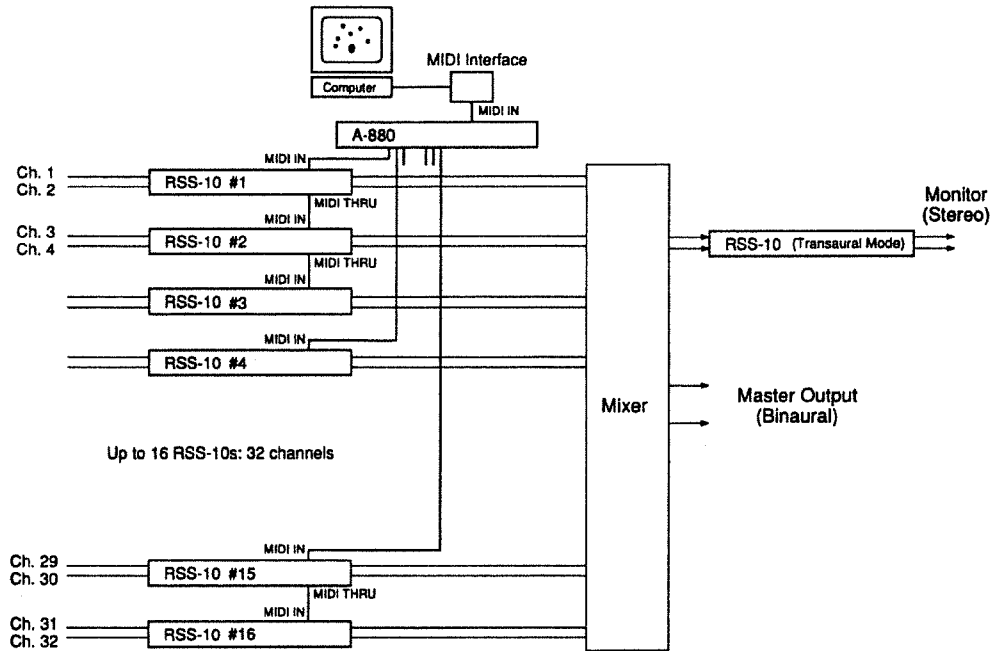

<Sound FX Authoring System>

The following shows an example setup for controlling four RSS-10s at the same time, using the RSS-FX application. You can sync them to the video picture.

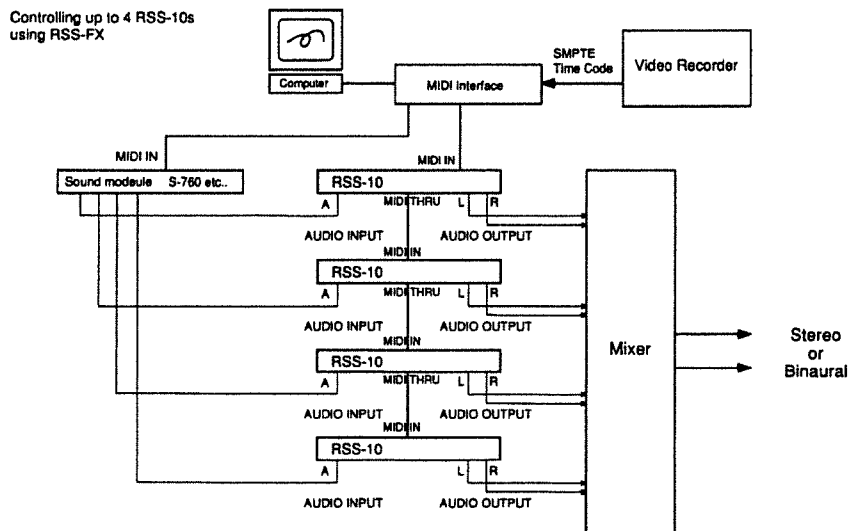

LOCATION OF THE DEVICES AND LISTENER

For the listener to hear the three-dimensional sound created by the RSS System as you have intended, it is important to specify an appropriate environment for the listener. When making the packages for a CD, video, multi-media title or game, make sure that the following precautions are shown in a prominent location.

When recorded in the Speaker Mode



For Stereo Speakers

This sound is made to be played specifically through speakers.
The proper effect cannot be obtained if listened to through headphones.

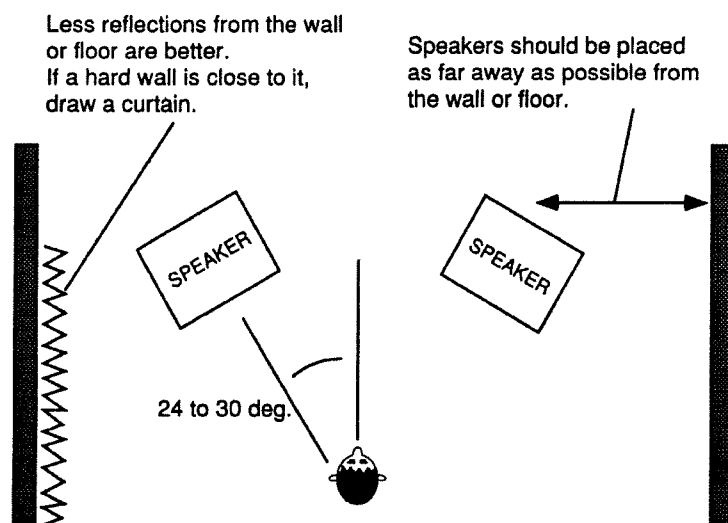

The following shows best, good and bad location examples for the RSS System.

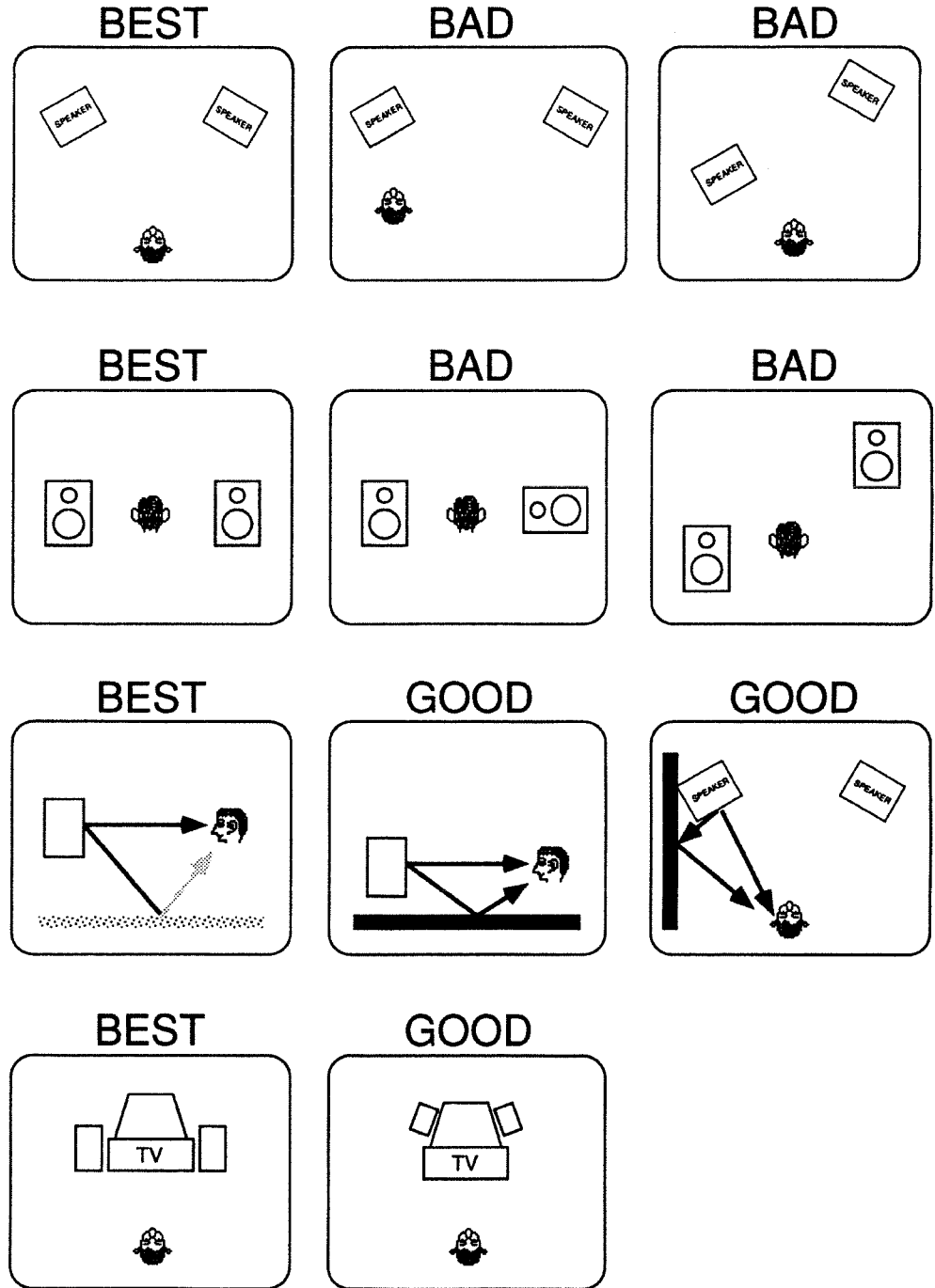

When recorded in the Headphone Mode



This sound has been made specifically for playing through headphones.
You cannot obtain the proper effect if listening through speakers.



EFFECTIVE USE OF THE RSS SYSTEM

The RSS System allows you to obtain 3D sounds without using any extra playback equipment. However, to make the best use of the system, various conditions may be required as follows.

Notes in monitoring

The results you can attain from the RSS System vary depending on the monitoring system you use, or its location. While using the system, please pay attention to the following points.

<When monitoring through speakers>

A non-reverberant control room is suitable for use with the RSS System.

The ideal speaker system for the RSS System is the single way type or multi-way type with a coaxial or virtual coaxial design that focuses the sound image to one point.

Be sure to monitor the sound at the sweet spot of the RSS System.

Speakers with broad diffusion characteristics provide a wider sweet spot.

The sense of sound localization from the rear direction differs depending on the listener.

<Monitoring using headphones>

The sound localization to the distant front cannot be perceived clearly.

Sense of the Sound Localization

The RSS System simulates how people perceive positioning within the sound field. The actual impression of the sound localization differs depending on the tone of the sound, sound image direction, etc. Also, perception will widely vary depending on the listener. The following explains how the sound location can be perceived under different conditions, and explains the effective way of using the RSS System for various situations.

<Impression of the sound localization caused by tone difference>

The different impression of the sound localization is dependent not only on the nature of the RSS System, but also on the nature of human beings. For instance, it is more difficult for a person to perceive the location of lower frequency sounds at the upper direction, while it is difficult to perceive higher frequency sounds at a lower direction. Also, the sound localization of the source of sine waves or sounds with fewer harmonic contents cannot be clearly perceived.

Experimentation will confirm these findings.

<Sound Localization from the rear>

Sounds located in the front or back can be recognized through the difference in the frequency response, and therefore the sounds located behind the listener will be perceived differently depending on the individual. In particular, for sounds located straight back, there is a conspicuous amount of difference between individuals.

It may be effective to create the sensation of diagonal motion when working with sounds to be located behind the listener.

<Sound Localization Above and Below>

The sound located above and below the listener is highly subjective, because it is recognized through the difference in frequency response. This appears to be especially true of the sound localization of the front-center upper and lower directions.

The reverberation characteristics of the control room also affect the perception of the sound localization to upper and lower directions, when you are monitoring through speakers. Using headphones eliminates the effect of any room conditions.

To accurately hear the sound localization to the upper or lower directions, it may be effective to use sustained sounds, such as strings, and move the sound occasionally.

The impression of the sound localization to the upper or lower direction is again affected by the tone of the sound. Careful experimentation should help you learn it.

<Time Required for Sound Localization>

It requires a certain amount of time for a person to recognize the sound positioning.

Moving the sound position quickly will create an effect that is quite different from that intended by the RSS System.

** When you operate the RSS System using a sequencer, take the above into consideration.*

<Multiple Sound Sources>

The sense of sound localization is also affected by the number of sound sources. For instance, even if you cannot hear the position of one sound clearly, you may hear it when several sounds are mixed together. This may be especially helpful when positioning sound above or below the listener.

When sound sources that share similar frequency contents (such as vocal and flute) are mixed and delivered to the front and back, or right and left, the sounds will interrupt each other, and the sense of sound localization will be lost.

<Sound and Space>

Spacious sounds cannot be successfully produced by placing the same sound in different positions.

To create simulated stereophonic sound, use a chorus or reverb device, and then place the right and left sounds at different positions.

Spaciousness can also be created by placing similar sounds (e.g., synth strings and strings) in different positions. Again, however, this will blur the sense of sound localization.

<Note on Localizing a Stereo Sound Source>

The RSS System basically controls the sound localization of monophonic sources. When the right and left signals of a stereophonic sound source are placed in two different positions, a spacious sound will be created. However, this again will blur the sense of sound localization.

That is, placing the stereo sounds to the two symmetrical positions will not localize the sound between the two positions. This is because human beings can symmetrically recognize the sound location to the right and left directions but it is not so to the upper and lower or front and rear directions.

When Using Effects Devices

When effects devices are used with the RSS System, the sound position created by the system may change. Please note the following:

<How to Connect Effects Devices>

Use an effects device that is applied to the original sound (e.g., distortion, limiter, compressor or pitch shifter) prior to the RSS System.

When an effects device is connected after the RSS System, set the effect parameters for both left and right channels to the same settings.

<Using a Sampler>

Even if the sound output from the RSS System is recorded into a stereo sampler, the effect of the RSS System can be faithfully reproduced. If, however, you edit the recorded sound or use the key transpose function, the effect will be lost.

Some types of samplers feature a phase data controlling function that controls phase during sampling. If you are using this kind of sampler, do not use this function.

<Recording Using a Dummy Head>

An appropriate dummy head for recording is one that features a flat frequency response for sound coming from the front. If you use a different type, create a flat frequency response using an equalizer.

You can mix the sound recorded using a dummy head with the binaural sound created by the RSS System without experiencing any problems.

MIDI Implementation Chart

Function**		Transmitted	Recognized	Remarks
Basic Channel	Default Changed	1 *1 x	x x	
Mode	Default Messages Altered	x x *****	x x	
Note Number	True Voice	0 - 127 *1 *****	0 - 127 *2	
Velocity	Note ON Note OFF	1 - 127 *1 o *1	1 - 127 *2 0 - 127 *2	
After Touch	Key's Ch's	x x	x x	
Pitch Bend		x	x	
Control Change	0 - 119 120 121	x x x	*3	All Sound Off Reset All Controllers
Prog Change	True #	*1 *****	x	
System Exclusive		x	*4	
System Common	Song Pos Song Sel True	x x x	x x x	
System Real Time	Clock Commands	x x	x x	
AUX Messages	Local ON/OFF All Notes OFF Active Sense Reset	x o (123) x x	x x x x	
Notes	*1: Since these settings are stored permanently in internal ROM, they cannot be altered. *2: These messages are used solely for starting/stopping the demonstration data in Demo mode. *3: These messages are compatible with Mode 4 on the MCR-8. *4: You can find detailed explanation about these matters in the RSS-10 Developer's Kit (optionally available). For detained information on MIDI data of the RSS-10, a separate "MIDI Implementation document" is available at any Roland Service Station.			

Mode 1 : OMNI ON, POLY
Mode 3 : OMNI OFF, POLY

Mode 2 : OMNI ON, MONO
Mode 4 : OMNI OFF, MONO

o : Yes
x : No

SPECIFICATIONS

RSS-10: SOUND SPACE PROCESSOR

Frequency Response

20 Hz to 20 kHz -3/+1 dB

Nominal Input Level

Unbalanced Input: -10 dBm (head room: 20 dB)

Balanced Input: +4 dBm (head room: 20 dB)

Input Impedance

Unbalanced Input: 10 k Ω

Balanced Input: 10 k Ω

Nominal Output Level

Unbalanced Output: -10 dBm (head room: 20 dB)

Balanced Output: +4 dB (head room: 20 dB)

Output Impedance

Unbalanced Output: 600 Ω

Balanced Output: 200 Ω

Distance

81 m (1 cm step)

655 m (8 cm step)

352 m (8 cm step in Absolute mode)

Dynamic Range

100 dB or greater (IHF-A)

Display Window

7 segments, 2 lines (LED)

Connectors

Input Jacks A/B (1/4 inch phone type)

Input Jacks A/B (XLR-3-31 type)

Output Jacks L/R (1/4 inch phone type)

Output Jacks L/R (XLR-3-32 type)

Serial Port

MIDI Connectors (IN, OUT, THRU)

AC IN Connector

Power

AC 120, 220 or 240 V

Consumption

19 W

Dimensions

482 (W) X 340 (D) X 44 (H) mm

19 (W) x 13-7/16 (D) x 1-3/4 (H) inches

(EIA-1U rack mount type)

Accessories

RSS-10

AC Cord

Macintosh Version Application Disk

Windows Version Application Disk

Owner's Manual for the RSS-10

Owner's Manual for RSS-FX (Macintosh Version)

Owner's Manual for RSS-Stage (Macintosh Version)

Owner's Manual for RSS-FX (Windows Version)

Owner's Manual for RSS-Stage (Windows Version)

Demo Play Table (RSS-10 Demo Table)

Template for the MCR-8: 1 set (2 sheets)

Option

Multi Controller MCR-8

** 0 dBm = 0.775 Vrms*

** The specifications are subject to change without notice.*

INDEX

A

Absolute Delay Mode	14
Azimuth	10, 23

B

Baud Rate	20
Binaural	17
Binaural Mode	13
Binaural sound	12
Bypass	18, 22
Bypass Button	15
Bypass Function	18
Bypass Off	22
Bypass On	22

C

Clipping Area	23
Coefficient of the floor reflection	24

D

Delay Mode	14, 24
Demo	19
Demo Button	15
Demo Off	22
Demo On	22
Demo Play	19, 22, 26
Demo Program Button	15
Device ID	17
Device ID Button	15
Direct On/Off	23
Direct sound	10
Distance	10, 23
Doppler effect	11, 14
Dummy-head	12

E

Elevation	10, 23
-----------------	--------

F

Flavor Type	24
Flanging effect	11
Floor Color	24
Floor Distance	24
Flying	17, 22
Flying Mode	12
Function	17
Function Button	15
Function Modes	17, 22
Function Mode Indicators	15

H

Headphones	17, 22
Headphones Mode	13, 34
Headphone playback	13
Horizontal directions	23

I

Input	15
Input Level	16
Input Level Indicators	15
Input Level Knobs	15

L

Lock	18
Lock Button	15
Lock Function	18

M

MCR-8	21
MCR-8 Mode	18
MIDI Connectors	15
Movement	11

O

Option Button	15
Output	15, 17
Output Button	15
Output Level	25
Output Level Indicators	15
Output Mode	13, 15, 20, 22, 25
Output Mode Indicators	15
Over	16

P

Play	22
------------	----

R

Reflection	24
Relative Delay Mode	14
Reset	22
Reverb Level	23
Reverb Time	24
Room Size	24

S

sense of distance	10
Serial Port	15, 20
Serial Port Switch	15
Speaker	17, 20, 22
Speaker Angle	20
Speaker Mode	13, 32
Speaker playback	13
Stationary	17, 22
Stationary Mode	12
Stop	22

T

Transaural	17, 22
Transaural Mode	12

U

Upper and lower directions	23
----------------------------------	----

W

Wall Color	24
------------------	----

MEMO

Information

When you need repair service, call your local Roland Service Station or the authorized Roland distributor in your country as shown below.

U. S. A.

Roland Corporation U.S.
7200 Dominion Circle
Los Angeles, CA. 90040-
3696, U. S. A.
TEL: (213) 685 5141

CANADA

Roland Canada Music Ltd.
(Head Office)
5480 Parkwood Way
Richmond B. C., V6V 2M4
CANADA
TEL: (604) 270 6626

Roland Canada Music Ltd.
(Montreal Office)
9425 Transcanadienne
Service Rd. N., St Laurent,
Quebec H4S 1V3, CANADA
TEL: (514) 335 2009

Roland Canada Music Ltd.
(Toronto Office)
346 Watline Avenue,
Mississauga, Ontario L4Z
1X2, CANADA
TEL: (416) 890 6488

AUSTRALIA

Roland Corporation
Australia Pty. Ltd.
38 Campbell Avenue
Dee Why West. NSW 2099
AUSTRALIA
TEL: (02) 982 8266

NEW ZEALAND

Roland Corporation
(NZ) Ltd.
97 Mt. Eden Road, Mt. Eden,
Auckland 3, NEW
ZEALAND
TEL: (09) 3098 715

UNITED KINGDOM

Roland (U.K.) Ltd.
Rye Close Ancells Business
Park Fleet, Hampshire GU13
8UY, UNITED KINGDOM
TEL: (0252) 816181

Roland (U.K.) Ltd.,

Swansea Office
Atlantic Close, Swansea
Enterprise Park, Swansea,
West Glamorgan SA79FJ,
UNITED KINGDOM
TEL: (0792) 700 139

IRELAND

The Dublin Service
Centre Audio
Maintenance Limited
11 Brunswick Place Dublin 2
Republic of Ireland
TEL: (01) 677322

ITALY

Roland Italy S. p. A.
Viale delle Industrie 8 20020
ARESE MILANO ITALY
TEL: (02) 93581311

SPAIN

Roland Electronics
de España, S. A.
Calle Bolivia 239 08020
Barcelona, SPAIN
TEL: (93) 308 1000

GERMANY

Roland Elektronische
Musikinstrumente
Handelsgesellschaft mbH.
Oststrasse 96, 22844
Norderstedt, GERMANY
TEL: (040) 52 60090

FRANCE

Guillard Musiques Roland
ZAC de Rosarge Les Echets
01700
MIRIBEL FRANCE
TEL: (72) 26 5060

Guillard Musiques Roland
(Paris Office)
1923 rue Léon Geoffroy
94400 VITRY-SUR-SEINE
FRANCE
TEL: (1) 4680 86 62

BELGIUM/HOLLAND/ LUXEMBOURG

Roland Benelux N. V.
Houtstraat 1 B-2260 Oevel-
Westerlo BELGIUM
TEL: (014) 575811

DENMARK

Roland Scandinavia A/S
Langebrogade 6 Box 1937
DK-1023 Copenhagen K.
DENMARK
TEL: 31 95 31 11

SWEDEN

Roland Scandinavia A/S
Danvik Center 28 A, 2 tr.
S-131 30 Nacka SWEDEN
TEL: (08) 702 0020

NORWAY

Roland Scandinavia
Avd. Kontor Norge
Lilleakerveien 2 Postboks 95
Lilleaker N-0216 Oslo 2
NORWAY
TEL: (02) 73 0074

FINLAND

Fazer Musik Inc.
Länsituulentie POB 169,
SF-02101 Espoo FINLAND
TEL: (00) 43 5011

SWITZERLAND

Roland (Switzerland) AG
Musitronic AG
Gerberstrasse 5, CH-4410
Liestal, SWITZERLAND
TEL: (061) 921 1615

AUSTRIA

E. Dematte & Co.
Neu-Rum Siemens-Strasse 4
A-6040 Innsbruck P.O.Box
83
AUSTRIA
TEL: (0512) 26 44 260

GREECE

V. Dimitriadis & Co. Ltd.
20, Alexandras St. &
Bouboulinas 54 St. 106 82
Athens, GREECE
TEL: (01) 8232415

PORTUGAL

Caius - Tecnologias
Audio e Musica , Lda.
Rue de Catarina 131
4000 Porto, PORTUGAL
TEL: (02) 38 4456

HUNGARY

Intermusica Ltd.
Warehouse Area 'DEPO'
Pt.83 H-2046 Torokbalint,
Budapest HUNGARY
TEL: (1) 1868905

ISRAEL

D.J.A. International Ltd.
Twin Towers, 33 Jabntinsky St.
Room 211, Ramat Gan 52511
ISRAEL
TEL: (03) 751 8585

CYPRUS

Radex Sound
Equipment Ltd.
17 Diagorou St., P.O.Box
2046, Nicosia CYPRUS
TEL: (2) 453 426
(2) 466 423

U.A.E

Zak Electronics &
Musical Instruments Co.
P.O. Box 8050
2046, Nicosia CYPRUS
DUBAI, U.A.E
TEL: 360715

KUWAIT

Easa Husain Al-Yousifi
P.O. Box 126 Safat 13002
KUWAIT
TEL: 5719499

LEBANON

A. Chahine & Fils
P.O. Box 16-5857
Beirut, LEBANON
TEL: (01) 335799

TURKEY

Barkat Sanayi ve Ticaret
Siraselviler Cad. 86/6
Taksim Istanbul, TURKEY
TEL: (0212) 2499324

EGYPT

Al Fanny Trading Office
9, Ebn Hagar Ai Askalany
Street, Ard El Golf,
Heliopolis, Cairo, 11341
EGYPT
TEL: (02) 4171828
(02) 4185531

QATAR

Badie Studio & Stores
P.O.Box 62,
DOHA Qatar
TEL: 423554

SYRIA

Technical Light &
Sound Center
Khaled Ebn Al Walid St.
P.O.Box 13520
Damascus - Syria
TEL: (11) 2235 384

BAHRAIN

Moon Stores
Bad Al Bahrain Road,
P.O.Box 20077
State of Bahrain
TEL: 211 005

REUNION

FO - YAM Marcel
25 Rue Jules MermanZL
Chaudron - BP79 97491
Ste Clotilde REUNION
TEL: 262 28 29 16

BRAZIL

Roland Brasil Ltda.
R. Coronel Octaviano da
Silveira 203 05522-010
Sao Paulo BRAZIL
TEL: (11) 843 9377

MEXICO

Casa Veerkamp, s.a. de
c.v.
Mesones No. 21 Col. Centro
MEXICO D.F. 06080
TEL: (905) 709 3716

La Casa Wagner de
Guadalajara s.a. de c.v.
Av. Corona No. 202 5.j.
Guadalajara, Jalisco
MEXICO C.P.44100
TEL: (36) 13 1414

VENEZUELA

Musicland Digital C.A.
Av. Francisco de Miranda,
Centro Parque de Cristal,
Nivel C2 Local 20 Caracas
VENEZUELA
TEL: (2) 285 9218

PANAMA

Productos Superiores,
S.A.
Apartado 655 - Panama 1
REP. DE PANAMA
TEL: 26 3322

ARGENTINA

Instrumentos Musicales
S.A.
Florida 638
(1005) Buenos Aires
ARGENTINA
TEL: (1) 394 4029

HONG KONG

Tom Lee Music Co., Ltd.
Service Division
22-32 Pun Shan Street, Tsuen
Wan, New Territories,
HONG KONG
TEL: 852 2 737 7688

KOREA

Cosmos Corporation
Service Station
261 2nd Floor Nak-Won
Arcade Jong-Ro ku, Seoul,
KOREA
TEL: (02) 742 8844

SINGAPORE

Swee Lee Company
BLOCK 231,
Bain Street #03-23
Bras Basah Complex,
Singapore 0718
TEL: 3367886

CRISTOFORI MUSIC

PTE LTD
335, Joo Chiat Road
SINGAPORE 1542
REPUBLIC OF SINGAPORE
TEL: 3450435

PHILIPPINES

G.A. Yupanco & Co. Inc.
339 Gil J. Puyat Avenue
Makati, Metro Manila 1200,
PHILIPPINES
TEL: (02) 817 0013

THAILAND

Theera Music Co., Ltd.
330 Verng Nakorn Kasern,
Soi 2, Bangkok 10100,
THAILAND
TEL: (02) 2248821

MALAYSIA

Bentley Music SDN BHD
No.142, Jalan Bukit Bintang
55100 Kuala Lumpur,
MALAYSIA
TEL: (03) 2443333

INDONESIA

PT CITRARAMA
BELANTIKA
Kompleks Perkantoran Duta
Merlin Blok E No.6—7
Jl. Gajah Mada No.3—5,
Jakarta 10130,
INDONESIA
TEL: (021) 3850073

TAIWAN

Siruba Enterprise
(Taiwan) Co., LTD.
Room. 5, 9fl. No. 112 Chung
Shan N.Road Sec.2 Taipei,
TAIWAN, R.O.C.
TEL: (02) 571 5860

SOUTH AFRICA

That Other Music Shop
(PTY) Ltd.
11 Melle Street (Cnr Melle
and Juta Street)
Braamfontein 2001
Republic of South Africa
TEL: (011) 403 4105

Paul Bothner (PTY) Ltd.
17 Werdmuller Centre
Claremont 7700
Republic of South Africa
TEL: (021) 64 4030

As of Feb. 23, 1995

Bescheinigung des Herstellers/Importeurs

Hiermit wird bescheinigt, daß der/die/das

Sound Space Processor RSS-10

(Gerät, Typ, Bezeichnung)

in Übereinstimmung mit den Bestimmungen der BMPT-Amtsbl/Vfg 243/1991, 46/1992 funk-entstört ist.

Der vorschriftsmäßige Betrieb mancher Geräte (z. B. Meßsender) kann allerdings gewissen Einschränkungen unterliegen. Beachten Sie deshalb die Hinweise in der Bedienungsanleitung.

Dem Zentralamt für Zulassungen im Fernmeldewesen wurde das Inverkehrbringen dieses Gerätes angezeigt und die Berechtigung zur Überprüfung der Serie auf die Einhaltung der Bestimmungen eingeräumt.

Roland Corporation

4-16 Dojimahama 1-Chome Kita-ku Osaka 530 Japan

(Name und Anschrift des Herstellers/Importeurs)

FEDERAL COMMUNICATIONS COMMISSION RADIO FREQUENCY INTERFERENCE STATEMENT

This equipment has been tested and found to comply with the limits for a Class B digital device, pursuant to Part 15 of the FCC Rules. These limits are designed to provide reasonable protection against harmful interference in a residential installation. This equipment generates, uses, and can radiate radio frequency energy and, if not installed and used in accordance with the instructions, may cause harmful interference to radio communications. However, there is no guarantee that interference will not occur in a particular installation. If this equipment does cause harmful interference to radio or television reception, which can be determined by turning the equipment off and on, the user is encouraged to try to correct the interference by one or more of the following measures:

- Reorient or relocate the receiving antenna.
- Increase the separation between the equipment and receiver.
- Connect the equipment into an outlet on a circuit different from that to which the receiver is connected.
- Consult the dealer or an experienced radio/TV technician for help.

Unauthorized changes or modification to this system can void the users authority to operate this equipment.
This equipment requires shielded interface cables in order to meet FCC class B Limit.

CLASS B

NOTICE

This digital apparatus does not exceed the Class B limits for radio noise emissions set out in the Radio Interference Regulations of the Canadian Department of Communications.

CLASSE B

AVIS

Cet appareil numérique ne dépasse pas les limites de la classe B au niveau des émissions de bruits radioélectriques fixés dans le Règlement des signaux parasites par le ministère canadien des Communications.

 Roland®

00780501

UPC

00780501



1098:

RSS-10

Roland Corporation

00780501 '95-3-A3-11SE

Free Manuals Download Website

<http://myh66.com>

<http://usermanuals.us>

<http://www.somanuals.com>

<http://www.4manuals.cc>

<http://www.manual-lib.com>

<http://www.404manual.com>

<http://www.luxmanual.com>

<http://aubethermostatmanual.com>

Golf course search by state

<http://golfingnear.com>

Email search by domain

<http://emailbydomain.com>

Auto manuals search

<http://auto.somanuals.com>

TV manuals search

<http://tv.somanuals.com>