

TOTAL PERCUSSION PAD SPD-20

OWNER'S MANUAL

Thank you, and congratulations on your choice of the SPD-20 Total Percussion Pad. The SPD-20 is an electronic percussion unit that has eight pads, trigger interfaces, a high-quality digital sound generator, and on-board digital effects.

Since the SPD-20 includes a sound generator and effects in one lightweight, compact package, you can use it anywhere, anytime. A wide variety of options (pads, pedals, drum stand, etc.) are available, allowing you to easily create a custom drum kit. By adding sequencers or samplers, you can take advantage of the possibilities of MIDI percussion.

The SPD-20 provides the flexibility and expandability that will be appreciated by every percussionist, from beginner to professional.

About the Symbols in This Manual

Words or symbols enclosed in [square brackets] indicate panel buttons or controls.

For example, [LAYER] signifies the Layer button.

Items marked by **MEMO** are supplementary explanations.

Items headed by **NOTE** explain important points concerning the operation of your SPD-20.



Items preceded by **HINT** give you useful tips and information regarding the use of the SPD-20.

Before using this unit, carefully read the sections entitled: "USING THE UNIT SAFELY" and "IMPORTANT NOTES" (Owner's manual p. 2; p. 6). These sections provide important information concerning the proper operation of the unit. Additionally, in order to feel assured that you have gained a good grasp of every feature provided by your new unit, Owner's manual should be read in its entirety. The manual should be saved and kept on hand as a convenient reference.







USING THE UNIT SAFELY

INSTRUCTIONS FOR THE PREVENTION OF FIRE, ELECTRIC SHOCK, OR INJURY TO PERSONS

About  WARNING and  CAUTION Notices

 WARNING	Used for instructions intended to alert the user to the risk of death or severe injury should the unit be used improperly.
 CAUTION	Used for instructions intended to alert the user to the risk of injury or material damage should the unit be used improperly. * Material damage refers to damage or other adverse effects caused with respect to the home and all its furnishings, as well to domestic animals or pets.

About the Symbols

	The  symbol alerts the user to important instructions or warnings. The specific meaning of the symbol is determined by the design contained within the triangle. In the case of the symbol at left, it is used for general cautions, warnings, or alerts to danger.
	The  symbol alerts the user to items that must never be carried out (are forbidden). The specific thing that must not be done is indicated by the design contained within the circle. In the case of the symbol at left, it means that the unit must never be disassembled.
	The  symbol alerts the user to things that must be carried out. The specific thing that must be done is indicated by the design contained within the circle. In the case of the symbol at left, it means that the power-cord plug must be unplugged from the outlet.



ALWAYS OBSERVE THE FOLLOWING

WARNING

- Before using this unit, make sure to read the instructions below, and the Owner's Manual. 



- Do not open (or modify in any way) the unit or its AC adaptor. 

- Do not attempt to repair the unit, or replace parts within it (except when this manual provides specific instructions directing you to do so). Refer all servicing to your retailer, the nearest Roland Service Center, or an authorized Roland distributor, as listed on the "Information" page. 

- Never use or store the unit in places that are: 
 - Subject to temperature extremes (e.g., direct sunlight in an enclosed vehicle, near a heating duct, on top of heat-generating equipment); or are 
 - Damp (e.g., baths, washrooms, on wet floors); or are
 - Humid; or are
 - Dusty; or are
 - Subject to high levels of vibration.



- When using the unit with a rack or stand recommended by Roland, the rack or stand must be carefully placed so it is level and sure to remain stable. If not using a rack or stand, you still need to make sure that any location you choose for placing the unit provides a level surface that will properly support the unit, and keep it from wobbling. 

WARNING

- Be sure to use only the AC adaptor supplied with the unit. Also, make sure the line voltage at the installation matches the input voltage specified on the AC adaptor's body. Other AC adaptors may use a different polarity, or be designed for a different voltage, so their use could result in damage, malfunction, or electric shock.  

- Avoid damaging the power cord. Do not bend it excessively, step on it, place heavy objects on it, etc. A damaged cord can easily become a shock or fire hazard. Never use a power cord after it has been damaged. 

- This unit, either alone or in combination with an amplifier and headphones or speakers, may be capable of producing sound levels that could cause permanent hearing loss. Do not operate for a long period of time at a high volume level, or at a level that is uncomfortable. If you experience any hearing loss or ringing in the ears, you should immediately stop using the unit, and consult an audiologist. 

- Do not allow any objects (e.g., flammable material, coins, pins); or liquids of any kind (water, soft drinks, etc.) to penetrate the unit.  

WARNING

- Immediately turn the power off, remove the AC adaptor from the outlet, and request servicing by your retailer, the nearest Roland Service Center, or an authorized Roland distributor, as listed on the "Information" page when:
 - The AC adaptor or the power-supply cord has been damaged; or
 - Objects have fallen into, or liquid has been spilled onto the unit; or
 - The unit has been exposed to rain (or otherwise has become wet); or
 - The unit does not appear to operate normally or exhibits a marked change in performance.
- In households with small children, an adult should provide supervision until the child is capable of following all the rules essential for the safe operation of the unit.
- Protect the unit from strong impact. (Do not drop it!)
- Do not force the unit's power-supply cord to share an outlet with an unreasonable number of other devices. Be especially careful when using extension cords—the total power used by all devices you have connected to the extension cord's outlet must never exceed the power rating (watts/amperes) for the extension cord. Excessive loads can cause the insulation on the cord to heat up and eventually melt through.
- Before using the unit in a foreign country, consult with your retailer, the nearest Roland Service Center, or an authorized Roland distributor, as listed on the "Information" page.

CAUTION

- The unit and the AC adaptor should be located so their location or position does not interfere with their proper ventilation.
- Always grasp only the plug or the body of the AC adaptor when plugging into, or unplugging from, an outlet or this unit.
- Whenever the unit is to remain unused for an extended period of time, disconnect the AC adaptor.
- Try to prevent cords and cables from becoming entangled. Also, all cords and cables should be placed so they are out of the reach of children.
- Never climb on top of, nor place heavy objects on the unit.
- Never handle the AC adaptor body, or its plugs, with wet hands when plugging into, or unplugging from, an outlet or this unit.
- Before moving the unit, disconnect the AC adaptor and all cords coming from external devices.
- Before cleaning the unit, turn off the power and unplug the AC adaptor from the outlet (p. 12).
- Whenever you suspect the possibility of lightning in your area, disconnect the AC adaptor from the outlet.

Table of Contents

USING THE UNIT SAFELY.....	2
How to Use This Manual.....	5
Important Notes	6
Main Features of the SPD-20.....	7
Panel Descriptions.....	8
Attaching the SPD-20 to a Drum Stand.....	10
Using the Slit Tape (Included).....	10
How to Restore the Factory Settings (System Initialize).....	11

CHAPTER 1 Quick Start

Connection to Audio Equipment.....	12
Playing the Pads	12
Turning the Power On	12
Turning the Power Off.....	13
Adjusting the Volume	13
Selecting a Patch	14
What is a Patch?	14
Using a Footswitch to Select Patches	15
Comparing Layered Sounds.....	15
What is a Pad Bank?	16
What is the Layer Function?.....	17

CHAPTER 2 Using the SPD-20 by Itself

About the SPD-20's Internal Setup and Parameter	
Settings (Edit).....	18
What Kind of Instrument is the SPD-20?	18
Internal Organization.....	18
Play Mode and Edit Mode.....	19
How to Edit.....	20
Selecting and Adjusting Sounds	
(Sound Parameters).....	22
Selecting a Sound (INST).....	22
Adjusting the Volume (LEVEL).....	23
Adjusting the Pitch (PITCH)	23
Adjusting the Decay (DECAY)	23
Adjusting the Stereo Position (PAN)	23
Adjusting the Dynamic Volume Response (CURVE).....	24
Adjusting the Effects Depth (FX SEND).....	25
How to Edit Sound Parameters	26
Adding Reverberation and Other Effects to the Sound	
(Effect Parameters).....	28
Select an Effect (FX TYPE)	28
Setting Effect Duration and Rate (FX TIME)	28
Adjust the Effect Depth for the Entire Patch	
(FX LEVEL).....	28
How to Edit Effect Parameters.....	29

Adjusting the Pad Sensitivity (TRIG SENS)	30
Setting the Pad's Minimum Level (TRIG THRESHOLD).....	31
Copying a Patch (COPY).....	32
Setting Up Your Own Patch Sequences	
(Patch Chain).....	33
What is a Patch Chain?.....	33
Setting up a Patch Chain.....	33
Using a Patch Chain to Select Patches	34
Erasing a Patch Chain	34

CHAPTER 3 Connecting External Pads or Pedals

Connecting External Pads or Hi-Hat Control Pedal ..35	
Connecting External Pads or the Special Pedal.....	35
Precautions When Connecting a External Pad.....	37
Precautions When Connecting	
the PD-100 or PD-120.....	38
How to Use the Rim Shot and Cymbal Choke	
Playing Techniques	39
Precautions When Connecting	
a Hi-Hat Control Pedal.....	40
Using a Footswitch as a Hold Pedal.....	41
Settings for External Pads or Kick Trigger Units.....	42
Setting External Pad Tone and MIDI Parameters	42
How to Edit the Trigger Parameters.....	42
Setting Parameters for Reliable Performance using	
Acoustic Drum Triggers and Other Manufacturers'	
Pads (Advanced Trigger Parameters).....	48
Settings for an External Hi-Hat Control Pedal.....	54
Controlling the Tone with the Hi-Hat	
Control Pedal—Pedal Control (PDL CTRL).....	54
Adjusting the Volume of the Pedal Hi-Hat Sound	
(PDL LEVEL).....	55
Using the Hi-Hat Control Pedal's Action to Set	
Controller Numbers for Sending and Receiving	
MIDI Data (PDL CC#).....	56

CHAPTER 4 Connecting MIDI Devices

MIDI Connections	57
About MIDI.....	57
How MIDI Data is Sent and Received	57
Main Types of MIDI Data Used by the SPD-20.....	58
MIDI Parameter Settings.....	61
How the MIDI Parameters Work	61
Setting MIDI Parameters	66
Priority Ranking of Note Number Expression	67
Using the SPD-20 as a MIDI Sound Module	67
Setting the Receive Channel (Basic Channel)	67

Settings for Each Pad.....	68
Using External MIDI Devices to Play the Internal Sound Generator.....	69
Expanding Patches to Allow Reception of Many Note Numbers (Patch Expand)	69
How to Use a Sequencer or a Computer to Record/Play back Your Performance	72
Connecting a Computer (or a Sequencer)	72
Breaking/Cutting the Connection Between the Sound Generator and the Pad Controller (Local Control).....	72
How to Set Up the SPD-20 for Sequencing	74
Storing the SPD-20's Data in External Devices (Bulk Dump)	75
How to Transmit (Bulk Dump).....	75
How to Receive (Bulk Load)	76
Reading SPD-11 Data with the SPD-20.....	77
What is Device ID	78

CHAPTER 5 Supplementary Materials

Taking Advantage of the On-board Effects.....	79
Troubleshooting.....	82
Error Messages.....	87
Instrument List.....	88
Patch List	93
Parameter List	94
Trigger Type Internal Parameters (Advanced Trigger Parameters)	94
Blank Parameter Chart	95
Roland Exclusive Message	96
MIDI Implementation.....	98
MIDI Implementation Chart.....	102
How to Read a MIDI Implementation Chart	103
Specifications.....	104
Index.....	105
How-To Index.....	106

How to Use This Manual

This manual provides a step-by-step introduction to the many functions of the SPD-20. If this is your first time using electronic drums, or a MIDI device, please read the manual from beginning to end. If you are already familiar with electronic percussion and sequencers, you may not need to read the entire manual. Glance briefly over Chapters 1 & 2, then refer to other sections as necessary, while you experiment with the SPD-20. You will soon learn how the unit works. If you don't understand the meaning of a term or how a function works, use the index to find the appropriate explanation.

CHAPTER 1 Quick Start

Read this chapter first to learn how to play using the SPD-20. It guides you quickly through the basics, up to the point where you can produce sound. All the fundamental operating procedures are also introduced.

CHAPTER 2 Using the SPD-20 by Itself

Read this chapter if you wish to use the SPD-20 as a stand-alone unit. Here you will find a variety of information, such as how the unit is organized internally, as well as how to modify the sounds.

CHAPTER 3 Connecting External Pads or Pedals

Read this chapter when you wish to connect external pads or hi-hat control pedal to the SPD-20.

CHAPTER 4 Connecting MIDI Devices

Read this chapter when you wish to use the SPD-20 to play an external sound module, to have sequencer performance data played through the SPD-20, or to save data from the SPD-20 to a sequencer.

CHAPTER 5 Supplementary Materials

Supplementary sections provided with this manual include "Troubleshooting," a "Instrument List," and the "MIDI Implementation" chart. Read this when, for example, you need a solution to some difficulty in operating the unit, or when you just want to know about MIDI in greater detail. You can find both a subject-specific index and general index at the end of this manual.

MEMO

If you will be using the SPD-20 by itself, there is no need for you to read Chapters 3 and 4, or the MIDI Implementation section in Chapter 5 (p. 98–101).

NOTE

The explanations in this manual include illustrations that depict what should typically be shown by the display. Note, however, that your unit may incorporate a newer, enhanced version of the system (e.g., includes newer sounds), so what you actually see in the display may not always match what appears in the manual.

Important Notes

In addition to the items listed under “USING THE UNIT SAFELY” on page 2, please read and observe the following:

Power Supply

- Do not use this unit on the same power circuit with any device that will generate line noise (such as an electric motor or variable lighting system).
- The AC adaptor will begin to generate heat after long hours of consecutive use. This is normal, and is not a cause for concern.
- Before connecting this unit to other devices, turn off the power to all units. This will help prevent malfunctions and/or damage to speakers or other devices.

Placement

- Using the unit near power amplifiers (or other equipment containing large power transformers) may induce hum. To alleviate the problem, change the orientation of this unit; or move it farther away from the source of interference.
- This device may interfere with radio and television reception. Do not use this device in the vicinity of such receivers.
- Do not expose the unit to direct sunlight, place it near devices that radiate heat, leave it inside an enclosed vehicle, or otherwise subject it to temperature extremes. Excessive heat can deform or discolor the unit.

Maintenance

- For everyday cleaning wipe the unit with a soft, dry cloth or one that has been slightly dampened with water. To remove stubborn dirt, use a cloth impregnated with a mild, non-abrasive detergent. Afterwards, be sure to wipe the unit thoroughly with a soft, dry cloth.
- Never use benzine, thinners, alcohol or solvents of any kind, to avoid the possibility of discoloration and/or deformation.

Repairs and Data

- Please be aware that all data contained in the unit's memory may be lost when the unit is sent for repairs. Important data should always be backed up in another MIDI device (e.g., a sequencer), or written down on paper (when possible). During repairs, due care is taken to avoid the loss of data. However, in certain cases (such as when circuitry related to memory itself is out of order), we regret that it may not be possible to restore the data, and Roland assumes no liability concerning such loss of data.

Memory Backup

- This unit contains a battery which powers the unit's memory circuits while the main power is off. When this battery becomes weak, the message shown below will appear in the display. Once you see this message, have the battery replaced with a fresh one as soon as possible to avoid the loss of all data in memory. To have the battery replaced, consult with your retailer, the nearest Roland Service Center, or an authorized Roland distributor, as listed on the “Information” page.

bAttErY Lo

Additional Precautions

- Unfortunately, it may be impossible to restore the contents of data that was stored in another MIDI device (e.g., a sequencer) once it has been lost. Roland Corporation assumes no liability concerning such loss of data.
- Use a reasonable amount of care when using the unit's buttons, sliders, or other controls; and when using its jacks and connectors. Rough handling can lead to malfunctions.
- Never strike or apply strong pressure to the display.
- When connecting/disconnecting all cables, grasp the connector itself—never pull on the cable. This way you will avoid causing shorts, or damage to the cable's internal elements.
- To avoid disturbing your neighbors, try to keep the unit's volume at reasonable levels. You may prefer to use headphones, so you do not need to be concerned about those around you (especially when it is late at night).
- This instrument is designed to minimize the extraneous sounds produced when it's played. However, since sound vibrations can be transmitted through floors and walls to a greater degree than expected, take care not to allow these sounds to become a nuisance to neighbors, especially when performing at night and when using headphones.
- When you need to transport the unit, package it in the box (including padding) that it came in, if possible. Otherwise, you will need to use equivalent packaging materials.

Main Features of the SPD-20

- The SPD-20 features 700 different internal instruments, including drum set sounds, percussion sounds from around the world, dance sounds, sound effects, phrase loops, and more, that can be used in a wide variety of musical genres. (Instrument List p. 88)
- Each sound can be edited using a wide variety of sound parameters, including level, pitch, decay, pan, velocity curve, and effect send (p. 22).
- Using the Layer function, different Velocity Curves can be assigned to each of two sounds, and the two sounds mixed (or switched) by your playing dynamics (p. 17).
- The on-board digital effects unit (Reverb, Delay, Chorus and Flanger) allows you to set the effect depth independently for each sound assigned to a pad (p. 28).
- Four external dual trigger inputs are provided, allowing you to connect kick trigger units (KD-7s; sold separately) or pads (PD-7, PD-9, PD-5, PD-120, PD-100: sold separately), for playing in conjunction with the SPD-20's pads (p. 35). When you connect the PD-7 or PD-9, you can enjoy such drum techniques as snare rim shots and cymbal choking (p. 39). With the PD-120 connected, you can play rim shots. What's more, you can play the SPD-20's sounds using an acoustic drum trigger attached to an acoustic drum (p. 45).
- When a hi-hat control pedal (FD-7; sold separately) is connected, you have continuous control (from closed to open) of the hi-hat sounds (p. 54).
- Settings for the SPD-20's 8 pads, 4 external pads, hi-hat control pedal, and the effects unit can be stored as one of 99 Patches. This means that a single SPD-20 is able to store and instantly recall 99 different percussion "sets," covering virtually any style of music you can imagine.
- Using the Patch Chain function, you can create and store a sequence of up to 16 Patches which can be selected in a predetermined order (convenient for use within a song). The SPD-20 can store eight such Patch Chains (p. 33).
- For each pad, you can set two independent MIDI transmit channels and Velocity Curves, so that your playing dynamics can control external and internal sound generators (p. 61).
- The SPD-20 is fully expandable via MIDI, and is especially powerful when used with a sequencer. For example, you might record SPD-20 settings as bulk data (p. 75) at the beginning of sequencer song data, or allow the sequencer to take care of Patch selection so that you can concentrate on playing.

Panel Descriptions

Front

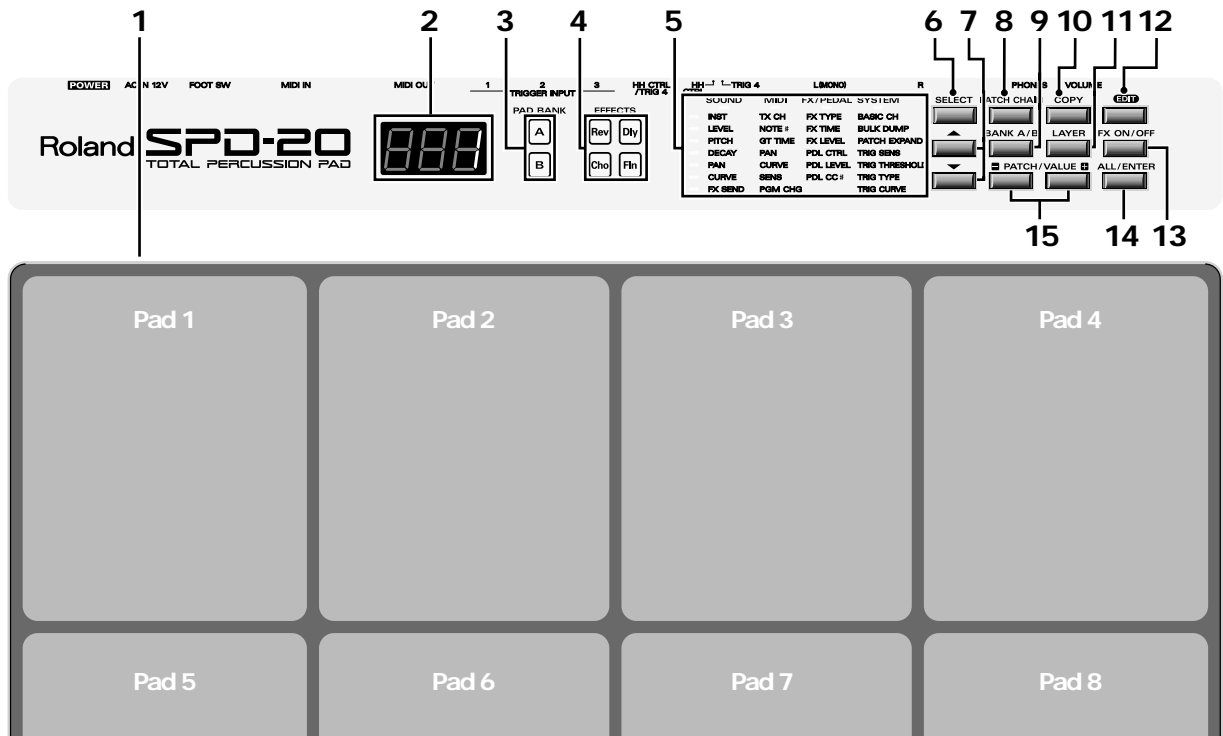

Rear

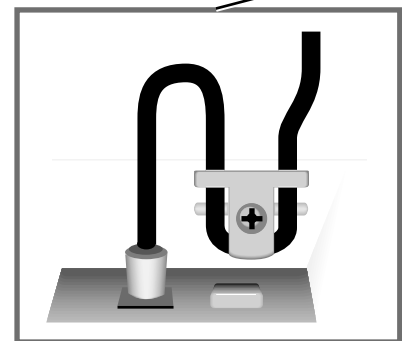
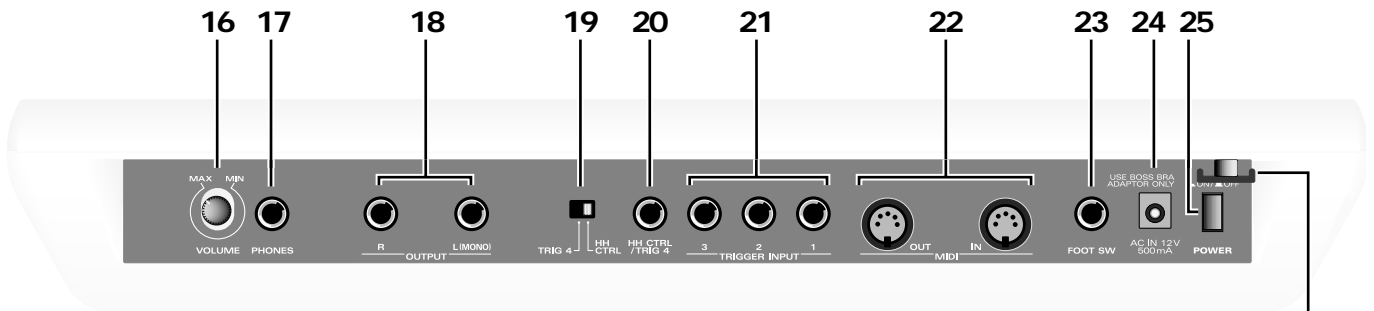

Cord Hook

NOTE

To prevent the disruption of power to your unit (should the plug be pulled out accidentally), and to avoid applying undue stress to the AC adaptor jack, anchor the power cord using the cord hook, as shown in the illustration.

1 Pads 1–8

Play these pads to trigger the various sounds. The pads are velocity sensitive and will respond to your playing dynamics.

2 Patch display

This display indicates the Patch number or the value of each parameter (p. 14).

3 PAD BANK indicator

Indicates the selected pad bank (A or B) (p. 16).

4 EFFECT indicator

The LED of the selected effect will light (p. 28).

5 Parameter List

In the Edit mode, the indicator of the selected parameter will light (p. 20). Use the [SELECT] (Parameter Group Select) and [▼][▲] (Parameter Select) buttons to choose parameters (p. 21).

6 Parameter Group Select button [SELECT]

In the Edit mode, this button selects the desired parameter group: SOUND, MIDI, FX/PEDAL, or SYSTEM (p. 21).

7 Parameter Select buttons [▼][▲]

In the Edit mode, use these buttons to select a parameter within the parameter group (p. 21).

8 [PATCH CHAIN] button

Use this button when setting up or playing a Patch Chain (p. 33).

9 [BANK A/B] button

Switches you between pad banks A and B (p. 16).

10 [COPY] button

Use to copy data from one Patch to another (p. 32).

11 [LAYER] button

This button allows the sounds assigned to pad banks A and B to be played together (p. 15).

12 [EDIT] button

This button switches between the Edit and Play modes (p. 19).

13 [FX ON/OFF] button

This button turns the effects on or off (p. 28).

14 [ALL/ENTER] button

Use this button when setting all pads to the same value (p. 27), when performing a copy (p. 32), or when storing Patch Chain settings (p. 33).

15 PATCH/VALUE [-], [+] buttons

These buttons are used to select Patches. In the Edit mode they are used to modify parameter values (p. 14).

16 VOLUME knob

Adjusts the volume of the OUTPUT jacks and PHONES jack (p. 13).

17 PHONES jack

A pair of stereo headphones can be connected to this jack. Even with headphones connected, the OUTPUT jacks will still be active (p. 12).

18 OUTPUT (R, L/MONO) jacks

These jacks output the sound of the SPD-20. For monaural output use the L/MONO jack (p. 12).

19 [HH CTRL/TRIG 4] select switch

If a hi-hat control pedal (FD-7; sold separately) is connected to the hi-hat control pedal jack, set this switch to HH CTRL (p. 40). If an external pad is connected, set this switch to TRIG 4 (p. 37).

20 HH CTRL/TRIG 4 jack

A hi-hat control pedal (FD-7; sold separately) can be connected to this jack. If the external input select switch is set to TRIG 4, an external pad can be connected to this jack (p. 35, 36).

21. TRIGGER INPUT 1–3 jacks

External pads etc. can be connected here (p. 37).

 *Use Trigger Input jack 1 and 2 to allow the playing of rim shots when using a PD-120 pad (p. 38).*

22. MIDI IN/OUT connectors



External MIDI devices can be connected here (p. 57).

23. FOOT SW jack

A footswitch can be connected here allowing you to change Patches by remote control. If you use a special cable (PCS-31; sold separately) to connect two FS-5U switches (sold separately), you can move up or down through the Patch numbers. If you connect a DP-2 switch (sold separately), you can move up (but not down) through the Patch numbers (p. 15).

24. AC adaptor jack

Connect the included AC adaptor here (p. 12).

 **WARNING** *Use only the included AC adaptor. Use of any other AC adaptor may cause damage or malfunction.* 

25. POWER switch

This switch turns the unit on/off (p. 12).

Attaching the SPD-20 to a Drum Stand

If you are attaching the unit to a cymbal stand etc. with a pipe diameter of 10.5–30 mm, use an all purpose clamp set (APC-33: sold separately).

- 1** Using a 4 mm wrench, remove the four screws from the bottom of the SPD-20.

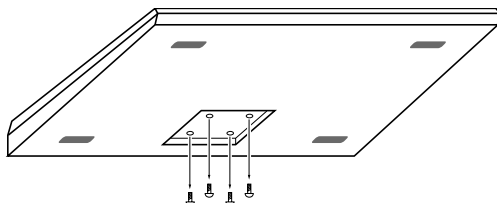

- 2** Use the four screws you removed in step 1 to attach the stand holder to the bottom of the SPD-20.

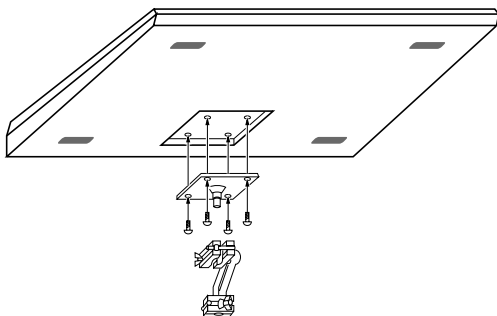

NOTE The screws included with the APC-33 cannot be used.

Using the Slit Tape (Included)

Place the Slit tape, included with the SPD-20, along the slits, or grooves around each of the pads. The Slit tape allows you to clearly distinguish where each pad is, even on stage or in other darkened locations.

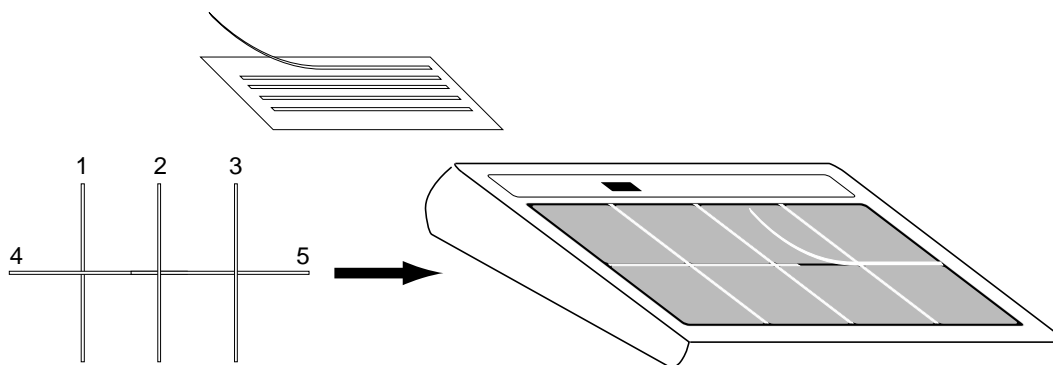

NOTE Please note that Roland does not handle replacements or additional purchases of Slit Tape.

How to Restore the Factory Settings (System Initialize)

When the SPD-20 is shipped, it contains 99 Patches in memory. You can freely overwrite this data. However, the same data is also preserved in ROM, and can be restored at any time. This procedure is called System Initialize.

ROM

This is an abbreviation for Read Only Memory, which is a type of memory that can only be read; modification or deletion is not possible.

The explanations in this manual assume that the SPD-20 is still in its factory initialized state. We recommend that before you begin using the unit, you perform this System Initialize operation.

NOTE

When you execute the System Initialize operation, all your edited data will be lost. If your SPD-20 contains important edited data, you should make a note of the settings or store the data in an external device such as a sequencer (p. 75).

1 While holding down [▼] and [ALL/ENTER], turn the power on.

The following display will appear.



2 Press [ALL/ENTER] and the data will be initialized.

If you wish to quit without initializing, press any key other than [ALL/ENTER].

MEMO

It is possible to restore the factory settings of a single patch with Patch Copy (p. 32).

CHAPTER 1 Quick Start

Connection to Audio Equipment

With the SPD-20, you can produce realistic sounds simply by connecting an audio system. You can also use headphones.

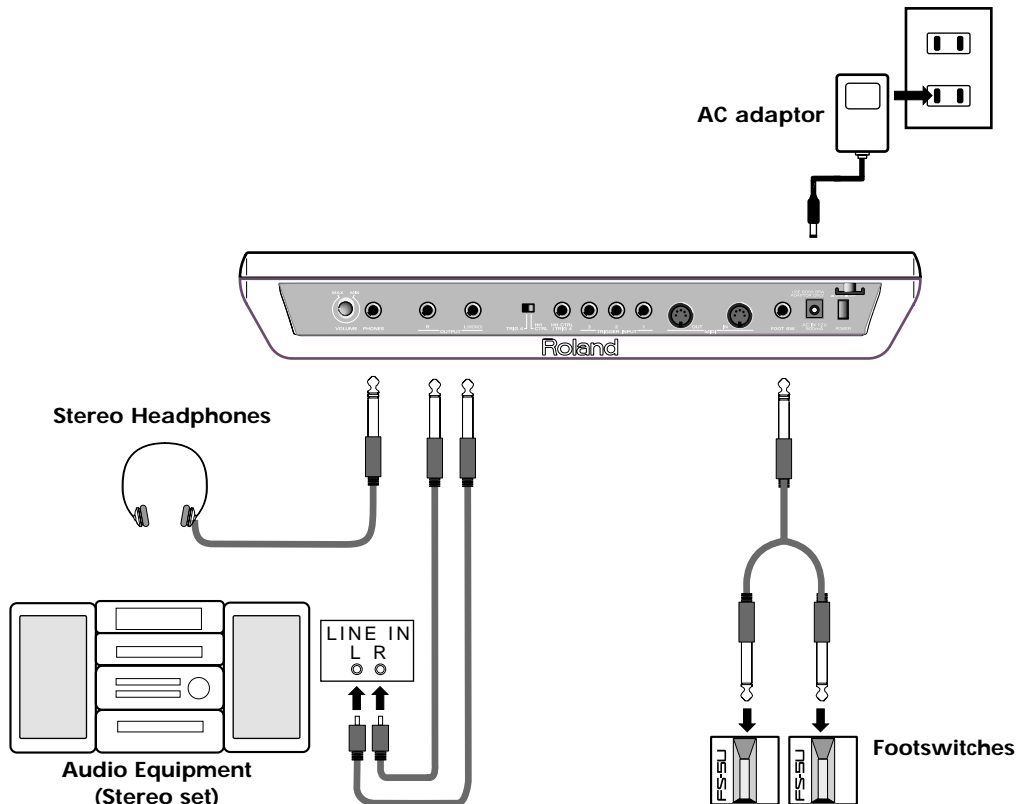

NOTE

To prevent malfunction and/or damage to speakers or other devices, always turn down the volume, and turn off the power on all devices before making any connections.

Playing the Pads

When connections are complete, you can play the SPD-20.

Turning the Power On

The POWER switch is on the rear panel.

NOTE

Once the connections have been completed, turn on power to your various devices in the order specified. By turning on devices in the wrong order, you risk causing malfunction and/or damage to speakers and other devices.

Always make sure to have the volume level turned down before switching on power. Even with the volume all the way down, you may still hear some sound when the power is switched on, but this is normal, and does not indicate a malfunction.

1

Check that all connections with other devices are correct, and that everything is off.

2 Press the power switch to turn the unit on.



When the power is turned on, the SPD-20 will be in the Play mode. This is the mode in which you will play the SPD-20.



NOTE

When you turn the SPD-20's power on, it takes about one second complete adjustments to the trigger circuits.

After you turn the power on, do not strike the pads or press the pedals until the Patch number is displayed.

If you turn the power on when a hi-hat control pedal (FD-7) is connected, make sure that the pedal is fully open. When you turn the power on, a message "Fd7" will be displayed briefly. (For details see p. 40.) Do not press the pedal until this message has been displayed.

3 Turn on the other devices, but turn the power amp on last.

Turning the Power Off

Power down your system in the reverse order.

When the power is turned off, the following three functions will be reset to their factory settings.

Function	Factory setting
Local Control (p. 72)	On
HH Control Pedal (p. 40)	Not set
PATCH CHAIN ON/OFF	Off

Functions and parameter settings other than these are retained even when the power is turned off.

CAUTION Whenever the unit is to remain unused for an extended period of time, disconnect the AC adaptor.



Adjusting the Volume

When you strike a pad, it will trigger the sound that has been assigned to it. Playing harder will produce a louder sound. As you play, adjust the overall volume by rotating the VOLUME knob located on the rear panel.

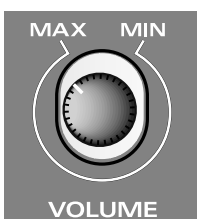

WARNING This unit, either alone or in combination with an amplifier and headphones or speakers, may be capable of producing sound levels that could cause permanent hearing loss. Do not operate for a long period of time at a high volume level, or at a level that is uncomfortable. If you experience any hearing loss or ringing in the ears, you should immediately stop using the unit, and consult an audiologist.



NOTE

To avoid disturbing your neighbors, try to keep the unit's volume at reasonable levels. You may prefer to use headphones, so you do not need to be concerned about those around you (especially when it is late at night).

Selecting a Patch

When you select a Patch, the sound assigned to each pad and the settings for MIDI, effect and pedal will all change instantly. Try each of the 99 factory-preset Patches to hear the different possibilities.

To select Patches first make sure you are in the Play mode. Then use the PATCH/VALUE [-] or [+] buttons to select Patches. The number of the selected Patch will appear in the display.



Pressing PATCH/VALUE [+] while holding down PATCH/VALUE [-] (or vice versa) causes the Patch numbers to change more rapidly.



What is a Patch?

A Patch contains data determines how each pad sounds, settings for the effects and also MIDI settings. The SPD-20 can store 99 different Patches.

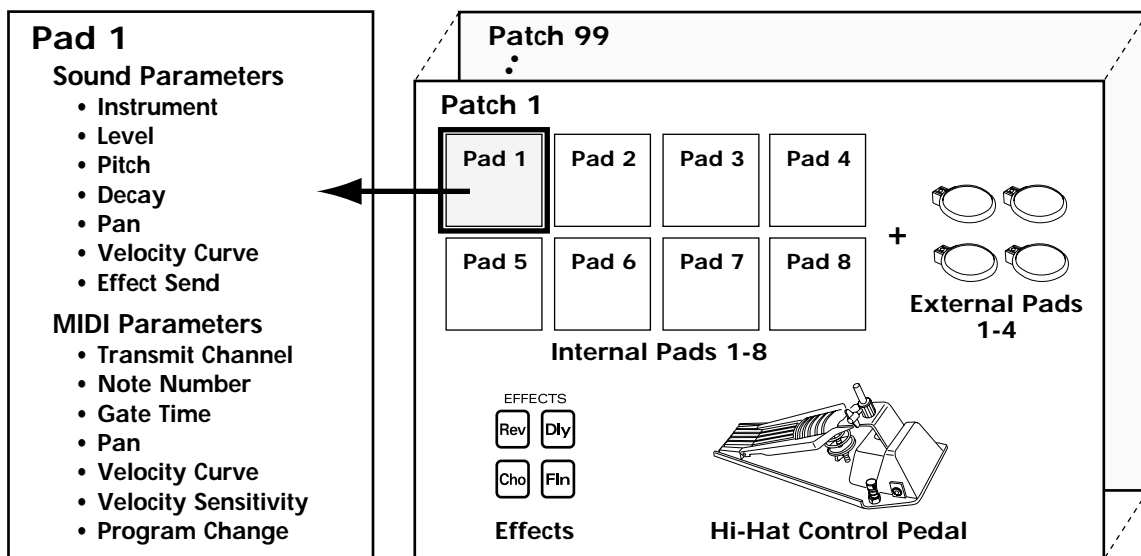

When you select a Patch, the settings for each pad are instantly changed (p. 15).



You can also use MIDI Exclusive messages to store Patch data in an external sequencer or other device (p. 75).

Using a Footswitch to Select Patches

By using a special cable (PCS-31; sold separately) to connect two footswitches (FS-5U; sold separately) to the FOOT SW jack, you can select Patches by remote control. When you press Footswitch 1 you will advance to the next Patch number, and when you press Footswitch 2 you will go back to the previous Patch number. If you connect a DP-2, you can move up (but not down) through the Patch numbers.

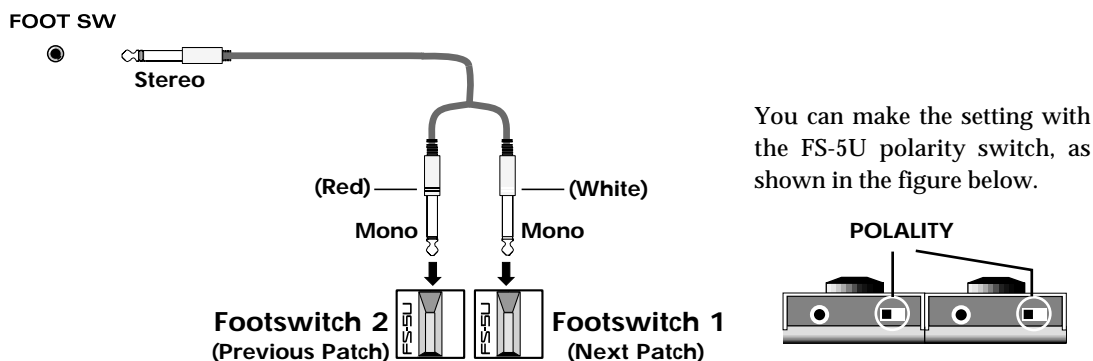

Connect the two mono cables of the PCS-31 to the two footswitches. The plug with the white line is for Footswitch 1, and the plug with the red line is for Footswitch 2.



Connecting the model DP-2 pedal switch (sold separately) allows you to only advance the Patch numbers.

When using the footswitch as a Hold Pedal, please refer to "Using a Footswitch as a Hold Pedal" on p. 41.

Comparing Layered Sounds

Most of the factory-preset Patches use Layer (p. 17). Select a layered Patch and listen to the sounds of pad banks A and B. When you select a layered Patch, both PAD BANK indicators (A and B) will light.

1 Select a Patch.

2 In the Play mode, press [LAYER] to turn Layer off.

PAD BANK indicator B will go out. Now you can play the pads to hear the sound of pad bank A.

3 To hear the sound of pad bank B, press [BANK A/B] so that PAD BANK indicator B lights. Play the pads.



Each time you press [BANK A/B], PAD BANK indicators A and B will light alternately.

What is a Pad Bank?

The 8 pads of the SPD-20, together with 4 external pads (plus the 4 rims)—for a total of 16 pads—are referred to as a pad bank. Each Patch contains two pad bank settings, A and B.

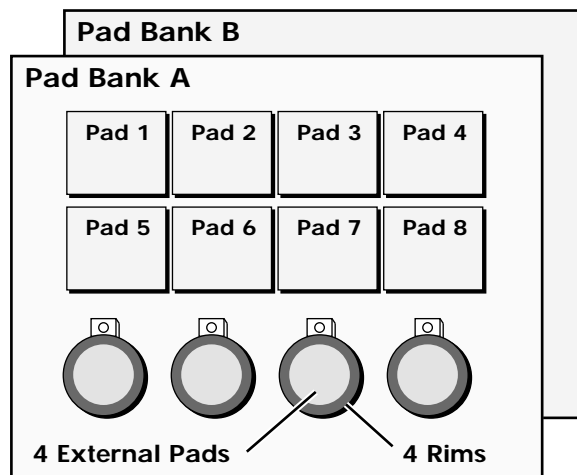

When you select a Patch, the PAD BANK indicator will show which pad bank the Patch uses. If the Layer function (explained below) is used in that Patch, both PAD BANK indicators (A and B) will be lit.

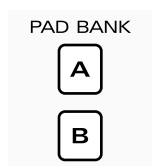

What is the Layer Function?

Layer means that two sounds are played simultaneously. The Layer setting is stored as part of each Patch. A Patch for which Layer is enabled will simultaneously play the sounds of both pad banks (A and B). In this case, however, you will only be able to play half as many notes simultaneously (a maximum of 7). Layering sounds can open the door to creative expression.

Ways to use the Layer function

By assigning different Instruments to pad banks A and B, and setting pad banks A and B to different Velocity Curves (p. 24), your playing dynamics can be used to cross-fade or switch between the two sounds.

Velocity Mix: Playing dynamics will determine the mix of the two sounds.

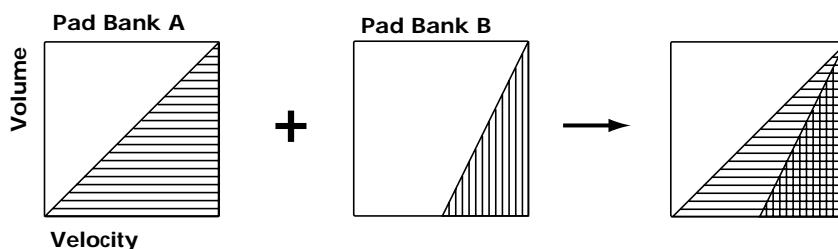

Velocity Switch: Playing dynamics cause a switch between the two sounds.

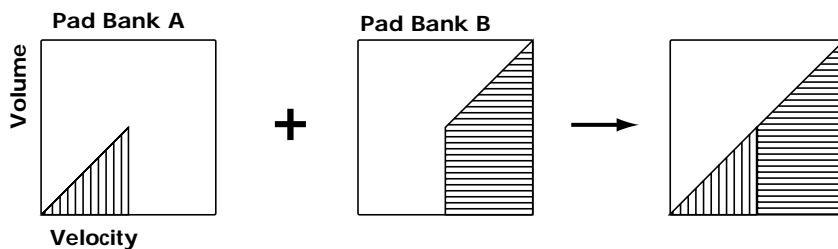

Velocity Crossfade: Playing dynamics produce cross-fades between the two sounds.

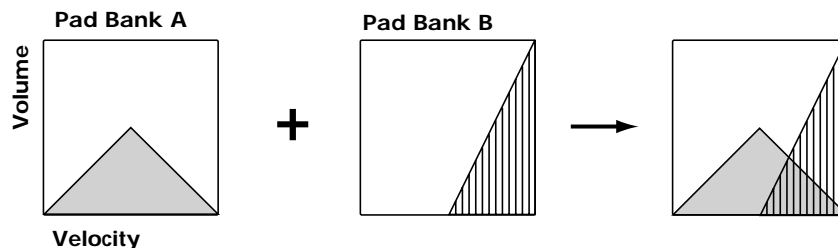

CHAPTER 2 Using the SPD-20 by Itself

About the SPD-20's Internal Setup and Parameter Settings (Edit)

This Chapter explains the basic structure of the SPD-20 and how it functions. Before we get into details, you should have an overall understanding of the unit.

What Kind of Instrument is the SPD-20?

The SPD-20 is an electronic percussion instrument that produces sound when its pads are struck. This type of device is usually called a MIDI pad controller. The SPD-20 includes a sound generator (700 sounds with 16-bit dynamic range) and digital effects unit in a compact and lightweight package. By connecting external pads or pedals (sold separately), you can obtain the same musical expressivity from the SPD-20 as you might enjoy with an acoustic drum kit. In addition, the SPD-20 is MIDI compatible, meaning that it can be connected to any other MIDI-compatible device (sequencer, sampler, etc.) regardless of the manufacturer. This allows you to create a very powerful music system.

Product Overview

- Self-contained compact MIDI pad controller
- 8 dynamics-sensitive pads
- 700 sounds with 16-bit dynamic range
- Built-in digital effects
- Expandable with external pads/pedals (such as the PD-7, PD-120, KD-7, and FD-7)
- Teams up with various MIDI units (such as sequencer, sampler, etc.)

Internal Organization

The SPD-20 can be divided into the following sections:

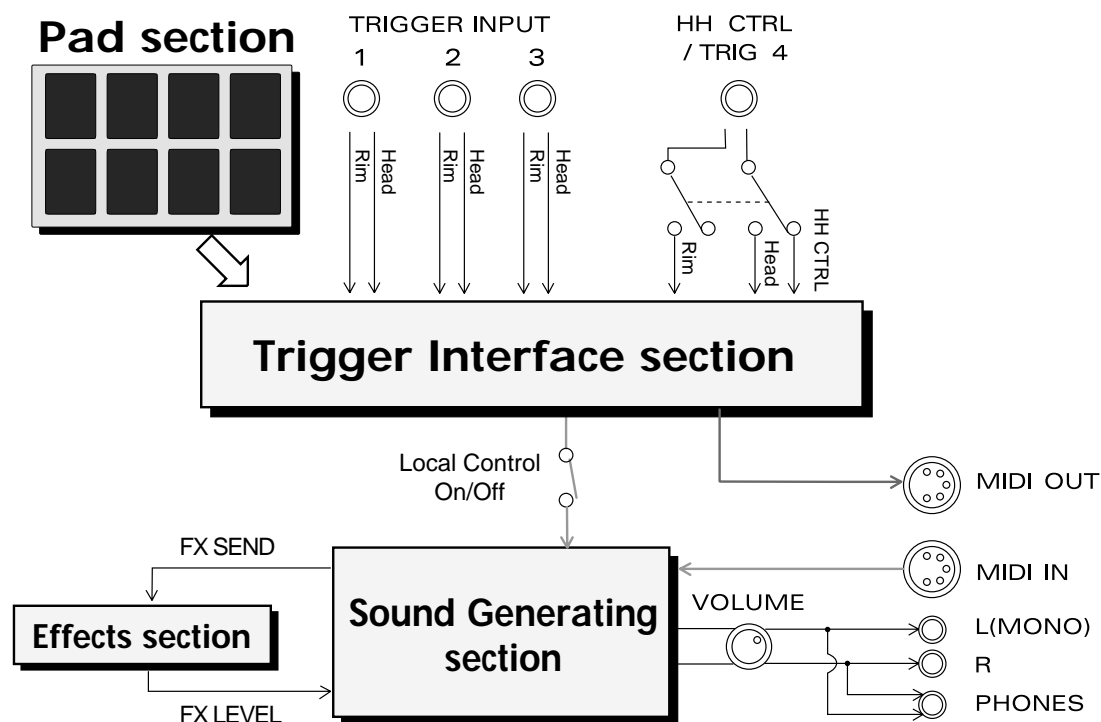

Pad section

This section has 8 velocity sensitive pads that respond to changes in your playing dynamics.

Trigger Interface section

This section sends the trigger signals (electric signals produced when you strike a pad) to the Sound Generating section.

Sound Generating section

This section receives signals from the trigger interface or MIDI IN, and produces sound in response. The SPD-20 contains 700 sounds and up to 14 can be played simultaneously.

Effects section

This section adds effects (Flanger, Chorus, Reverb, Delay) to the sound from the sound generator. You can select from 25 effects combinations (p. 28).

Play Mode and Edit Mode

The SPD-20 has two modes; the Play mode and the Edit mode. Press [EDIT] to switch between them.

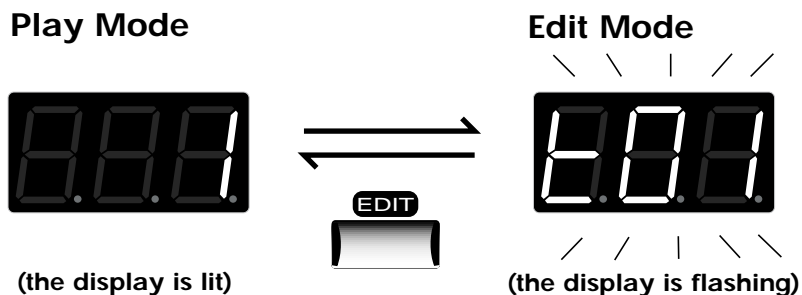

Play Mode

In this mode you can strike the pads and select Patches. In the Play mode, the display will show the Patch number.

Edit Mode

In this mode you can make settings for the various parameters. In the Edit mode, the display will show the parameter value (which will be flashing).



In addition to these two modes, there is another, the Advanced Edit mode, for making more detailed settings for the Trigger parameters. (p. 48)

How to Edit

To modify parameter values you must be in the Edit mode. The names of all the parameters you can modify are in the Parameter List printed on the front panel.



“Edit” refers to the process of changing parameter values.

How to read the parameter list

The parameter list has four indicators arranged horizontally and seven indicators arranged vertically. In the Edit mode, one of the horizontal indicators and one of the vertical indicators will always be lit. This shows which parameter is being edited; i.e., the intersection of the indicated column and row is the currently selected parameter. The display shows the value of this parameter. To edit a particular parameter, refer to the parameter list and use the [SELECT] and [▲] [▼] buttons to select it.

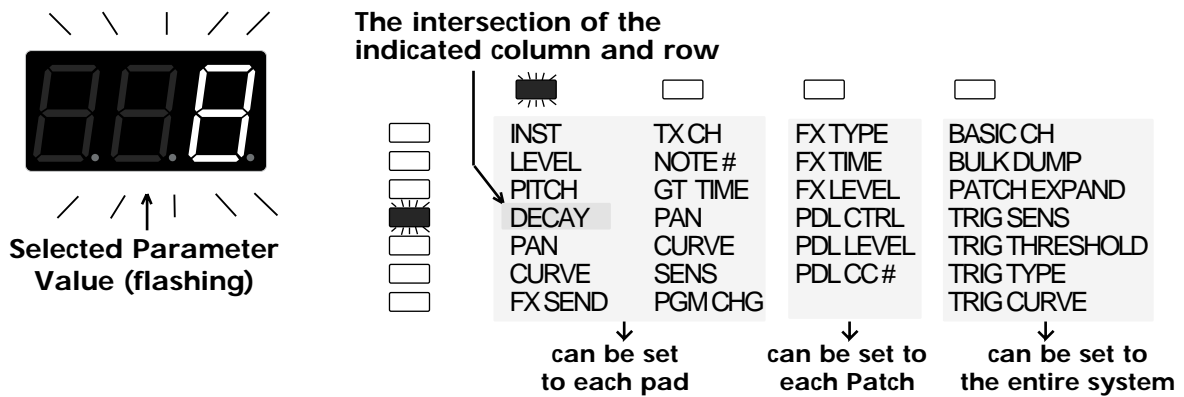

Use PATCH/VALUE [-] or [+] to modify the parameter value.

How to edit

1 Press [EDIT] to enter the Edit mode.

2 Select the parameter you wish to edit. Press [SELECT] to get the appropriate indicator to light, thus selecting a column. Use [▲] or [▼] to select the desired row, by getting the appropriate indicator to light. (The display will show the value of the selected parameter.)

[SELECT] chooses the parameter group. The parameters of the SPD-20 are organized into four groups: SOUND, MIDI, FX/PEDAL, and SYSTEM. With each press of [SELECT], the indicator that lights (and the group that is selected), will be the next one in this group.

The [▲] and [▼] buttons are used to select parameters within the parameter groups. The indicator above the currently lighted one will light when you press [▲], and the one below the one currently lighted will light when you press [▼].

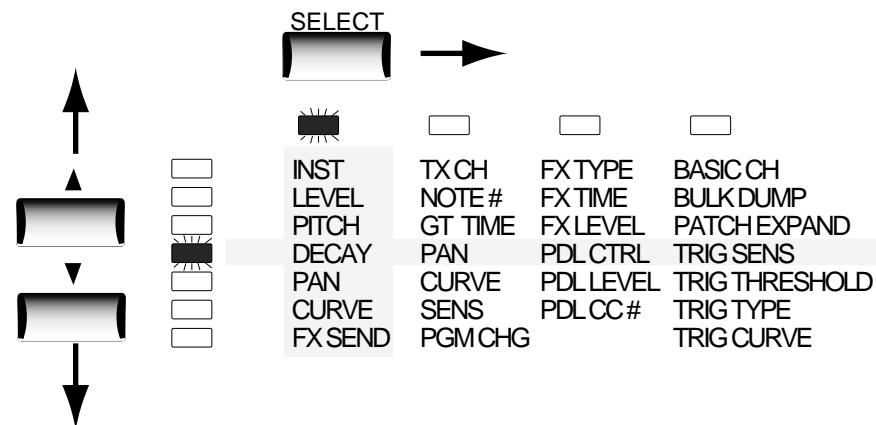

In this illustration, the DECAY parameter in the SOUND parameter group is selected.

3 Use PATCH/VALUE [-] or [+] to set the value. The previous value of the parameter will be discarded. In the case of a numerical value, PATCH/VALUE [+] increases the value, and PATCH/VALUE [-] decreases it.

MEMO

You can speed up the change in values by pressing [+] while holding down [-] (or vice versa).

4 If you wish to edit another parameter, repeat steps 2-3 as necessary.

5 Press [EDIT] to return to the Play mode.

The parameter list indicators will go out, and the display will once again show the Patch number.

Selecting and Adjusting Sounds (Sound Parameters)

The parameters in the SOUND group (the sound parameters) allow you to modify the sound assigned to each pad.

The SOUND group contains 7 parameters: INST, LEVEL, PITCH, DECAY, PAN, CURVE and FX SEND.



Sound parameter settings for each pad are stored in each Patch.

Selecting a Sound (INST)

Each sound assigned to a pad is called an Instrument. The SPD-20 contains 700 such Instruments, and the Instrument assign settings determine which sounds will be played. The 700 Instruments are grouped into the following categories.

	b01 – b50	Bass Drum
	S01 – S86	Snare Drum
	t01 – t40	Tom-tom
	h01 – h33	Hi-Hat Cymbal
	H01 – H17	Hi-Hat Cymbal for pedal control
	C01 – C36	Crash/Ride Cymbal
	L01 – L78	Latin Percussion (Cuban, Brazilian)
	i01 – i33	Indian Percussion
	F01 – F37	African/Middle Eastern/Australian/Other Percussion
	J01 – J51	Japanese/Korean/Chinese/Southeast Asian Percussion
	o01 – o24	Orchestral Percussion
	M01 – M59	Melodic Percussion/Melodic Instrument
	A01 – A16	Analog Percussion (CR-78, TR-808, etc.)
	d01 – d43	Dance Sounds
	E01 – E46	Artificial Sound Effects
	n01 – n31	Natural Sounds, Human Voice
	r01 – r20	Ambience, Reversed Sounds
	Mut	Forces Phrase Loop Instrument to stop (MUTE). No sound
	oFF	No sound



The Hi-Hat Cymbals for pedal control “instruments H01–H17” can be used effectively only when a Hi-Hat controller (FD-7; separately sold) is used (p. 54).

If the Instrument assign setting for any Pad is set to “oFF”, there will be no sound when you strike that Pad.

If you make the Hold Pedal settings (p. 41), then with some of the sounds, you can use the footswitch to sustain the sound. For the instruments that can be lengthened with the footswitch, refer to p. 88.

When an Instrument is selected, by pressing PATCH/VALUE [+] while holding down [-] (or vice versa), you can jump to the next Instrument group.

About Phrase Loop

Some Instruments are designed as Phrase Loops (p. 88).

When you select a Phrase Loop, you don't just hear single notes; instead, a short phrase typical of that musical genre is played. You cannot play more than one Phrase Loop on different pads. You can layer two Phrase Loops on one pad and play them simultaneously. To force a Phrase Loop to stop sounding, select “Mut” and strike the pad. No sound is heard from a pad that has been set for “Mut.”

Adjusting the Volume (LEVEL)

This parameter determines the volume (0–15). At a setting of 0 there will be no sound.

NOTE

When FX SEND in the SOUND parameter group is set above 0, the effects sound alone will be heard even if the LEVEL parameter is set to 0.

Adjusting the Pitch (PITCH)

This parameter determines the pitch of the Instrument (-24–+24). Each step will change the pitch by a semitone (100 cents).

NOTE

For some Instruments, raising the pitch beyond a certain point will not be possible.

Adjusting the Decay (DECAY)

This parameter adjusts the decay of the Instrument (-31–+31). Higher settings will result in a longer decay time.

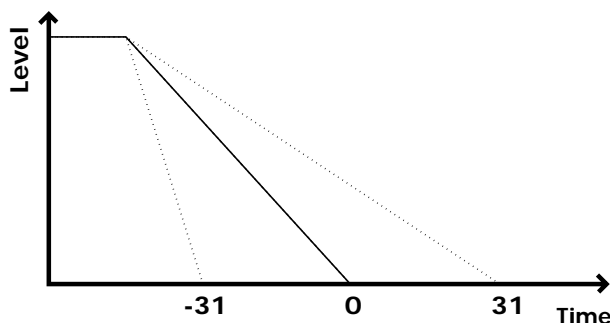

NOTE

For some Instruments, raising the decay beyond a certain point will not be possible.

When the connected pedal is assigned to “HH” (p. 54), the decay parameter has no effect on Hi-Hat Cymbals for pedal control (instruments H01–H17).

Changing the decay setting for a Phrase Loop Instrument (p. 88) changes the attenuation time at the end of the loop.

Adjusting the Stereo Position (PAN)

This parameter determines the stereo position of the Instrument (L7–Ctr–r7/rnd). A setting of L7 is far left, Ctr is center, and r7 is far right. At the “rnd” setting, the stereo position will change randomly each time you strike the pad.

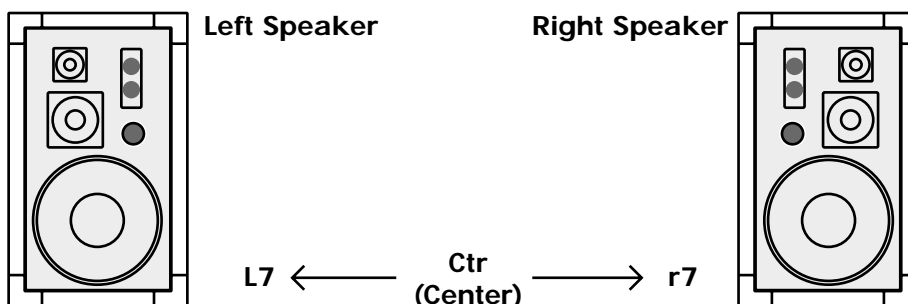

NOTE

This parameter is meaningful only when the SPD-20 is connected to a stereo audio system.

Adjusting the Dynamic Volume Response (CURVE)

This parameter determines how the Instrument volume will change in response to your playing. You can choose from 16 response curves.

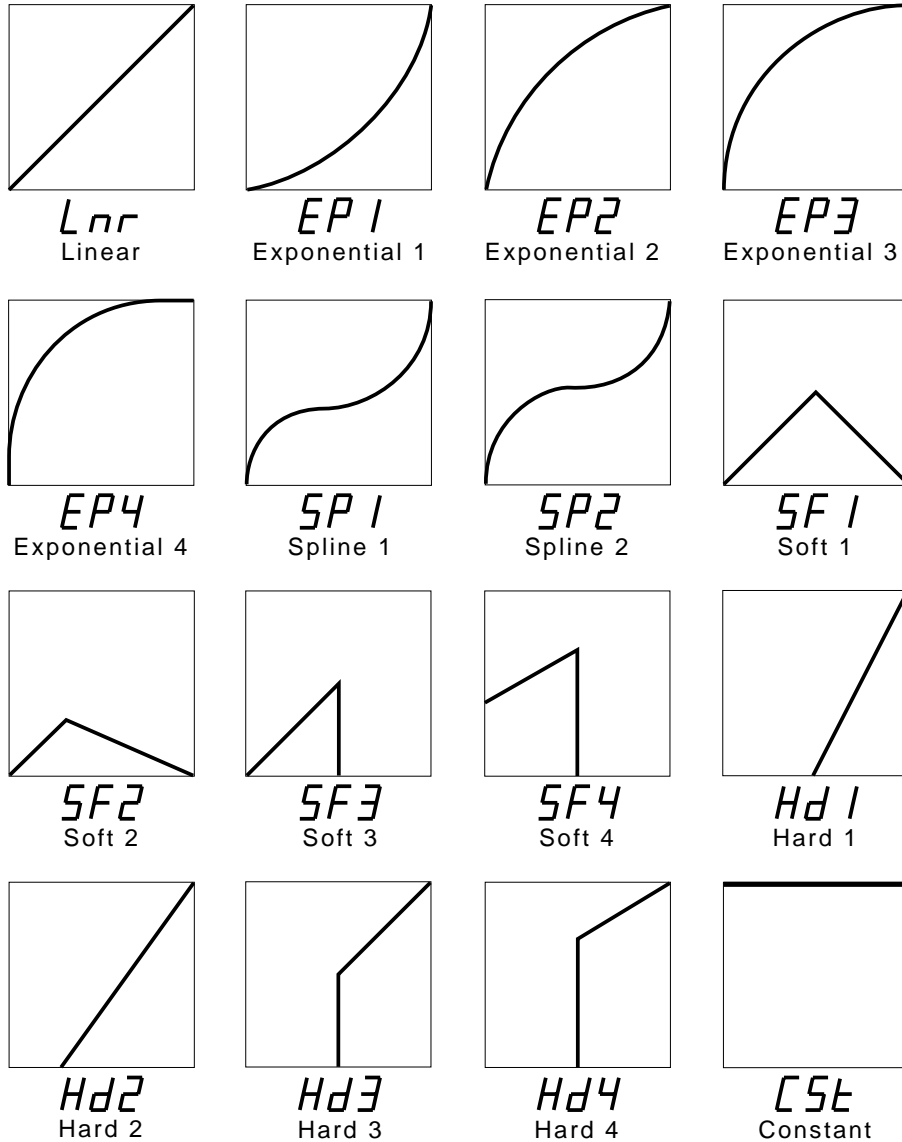

You can come up with some effective Layered sounds by combining SF (Soft) and Hd (Hard) Velocity Curves.

Ex. 1: In a layered patch, when you combine SF1 and Hd1, or SF2 and Hd2, as the Velocity Curve settings for pad bank A and pad bank B, respectively, striking the pad lightly sounds the Instrument of pad bank A, and the harder you hit, the louder you can make the sound of the pad bank B Instrument become (Velocity Crossfade).

Ex. 2: In a layered patch, when you combine SF3 and Hd3, or SF4 and Hd4, as the Velocity Curve settings for pad bank A and pad bank B, respectively, you can switch the pad bank A and pad bank B Instruments with the strength with which you strike the pads (Velocity Switch).

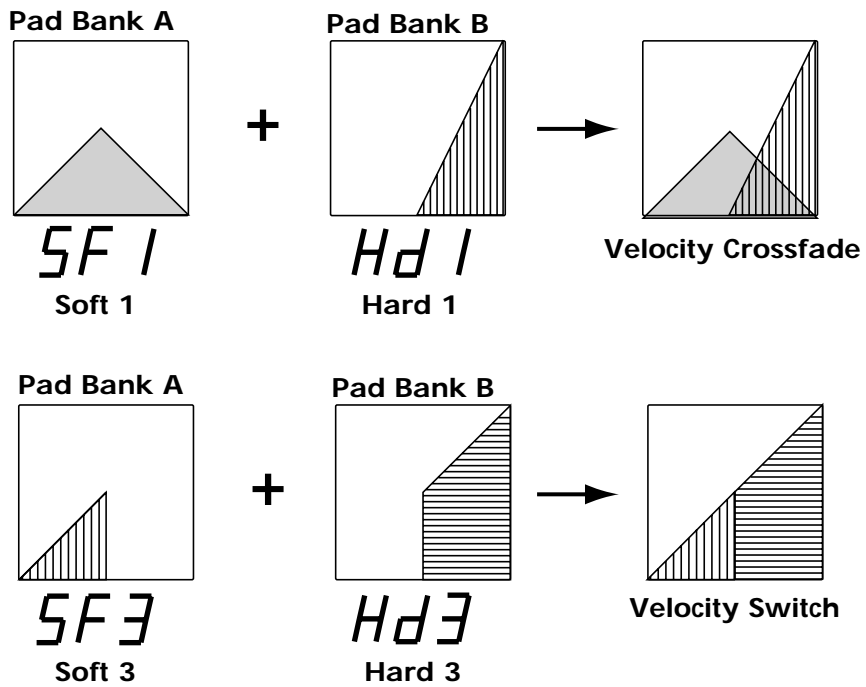

MEMO When CSt is selected, the unit sounds at maximum volume, regardless of how hard you strike the pad.

Adjusting the Effects Depth (FX SEND)

This parameter determines the depth (0-15) of the effect applied to each Instrument assigned to the pad. Higher settings will result in a deeper effect. With a setting of 0 there will be no effect. The overall effects level for a Patch is determined by FX LEVEL in the FX/PEDAL parameter group.

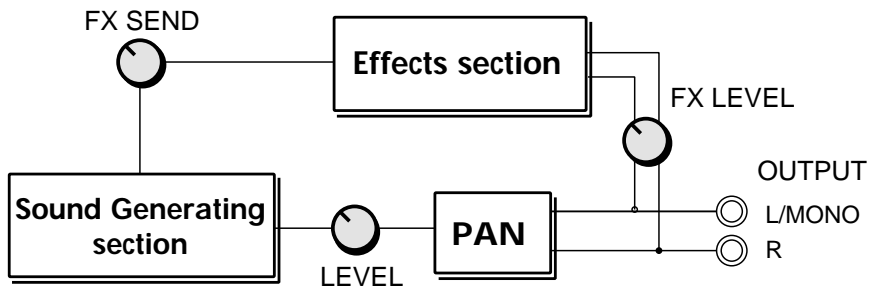

NOTE This FX SEND parameter will have an audible result only if the [FX ON/OFF] setting is on, and FX LEVEL in the FX/PEDAL parameter group is set above 0.

How to Edit Sound Parameters

It is not possible to simultaneously edit the sound parameters of pad banks A and B. Use [BANK A/B] to switch between the two pad banks, and edit each bank separately.

Editing a sound parameter

1 In the Play mode, use the PATCH/VALUE [-] or [+] buttons to select the Patch (1-99) to edit.

2 Press [EDIT] to enter the Edit mode.



Selecting and changing parameters is called editing.

3 Strike the pad you wish to edit.

4 Turn Layer on or off if necessary.



You can have only one of the Pad Bank Instruments sound by setting Layer to OFF.

5 Press [BANK A/B] to select the bank you wish to edit.

The selected PAD BANK indicator will be flashing.

6 Press [SELECT] to select the SOUND parameter group.

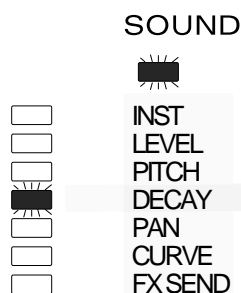

7 Press [▲] or [▼] to select the parameter to be edited.

8 Use PATCH/VALUE [-] or [+] to set the value.

For a numerical parameter, pressing PATCH/VALUE [-] will decrease the value, and pressing PATCH/VALUE [+] will increase the value.



Pressing PATCH/VALUE [+] while holding down PATCH/VALUE [-] (or vice versa) makes this change more rapidly. However, when selecting a Parameter Group Instrument (INST), when you press PATCH/VALUE [+] while holding down PATCH/VALUE [-] (or vice versa), you jump to the next Instrument group.

9 To edit the other pad bank of the layered sound, repeat steps 5–8.

10 When you finish making settings, press [EDIT] to return to the Play mode.

MEMO

By using a special cable (PCS-31; sold separately) to connect two footswitches (FS-5U; sold separately) to the FOOT SW jack, you can change parameter values by remote control. While in Edit Mode, when you press Footswitch 1 you will advance to the next higher parameter value, and when you press Footswitch 2 you will go down to the next lower parameter value (p. 15). If you connect a single footswitch (DP-2; sold separately) you can only move up to a higher parameter value, not down to a lower parameter value.

Setting all pads to the same parameter value

If you press [ALL/ENTER] after step 8, the displayed parameter value will be set for all pads of the currently selected pad bank.



MEMO

If you are making settings for one of the SPD-20's pads, the settings will be applied to all 8 pads. If you are making settings for an external pad, the settings will be applied to all 4 of the external pads, and all 4 of the external rims.

HINT

By assigning the same Instrument to all the pads and setting a different pitch for each, you can play melodies. The following procedure is an example using a melodic percussion Instrument (M01–M59).

1. Set the INST parameter in the SOUND parameter group to the desired Instrument.
2. Press [ALL/ENTER] to set all pads to the same sound.
3. Adjust the PITCH parameter for each pad.

Adding Reverberation and Other Effects to the Sound (Effect Parameters)

The SPD-20 has four on-board effects: Reverb, Delay, Chorus, and Flanger. There are three effects parameters: FX TYPE, FX TIME and FX LEVEL.



Effects settings are stored independently for each Patch, so you can set up the ideal effects for each Patch.

Chapter 5 includes a section on “Taking Advantage of the On-board Effects” (p. 79), and we suggest that you read this as well.

Select an Effect (FX TYPE)

This parameter selects one of the 25 effects combinations (1–25).

The Effect Indicator for the selected effect type will light to show the effect being used.

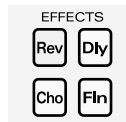

Effect Type	Explanation	
1–10	Reverb sound	Adds reverberation to the sound
11–14	Chorus sound	Adds breadth to the sound
15–17	Flanger sound	Applies undulations to the sound
18–25	Delay sound	Adds an echo-like effect



For details on each effect type, refer to the page 79.

The effects are toggled on/off with each press of [FX ON/OFF].

Setting Effect Duration and Rate (FX TIME)

This sets the duration of reverberation, or the modulation rate (1–32). The higher the value, the longer the reverb duration, or the higher the modulation rate. The result will be different depending on the type of effect. Refer to page 79.

Adjust the Effect Depth for the Entire Patch (FX LEVEL)

This parameter corresponds to the effect return level on a mixer, and higher settings will result in a deeper effect (0–15). At a value of 0 there will be no effect.



The depth of the effect applied to each Instrument (assigned to a pad) is determined by FX SEND in the SOUND parameter group. (p. 25)



This effect level parameter will have an audible result only if the [FX ON/OFF] setting is on, and if the Instrument parameter FX SEND for a pad is set above 0.

How to Edit Effect Parameters

1 In the Play mode, use PATCH/VALUE [-] or [+] to select a Patch (1-99).

2 Press [EDIT] to enter the Edit mode.

3 Press [SELECT] to select the FX/PEDAL parameter group (p. 21).

	SOUND	MIDI	FX/PEDAL	SYSTEM
	<input type="checkbox"/>	<input type="checkbox"/>	<input checked="" type="checkbox"/>	<input type="checkbox"/>
<input checked="" type="checkbox"/>	INST	TX CH	FX TYPE	BASIC CH
<input type="checkbox"/>	LEVEL	NOTE #	FX TIME	BULK DUMP
<input type="checkbox"/>	PITCH	GT TIME	FX LEVEL	PATCH EXPAND
<input type="checkbox"/>	DECAY	PAN	PDL CTRL	TRIG SENS
<input type="checkbox"/>	PAN	CURVE	PDL LEVEL	TRIG THRESHOLD
<input type="checkbox"/>	CURVE	SENS	PDL CC #	TRIG TYPE
<input type="checkbox"/>	FX SEND	PGM CHG		TRIG CURVE

4 Press [▲] or [▼] to select the effect parameter you wish to edit.

5 Use PATCH/VALUE [-] or [+] to set the value.

6 Repeat steps 3-5 to finish making the effect settings for the Patch.

7 If you wish to adjust the effect depth independently for each pad, make the appropriate settings for the FX SEND in the SOUND parameter group for each pad (p. 25).

Adjusting the Pad Sensitivity (TRIG SENS)

By adjusting the TRIG SENS in the SYSTEM parameter group you can adjust the sensitivity of the pad when it is struck (the range of adjustment is 1–16). Higher settings result in higher sensitivity, so that the pad will produce a loud volume even when struck softly. This parameter applies to all 8 pads.

NOTE

Factory Trigger Sensitivity (TRIG SENS) settings for the internal pad reflect the average user's preferences. If these settings produce good results for you, then there is no need to change the Trigger Sensitivity values.

MEMO

This parameter is set for all 8 pads, i.e., the same value applies to all pads. However, this parameter can be set independently for each connected external pad.

Trigger Sensitivity (TRIG SENS) settings are common to all patches.

1 Press [EDIT] to enter the Edit mode.

2 Press [SELECT] to select the SYSTEM parameter group.

3 Use [▲] or [▼] to select TRIG SENS.



4 Strike one of the 8 pads.

MEMO

When you strike the pad, the strength with which the pad is struck (velocity) is shown in the display on a six-level scale. Striking the pad forcefully sets velocity at a value of 127.

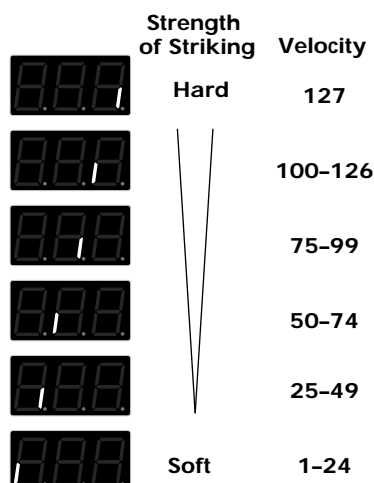

5 Use PATCH/VALUE [-] or [+] to set the value.

Setting the Pad's Minimum Level (TRIG THRESHOLD)

By adjusting the TRIG THRESHOLD in the SYSTEM parameter group you can have a pad produce a trigger signal only when struck with more than a certain level of force (a "threshold"). This can be used to prevent a pad from sounding in response to extraneous vibrations from another pad. However, if you strike the pad with a force less than the Trigger Threshold, it will not sound. In the diagram below, the pad will sound for 2, but not for 1 or 3. This parameter can be set over a range of 0–15.

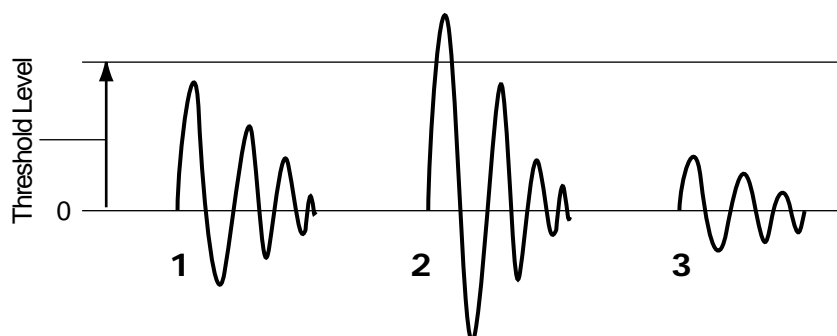

NOTE

Factory Trigger Threshold (TRIG THRESHOLD) settings for the internal pad reflect the average user's preferences. If these settings produce good results for you, then there is no need to change the Trigger Sensitivity values.

MEMO

This parameter is set for all 8 pads, i.e., the same value applies to all pads. However, this parameter can be set independently for each connected external pad.

Trigger Threshold (TRIG THRESHOLD) settings are common to all patches.

1 In the Edit mode, select the SYSTEM parameter group (p. 21).

2 Use [▲] or [▼] to select TRIG THRESHOLD.



3 Strike one of the 8 pads.

4 Use PATCH/VALUE [-] or [+] to set the value.

MEMO

For information on editing external Pad Trigger Parameters, please refer to p. 42.

Copying a Patch (COPY)

This operation copies Patch settings to another Patch. If you need another Patch that is only slightly different from an existing one, copy that Patch and then make the changes that you need.

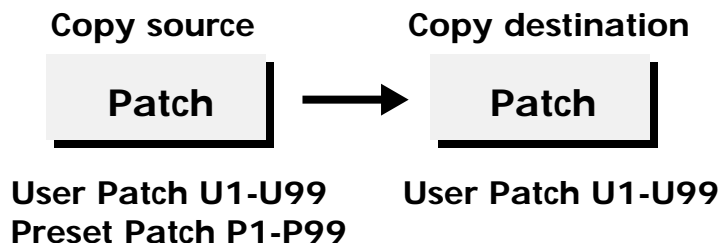

When you execute COPY, the contents of the copy destination patch are rewritten.

1 In the Play mode, use PATCH/VALUE [-] or [+] to select the copy destination Patch (1-99).
When you execute COPY, the data is overwritten in this patch.

2 Press [EDIT] to enter the Edit mode.

3 Press [COPY].



4 Use PATCH/VALUE [-] or [+] to select the copy source Patch.
The copy source Patch can be selected from user Patches (U1-U99) or factory-preset Patches (P1-P99).



Play the pads to check the selected copy source Patch.

To quit without copying, press [COPY].

5 Press [ALL/ENTER] and the Patch will be copied.



6 Press [EDIT] once again to return to the Play mode.



The external pad's SOUND parameter, MIDI parameter, and FX/PEDAL settings are copied simultaneously.

Setting Up Your Own Patch Sequences (Patch Chain)

What is a Patch Chain?

A Patch Chain is a sequence (that you create) of up to 16 Patches. The SPD-20 can store 8 of these Patch Chains (A, b, C, d, e, F, G, H.)

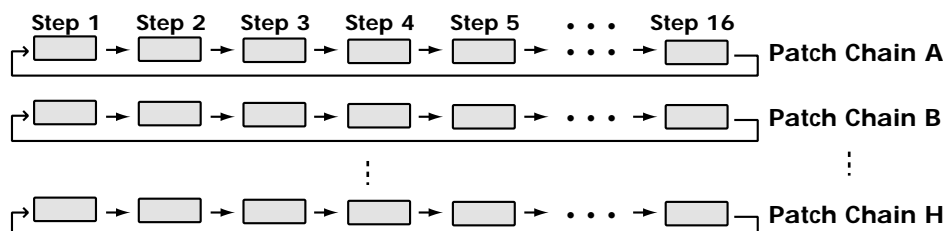

By setting up a Patch Chain that contains all the Patches needed for a stage set or a song, you can quickly and easily access the Patches you need.

Setting up a Patch Chain

- 1** In the Edit mode, press [PATCH CHAIN] to select a Chain (A, b, C, d, e, F, G, H).

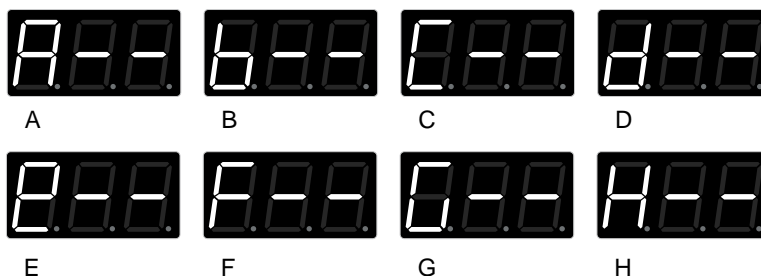

- 2** Use the PATCH/VALUE [-] or [+] buttons to select the Patch number (1-99).

MEMO

You can also select Patch numbers using a footswitch connected to the FOOT SW jack.

- 3** Press [ALL/ENTER].

- 4** Repeat steps 2-3 to create a Chain of Patches.

MEMO

Each Chain can consist of up to 16 Patches. If you attempt to specify a 17th Patch, the display will show "FUL."

- 5** When you are finished, press [ALL/ENTER].



NOTE

If you press [PATCH CHAIN] to select another Chain before pressing [ALL/ENTER], the Patch Chain settings you just made will be lost.

6

If you wish, you may make settings for another Patch Chain.

7

When you finish making Patch Chain settings, press [EDIT] to return to the Play mode.

Using a Patch Chain to Select Patches

Here's how to step through the Patches in a Patch Chain.

1

In the Play mode, press [PATCH CHAIN] to select the Patch Chain you wish to use (A, b, C, d, e, F, G,H).

**NOTE**

A Patch Chain which does not contain any data will not be displayed in the Play mode.

2

Each time you press PATCH/VALUE [-] or [+] the next Patch in the Chain will be selected.

MEMO

After the last Patch in the Chain, you will return to the first Patch.

A footswitch connected to the FOOT SW jack can also be used to select Patches.

3

Press [PATCH CHAIN] several times to return to the Play mode.

Erasing a Patch Chain

Here's how to erase the current Patch Chain settings.

1

Press [EDIT] to enter the Edit mode.

2

Use [PATCH CHAIN] to select a Patch Chain, and press [ALL/ENTER] to erase it. The following display will appear.



3

Press [EDIT] once again to return to the Play mode.

NOTE

After all chains are cleared, the Patch Chain cannot be used, even if you press [PATCH CHAIN] in the Play mode.

CHAPTER 3 Connecting External Pads or Pedals

You can add external pads to the SPD-20. Furthermore, you can connect a hi-hat control pedal (FD-7; sold separately) to control the opening and closing of the hi-hat.

Connecting External Pads or Hi-Hat Control Pedal

Connecting External Pads or the Special Pedal

Example 1: Percussion Set

The SPD-20 should be mounted on a stand. A commercially available cymbal or tom-tom stand works well for this.

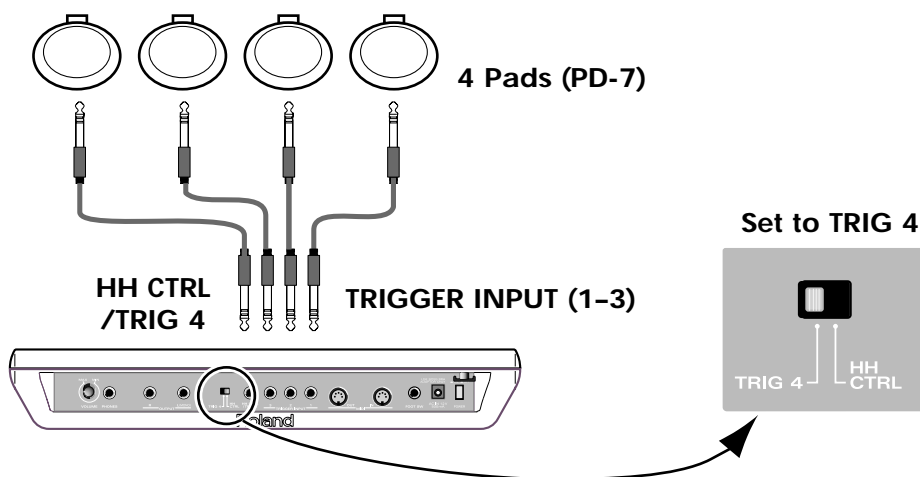
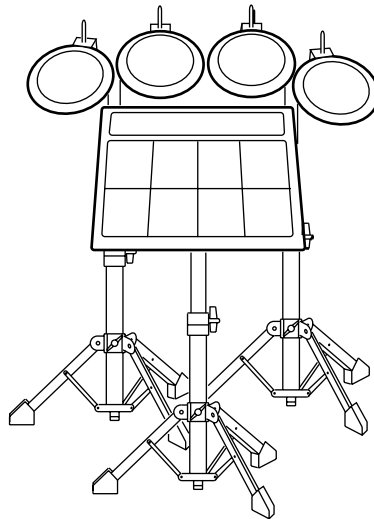

Example 2: Full Set Kit

If you wish to connect a hi-hat control pedal (FD-7; sold separately) to the HH CTRL/TRIG 4 jack, set the [HH CTRL/TRIG 4] select switch (p. 40) to HH CTRL. If you wish to connect an external pad, set the switch to TRIG 4.

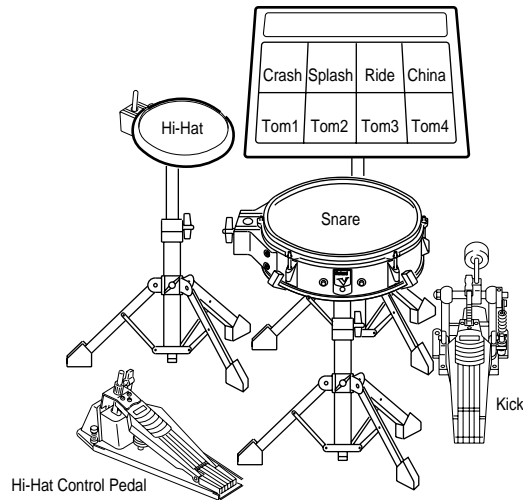

Hi-Hat Control Pedal (FD-7)

Pad (PD-120)

Kick Trigger Unit (KD-7)
+ Kick Pedal

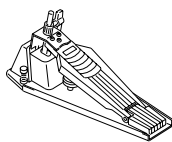

Pad (PD-7)

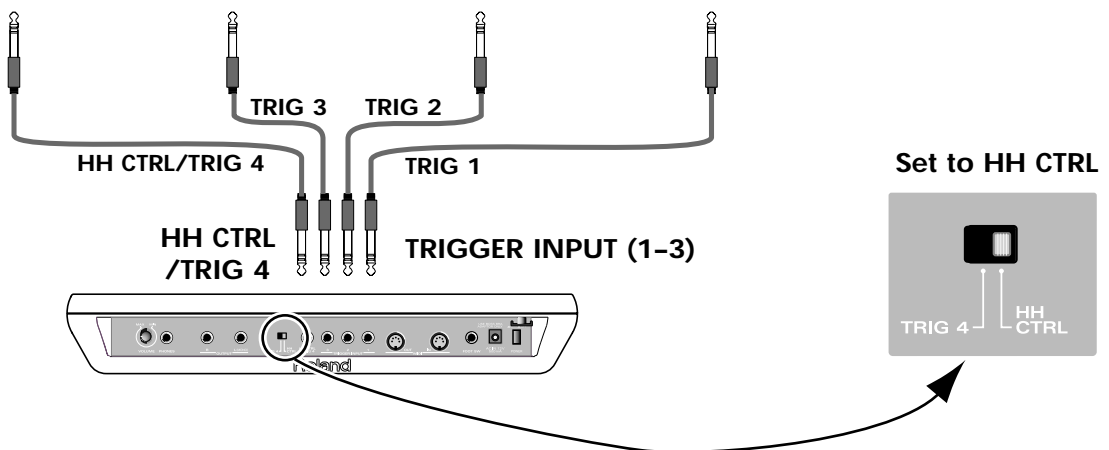
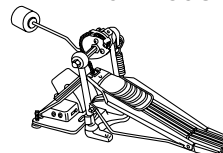
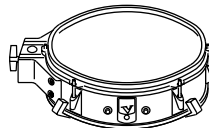

Precautions When Connecting a External Pad

The external pad and Kick Trigger Unit are connected to the Trigger Input jacks 1, 2, and 3, or the HH CTRL/TRIG 4 jack. (However, in this case, the Trigger Input switch is set to TRIG 4.)

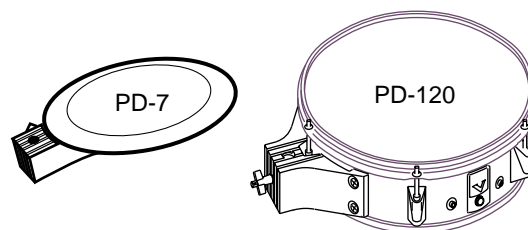

NOTE

You may hear a brief sound when you change the position of the switch. This is normal, and should not be a cause for concern.

To perform with even greater expression, we recommend the use of the following specialized pads from Roland.

PD-7, PD-9, PD-5, PD-120, PD-100, KD-7 (Kick Trigger Unit)

When you use these pads, it is necessary to set the pad type with the TRIGGER parameter TRIG TYPE (p. 45).

NOTE

Use a mono cable when connecting pads from other manufacturers.

When using a PD-7, PD-9 and KD-7, set the Polarity Switch on the pad to the “-” (negative) side, and make connections using the cable included with the pad or Kick Trigger Unit.

You may hear a brief sound when you change the position of this switch. This is normal, and should not be a cause for concern.

MEMO

The four Trigger Input jacks provided with the SPD-20 are already Dual Trigger Type. This is to allow processing of two types of signals, for when you strike the head and for rim shots, when you connect a PD-7 or PD-9.

NOTE

You can play rim shots with the PD-120 only by using Trigger Input jacks 1 and 2 (p. 38).

Precautions when connecting a Kick pedal (Kick Trigger Unit)

When using a kick pedal, a specialized Kick Trigger Unit (KD-7; sold separately) is necessary.

A connecting cable and beater are included with the KD-7, and you may use a favorite bass drum pedal to control the SPD-20 sounds. Set the Polarity Switch on the KD-7 to the “-” (negative) position, then connect to an TRIGGER INPUT jack (1–3), or to the HH CTRL/TRIG 4 jack. (However, in the later case, be sure to set the External input select switch to TRIG 4.)

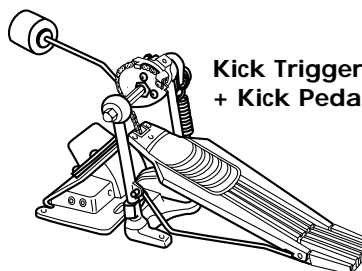

**Kick Trigger Unit (KD-7)
+ Kick Pedal**

By connecting two sets of units and pedals, you can use dual bass drum techniques. There are two ways to do this. You can use the mix in jack of one KD-7 and connect the two sets in serial to one SPD-20 input, or you can connect each KD-7 to its own SPD-20 Trigger input. The first method uses only one SPD-20 TRIGGER INPUT, and the second method uses two SPD-20 TRIGGER INPUTs. However, the second method allows you to control two different Instruments, so that you can assign different-sounding Kick Drums to each side, and change the pitch and Pan settings for a more expressive sound.

NOTE

When connecting two KD-7s with the KD-7's Mix In jack, the Kick Trigger signal is slightly weakened. In such cases, when connecting the KD-7 set the Trigger Input Trigger Sensitivity (TRIG SENS, p. 43) slightly higher.

Using a Footswitch Instead of a Kick Pedal

Even without a kick pedal, you can play Instruments by connecting a Pedal Switch (DP-2; sold separately) to Trigger Input jack 1. The pedal switch will yield one consistent level, regardless of how hard you hit the pedal. The level is set with a combination of two parameters. Set the Trigger Sensitivity (TRIG SENS) to have enough signal, then you may reduce the volume level with the Sound parameter level (LEVEL). Additionally, set the Trigger Threshold (THRESHOLD) between 6 and 8. Setting the Trigger Threshold value any lower than this causes the pedal to trigger sounds even when you remove your foot; setting it any higher prevents any triggering.

When triggering a sound module via MIDI, you can set the volume using MIDI parameter SENS.

NOTE

When using a Pedal Switch (DP-2; sold separately) to play Instruments, use only Trigger Input jack 1.

Precautions When Connecting the PD-100 or PD-120

Use the PD-120/PD-100 only after thoroughly reading the manuals provided with those models.

When using models PD-120/PD-100, set the pad type (120, 100) with the TRIGGER parameter TRIG TYPE (p. 45). With the PD-120, setting the Trigger Type makes it possible for you to play rim shots.

You can play rim shots with the PD-120 only by using Trigger Input jacks 1 and 2.

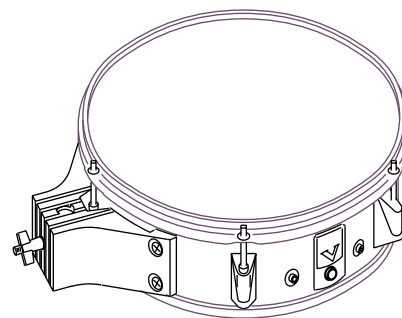

MEMO

With the PD-7 and PD-9, you can play rim shots using any of the Trigger Inputs.

NOTE

The sound does not change, regardless of where you strike the head.

If the PD-120 does not play rim shots, check the following items.

→ The PD-120's rim shot trigger characteristics differ from those of the PD-7 (or PD-9). Rim shots are detected by setting the Trigger Type to the PD-120.

→ Is it connected to Trigger Input 1 or 2?

Rim shots on the PD-120 are detected only through Trigger Input 1 and 2.

→ Is the PD-120 connected with the stereo cable provided?

When the PD-120 is connected with a mono cable, rim shots are not detected.

→ Please strike the rim close to where the PD-120's jack is located (p. 39).

MEMO

When using the PD-120 as a snare, please play with the unit set up on a snare stand.

NOTE

Do not play the PD-120 or PD-100 when the head is loose. Striking the head when it is loose not only causes sounds to be played incorrectly, but may also result in damage to the internal sensors. Furthermore, you'll get better performance if the head is on the stiff side.

How to Use the Rim Shot and Cymbal Choke Playing Techniques

If a PD-7 or PD-9 is connected, you will be able to use Rim Shot and Cymbal Choke playing technique.
If a PD-120 is connected, you will be able to use Rim Shot playing technique.

Rim Shot

By playing Rim Shot, you can play two types of sound from one pad. This can be done with a PD-7, PD-9, PD-120.

MEMO

At the time the unit was shipped from the factory, the Snare Drum Rim Shot Instrument was set to Patch 1 Trigger Input 2; confirm this by actually striking the pad.

Normal shot: Strike only the head (center)

Rim shot: Strike both the head and the rim (perimeter) simultaneously.

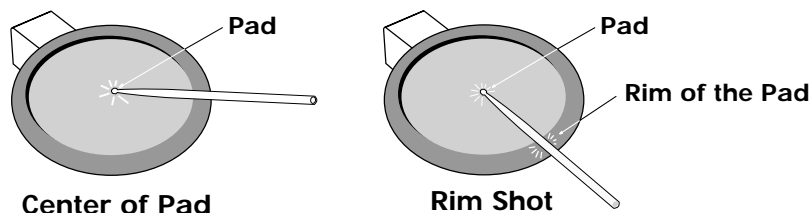

NOTE

When playing rim shots, striking only the rim does not produce a solid rim shot sound. Be sure to strike both the head and rim at the same time. With rim shots how hard the drum is struck is detected in the head portion.

When you play rim shots on the PD-120, with the pad OUTPUT jack facing toward you as shown in the figure, strike the rim within the range shown. By making rim shots outside this range you will not be able to achieve a reliable rim shot sound.

NOTE

rim shots can be played on the PD-120 only through Trigger Input 1 and 2.

MEMO

With the SPD-20, you can choose two separate MIDI sound modules for a dual trigger pad, i.e. send the "head only" to MIDI channel 10, and the "rim" to MIDI channel 11. This allows you to control instruments from two MIDI systems with one PD-7, PD-9, or PD-120 (p. 66).

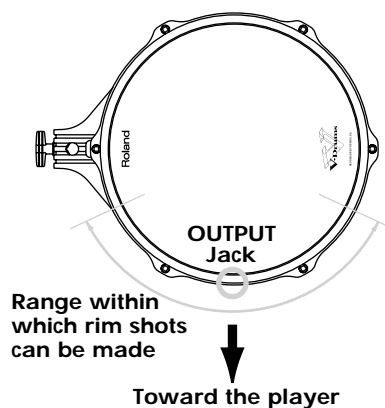

Cymbal Choke

With the PD-7 and PD-9, physically grasping the rim of the pad just after the pad is struck stops the sound as it is made. This allows you to make the same sound you get when you stop the cymbal from sounding with your hand just after striking it.

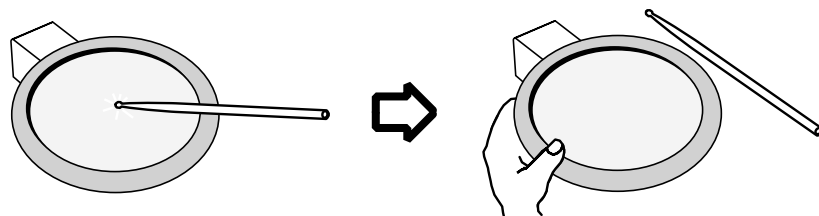

Precautions When Connecting a Hi-Hat Control Pedal

Connect the hi-hat control pedal (FD-7; sold separately) to the HH CTRL/TRIG 4 jack, and set the Trigger input switch to HH CTRL. When using an FD-7 you will be able to control various Instrument parameters in real time (p. 54).

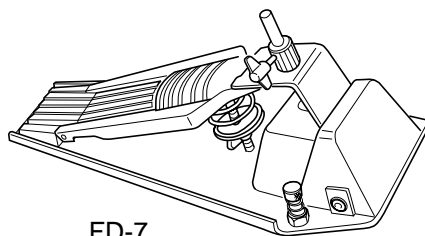

How to set the hi-hat control pedal for the best possible performance results

- 1** Using the cable included with the FD-7, connect the FD-7 to the HH CTRL/TRIG 4 jack.
- 2** Make sure that the pedal is fully open.

NOTE *If the pedal is depressed, settings will not be made correctly.*

- 3** Move the external input select switch to TRIG 4 and then move it back to HH CTRL. When the switch is moved back to HH CTRL the following display will appear. This indicates that the FD-7 has been "recognized" by the SPD-20 and will now function correctly.



NOTE *You may hear a brief sound when you change the position of this switch. This is normal, and should not be a cause for concern.*

Be very careful not to depress the pedal until the above message is displayed.

The appropriate settings will be made automatically and the same message will be displayed whenever the power is turned on with the FD-7 already plugged in.

Using a Footswitch in Place of the Hi-Hat Pedal

In place of a hi-hat control pedal, you can also control the hi-hat with a footswitch (DP-2 Pedal Switch; sold separately) connected to the HH CTRL/TRIG 4 jack. However, with this arrangement, techniques such as half open cannot be played. Just as with the hi-hat control pedal, when using the footswitch, it is necessary to have the pedal recognized using the previously mentioned procedure. When the pedal switch is properly recognized, "dP2" appears in the display.

Using a Footswitch as a Hold Pedal

A footswitch (DP-2/FS-5U; sold separately) connected to the FOOT SW jack can be used as a hold (sustain) pedal to control specified Instruments and external MIDI sound modules. When you depress the pedal, a Control Change message (Hold) will be transmitted, instructing the MIDI sound modules to continue sounding the notes that are currently being played.

If you turn the SPD-20 on while the footswitch is depressed, the following message will scroll across the display and the footswitch will act as a hold pedal.

SET HOLD PEDAL

If you are using an FS-5U, Footswitch 1 with PCS-31 will act as the hold pedal, and Footswitch 2 will increase the Patch number.

NOTE

The SPD-20's display can only show 3 characters at once. To "scroll" means that the characters automatically move across the display to show a longer message. The SPD-20 will sometimes scroll error messages or other helpful information (p. 87).

MEMO

Hold messages will be transmitted on the channel specified by the Basic Channel.

There are specific Instruments in the internal sound generator that can also be held with a footswitch (p. 88).

NOTE

This may not work properly for some MIDI sound modules or some sounds.

When using the footswitch as a Patch Shift Pedal (p. 15), first turn off the power to the unit, then with the footswitch depressed, turn the power back on. The following message is displayed, and the footswitch is set to function as a Patch Shift Pedal.

SET Patch Shift PEDAL

The footswitch can function as a "Patch Shift Pedal" or a "Hold Pedal."

Each time the power is turned on with the footswitch in the depressed position, the function is switched between "Patch Shift Pedal" and "Hold Pedal." The footswitch setting is set at the factory to "Patch Shift Pedal."

Settings for External Pads or Kick Trigger Units

Setting External Pad Tone and MIDI Parameters

Sound and MIDI parameters can be set for external pads or Kick Trigger Units (connected to the TRIG INPUT jacks) in the same way as for the on-board pads.

If a PD-7, PD-9, PD-120 is connected, each parameter can be set independently for the head and rim.

The method for setting external pad tones is the same as that for internal pads. Make settings after referring to “Selecting and Adjusting Sounds (Sound Parameters)” (p. 22). With external pads, you can make settings for both the head and the rim. To make settings for the head, strike only the head. To make settings for the rim, simultaneously strike the rim and head. (Rim settings apply only to the PD-7, PD-9, and PD-120. However, the rim for the PD-120 can only be used with Trigger Input 1 and 2.) Press the connected pedal when making the Kick Trigger Unit’s tone settings.

Except for the option of making rim settings, MIDI parameter settings for external pads are made the same way as those for internal heads. Make settings after referring to “MIDI Parameter Settings” (p. 61).

NOTE

It is better not to set and layer two different tones and Velocity Curves using the rim’s Pad Bank, since the relative strength is difficult to control precisely.

How to Edit the Trigger Parameters

You can set the sensitivity and make other settings for external pads (TRIGGER parameters). There are four types of TRIGGER parameters available (TRIG SENS, TRIG THRESHOLD, TRIG TYPE, and TRIG CURVE).

Settings for some of these parameters can control both internal and external pads; others can control the external pads only.

Parameter	Internal Pad	External Pad (4 Independent)
TRIG SENS	Common to 8 Pads	OK
TRIG THRESHOLD	Common to 8 Pads	OK
TRIG TYPE	No	OK
TRIG CURVE	No	OK

NOTE

External and internal pads have shared TRIGGER parameter settings.

Adjusting the Sensitivity of a Pad or Kick Trigger Unit (TRIG SENS)

This parameter adjusts the sensitivity of a pad or Kick Trigger Unit. Higher values will result in higher sensitivity (setting range: 1–16). When external pads are connected, you should adjust the relative sensitivity between the external and on-board pads so as to provide a balanced feel for the entire drum kit.

1 In the Edit mode, select the SYSTEM parameter group (p. 21).

2 Use [▲] or [▼] to select TRIG SENS.



3 Strike the pad (or depress the Kick Trigger Unit) you wish to edit.



When you strike the pad, the strength with which the pad is struck (velocity) is shown in the display in six levels. Striking the pad hard sets velocity at a value of 127.

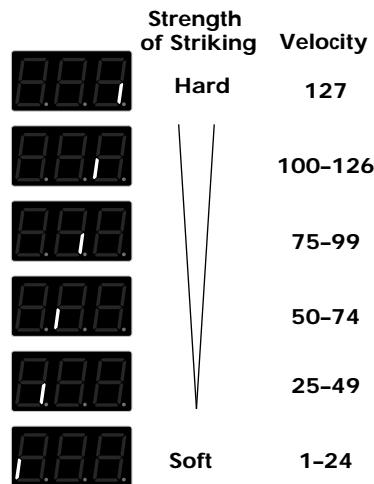

4 Use PATCH/VALUE [-] or [+] to set the value.

About the PD-120's Rim Sensitivity

Available only when making Trigger Type settings to the PD-120, you can set the Rim Sensitivity in Advanced Edit mode (p. 53).

Setting Minimum Levels for the Pads (TRIG THRESHOLD)

By setting this parameter, you can make the pad respond with a trigger signal only when it is struck with a force above a threshold level. This allows you to prevent the pad from picking up extraneous vibrations from neighboring pads. If the striking force is less than the threshold, the pad will not sound. In the following diagram, the statement like “2” of the examples will produce sound (setting range: 0–15.)

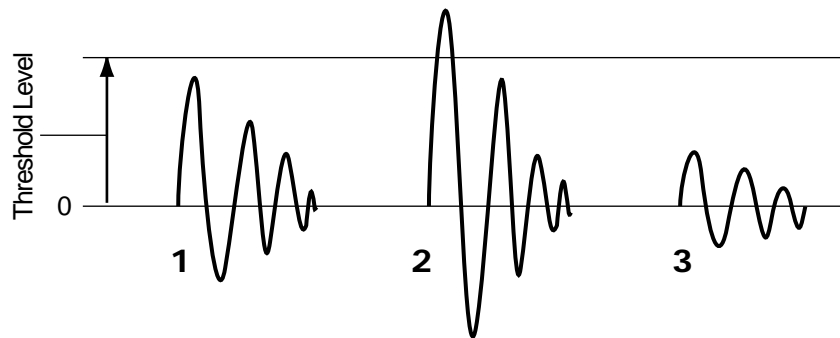

NOTE

To have the unit sound even when struck lightly, set the TRIGGER THRESHOLD as low as possible without triggering other connected pads.

Settings for the internal pads reflect the average user's preferences. If these settings produce good results for you, there is no need to change these values.

1 In the Edit mode, select the SYSTEM parameter group (p. 21).

2 Use [▲] or [▼] to select TRIG THRESHOLD.



3 Strike the pad (or depress the Kick Trigger Unit) you wish to edit.

MEMO

Rim and head feature shared TRIG THRESHOLD settings for all pads (PD-7/9, PD-120).

4 Use PATCH/VALUE [-] or [+] to set the value.

MEMO

When the vibration from striking one external pad causes the Instrument of another pad to play, set Crosstalk Cancel (p. 53).

Selecting Types for External Pads (TRIG TYPE)

The SPD-20's Trigger Inputs allow you to connect and play using a variety of pad types. While the trigger signal output from a pad can have a variety of characteristics depending on the type of pad, you can make sure the trigger signal is read correctly by setting the Trigger Type. In addition, when connecting the PD-120 or other pad models, setting the Trigger Type makes it possible to play rim shots on the PD-120 (p. 39). The Trigger Type is set not only for different drum pad types, but for different acoustic drum triggers as well.

Acoustic Drum Triggers

These are pickups that are attached to acoustic drums. The strength with which the drum is struck is output as a trigger signal, allowing you to play sound modules with Trigger Inputs such as the SPD-20's.

- 1** In the Edit mode, select the SYSTEM parameter group (p. 21).
- 2** Use [▲] or [▼] to select TRIG TYPE.
- 3** Strike the External pad (or depress the Kick Trigger Unit) you wish to edit.



MEMO

Trigger Type rim and head settings are shared for all pads (PD-7/9, PD-120).

NOTE

You cannot make settings for the internal pads. If you try to select the internal head by striking it, "----" is displayed.

- 4** Use PATCH/VALUE [-] or [+] to set the value.

Pad Trigger Types

Displayed	Description
	For the PD-5
	For the PD-7, standard drum pads, other manufacturers' pads
	For the PD-9, low crosstalk (p. 53) pads
	For the PD-100
	For the PD-120
	For other makers' pads (See Note)
	For other makers' pads (See Note)
	For the KD-7, standard kick pads, other manufacturers' pads
	For other manufacturers' kick pads (see Note)
	For other manufacturers' kick Pads (see Note)

(Note) This type of Trigger (TRIG TYPE) is for drum pads whose output of the Trigger signal waveform's attack is slow. In order to reliably detect the strength with which the pad is struck, the time set for detection of the trigger (Scan Time; p. 51) is as slow as 1–2 msec. When using other manufacturers' pads, if while playing with the Trigger Type set to "Pd7" you notice the sound strength or dynamics are unstable, you should reset the Trigger Type to "P1" or "P2."

For faster sound expression, set to "P1" or "P2" ("K1" or "K2").

Acoustic Drum Trigger Types

Displayed	Description
	For kick drums (bass drums)
	For snare drums
	For toms
	For floor toms, toms with 15-inch or bigger heads

Trigger Type Internal Settings (Advanced TRIGGER Parameters)

When you make settings for the Trigger Type, a number of internal parameters that do not appear on the panel are set automatically. These parameters are known as Advanced TRIGGER parameters. Normally, no detailed settings are necessary to match the selected Trigger Type, but when you get poor sound, even having set the Trigger Type, or when using pads or acoustic drum triggers not covered by a particular Trigger Type, then set the Advanced TRIGGER parameters as needed (p. 48).

Advanced TRIGGER Parameter	Description
Scan Time	Sets the time for detecting the trigger signal
Retrigger Cancel	Detects the attenuation of the trigger signal and cancels subsequent incorrect triggering
Mask Time	Cancels secondary sounding of the kick pad and other pads
Crosstalk Cancel	Cancels triggering caused by vibration from other pads
Rim Sensitivity	Adjusts the PD-120's Rim Sensitivity

For more detailed information, refer to (p. 48).

Setting How the Strength with Which External Pads Are Struck Changes the Volume (TRIG CURVE)

With some external pads and acoustic drum triggers, the relationship between the strength with which you strike the pad and the changes in volume output signal is unnatural. To get natural-sounding volume changes, set the Trigger Curve.

1 In Edit mode, select the SYSTEM parameter group (p. 21).

2 Press [▲] or [▼] to select the TRIG CURVE.

3 Strike the external pad (or Kick Trigger Unit) to be set.



MEMO

Trigger Curve rim and head settings are shared for all pads (PD-7/9, PD-120).

You cannot make settings for the internal pads. If you try to select the internal head by striking it, "----" is displayed.

4 Using PATCH/VALUE [+] or [-], set the Trigger Curve (-2, -1, 0, 1, or 2).

Values correspond to the Trigger Curves shown below.

"0" denotes the standard Trigger Curve.

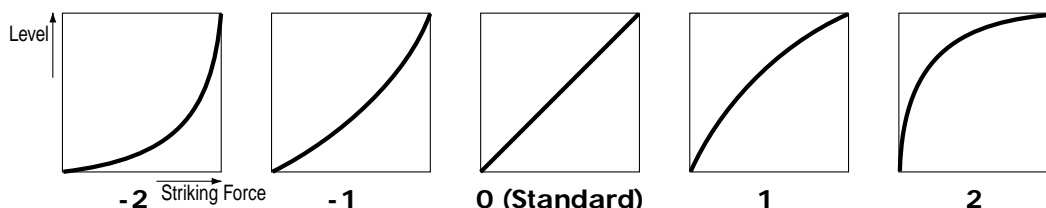

MEMO

To make this setting correctly, set the Trigger Sensitivity before setting the Trigger Curve.

Setting the Same Parameter Values to All Pads

When you press [ALL/ENTER] while in Edit mode, the parameter values that are set in an external pad are set to all external pads that are in the selected pad bank at that time.

HINT

For example, with Trigger Type Pd7 set to Trigger Input 1, by pressing [ALL/ENTER], Pd7 is set to all four Trigger Inputs.

MEMO

If you press [ALL/ENTER] when setting the Trigger Type, the current pad's Advance Trigger parameter settings (p. 48) are applied to all of the other Trigger Inputs.

NOTE

[ALL/ENTER] does not function in Advanced Edit mode (p. 48).

Setting Parameters for Reliable Performance using Acoustic Drum Triggers and Other Manufacturers' Pads (Advanced Trigger Parameters)

Sometimes, when you use the SPD-20 with an acoustic drum trigger or a pad from another manufacturer, setting only the Trigger Type may result in poor sound or mistakenly played sounds. In such cases, by setting the Advanced Trigger Parameters, you can make more detailed trigger parameter settings.

NOTE

Advanced Trigger Parameters are set automatically when the Trigger Type is set. Normally, when you set the Trigger Type, no setting of the Advanced Trigger Parameters is necessary.

The five Advanced Trigger Parameters are as follows:

Scan Time	Sets the time for detecting the trigger signal
Retrigger Cancel	Detects the attenuation of the trigger signal, and prevents subsequent incorrect triggering
Mask Time	Prevents secondary sounding of the kick pad and other pads
Crosstalk Cancel	Prevents triggering caused by vibration from other pads
Rim Sensitivity	Adjusts the sensitivity of the PD-120's rim

How to Set Advanced Trigger Parameters

The process of making settings for the Advanced Trigger Parameters differs from that when making other settings. Special procedures are required to set the parameters in Advanced Edit mode.

NOTE

The Advanced Trigger Parameters cannot be found in the Parameter List on the front panel.

You cannot make Advanced Trigger Parameter settings for internal pads.

There are three modes

Play mode:	The unit is played in this mode.
Edit mode:	Status in which settings are made for the parameters from the parameter list.
Advanced Edit mode:	In this mode, settings can be made for the Advanced Trigger Parameters, which are not included in the parameter list.

First, set the Trigger Type. When you set the Trigger Type, the most suitable Advanced Trigger Parameters values are set automatically.

NOTE

If, after having set the Advanced Trigger Parameters, you then change the Trigger Type setting, the Advanced Trigger Parameter settings revert to the initial values for that Trigger Type.

- 1** In Edit mode, select the SYSTEM parameter group (p. 21).
- 2** Press [▲] or [▼] to select the TRIG TYPE.
- 3** Strike the external pad (or drum pad) to be set.



MEMO

Trigger Type rim and head settings are shared for all pads (PD-7/9, PD-120).

You cannot make settings for the internal pads. If you try to select the internal head by striking it, "---" is displayed.

4 Using PATCH/VALUE [+] or [-], set the Trigger Type.

If you don't find the settings most suitable for your Trigger Type, then set the type you think is closest.

Drum Pad:	Pd7, P 1, P 2
Kick Pad:	Kd7, K 1, K 2
Acoustic Drum Trigger:	KiK, Snr, toM, FLr

MEMO

For descriptions of each of the Trigger Types, see p. 45.

Up to this point, the procedure has been the same as in making normal Trigger Type settings.

After setting the Trigger Type, the following operation is used to enter Advanced Edit mode.

5 Confirm that Trigger Type (TRIG TYPE) in the SYSTEM parameter group has been selected.

6 Hold down [EDIT] for several seconds. This takes you into Advanced Edit mode.

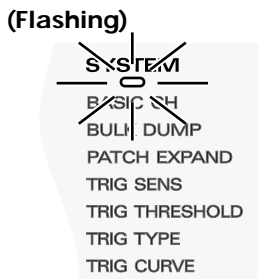

MEMO

In Advanced Edit mode, the SYSTEM Parameter Group indicator flashes.

One second after "Scn" appears in the display, the value is then displayed.

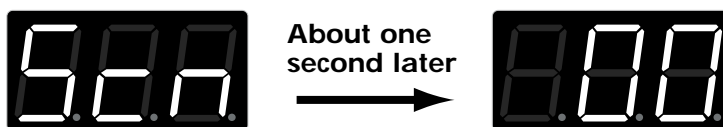

This is the Scan Time settings screen.

NOTE

If the TRIG TYPE settings screen does not come up, consequently, you can not call up the Advanced Edit Mode screens by holding down [EDIT].

7

Press [▲] or [▼] to select the Advanced Trigger Parameter to be set. When you make your selection, the name of the parameter appears, followed one second later by the value for that parameter.



Scn Scan Time



rEt Retrigger Cancel



MSK Mask Time



CrS Cross Talk Cancel



riM Rim Sensitivity



Refer to p. 51 for descriptions of how each of the parameters works.

8

Press PATCH/VALUE [+] or [-] to set the value.



When making settings for another pad, strike the pad first.

9

When you have finished making settings, press [EDIT].

You are returned to the normal Edit mode.

10

Then press [EDIT] once again to return to Play mode.



[ALL/ENTER] does not function in Advanced Edit mode (p. 48).

Overview of the Process of Making Settings in Advanced Trigger Parameters

- In Edit mode, select and set the TRIG TYPE.
- Press [EDIT] for about one second.
- Press [▲] or [▼] to select the parameter to be set. When you select the parameter, then one second after the name of the parameter is displayed, the value appears.
- Press PATCH/VALUE [+] or [-] to set the value.
- After you finish making the settings, press [EDIT] twice to return to PLAY mode.

Adjusting the Trigger Signal Detection Time (Scan Time, Scn)



(Available Settings) 0.0–0.3 ms (0.1 ms steps)

NOTE

00–30 appears in the display.

The trigger signal waveforms produced by some types of drum pads or acoustic drum triggers have rather long attack times, which can result in unstable volume levels, even when the same force is used to strike the pad; or can result in unreliable detection of striking force. In such cases, by adjusting the amount of time between the striking of the pad and detection of that strike (Scan Time), you can achieve the correct detection of striking force.

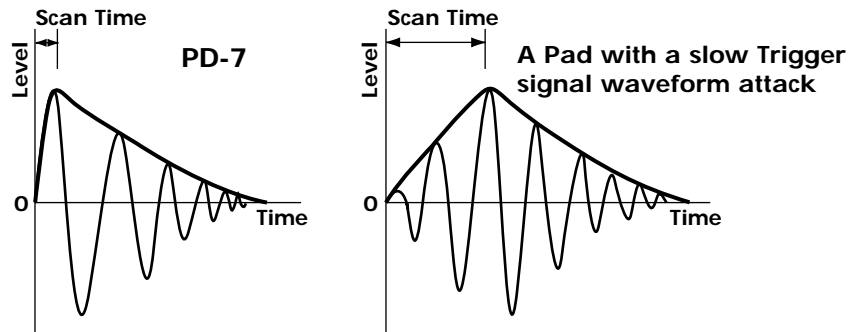

For reliable detection of Trigger signal output, adjust the time for reading the trigger signal (Scan Time). For more on how to set these values, refer to p. 48.

MEMO

To maximize the speed at which sounds are triggered, set the Scan Time value as low as possible.

For P 1 and P 2 trigger types, increase the Pd7 Scan Time values. For K 1 and K 2, increase the Kd7 Scan Time values.

When you strike the pad, the strength with which the pad is struck (velocity) is shown in the display, with six possible levels. When the pad is struck hard, the velocity is set to a value of 127.

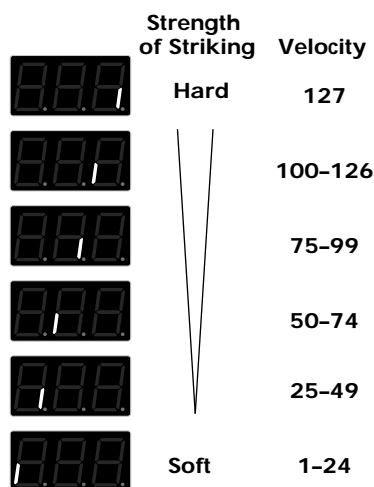

Detecting Trigger Signal Attenuation and Cancelling Incorrect Triggering (Retrigger Cancel, rEt)



(Available Settings) 1–16

Use this setting when your setup uses mainly acoustic drum triggers.

Compared with drum pads, the trigger signal that is output from an acoustic drum trigger may have unnecessarily long attenuation times, and erratic waveforms. Multiple soundings from a single strike to the head are more likely to occur. You can eliminate such symptoms by increasing the Trigger Cancel value.

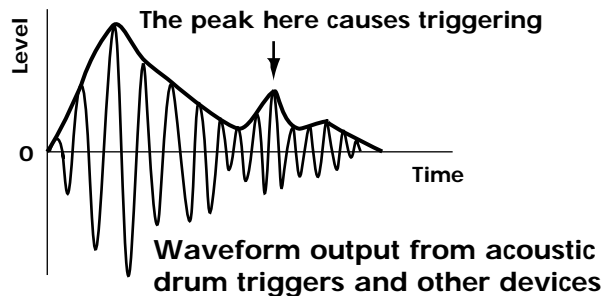
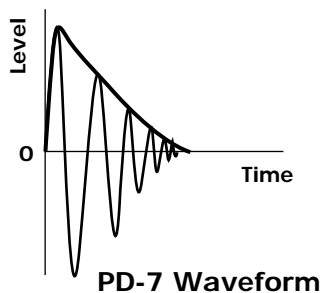

NOTE

If the Retrigger Cancel value is extremely high, individual notes may drop out more readily when you strike repeatedly or play rolls, so set the value as low as possible.

MEMO

The problem of double sounding can also be eliminated using Mask Time. However, Mask Time cannot detect trigger signals if they occur within the specified amount of time after the previous trigger signal was received. Retrigger Cancel detects the attenuation of the trigger signal level, and triggers the sound after internally determining which trigger signals were actually generated when the head was struck, while weeding out the other false trigger signals that need not trigger a sound.

Trigger signal attenuation time varies with the type and workings of the connected acoustic drum trigger.

When using acoustic drum triggers, it is recommended that you mute the acoustic drums to suppress excess head vibration.

For more on how to set these values, refer to p. 48.

Preventing Double Triggering of Kick Pads and Other Instruments (Mask Time, MSK)



(Available Settings) 0–64 (in milliseconds)

Make this setting when using acoustic drum triggers fitted to other manufacturers' kick pads or to acoustic drums.

Sometimes when playing the kick pad or similar instruments, you may be trying to depress the kick pedal to have the beater strike the head just once, but the beater ends up striking twice or more, resulting in mistaken triggering. After a trigger signal is detected, Mask time prevents detection of any subsequent trigger signal only within the set time period, thus eliminating mistaken triggering.

However, since with Mask Time set, absolutely no trigger signal is detected in the set period, in order not to lose any sounds when playing repeated strikes, set the level as low as possible.

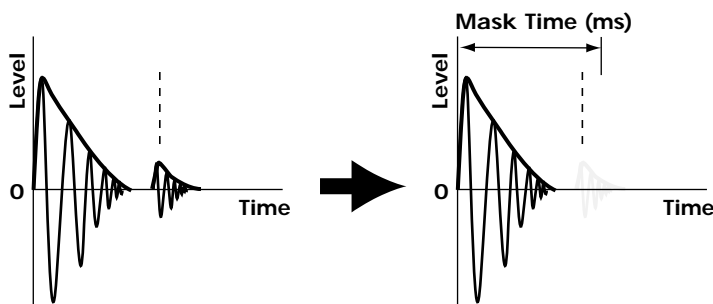

When Mask Time is set, all trigger signals are canceled within the set time.

MEMO

If two or more sounds are being produced when you strike the head just once, then set Retrigger Cancel (p. 52).

For more on how to set these values, refer to p. 48.

Preventing Vibrations from Other Pads from Causing Incorrect Triggering (Crosstalk Cancel, CrS)



(Available Settings) OFF, 30, 40, 50, 60, 70, 80

When different pads, for example one used as a tom and another as a cymbal, are attached to the same stand, vibrations from the tom may cause incorrect sounding of the cymbal pad (this phenomenon is called crosstalk). In this case, you can avoid the problem by setting Crosstalk Cancel on the cymbal pad. The higher the value is set, the more difficult it is for external vibrations to mistakenly trigger the pad.

NOTE

However, if you increase the Crosstalk Cancel value on a pad, then when that pad and another pad are struck simultaneously, the sound from the pad that is struck more weakly may be omitted. To prevent this from occurring, set Crosstalk Cancel values as low as possible.

For more on how to set these values, refer to p. 48.

Setting Rim Sensitivity on the PD-120 (Rim Sensitivity, riM)



(Available Settings) OFF, 1-15

You can set the Rim Sensitivity only when using the PD-120. When you find it difficult to get rim shots to sound, increase the Rim Sensitivity value. When Rim Sensitivity is set to OFF, striking the rim produces the sound of the same Instrument as that of the head.

With the Trigger Type set to 120 (PD-120), you can play rim shots and set the Rim Sensitivity.

MEMO

Rim shots are possible on the PD-120 only with Trigger Inputs 1 and 2.

NOTE

You cannot adjust the rim sensitivity of the PD-7 and PD-9. Both rim and head use the same values.

For more on how to set these values, refer to p. 48.

Settings for an External Hi-Hat Control Pedal

You can use the hi-hat control pedal (FD-7; sold separately) not only to open and close the hi-hat, you can also use it to control the sound effect level sent in real time, and change the pitch (PDL CTRL; p. 54). Additionally, you can send Control Change Data to connected external MIDI devices (PDL CC#; p. 56).

Hi-Hat Control pedal settings are made with FX/PEDAL Parameter Group PDL CTRL, PDL LEVEL, and PDL CC#. To see how to make these settings, refer to each item shown on the following page.



For more on how to connect the pedal, refer to “Precautions When Connecting a Hi-Hat Control Pedal” (p. 40).

Hi-Hat control pedal settings are stored in each Patch.

Controlling the Tone with the Hi-Hat Control Pedal—Pedal Control (PDL CTRL)

Select from the following settings to determine how the hi-hat control pedal exerts control when pressed.

HH	Opened/closed hi-hat sounds (p. 54)
EFS	Tone Effect Send (p. 55)
U07, U12, U24, d05, d12, d24	Raising and lowering of the pitch (p. 55)

- 1** In the Edit mode, select the FX/PEDAL parameter group.
- 2** Use [▲] or [▼] to select PDL CTRL.
- 3** Use PATCH/VALUE [-] or [+] to select the function you wish to control.



You can make settings for each Patch independently.

Controlling the Opening and Closing of the Hi-Hat (HH)

The pedal works as a hi-hat control pedal controlling sounds (H01–H17) assigned to a pad. Stepping on the pedal while striking the pad produces a closed hi-hat sound, and by letting up on the pedal a little at a time, you continuously change the tone and length of the sound from closed, to half-opened, to opened. Additionally, you can get a “foot close” sound by stepping on the pedal more forcefully. You can also get a great “foot open” sound, similar to the sound you get as you lift your foot off the hi-hat.



Set the volume of the pedal hi-hat sound produced with the pedal in PDL LEVEL. For more on how to make these settings, refer to “Adjusting the Volume of the Pedal Hi-Hat Sound” (p. 55).



If a hi-hat sound (H01–H17) is assigned to two or more pads, the pedal hi-hat will sound for the highest-priority pad as shown in next page:

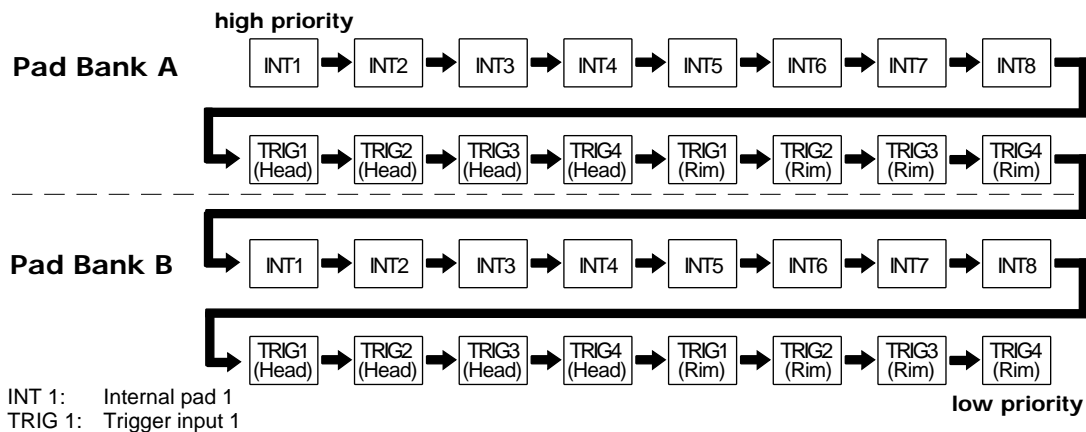

NOTE The Velocity Curve (p. 24) and layer (p. 17) settings do not affect the pedal hi-hat sound.

Control the effect applied to an Instrument (EFS)

When this function is assigned, the hi-hat control pedal will control the effect send level of an Instrument. When the pedal is released, the pad takes the values set for the pad (values set in FX SEND). When the pedal is depressed, the effect send level will be increased proportionally to the angle of the pedal.

Control Instrument pitch (U07/U12/U24/d05/d12/d24)

When this function is assigned, the hi-hat control pedal will control the pitch of an Instrument. When the pedal is released, the pad takes the pitch set for the pad. When the pedal is depressed, the pitch will be modified proportionally to the angle of the pedal.

U07	up	700 cents	(a perfect fifth)
U12	up	1,200 cents	(one octave)
U24	up	2,400 cents	(two octaves)
d05	down	500 cents	(a perfect fourth)
d12	down	1,200 cents	(one octave)
d24	down	2,400 cents	(two octaves)

NOTE

Depending on the type of Instrument or on the sound parameter pitch settings, there may be a point above which the pitch cannot be raised.

Adjusting the Volume of the Pedal Hi-Hat Sound (PDL LEVEL)

When one of the Hi-Hat Cymbals for pedal control (H01–H17) sounds is assigned to the pad, you can control the pedal hi-hat volume when the hi-hat control pedal is pressed. Higher values will result in a louder sound. At a setting of 0, there will be no sound.

- 1** In the Edit mode, select the FX/PEDAL parameter group.
- 2** Use [▲] or [▼] to select PDL LEVEL.
- 3** Use PATCH/VALUE [-] or [+] to set the volume (0–15).

Using the Hi-Hat Control Pedal's Action to Set Controller Numbers for Sending and Receiving MIDI Data (PDL CC#)

When not using an external MIDI device, Setting Pedal Controller Numbers is unnecessary.

You can transmit the action of the hi-hat control pedal as Control Change messages sent to external MIDI devices and have Control Change messages sent from external sources act as pedal movements.

A main way to use this setup is by controlling one more SPD-20 hi-hat, and by continuously pressing the pedals, you can do things like add modulation to the sounds from external MIDI sound modules.

However, there is no need to be able to receive the Controller Numbers set here to external MIDI devices.

MEMO

For explanations of Control Change messages and Controller numbers, refer to p. 59.

Send and Receive Controller Numbers are as shown below.

Controller Number	
1	Modulation
4	Foot
10	Pan
11	Expression
16	General Purpose 1
17	General Purpose 2
64	Hold
oFF	No Transmission

MEMO

The Controller Number is set at the factory to 4 (Foot). You can control the SPD-20, TD-10, TD-7, and TD-5 hi-hats with this setting. For control of the SPD-11 hi-hat, set the number to 1 (Modulation).

When recording SPD-20 a performance to a sequencer, and playing back the same performance, set the Controller Number to 4 (Foot). This way, you can faithfully reproduce the action of the hi-hat control pedal.

-
- 1** In Edit mode, select the FX/PEDAL parameter group.

 - 2** Press [▲] or [▼] to select PDL CC#.

 - 3** Using PATCH/VALUE [+] or [-], select the Controller Number.

Refer to the above Controller Number.

NOTE

If you switch to a Patch set with a different Pedal Controller Number while the hi-hat control pedal is pressed, the connected external sound module ends up being set with the Control Change message value set in the immediately preceding Patch. For example, Modulation will constantly be applied to the external sound module.

When each Patch is set with a different Controller Number, we recommend that you not switch Patches with the pedal depressed. If you do switch Patches while the pedal is pressed, the external sound module is then set with the Control Change message value just as it is. When you then revert to the original Patch by releasing the pedal, the Control Change message value reverts to its initial setting.

CHAPTER 4 Connecting MIDI Devices

MIDI Connections

When connected to other MIDI devices, the SPD-20 can be used in a wide variety of musically creative ways. For example, it can be connected to a sequencer as a pad controller for realtime input, and its on-board sound generator can be layered with external sound modules. Other applications include using a sequencer to automatically select SPD-20 Patches, or to store SPD-20 data in a sequencer or other MIDI Bulk storage device.

Example of one way to connect when using the SPD-20 to control an external sound module

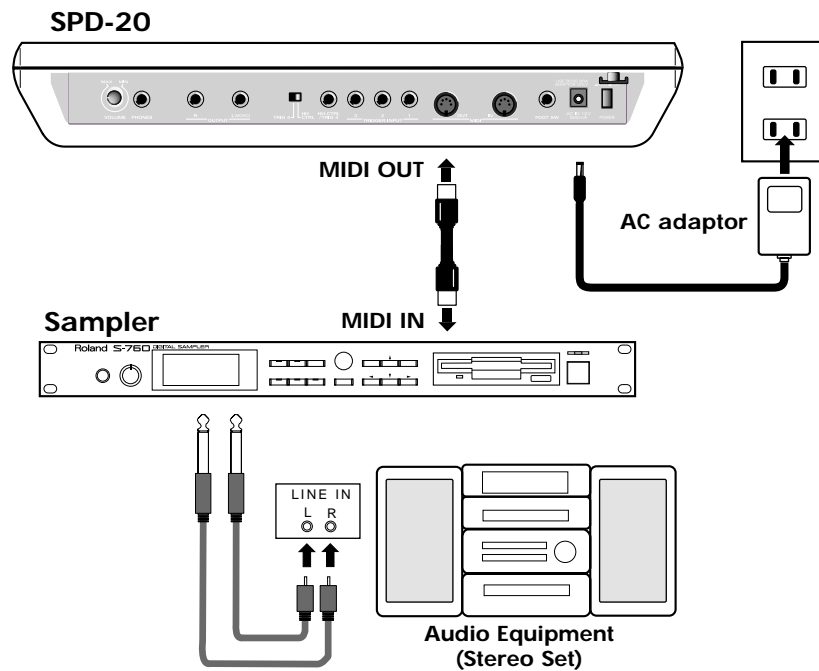

About MIDI

MIDI is an acronym for “Musical Instrument Digital Interface,” and is a standard by which electronic musical Instruments and computers can exchange musical data. The SPD-20 conforms to the MIDI specification and can be connected to other devices to either control, or be controlled.

How MIDI Data is Sent and Received

First, we will briefly explain how MIDI data is sent and received.

MIDI connectors

MIDI data is sent and received through the following connectors. Use a MIDI cable to connectors these connectors to other devices.

- MIDI IN: receives data from other MIDI devices
- MIDI OUT: transmits data to other MIDI devices
- MIDI THRU: re-transmits the data received via MIDI IN

The SPD-20 does not have a MIDI THRU connector.

It is possible to connect (“daisy chain”) several MIDI devices using the MIDI THRU connectors, but you should keep the total length of MIDI cables within 10 meters, to prevent possible reception errors.

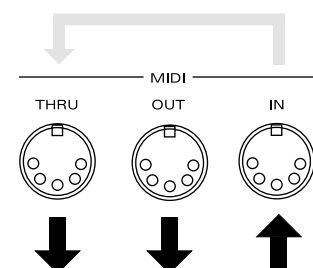

NOTE

MIDI channels

MIDI allows you to independently control two or more devices over a single MIDI cable. This is possible because MIDI provides for multiple channels of control. You can think of MIDI channels as being similar to television channels. Although many broadcast channels are in the air at any one time (many channels of MIDI data are moving through a single cable), a television set receives only the channel to which it is set (the MIDI device receives only the channel to which it is set).

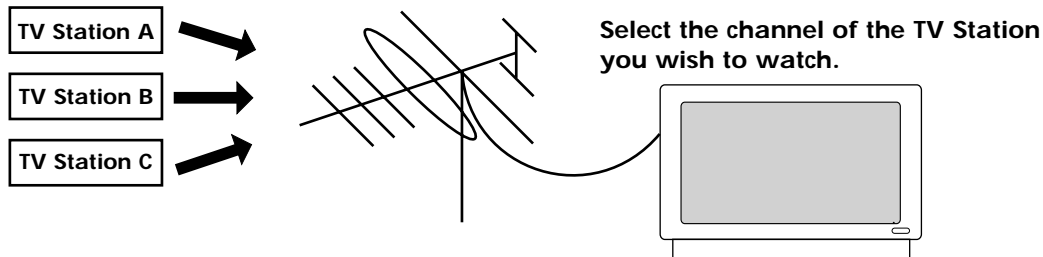

TV messages from various TV Stations are sent through the antenna's cable.

MIDI provides sixteen channels, 1–16, and the receiving device will only receive data when its receive channel matches the Transmit Channel. In the following diagram, playing the keyboard will cause only sound module B to play.

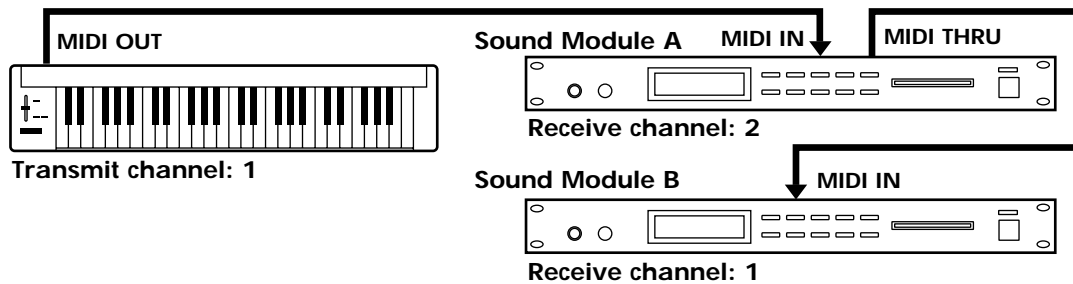

With the SPD-20, you can set the Transmit Channel (TX CH) for each pad (p. 61). Settings for the receiving end are made with the Basic Channel (BASIC CH) (p. 67).

Main Types of MIDI Data Used by the SPD-20

A wide variety of musical data can be transmitted by MIDI, with a different type of MIDI message provided for each type of data. MIDI messages can be broadly categorized into two groups: information that is differentiated by channel (Channel messages) and information that is not differentiated by channel (System messages).

Data differentiated by channel (Channel messages)

These messages carry musical performance data. Normally, these messages do most of the work. The result that each type of message produces will depend on the settings of the sound module.

- **Note messages**

These messages notify the sound generator that a pad has been struck. (A keyboard would transmit these messages when keys are played.) Note messages convey the following information.

- Note Number: Each note message (Note On or Note Off) carries the Note Number which was assigned to that pad (a number indicating the note position on a keyboard).
- Note On: This message is transmitted when a pad is struck (when a key is played).
- Note Off: This message is transmitted when the specified Gate Time has elapsed after the Note On message (when a key is released).
- Velocity: Each note message contains data indicating how strongly the pad was struck (how strongly the key was played).

The Note Numbers fall within the range of 0–127, with middle C (C4) as number 60 (p. 62).

Note numbers usually specify the pitch of the sound to be produced, but for rhythm sound generators, they specify the type of drum sound (the Instrument) which is to be played.

MEMO

With the SPD-20, Note Numbers for transmitting and receiving are set with the MIDI parameter NOTE #.

- **Aftertouch messages**

Aftertouch messages are transmitted by some keyboards when you press down on the keyboard after playing a note. The degree of pressure (aftertouch) can thus be used to control various aspects of the sound. There are two types of aftertouch messages. Data which is transmitted independently for each key is called Polyphonic Key Pressure, and data which is transmitted for the overall keyboard (without differentiating between individual keys) is called Channel Key Pressure.

MEMO

The SPD-20 transmits Polyphonic Key Pressure messages when the rim area of a pad (PD-7, PD-9) is squeezed or released. When the SPD-20 receives Polyphonic Key Pressure messages from another MIDI device, its sound will be affected in the same way as when the rim area of a pad is squeezed.

- **Program Change messages (1–128)**

These messages are usually used to select sounds.

MEMO

The SPD-20 can transmit Program Change messages to select Patches on external sound modules (p. 65). When the SPD-20 receives a Program Change message from another MIDI device, the Patch will change (p. 69).

- **Control Change messages**

These messages convey various types of information that make a musical performance more expressive. Each message carries a control number that indicates which function it is to control. The result will depend on the MIDI device.

MEMO

With the SPD-20, you can transmit PAN Control Change messages to each pad individually.

The SPD-20 transmits movements of the hi-hat control pedal as Control Change messages (p. 56). When it receives Control Change messages from another MIDI device, its sound will be affected in the same way as when the pedal is moved.

Data not differentiated by channel (System messages)

System messages include Exclusive messages as well as other messages that keep a MIDI system running smoothly.

- **Exclusive messages**

Exclusive messages are used to transmit and receive data which is unique to a particular device (such as Patch data). This type of data can be received and transmitted between devices of identical type and manufacturer. For details, refer to the MIDI Implementation (p. 98).

- **Start**

This message starts playback of a song on a sequencer from the beginning of the song.

- **Stop**

This message stops playback of the sequencer song.

- **Continue**

This message is for starting playback of a sequencer song from the current location.

MEMO

With the SPD-20, you can make external sequencers start, stop, and continue by striking the pads (p. 61).

- **Song Position Point**

This message tell the connected sequencer to move the current location in the song.

MEMO

With the SPD-20, you can return to the first measure of a sequencer song by striking the pad (p. 61).

- **Active sensing**

These messages are used to monitor the integrity of MIDI connections. If no MIDI messages are received within a specific length of time, the device assumes that the connection has been broken (e.g., a cable disconnected) and will reset itself according to a specific procedure.

How to Read the MIDI Implementation Chart

MIDI has made it possible for a wide variety of devices to exchange information, but it is not always true that all types of MIDI messages can be exchanged between all types of devices.

To help you quickly determine what types of MIDI messages can be exchanged between master and slave, the manual of each MIDI device includes a MIDI Implementation chart. By looking at this chart, you can quickly see what messages the device is able to transmit and receive. MIDI Implementation charts are standardized, so you can fold the charts together to see at a glance how the two devices will communicate.

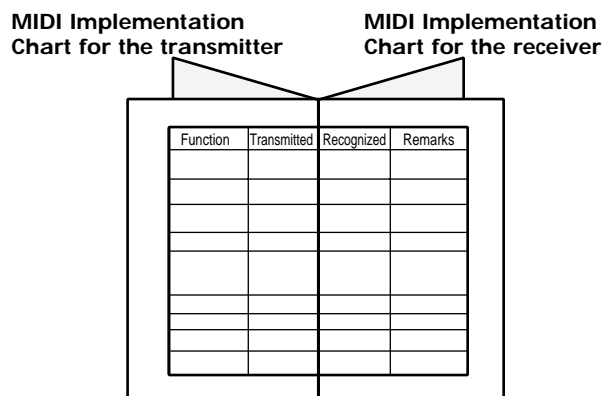

MEMO

A MIDI Implementation chart for the SPD-20 is included in page 102 .

MIDI Parameter Settings

If you wish to use the SPD-20 to control another MIDI sound module, or use another MIDI device to control the SPD-20, you will need to set the MIDI parameters.



You can set MIDI parameters for each pad in a pad bank (A and B), allowing you to control external sound modules on two channels. Additionally, MIDI parameters can be set to Patches.

For more on how to set MIDI parameters, refer to p. 66.

How the MIDI Parameters Work

Transmit Channel (TX CH)

Set this parameter to match the receive channel of the MIDI sound module you have connected. If you want a pad to play only the SPD-20's sounds, set this parameter to "oFF."

Besides the Transmit Channel, settings for transmitting Program Numbers by striking the pad, and for transmitting Start and Stop messages to external sequencers are also made in the TX CH settings.

Using the Pads to Play External Sound Modules

1-16: When playing external sound modules, Note messages are sent through the Transmit Channels set here. If you find it unnecessary to make any special setting for this, just set it to 10 (the initial value).



If you switch Patches while setting Program Changes (PGM CHG; p. 65), the Program Number is sent through the TX CH (1-16) set here.

When You Are Not Sending MIDI Messages

oFF: MIDI messages are not transmitted.

Using the Pads to Control External Devices

With these settings Note messages are not transmitted.

P1-P16: Set this when using the pad to switch external sound module tones. The Program Number set to Program Change (PGM CHG; p. 65) is sent via the MIDI channel 1-16 (P1-P16) according to the timing with which you strike the pad.

S-S: Controls external sequencers and other devices by mutual transmission of MIDI Start and Stop messages when the Pad is struck.

C-S: Controls external sequencers and other devices by mutual transmission of MIDI Continue and Stop messages when the pad is struck.

toP: Returns the external sequencer's Song Position to the first measure of the song.



External sound modules cannot be played when you set oFF, P1-P16, S-S, C-S, or toP, since the Note Numbers are not transmitted. Pads set with these parameters are dedicated pads for controlling external sound modules or external MIDI devices.

Note Number (NOTE #)

Set this parameter to the sound (note) of the MIDI sound module you want to play from that pad (0-127/oFF).

Correspondence between Note Numbers and Note Names

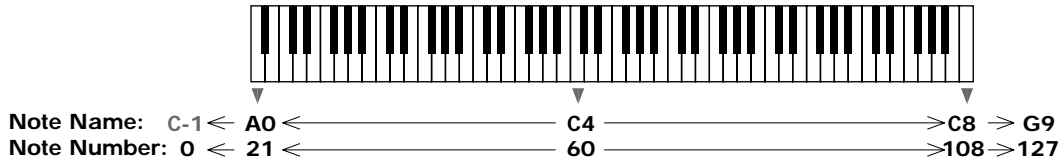

When setting the same Note Numbers to a number of pads within the same Patch, the same Note Numbers and Note Messages are transmitted from each pad. However, when identical Note Numbers and Note Messages are received, only the tone set to the highest priority pad (p. 67) is expressed. When making settings such as these, the indicator flashes more quickly, informing you that there are non-effective settings.

About Note Numbers for HI-Hats Controlled with Pedals

Normally one Instrument will be assigned one Note Number. However, a hi-hat sound (H01-H17) controlled by a hi-hat control pedal will automatically be given three note numbers; the displayed Note Number and the two note numbers immediately below it. Only the highest Note Number will be displayed.

Sound of an Instrument

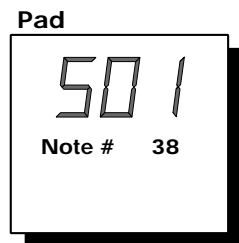

Hi-Hat sound controlled by a Pedal

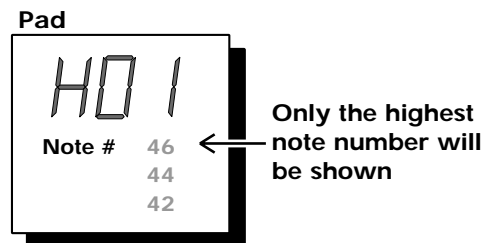

For example, suppose that H01 has Note Number 46 assigned to it. With the pedal depressed, if you strike the pad to which H01 is assigned, Note Number 42 will be sent. If you strike the pad without depressing the pedal, Note Number 46 will be sent. If you depress the pedal without striking the pad, Note Number 44 will be sent.

Gate Time (GT TIME)

This parameter determines the length of time that the MIDI sound module will produce sound (0.1 second–4.0 seconds, ALt).

NOTE *Settings values shown in the display are 01–40 and ALt (0.1–4.0 seconds and Alternate).*

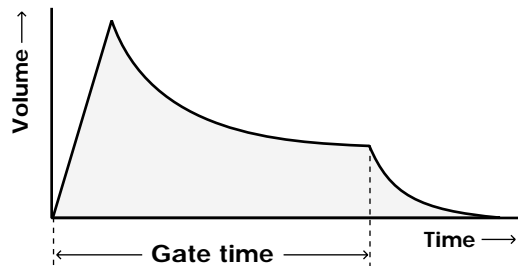

This Gate Time parameter corresponds to the length of time a note is held (on a MIDI keyboard) before it is released.

When you set “ALt”, Note On and Note Off are alternately transmitted when you strike the pad. When using samplers and other such devices, you can strike a pad to start a sampler phrase loop, and stop the phrase loop the next you strike the same pad.

NOTE *If the MIDI sound module ignores Note Off messages, this Gate Time parameter will not affect the length of the note (Drum sound modules and other sound modules).*

The actual length of time the note sounds will depend on the settings of the MIDI sound module.

MEMO *If you are using a pad to play a sound that has a slow attack, the note may be too quiet or may be cut off too quickly. If so, increase the Gate Time.*

Pan (PAN)

If you have connected a MIDI sound module that can receive Pan Control Change messages (control number 10), this parameter allows you to specify the stereo position (L7–Ctr–r7/rnd/oFF). With a setting of “rnd” the stereo position will change randomly each time you strike the pad. With a setting of “oFF,” Pan messages will not be transmitted.

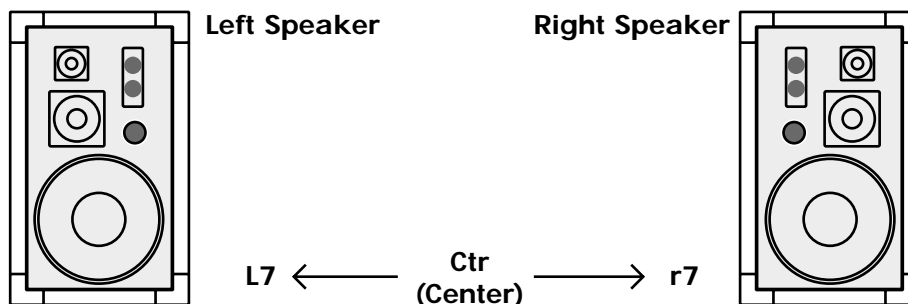

NOTE *If the MIDI sound module ignores Pan Control Change messages (control number 10), this Pan parameter will not affect the stereo position.*

MIDI Velocity Curve (CURVE)

When changing the strength with which you strike the pad, select from the following 16 types of velocity curves for transmitting Velocity values (volume changes) from MIDI OUT.

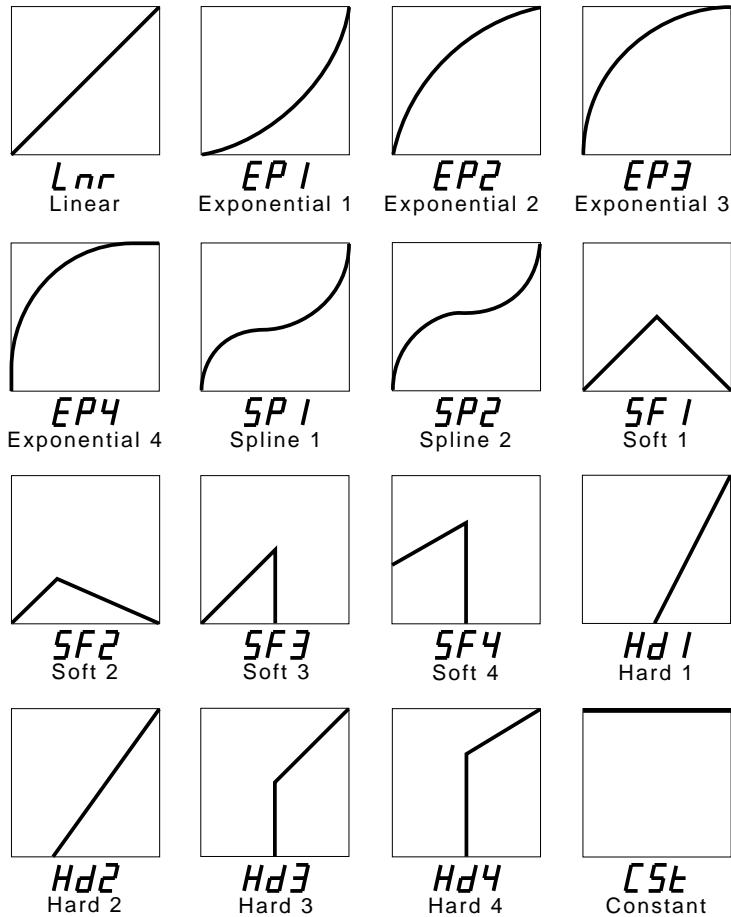

If this parameter is set to “CSt” (constant), the volume will be the same for each note—regardless of how strongly or softly you strike the pad. In this case, you will adjust the velocity Sensitivity parameter to set the volume.

Velocity Sensitivity (SENS)

When striking the pad, you can adjust the Velocity Sensitivity (1–15) transmitted to a MIDI device. Sensitivity increases as the value is raised, allowing you to transmit high Velocity levels even when striking the pad softly.

If the Velocity Curve parameter has been set to “CSt,” velocity will be transmitted with the following value.

Sensitivity	Velocity	Sensitivity	Velocity
1	1	9	73
2	10	10	82
3	19	11	91
4	28	12	100
5	37	13	109
6	46	14	118
7	55	15	127
8	64		

Program Change (PGM CHG)

By transmitting Program Change messages, the SPD-20 can select sounds on another MIDI device. This parameter specifies the Program Number transmitted when Patches are switched (1–128, oFF). In the Edit mode, each time you modify this parameter, a Program Change message will be transmitted immediately from MIDI OUT, so that you can then strike the pad to check the external sound module. If you do not wish to transmit Program Change messages, set this parameter to “oFF.”

Each Pad will transmit a Program Change message on its assigned MIDI channel whenever a Patch is selected in the Play mode. If two or more pads are assigned to the same MIDI channel and have been set to transmit different Program Numbers, only the highest-priority pad will transmit the Program Change (p. 67).



If while editing you attempt to make such a conflicting setting, the display will flash more rapidly to warn you. Also, Program Change messages for the lowest-priority pad will not be transmitted from the conflicting pad.



When transmitting Program Numbers set with Program Change (PGM CHG) by striking the pad, set the Transmit Channel (TX CH) to (P 1–P16) (p. 61). However, Note Numbers from a pad set like this are not transmitted, so you cannot use them to play an external sound module.

The following table shows how the numeric display (1–128) corresponds to the GBN (Group/Bank/Number) Program Number scheme used in Roland devices.

Group A		Group B	
		Number	
Bank	Number	Bank	Number
1	1 2 3 4 5 6 7 8	1	65 66 67 68 69 70 71 72
2	9 10 11 12 13 14 15 16	2	73 74 75 76 77 78 79 80
3	17 18 19 20 21 22 23 24	3	81 82 83 84 85 86 87 88
4	25 26 27 28 29 30 31 32	4	89 90 91 92 93 94 95 96
5	33 34 35 36 37 38 39 40	5	97 98 99 100 101 102 103 104
6	41 42 43 44 45 46 47 48	6	105 106 107 108 109 110 111 112
7	49 50 51 52 53 54 55 56	7	113 114 115 116 117 118 119 120
8	57 58 59 60 61 62 63 64	8	121 122 123 124 125 126 127 128

GBN system

This is a way of organizing Patch memory select buttons into Groups (A/B), Banks (1–8) and Numbers (1–8), which is used on many Roland synthesizers and sound modules.

Setting MIDI Parameters

Since MIDI parameters can be set independently for each pad bank (A and B), each pad can control two external sound modules.

1 In the Play mode, use PATCH/VALUE [-] or [+] to select the Patch (1-99) for which you wish to make settings.

2 Press [EDIT] to enter the Edit mode.

3 Use [SELECT] to select the MIDI parameter group.

4 Use [▲] or [▼] to select the parameter you wish to set.

5 Press [BANK A/B] to select the pad bank you wish to set.

6 Strike the pad you wish to set.

NOTE

If you have a PD-7, PD-9, or PD-120 connected, you can make independent settings to the pad and rim. When making MIDI parameter settings to the rim, play a rim shot to call up the trigger settings.

7 Use PATCH/VALUE [-] or [+] to set the parameter value.

MEMO

The value will change more rapidly if you press [+] while holding [-].

If you press [ALL/ENTER] at this point, the currently displayed value will be set for all pads. If you are making settings for an internal pad, this will apply to all 8 internal pads. If you are making settings for an external pad, this will apply to the 4 external pads and rims.

You can strike the pad to hear the edited sound. If you have layered two sounds, it is probably a good idea to press [LAYER] to turn Layer off.

8 To set parameters for the other pad bank, repeat steps 5-7.

9 If you wish to set the same parameters for other pads, repeat steps 6-7. If you wish to set different parameters for the other pads, repeat steps 4-8.

10 Press [EDIT] once again to return to the Play mode.

Layer

When Layer is on, two note messages will be transmitted each time you strike a pad. By making appropriate MIDI Velocity Curve settings for each pad bank (A and B), you can create effects such as velocity crossfades for external sound modules.

MEMO

If you set Layer to Velocity Switch, be sure that the SENS parameter is set to the same value for both pad banks (A/B). By changing the SENS value, you can shift the switching point of two sounds otherwise.

Priority Ranking of Note Number Expression

When there are two or more sounds corresponding to Note Numbers that are received, only the sound that is set to the highest priority Pad (according to the following chart) is played.

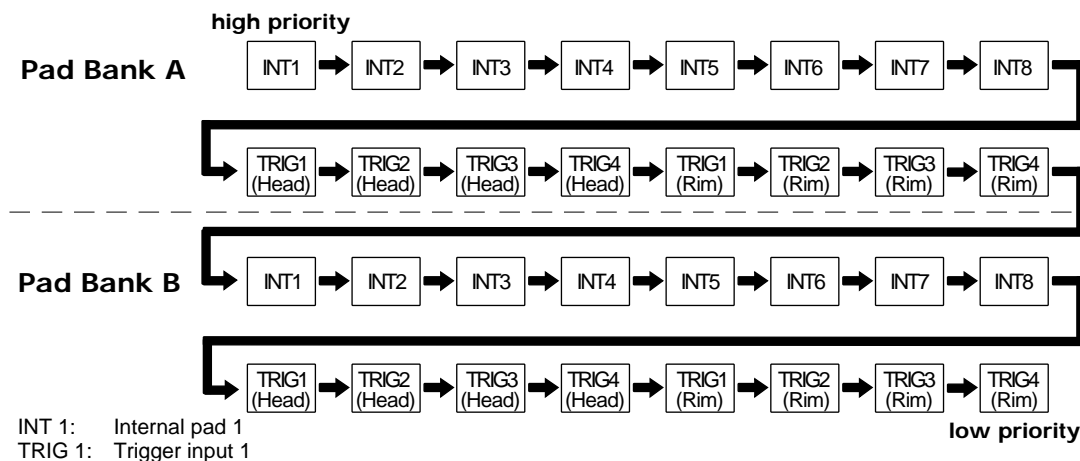

MEMO

If different Program Numbers are set to multiple pads that are set to the same Transmit Channel, then when you switch Patches, the Program Number of the highest priority pad is transmitted.

Using the SPD-20 as a MIDI Sound Module

Incoming MIDI messages from an external device can also trigger the SPD-20's sounds. The Instruments specified by the sound parameters for each pad will be played by incoming note messages of the Note Number specified for each pad. Incoming note messages are received on the Basic Channel.

4

Setting the Receive Channel (Basic Channel)

The SPD-20 receives MIDI messages (note messages, Program Change messages, Control Change messages) on its Basic Channel. When using an external MIDI device to play the SPD-20's sound generator, set the Transmit Channel of the external MIDI device to match the Basic Channel of the SPD-20.

- 1** In the Edit mode, press [SELECT] to select the SYSTEM parameter group.
- 2** Use [▲] or [▼] to select BASIC CH.
- 3** Use PATCH/VALUE [-] or [+] to specify the channel number (1-16).
- 4** Press [EDIT] to return to the Play mode.

Settings for Each Pad

Here's how to specify the Instrument (and its Note Number) that will be played by incoming MIDI messages.

- 1** In the Play mode, use PATCH/VALUE [-] or [+] to select the Patch (1–99) for which you wish to make settings.
- 2** Press [EDIT] to enter the Edit mode.
- 3** Strike the pad you wish to set.
- 4** Select an Instrument using INST in the SOUND parameter group (p. 22).
- 5** Select the note number (0–127) by using NOTE # in the MIDI parameter group (p. 62).
Now when the specified Note Number is received from the external device, you will be able to check the sound.
- 6** If you wish to make settings for other pads, repeat steps 3–5.
- 7** Press [EDIT] to return to the Play mode.

MEMO

If you have specified the same Note Number for two or more pads, each pad will transmit the same Note Number. However, if a note message of that number is received, only the Instrument assigned to the highest-priority pad will sound (p. 67). If you attempt to make such a conflicting setting, the display will flash more rapidly to inform you that the setting is invalid.

NOTE

If the Patch Expand function (p. 69) is on and more than two same note numbers are included in these five Patches, the display will also flash more rapidly.

Remember that three note numbers are assigned to each Hi-Hat Cymbal for pedal control sound (H01–H17). If even one of these three note numbers coincides with a Note Number assigned to another pad, only the highest-priority pad will sound. For example, if Note Number 38 has been assigned to the S01 sound for pad number 1, and Note Number 42 has been assigned to the H01 sound for Pad number 2, the H01 sound will not be heard. If you attempt to make such a conflicting setting, the display will flash more rapidly to inform you that the setting is invalid.

MEMO

By switching the Layer on/off, the way of note message processing will be changed;

Layer Off: *Each of the Note Numbers set to pad banks A and B are transmitted when received.*

Layer On: *When received, the Note Number in pad bank B is ignored, while the Note Number in pad bank A is played.*

Using External MIDI Devices to Play the Internal Sound Generator

- 1** Set the Transmit Channel for the external MIDI device to match the Basic Channel of the SPD-20 (p. 67).
- 2** If necessary, use PATCH/VALUE [-] or [+] to select a Patch.
- 3** When you play the external MIDI device, the SPD-20 will sound.
When a note message is received from the external MIDI device, the Instrument selected for the pad set to the corresponding Note Number will sound.



If a Program Change message is received on the Basic Channel (p. 67), the corresponding Patch (1–99) will be selected. (Only in the Play mode.)

The SPD-20 will not respond to incoming Program Numbers 100–128 for patch changes.

Expanding Patches to Allow Reception of Many Note Numbers (Patch Expand)

For each Patch of the SPD-20, 32 sounds can be selected. (If Layer is on, 16 sounds.) However, when using the unit as a MIDI sound module to play drum parts in GM System, GS Format, and other formats, this is an insufficient number of sounds. Therefore, the Patch Expand function is provided to make more sounds available for control from an external MIDI device. When Patch Expand is turned on, the sounds selected for Patches 96–99 will also be available, in addition to the currently selected Patch. (This provides a total of five Patches that can be played simultaneously via MIDI.) Note Numbers 27–90 are set at the factory to each of the pads with Patch Numbers 96–99 (p. 70).



The settings for the FX/PEDAL and FX/ON OFF will apply to the settings of currently selected Patch.

4

How to turn the Patch Expand function on

- 1** In the Edit mode, press [SELECT] to select the SYSTEM parameter group.
- 2** Use [▲] or [▼] to select PATCH EXPAND.
- 3** Use PATCH/VALUE [-] or [+] to turn the Patch Expand function on.
- 4** Press [EDIT] to return to the Play mode.

When the Patch Expand function is on, an “E” will be displayed to the left of the Patch number when you are in the Play mode.



MEMO

When you make settings for the Patch Chain (p. 33) while the Patch Expand function is on, the display will indicate the selected patch chain (A, b, c, d, e, F, G, H) only.

NOTE

In order to make distinct the "E" indicating Patch Expand, a lower case "e" is used to indicate Patch Chain.



Patch Expand function is On



Patch Chain "e"

Contents of the Patches used for the Patch Expand function

The contents of the Patches used for the Patch Expand function (Patch numbers 96–99) are initially set as follows:

Patch Number 96

pad	note#	instrument
A01	27	d19 High-Q 1
A02	28	E25 Shot 4
A03	29	d06 Scratch Push
A04	30	d07 Scratch Pull
A05	31	S81 Hall Cross Stick
A06	32	A01 DR-55 Claves
A07	33	A03 CR-78 Metallic Beat
A08	34	A03 CR-78 Metallic Beat
B01	35	b23 Mondo Kick
B02	36	b01 Dry Kick
B03	37	S80 Ambient Cross Stick
B04	38	S37 L.A. Fat Snare
B05	39	d01 Hand Clap 1
B06	40	S46 Rock Snare
B07	41	t22 Real Tom 2
B08	42	h01 Pop Closed Hi-Hat Inner

Patch Number 98

pad	note#	instrument
A01	59	C31 Brush Ride Cymbal
A02	60	L03 Bongo High
A03	61	L04 Bongo Low 1
A04	62	L09 Conga High Mute
A05	63	L11 Conga High Open
A06	64	L12 Conga Low Open 1
A07	65	L30 Timbale High
A08	66	L31 Timbale Low
B01	67	L38 Agogo 3
B02	68	L38 Agogo 3
B03	69	L39 Cabasa
B04	70	L23 Maracas
B05	71	L64 Samba Whistle Short
B06	72	L65 Samba Whistle Long
B07	73	L21 Guiro Short
B08	74	L22 Guiro Long

Patch Number 97

pad	note#	instrument
A01	43	t22 Real Tom 2
A02	44	h05 Pop Pedal Hi-Hat
A03	45	t22 Real Tom 2
A04	46	h04 Pop Open Hi-Hat Outer
A05	47	t21 Real Tom 1
A06	48	t21 Real Tom 1
A07	49	C01 Crash Cymbal 1
A08	50	t21 Real Tom 1
B01	51	C15 Ride Cymbal 1
B02	52	C06 Chinese Cymbal 2
B03	53	C16 Ride Bell Cymbal 1
B04	54	L27 Tambourine 1
B05	55	C02 Crash Cymbal 2
B06	56	L14 Cowbell 1
B07	57	C02 Crash Cymbal 2
B08	58	L33 Vibra-Slap

Patch Number 99

pad	note#	instrument
A01	75	L19 Claves 1
A02	76	o07 Wood Block
A03	77	o07 Wood Block
A04	78	L43 Cuica Mute 1
A05	79	L45 Cuica Open
A06	80	o03 Triangle Mute
A07	81	o04 Triangle Open
A08	82	L24 Shaker 1
B01	83	o01 Sleigh Bell
B02	84	F15 Bell Tree
B03	85	o05 Castanets
B04	86	L54 R-8 Surdo Mute
B05	87	L55 R-8 Surdo Open
B06	88	L10 Conga High Slap
B07	89	J40 Small Gong
B08	90	J39 Large Gong

MEMO

In the contents of Patch Expand Patches, note numbers 35–81 are compatible with GM Percussion Map which can be used to select Percussion sounds under the General MIDI System, and note numbers 27–87 are compatible with GS Standard Set which can be used under the GS Format.

General MIDI System

The General MIDI system is a set of recommendations which seeks to provide a way to go beyond the limitations of proprietary designs, and standardize the MIDI capabilities of sound generating devices. Sound generating devices and music files that meets the General MIDI standard bears the General MIDI logo (). Music files bearing the General MIDI logo can be played back using any General MIDI sound generating unit to produce essentially the same musical performance. General MIDI supports the GM Percussion Map in channel 10.

GS Format

The GS Format () is Roland's set of specifications for standardizing the performance of sound generating devices. In addition to including support for everything defined by the General MIDI System, the highly-compatible GS Format additionally offers an expanded number of sounds, provides for the editing of sounds, and spells out many details for a wide range of extra features, including effects such as reverb and chorus.

Designed with the future in mind, the GS Format can readily include new sounds and support new hardware features when they arrive.

Since it is upwardly compatible with the General MIDI System, Roland's GS Format is capable of reliably playing back GM Scores equally as well as it performs GS Music Files (music files that has been created with the GS Format in mind). The GS Standard set is one of the percussion sets which can be used in GS drum part. (Default; ch 10.)

MEMO

The contents of the Patches used by the Patch Expand function (Patches 96–99) can be modified in the same way as other Patches.

Sounding Priority when Patch Expand is On

If more than two sounds are set to the same note number and they receive the corresponding note number, only one sound will play, in the priority shown in the following diagram.

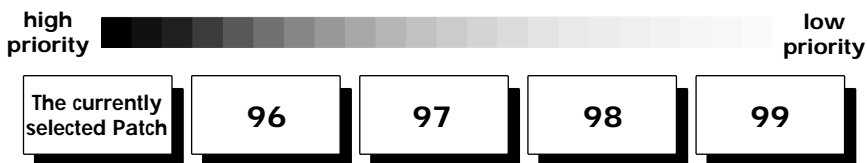

How to Use a Sequencer or a Computer to Record/Play back Your Performance

When you wish to record or play back the musical performance of your SPD-20, you must make connections properly and make settings (such as Local Control off) before you begin recording.

Connecting a Computer (or a Sequencer)

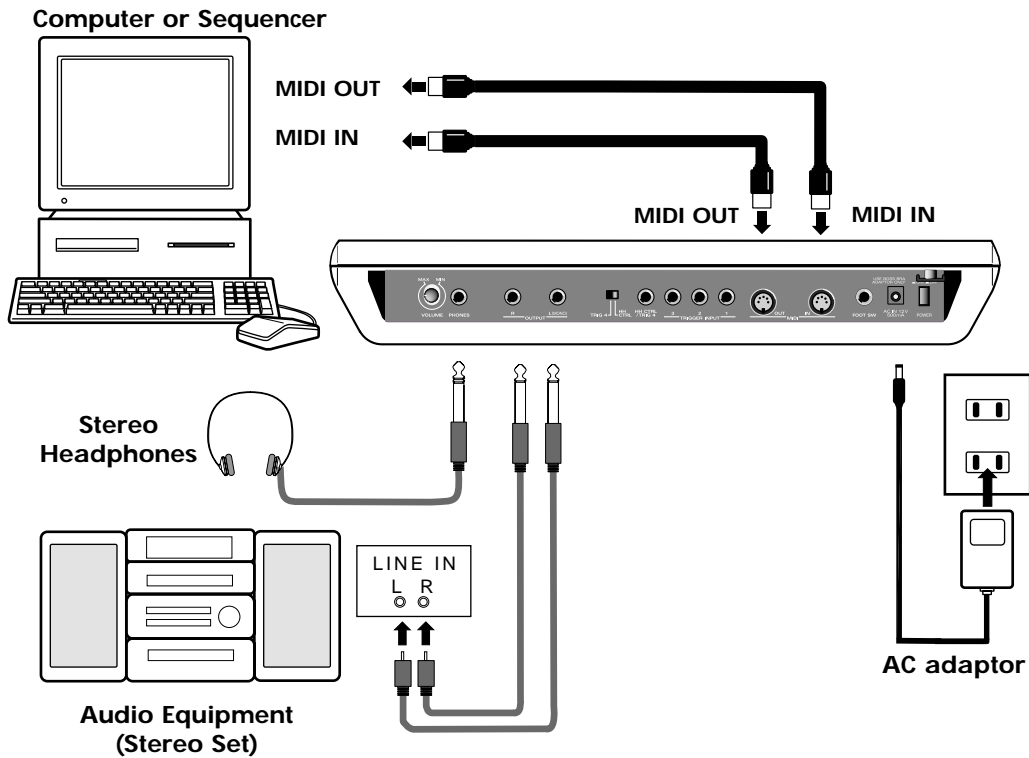

Breaking/Cutting the Connection Between the Sound Generator and the Pad Controller (Local Control)

The Local Control setting allows you to disconnect the pad section from the sound generating section. When you wish to record and playback your SPD-20 performances using a MIDI sequencer or computer, set Local Control to off (Local Control Off).

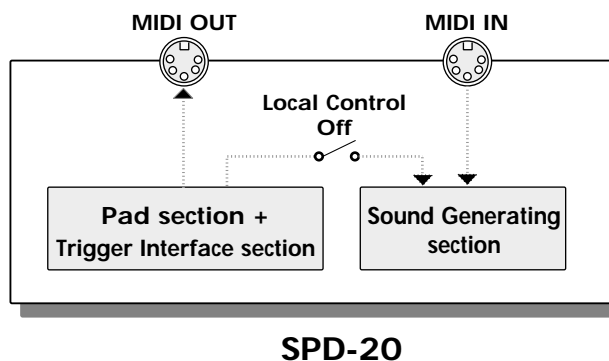

1 Turn off the power switch.

2 While pressing [PATCH CHAIN], turn the power switch back on.

The following message will scroll across the display, and Local Control will be turned off.

Local Control OFF

When Local Control is set to “Off,” the internal sound generator does not sound, even when the Pad is struck, and in PLAY mode, the MIDI Indicator lights.

NOTE Local Control Off is lifted and Local Control On restored the next time the power is turned on.

MEMO Regardless of the Local Control setting, messages received at MIDI IN will play the internal sound generator, and the pads and pedals will transmit messages from MIDI OUT.

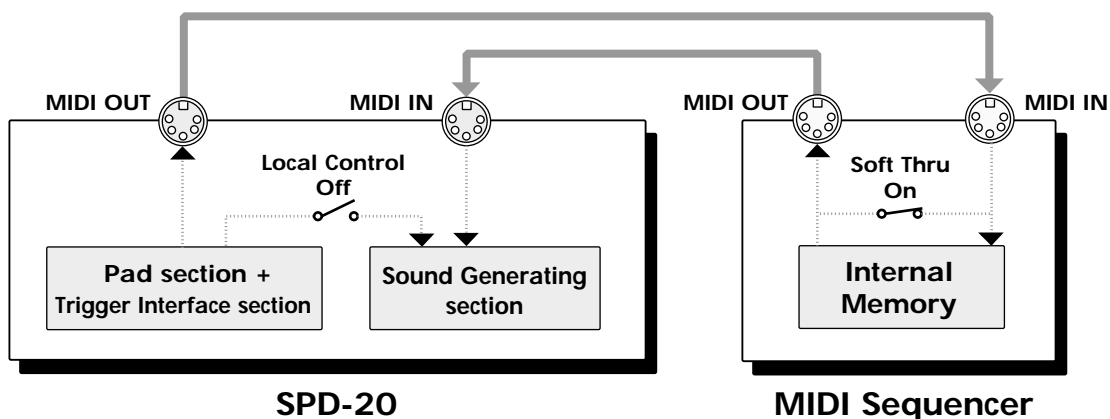

MEMO If you have connected the SPD-20 to a MIDI sequencer (or a personal computer running MIDI sequencing software) that has a “soft(ware) thru” function, set the SPD-20 to Local Off.

Soft Thru

“Soft thru” is a function (provided in most MIDI sequencers) by which the messages received at MIDI IN of the sequencer are re-transmitted from MIDI OUT. (For details, refer to the manual of your sequencer or sequencer software.)

When the sequencer’s soft thru is turned on, messages it receives at its MIDI IN will be re-transmitted from its MIDI OUT. If the connected SPD-20 is set to Local On, it would sound each note twice: once in response to the message from the pad section, and once again in response to the MIDI message sent via the software thru function of the sequencer.

MEMO It is also useful to set Local Off when using the SPD-20 as a pad controller to play only external sound modules.

How to Set Up the SPD-20 for Sequencing

If you wish to record and playback an SPD-20 performance on a MIDI sequencer or computer, make the following settings. (these are the factory settings.)

- For each pad you wish to use, set TX CH (p. 61) to the same channel as the Basic Channel.
- For each pad you wish to use, set Note # (p. 62) for the pads so that they don't overlap.
- For each pad you wish to use, set CURVE (p. 64) to "Lnr".
- For each pad you wish to use, set SENS (p. 64) to 8.

If you wish to record and playback Patch changes made during a performance, you will need to make the following settings as well.

- For only one pad, set a Program Number that matches the Patch number (p. 65).

If you wish to record and playback the pedal controller hi-hat sound (H01–H17) layered with another instrument, following setting will be necessary.

- Assign a hi-hat cymbal for pedal control instrument (H01–H17) to pad bank A.

If you assign these instruments to pad bank B, recording will be correct, but since the SPD-20 ignores incoming note messages for pad bank B, the Pedal hi-hat will not be heard during playback.

Storing the SPD-20's Data in External Devices (Bulk Dump)

The Patch data in the SPD-20 can be transmitted either singly or collectively to another SPD-20 (or to a sequencer). SPD-20 data is transmitted and received according to the Device ID number which has been set for each unit. (In the SPD-20, the Basic Channel number is also used as the Device ID number. p. 78) The operation of transmitting this data is called a "Bulk Dump"; receiving this data is called a "Bulk Load."

How to Transmit (Bulk Dump)

The SPD-20 transmits stored data.

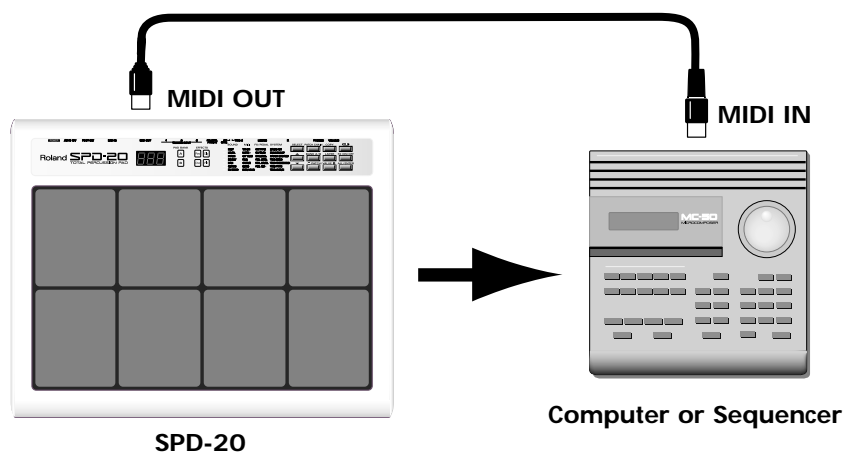

Connect the MIDI OUT of the SPD-20 to the MIDI IN of the sequencer.

- 1** Set the ID (the same as the Basic Channel's; p. 67) of the device transmitting the Exclusive Messages.
- 2** Press [EDIT] to enter the Edit mode.
- 3** Use [▲] or [▼] to select the BULK DUMP in the SYSTEM parameter group.
- 4** Use PATCH/VALUE [-] or [+] to select the Patch data you wish to transmit (ALL/1-99).

If ALL is selected, all Patch data, Patch Chain data, and system parameter data will be transmitted at once. If you wish to save an individual patch, select the patch number you wish to send with the value buttons.
- 5** Set the receiving MIDI device so that it will be able to receive Exclusive messages.
- 6** Press [ALL/ENTER] and data transmission will begin.



If you wish to stop the operation during transmission, press [EDIT].

6

If you wish to transmit other Patch data, repeat steps 3-5.

7

Press [EDIT] to return to the Play mode.

How to Receive (Bulk Load)

Here's how to receive Patch data that was stored in another SPD-20 (or in a sequencer).

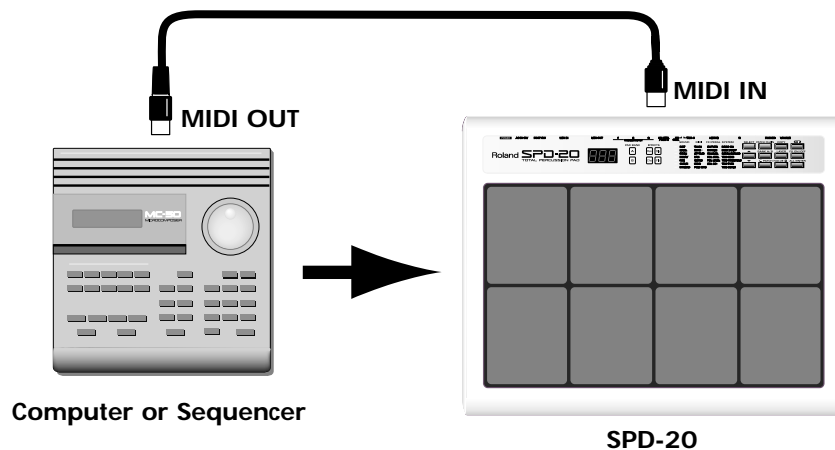

Connect the MIDI OUT of the transmitting device to the MIDI IN of the SPD-20.

NOTE

When data is received, the previously existing patch settings will be lost.

1

Make sure that the MIDI channel of the transmitting device matches the Basic Channel of the receiving SPD-20 (p. 67).

If you transfer Exclusive data from another SPD-20, set the basic channels on both units match. If you receive the Exclusive data that was stored in a sequencer, set the basic channel to match the same number which was set when you saved data in the sequencer.

2

Transmit the Exclusive data from the other MIDI device. When reception begins, "Lod" appears in the SPD-20's display.

You are returned to the previous display as soon as the Bulk Load has been completed.

MEMO

When Patch data is received, the bulk dumped Patch data is written to identical Patch numbers.

For example, if you save Patch Number 21 using bulk dump, then when the Patch data is bulk loaded, it is stored in Patch Number 21.

NOTE

Exclusive Messages cannot be received while Patch Copy and Patch Chain are being received.

Exclusive data transmission and reception requires a great deal of processing, so it is best to avoid playing or editing while transmission is going on. Also, Exclusive data transmission can require a significant amount of time, so allow a reasonable time for these operations. Data cannot be transmitted while incoming Bulk data is being processed, nor can data be received while Bulk data is being transmitted.

Reading SPD-11 Data with the SPD-20

You can use the SPD-20 to receive bulk data (bulk load) from the SPD-11. The SPD-20 has all of the Instruments from the SPD-11 built in, allowing you to play back Patches and other data created on the SPD-11.

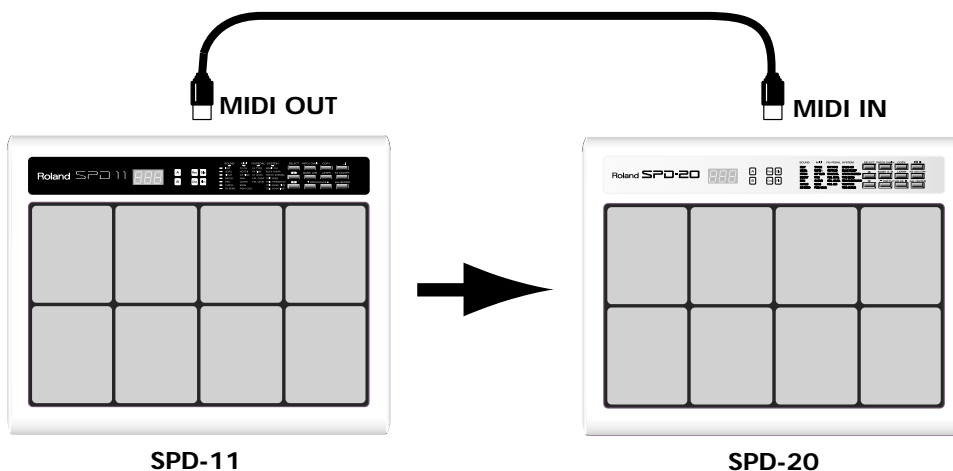

When SPD-11 data is sent to the SPD-20, Patches 1-64 from the SPD-11 are stored in Patches 1-64.

NOTE

When data is received by the SPD-11, the SPD-20's Patch data is overwritten.

You cannot transmit SPD-20 data to the SPD-11.

- 1** Using a MIDI cable, connect the MIDI OUT of the SPD-11 to the MIDI IN of the SPD-20.
- 2** Match the SPD-11's Basic Channel with the Basic Channel the SPD-20. (p. 67)
- 3** Put the SPD-11 in Edit mode and select the BULK DUMP SYSTEM parameter.
- 4** Select the SPD-11 Patches (ALL, 1-64) to be forwarded.

NOTE

When transmitting data, the SPD-11's Patch Number is written as is to the same Patch Number on the SPD-20. When ALL is selected, then Patches 1-64 from the SPD-11 are written to Patches 1-64 on the SPD-20.

- 5** When you press [ALL/ENTER] on the SPD-11, the data is forwarded from the SPD-11 to the SPD-20.
- 6** When reception begins, "Lod" appears in the SPD-20's display.
Bulk Load is then completed.

MEMO

When transferring Patches 1-64 used for Patch Expand on the SPD-11 (p. 70) to the SPD-20, you must then use Patch Copy to copy Patches 1-64 on the SPD-11, to Patches 96-99 on the SPD-20.

What is Device ID

According to the explanation on page 58 of this manual, Exclusive data is not differentiated by channel. However, this would mean that in a complex MIDI system that contained two or more SPD-20s, it would not be possible to transmit Exclusive data to only a specific SPD-20. To get around this problem, each SPD-20 has its own Device ID number (1–16) on which it transmits and receives Exclusive data. Exclusive data can be received only when the Device ID number of the receiving device matches the Device ID number of the transmitting device.

In the SPD-20, the Basic Channel number is also used as the Device ID number.

NOTE

In some devices, the MIDI channel number and the Device ID number can be set independently, and will not necessarily be the same. When transferring Bulk data to another device, refer to the operation manual for that device.

MEMO

If you are using a sequencer to control two or more SPD-20s, you can set each unit to a different Device ID so that select data can be sent to each unit. But remember that the Basic Channel numbers will also be different.

CHAPTER 5 Supplementary Materials

Here you will find materials that are useful in helping you get the most out of your SPD-20. Read the sections as needed.

Taking Advantage of the On-board Effects

Effect list

FX TYPE	Name	Explanation	The parameter affected by "Time"
1.	Room (Bright)	A bright-sounding room reverb	Reverb Time
2.	Room (Standard)	A standard room reverb	Reverb Time
3.	Room (Dark)	A dark-sounding room reverb	Reverb Time
4.	Hall (Bright)	A bright-sounding hall reverb	Reverb Time
5.	Hall (Standard)	A standard hall reverb	Reverb Time
6.	Hall (Dark)	A dark-sounding hall reverb	Reverb Time
7.	Plate (Bright)	A bright-sounding plate reverb	Reverb Time
8.	Standard Plate	A standard plate reverb	Reverb Time
9.	Chorus + Reverb	Chorus and reverb	Reverb Time
10.	Tremolo Reverb	Tremolo and reverb	Reverb Time
11.	Chorus	A standard chorus	Chorus Rate
12.	Chorus + Room	Chorus and room reverb	Reverb Time
13.	Chorus + Hall	Chorus and hall reverb	Reverb Time
14.	Chorus + Plate	Chorus and plate reverb	Reverb Time
15.	Flanger	A standard flanger	Flanger Rate
16.	Flanger + Reverb	Flanger and reverb	Reverb Time
17.	Flanger + Reverb	Flanger and reverb	Flanger Rate
18.	Pitched Delay + Reverb	Pitch-shifted delay and reverb	Delay Pitch
19.	Pitched Delay + Reverb	Pitch-shifted delay and reverb	Delay Rate
20.	Stereo Delay	Stereo delay (without feedback)	Delay Time
21.	Stereo Delay	Stereo delay (with feedback)	Delay Time
22.	Panning Delay	Panned delay (without feedback)	Delay Time
23.	Panning Delay	Panned delay (with feedback)	Delay Time
24.	Chorus + Delay	Chorus + stereo delay (without feedback)	Delay Time
25.	Chorus + Delay	Chorus + stereo delay (with feedback)	Delay Time

Explanation of Terms

Room Reverb	A simulation of the reverberation in a small room.
Hall Reverb	A simulation of the reverberation in a room with a high ceiling.
Plate Reverb	A simulation of a plate reverb (a reverb device which uses a metal plate), producing bright reverberation.
Chorus	An effect of enhanced spaciousness.
Flanger	An effect blending sounds reminiscent of a jet ascending and descending.
Pitched Delay	An effect in which the delayed sound is pitch-shifted.
Delay Feedback	This term refers to when the delayed signal is returned to the input of the circuit. Delay effects marked “with feedback” will have more repetitions of the delayed sound.
Panning Delay	The delayed sound will be panned back and forth between the left and right speakers (if you are listening in stereo). Even if you select a Panning Delay marked “without feedback,” there will be one delay for each position of right, center, and left.
Reverb Time	This sets the length of the reverberation.
Chorus Rate	This sets the modulation speed of the chorus effect. Higher settings result in faster chorusing.
Flanger Rate	This sets the modulation speed of the flanger effect. Higher settings result in faster flanging.
Pitched Delay Pitch	This sets the amount of pitch change applied to the delayed sound. Higher settings result in greater pitch change.
Pitched Delay Rate	This sets the modulation speed of the delayed sound. Higher settings result in faster modulation.
Delay Time	This sets the Delay time. Higher settings result in a longer delay. For the exact Delay times, refer to the table below.

Delay Time: 0–450 (msec)

The following chart shows the correspondence between Effect Time values and actual time (msec) when Delay is the Effect Type.

FX TIME	1	2	3	4	5	6	7	8	9	10	11	12	13	14	15	16
TIME [msec]	5	10	20	30	45	60	75	90	105	120	135	150	165	180	195	210
FX TIME	17	18	19	20	21	22	23	24	25	26	27	28	29	30	31	32
TIME [msec]	225	240	255	270	285	300	315	330	345	360	375	390	405	420	435	450

Hints on Using Reverb

Reverb gives presence and spaciousness to any sound, whether solo or background. However, excessively high effects levels and long effects times may make the performance difficult to follow (because sounds are blurred), or make the rhythm less precise. There is a definite relationship between effect time and effect level. Here are two hints on using Reverb, based on that relationship.

- **If you want to use a long effect time, decrease the effect level to reduce muddiness.**
- **If you want to use a high effect level, shorten the effect time to reduce muddiness.**

Hints on Using Delay

While Reverb creates a lingering resonance, Delay creates quite a different effect. For Delay effects, the effect time setting can create significant differences in the resulting sound. For example, when playing a melodic solo using a mallet-type Instrument, an extremely short Delay time can be used to thicken the sound. On the other hand, a longer repeating Delay can be set to a Delay time of a half-note or quarter-note that matches the tempo of the song.

If you are listening to the SPD-20 in stereo, it can also be interesting to select effect type 22 or 23 (Panned Delay) and select a Pan setting of “random.”

Hints on Using Chorus/Flanger

For Chorus/Flanger effects, the Time parameter determines the rate (the speed of modulation).

For Chorus, lower settings of the time parameter will result in a more spacious sound, and higher settings will result in a more tremolo-like effect. Flanging is often used on metallic sounds such as cymbals or Hi-Hats to produce a frequently-heard effect.

Hints on Making Parameter Settings

Effects provide many possibilities, but if you always use the same heavily-applied Reverb or Chorus, all the Patches will sound the same. It is important to choose effect settings that are appropriate for the song or suited to the role of the Instrument (solo, backing, special effects, etc.).

The FX SEND in the SOUND parameter group allows you to set the effect depth independently for the Instrument assigned to each pad, so it is possible, for instance, to apply flanging only to the cymbals. In the case of Reverb, higher settings of FX SEND will create the impression of the Instrument being played further away, so you might set the FX SEND parameter to a different value for each Instrument to create spatial contrast. By utilizing the Pan setting (the stereo position) and the Chorus effect, you can control a vast performance space.

Hints on Not Using Effects

Speaking of contrast, it can also be very “effective” to not use effects. Some possibilities are as follows.

- **To apply effects to certain Instruments and not to others.**
- **To switch to a non-effect Patch at a strategic moment.**

As an example of the first possibility, you might try using an ethnic percussion Instrument—such as a surdo—without any effects for a feeling of authenticity. As an example of the second possibility, you could switch from a Patch with deep Reverb to a Patch with no effects (or vice versa) to reinforce musical movement or development within a song.

Troubleshooting

When playing the internal sound generator

- **No sound**

Is the volume set to 0?

→ Check the SPD-20 volume, and the volume of the amp system and mixer.

Can you here sound through the headphones?

→ If there is sound through the headphones, the problem may be that a connecting cable is damaged, or there is a problem with the amp or mixer. Check the amplification system and the audio connections.

Is Layer Off selected?

→ When Layer Off is selected, the sound from only one side is played.

Could LEVEL in the SOUND parameter group be set to 0?

→ Set the levels to an appropriate value (p. 23).

Is INST (Instrument Assign) in the SOUND parameter group set to “oFF”?

→ A pad will not sound if its Instrument Assign parameter is set to “oFF” (p. 22).

Is Local Control turned off?

→ If Local Control is turned off, the pad section is disconnected from the sound generator, so playing the Pads will not produce sound (p. 72).

Is CURVE (Velocity Curve) in the SOUND parameter group inappropriate?

→ Make appropriate settings for the Velocity Curve parameter (p. 24).

- **No power/Power on, but unit does not operate**

Are you using the supplied AC adaptor?

→ Other AC adaptors may not work properly. If the SPD-20 does not operate even with the correct AC adaptor, check whether the correct AC line voltage is being supplied.

NOTE

It is best to avoid connecting many devices of high power consumption to the same AC outlet, or using an excessive number of AC outlet expansion plugs.

- **The volume is too low**

Is the volume turned down?

→ Check the SPD-20 volume, and the volume of the amp system and/or mixer.

Are LEVEL in the SOUND parameter group set too low?

→ Set the LEVEL to appropriate levels (p. 23).

Is CURVE (Velocity Curve) in the SOUND parameter group inappropriate?

→ Make appropriate settings for the Velocity Curve parameter (p. 24).

Is SENS (Velocity Sens) in the MIDI parameter group set too low?

→ Make appropriate settings for the Velocity Sensitivity parameter.

- **The sound is wrong**

Are the SOUND parameters set correctly?

→ Modify the SOUND parameters (p. 22).

- **You hear sounds that you did not select**

Is the layer function on?

→ Set Layer to Off (p. 15).

Is an external MIDI sound module being played from that pad?

→ If you do not wish to trigger an external MIDI sound module, set the Transmit Channel in the MIDI parameter to “oFF” (p. 61).

- **Soft strikes does not produce sound**

Is the TRIG THRESHOLD setting too high?

→ Set TRIG THRESHOLD to an appropriate value (p. 44).

Is CURVE (Velocity Curve) in the SOUND parameter group inappropriate?

→ Make appropriate settings for the Velocity Curve parameter (p. 24).

- **When two pads are struck simultaneously, only one of the sounds is played**

Are you striking the center of the pad?

→ When striking two pads simultaneously, you should hit them both in the center. Furthermore, you can be more sure of sounding both pads if you strike them with the timing slightly off.



With the SPD-20, the prevention of crosstalk (incorrect actions caused by the vibration from another pad) is processed internally. Thus, if when two pads are struck at the same time the signal output by one of the pads is extremely weak, then that sound is prevented from sounding. Being sure to strike both pads in their centers, with the same force/strength makes it difficult for the sound difficult to be omitted.

When external pads are connected



When using external pads, set the TRIG TYPE (p. 45).

The volume can't be controlled by adjusting the striking strength

→ Make the TRIG TYPE match (p. 45).

→ Make the TRIG SENS and TRIG CURVE match (p. 43, p. 47).

When striking repeatedly, some sounds are lost

→ Make the TRIG TYPE match (p. 45).



In some cases, when using pads or acoustic drum triggers from other manufacturers, you should make your settings in Advanced Trigger Parameters (p. 48).

There is no sound when rim shots are played

→ Play the rim shot correctly (p. 39).

Are stereo cables used to connect the pads?

→ Connect using stereo cables.

→ On the PD-120, rim shots can be played when you use Trigger Inputs 1 and 2.

When playing external MIDI sound modules

- **No sound**

Are MIDI connections correct?

- Check that the SPD-20 MIDI OUT is connected to the MIDI IN of the external sound module, and that the MIDI cable is not damaged.

Is the volume of the MIDI sound module turned down?

- Raise the volume.

Is TX CH (Transmit Channel) in the MIDI parameter group set correctly?

- Make sure that the Transmit Channel is not set to "OFF" and that the MIDI channel of the pad and the sound module match (p. 61). Additionally, if the Transmit Channel is set to P1-P16, S-S, C-S, or toP, Note Messages are not transmitted.

Is NOTE # (Note Number) in the MIDI parameter group set correctly?

- Check the note numbers of the MIDI sound module (p. 62).

Is CURVE (Velocity Curve) in the SOUND parameter group inappropriate?

- Make appropriate settings for the Velocity Curve parameter (p. 64).

- **The sound is too soft**

Is GT TIME (Gate Time) set too low?

- If you are playing a sound with a soft attack, set a longer Gate Time (p. 63).

Is CURVE in the MIDI parameter group set to an inappropriate value?

- Set Velocity Curve to an appropriate value (p. 64).

Is SENS in the MIDI parameter group too low?

- Set Velocity Sensitivity to an appropriate value (p. 64).

- **The volume does not change in response to playing dynamics**

Is CURVE in the MIDI parameter group set to "CSt"?

- Set Velocity Curve to an appropriate value (p. 64).

- **The note duration of the MIDI sound module does not change even though you adjusted GT TIME**

Does the MIDI sound module recognize Note Off messages? Or has it been set to a mode in which it does not recognize Note Off messages?

- Refer to the operation manual of the MIDI sound module.

- **When you select a Patch, the sound of the MIDI sound module also changes**

Has PGM CHG (Program Change) in the MIDI parameter group been set for a pad?

- Set Program Change to "OFF" (p. 65).

- **The MIDI sound module does not change sounds in response to Program Change messages**

Is PGM CHG in the MIDI parameter group set to "OFF"?

- Make Program Change settings (p. 65).

Are the Transmit Channel of the pad and the MIDI channel of the MIDI sound module set appropriately?

- Check the Transmit Channel of the pad and the MIDI channel of the MIDI sound module (p. 61).

Is the MIDI sound module able to respond to Program Change messages? Or is it set to a mode in which it does not recognize Program Change messages?

- Refer to the operation manual of the MIDI sound module.

- **Two sounds are played**

Is the Layer function set to On?

→ Turn the Layer function off (p. 15).

- **When the pad is struck, the sound is intermittent**

Is the Gate Time set to ALt?

→ Set the Gate Time to something other than ALt (p. 63).

When playing the internal sound generator of the SPD-20

- **No sound**

Does the Basic Channel of the SPD-20 match the Transmit Channel of the external MIDI device?

→ Set both devices to the same channel (p. 67).



Set the Basic Channel (BASIC CH; p. 67) as the SPD-20's Receive Channel.

Is the layer function on?

→ When the layer function is on, note messages assigned to pad bank B will be ignored. Turn the layer function off.

Is the Instrument you wish to play assigned to a pad?

→ Assign the Instrument to a pad (p. 22).

Is the Note Number set correctly?

→ The SPD-20 will not produce sound if it receives a Note Number which has not been assigned to a pad. Modify the Note Number, or select a Patch which has different note numbers assigned to it (p. 62).

Have you assigned the same Note Number to more than one pad?

→ Even if you assign the same Note Number to more than one pad, only one Instrument will sound. Set different note numbers for each pad (p. 62).

- **Note Numbers not set to a Patch are played**

Is Patch Expand on?

→ Set Patch Expand to Off (p. 69).

When a footswitch is connected

- **The footswitch does not work**

Is the footswitch connected correctly?

→ Connect the footswitch properly (p. 15).

- **The MIDI sound module does not sustain notes when you press the Footswitch**

Is the Hold Pedal function set?

→ Turn on the Hold Pedal function (p. 41).

Is the MIDI sound module able to respond to Hold messages?

→ Refer to the operation manual of the MIDI sound module.

- **The internal sound generator does not hold notes when pressed**

Have you chosen an instrument that can hold tones?

→ Holding with the internal sound generator is limited to certain specific Instruments (p . 88).

Others

- **The Patch you set in a Patch Chain is not selected**

Is the Patch Chain set correctly?

→ Check whether the Patch Chain is set correctly (p. 33).

NOTE

If you do not press [ENTER] after entering all of the Patch Numbers, the Patch Chain setting will not be completed.

Is the SPD-20 in the Play mode?

→ The Patch Chain function works only in the Play mode.

Is the SPD-20 in the Patch Chain Play mode?

→ While in Patch Chain Play mode, letters of the alphabet (A, b, C, d, e, F, G, H) appear to the left of the Patch Numbers.

- **Exclusive messages are not received**

Does the Device ID number of the transmitting MIDI device match the Basic Channel (Device ID number) of the SPD-20?

→ Set the basic channel (p. 67).

MEMO

Set the SPD-20's Device ID to the Basic Channel.

- **The effect does not work**

Is [FX ON/OFF] turned off?

→ Press [FX ON/OFF] to on (p. 9).

Is the FX LEVEL at 0?

→ Set the FX LEVEL to an appropriate level (p. 28).

Is the FX SEND at 0?

→ Set the FX SEND LEVEL to an appropriate level (p. 25).

- **The display flashes rapidly during setting of the Note Numbers**

→ This indicates that during setting of Note Numbers the same Patch is being set to different pads (including pad bank A/B). If you set the same Note Numbers to different pads, the Note Number of the pad determined to have higher priority (p. 67) will take precedence.

MEMO

When Patch Expand is in effect, check to see if the same Note Number is used in any more than one of the five patches.

- **The sound recorded to a sequencer is not the same as that played back**

Are the pad's Note Numbers overlapping with those of another pad?

→ Make all Note Numbers on the pads you are using different. The Note Number flashes rapidly when Note Numbers from different pads overlap (p. 62).

Error Messages

If a problem occurs during operation, an error message will be displayed. Take the appropriate action as described in this section.

Act SENS Err

A MIDI cable is not connected properly or may be damaged.

- Check the MIDI cable(s) and the connections with the other device(s).

Load Err

Data loading was not successful.

- Try loading once again. Pressing any button will return to the previous display.

SERIAL Err

MIDI data was received incorrectly.

Press any button on the front panel and the previous display will appear.

- If this message appears repeatedly, consult your dealer or the nearest Roland Service Center.

BUFFER FULL

Too much MIDI data was received from another MIDI device.

- Reduce the amount of MIDI data transmitted by the other device. Or, re-transmit the data after a pause to reduce the amount of MIDI data transmitted all at once. Pressing any button will return you to the previous display.

RAM TEST Err

The internal memory data has been lost.

- Press any button on the front panel. All data will be initialized, and the previous display will reappear.

NOTE

If this happens, all the data in the SPD-20 will be reset to the factory presets.

ANALOG TEST

This message indicates that there is an irregularity in the voltage of the pad detection circuit. Press any button on the front panel and the previous display will reappear.

- If the previous display does not reappear, no matter which button you press, contact the nearest Roland Service Center. Sometimes this error message will appear if you strike a pad while turning on the power. In this event, turn the power off and then on again.

BATTERY Lo

The memory-backup battery is exhausted.

- If the backup battery runs down completely, the data in internal memory will be lost. Contact your dealer or the nearest Roland Service Center as soon as possible to have the battery replaced.

Press any button on the panel to return to the previous display.

Instrument List

Loop: After Phrase Loop plays for several measures, the volume then decreases (p. 22).

Exc No.: You cannot sound the instrument that has the same number (#).

Hold: You can use the foot switch to hold notes (p. 41).

SPD-11: Indicates one of the SPD-11's internal instruments.

DRUMS

Bass Drum (Kick)

No.	Instrument	Loop	Exc No.	Hold	SPD-11
b01	Dry Kick				✓
b02	Dry Medium Kick				
b03	Dry Hard Kick				
b04	Meat Kick				
b05	Pillow Kick				✓
b06	Jazz Kick 1				
b07	Jazz Kick 2				
b08	Maple Kick				
b09	Real Kick				✓
b10	Vintage Kick 1				
b11	Vintage Kick 2				
b12	26" Deep Kick				
b13	Medium Kick				
b14	Oyster Kick				
b15	Open Kick				
b16	Big Low Kick				
b17	Wood Beater Kick				
b18	Deep Kick				✓
b19	Room Kick 1				✓
b20	Room Kick 2				✓
b21	Reverb Kick				✓
b22	Deep Reverb Kick				✓
b23	Mondo Kick				✓
b24	Mondo Deep Kick				✓
b25	Mondo Reverb Kick				✓
b26	Solid Kick				✓
b27	Reverb Solid Kick				✓
b28	House Kick				✓
b29	Dance Kick				✓
b30	Deep Dance Kick				✓
b31	Rap Kick 1				✓
b32	Rap Kick 2				
b33	Plastic Kick 1				
b34	Plastic Kick 2				
b35	Gabba Kick				
b36	Jungle Kick				
b37	Electronic Kick 1				
b38	Electronic Kick 2				✓
b39	TR-808 Kick 1				✓
b40	TR-808 Kick 2				
b41	TR-808 Kick 3				
b42	808 Electronic Kick				✓
b43	808 Boom Kick 1				
b44	808 Boom Kick 2				
b45	TR-909 Kick 1				✓
b46	TR-909 Kick 2				
b47	TR-909 Kick 3				
b48	909 Hard Kick				✓
b49	TR-606 Distortion Kick				
b50	CR-78 Kick				

Snare Drum

No.	Instrument	Loop	Exc No.	Hold	SPD-11
S01	Piccolo Snare Soft				
S02	Piccolo Snare Hard				
S03	Piccolo Snare Rim Shot				
S04	Beech Snare Soft				
S05	Beech Snare Hard				
S06	Beech Snare Rim Shot				
S07	Acoustic Snare Soft				
S08	Acoustic Snare Hard				
S09	Acoustic Snare Rim Shot				
S10	Steel Snare Soft				
S11	Steel Snare Hard				
S12	Steel Snare Rim Shot				

No.	Instrument	Loop	Exc No.	Hold	SPD-11
S13	Loose Snare Soft				
S14	Loose Snare Hard				✓
S15	Loose Snare Rim Shot				
S16	Medium Snare 1 Soft				
S17	Medium Snare 1 Hard				
S18	Medium Snare 1 Rim Shot				
S19	Medium Snare 2 Soft				
S20	Medium Snare 2 Hard				
S21	Medium Snare 2 Rim Shot				
S22	Concert Snare Soft		Exc 1		
S23	Concert Snare Hard		Exc 1		
S24	Concert Snare Rim Shot		Exc 1		
S25	Concert Snare Roll		Exc 1		
S26	Concert Snare Buzz		Exc 1		
S27	Roll Snare				✓
S28	Brass Snare Soft				
S29	Brass Snare Hard				
S30	Ring Snare Soft				
S31	Ring Snare Hard				✓
S32	High Piccolo Snare				
S33	Medium Fat Snare				
S34	TD-7 Acoustic Snare				✓
S35	Real Snare				✓
S36	L.A. Snare				✓
S37	L.A. Fat Snare				✓
S38	Fat Snare				✓
S39	Brush Roll Snare 1		Exc 2		✓
S40	Brush Roll Snare 2		Exc 2		✓
S41	Brush Swish Snare		Exc 2		✓
S42	Brush Slap Snare 1				✓
S43	Brush Slap Snare 2				✓
S44	Brush Slap Snare 3				✓
S45	Brush Slap Snare 4				✓
S46	Rock Snare				✓
S47	Rocker Snare				✓
S48	Rockin' Snare				✓
S49	Rock Light Snare				✓
S50	Rock Rim Shot Snare				✓
S51	Rock Splatter Snare				✓
S52	Light Snare				✓
S53	Big Shot Snare				✓
S54	Hyper Snare				✓
S55	Splatter Snare				✓
S56	Super Light Snare				✓
S57	Super Whack Snare				✓
S58	Cracker Snare				✓
S59	Cruddy Snare				✓
S60	Dopin' Snare				✓
S61	House Snare				✓
S62	House Dopin' Snare				✓
S63	Reggae Snare 1				✓
S64	Reggae Snare 2				✓
S65	Swing Snare				✓
S66	90's Snare				✓
S67	Digital Snare				✓
S68	FX Snare				✓
S69	Rage Snare				
S70	Jungle Tiny Snare				
S71	Jungle Rim Snare				
S72	Electronic Snare 1				
S73	Electronic Snare 2				✓
S74	TR-808 Snare 1				✓
S75	TR-808 Snare 2				
S76	TR-909 Snare				✓
S77	TR-707 Snare				
S78	TR-606 Snare				
S79	CR-78 Snare				
S80	Ambient Cross Stick				✓
S81	Hall Cross Stick				✓
S82	Analog Cross Stick				
S83	Ragga Cross Stick				
S84	TR-808 Cross Stick				✓
S85	TR-909 Cross Stick				
S86	CR-78 Cross Stick				

Tom-Tom

No.	Instrument	Loop	Exc No.	Hold	SPD-11
t01	Big Tom 1 Soft				
t02	Big Tom 1 Hard				
t03	Big Tom 2 Soft				
t04	Big Tom 2 Hard				
t05	Studio Tom 1 Soft				
t06	Studio Tom 1 Hard				
t07	Studio Tom 2 Soft				
t08	Studio Tom 2 Hard				
t09	Jazz Tom 1 Soft				
t10	Jazz Tom 1 Hard				
t11	Jazz Tom 2 Soft				
t12	Jazz Tom 2 Hard				
t13	Vintage Tom 1 Soft				
t14	Vintage Tom 1 Hard				
t15	Vintage Tom 2 Soft				
t16	Vintage Tom 2 Hard				
t17	Double Head Tom 1				✓
t18	Double Head Tom 2				✓
t19	Fusion Tom 1				
t20	Fusion Tom 2				
t21	Real Tom 1				✓
t22	Real Tom 2				✓
t23	Birch Tom 1				
t24	Birch Tom 2				
t25	Bowl Tom 1				
t26	Bowl Tom 2				
t27	Room Tom 1				
t28	Room Tom 2				
t29	Acoustic Tom 1				✓
t30	Acoustic Tom 2				✓
t31	Rock Tom 1				✓
t32	Rock Tom 2				✓
t33	Brush Slap Tom 1				✓
t34	Brush Slap Tom 2				✓
t35	Electronic Tom				
t36	2-Tone Electronic Tom				
t37	Bright Electronic Tom				
t38	TR-808 Tom				✓
t39	TR-909 Tom				
t40	909 Whack Tom				

Hi-Hat Cymbal

No.	Instrument	Loop	Exc No.	Hold	SPD-11
h01	Pop Closed Hi-Hat Inner		Exc 31		✓
h02	Pop Closed Hi-Hat Outer		Exc 31		✓
h03	Pop Open Hi-Hat Inner		Exc 31		✓
h04	Pop Open Hi-Hat Outer		Exc 31		✓
h05	Pop Pedal Hi-Hat		Exc 31		✓
h06	Real Closed Hi-Hat Inner		Exc 31		✓
h07	Real Closed Hi-Hat Outer		Exc 31		✓
h08	Real Open Hi-Hat Inner		Exc 31		✓
h09	Real Open Hi-Hat Outer		Exc 31		✓
h10	Real Pedal Hi-Hat		Exc 31		✓
h11	Brush Closed Hi-Hat		Exc 31		✓
h12	Brush Open Hi-Hat		Exc 31		✓
h13	Pure Closed Hi-Hat Inner		Exc 31		
h14	Pure Closed Hi-Hat Outer		Exc 31		
h15	Pure Half Open Hi-Hat		Exc 31		
h16	Pure Open Hi-Hat		Exc 31		
h17	Heavy Closed Hi-Hat		Exc 31		
h18	Heavy Open Hi-Hat		Exc 31		
h19	Medium Closed Hi-Hat		Exc 31		
h20	Medium Open Hi-Hat		Exc 31		
h21	Tambourine Closed Hi-Hat		Exc 31		
h22	Tambourine Open Hi-Hat		Exc 31		
h23	Wheel Closed Hi-Hat		Exc 31		
h24	Wheel Open Hi-Hat		Exc 31		
h25	Wheel Pedal Hi-Hat		Exc 31		
h26	TR-808 Closed Hi-Hat Inner		Exc 31		✓
h27	TR-808 Closed Hi-Hat Outer		Exc 31		✓
h28	TR-808 Open Hi-Hat Inner		Exc 31		✓
h29	TR-808 Open Hi-Hat Outer		Exc 31		✓
h30	TR-909 Closed Hi-Hat		Exc 31		
h31	TR-909 Open Hi-Hat		Exc 31		
h32	CR-78 Closed Hi-Hat		Exc 31		✓
h33	CR-78 Open Hi-Hat		Exc 31		✓

Hi-Hat Cymbal for pedal control

No.	Instrument	Loop	Exc No.	Hold	SPD-11
H01	Pop Hi-Hat Inner		Exc 31		✓
H02	Pop Hi-Hat Outer		Exc 31		✓
H03	Real Hi-Hat Inner		Exc 31		✓
H04	Real Hi-Hat Outer		Exc 31		✓
H05	Brush Hi-Hat		Exc 31		✓
H06	Pure Hi-Hat Inner		Exc 31		
H07	Pure Hi-Hat Outer		Exc 31		
H08	Heavy Hi-Hat		Exc 31		
H09	Medium Hi-Hat		Exc 31		
H10	Wheel Hi-Hat		Exc 31		
H11	TR-808 Hi-Hat Inner		Exc 31		✓
H12	TR-808 Hi-Hat Outer		Exc 31		✓
H13	TR-909 Hi-Hat		Exc 31		
H14	CR-78 Hi-Hat		Exc 31		✓
H15	Chenchen Hi-Hat		Exc 31		
H16	Shekere Hi-Hat		Exc 31		
H17	Hand Cymbal Hi-Hat		Exc 31		

Crash/Ride Cymbal

No.	Instrument	Loop	Exc No.	Hold	SPD-11
C01	Crash Cymbal 1				✓
C02	Crash Cymbal 2				✓
C03	Quick Crash Cymbal				
C04	Crash Cymbal Soft				
C05	Chinese Cymbal 1				
C06	Chinese Cymbal 2				✓
C07	Chinese Cymbal 3				✓
C08	Sizzle Chinese Cymbal				
C09	Splash Cymbal 1				
C10	Splash Cymbal 2				
C11	Pgy Crash Cymbal 1				
C12	Pgy Crash Cymbal 2				
C13	Pgy Chinese Cymbal				
C14	Pgy Splash Cymbal				
C15	Ride Cymbal 1				✓
C16	Ride Bell Cymbal 1				✓
C17	Ride Cymbal 2				
C18	Ride Bell Cymbal 2				
C19	Ride Cymbal 3				
C20	Ride Bell Cymbal 3				
C21	Sizzle Ride Cymbal 1				
C22	Sizzle Ride Bell Cymbal 1				
C23	Sizzle Ride Cymbal 2				
C24	Sizzle Ride Bell Cymbal 2				
C25	Sizzle Ride Cymbal 3				
C26	Sizzle Ride Bell Cymbal 3				
C27	Pgy Ride Cymbal 1				
C28	Pgy Ride Cymbal 2				
C29	Brush Crash Cymbal				
C30	Brush Sizzle Crash Cymbal				
C31	Brush Ride Cymbal				✓
C32	Brush Sizzle Ride Cymbal				
C33	Hand Cymbals				✓
C34	Mallet Cymbal				
C35	TR-808 Cymbal				✓
C36	TR-606 Cymbal				

PERCUSSION

Latin Percussion (Cuban, Brazilian)

No.	Instrument	Loop	Exc No.	Hold	SPD-11
L01	R-8 Bongo High				
L02	R-8 Bongo Low				
L03	Bongo High				✓
L04	Bongo Low 1				✓
L05	Bongo Low 2				✓
L06	R-8 Conga High Mute				
L07	R-8 Conga High Open				
L08	R-8 Conga Low Open				
L09	Conga High Mute				✓
L10	Conga High Slap				✓
L11	Conga High Open				✓
L12	Conga Low Open 1				✓
L13	Conga Low Open 2				✓
L14	Cowbell 1				✓
L15	Cowbell 2				✓
L16	Cowbell 3				
L17	Cowbell 4				
L18	Cowbell 5				

No.	Instrument	Loop	Exc No.	Hold	SPD-11
L19	Claves 1				✓
L20	Claves 2				✓
L21	Guiro Short		Exc 3		✓
L22	Guiro Long		Exc 3		✓
L23	Maracas				✓
L24	Shaker 1				✓
L25	Shaker 2				
L26	Shaker 3				
L27	Tambourine 1				✓
L28	Tambourine 2				
L29	Timbale High				
L30	Timbale High Rim Shot				✓
L31	Timbale Low				✓
L32	Timbale Paila				✓
L33	Vibra Slap				✓
L34	Agogo 1 High				
L35	Agogo 1 Low				
L36	Agogo 2 High				
L37	Agogo 2 Low				
L38	Agogo 3				✓
L39	Cabasa				✓
L40	TD-10 Cuica Mute 1		Exc 4		
L41	TD-10 Cuica Mute 2		Exc 4		
L42	TD-10 Cuica Open		Exc 4		
L43	Cuica Mute 1		Exc 5		✓
L44	Cuica Mute 2		Exc 5		✓
L45	Cuica Open		Exc 5		✓
L46	Pandeiro 1 Mute		Exc 6		
L47	Pandeiro 1 Slap		Exc 6		
L48	Pandeiro 1 Open		Exc 6		
L49	Pandeiro 2 Mute		Exc 7		✓
L50	Pandeiro 2 Slap		Exc 7		✓
L51	Pandeiro 2 Open		Exc 7		✓
L52	Pandeiro 3				✓
L53	R-8 Surdo Rim				✓
L54	R-8 Surdo Mute		Exc 8		✓
L55	R-8 Surdo Open		Exc 8		✓
L56	Surdo Mute		Exc 9		
L57	Surdo Open		Exc 9		
L58	Tamborim 1 Mute				
L59	Tamborim 1 Slap				
L60	Tamborim 1 Open				✓
L61	Tamborim 2 Open				✓
L62	TD-10 Samba Whistle Short		Exc 10		
L63	TD-10 Samba Whistle Long		Exc 10		
L64	Samba Whistle Short		Exc 11		✓
L65	Samba Whistle Long		Exc 11		✓
L66	Caxixi				
L67	Berimbau Mute		Exc 12		
L68	Berimbau Open		Exc 12		
L69	Berimbau Up		Exc 12		
L70	Berimbau Down		Exc 12		
L71	Caixa Mute				
L72	Caixa Open Soft				
L73	Caixa Open Hard				
L74	Caixa Roll				
L75	Rain Stick				
L76	Samba Bateria				
L77	Samba Loop	Loop	Exc 30		✓
L78	Shaker Loop	Loop	Exc 30		✓

Indian Percussion

No.	Instrument	Loop	Exc No.	Hold	SPD-11
i01	Sarna Bell				
i02	Baya 1 Slide		Exc 13		
i03	Baya 1 Gin		Exc 13		
i04	Baya 1 Ka		Exc 13		
i05	Baya 1 Ge		Exc 13		
i06	Baya 2 Ge		Exc 13		✓
i07	Tabla 1 Na		Exc 14		
i08	Tabla 1 Tin		Exc 14		
i09	Tabla 1 Tun		Exc 14		
i10	Tabla 1 Ti		Exc 14		
i11	Tabla 2 Te		Exc 14		✓
i12	Tabla 2 Na 1		Exc 14		✓
i13	Tabla 2 Na 2		Exc 14		✓
i14	Tabla 2 Tun		Exc 14		✓
i15	Pot Drum 1 Low		Exc 32		
i16	Pot Drum 1 High		Exc 32		
i17	Pot Drum 1 Accent				
i18	Pot Drum 2 Mute				
i19	Pot Drum 2 Long		Exc 33		

No.	Instrument	Loop	Exc No.	Hold	SPD-11
i20	Pot Drum 2 Short		Exc 33		
i21	Dholak Ga				
i22	Dholak Ta		Exc 34		
i23	Dholak Tun		Exc 34		
i24	Dholak Na		Exc 34		
i25	Madal Da				
i26	Madal Din		Exc 35		
i27	Madal Ta		Exc 35		
i28	Khole				
i29	Dhol 1		Exc 15		
i30	Dhol 2		Exc 15		
i31	Dhol 3		Exc 16		
i32	Dhol 4		Exc 16		
i33	Tabla Baya Loop	Loop	Exc 30		✓

African/Middle Eastern/Australian/Other Percussion

No.	Instrument	Loop	Exc No.	Hold	SPD-11
< Africa >					
F01	Shekere				✓
F02	Djembe 1 Center				
F03	Djembe 1 Rim				
F04	Djembe 2				✓
F05	Djembe 3				✓
F06	Djembe 4				✓
F07	Talking Drum 1 Down		Exc 17		
F08	Talking Drum 1 Up		Exc 17		
F09	Talking Drum 2				✓
F10	Afro Drum Open 1				
F11	Afro Drum Open 2				
F12	Afro Drum Flam				
F13	Afro Drum Rattle				
F14	Metal Castanets				
< Middle East >					
F15	Bell Tree				✓
F16	Sagat Closed		Exc 18		
F17	Sagat Open		Exc 18		
F18	Darbuka 1 Dom				
F19	Darbuka 1 Tak				
F20	Darbuka 2				✓
F21	Doira Dun				
F22	Doira Tik				
F23	Doholla Dom				
F24	Doholla Sak				
F25	Doholla Tak				
F26	Doholla Roll		Exc 19		
F27	Doholla Stop		Exc 19		
F28	Rek Dom				
F29	Rek Tek				
F30	Rek Open				
F31	Rek Trill				
F32	Bendir				
F33	Dawul				
< Australia >					
F34	Clapstick				
F35	Boomerang				
< Other >					
F36	Bloom Bell				
< Africa >					
F37	Afro Loop	Loop	Exc 30		✓

Japanese/Korean/Chinese/Southeast Asian Percussion

No.	Instrument	Loop	Exc No.	Hold	SPD-11
< Japan >					
J01	Biwa				
J02	Atarigane				
J03	Hyoshigi				
J04	Ohkawa				
J05	Tsuzumi 1 High				
J06	Tsuzumi 1 Low				
J07	Tsuzumi 2				✓
J08	Shime Taiko 1				
J09	Shime Taiko 2				
J10	Matsuri Taiko				
J11	Matsuri Taiko Rim				
J12	Taiko 1				✓
J13	Taiko 2				✓
J14	Taiko Rim				✓
J15	Matsuri				✓

No.	Instrument	Loop	Exc No.	Hold	SPD-11
J16	Yyoo Dude				
< Korea >					
J17	Buk				
J18	Buk Rim				
J19	Jang-Gu				
J20	Jing Mute		Exc 28		
J21	Jing Soft		Exc 28		
J22	Jing Hard		Exc 28		
J23	Gengari Mute		Exc 29		
J24	Gengari Soft		Exc 29		
J25	Gengari Hard		Exc 29		
< China >					
J26	Ban Gu 1				
J27	Ban Gu 2				
J28	Ban Gu 3				
J29	Gu Roll		Exc 20		
J30	Gu High		Exc 20		
J31	Tang Gu Mute		Exc 21		
J32	Tang Gu		Exc 21		
J33	Hu Yin Luo Mute		Exc 22		
J34	Hu Yin Luo		Exc 22		
J35	Nao Bo				
J36	Xiao Bo				
J37	Small Tam-Tam				
J38	Large Tam-Tam				
J39	Large Gong				✓
J40	Small Gong				✓
J41	Tiny Gong				
J42	Bend Gong				
< Southeast Asia >					
J43	Finger Cymbal				
J44	Rama Cymbal				
J45	Chenchen Closed		Exc 23		
J46	Chenchen Open		Exc 23		
J47	Bali Cymbal Closed		Exc 24		
J48	Bali Cymbal Open		Exc 24		
J49	Thai Gong				
J50	Jaws Harp Open		Exc 25		
J51	Jaws Harp Wow		Exc 25		

Orchestral Percussion

No.	Instrument	Loop	Exc No.	Hold	SPD-11
o01	Sleigh Bell				✓
o02	Tree Chimes				
o03	Triangle Mute		Exc 26		✓
o04	Triangle Open		Exc 26		✓
o05	Castanets				✓
o06	Castanets with Hall Ambience				✓
o07	Wood Block				✓
o08	Slapstick				
o09	Concert Bass Drum Mute		Exc 27		✓
o10	Concert Bass Drum Open		Exc 27		✓
o11	Timpani 1 Soft				
o12	Timpani 1 Hard				
o13	Timpani 2				✓
o14	Timpani Bend				✓
o15	Church Bell			✓	
o16	Percussion Hit 1				
o17	Percussion Hit 2				
o18	Percussion Hit 3				
o19	Orchestra Hit Major 1				
o20	Orchestra Hit Major 2				
o21	Orchestra Hit Diminish 1				
o22	Orchestra Hit Diminish 2				
o23	Orchestra Hit 1			✓	
o24	Orchestra Hit 2			✓	

Melodic Percussion/Melodic Instruments

No.	Instrument	Loop	Exc No.	Hold	SPD-11
M01	Glockenspiel				✓
M02	Vibraphone			✓	✓
M03	Xylophone				✓
M04	Marimba 1				✓
M05	Marimba 2				✓
M06	Bass Marimba				
M07	Celesta				
M08	Tubular Bells 1			✓	
M09	Tubular Bells 2			✓	

No.	Instrument	Loop	Exc No.	Hold	SPD-11
< Central America >					
M10	Steel Drum 1				✓
M11	Steel Drum 2				✓
< India >					
M12	Sitar				
M13	Sitar Gliss				
M14	Santoor Upper				
M15	Santoor Lower				
M16	Tambura				
M17	Tambura Drone				✓
< Middle East >					
M18	Hammer Dulcimer Upper				
M19	Hammer Dulcimer Lower				
< Africa >					
M20	Kalimba				✓
M21	Log Drum				✓
M22	Balaphone				
M23	Afro Zither				
< China >					
M24	Yang Qin				
< Southeast Asia >					
M25	Bonang				
M26	Gender				
M27	Saron				
M28	Angklung				
< Melodic Instruments >					
M29	Gamelan 1				✓
M30	Gamelan 2				✓
M31	Glass				✓
M32	Iron Hammer				✓
M33	Bamboo				✓
M34	Drip				✓
M35	Synth Strings 1				
M36	Synth Strings 2				✓
M37	Brass Hit 1 Short				✓
M38	Brass Hit 1 Long				
M39	Brass Hit 2 Short				
M40	Brass Hit 2 Long				
M41	Brass Hit 3 Short				
M42	Brass Hit 3 Long				✓
M43	Brass Fall				✓
M44	Choir Soprano				✓
M45	Choir Alto				✓
M46	Choir Bass				✓
M47	Choir Unison 1				✓
M48	Choir Unison 2				✓
M49	Choir 5th 1				✓
M50	Choir 5th 2				✓
M51	Choir 4th 1				✓
M52	Choir 4th 2				✓
M53	Acoustic Bass				
M54	Fingered Bass				
M55	Picked Bass				
M56	Slap Bass				
M57	Funky Bass				
M58	TB-303 Bass				
M59	SH-101 Bass				

Analog Percussion (CR-78, TR-808, etc.)

No.	Instrument	Loop	Exc No.	Hold	SPD-11
A01	DR-55 Claves				✓
A02	CR-78 Cowbell				✓
A03	CR-78 Metallic Beat				✓
A04	CR-78 Guiro				✓
A05	CR-78 Tambourine				✓
A06	CR-78 Maracas				✓
A07	CR-78 Bongo				
A08	CR-78 Claves				
A09	TR-707 Cowbell				
A10	TR-727 Agogo				
A11	TR-808 Conga				✓
A12	TR-808 Claves				✓
A13	TR-808 Maracas				✓
A14	TR-808 Cowbell				✓
A15	TR-808 Hand Clap				✓
A16	TR-909 Hand Clap				

SOUND EFFECTS

Dance Sounds

No.	Instrument	Loop	Exc No.	Hold	SPD-11
d01	Hand Clap 1				✓
d02	Hand Clap 2				✓
d03	Little Clap				
d04	Hip Clap				
d05	Afro Clap				
d06	Scratch Push				✓
d07	Scratch Pull				✓
d08	Scratch Stereo				✓
d09	DR-550 Scratch Push				
d10	DR-550 Scratch Pull				
d11	Scratch Bass Drum Push				
d12	Scratch Bass Drum Pull				
d13	Scratch Snare				
d14	Jungle Hat				
d15	Jungle Cymbal				
d16	Dance Shaker				
d17	Tape Rewind				
d18	Vinyl Stop				
d19	High-Q 1				✓
d20	High-Q 2				✓
d21	Beam High-Q				
d22	Air Blip				
d23	Techno Snap				
d24	Organ Chord				
d25	Distortion Guitar				
d26	Auh Voice				
d27	Techno Chord				
d28	Techno Scene				
d29	Synth Hit				
d30	Distortion Hit				
d31	Thin Beef				
d32	Techno Hit				
d33	Tao Hit				
d34	Philly Hit				
d35	Analog Bird				
d36	Retro UFO				
d37	Metal Sweep				
d38	Bounce				
d39	Distortion Swish				
d40	PCM Press				
d41	Jungle Roll Kick				
d42	Jungle Roll Snare				
d43	Techno Loop	Loop	Exc 30		✓

Artificial Sound Effects

No.	Instrument	Loop	Exc No.	Hold	SPD-11
E01	Burt				
E02	Boing 1				
E03	Boing 2				
E04	Onkey				
E05	Tom Noise				
E06	Lazer				
E07	Feedback Wave				
E08	Atmosphere				
E09	Bend Synth				
E10	Toy Gun				
E11	Eddy				
E12	R-8 Spark				
E13	Rattle				✓
E14	Anvil				✓
E15	Chop				✓
E16	Metal 1				✓
E17	Metal 2				✓
E18	Metal Cross Stick				✓
E19	Crash 1				✓
E20	Crash 2				✓
E21	Explosion				
E22	Shot 1				✓
E23	Shot 2				✓
E24	Shot 3				✓
E25	Shot 4				✓
E26	Stick Hit				✓
E27	Noise Accent 1				✓
E28	Noise Accent 2				✓
E29	Noise Accent 3				✓
E30	Noise Accent 4				✓
E31	Random Noise 1				✓
E32	Random Noise 2				✓

No.	Instrument	Loop	Exc No.	Hold	SPD-11
E33	Random Noise 3				✓
E34	Random Noise 4				✓
E35	Slide				
E36	Uut?				✓
E37	Drop				✓
E38	Emergency				✓
E39	Woody 1				✓
E40	Woody 2				✓
E41	Monster Drum				✓
E42	Can Drum				✓
E43	Wah Guitar Down 1				
E44	Wah Guitar Up 1				
E45	Wah Guitar Down 2				
E46	Wah Guitar Up 2				

Natural Sounds, Human Voice

No.	Instrument	Loop	Exc No.	Hold	SPD-11
n01	Telephone 1				
n02	Telephone 2				
n03	Doorbell				
n04	Dog Bark				
n05	Bird				
n06	Car Door				
n07	Car Stop				
n08	Horn				
n09	Punch				
n10	Glass Crash				
n11	Door Close				
n12	Metallic Lid				
n13	Machine Gun				
n14	Pistol				
n15	Siren				
n16	Drum Major Whistle				
n17	Afro Feet				
n18	Afro Stomp				
n19	Thunder				
n20	Stream				
n21	Snaps				✓
n22	Human Whistle				
n23	Oww!				
n24	Woa!				
n25	Ooh!				
n26	Chiki!				
n27	Hey!				
n28	Ou!				
n29	Ou! Up				
n30	Scream				
n31	Voice Loop	Loop	Exc 30		✓

Ambience, Reversed Sounds

No.	Instrument	Loop	Exc No.	Hold	SPD-11
r01	Kick Ambience				✓
r02	Snare Ambience				✓
r03	Tom Ambience				✓
r04	Concert Ambience				✓
r05	Reverse Bend Gong				
r06	Reverse Analog Bird				
r07	Reverse Laser				
r08	Reverse Boing				
r09	Reverse Bend Synth				
r10	Reverse High-Q				✓
r11	Reverse Beat				✓
r12	Reverse Sitar Gliss				
r13	Reverse Yyoo Dude				
r14	Reverse Ambience				✓
r15	Reverse Clap				✓
r16	Reverse Cymbal				✓
r17	Reverse Kick				✓
r18	Reverse Shot				✓
r19	Reverse Snare				✓
r20	Reverse Tom				✓

Forces Phrase Loop Instrument to stop (MUTE)

No.	Instrument	Loop	Exc No.	Hold	SPD-11
Mut	Phrase Loop Mute		Exc 30		

No sound

No.	Instrument	Loop	Exc No.	Hold	SPD-11
oFF	Off				

Patch List

No.	Patch Name	Description	No.	Patch Name	Description
1	Drums & Shaker *	Demo Kit	51	Yang Qin	Chinese Struck Stringed Instrument
2	Latin Set *	Demo Kit	52	Southeast Asian	Southeast Asian Percussion
3	Orchestral	Demo Kit	53	Gamelan	Southeast Asian Percussion
4	Groove *	Demo Kit	54	Timpani	Orchestral Percussion
5	Amazon *	Demo Kit	55	Chimes & Bells	Orchestral Percussion
6	Brushes *	Demo Kit	56	Orchestra Hits	Orchestral Percussion
7	Delay	Demo Kit	57	Marimba	Melodic Percussion
8	Dance Chord	Demo Kit	58	Bass Marimba	Melodic Percussion
9	Indian *	Demo Kit	59	Celesta	Melodic Percussion
10	Tex-Mex	Demo Kit	60	Vibraphone	Melodic Percussion
11	Standard 1	Acoustic Drum Kit	61	Xylophone	Melodic Percussion
12	Standard 2	Acoustic Drum Kit	62	Tubular Bells	Melodic Percussion
13	Big Rock	Acoustic Drum Kit	63	Steel Drum	Melodic Percussion
14	Jazz	Acoustic Drum Kit	64	Melodic Gong	Melodic Sound
15	Funk	Acoustic Drum Kit	65	Oriental	Melodic Sound
16	Power	Acoustic Drum Kit	66	Choir	Melodic Sound
17	Rock	Acoustic Drum Kit	67	Choir & Bass	Melodic Sound
18	Electronic	Electronic Drum Kit	68	Strings & Bass	Melodic Sound
19	Vintage Hex	Electronic Drum Kit	69	Brass	Melodic Sound
20	TR-909	Electronic Drum Kit	70	Melodic 1	Melodic Sound
21	TR-808	Electronic Drum Kit	71	Melodic 2	Melodic Sound
22	CR-78/TR-808	Electronic Drum Kit	72	Melodic 3	Melodic Sound
23	Dance Scratch	Electronic Drum Kit	73	Melodic 4	Melodic Sound
24	Dance Mix *	Electronic Drum Kit	74	Whole Tone	Melodic Sound
25	Techno	Electronic Drum Kit	75	One Shot Delay	Sound Effects
26	Techno Beat	Electronic Drum Kit	76	Chorus + Delay	Sound Effects
27	Techno Hit *	Electronic Drum Kit	77	Flanger + Reverb	Sound Effects
28	Hip Hop	Electronic Drum Kit	78	Metal Head	Sound Effects
29	Jungle *	Electronic Drum Kit	79	Chorus Chord	Sound Effects
30	Drums & Synth	Electronic Drum Kit	80	Wack-O	Sound Effects
31	Bongo & Conga	Cuban Percussion	81	Flying	Sound Effects
32	Timbales *	Cuban Percussion	82	Crime Scene	Sound Effects
33	Cabasa & Cuica	Brazilian Percussion	83	Holler	Sound Effects
34	Berimbau *	Brazilian Percussion	84	Voices *	Sound Effects
35	Samba *	Brazilian Percussion	85	Loop Menu *	Sound Effects
36	Tabla Baya	Indian Percussion	86	Reversed Sounds	Sound Effects
37	Pot Drums	Indian Percussion	87	Ambience	Sound Effects
38	Madal & Dholak *	Indian Percussion	88	Deep (Full Set)	Full Set Kit
39	Sitar *	Indian Stringed Instrument	89	Recording (Full Set)	Full Set Kit
40	Santoor	Indian Struck Stringed Instrument	90	Vintage (Full Set)	Full Set Kit
41	Tambura	Indian Stringed Instrument	91	Jazz (Full Set)	Full Set Kit
42	African *	African Percussion	92	Jazz Brushes (Full Set)	Full Set Kit
43	Kalimba	African Percussion	93	Analog (Full Set)	Full Set Kit
44	Balaphone	African Percussion	94	Kit Copy	
45	Darbuka	Percussion	95	Kit Copy	
46	Doholla	Percussion	96	for Patch Expand 1	
47	Hammer Dulcimer	Struck Stringed Instrument	97	for Patch Expand 2	
48	Japanese	Japanese Percussion	98	for Patch Expand 3	
49	Korean	Korean Percussion	99	for Patch Expand 4	
50	Chinese	Chinese Percussion			



Patches marked with an asterisk "*" are made using phrase-loop Instruments.

Parameter List

GROUP	PARAMETER	VALUE (DISPLAY)	PAGE
SOUND	INST	b01–b50, S01–S86, t01–t40, h01–h33, H01–H17, C01–C36, L01–L78, i01–i33, F01–F37, J01–J51, o01–o24, M01–M59, A01–A16, d01–d43, E01–E46, n01–n31, r01–r20, Mut, oFF	22
	LEVEL	0–15	23
	PITCH	-24–24	23
	DECAY	-31–31	23
	PAN	L7–L1, Ctr, r1–r7, rnd	23
	CURVE	Lnr, EP1–EP4, SP1, SP2, SF1–SF4, Hd1–Hd4, CSt	24
	FX SEND	0–15	25
MIDI	TX CH	1–16, oFF, P1–P16, S-S, C-S, toP	61
	NOTE #	0–127, oFF	62
	GT TIME	01–40, ALt	63
	PAN	L7–L1, Ctr, r1–r7, rnd, oFF	63
	CURVE	Lnr, EP1–EP4, SP1, SP2, SF1–SF4, Hd1–Hd4, CSt	64
	SENS	1–15	64
	PGM CHG	1–128, oFF	65
FX/PEDAL	FX TYPE	1–25	28
	FX TIME	1–32	28
	FX LEVEL	0–15	28
	PDL CTRL	HH, EFS, U07, U12, U24, d05, d12, d24	54
	PDL LEVEL	0–15	55
	PDL CC #	oFF, 1, 4, 10, 11, 16, 17, 64	56
SYSTEM	BASIC CH	1–16	67
	BULK DUMP	ALL, 1–99	75
	PATCH EXPAND	oFF, on	69
	TRIG SENS	1–16	43
	TRIG THRESHOLD	0–15	44
	TRIG TYPE	Pd5, Pd7, Pd9, 100, 120, P1, P2, Kd7, K1, K2, KiK, Snr, toM, FLr	45
	TRIG CURVE	-2, -1, 0, 1, 2	47

GROUP	PARAMETER	VALUE (DISPLAY)	PAGE
ADVANCED TRIGGER PARAMETER	SCAN TIME [x 0.1ms]	00–30	51
	RETRIGGER CANCEL	1–16	52
	MASK TIME [ms]	00–64	52
	CROSSTALK CANCEL	oFF, 30, 40, 50, 60, 70, 80	53
	RIM SENS (PD-120)	oFF, 1–15	53

Trigger Type Internal Parameters (Advanced Trigger Parameters)

Refer to the chart for the Advanced Trigger Parameter values, which are set automatically when the Trigger Type is set.

ADVANCED TRIGGER PARAMETER	for DRUM PAD										for DRUM TRIGGER			
	Pd5	Pd7	Pd9	100	120	P1	P2	Kd7	K1	K2	KiK	Snr	toM	FLr
SCAN TIME [x 0.1ms]	15	00	00	00	10	10	20	00	10	20	10	10	10	20
RETRIGGER CANCEL	1	1	1	1	1	1	1	7	7	7	7	5	7	9
MASK TIME [ms]	12	12	12	12	12	12	12	12	28	28	28	28	28	28
CROSSTALK CANCEL	50	40	40	30	30	50	50	oFF	oFF	oFF	40	40	40	30
RIM SENSITIVITY	---	---	---	---	9	---	---	---	---	---	---	---	---	---

Pd5: PD-5

100: PD-100

P2: PAD 2

K2: KICK PAD 2

toM: TOM TOM

Pd7: PD-7

120: PD-120

Kd7: KD-7

KiK: KICK

FLr: FLOOR TOM

Pd9: PD-9

P1: PAD 1

K1: KICK PAD 1

Snr: SNARE

Blank Parameter Chart

PATCH PARAMETER

PATCH No.	
PATCH NAME	

PAD BANK	A	B
LAYER	ON	OFF
FX ON/OFF	ON	OFF

FX/PEDAL	FX TYPE	
	FX TIME	
	FX LEVEL	
	PDL CTRL	
	PDL LEVEL	
	PDL CC #	

INTERNAL PAD

		PAD 1		PAD 2		PAD 3		PAD 4		PAD 5		PAD 6		PAD 7		PAD 8	
		BANK A	BANK B	BANK A	BANK B	BANK A	BANK B	BANK A	BANK B	BANK A	BANK B	BANK A	BANK B	BANK A	BANK B	BANK A	BANK B
SOUND	INST																
	LEVEL																
	PITCH																
	DECAY																
	PAN																
	CURVE																
	FX SEND																
MIDI	TX CH																
	NOTE #																
	GT TIME																
	PAN																
	CURVE																
	SENS																
	PGM CHG																

EXTERNAL PAD

		HEAD 1		RIM 1		HEAD 2		RIM 2		HEAD 3		RIM 3		HEAD 4		RIM 4	
		BANK A	BANK B	BANK A	BANK B	BANK A	BANK B	BANK A	BANK B	BANK A	BANK B	BANK A	BANK B	BANK A	BANK B	BANK A	BANK B
SOUND	INST																
	LEVEL																
	PITCH																
	DECAY																
	PAN																
	CURVE																
	FX SEND																
MIDI	TX CH																
	NOTE #																
	GT TIME																
	PAN																
	CURVE																
	SENS																
	PGM CHG																

TRIGGER PARAMETER

		TRIG 1	TRIG 2	TRIG 3	TRIG 4	INTERNAL PAD
BASIC	TRIG SENS					
	TRIG THRESHOLD					
	TRIG TYPE					
	TRIG CURVE					
ADVANCED	SCAN TIME					
	RETRIGGER CANCEL					
	MASK TIME					
	CROSSTALK CANCEL					
	RIM SENSITIVITY (PD-120)					

Roland Exclusive Message

1. Data Format for Exclusive Messages

Roland's MIDI implementation uses the following data format for all Exclusive messages (type IV):

Byte	Description
F0H	Exclusive Status
41H	Manufacturer ID (Roland)
DEV	Device ID
MDL	Model ID
CMD	Command ID
[BODY]	Main data
F7H	End of exclusive

• MIDI status: F0H, F7H

An Exclusive message must be flanked by a pair of status codes, starting with a Manufacturer ID immediately after F0H (MIDI version 1.0).

• Manufacturer ID: 41H

The Manufacturer ID identifies the manufacturer of a MIDI instrument that sends an Exclusive message. Value 41H represents Roland's Manufacturer ID.

• Device ID: DEV

The Device ID contains a unique value that identifies individual devices in the implementation of several MIDI instruments. It is usually set to 00H-0FH, a value smaller by one than that of a basic channel, but value 00H-1FH may be used for a device with several basic channels.

• Model ID: MDL

The Model ID contains a value that identifies one model from another. Different models, however, may share an identical Model ID if they handle similar data.

The Model ID format may contain 00H in one or more places to provide an extended data field. The following are examples of valid Model IDs, each representing a unique model:

01H
02H
03H
00H, 01H
00H, 02H
00H, 00H, 01H

• Command ID: CMD

The Command ID indicates the function of an Exclusive message. The Command ID format may contain 00H in one or more places to provide an extended data field. The following are examples of valid Command IDs, each representing a unique function:

01H
02H
03H
00H, 01H
00H, 02H
00H, 00H, 01H

• Main data: BODY

This field contains a message to be exchanged across an interface. The exact data size and content will vary with the Model ID and Command ID.

2. Address-mapped Data Transfer

Address mapping is a technique for transferring messages conforming to the data format given in Section 1. It assigns a series of memory-resident records—waveform and tone data, switch status, and parameters, for example, to specific locations in a machine-dependent address space, thereby allowing access to data residing at the address a message specifies.

Address-mapped data transfer is therefore independent of models and data categories. This technique allows use of two different transfer procedures: one-way transfer and handshake transfer.

• One-way transfer procedure (See Section 3 for details.)

This procedure is suited to the transfer of a small amount of data. It sends out an Exclusive message completely independent of the receiving device's status.

Connection Diagram

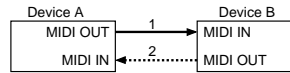

Connection at point 2 is essential for "Request data" procedures. (See Section 3.)

• Handshake-transfer procedure (This device does not use this procedure)

This procedure initiates a predetermined transfer sequence (handshaking) across the interface before data transfer takes place. Handshaking ensures that reliability and transfer speed are high enough to handle a large amount of data.

Connection Diagram

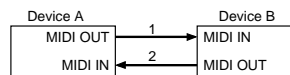

Connection at points 1 and 2 is essential.

Notes on the above procedures

* There are separate Command IDs for different transfer procedures.

* Devices A and B cannot exchange data unless they use the same transfer procedure, share identical Device ID and Model ID, and are ready for communication.

3. One-way Transfer Procedure

This procedure sends out data until it has all been sent and is used when the messages are so short that answerbacks need not be checked.

For longer messages, however, the receiving device must acquire each message in time with the transfer sequence, which inserts 20 milliseconds intervals.

Types of Messages

Message	Command ID
Request data 1	RQ1 (11H)
Data set 1	DT1 (12H)

• Request data #1: RQ1 (11H)

This message is sent out when there is a need to acquire data from a device at the other end of the interface. It contains data for the address and size that specify designation and length, respectively, of data required.

On receiving an RQ1 message, the remote device checks its memory for the data address and size that satisfy the request.

If it finds them and is ready for communication, the device will transmit a "Data set 1 (DT1)" message, which contains the requested data. Otherwise, the device won't send out anything.

Byte	Description
F0H	Exclusive Status
41H	Manufacturer ID (Roland)
DEV	Device ID
MDL	Model ID
11H	Command ID
aaH	Address MSB
	LSB
ssH	Size MSB
	LSB
sum	Check sum
F7H	End of exclusive

* The size of the requested data does not indicate the number of bytes that will make up a DT1 message, but represents the address fields where the requested data resides.

* Some models are subject to limitations in data format used for a single transaction. Requested data, for example, may have a limit in length or must be divided into predetermined address fields before it is exchanged across the interface.

* The same number of bytes comprises address and size data, which, however, vary with the Model ID.

* The error-checking process uses a checksum that provides a bit pattern where the last 7 bits are zero when values for an address, size, and that checksum are summed.

• Data set 1: DT1 (12H)

This message corresponds to the actual data transfer process. Because every byte in the data is assigned a unique address, a DT1 message can convey the starting address of one or more bits of data as well as a series of data formatted in an address-dependent order.

The MIDI standards inhibit non real-time messages from interrupting an Exclusive one. This fact is inconvenient for devices that support a "soft-thru" function. To maintain compatibility with such devices, Roland has limited the DT1 to 256 bytes so that an excessively long message is sent out in separate 'segments'.

Byte	Description
F0H	Exclusive Status
41H	Manufacturer ID (Roland)
DEV	Device ID
MDL	Model ID
12H	Command ID
aaH	Address MSB
	LSB
ddH	Data MSB
	LSB
sum	Check sum
F7H	End of exclusive

* A DT1 message is capable of providing only the valid data among those specified by an RQ1 message.

* Some models are subject to limitations in data format used for a single transaction. Requested data, for example, may have a limit in length or must be divided into predetermined address fields before it is exchanged across the interface.

* The number of bytes comprising address data varies from one Model ID to another.

* The error-checking process uses a checksum that provides a bit pattern where the last 7 bits are zero when values for an address, size, and that checksum are summed.

• Example of Message Transactions

• Device A sending data to Device B

Transfer of a DT1 message is all that takes place.

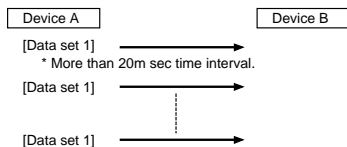

• Device B requesting data from Device A

Device B sends an RQ1 message to Device A. Checking the message, Device A sends a DT1 message back to Device B.

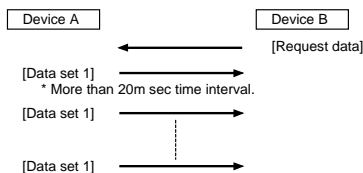

MIDI Implementation

TOTAL PERCUSSION PAD

Model SPD-20

Date: Dec. 4 1997

Version: 1.00

1. TRANSMITTED DATA

[Channel Voice Message]

(1) Note off

Status	Second	Third
9nH	kkH	00H
n = MIDI Channel:	0H-FH (ch.1-ch.16)	
kk = Note number:	00H-7FH (0-127)	

(2) Note on

Status	Second	Third
9nH	kkH	vvH
n = MIDI Channel:	0H-FH (ch.1-ch.16)	
kk = Note number:	00H-7FH (0-127)	
vv = Velocity:	01H-7FH (1-127)	

The SPD-20 transmits through the MIDI Channels set to each Pad's Transmit Channel (TX CH). However, there is no transmission if the Transmit Channel is set to P1-P16, S-S, C-S, or toP.

When the Gate Time is set to 01-40, after Note On is transmitted, Note Off is transmitted after the set time has elapsed. However, if a new sound is produced by the same Pad before Note Off is transmitted, then Note Off is transmitted at that time.

With Gate Time set to ALt, Note On and Note Off messages are alternately transmitted when you strike the Pad. However, when switching Patches,

When the Layer function is on, settings for both Bank A and Bank B are transmitted.

(3) Polyphonic Key Pressure

Status	Second	Third
AnH	kkH	vvH
n = MIDI Channel:	0H-FH (ch.1-ch.16)	
kk = Note number:	00H-127H (0-127)	
vv = Value:	00H, 7FH (0, 127)	

These are transmitted via the MIDI Channel that is set to each Pad's Transmit Channel. However, if the Transmit Channel is set to P1-P16, S-S, C-S, or toP, the settings are not transmitted.

This message is transmitted with value 7FH when grab the rim of the pad or value 00H when release the rim. Note number to be transferred is content of the head/rim of grabbed pad.

When the "SOUND" is set from "H**", the note number of the head, rim, note number of head minus 2, note number of head minus 4, note number of rim minus 2, note number of rim minus 4 are transferred.

When the "LAYER" is set at "ON", the note number of "BANK A" and "BANK B" are transmitted.

(4) Control Change

Modulation Depth (Controller number 1)

Status	Second	Third
BnH	01H	vvH

Foot Control (Controller number 4)

Status	Second	Third
BnH	04H	vvH

Expression (Controller number 11)

Status	Second	Third
BnH	0BH	vvH

General purpose controller 1 (Controller number 16)

Status	Second	Third
BnH	10H	vvH

General purpose controller 2 (Controller number 17)

Status	Second	Third
BnH	11H	vvH
n = MIDI channel:	0H-0FH (ch.1-ch.16)	
vv = Parameter Value:	00H-7FH (0-127)	

This transmits the Hi-Hat Controller position message as one of the Control Messages set in PDL CC#.

When the Footswitch function is set as a hold pedal, then if the pedal is pressed, 7FH is transmitted; when the pedal is released, 00H is transmitted.

It is transmitted via the MIDI Channel set to the Basic Channel.

Hold1 (Controller number 64)

Status	Second	Third
BnH	40H	vvH
n = MIDI channel:	0H-0FH (ch.1-ch.16)	
vv = Parameter Value:	00H-7FH (0-127)	

This transmits the Hi-Hat Controller position message as one of the Control Messages set in PDL CC#.

It is transmitted via the MIDI Channel set to the Basic Channel.

Panpot (Controller number 10)

Status	Second	Third
BnH	0AH	vvH
n = MIDI channel:	0H-0FH (ch.1-ch.16)	
vv = Panpot:	00H-7FH (0-127)	

This transmits the Hi-Hat Controller position message as one of the Control Messages set in PDL CC#.

It is transmitted via the MIDI Channel set to the Basic Channel.

These are transmitted via the MIDI Channel that is set to each Pad's Transmit Channel. However, if the Transmit Channel is set to P1-P16, S-S, C-S, or toP, the settings are not transmitted.

When the Pad is struck, the Panpot value corresponding to the MIDI PAN set to the Pad is transmitted.

The Panpot message is not transmitted when the Transmit Channel and the Panpot value of a Pad that is tapped are the same as those of the most recently tapped Pad.

The Panpot value

MIDI PAN	vv
L7	0
L6	9
L5	18
L4	27
L3	36
L2	45
L1	54
Ctr	64
R1	73
R2	82
R3	91
R4	100
R5	109
R6	118
R7	127
rnd	one of upper value

(5) Program Change

Status	Second
CnH	ppH
n = MIDI channel:	0H-FH (ch.1-ch.16)
pp = Program number:	00H-7FH (prog.1-prog.128)

With the Transmit Channel set to 1-16, when you switch Patches, the Transmit Channel and Program Changes set to each of the Pads in Banks A and B are transmitted.

With the Transmit Channel set to P1-P16, when you strike Pads, the Transmit Channel and Program Changes set to each of the Pads in Banks A and B are transmitted.

[System Exclusive Message]

Status	System Exclusive
F0H:	System Exclusive
F7H:	EOX (End Of Exclusive)

With the SPD-20, the System Exclusive Message can be used to transmit Bulk Dump of patch data, instrument data, system data, chain data and sequence data.

For details refer to "3. Exclusive Communications" and "Roland Exclusive Message."

[System Common Message]

(1) Song Position Pointer

Status	Second	Third
F2H	00H	00H

When "toP" is selected as the Transmit Channel, messages are transmitted when the Pad is struck.

[System Realtime Message]

(1) Start

Status
FAH

When "S-S" is selected as the Transmit Channel, messages are transmitted when the Pad is struck. Afterwards, striking the Pad alternately transmits Stop and Start messages.

(2) Continue

Status
FBH

When "C-S" is selected as the Transmit Channel, messages are transmitted when the Pad is struck. Afterwards, striking the Pad alternately transmits Stop and Continue messages.

(3) Stop

Status
FCH

When "S-S" or "C-S" is selected as the Transmit Channel, striking the Pad after transmitting Start or Continue messages transmits.

(4) Active Sensing

Status
FEH

Normal transmission takes approximately 240 ms.

2.RECEIVED DATA

[Channel Voice Message]

(1) Note On

Status	Second	Third
9nH	kkH	vvH
n = MIDI channel:	0H-0FH (ch.1-ch.16)	
kk = Note number:	00H-7FH (0-127)	
vv = Velocity:	01H-7FH (1-127)	

The SPD-20 receives Note on messages on the basic channel. If the received Note number is assigned to any pad, the instrument which is assigned to that pad will sound. If there are two (or more) pads which are assigned the same Note number, the instrument priority is given to the lower (lowest) pad number. When the Layer is set at "ON", the note number of "BANK B" is ignored.

(2) Polyphonic Key Pressure

Status	Second	Third
AnH	kkH	vvH
n = MIDI channel:	0H-FH (ch.1-ch.16)	
kk = Note number:	00H-7FH (0-127)	
vv = Value:	00H-7FH (0-127)	

The SPD-20 receives the message on the basic channel. If the value is greater than or equal to 40H(64), the decay of the instrument which corresponds to the Note number is made shorter.

(3) Control Change

Modulation Depth (Controller number 1)

Status	Second	Third
BnH	01H	vvH

Foot Control (Controller number 4)

Status	Second	Third
BnH	04H	vvH

Panpot (Controller number 10)

Status	Second	Third
BnH	0AH	vvH

Expression (Controller number 11)

Status	Second	Third
BnH	0BH	vvH

General purpose controller 1 (Controller number 16)

Status	Second	Third
BnH	10H	vvH

General purpose controller 2 (Controller number 17)

Status	Second	Third
BnH	11H	vvH
n = MIDI channel:	0H-0FH (ch.1-ch.16)	
vv = Parameter Value:	00H-7FH (0-127)	

Any one of the Control Messages set in PDL CC# is received as a Hi-Hat Control pedal Position Message. The result of receiving the message depends on the parameter of "PDL CTRL". The SPD-20 receives the message on the basic channel.

Hold1 (Controller number 64)

Status	Second	Third
BnH	40H	vvH
n = MIDI channel:	0H-0FH (ch.1-ch.16)	
vv = Parameter Value:	00H-7FH (0-127)	

Any one of the Control Messages set in PDL CC# is received as a Hi-Hat Control pedal Position Message. Effects are determined in the PDL CTRL settings. When Hold is selected for the PDL CC# setting, with vv = 40H-7FH, Hold is turned on, and when vv = 00H-3FH, Hold is turned off. This is received via the channel set to the Basic Channel.

(4) Program Change

Status	Second
CnH	ppH
n = MIDI channel:	0H-0FH (ch.1-ch.16)
pp = Program number:	00H-62H (0-98)

The SPD-20 receives the message on the basic channel. The program change number 0-98 correspond to the patch number 1-99.

[Channel Mode Message]

(1) Reset All Controllers

Status	Second	Third
BnH	79H	00H
n = MIDI channel:	0H-FH (ch.1-ch.16)	

The SPD-20 receives the message on the basic channel. The SPD-20 initializes the controller on receiving this message.

Modulation Depth	0
Foot Controller	0
Panpot	0
Expression	0
General Purpose Controller 1	0
General Purpose Controller 2	0
Hold 1	0

[System Real Time Message]

(1) Active Sensing

Status
FEH

Whenever the SPD-20 receives this message, it monitors the interval of the coming data. If the subsequent message has not arrived within 300ms after the previous data, it process as though it has received Reset All Controllers and stops monitoring receiving interval.

[System Exclusive Message]

Status

F0H: System Exclusive
F7H: EOX (End Of Exclusive)

When using Exclusive Messages with the SPD-20, you can bulk dump Patch data, System data, and Chain data.

For details refer to "Roland Exclusive Message" and paragraph "3. Exclusive Communications."

3.Exclusive Communications

[General]

SPD-20 can do one-way communications to send and receive parameters for sequence and setup.

Model ID included in the exclusive message should be 00H 0DH. The device ID code should be BASIC CH of System. Note that the actual value that set in the device ID field is smaller by one than the value set at parameter BASIC CH of System.

[One Way Communications]

Request data RQ1 11H

Byte	Description
F0H	Exclusive status
41H	Manufacturer's ID (Roland)
DEV	Device ID (00H-0FH)
00H 0DH	Model ID (SPD-20)
11H	Command ID (RQ1)
aaH	Address MSB
aaH	Address
aaH	Address
aaH	Address LSB
ssH	size MSB
ssH	size
ssH	size
ssH	size LSB
sum	Checksum
F7H	EOX (End of Exclusive)

Data set DT1 12H

Byte	Description
F0H	Exclusive status
41H	Manufacturer's ID (Roland)
DEV	Device ID (00H-0FH)
00H 0DH	Model ID (SPD-20)
12H	Command ID (DT1)
aaH	Address MSB
aaH	Address
aaH	Address
aaH	Address LSB
ddH	data
.	
.	
sum	Checksum
F7H	EOX (End of Exclusive)

[Transmission]

The SPD-20 transmit exclusive messages only when MIDI Bulk dump is performed by panel operation on menu of System function.

[Receive]

When the SPD-20 is using One Way Communication, parameters are received when Bulk Dump is not executed.

The SPD-20 can receive SPD-11 Patch parameter System Exclusive messages. When this is done, the SOUND INST Sound parameter is shifted and saved to the SPD-20 Instrument Number having the same tone as the one received from the SPD-11.

4.Parameter address map

Addresses are shown in every 7-bit hexadecimal.

Address	MSB			LSB
Binary	0aaa aaaa	0bbb bbbb	0ccc cccc	0ddd dddd
7-bit hex.	AA	BB	CC	DD

[Parameter base addresses]

Start Address	Description	
00 00 00 00	Patch parameters	*4-1
01 00 00 00	System parameters	*4-2
02 00 00 00	Chain setup	*4-3

Table 4-1 Patch parameters

* p: Patch No. (0-98), t: Pad No. (1-32)

The correspondence of the "t" value to internal and external pads is as follows.

00H (1):	BANK A INTERNAL PAD1
07H (8):	BANK A INTERNAL PAD8
08H (9):	BANK A EXTERNAL HEAD1
0BH (12):	BANK A EXTERNAL HEAD4
0CH (13):	BANK A EXTERNAL RIM1
0FH (16):	BANK A EXTERNAL RIM4
10H (17):	BANK B INTERNAL PAD1
17H (24):	BANK B INTERNAL PAD8
18H (25):	BANK B EXTERNAL HEAD1
1BH (28):	BANK B EXTERNAL HEAD4
1CH (29):	BANK B EXTERNAL RIM1
1FH (32):	BANK B EXTERNAL RIM4

Offset Address	Description		
pp 00 00	BANK A/B	0-1	(0: A, 1: B)
00 01	LAYER	0-1	(0: OFF, 1: ON)
00 02	FX ON/OFF	0-1	(0: OFF, 1: ON)
00 03	FX TYPE	0-24	
00 04	FX TIME	0-31	
00 05	FX LEVEL	0-15	
00 06	PDL CTRL	0-7	(0: HH, 1: EFS, 2: U07, 3: U12, 4: U24, 5: d05, 6: d12, 7: d24)
00 07	PDL LEVEL	0-15	
00 08	PDL CC#	0-7	
tt 00	SOUND INST Upper 3bits		
tt 01	SOUND INST Lower 7bits		0-701 (700: Mut, 701: oFF)
tt 02	SOUND LEVEL	0-15	
tt 03	SOUND PITCH	0-48	
tt 04	SOUND DECAY	*31-~*31	Lower 7bits of 2's complement
tt 05	SOUND PAN	0-15	(0-14: L7-R7, 15: RND)
tt 06	SOUND CURVE	0-15	
tt 07	SOUND FX SEND	0-15	
tt 08	MIDI TX CH	0-35	(16: OFF, 17-32: P1-P16, 33: S-S, 34: C-S, 35: toP)
tt 09	MIDI NOTE #	0-127	
tt 0A	MIDI NOTE #	0-1	(1: OFF)
tt 0B	MIDI GT TIME	1-41	(41: ALt)
tt 0C	MIDI PAN	0-16	(0-14: L7-R7, 15: RND, 16: OFF)
tt 0D	MIDI CURVE	0-15	
tt 0E	MIDI SENS	0-14	
tt 0F	MIDI PGM CHG	0-127	
tt 10	MIDI PGM CHG	0-1	(1: OFF)

Table 4-2 System parameters

Offset Address	Description		
00	PATCH EXPAND	0-1	(0: OFF, 1: ON)
01	TRIG SENS (INTERNAL)	0-15	
02	TRIG THRESHOLD (INTERNAL)	0-15	
03	EPAD1 Trig Type	0-13	(0: Pd5, 1: Pd7, 2: Pd9, 3: 100, 4: 120, 5: P1, 6: P2, 7: Kd7, 8: K1, 9: K2, 10: KiK, 11: Snr, 12: toM, 13: FLr)
04	EPAD1 Trig Sens	0-15	
05	EPAD1 Trig Threshold	0-15	
06	EPAD1 Trig Curve	0-4	
07	EPAD1 Scan Time	0-30	
08	EPAD1 Retrigger Cance	0-15	
09	EPAD1 Mask Time	0-16	
0A	EPAD1 Crosstalk Cancel	0-6	
0B	EPAD1 Rim Sens	0-15	
0C	EPAD2 Trig Type	0-13	(0: Pd5, 1: Pd7, 2: Pd9, 3: 100, 4: 120, 5: P1, 6: P2, 7: Kd7, 8: K1, 9: K2, 10: KiK, 11: Snr, 12: toM, 13: FLr)
0D	EPAD2 Trig Sens	0-15	
0E	EPAD2 Trig Threshold	0-15	
0F	EPAD2 Trig Curve	0-4	
10	EPAD2 Scan Time	0-30	
11	EPAD2 Retrigger Cancel	0-15	
12	EPAD2 Mask Time	0-16	

MIDI Implementation Chart

TOTAL PERCUSSION PAD

Date : Dec. 4, 1997

Model SPD-20

MIDI Implementation Chart

Version : 1.00

Function...	Transmitted	Recognized	Remarks
Basic Channel Default Changed	Off, 1-16 *1 Off, 1-16 *1	1-16 1-16	Memorized (Non-volatile)
Mode Default Messages Altered	Mode 3 X *****	Mode 3 X	
Note Number : True Voice	Off, 0-127 *2 *****	Off, 0-127 *2	
Velocity Note ON Note OFF	O 9n v = 1-127 X 9n v = 0	O 9b v = 1-127 X	n = Pad ch. b = Basic ch.
After Touch Key's Ch's	0, 127 X	O 0, 127 X	
Pitch Bend	X	X	
Control Change	1 X *3	X *3	Modulation
	4 O *3	O *3	Foot
	10 X *3	X *3	Pan Expression
	11 X *3	X *3	
	16 X *3	X *3	General Purpose 1
	17 X *3	X *3	General Purpose 2
	64 X *3 *4	O *3	Hold 1
121 X	O	Reset all controllers	
Program Change : True #	O *1 Off, 0-127	O 0-98	
System Exclusive	O	O	
System Common : Song Pos : Song Sel : Tune	X *1 X X	X X X	
System Real Time : Clock : Commands	X X *1	X X	
Aux Message : Local ON/OFF : All Notes OFF : Active Sense : System Reset	X X O X	X X O X	
Notes	* 1 Can be set and stored for each pad. * 2 Common to "Transmitted" and "Recognized." * 3 Select one to use as the Hi-hat Control pedal. * 4 Transmitted when Footswitch is set to "Hold pedal."		

Mode 1 : OMNI ON, POLY
Mode 3 : OMNI OFF, POLY

Mode 2 : OMNI ON, MONO
Mode 4 : OMNI OFF, MONO

O : Yes
X : No

How to Read a MIDI Implementation Chart

O: MIDI messages that can be transmitted or received

X: MIDI messages that cannot be transmitted or received

- **Basic Channel**

This is the range of MIDI channels on which MIDI messages can be transmitted (received). The MIDI channel setting will be retained even when the power is turned off.

- **Mode**

Most keyboards today use mode 3 (omni off, poly). This means that MIDI messages will only be received on a specific MIDI channel, and will be played polyphonically.

NOTE *The MIDI “mode” setting is relevant only to reception.*

- **Note Number**

This is the range of note numbers that can be transmitted (received). Note Number 60 is middle C (C4).

- **Velocity**

This is the range of velocity values which can be transmitted (received) as part of each Note On or Note Off message.

- **Aftertouch**

Polyphonic: aftertouch is independent for each key in the channel.

Channel: aftertouch applies equally to all keys in the channel.

- **Pitch Bend**

The SPD-20 does not transmit/receive this data.

- **Control Change**

These are the Control Change numbers which can be transmitted (received), and the control functions they can have. For details refer to the MIDI Implementation.

- **Program Change**

The Program Numbers in the chart are the actual data values. The Patch numbers will be one number higher.

- **Exclusive**

Patch data can be transmitted and received as an Exclusive message.

- **Common, Realtime**

This MIDI message is used when the SPD-20 plays concurrently with a sequencer or rhythm machine, or when Start/Stop/Continue messages are in effect.

- **Other**

This category includes messages such as Active Sensing (to monitor the integrity of MIDI connections), which help keep a MIDI system running properly.

Specifications

SPD-20: Total Percussion Pad

• Pads

Built-in Pads: 8

Four external trigger inputs (dual) are provided, allowing you to connect Pads.

• Maximum Polyphony

14 voices

• Instruments

700

• Memory

Patches: 99

Patch Chains: 8

• Sound Parameters

Instrument

Level

Pitch

Decay

Pan

Curve

Effect Send Level

• Effects

Reverb

Delay

Chorus

Flanger

• Display

7 segments, 3 characters (LED)

• Connectors

Output Jacks (L [Mono], R)

Phones Jack (Stereo)

Trigger Input Jacks (Dual): 3

HH CTRL/TRIG 4 Jack (Dual)

MIDI Connectors (IN, OUT)

Foot Sw Jack (Dual)

Trigger inputs 1 and 2 accept rim shots from the PD-7, PD-9 and PD-120 while inputs 3 and 4 accept rim shots from the PD-7 and PD-9.

• Power Supply

AC 12 V: AC Adaptor

• Current Draw

420 mA

• Dimensions

450 (W) x 350 (D) x 70 (H) mm

17-3/4 (W) x 13-13/16 (D) x 2-13/16 (H) inches

• Weight

2.8 kg

6 lbs 3 oz

(excepting AC adaptor)

• Accessories

Owner's Manual

AC Adaptor (BOSS BRA Series)

Slit Tape

• Options

Pads (PD-120, PD-100, PD-9, PD-7, PD-5)

Kick Trigger Unit (KD-7)

Hi-Hat Control Pedal (FD-7)

Footswitch (BOSS FS-5U)

Footswitch Cable (BOSS PCS-31)

Pedal Switch (DP-2/6)

All-purpose Clamp Set (APC-33)

In the interest of product improvement, the specifications and/or appearance of this unit are subject to change without prior notice.

A	
Acoustic Drum Trigger	45, 48
Advanced Edit Mode	48
Advanced Trigger Parameter	48
Aftertouch Messages	59
ALL	27, 47
All Purpose Clamp Set	10
ALt	63
APC-33	10
B	
BASIC CH	67
Basic Channel	67
Bulk Dump	75
Bulk Load	76
C	
Chorus	81
Closed Hi-Hat	54
Control Change Messages	59
COPY	32
Cord Hook	8
Crosstalk Cancel	53
CURVE(Velocity Curve)	24
Cymbal Choke	39
D	
DECAY	23
Delay	81
Device ID	78
Drum Trigger	45, 48
E	
Edit Mode	19
Effect Level	28
Effect List	79
Effect Parameter	28
Effect Section	18
Effect Send Level	25
Effect Time	28
Effect Type	28, 79
Error Message	87
Exclusive Messages	59
External Pad	37
F	
Factory Initialized State	11
FD-7	36, 40, 54
Foot Close	54
Foot Open	54
Footswitch	15, 38, 40, 41
Franger	81
FS-5U	15
Full Set Kit	36
FX LEVEL	28
FX SEND(Effect Send Level)	25
FX TIME	28
G	
Gate Time	63
GBN System	65
General MIDI System	71
GS Format	71
GT TIME	63
H	
Half Open Hi-Hat	54
Head	39
Hi-Hat Control Pedal	40, 54
Hi-Hat Cymbals for Pedal Control	22
Hold Pedal	41
I	
INST	22
Instrument Group	22
Instrument List	88
Instruments	22
K	
KD-7	36, 37, 45
Kick Pedal	37
Kick Trigger Unit	37
L	
Layer	15, 17
LEVEL	23
Local Control	72
M	
Mask Time	52
MIDI	57
MIDI Channels	58
MIDI Implementation	98
MIDI Implementation Chart	102
MIDI Parameter	61
MIDI Connector	57
MIDI Velocity Curve	64
N	
NOTE #	62
Note Number	58, 62
Note Off	58
Note On	58
O	
Open Hi-Hat	54
P	
Pad Bank	16
Pad Section	18
PAN	23, 63
Parameter List	20, 94
Patch	14
Patch Chain	33
Patch Expand	69
Patch List	93
PD-100	38, 45
PD-120	36, 37, 38, 39, 45
PD-5	37, 45
PD-7	35, 36, 37, 39, 45
PD-9	37, 39, 45
PDL CC#	56
PDL CTRL	54
PDL LEVEL	55
Pedal Control	54
Pedal Controller Numbers	56
Pedal Hi-Hat	54
Pedal Level	55
Pedal Switch	38, 40
Percussion Set	35
PGM CHG	65
Phrase Loop	22
PITCH	23
Play Mode	19
Program Change	61, 65
Program Change Messages	59
PSC-31	15
R	
Receive Channel	67
Retrigger Cancel	52
Reverb	81
Rim	39
Rim Sensitivity	53
Rim Shot	39
ROM	11
S	
Scan Time	51
SENS	64
Slit Tape	10
Soft Thru	73
Sound Generator Section	18
Sound Parameter	22
Specifications	104
System Initialize	11
T	
The Patch used for the Patch Expand Function	70
Transmit Channel	61
TRIG CURVE	47
TRIG SENS	30, 43
TRIG THRESHOLD	31, 44
TRIG TYPE	45
Trigger Curve	47
Trigger Interface Section	18
Trigger Parameter	42
Trigger Sensitivity	30, 43
Trigger Signal	51
Trigger Threshold	31, 44
Trigger Type	45
TX CH	61
V	
Velocity	58
Velocity Crossfade	17
Velocity Curve	24
Velocity Mix	17
Velocity Sensitivity	64
Velocity Switch	17

How-To Index

Internal pad settings

• When playing the SPD-20's pads, how to ...

Adjust the Sensitivity of the pads	30, 43
Adjust the volume of each pad.....	23
Change the decay	23
Change the depth of the effect applied to the sound of each pad.....	25
Change the Instrument triggered by a pad	22
Change the Pan setting	23
Change the pitch.....	23
Change the way playing dynamics affects volume	24, 47
Force the internal tone Phrase Loop to stop using the pads.....	22
Play two Instruments simultaneously.....	17
Prevent improper triggering of the pads	31

• When playing an external MIDI sound module, how to ...

Adjust pad sensitivity	64
Change sounds using Program Change messages	65
Change the length of time that the note is sounded.....	63
Change the MIDI channel	61
Change the Note Number	62
Change the way playing dynamics affects volume.....	64
Use the SPD-20 as a pad controller to play only external sound.....	61
Use the pads to transmit Program Changes to external devices.....	65
Use the pads to start and stop a sequencer.....	61
Use the pads to alternately transmit Note On and Note Off	63

• When using the SPD-20 as a MIDI sound module, how to ...

Make more sounds available from an external controller	69
Set each Instrument's note number	62
Set the receive channel.....	67
Use a Sequencer to record/playback.....	72

External pad settings

Adjust the sensitivity of an external pad	43
Adjusting the Trigger Signal Detection Time.....	51
Prevent double triggering of an external pad	52
Prevent improper triggering of an external pad.....	48
Use external pads	35
Set minimum levels for external pads	44
Set the Trigger Type for external pads	45
Set the Dynamics Curve for external pads	47
Set Rim Sensitivity on the PD-120.....	53

Patch editing

Copy Patch settings to another Patch.....	32
Set all pads to the same parameter value.....	27

While playing

Adjust the overall volume of the SPD-20.....	13
Get half-open sounds with connected FD-7	54
Select Patches	14
Select Patches in a preset order (Patch Chain)	33
Select Patches using footswitches	15
Select Patches using Program Change messages.....	65
Use choke playing technique with connected PD-7	39
Use dual bass drum techniques with connected KD-7s	37
Use rim shot with connected PD-7, PD-9, PD-120	39

Footswitch

Use a footswitch to hold a sound of an external sound module	41
Use footswitches to select Patches	15
Use a footswitch in place of the kick pedal.....	38
Use a footswitch in place of the hi-hat control pedal	40

Hi-Hat Control Pedal

Adjust the hi-hat volume with the pedal	55
Control the hi-hat with the pedal.....	54
Control the Effect Send level, pitch, etc., with the pedal.....	55
Transmit Control Changes to external devices with the pedal.....	56

Effect

Adjust the effect depth for each Instrument assigned to the pad	25
Adjust the overall effect depth for a Patch	28
Change the effect type	28
Control the effect send by using a hi-hat control pedal	55
Taking advantage of the on-board effects.....	79

Other

Adjust the overall volume	13
Attach the SPD-20's tom stand and cymbal stand.....	10
Create a custom drum kit.....	36
Create a custom percussion set.....	35
Read MIDI Implementation Chart.....	60
Read the parameter list.....	94
Read this manual	5
Receive Patch data stored in a sequencer	76
Reset all parameters to the factory settings	11
Reset one patch to the factory settings	32
Transmit Patch data as an Exclusive message.....	75
Turn the power off	13
Turn the power on.....	12
Use the cord hook.....	8
Move Patch data from the SPD-11 to the SPD-20	77

For the U.K.

IMPORTANT: THE WIRES IN THIS MAINS LEAD ARE COLOURED IN ACCORDANCE WITH THE FOLLOWING CODE.

BLUE: NEUTRAL
BROWN: LIVE

As the colours of the wires in the mains lead of this apparatus may not correspond with the coloured markings identifying the terminals in your plug, proceed as follows:

The wire which is coloured BLUE must be connected to the terminal which is marked with the letter N or coloured BLACK.
The wire which is coloured BROWN must be connected to the terminal which is marked with the letter L or coloured RED.
Under no circumstances must either of the above wires be connected to the earth terminal of a three pin plug.

For EU Countries

Apparatus containing Lithium batteries

ADVARSEL!

Lithiumbatteri - Eksplosionsfare ved fejlagtig håndtering.
Udskiftning må kun ske med batteri af samme fabrikat og type.
Levér det brugte batteri tilbage til leverandøren.

ADVARSEL

Ekspløsjonsfare ved feilaktig skifte av batteri.
Benytt samme batteritype eller en tilsvarende type anbefalt av apparatfabrikanten.
Brukte batterier kasseres i henhold til fabrikantens instruksjoner.

CAUTION

Danger of explosion if battery is incorrectly replaced.
Replace only with the same or equivalent type recommended by the manufacturer.
Discard used batteries according to the manufacturer's instructions.

VARNING

Explosionsfara vid felaktigt batteribyte.
Använd samma batterityp eller en ekvivalent typ som rekommenderas av apparatillverkaren.
Kassera använt batteri enligt fabrikantens instruktion.

VAROITUS

Paristo voi räjähtää, jos se on virheellisesti asennettu.
Vaihda paristo ainoastaan laitevalmistajan suosittelemaan tyyppiin. Hävitä käytetty paristo valmistajan ohjeiden mukaisesti.

For EU Countries



This product complies with the requirements of European Directive 89/336/EEC.

For the USA

FEDERAL COMMUNICATIONS COMMISSION RADIO FREQUENCY INTERFERENCE STATEMENT

This equipment has been tested and found to comply with the limits for a Class B digital device, pursuant to Part 15 of the FCC Rules. These limits are designed to provide reasonable protection against harmful interference in a residential installation. This equipment generates, uses, and can radiate radio frequency energy and, if not installed and used in accordance with the instructions, may cause harmful interference to radio communications. However, there is no guarantee that interference will not occur in a particular installation. If this equipment does cause harmful interference to radio or television reception, which can be determined by turning the equipment off and on, the user is encouraged to try to correct the interference by one or more of the following measures:

- Reorient or relocate the receiving antenna.
- Increase the separation between the equipment and receiver.
- Connect the equipment into an outlet on a circuit different from that to which the receiver is connected.
- Consult the dealer or an experienced radio/TV technician for help.

Unauthorized changes or modification to this system can void the users authority to operate this equipment.
This equipment requires shielded interface cables in order to meet FCC class B Limit.

For Canada

NOTICE

This Class B digital apparatus meets all requirements of the Canadian Interference-Causing Equipment Regulations.

AVIS

Cet appareil numérique de la classe B respecte toutes les exigences du Règlement sur le matériel brouilleur du Canada.

Information

When you need repair service, call your nearest Roland Service Center or authorized Roland distributor in your country as shown below.

AFRICA

EGYPT

Al Fanny Trading Office

9, EBN Hagar A1 Askalany Street,
ARD E1 Golf, Heliopolis,
Cairo 11341, EGYPT
TEL: 20-2-417-1828

REUNION

Maison FO - YAM Marcel

25 Rue Jules Hermann,
Chaudron - BP79 97 491
Ste Clotilde Cedex,
REUNION ISLAND
TEL: (0262) 218-429

SOUTH AFRICA

That Other Music Shop (PTY) Ltd.

11 Melle St., Braamfontein,
Johannesburg, SOUTH AFRICA

P.O.Box 32918, Braamfontein 2017
Johannesburg, SOUTH AFRICA
TEL: (011) 403 4105

Paul Bothner (PTY) Ltd.

17 Werdmuller Centre,
Main Road, Claremont 7708
SOUTH AFRICA

P.O.Box 23032, Claremont 7735,
SOUTH AFRICA
TEL: (021) 674 4030

ASIA

CHINA

Beijing Xinghai Musical Instruments Co., Ltd.

6 Huangmunchang Chao Yang
District, Beijing, CHINA
TEL: (010) 6774 7491

Shanghai Xingtong Acoustics Equipment CO., Ltd.

5F. No.1500 Pingliang Road
New East Club Plaza, Shanghai,
CHINA
TEL: (021) 5580-0800

HONG KONG

Tom Lee Music Co., Ltd. Service Division

22-32 Pun Shan Street, Tsuen
Wan, New Territories,
HONG KONG
TEL: 2415 0911

INDIA

Rivera Digitec (India) Pvt. Ltd.

409, Nirman Kendra Mahalaxmi
Flats Compound Off. Dr. Edwin
Moses Road, Mumbai-400011,
INDIA
TEL: (022) 498 3079

INDONESIA

PT Citra IntiRama

J1, Cideng Timur No. 15J-150
Jakarta Pusat
INDONESIA
TEL: (021) 6324170

KOREA

Cosmos Corporation

1461-9, Seocho-Dong,
Seocho Ku, Seoul, KOREA
TEL: (02) 3486-8855

MALAYSIA

BENTLEY MUSIC SDN BHD

140 & 142, Jalan Bukit Bintang
55100 Kuala Lumpur, MALAYSIA
TEL: (03) 2144-3333

PHILIPPINES

G.A. Yupangco & Co. Inc.

339 Gil J. Puyat Avenue
Makati, Metro Manila 1200,
PHILIPPINES
TEL: (02) 899 9801

SINGAPORE

Swee Lee Company

150 Sims Drive,
SINGAPORE 387381
TEL: 846-3676

CRISTOFORI MUSIC PTE LTD

Blk 3014, Bedok Industrial Park E,
#02-2148, SINGAPORE 489980
TEL: 243 9555

TAIWAN

ROLAND TAIWAN

ENTERPRISE CO., LTD.
Room 5, 9fl. No. 112 Chung Shan
N.Road Sec.2, Taipei, TAIWAN,
R.O.C.
TEL: (02) 2561 3339

THAILAND

Theera Music Co., Ltd.

330 Verg NakornKasem, Soi 2,
Bangkok 10100, THAILAND
TEL: (02) 2248821

VIETNAM

Saigon Music

138 Tran Quang Khai St.,
District 1
Ho Chi Minh City
VIETNAM
TEL: (08) 844-4068

AUSTRALIA/ NEW ZEALAND

AUSTRALIA

Roland Corporation

Australia Pty., Ltd.
38 Campbell Avenue
Dee Why West, NSW 2099
AUSTRALIA
TEL: (02) 9982 8266

NEW ZEALAND

Roland Corporation Ltd.

32 Shaddock Street, Mount Eden,
Auckland, NEW ZEALAND
TEL: (09) 3098 715

CENTRAL/LATIN AMERICA

ARGENTINA

Instrumentos Musicales S.A.

Av.Santa Fe 2055
(1123) Buenos Aires
ARGENTINA
TEL: (011) 4508-2700

BRAZIL

Roland Brasil Ltda

Rua San Jose, 780 Sala B
Parque Industrial San Jose
Cotia - Sao Paulo - SP, BRAZIL
TEL: (011) 4615 5666

COSTA RICA

JUAN BANSBACH

Instrumentos Musicales
Ave.1. Calle 11, Apartado 10237,
San Jose, COSTA RICA
TEL: 258-0211

CHILE

Comercial Fancy II S.A.

Rut.: 96.919.420-1
Nataniele Cox #739, 4th Floor
Santiago - Centro, CHILE
TEL: (02) 688-9540

EL SALVADOR

OMNI MUSIC

75 Avenida Norte y Final
Alameda Juan Pablo II,
Edificio No.4010 San Salvador,
EL SALVADOR
TEL: 262-0788

MEXICO

Casa Veerkamp, s.a. de c.v.
Av. Toluca No. 323, Col. Olivar
de los Padres 01780 Mexico D.F.
MEXICO
TEL: 668-0480

PANAMA

SUPRO MUNDIAL, S.A.

Boulevard Andrews, Albrook,
Panama City, REP. DE PANAMA
TEL: 315-0101

PARAGUAY

Distribuidora De

Instrumentos Musicales

J.E. Olear y ESQ. Manduvira
Asuncion PARAGUAY
TEL: (021) 492-124

PERU

VIDEO Broadcast S.A.

Portinari 199 (ESQ. HALS),
San Borja, Lima 41,
REP. OF PERU
TEL: (01) 4758226

URUGUAY

Todo Musica S.A.

Francisco Acuna de Figueroa 1771
C.P.: 11.800
Montevideo, URUGUAY
TEL: (02) 924-2335

VENEZUELA

Musicland Digital C.A.

Av. Francisco de Miranda,
Centro Parque de Cristal, Nivel
C2 Local 20 Caracas
VENEZUELA
TEL: (212) 285-8586

EUROPE

AUSTRIA

Roland Austria GES.M.B.H.

Siemensstrasse 4, P.O. Box 74,
A-6063 RUM, AUSTRIA
TEL: (0512) 26 44 260

BELGIUM/HOLLAND/ LUXEMBOURG

Roland Benelux N. V.

Houtstraat 3, B-2260, Oevel
(Westerlo) BELGIUM
TEL: (014) 575811

DENMARK

Roland Scandinavia A/S

Nordhavnsvej 7, Postbox 880,
DK-2100 Copenhagen
DENMARK
TEL: (039)16 6200

FRANCE

Roland France SA

4, Rue Paul Henri SPAAK,
Parc de l'Esplanade, F 77 462 St.
Thibault, Lagny Cedex FRANCE
TEL: 01 600 73 500

FINLAND

Roland Scandinavia As,

Filial Finland

Lauttaasaarentie 54 B
Fin-00201 Helsinki, FINLAND
TEL: (9) 682 4020

GERMANY

Roland Elektronische

Musikinstrumente HmbH.
Oststrasse 96, 22844 Norderstedt,
GERMANY
TEL: (040) 52 60090

GREECE

STOLLAS S.A.

Music Sound Light
155, New National Road
Patras 26442, GREECE
TEL: (061) 43-5400

HUNGARY

Intermusica Ltd.

Warehouse Area 'DEPO' Pf.83
H-2046 Torokbalint, HUNGARY
TEL: (23) 511011

IRELAND

Roland Ireland

Audio House, Belmont Court,
Donnybrook, Dublin 4,
Republic of IRELAND
TEL: (01) 2603501

ITALY

Roland Italy S. p. A.

Viale delle Industrie 8,
20020 Arese, Milano, ITALY
TEL: (02) 937-78300

NORWAY

Roland Scandinavia Avd.

Kontor Norge

Lilleakerveien 2 Postboks 95
Lilleaker N-0216 Oslo
NORWAY
TEL: 273 0074

POLAND

P. P. H. Brzostowicz

UL. Gibraltarska 4,
PL-03664 Warszawa POLAND
TEL: (022) 679 44 19

PORTUGAL

Tecnologias Musica e Audio,

Roland Portugal, S.A.

Cais Das Pedras, 8/9-1 Dto
4050-465 PORTO
PORTUGAL
TEL: (022) 608 00 60

ROMANIA

FBS LINES

Plata Libertatii 1,
RO-4200 Gheorgheni
TEL: (095) 169-5043

RUSSIA

MuTek

3-Bogatyrskaya Str. 1.k.1
107 564 Moscow, RUSSIA
TEL: (095) 169 5043

SPAIN

Roland Electronics

de España, S. A.

Calle Bolivia 239, 08020
Barcelona, SPAIN
TEL: (93) 308 1000

SWEDEN

Roland Scandinavia A/S

SWEDISH SALES OFFICE

Danvik Center 28, 2 tr.
S-131 30 Nacka SWEDEN
TEL: (08) 702 0020

SWITZERLAND

Roland (Switzerland) AG

Musitronic AG

Gerberstrasse 5, Postfach,
CH-4410 Liestal, SWITZERLAND
TEL: (061) 927-8383

UKRAINE

TIC-TAC

Mira Str. 19/108
P.O. Box 180
295400 Munkachevo, UKRAINE
TEL: (03131) 414-40

UNITED KINGDOM

Roland (U.K.) Ltd.

Atlantic Close, Swansea
Enterprise Park, SWANSEA
SA7 9FJ,
UNITED KINGDOM
TEL: (01792) 700139

MIDDLE EAST

BAHRAIN

Moon Stores

No.16, Bab Al Bahrain Avenue,
P.O.Box 247, Manama 304,
State of BAHRAIN
TEL: 211 005

CYPRUS

Radex Sound Equipment Ltd.

17, Diagorou Street, Nicosia,
CYPRUS
TEL: (02) 66-9426

IRAN

MOCO, INC.

No.41 Nike St., Dr.Shariyati Ave.,
Roberoye Cerah Mirdamad
Tehran, IRAN
TEL: (021) 285-4169

ISRAEL

Halilit P. Greenspoon &

Sons Ltd.

8 Retzif Ha'aliya Hashnya St.
Tel-Aviv-Yafo ISRAEL
TEL: (03) 6823666

JORDAN

AMMAN Trading Agency

245 Prince Mohammad St.,
Amman 1118, JORDAN
TEL: (06) 464-1200

KUWAIT

Easa Husain Al-Yousifi

Abdullah Salem Street,
Safat, KUWAIT
TEL: 243-6399

LEBANON

A. Chahine & Fils

Gerge Zeidan St., Chahine Bldg.,
Achrachieh, P.O.Box: 16-5857
Beirut, LEBANON
TEL: (01) 20-1441

QATAR

Al Emadi Co. (Badie Studio &

Stores)

P.O. Box 62,
Doha, QATAR
TEL: 4423-554

SAUDI ARABIA

aDawlah Universal

Electronics APL

Corniche Road, Aldossary Bldg.,
1st Floor, Alkhobar,
SAUDI ARABIA

P.O.Box 2154, Alkhobar 31952

SAUDI ARABIA

TEL: (03) 898 2081

SYRIA

Technical Light & Sound

Center

Bldg. No. 47,
Khaled Ebn Al Walid St.
Damascus, SYRIA
TEL: (011) 221-1230

TURKEY

Barkat muzik aletleri ithalat

ve ihracat Ltd Sti

Siraselvilir Caddesi Siraselvilir
Pasaji No:74/20
Taksim - Istanbul, TURKEY
TEL: (0212) 2499324

U.A.E.

Zak Electronics & Musical

Instruments Co. L.L.C.

Zabeel Road, Al Sherooq Bldg.,
No. 14, Grand Floor, Dubai, U.A.E.
TEL: (04) 3360715

NORTH AMERICA

CANADA

Roland Canada Music Ltd.

(Head Office)

5480 Parkwood Way Richmond
B. C., V6V 2M4 CANADA
TEL: (604) 270 6626

Roland Canada Music Ltd.

(Toronto Office)

Unit 2, 109 Woodbine Downs
Blvd, Etobicoke, ON
M9W 6Y1 CANADA
TEL: (0416) 213 9707

U. S. A.

Roland Corporation U.S.

5100 S. Eastern Avenue
Los Angeles, CA 90040-2938,
U. S. A.
TEL: (323) 890 3700

As of January 1, 2002 (Roland)

Free Manuals Download Website

<http://myh66.com>

<http://usermanuals.us>

<http://www.somanuals.com>

<http://www.4manuals.cc>

<http://www.manual-lib.com>

<http://www.404manual.com>

<http://www.luxmanual.com>

<http://aubethermostatmanual.com>

Golf course search by state

<http://golfingnear.com>

Email search by domain

<http://emailbydomain.com>

Auto manuals search

<http://auto.somanuals.com>

TV manuals search

<http://tv.somanuals.com>