

Roland Drum System **TD-8KV**

Owner's Manual

Thank you, and congratulations on your choice of the TD-8KV Roland Drum System.

Before using this unit, carefully read the sections entitled: "USING THE UNIT SAFELY" (p. 2-3) and "IMPORTANT NOTES" (p. 4). These sections provide important information concerning the proper operation of the unit. Additionally, in order to feel assured that you have gained a good grasp of every feature provided by your new unit, Owner's manual should be read in its entirety. The manual should be saved and kept on hand as a convenient reference.







Copyright © 2001 ROLAND CORPORATION

All rights reserved. No part of this publication may be reproduced in any form without the written permission of ROLAND CORPORATION.







USING THE UNIT SAFELY

INSTRUCTIONS FOR THE PREVENTION OF FIRE, ELECTRIC SHOCK, OR INJURY TO PERSONS

About  WARNING and  CAUTION Notices

 WARNING	Used for instructions intended to alert the user to the risk of death or severe injury should the unit be used improperly.
 CAUTION	Used for instructions intended to alert the user to the risk of injury or material damage should the unit be used improperly. * Material damage refers to damage or other adverse effects caused with respect to the home and all its furnishings, as well to domestic animals or pets.

About the Symbols

	The  symbol alerts the user to important instructions or warnings. The specific meaning of the symbol is determined by the design contained within the triangle. In the case of the symbol at left, it is used for general cautions, warnings, or alerts to danger.
	The  symbol alerts the user to items that must never be carried out (are forbidden). The specific thing that must not be done is indicated by the design contained within the circle. In the case of the symbol at left, it means that the unit must never be disassembled.
	The  symbol alerts the user to things that must be carried out. The specific thing that must be done is indicated by the design contained within the circle. In the case of the symbol at left, it means that the power-cord plug must be unplugged from the outlet.



ALWAYS OBSERVE THE FOLLOWING

WARNING

- Before using this unit, make sure to read the instructions below, and the Owner's Manual. 

- Do not open or perform any internal modifications on the unit or its AC adaptor. (The only exception would be where this manual provides specific instructions which should be followed in order to put in place user-installable options; see p. 7, p. 8.) 



- Do not attempt to repair the unit, or replace parts within it (except when this manual provides specific instructions directing you to do so). Refer all servicing to your retailer, the nearest Roland Service Center, or an authorized Roland distributor, as listed on the "Information" page. 

- Never use or store the unit in places that are:
 - Subject to temperature extremes (e.g., direct sunlight in an enclosed vehicle, near a heating duct, on top of heat-generating equipment); or are 
 - Damp (e.g., baths, washrooms, on wet floors); or are 
 - Humid; or are
 - Exposed to rain; or are
 - Dusty; or are
 - Subject to high levels of vibration.

WARNING

- This unit should be used only with a rack or stand that is recommended by Roland. 



- When using the unit with a rack or stand recommended by Roland, the rack or stand must be carefully placed so it is level and sure to remain stable. If not using a rack or stand, you still need to make sure that any location you choose for placing the unit provides a level surface that will properly support the unit, and keep it from wobbling. 

- Do not allow any objects (e.g., flammable material, coins, pins); or liquids of any kind (water, soft drinks, etc.) to penetrate the unit. 







- In households with small children, an adult should provide supervision until the child is capable of following all the rules essential for the safe operation of the unit. 

- To prevent accidents, never allow small children to play near the drum kit. 







WARNING

- Do not drop the unit! 
- To avoid personal injury and/or damage to the unit, do not touch anything inside the frame of the PD-80 and PD-80R. 

CAUTION

- Try to prevent cords and cables from becoming entangled. Also, all cords and cables should be placed so they are out of the reach of children. 
- Never climb on top of, nor place heavy objects on the unit. 
- Should you remove screws, nuts, bolts, springs, washers, etc., make sure to put them in a safe place out of children's reach, so there is no chance of them being swallowed accidentally. 
- Assemble the drum stand and TD-8KV carefully, to avoid pinching your fingers. 
- Make sure to firmly tighten all clamps and bolts after you have assembled the stand and attached a pad or unit to it. You should probably also try to make a habit of checking and retightening them if necessary before every performance. You risk injury if you have loose screws or clamps, since a pad or unit can fall unexpectedly. 
- Be sure to tighten the head tension before using the KD-80, PD-80R, and PD-80. Striking the head when the head tension is loose may damage the sensor and head. 

CAUTION

- Do not apply excessive force to the sensor (and on the KD-80, the cushion) located below the center of the head of the KD-80, PD-80R, and PD-80. Doing so can interfere with accurate detection, and may damage it. 
- Due to the nature of the materials used in the sensor of the KD-80, PD-80R, and PD-80, changes in room temperature may affect the sensitivity of the sensor. 
- Please be aware that by using a felt beater for the KD-80, you risk causing damage to the head as a result of the metal portions of the beater that can become exposed when the felt wears thin. For the kick pedal, we recommend that you use only the supplied beater, or a commercially available plastic beater. 
- To keep the KD-80 and FD-6 from slipping or moving during play, the tips of the legs installed on the stand and the tips of the anchor bolts are pointed. Handle with care to avoid injury. 
- Brushes can be used to play the PD-80R and PD-80. When using brushes, be sure to use nylon brushes. Using metal brushes will not only scratch the head, but can also be hazardous, since the tip of the brush may catch in the mesh of the net. 
- The rubber portion of the PD-80R's hoop is one component that eventually wears out (the more so if numerous rim shots are performed), and will require replacement. Errors may occur when attempting rim shots once the rubber portion has worn out. If this occurs, replace the hoop rubber. For more on replacing the hoop rubber, consult with your retailer, the nearest Roland Service Center, or an authorized Roland distributor, as listed on the "Information" page. 

IMPORTANT NOTES

In addition to the items listed under “USING THE UNIT SAFELY” on page 2–3, please read and observe the following:

Placement

- Do not expose the unit to direct sunlight, place it near devices that radiate heat, leave it inside an enclosed vehicle, or otherwise subject it to temperature extremes. Excessive heat can deform or discolor the unit.
- To avoid possible breakdown, do not use the unit in a wet area, such as an area exposed to rain or other moisture.
- Do not allow rubber, vinyl, or similar materials to remain on the unit for long periods of time. Such objects can discolor or otherwise harmfully affect the finish.
- Do not put anything that contains water (e.g., flower vases) on the unit. Also, avoid the use of insecticides, perfumes, alcohol, nail polish, spray cans, etc., near the unit. Swiftly wipe away any liquid that spills on the unit using a dry, soft cloth.

Maintenance

- For everyday cleaning wipe the unit with a soft, dry cloth or one that has been slightly dampened with water. To remove stubborn dirt, use a cloth impregnated with a mild, non-abrasive detergent. Afterwards, be sure to wipe the unit thoroughly with a soft, dry cloth.
- Never use benzine, thinners, alcohol or solvents of any kind, to avoid the possibility of discoloration and/or deformation.

Additional Precautions

- Use a reasonable amount of care when using the unit’s buttons, sliders, or other controls; and when using its jacks and connectors. Rough handling can lead to malfunctions.
- When connecting / disconnecting all cables, grasp the connector itself—never pull on the cable. This way you will avoid causing shorts, or damage to the cable’s internal elements.
- To avoid disturbing your neighbors, try to keep the unit’s volume at reasonable levels. You may prefer to use headphones, so you do not need to be concerned about those around you (especially when it is late at night).
- This instrument is designed to minimize the extraneous sounds produced when it’s played. However, since sound vibrations can be transmitted through floors and walls to a greater degree than expected, take care not to allow these sounds to become a nuisance to neighbors, especially when performing at night and when using headphones.
- Use a provided cable or a cable from Roland to make the connection. If using some other make of connection cable, please note the following precautions.
 - Some connection cables contain resistors. Do not use cables that incorporate resistors for connecting to this unit. The use of such cables can cause the sound level to be extremely low, or impossible to hear. For information on cable specifications, contact the manufacturer of the cable.

Getting Started

Check the Contents of the Box

- TD-8 (Percussion Sound Module) x 1
- KD-80 (V-Kick Trigger) x 1
- FD-6 (Hi-Hat Control Pedal) x 1
- PD-80R (V-Pad) x 1
- PD-80 (V-Pad) x 3
- CY-12R/C (V-Cymbal) X 2
- PD-7 (Pad) x 1
- Accessory Set x 1
 - Tuning Key (for KD-80, PD-80R, PD-80, CY-12R/C, and FD-6) x 1
 - Beater (for KD-80) x 1
 - Anchor Bolt (for FD-6) x 2
 - Spring for Anchor Bolt (for FD-6) x 2
 - Wing Nut (for CY-12R/C) x 2
 - Felt Washer (for CY-12R/C) x 2
 - Stopper (for CY-12R/C) x 2
 - Cable Tie (for CY-12R/C) x 2
- Connection Cable Set x 1
 - Connection Cable (1 meter) x 2 (for Hi-Hat: PD-7/Snare: PD-80R)
 - Connection Cable (2 meters) x 5 (for Kick: KD-80/Tom1, 2: PD-80 x 2/Hi-Hat Control Pedal: FD-6/Crash: CY-12R/C)
 - Connection Cable (3.5 meters) x 2 (for Tom3: PD-80/Ride: CY-12R/C)
- TD-8KV Owner's Manual (this manual) x 1

MEMO

- This package does not include a drum stand. Please use the separately available drum stand (MDS series).
- This package does not include a kick pedal. Use with a commercially available kick pedal.

- The TD-8 Owner's Manual is included in the TD-8 package.

NOTE

In the interest of product improvement, the specifications and/or appearance of this unit are subject to change without prior notice.

Setup Procedure

1. Assemble the drum stand.



For more information on assembling the stand, refer to the owner's manual for the stand.

2. Adjust the head tension of the KD-80, PD-80R, and PD-80 (p. 6).
3. Set up the pads, cymbals and pedals.
 - KD-80 (Kick) → p. 8
 - PD-80R (Snare)/PD-80 (Tom-Tom) → p. 10
 - CY-12R/C (Ride, Crash) → p. 10
 - PD-7 (Hi-Hat) → p. 12
 - FD-6 (Hi-Hat Control Pedal) → p. 13
 - TD-8 (Percussion Sound Module) → p. 13
4. Connect all pads and the like to the TD-8 (p. 14).

About the Mesh Head

Adjusting the Head Tension

The KD-80, PD-80R, and PD-80 are shipped from the factory with the head tension loosened. Be sure to adjust the tension before use.

In general, a tension that produces a strike response approximately the same as an acoustic drum will be appropriate.

NOTE

- Striking the head when the head tension is loose may damage the sensor and head.
- Should you neglect to make the appropriate settings, you could likely experience the following problems:
Sometimes it does not sound (uneven volume).
The volume is too low (reduced sensitivity).

NOTE

- On the KD-80, PD-80R, and PD-80, adjusting the head tension affects only the head response, and does not change the pitch of the sound, as it would on an acoustic drum.
- The head tension will change as the instrument is used, so you should readjust when necessary.
- The head stretches when used for extended periods, so even when properly adjusted to 7.5 mm (KD-80), or 7 mm (PD-80R and PD-80) by means of the following procedure, you may not achieve the same degree of tension as when the head was initially adjusted. Strike the head to check the feel and response as you adjust the tension.
- Tighten each tuning bolt one by one, observing the numerical order shown in the diagram. Do not firmly tighten a single tuning bolt by itself. Doing so will make it impossible to tension the head evenly, and will cause malfunctions.

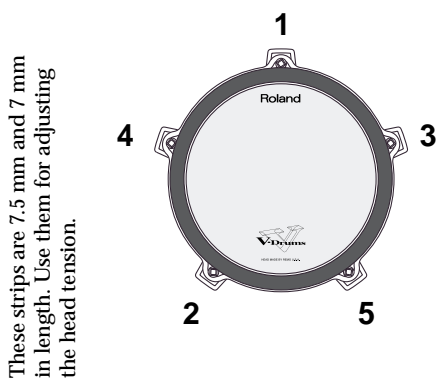

1. Use the included tuning key to tighten the tuning bolts.

Tighten the bolts until you achieve the correct amount of space between the frame and the hoop, which is:

KD-80: approximately 7.5 mm

PD-80R/PD-80: approximately 7 mm

KD-80

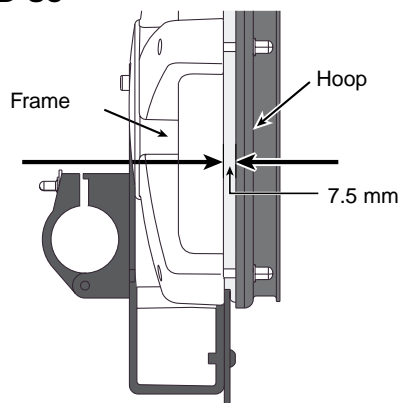

PD-80R/PD-80

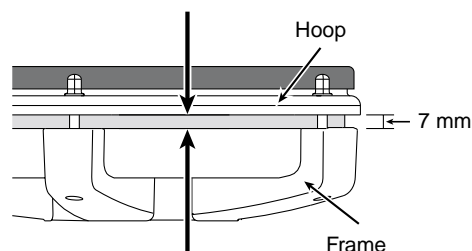

HINT

Black strips, one 7.5 mm in length and the other 7 mm, are printed at the edge of this page. Use these for reference when making the adjustment.

2. Fine-tune the adjustment while continuing to check the pad feel and response.

Replacing the Head

When the Head Should Be Replaced

The head is an expendable item that eventually will wear out and need to be replaced. Replace the head when the following occurs:

- The head surface is torn
- Striking points are no longer detected correctly, even when the head tension is properly adjusted.
- Slack portions remain in the head even after the head tension is properly adjusted.

Replacement heads (optional)

MH-8 Mesh Head: for either KD-80, PD-80R or PD-80

Replacing the Head

1. Remove all tuning bolts and washers.



When replacing the head of the KD-80 or the PD-80R, press the lock bushing (in figure below) in place with your finger as you remove each tuning bolt, to prevent the bushings from being pulled off the frame. Only the KD-80 and the PD-80R are provided with lock bushings.

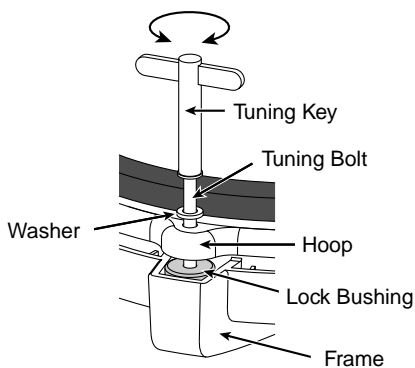

For more on the lock bushings, refer to the following section, "About the Lock Bushings."

2. Remove the hoop.
3. Remove the old head.
4. Place the new head on the frame.
5. Place the hoop onto the head.

6. Pass the tuning bolts through the washers, then attach them to the hoop and frame.
7. Next, adjust the tension of the head. Refer to "Adjusting the Head Tension" (p. 6).



Do not firmly tighten a single tuning bolt by itself. Doing so will make it impossible to tension the head evenly, and will cause malfunctions such as failure to accurately detect the striking location.

About the Lock Bushings

The KD-80 and the PD-80R are provided with lock bushings to prevent rotation and loosening of the tuning bolts caused by vibration transmitted from the hoop.

If a lock bushing happens to become separated from the frame while the head is being replaced, position the bushing so its four slots are aligned with the corresponding ridges in the frame, then press down firmly on the bushing.

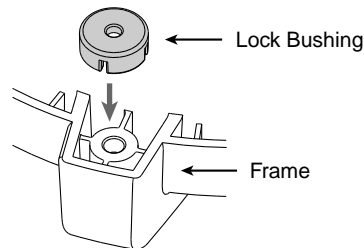

Setting Pads and Pedals

KD-80 (V-Kick Trigger)

NOTE

Before using the KD-80, you need to adjust the head tension (p. 6).

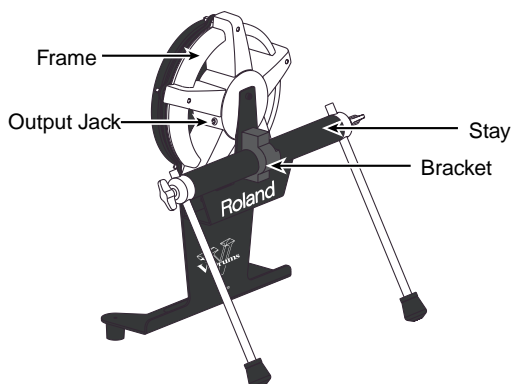
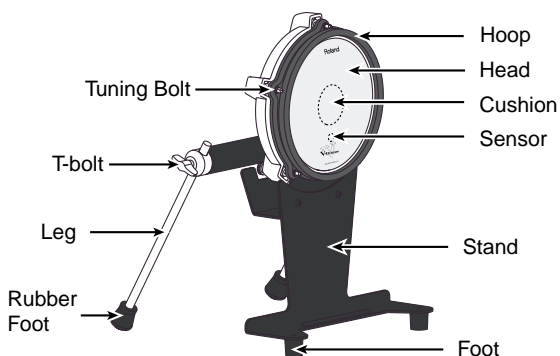

Assembling the KD-80

NOTE

- Take care not to pinch your fingers between the KD-80 pad and the stand plate.
- Please be aware that by using a felt beater, you risk causing damage to the head as a result of the metal portions of the beater that can become exposed when the felt wears thin. For the kick pedal, we recommend that you use only the supplied beater, or a commercially available plastic beater.

1. Place the KD-80 pad, with the head surface facing downward, on a flat surface such as the floor.
2. Use the included tuning key to loosen the bolts for the bracket on the back of the KD-80 pad, then open the bracket.

3. Mount the stay on the pad.

Align the mark on the stay with the protrusion of the bracket, and use the tuning key to firmly tighten the bolts that you loosened in step 2.

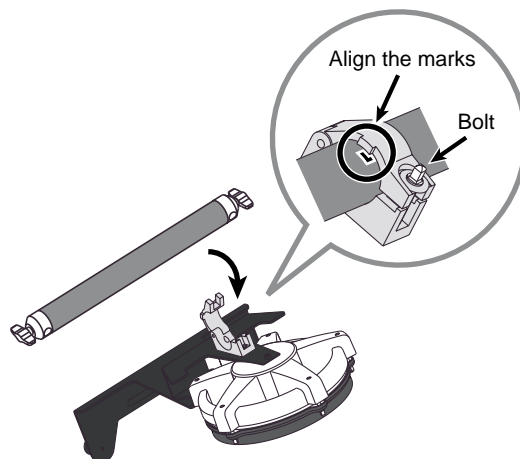

4. Loosen the leg nut.

5. Rotate the rubber foot to adjust the leg tip.

Adjust to use the spike legs when installing on carpeting or other soft surfaces, or the rubber legs when installing on flooring or other hard surfaces. When shipped from the factory, the stand is adjusted for using the rubber legs.

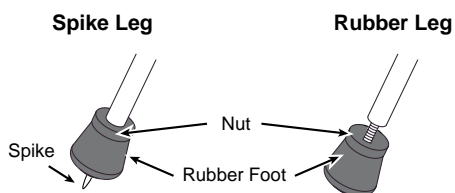

NOTE

- The tip of the spike is sharp. Handle it with care.
- When using on flooring, the spike legs may damage the floor. Adjust to use the rubber legs.

6. Tighten the nut and rubber foot to secure the rubber foot in place and keep it from loosening. The nut and rubber foot must be tightened to prevent the malfunctions.

7. Loosen the T-bolts for the stay and mount the legs on the stay.

Install the legs as shown in the figure so that the ends of the legs protrude by about 1 inch (2 cm).

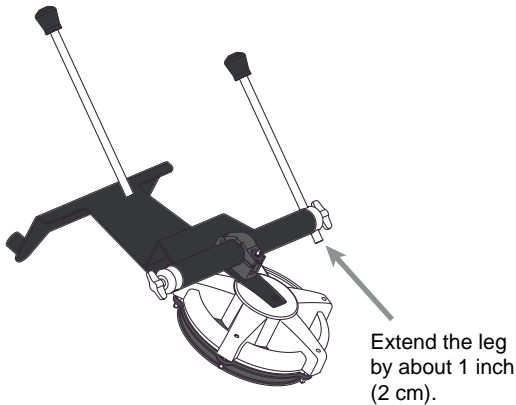

8. Tighten the T-bolts to secure the legs to the stand.
9. Lift the KD-80 and place the stand and the four legs upright.
10. Adjust the angle of the stand plate so that it's at a right angle to the floor.
Loosen the T bolts that you tightened in step 8, and adjust the length of the legs so that the stand plate is vertical to the floor. Then firmly tighten the T bolts.
11. Install the included beater on your kick pedal.
12. Mount the kick pedal on the KD-80.

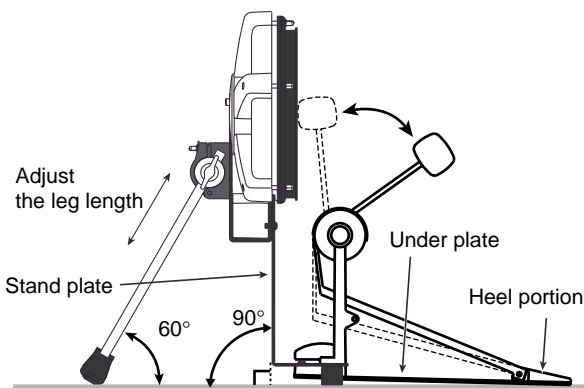

NOTE

- Install the kick pedal securely.
- Set the KD-80 so no mechanical noise is heard when you step on pedal.
- Make sure that KD-80 does not touch the drum stand or the other pads.

MEMO

If you are using a kick pedal with an under plate
Adjust the length of the legs so that the four legs of the KD-80 and the heel of the kick pedal contact the floor evenly.

13. Adjust the striking point for the beater.
The beater's striking point is adjusted to fall at the center of the head.
Adjust the striking point so that it doesn't extend beyond the cushion on the back of the head.

When Using a Twin (Double Kick) Pedal

With the KD-80, you can also play using a twin (double kick) pedal.
Set this up so the striking points of the two beaters fall at equal distances to the left and right of the center of the head.

NOTE

When using a twin (double kick) pedal, as with a regular pedal, use the included beater or a plastic beater as the beater for the kick pedal.

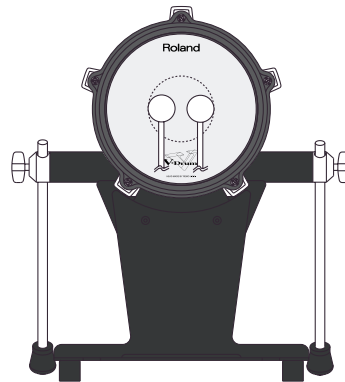

Specifications

KD-80: V-Kick Trigger

Pad Size: 8 inches

Trigger: 1

Dimensions: 440 (W) x 340 (D) x 465 (H) mm

17-3/8 (W) x 13-7/16 (D) x 18-5/16 (H) inches

Weight: 4.8 kg

10 lbs 10 oz

PD-80R/PD-80 (V-Pad)

NOTE

Before using the PD-80R and the PD-80, you need to adjust the head tension (p. 6).

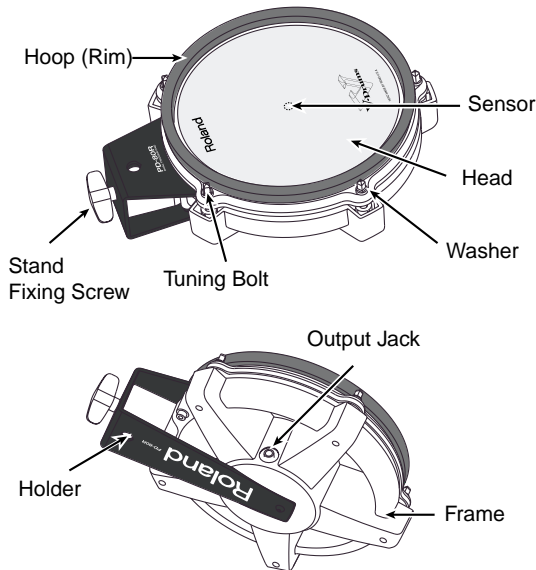

Attaching the Pad to a Stand

Attach the PD-80R or PD-80 to a stand (MDS series).

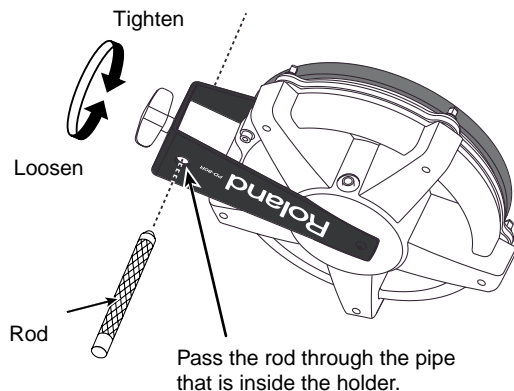

NOTE

When attaching the PD-80R and the PD-80 to the pad mount, be sure to tighten the stand fixing screw securely. If any of them remain loose, the pad could fall off.

Adjustment for Positional Sensing with the TD-8

When the TD-8 is used as the sound module, the location at which the pad is struck can be varied to produce tonal changes. In this case, it is important to adjust the head so the tension is evenly distributed, so the striking location can be detected accurately. For details on adjustments, refer to the TD-8 owner's manual.

MEMO

The positional sensing function works only with TD-8's trigger input 3 (SNARE).

Specifications

PD-80R: V-Pad

Pad Size: 8 inches

Trigger: 2 (Head, Rim)

Dimensions: 245 (W) x 310 (D) x 95 (H) mm

9-11/16 (W) x 12-1/4 (D) x 3-3/4 (H) inches

Weight: 1.7 kg

3 lbs 11 oz

PD-80: V-Pad

Pad Size: 8 inches

Trigger: 1 (Head)

Dimensions: 245 (W) x 310 (D) x 95 (H) mm

9-11/16 (W) x 12-1/4 (D) x 3-3/4 (H) inches

Weight: 1.6 kg

3 lbs 8 oz

CY-12R/C (V-Cymbal)

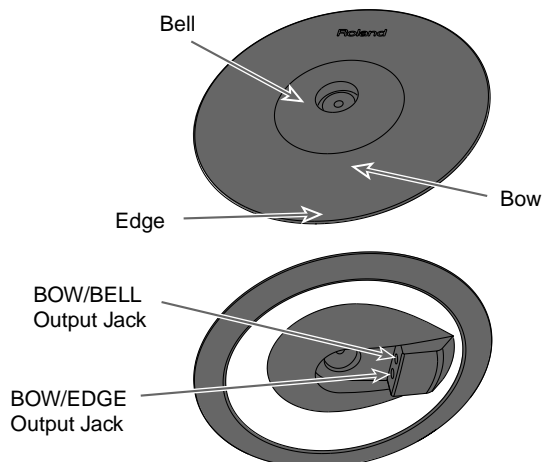

Attaching the V-Cymbal to the Cymbal Mount

Attach the CY-12R/C to the cymbal mount of a drum stand (MDS series).

1. Use the included tuning key to tighten the stopper bolt. The stopper keeps the CY-12R/C from turning, and

prevents the cables from catching or getting tangled on the stand.

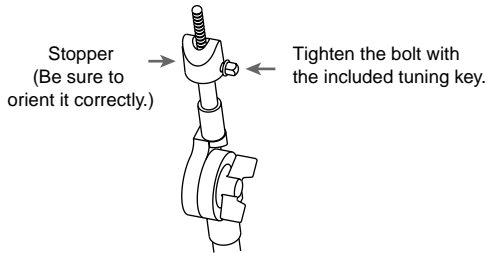

- Attach the CY-12R/C so the unit is oriented as shown in the diagram (bolt should be opposite the output jacks).
- Tighten the wing nut to obtain the desired movement.
Use the included felt washer and the wing nut.

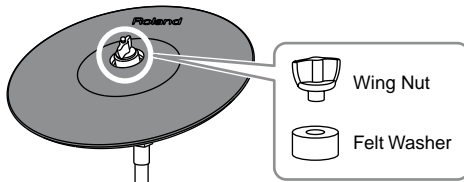

NOTE

- Double sounding may occur if the wing nut is loose.
- Do not use the washer or felt included with the drum stand (MDS series).

About the Output Jacks

The CY-12R/C features two different output jacks, BOW/BELL and BOW/EDGE.

Use the BOW/BELL output jack when you want to play the bow and the bell sounds (used as a ride cymbal); use the BOW/EDGE output jack when you want to play the bow and the edge sounds (used as a crash cymbal).

NOTE

Use either the BOW/BELL or BOW/EGDE output jack, but not both at the same time. Connecting both jacks results in two separate trigger inputs playing simultaneously.

Output Jack	Corresponding Play Methods	Tones Sounded
BOW/BELL	Bow Shot (p. 11)	Head
	Bell Shot (p. 11)	Rim
	Choke (p. 12)	-
BOW/EDGE	Bow Shot (p. 11)	Head
	Edge Shot (p. 11)	Rim
	Choke (p. 12)	-

Playing the CY-12R/C

Bow Shot

This is the most common playing method, playing the pad face of the cymbal. It corresponds to the sound of the “head-side” of the connected trigger input.

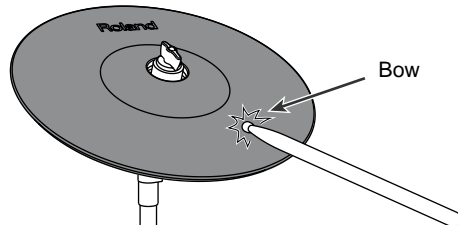

Edge Shot

This playing method involves striking the edge with the shoulder of the stick. It corresponds to the sound of the “rim-side” of the connected trigger input.

NOTE

To make use of edge shot, you'll need to connect to a trigger input jack on the percussion sound module that accommodates rim shots.

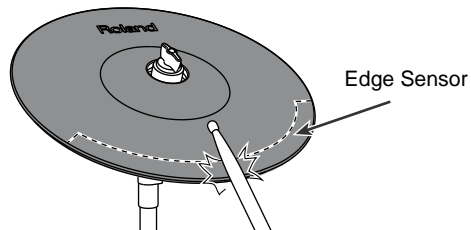

Bell Shot

This playing method involves striking the bell. It corresponds to the sound of the “rim-side” of the connected trigger input.

NOTE

- To make use of bell shot, you'll need to connect to a trigger input jack on the percussion sound module that accommodates rim shots.
- Use the shoulder of the stick when playing bell shots.

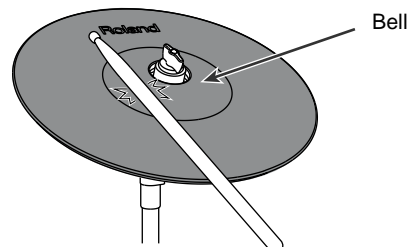

Choking

Choking (pinching) the cymbal's edge with the hand immediately after hitting the cymbal makes the sound stop.

NOTE

To make use of choking play techniques, you'll need to connect to a trigger input jack on the percussion sound module that accommodates rim shots.

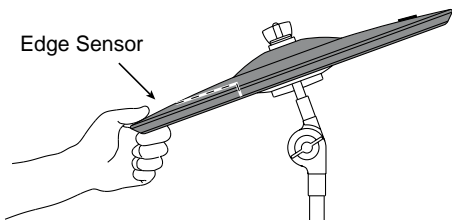

Troubleshooting

The sound does not change when an edge shot is made

- **Is the cable connected to the BOW/EDGE output?**
Make the connection to the BOW/EDGE output to enable the CY-12R/C to support edge shots (p. 11).
- **Are you striking the cymbal in the area with the edge sensors?**
Edge sensors are embedded only in the part of the CY-12R/C directly in front (p. 11).

The sound does not change when a bell shot is made

- **Is the cable connected to the BOW/BELL output?**
Make the connection to the BOW/BELL output to enable the CY-12R/C to support bell shots (p. 11).
- **Use the shoulder of the stick when playing bell shots (p. 11).**
- **Adjust the "Scan Time."**

Choke play is not possible

- **Are you choking the cymbal in the area with the edge sensors?**
Edge sensors are embedded only in the part of the CY-12R/C directly in front (p. 12).

Ride cymbal sounds odd (Other cymbal sound is heard simultaneously)

- Connect either the CY-12R/C's Bow/Bell output or the Bow/Edge output to the TD-8 (p. 11).

Double sounding

- **Are any cables touching the CY-12R/C?**
Secure the cables in place with the cable ties so that they do not touch the units. Also, be careful to make sure that the cables are not pulled by the movement of a cymbal when struck (p. 15).
- **Are the stopper, felt washer, and wing nut attached correctly?**
Double triggering may occur if the stopper and/or wing nut is loose. Use a tuning key (drum key) to tighten

properly (p. 10).

- * *If double triggering still occurs, try adjusting trigger parameters, such as Retrigger Cancel, on your TD-8.*

Specifications

CY-12R/C: V-Cymbal Ride/Crash

Pad Size: 12 inches

Trigger: 3 (Bow, Bell, Edge)

Dimensions: 300 (W) x 300 (D) x 51 (H)

11-13/16 (W) x 11-13/16 (W) x 2-1/16 (H)

Weight: 1.1 kg

2 lbs 7 oz

PD-7 (Pad)

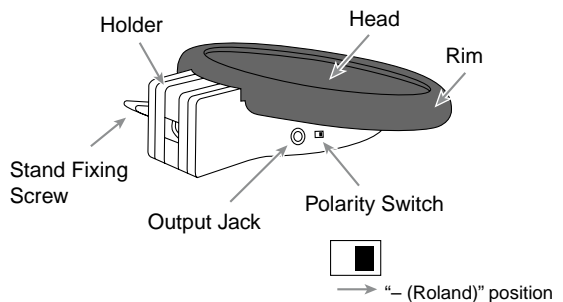

Attaching the Pad to a Stand

Attach the PD-7 to a stand (MDS series).

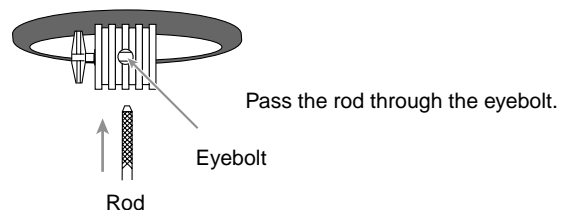

NOTE

When attaching the PD-7 to the pad mount, be sure to tighten the stand fixing screw securely. If any of them remain loose, the pad could fall off.

Specifications

PD-7: Pad

Pad Size: 7.5 inches

Trigger: 2 (Head, Rim)

Dimensions: 192 (W) x 230 (D) x 65 (H)

7-9/16 (W) x 9-1/16 (W) x 2-9/16 (H)

Weight: 0.8 kg

1 lb 13 oz

FD-6 (Hi-Hat Control Pedal)

Adjusting the Travel of the Pedal

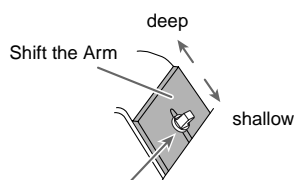

Loosen the bolt with the included tuning key. After adjusting, tighten the bolt.

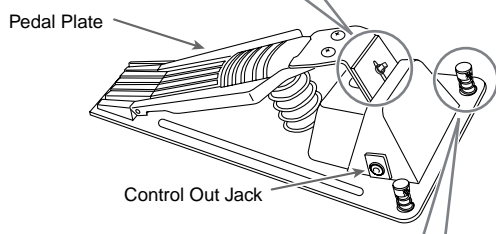

Attaching the Anchor Bolts (When Using on the Carpet)

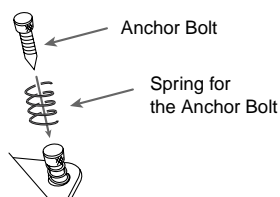

NOTE

- The tips of the anchor bolts are sharp. Handle with care.
- When using on flooring, the anchor bolts may damage the floor. Do not attach the anchor bolts.
- When the FD-6 is not going to be used for a long period of time, move and fix the arm, allowing longer travel for the pedal.
- To avoid damage, do not leave the FD-6 for extended periods of time with the pedal plate depressed.

MEMO

The TD-8 owner's manual assumes use of the FD-7 Hi-Hat Control Pedal. For each instance in which you find "FD-7" mentioned in the TD-8 owner's manual, please substitute the name "FD-6."

Specifications

FD-6: Hi-Hat Control Pedal

Dimensions: 160 (W) x 395 (D) x 120 (H) mm
6-5/16 (W) x 15-9/16 (D) x 4-3/4 (H) inches

Weight: 1.4 kg
3 lbs 2 oz (including anchor bolts)

TD-8 (Percussion Sound Module)

Attach the stand holder (included with the drum stand) to the TD-8.

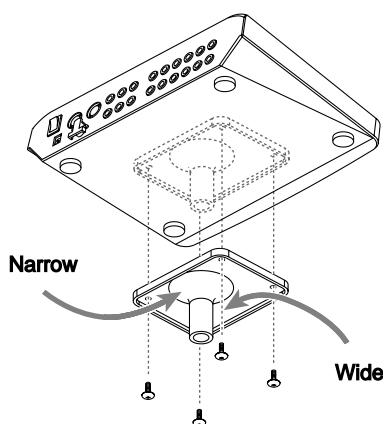

NOTE

- To attach the stand holder, remove the four 12 mm screws (M5 x 12) from the bottom of the TD-8 and use them. Use of other screws may result in damage to the unit.
- When turning the unit upside-down, get a bunch of newspapers or magazines, and place them under the four corners or at both ends to prevent damage to the buttons and controls. Also, you should try to orient the unit so no buttons or controls get damaged.
- When turning the unit upside-down, handle with care to avoid dropping it, or allowing it to fall or tip over.

Connect the pads and pedals to the TD-8

NOTE

To prevent malfunction and/or damage to speakers or other devices, always turn down the volume, and turn off the power on all devices before making any connections.

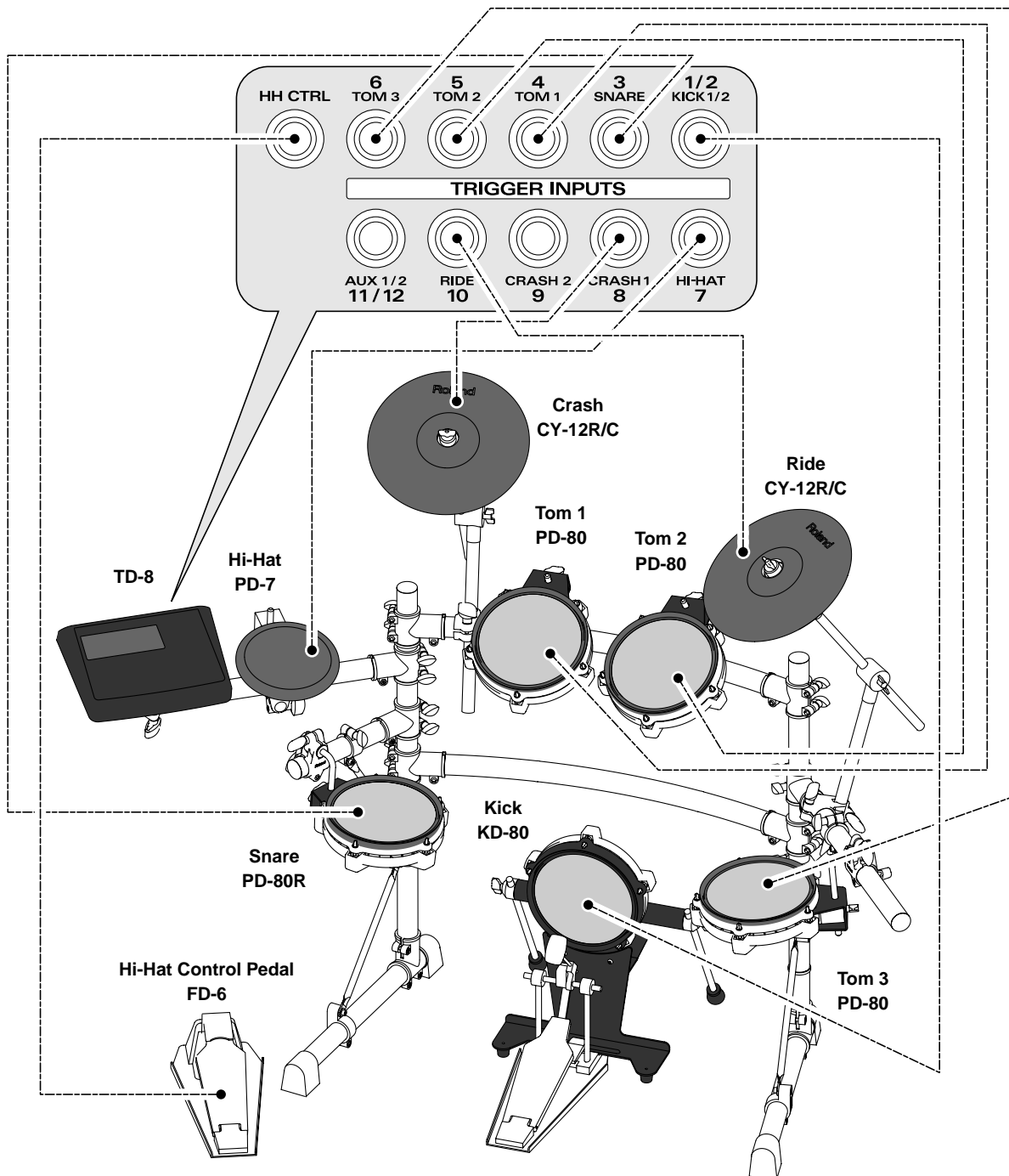

About the Included Cables

Using the provided cables, connect the pads and pedals to the TD-8.

- Carefully refer to the numbers shown in the illustration and connect to the appropriate TRIGGER INPUT jacks on the TD-8's rear panel.
- Connect the L-shaped plug of the included cable to the pad. This will prevent strain from being applied to the pad.

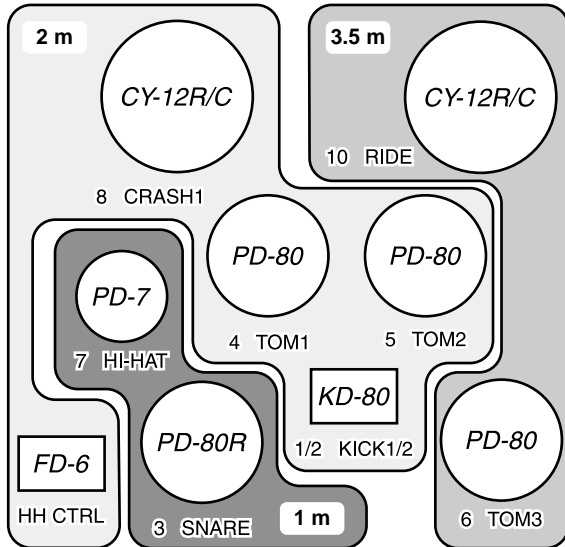

Connecting the CY-12R/C

1. Use the included cable to connect one of the CY-12R/C's output jacks (either one, but not both) to the TD-8's trigger input jack.
If the CY-12R/C is to be used as a crash cymbal, connect it to the BOW/EDGE output jack; if it is to be used as a ride cymbal, connect it to the BOW/BELL output jack.
2. Secure the cable with cable ties.
 Secure the cables in place with the cable tie, while leaving some slack in the cables to ensure that they are not pulled by the movement of the cymbal units when struck.

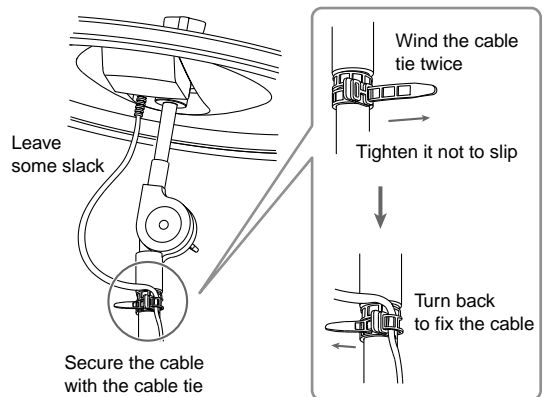

NOTE

Take care to ensure that the cables do not touch the cymbal units and/or the stand. A cable touching a cymbal unit or a stand may cause double sounding or other incorrect operation.

When you have finished making the connections, proceed with the TD-8's settings.

MEMO

Settings optimized for the TD-8KV are provided in factory settings on the TD-8 (Trigger Bank 1).

1. Press [SETUP] → [F1 (TRIG)].
2. Check to see if you have things set as shown in the screen below.



3. If your settings are different, make the trigger settings as described in the owner's manual provided with the TD-8.

Free Manuals Download Website

<http://myh66.com>

<http://usermanuals.us>

<http://www.somanuals.com>

<http://www.4manuals.cc>

<http://www.manual-lib.com>

<http://www.404manual.com>

<http://www.luxmanual.com>

<http://aubethermostatmanual.com>

Golf course search by state

<http://golfingnear.com>

Email search by domain

<http://emailbydomain.com>

Auto manuals search

<http://auto.somanuals.com>

TV manuals search

<http://tv.somanuals.com>