

## AUDIO RECORDER **AR-200**

# Owner's Manual

Before using this unit, carefully read the sections entitled: "USING THE UNIT SAFELY" and "IMPORTANT NOTES" ( p. 2, p. 3). These sections provide important information concerning the proper operation of the unit. Additionally, in order to feel assured that you have gained a good grasp of every feature provided by your new unit, Owner's manual should be read in its entirety. The manual should be saved and kept on hand as a convenient reference.

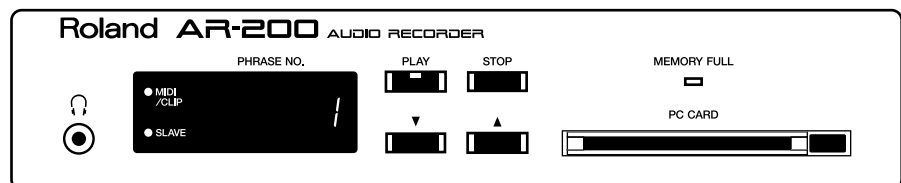

Copyright © 2000 ROLAND CORPORATION

All rights reserved. No part of this publication may be reproduced in any form without the written permission of ROLAND CORPORATION.

# USING THE UNIT SAFELY

## INSTRUCTIONS FOR THE PREVENTION OF FIRE, ELECTRIC SHOCK, OR INJURY TO PERSONS

### About ⚠ WARNING and ⚠ CAUTION Notices

<b>⚠ WARNING</b>	Used for instructions intended to alert the user to the risk of death or severe injury should the unit be used improperly.
<b>⚠ CAUTION</b>	Used for instructions intended to alert the user to the risk of injury or material damage should the unit be used improperly. * Material damage refers to damage or other adverse effects caused with respect to the home and all its furnishings, as well to domestic animals or pets.

### About the Symbols

	The ⚠ symbol alerts the user to important instructions or warnings. The specific meaning of the symbol is determined by the design contained within the triangle. In the case of the symbol at left, it is used for general cautions, warnings, or alerts to danger.
	The ⚡ symbol alerts the user to items that must never be carried out (are forbidden). The specific thing that must not be done is indicated by the design contained within the circle. In the case of the symbol at left, it means that the unit must never be disassembled.
	The ⚡ symbol alerts the user to things that must be carried out. The specific thing that must be done is indicated by the design contained within the circle. In the case of the symbol at left, it means that the power-cord plug must be unplugged from the outlet.

### ALWAYS OBSERVE THE FOLLOWING

#### ⚠ WARNING

- Before using this unit, make sure to read the instructions below, and the Owner's Manual.
- Do not open (or modify in any way) the unit or its AC adaptor.
- Do not attempt to repair the unit, or replace parts within it (except when this manual provides specific instructions directing you to do so). Refer all servicing to your retailer, the nearest Roland Service Center, or an authorized Roland distributor, as listed on the "Information" page.
- Never use or store the unit in places that are:
  - Subject to temperature extremes (e.g., direct sunlight in an enclosed vehicle, near a heating duct, on top of heat-generating equipment); or are
  - Damp (e.g., baths, washrooms, on wet floors); or are
  - Humid; or are
  - Exposed to rain; or are
  - Dusty; or are
  - Subject to high levels of vibration.
- This unit should be used only with a rack or stand that is recommended by Roland.

#### ⚠ WARNING

- When using the unit with a rack or stand recommended by Roland, the rack or stand must be carefully placed so it is level and sure to remain stable. If not using a rack or stand, you still need to make sure that any location you choose for placing the unit provides a level surface that will properly support the unit, and keep it from wobbling.
- Be sure to use only the AC adaptor supplied with the unit. Also, make sure the line voltage at the installation matches the input voltage specified on the AC adaptor's body. Other AC adaptors may use a different polarity, or be designed for a different voltage, so their use could result in damage, malfunction, or electric shock.
- Do not excessively twist or bend the power cord, nor place heavy objects on it. Doing so can damage the cord, producing severed elements and short circuits. Damaged cords are fire and shock hazards!
- This unit, either alone or in combination with an amplifier and headphones or speakers, may be capable of producing sound levels that could cause permanent hearing loss. Do not operate for a long period of time at a high volume level, or at a level that is uncomfortable. If you experience any hearing loss or ringing in the ears, you should immediately stop using the unit, and consult an audiologist.
- Do not allow any objects (e.g., flammable material, coins, pins); or liquids of any kind (water, soft drinks, etc.) to penetrate the unit.

**⚠ WARNING**

- Immediately turn the power off, remove the AC adaptor from the outlet, and request servicing by your retailer, the nearest Roland Service Center, or an authorized Roland distributor, as listed on the "Information" page when:
  - The AC adaptor or the power-supply cord has been damaged; or
  - Objects have fallen into, or liquid has been spilled onto the unit; or
  - The unit has been exposed to rain (or otherwise has become wet); or
  - The unit does not appear to operate normally or exhibits a marked change in performance.

---

- In households with small children, an adult should provide supervision until the child is capable of following all the rules essential for the safe operation of the unit.

---

- Protect the unit from strong impact. (Do not drop it!)

---

- Do not force the unit's power-supply cord to share an outlet with an unreasonable number of other devices. Be especially careful when using extension cords—the total power used by all devices you have connected to the extension cord's outlet must never exceed the power rating (watts/amperes) for the extension cord. Excessive loads can cause the insulation on the cord to heat up and eventually melt through.

---

- Before using the unit in a foreign country, consult with your retailer, the nearest Roland Service Center, or an authorized Roland distributor, as listed on the "Information" page.

**⚠ CAUTION**

- The unit and the AC adaptor should be located so their location or position does not interfere with their proper ventilation.

---

- Always grasp only the plug or the body of the AC adaptor when plugging into, or unplugging from, an outlet or this unit.

---

- Whenever the unit is to remain unused for an extended period of time, disconnect the AC adaptor.

---

- Try to prevent cords and cables from becoming entangled. Also, all cords and cables should be placed so they are out of the reach of children.

---

- Never climb on top of, nor place heavy objects on the unit.

---

- Never handle the AC adaptor body, or its plugs, with wet hands when plugging into, or unplugging from, an outlet or this unit.

---

- Before moving the unit, disconnect the AC adaptor and all cords coming from external devices.

---

- Before cleaning the unit, turn off the power and unplug the AC adaptor from the outlet (p. 10).

---

- Whenever you suspect the possibility of lightning in your area, disconnect the AC adaptor from the outlet.

# IMPORTANT NOTES

In addition to the items listed under “USING THE UNIT SAFELY” on page 2-3, please read and observe the following:

## Power Supply

- Do not use this unit on the same power circuit with any device that will generate line noise (such as an electric motor or variable lighting system).
- The AC adaptor will begin to generate heat after long hours of consecutive use. This is normal, and is not a cause for concern.
- Before connecting this unit to other devices, turn off the power to all units. This will help prevent malfunctions and/or damage to speakers or other devices.

## Placement

- This device may interfere with radio and television reception. Do not use this device in the vicinity of such receivers.
- To avoid possible breakdown, do not use the unit in a wet area, such as an area exposed to rain or other moisture.

## Maintenance

- For everyday cleaning wipe the unit with a soft, dry cloth or one that has been slightly dampened with water. To remove stubborn dirt, use a cloth impregnated with a mild, non-abrasive detergent. Afterwards, be sure to wipe the unit thoroughly with a soft, dry cloth.
- Never use benzine, thinners, alcohol or solvents of any kind, to avoid the possibility of discoloration and/or deformation.

## Additional Precautions

- Unfortunately, it may be impossible to restore the contents of data that was stored DATA card once it has been lost. Roland Corporation assumes no liability concerning such loss of data.
- Use a reasonable amount of care when using the unit's buttons, sliders, or other controls; and when using its jacks and connectors. Rough handling can lead to malfunctions.
- Never strike or apply strong pressure to the display.
- When connecting / disconnecting all cables, grasp the connector itself—never pull on the cable. This way you will avoid causing shorts, or damage to the cable's internal elements.
- To avoid disturbing your neighbors, try to keep the unit's volume at reasonable levels. You may prefer to use headphones, so you do not need to be concerned about those around you (especially when it is late at night).
- When you need to transport the unit, package it in the box (including padding) that it came in, if possible. Otherwise, you will need to use equivalent packaging materials.

- Use a cable from Roland to make the connection. If using some other make of connection cable, please note the following precautions.
  - Some connection cables contain resistors. Do not use cables that incorporate resistors for connecting to this unit. The use of such cables can cause the sound level to be extremely low, or impossible to hear. For information on cable specifications, contact the manufacturer of the cable.

## Before Using PC Cards

- Never attempt to remove a PC Card from the drive while the drive is operating (the indicator is lit); damage could result to both the card and the drive.
- Remove any disk from the drive before powering up or down.
- To avoid the risk of malfunction and/or damage, insert only PC Cards into the disk drive. Never insert any other type of disk. Avoid getting paper clips, coins, or any other foreign objects inside the drive.

## Before Using Cards

### Using DATA Cards

- Carefully insert the PC card all the way in—until it is firmly in place.

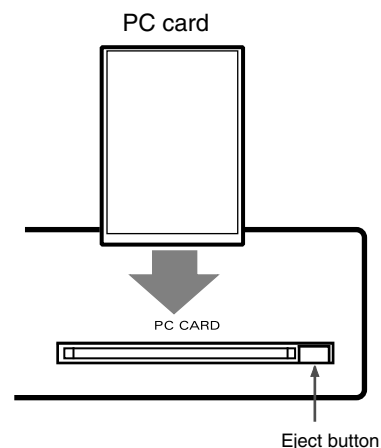

## Copyright

- Unauthorized recording, distribution, sale, lending, public performance, broadcasting, or the like, in whole or in part, of a work (musical composition, video, broadcast, public performance, or the like) whose copyright is held by a third party is prohibited by law.
- Do not use this unit for purposes that could infringe on a copyright held by a third party. Roland assumes no responsibility whatsoever with regard to any infringements of third-party copyrights arising through your use of this unit.

# Contents

<b>USING THE UNIT SAFELY .....</b>	<b>2</b>
<b>IMPORTANT NOTES .....</b>	<b>4</b>
<b>Main Features .....</b>	<b>7</b>
<b>Panel Descriptions .....</b>	<b>8</b>
<b>Important Notes on Making Connections and Switching the Power On and Off .....</b>	<b>9</b>
Turning On the Power .....	9
<b>Installation.....</b>	<b>10</b>
Attaching the Rubber Feet (Included Items).....	10
Rack Mounting (Important Notes on Heat Radiation).....	10
Attaching the Card Protector .....	11
<b>Examples of Usage and Connection for the AR-200.....</b>	<b>12</b>
Together with Other Equipment (System Examples).....	12
Using the Control Input and Output Connectors.....	12
Using the MIDI Connectors .....	13
What You Can Do (Usage Tips).....	14
Repeat Playback of the Same Phrase .....	14
Playing a Variety of Phrases in Succession.....	14
<b>Cards Handled by the AR-200 .....</b>	<b>15</b>
Types of Usable Cards.....	15
Card Storage Times and Number of Phrases.....	15
Formatting a Card.....	15
Important Notes on Handling Cards .....	16
Card Compatibility with Other Models in the AR Series .....	17
<b>Recording Audio.....</b>	<b>18</b>
Recording Units—Phrases.....	18
Connecting External Devices .....	18
Procedure for Recording .....	19
Required Settings for Recording Audio Signals (Recording Settings) .....	19
Procedure .....	22
Checking What You Recorded .....	23
Information Recorded on the Card .....	23
<b>Playback Using the Panel (Manual Playback).....</b>	<b>24</b>
<b>Deleting Phrases .....</b>	<b>25</b>
Deleting Single Phrases .....	25
Deleting All Phrases.....	25
<b>Recording and Playing MIDI Data (MIDI Phrase) .....</b>	<b>26</b>
What is a MIDI Phrase? .....	26
Connecting External Devices .....	26
Procedure for Recording MIDI Phrases .....	26
Procedure for Playing Back MIDI Phrases.....	27
<b>Controlling the AR-200 from an External Device (Control Input Connectors).....</b>	<b>28</b>
What Is No-voltage/Make-contact? .....	28
Types of Control Input Playback .....	28
Types of Control Input Recording .....	28
Playback By Card Data.....	28
Cards Created on the AR-3000, AR-2000, or AR-1 .....	28
Card made on the AR-100/200.....	28
AR-200 Settings.....	29
Playing Back Phrases Assigned to the Connectors (Direct Playback).....	30

Specifying Phrases in Binary Notation (Binary Playback) .....	31
To Specify Phrases with Binary Signals .....	32
Phrase Number / Binary Signal chart .....	33
Repeated Playback of Phrases (Interval Playback) .....	34
Controlling Recording with the Control Connectors (Terminal Rec) .....	34
What is Terminal Rec/Use and Applications .....	34
Connecting Equipment.....	35
Operational Specifications for Terminal Rec.....	35
AR-200 Settings.....	36
To Specify Phrases with Binary Signals .....	37
<b>Controlling Another Device with the AR-200 (Control Output Connectors) .....</b>	<b>38</b>
Starting Another Device (Busy Out).....	38
Controlling Another Device (Control Out) .....	39

## **Applications Guide (For Use in Conjunction with the AR-3000)**

---

<b>Controlling the AR-200 with MIDI Signals (MIDI control) .....</b>	<b>42</b>
What is MIDI Control?/What You Can Do Using MIDI Control .....	42
Playback of Phrases Using MIDI Signals.....	42
Connecting External Devices .....	42
Assignment of Phrases to Note Numbers (MIDI Note Map).....	43
AR-200 Settings.....	44
<b>Synchronized Recording and Playback with Multiple AR Units (AR-LINK) .....</b>	<b>45</b>
<b>Other Useful Functions During Phrase Playback.....</b>	<b>47</b>
Playing Data for Two Units on the Left and Right (Dual Mono Mode).....	47
Line Out (Thru) Setting During Phrase Playback.....	47
Adjusting the Sound Quality During Audio Phrase Playback (EQ=Equalizer).....	48

## **Appendices**

---

<b>Troubleshooting .....</b>	<b>50</b>
<b>Error messages .....</b>	<b>52</b>
<b>Regarding Cards.....</b>	<b>53</b>
Card Audio Recording Time Chart.....	53
Recorded Phrase Data .....	54
Settings When a Card Is Formatted.....	54
AR-3000 settings that can be used .....	55
<b>MODE SW Settings .....</b>	<b>56</b>
<b>Control I/O Connector specifications .....</b>	<b>57</b>
<b>MIDI Implementation .....</b>	<b>58</b>
<b>MIDI Implementation Chart .....</b>	<b>64</b>
<b>Specification .....</b>	<b>66</b>
Input/Output Standard.....	68
Dimensions.....	68
<b>Index .....</b>	<b>69</b>

# Main Features

## High-quality Recording and Playback

Thanks to Roland's innovative RDAC system, you can enjoy high-quality, recording and playback using less data. You can select recording settings that suit the situation and the capacity of the card (sampling frequency: 6 levels, recording mode: 4 levels). This ensures support for recording and playback in a variety of situations and uses.

What you record and the settings are all saved on the card, so you can change situations rapidly simply by changing cards. The AR-200 can record and play back up to a maximum of 250 phrases (using cards created on Roland's AR-3000 allows playback of up to 1000 phrases).

## Audio Recording System with No Moving Parts

An audio recording system that uses PC cards and has no moving parts is employed. The system has no rotating parts or drive mechanism, so it's practically maintenance free. It provides excellent sound quality and superior reliability.

## A Variety of Control Jacks for a Wide Range of Playback Methods

As connectors to use for control, the unit features a Control In jack, MIDI connectors, and AR-LINK connectors. This lets you select from a variety of playback methods and create systems matched to usage and situations.

## Compact Body for Easy Portability

The compact half-rack size body takes little space, and can be conveniently transported. If a separately sold RAD-50 rack mount adaptor is used, the AR-200 can be installed in an EIA rack.

## MIDI Connectors Allow for Play of Musical Instruments and Syncing with Video

Since the unit is equipped with MIDI connectors, you can record and play back MIDI signals. You can play an electronic musical instrument automatically, just like playing back an audio phrase.

Control of recording/playback using MIDI signals is also supported. This means you can use MTC and MMC signals to obtain recording/playback that is synchronized to video and other external devices.

## Multi-track Operation—AR-LINK Feature

The AR-LINK feature lets you link the unit to up to 31 other units to create a completely synchronized multi-track system. The AR-3000 is required as a master control device.

## Capable of DC-Powered Operation

Since external DC power supply is also supported, a wide variety of applications are possible.

# Panel Descriptions

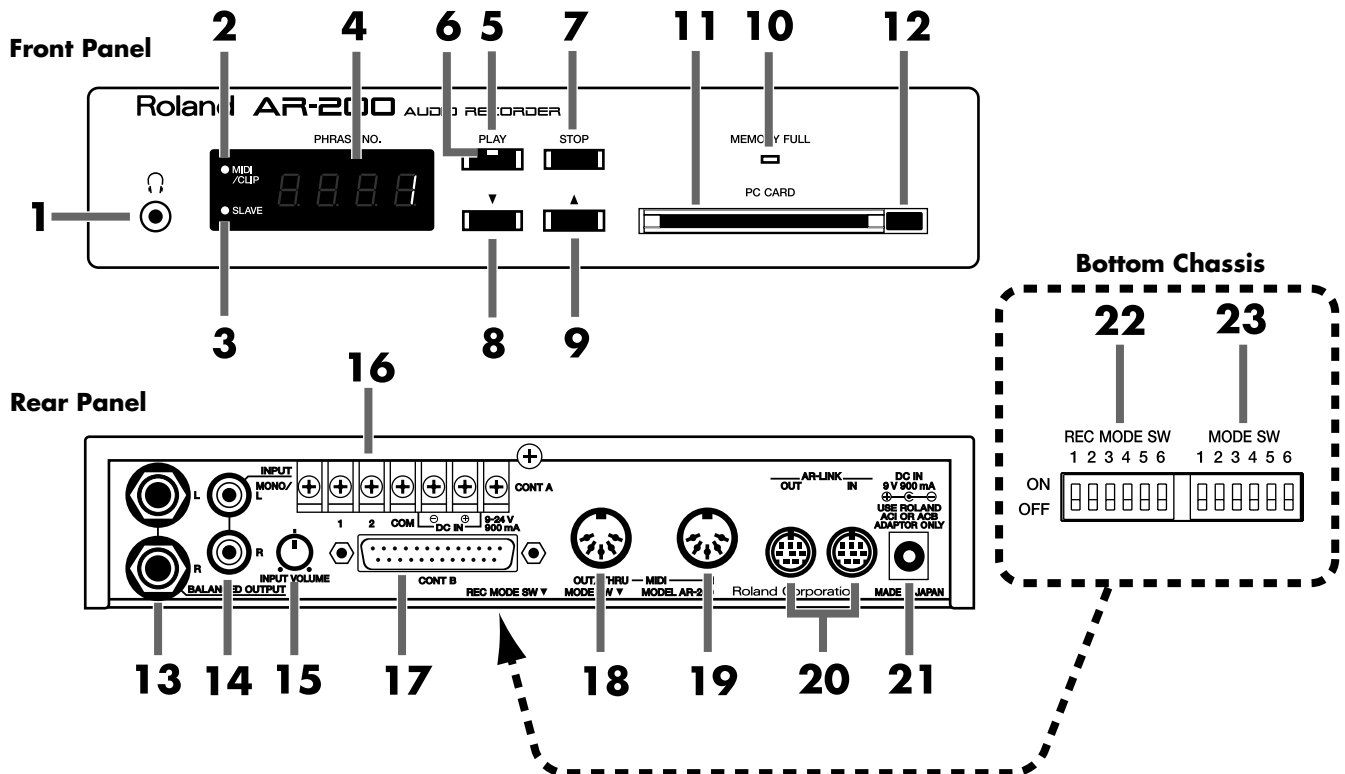

## Front panel

1. PHONES jack
2. MIDI/CLIP indicator
3. SLAVE Indicator
4. Display
5. PLAY button
6. PLAY indicator
7. STOP button
8. Decrement ( ▼ ) button
9. Increment ( ▲ ) button
10. MEMORY FULL indicator
11. CARD slot
12. Eject button

## Rear panel

13. OUTPUT jacks
14. INPUT jacks

## 15. INPUT VOLUME

## 16. Control input and DC input terminal (CONT A)

\* The terminal/connector section features a protective cover. Whenever you remove this cover, such as when making connections to the connectors, make sure not to lose it. Additionally, keep the cover out of the reach of children.

## 17. Control I/O connector (CONT B)

\* This is not an RS-232C type connector.

## 18. MIDI OUT/THRU connector

This is normally used as a MIDI OUT connector. However, by using a card with settings made on an AR-3000, this can also function as a MIDI THRU connector.

## 19. MIDI IN connector

## 20. AR-LINK Connectors (OUT and IN)

## 21. Power connector (for supplied AC adaptor)

## Bottom chassis

## 22. REC MODE switches

## 23. MODE switches



# Important Notes on Making Connections and Switching the Power On and Off

- To prevent malfunction and/or damage to speakers or other devices, always turn down the volume, and turn off the power on all devices before making any connections.
- Once the connections have been completed, turn on power to your various devices in the order specified. By turning on devices in the wrong order, you risk causing malfunction and/or damage to speakers and other devices.

(When turning the power off, reverse this procedure.)

Connected device → AR-200 → Power amp, etc.

- This unit is equipped with a protection circuit. A brief interval (a few seconds) after power up is required before the unit will operate normally.
- To avoid risk of electric shock, do not touch the connectors while the unit is in operation.
- Never remove a card during recording of phrases. Furthermore, do not turn off the power or remove the AC adaptor cord during recording of phrases. Doing so may damage the card.
- To avoid the risk of malfunction and/or damage, insert only PC Card into the disk drive. Never insert any other type of disk. Avoid getting paper clips, coins, or any other foreign objects inside the drive.
- The pin assignment for the connectors is as shown below. Before making any connections, make sure that this pin assignment is compatible with that of all your other devices.

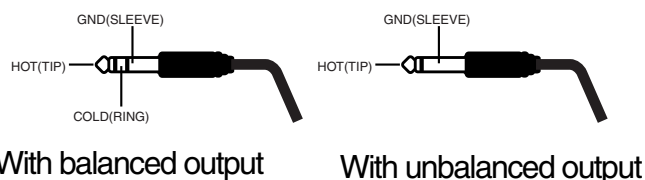

## Turning On the Power

The AR-200 is not equipped with a power switch. Power is turned on when electricity is supplied to the power connector (for the supplied AC adaptor), or to the control input and DC input, or control I/O connectors' DC IN (p. 8).

Supplied AC adaptor: ACI-100C (sold separately)

Control input and DC input/control I/O connector specifications

Voltage: 9 to 24 V DC

Current: 900 mA

\* Refer also to "DC power supply" (p. 57).

### NOTE

Do not supply electrical power simultaneously to multiple connectors or terminals; doing so may result in damage to the unit.

# Installation

## Attaching the Rubber Feet (Included Items)

Attach these as required, such as when you're using the AR-200 without mounting it on a rack or the like.

Peel off the double-sided tape from the rubber feet and affix the rubber feet at the locations shown in the following figure.

### Bottom Chassis

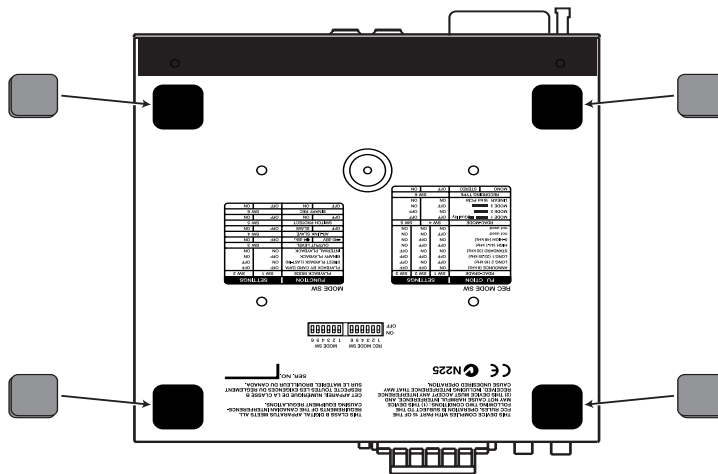

## Rack Mounting (Important Notes on Heat Radiation)

When you are mounting the unit on a rack or the like, give attention to the following points to ensure efficient cooling.

- Install in a well-ventilated location.
- Avoid mounting in a sealed rack. Warm air within the rack cannot escape and is sucked into the unit again, making efficient cooling impossible.
- When you are using a stacked mounting arrangement, be especially sure to provide for adequate ventilation within the rack to keep discharged air from being sucked back into the unit. If the back surface of the rack cannot be kept open, then provide a ventilation port or ventilation fan at the upper area of the back surface of the rack, where warm air accumulates.
- When you are using the unit in a portable case or rack, remove the covers from the front and back surfaces of the case, so that the front and back surfaces of the unit are not obstructed.
- If an error message informing you of a dangerous rise in temperature appears (p. 52), then heat-dissipating measures are needed. Refer to the cautions just described and check the installed state of the unit and the rack.

\* When placing the unit on the rack, be careful not to pinch your fingers.

\* For more information about installation, also see "**Placement**" in the Usage Notes (p. 4).

## Rack-Mounting the AR-200

By attaching a rack mount adaptor to the AR-200 (RAD-50: sold separately) you can install it in an EIA rack. One RAD-50 can accommodate up to two AR-200 units.

1

Remove the four rubber feet from bottom of the unit.

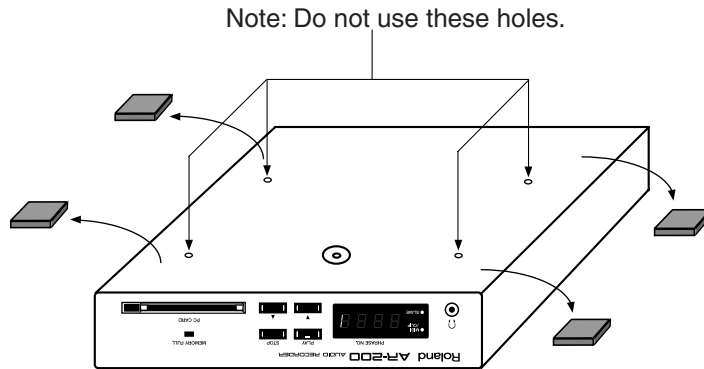

2

Attach the RAD-50 adaptor to the AR-200 using the screws that are supplied with the RAD-50.

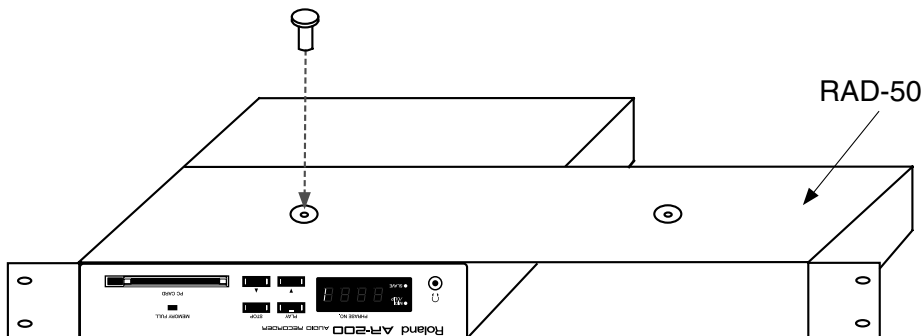

## Attaching the Card Protector

By attaching the Card Protector (supplied) to the AR-200, you can prevent the PC card from inadvertently being removed from the AR-200.

After confirming that the card is securely inserted in the card slot, use the provided screws to attach the Card Protector, as shown in the figure below.

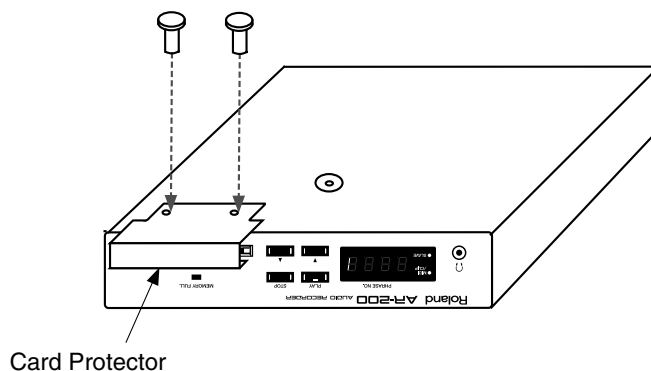

# Examples of Usage and Connection for the AR-200

You can use the AR-200 alone or in combination with other AR-200 units or other equipment to play audio in a wide variety of scenes. This section shows some examples of these. You can use these examples as a starting point for making changes to match your own usage circumstances.

## Together with Other Equipment (System Examples)

### Using the Control Input and Output Connectors

- Control Input: Messages, explanations, warnings, announcements, effect sounds, and the like are played with high sound quality according to control signals from sensors, buttons, and switches.



"Controlling the AR-200 from an External Device (Control Input Connectors)" (p. 28)

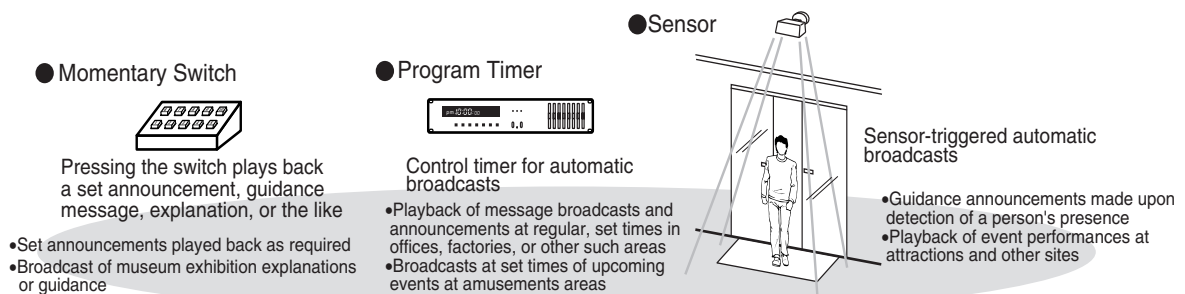

Types of External Control



- Control Output: Control signals can be output during or after phrase playback to control an external device.



"Controlling Another Device with the AR-200 (Control Output Connectors)" (p. 38)

#### ● Busy Out

Only during phrase playback, power amp or other gear is powered up (offset time set to five seconds)

Lamp lights during phrase playback

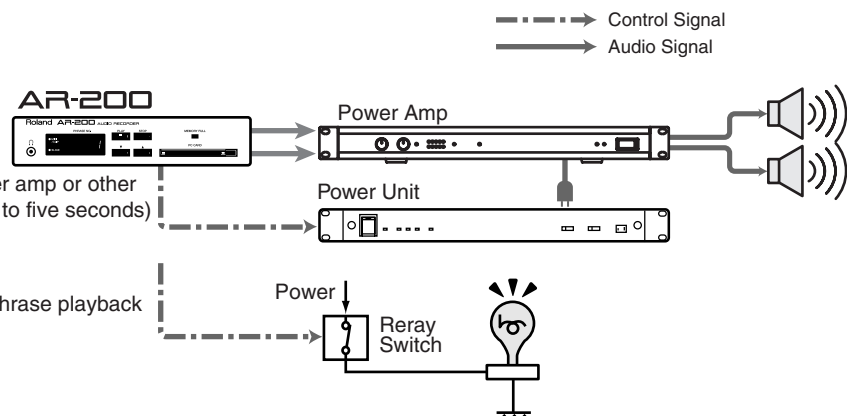

#### ● Control Out

After playback ends, controls external device

\* A card formatted on the AR-2000 or AR-3000 is required.

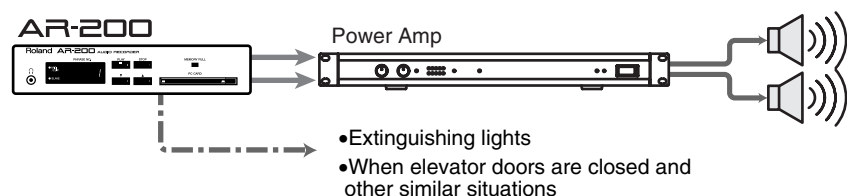

## Using the MIDI Connectors

- Spatial Expression

Using MIDI signals from a master AR-3000 (sold separately), you can play back background music performances from sound generating modules and other devices as well as sound effects phrases on slave AR-200s. This lets you create sonic fields with six-channel multi-playback.



"Controlling the AR-200 with MIDI Signals (MIDI control)" (p. 42)

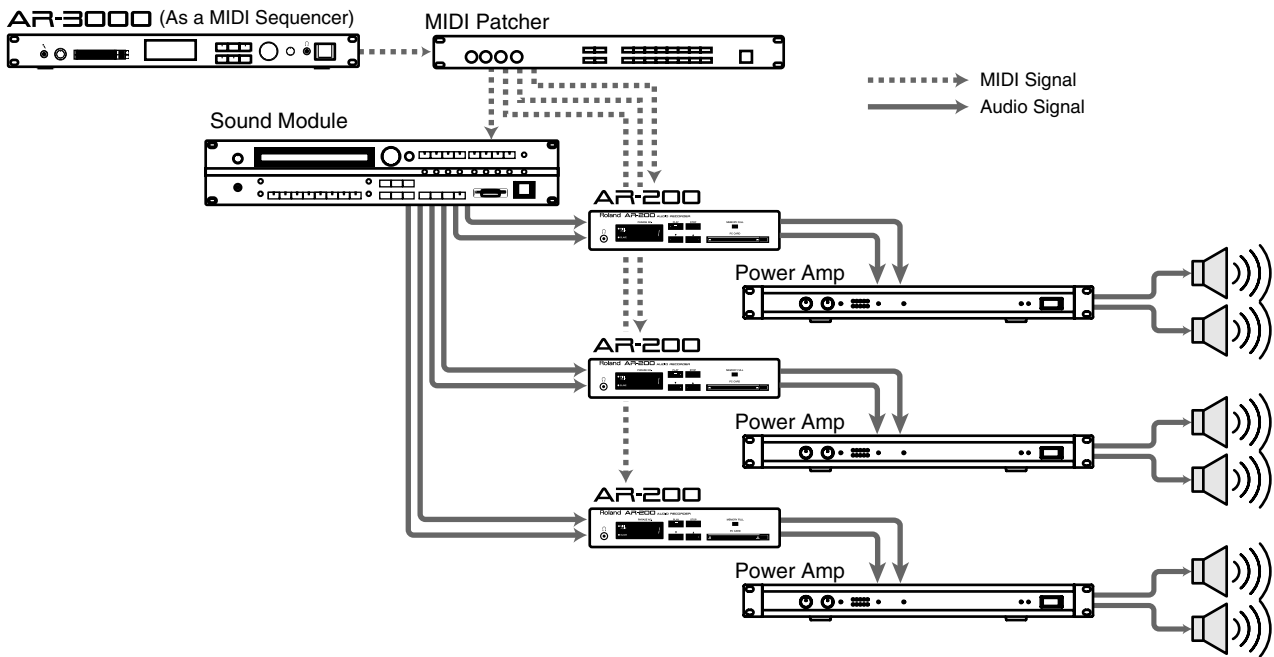

- Sound-field Control

Using batch MIDI control from a switch box, you can change programs on a mixer, equalizer, or the like to control the sonic field.

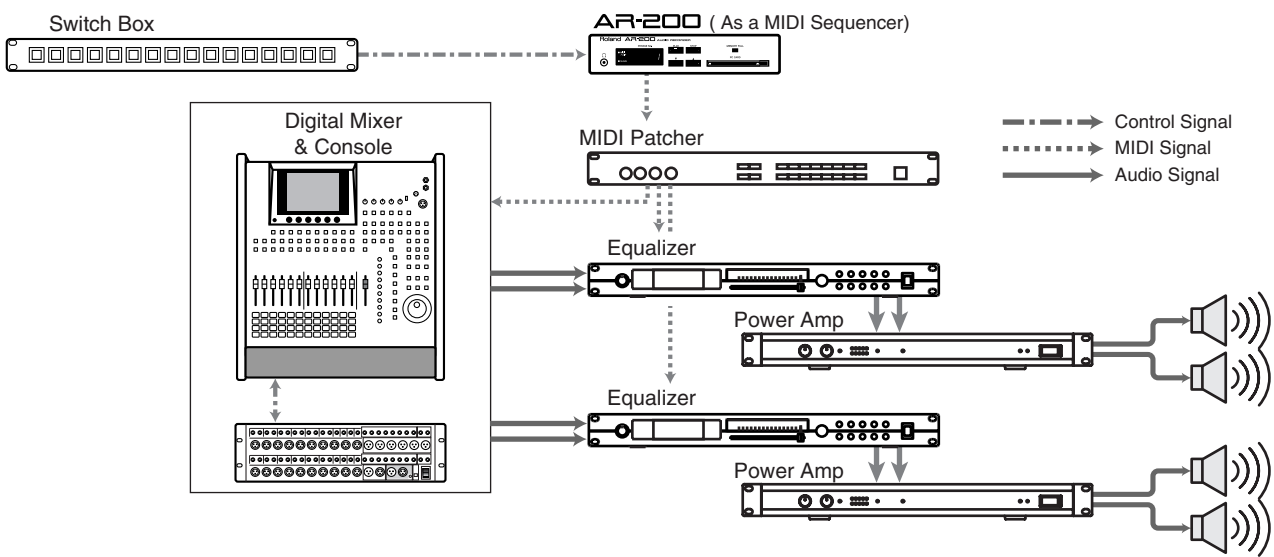

## **What You Can Do (Usage Tips)**

---

### **Repeat Playback of the Same Phrase**

There are several methods for doing this. Choose a playback method that matches your usage conditions.



**"Interval Playback"** (p. 34)

### **Changing Playback Mode Settings to Interval Mode**

You can have phrases be played back repeatedly at set intervals.

### **Inputting a Continuous Make-contact Signal to the Control Input Connectors**

You can repeat playback by continuously shorting the control input connectors.

\* *With some settings, playback doesn't repeat even when you continuously input a make-contact signal.*

For information, refer to **"Controlling the AR-200 from an External Device (Control Input Connectors)"** (p. 30).

### **Playing a Variety of Phrases in Succession**

There are several methods for doing this. Choose a playback method that matches your usage conditions.

### **Using Direct Playback of Control Input**

By inputting control signals to a connector number from 1 through 9, you can play back the phrase assigned to the number.



**"Direct Playback"** (p. 30)

### **Using Binary Playback of Control Input**

You can select phrases by inputting binary signals to connector numbers 1 through 8, and play the selected phrases in succession each time you input control signals to the START connector.



**"Binary Playback"** (p. 31)

# Cards Handled by the AR-200

## Types of Usable Cards

The AR-200 stores recorded audio and MIDI signals on the card. Additionally, all information other than recorded audio (phrase information) is stored on the card as well. (That is, it is not stored in the AR unit itself.)

This means that you can change the settings simply by swapping cards.

For cards used with the AR-200, we recommend Roland's line of optional PC cards (PM Series):

Roland PC Cards (PM series)

PM-004 (4M bytes)

PM-008 (8M bytes)

PM-016 (16M bytes)

PM-024 (24M bytes)

PM-032 (32M bytes)

PM-040 (40M bytes)

PM-080 (80M bytes)

PM-096 (96M bytes)

PM-184 (184M bytes)

PM-256 (256M bytes)

PM-01G (1G bytes)

You can also use a Smart Media adaptor (the optional SMA-1).

→ This adaptor allows commercially available Smart Media cards to be used with the AR-200.

\* *SmartMedia is a trademark of Toshiba Corporation.*

## Card Storage Times and Number of Phrases

A maximum of 250 phrases may be created on cards formatted on the AR-200.

- \* *The available recording time for a single card varies according to card capacity and recording settings.*
- \* *For a rough guide to maximum recording times with various settings, see the "Card Audio Recording Time Chart" in the reference materials (p. 53).*

## Formatting a Card

When you use a new card or a card used previously on a device other than the unit, you must first format (initialize) the card.

- \* *Cards formatted on the AR-3000 can be used just as they are.*
- \* *Please refer to p. 18 for information regarding previous models (AR-2000/100/1).*

### NOTE

Information cannot be stored in memory in the AR unit itself, so be sure to purchase cards separately. There are several types of card capacities available. The amount of information that you can store differs according to card capacity.

### NOTE

Depending on the type of PC card or SmartMedia you are using, it may not be possible to perform recording or playback at the set RDAC-Grade and RDAC-Mode due to data write speed and other factors.

### NOTE

Depending on the length of stored phrases, it may not be possible to create the set maximum number of phrases.

### NOTE

The time required for formatting a card varies with the card type (capacity), but may last from several seconds up to ten or twenty seconds.

## Cards Handled by the AR-200

### Notes Regarding Formatting

Performing formatting erases all data on the card. Before you format the card, make sure it contains no data you don't want to lose.

- \* A maximum of 250 phrases may be created on cards formatted on the AR-200.
- \* The available recording time for a single card varies according to card capacity and recording settings.
- \* For a rough guide to maximum recording times with various settings, see the "Card Audio Recording Time Chart" in the reference materials (p. 53).

#### NOTE

Depending on the length of stored phrases, it may not be possible to create the set maximum number of phrases.

### Procedure for Formatting Cards

**1** Confirm that there is no card inserted in the card slot.

**2** Hold down the STOP button for at least 5 seconds  
A flashing "Fot" appears.



**3** Insert the card that you wish to format into card slot.

**4** Press the PLAY button, formatting will begin.

**5** If you wish to stop the process, press the STOP button.  
When formatting is completed, the message is changed in the display.



#### NOTE

Never remove a card while formatting is in progress.

### Important Notes on Handling Cards

- When Inserting  
Insert the card all the way into the card slot.
- When Removing  
To remove the card, press the eject button.  
Never remove a card during recording, playback, or formatting.  
Furthermore, do not turn off the power or remove the AC adaptor cord during recording, playback, or formatting. Doing so may damage the card.



## Card Compatibility with Other Models in the AR Series

### If You're Using a Legacy Model

In case the card you are using with the AR-200 has been used on one of Roland's previous AR-2000, AR-100, or AR-1 devices; or if using an AR-200 card on one of these legacy models, the operational specifications are shown below.

- When using a card formatted on the AR-2000 (compatible models: AR-2000/100/1) with the AR-200.

You can carry out recording and playback without having to make any special changes.

Although playback may be carried out as is, the card cannot be used for recording.

#### AR-200

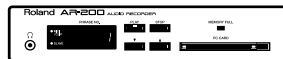

- Recording, PLAY
- ✕ settings changes, and phrase editing



Formatted on AR-2000



- When using a card formatted on the AR-200 with a legacy model (AR-2000/100/1)

Cards formatted on the AR-200 cannot be used with these previous models.

#### Previous Models AR-2000/100/1

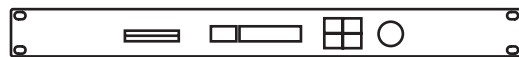

Can not be used

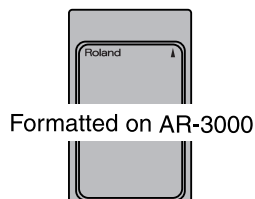

#### MEMO

You must perform Card Convert and Phrase Convert on the AR-3000 in order to make the card formatted on the AR-200 to be usable with a legacy model (AR-2000/100/1).

# Recording Audio

## Recording Units—Phrases

A single item of data recorded from the point where you start recording until the point where you stop recording is called a phrase. Audio data and MIDI data are both handled as phrases. Phrases are managed by phrase numbers.



Phrase Number

## Connecting External Devices

The AR-200 features analog input jacks (INPUT) on the rear panel. Refer to the following figure when connecting the AR-200 with external devices.

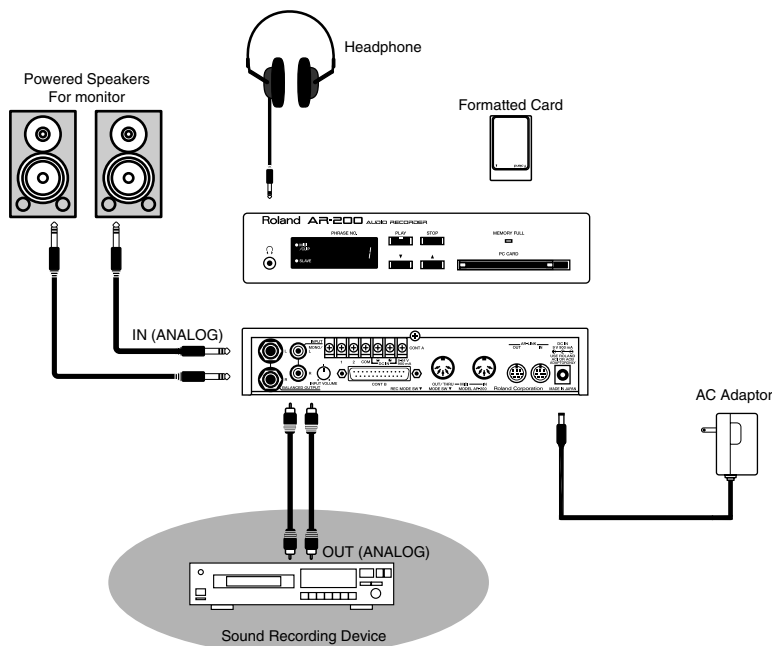

## Monitor Output During Recording and Recording Standby

Sounds input from the analog input jack (INPUT) can be output from the audio output jacks (BALANCED OUTPUT) during recording, recording standby, and ordinary playback.

- \* *The quality of sounds output from the audio output jack differs from that of RDAC-Grade or RDAC-Mode sound quality. Be sure to play back the phrase after recording to confirm the quality of the content.*



"What is a MIDI Phrase?"  
(P.26)



"Important Notes on Making Connections and Switching the Power On and Off" (P.9)

## Procedure for Recording

To enable recording with the AR-200 using cards formatted on the AR-2000, carry out the "Formatting a Card" (P.15) procedure.

### Required Settings for Recording Audio Signals (Recording Settings)

In order perform recording matched to usage conditions, including the connected equipment, recording source, sound quality, time, and playback system, you make recording settings.

Recording settings are made in phrase units. You can mix phrases having different recording settings on a single card.

The possible recording time of a card varies according to the recording settings. For a rough guide to maximum recording times with various settings, see the "Recording Audio" (P.18) in the reference materials (p. 53).

### RDAC-Grade(sampling frequency) (REC MODE SW-3)

The RDAC grade is the type of sampling frequency for digital recording. On the AR-200, you can select from among six grades.

		Sound quality	Amount of card memory consumed
S-HIGH	: 48 kHz	High	Large
HIGH	: 44.1 kHz	↑	↑
STANDARD	: 32 kHz		
LONG1	: 22.05 kHz		
LONG2	: 16 kHz		
ANNOUNCE	: 8 kHz	↓	Small

STANDARD is best for ordinary recording. ANNOUNCE uses up the least card space, and is best for recording announcements, narration, and the like. When you are recording audio such as a narration with ANNOUNCE or LONG2, you can record with higher clarity by using the equalizer to cut the bass range. Select an RDAC grade that matches the circumstances of use.

#### Procedure

- 1 Turn off the power of the AR-200.
- 2 Set the SW 1-3 REC MODE switches on the AR-200's bottom panel.

## Recording Audio

The different grade settings are shown in the following table.

RDAC-Grade	SW 1	SW 2	SW 3
ANNOUNCE	ON	OFF	OFF
LONG2	OFF	ON	OFF
LONG1	OFF	OFF	OFF
STANDARD	ON	ON	OFF
HIGH	OFF	OFF	ON
S-HIGH	ON	OFF	ON

### MEMO

If the type of card does not provide the recording time you want, change the RDAC mode or RDAC grade setting to use less card capacity, then perform recording again.

**3**

Turn on the power of the AR-200.

\* Use a narrow-tipped object to set the MODE switches to ON or OFF.

### RDAC-Mode (Signal Processing Format)(REC MODE SW 4, 5)

The RDAC mode is a type of digital data processing system for recording.

On the AR-200, you can select from among four modes.

		Sound quality	Amount of card memory consumed
LINEAR	: 16 bit PCM Recording	High	Large
MODE3	: About 2.5 times the recording time of Linear.	↑	↓
MODE2	: More than 2.5 times the recording time of Linear.		
MODE1	: About 4 times the recording time of Linear.		

LINEAR enables recording at the highest sound quality, but uses the most space on the card. MODE1 uses up the least card space, and is suited to long recording times. Select an RDAC mode that matches the circumstances of use.

#### Procedure

**1**

Turn off the power of the AR-200.

**2**

Set the SW 4 and 5 REC MODE switches on the AR-200's bottom panel.

The different grade settings are shown in the following table.

RDAC-Mode	SW 4	SW 5
MODE 1	OFF	OFF
MODE 2	ON	OFF
MODE 3	OFF	ON
LINEAR	ON	ON

**3**

Turn on the power of the AR-200.

\* Use a narrow-tipped object to set the MODE switches to ON or OFF.



"Card Audio Recording Time Chart" (P.53)

**What's RDAC?**

RDAC (Roland Digital Audio Coding) is a proprietary audio recording standard from Roland.

It achieves high sound quality and also makes it possible to record for long times.

**If You're Not Sure About Which Grade and Mode to Choose**

The optimal grade and mode vary according to the usage conditions, including the connected equipment, recording source, sound quality, time, and playback system.

The factory default settings are RDAC-Grade: LONG1; and RDAC-Mode: MODE1.

First, try recording and playback with these settings. In most cases, this yields satisfactory sound quality.

**Recording Type (Stereo/Mono)(REC MODE SW 6)**

Select either stereo recording or mono recording.

Choosing mono recording gives you recording times that are twice as long as with stereo recording.

**Procedure**

1. Turn off the power of the AR-200.
2. Set the SW 6 REC MODE switch on the AR-200's bottom panel.  
OFF : MONO  
ON : STEREO
3. Turn on the power of the AR-200.

\* Use a narrow-tipped object to set the MODE switches to ON or OFF.

**What is mono recording**

In the case of mono recording, input the audio signal to the "MONO/L" input jack. When audio signals are input simultaneously to the "MONO/L" and "R" input jacks, L and R are mixed and recorded.

**Line Thru Output**

REC SW6: OFF (mono)

When audio signals are input to "MONO/L," output is from OUTPUT L and R. When audio signals are input to "R," output is from OUTPUT R only.

When audio signals are input to both "MONO/L" and "R," solely the signals input to "MONO/L" are output from OUTPUT L, while the "MONO/L" and "R" signals are mixed and output from OUTPUT R.

REC SW6: ON (stereo)

Audio signals input to "MONO/L" are output from OUTPUT L, and audio signals input to "R" are output from OUTPUT R.

## Recording Audio

### Procedure

Make the correct connections, then turn on the power switch.

**1** Insert a formatted card into one of the slots.

**2** Press the [ ▼ ] or [ ▲ ] button to select the number of the phrase to be recorded.

The non-recording phrase number in display is flashed.



\* If you are re-recording over a previously recorded phrase, you should delete the phrase. (p. 26)

\* You cannot change the phrase number after recording, so be sure to select the phrase number you want to record.

**3** Hold down the STOP button and press the PLAY button to go into recording standby.

The PLAY indicator is flashed while the recording standby mode.

**4** Input the sounds from the device connected to the input jacks, then use the input volume knob to adjust the recording level so that the MIDI/CLIP indicator does not light.

Nominal Input level: 0 dBm

Maximum input level: +2.5 dBu

\* If signals louder than +2.5 dBu are being input, rotate the input volume knob to the left of center.

\* Press the STOP button and recording standby mode will end.



"Important Notes on Making Connections and Switching the Power On and Off" (P.9)

**5** When you press the PLAY button, sounds are input to the input jacks, and recording begins.

\* Even when the PLAY button is pressed, recording does not begin until the sound is at or above the base level (-36 dBu) (in trigger recording standby).

While recording is in progress, the PLAY indicator lights, and a dot flashes in the display.



\* When the card becomes full, recording will stop automatically.

**6** Press the Stop button to end recording.

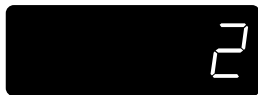

### NOTE

The MEMORY FULL indicator tells how much recording time is left. The MEMORY FULL indicator light flashes when the recorded data reaches 90% of the card's capacity, then stays on when 100% capacity is reached.

## Checking What You Recorded

After recording ends, you can play back the phrase by pressing the Play button.

### Information Recorded on the Card

The AR-200 stores recorded audio and MIDI signals on the card.

Additionally, all settings data (such as MIDI channels and other information) is stored on the card (the information is not stored in the AR unit itself).

This means that you can change the settings simply by swapping cards.

# Playback Using the Panel (Manual Playback)

Here is how to playback the phrase to check the recording.

The sound will be output from the Phones jack and from the output jacks.

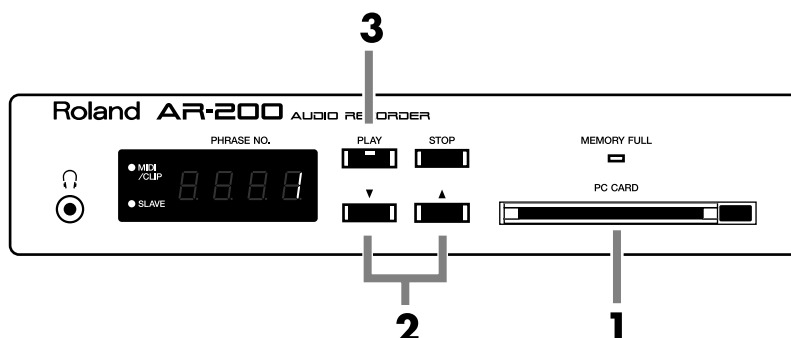

## Procedure

- 1 Insert a card containing recorded information into a slot.
- 2 Press the [▼] or [▲] button to select the number of the phrase to be played back.  
*\* The non-recording phrase number in display is flashed.*
- 3 Press the PLAY button and the phrase will playback.  
During playback of the phrase, the Play indicator lights up. The dot in the display also lights up.

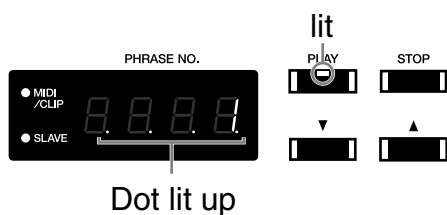

*\* Pressing the Stop button ends playback.*



# Deleting Phrases

You can delete unneeded phrases, either by deleting single phrase units or entire collections of phrases.

## Deleting Single Phrases

**1** Press the [ ▼ ] or [ ▲ ] button to select the number of the phrase to be deleted.

**2** Hold down the STOP button for at least 5 seconds.  
A flashing "dEL" appears.



**3** Press the PLAY button to execute deletion of the phrase.

*\* To stop the procedure, press the STOP button.*

When you're finished deleting the phrase, the display indication changes.



## Deleting All Phrases

**1** After confirming that the card to be deleted is inserted in the card slot, hold down the STOP button for at least five seconds.  
A flashing "dEL" appears.

**2** Press the [ ▲ ] button, so you have the "ALL" displayed.



**3** Press the PLAY button to execute deletion of the phrases.

*\* To stop the procedure, press the STOP button.*

When you're finished deleting the phrase, the display indication changes.



### NOTE

You cannot delete phrases on cards formatted on the AR-2000. Attempting to enter the menu screen causes the error message "Er16" to appear in the display.

### NOTE

Never remove a card while phrases are being deleted.

# Recording and Playing MIDI Data (MIDI Phrase)

## What is a MIDI Phrase?

You can use the AR-200 for recording and playback of MIDI data. MIDI data recorded with the AR-200 are called "MIDI phrases."

MIDI phrases and audio phrases are treated identically as phrases.

You can take MIDI data recorded with a MIDI sequencer and record this to the AR-200 as MIDI phrases, using them as "MIDI data playback sent to sound generating modules for broadcast within buildings."

MIDI data is saved by the AR-200 as Format 0 SMFs (Standard MIDI Files). The MIDI Time Base is fixed at 192.

- \* *Audio phrases and MIDI phrases cannot be recorded or played back simultaneously.*
- \* *The capacity of cards used for MIDI phrases is affected not only by recording time, but by the size of the MIDI data in the MIDI phrases themselves. Please be aware that when you record MIDI phrases, the possible recording time for a single card varies according to the size of the MIDI data.*

## MEMO

Control of the unit by using MIDI signals is described in another chapter.

Please refer to "Controlling the AR-200 with MIDI Signals (MIDI control)" (P.42).

## Connecting External Devices

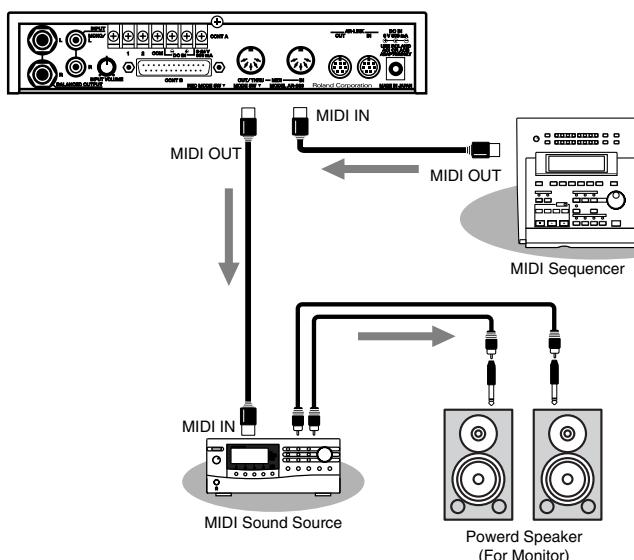

## MEMO

This automatically changes to MIDI THRU during recording and in recording standby.



"Important Notes on Making Connections and Switching the Power On and Off" (P.9)

## Procedure for Recording MIDI Phrases

Make the correct connections, then turn on the power switch.



"Important Notes on Making Connections and Switching the Power On and Off" (P.9)

1. Insert a formatted card into one of the slots.
2. Press the [ ▼ ] or [ ▲ ] button to select the number of the phrase to be recorded.
  - \* *The non-recording phrase number in display is flashed.*
  - \* *If you are re-recording over a previously recorded phrase, you should delete the phrase (p. 25).*
  - \* *You cannot change the phrase number after recording, so be sure to select the phrase number you want to record.*
3. Hold down the STOP button and press the PLAY button to go into recording standby.

The PLAY indicator is flashed while the recording standby mode.

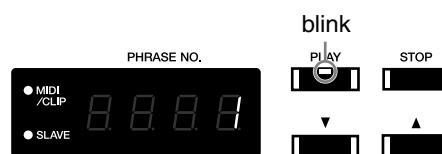

4. Hold down the [ ▲ ] button for at least five seconds to switch to MIDI mode. The MIDI/CLIP indicator is lit.
  - \* *Recording will begin when a System Real time message "Start" (FAH) is received from the connected MIDI device.*
5. After you press the PLAY button, recording begins when MIDI signals are input from the connected MIDI device. While recording is in progress, the PLAY indicator lights, and a dot flashes in the display.

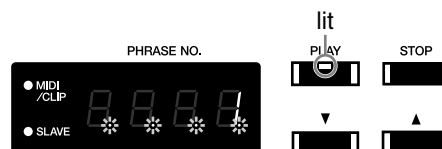

- \* *When the card becomes full, recording will stop automatically.*

## MEMO

The MEMORY FULL indicator tells how much recording time is left. The MEMORY FULL indicator light flashes when the recorded data reaches 90% of the card's capacity, then stays on when 100% capacity is reached.

6. Press the Stop button to end recording.

\* *Recording will also stop if a Stop signal is received from the connected MIDI device.*

## NOTE

- Some MIDI sequencers output MIDI sound generator setup messages (tone settings for each part, volume information, effects data, and so on) when a song is selected, and this may prevent MIDI messages from being recorded correctly when recording with the AR-200 begins. In such instances, start recording with the AR-200 first, then after this select and play back the song from the MIDI sequencer.
- In recording MIDI with the AR-200, the recording tempo is set at 120 (tempo information is not stored).
- You cannot change the phrase number afterward, so be sure select the phrase number you want to record before you start recording.

## HINT

### Using MIDI Signals to Start and Stop Recording

With the AR-200, you can do things such as have recording start upon reception of a start message from another MIDI device, as well as have a recording in progress be stopped upon reception of a stop message. During recording standby, recording starts when a System Real time start message (FAH) is received, and stops when a stop message (FCH) is received.

Furthermore, start (FAH) and stop (FCH) messages are transmitted when phrases are played back.



"MIDI Implementation", "MIDI Implementation"(p. 58-p. 64)

## Procedure for Playing Back MIDI Phrases

### Manual playback

1. Insert a card containing recorded information into a slot.
2. Press the / button to select the number of the phrase to be played back. The MIDI/CLIP indicator lights up when a MIDI phrase is selected.



\* *The non-recording phrase number in display is flashed.*

3. Press the PLAY button and the phrase will playback.

While playback is in progress, the PLAY indicator lights, and a dot flashes in the display.

4. Press the Stop button to end playback.

### Playback Using Control Input and Other Input

You can play back control input and other input in the same manner as you would with audio phrases.

# Controlling the AR-200 from an External Device (Control Input Connectors)

You can use the control input and DC input screw terminals (CONT A) and the 25-pin D-sub-type control I/O connector (CONT B) on the AR-200's rear panel to control the AR-200 from an external device.

This chapter explains how to connect external devices and make the settings for the AR-200.

## What Is No-voltage/Make-contact?

This is contact that makes starting possible simply by connecting two lines to the control input connectors and shorting their ends. This is a general-use method that lets you create start systems easily using only a switch and without any need for a power source, enabling easy use for a variety of applications.

You can control playback and recording with the AR-200 using On/Off signals from No-voltage/Make-contact input from an external source.

By connecting infrared sensors or switches, relays, and timers, or other external starting connectors to the AR-200, you can use the unit in an even wider variety of applications.

The AR-200 can help simplify installation operations by making the starting-side contact hot and sharing the ground as the common connector.



For more on the control input specifications, refer to "Control I/O Connector specifications" (p. 57) in the Appendices.

### Important Note on Using the Control I/O Connector

The control I/O connector cannot be used to switch the power to the AR unit on or off.



When making connections to the ports, be careful not to lose the removed screws. Place the screws out of the reach of small children. If a screw is accidentally swallowed, immediately consult a physician.

## Types of Control Input Playback

There are four types of control input playback: Playback by Card Data (p. 28), Direct Playback (Reverse Priority) (p. 30), Binary Playback (p. 31), and Interval Playback (p. 34).

\* You cannot use more than one type of playback at the same time.

## Operational Specifications for Control Input Playback

	When new control signals are input during playback of a phrase	When control signals are input continuously
Direct Playback (Normal)	A phrase in progress is stopped, and playback of another specified phrase is begun only when the control signal being input is of a higher priority than that of the phrase currently being played back	Repeated
Direct Playback (Reverse Priority)	Playback stopped, followed by playback of the specified phrase	Repeated
Interval Playback	Playback stopped, followed by playback of the specified phrase	Repeated
Binary Playback	Disabled	Repeated

## Types of Control Input Recording

The AR-200 features one type of control input recording, "Terminal Rec" (p. 34).

## Playback By Card Data

### Cards Created on the AR-3000, AR-2000, or AR-1

Playback will use the settings (playback method) recorded in the card. For more information, please refer to the owner's manuals for each device.

\* Some functions are not available. (p. 55)

### Card made on the AR-100/200

Playback mode is available Direct Playback(Normal).

Phrases 1 through 9 are assigned to the control I/O connector Port Nos. 1 through 9.

### Direct playback(Normal playback)

A phrase is played back when a control signal is input directly to the terminal with the number to which the phrase is assigned. Up to 9 phrases can be played back. Assign Phrases 1 through 9 beforehand to Port Nos. 1 through 9, respectively.

This makes it very convenient when you want to specify a desired phrase directly using a switch, relay, sensor, or other such means.

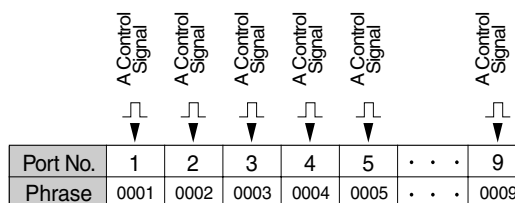

# Controlling the AR-200 from an External Device (Control Input Connectors)

## Connectors Used for Direct Play (Control I/O Connector)

“1–9”: Inputting a control signal directly to the terminal with the number corresponding to the phrase starts playback of the phrase.

“10 (Stop)”: This stops phrase playback.

In addition to the connectors just described, shorting “11/12 (GND)” (ground) connectors enables “On.”

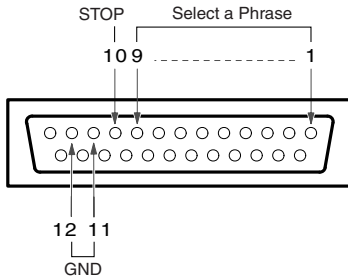

**"Important Notes on Making Connections and Switching the Power On and Off" (p. 9)**

## Basic Operation of Direct Playback (Normal Playback)

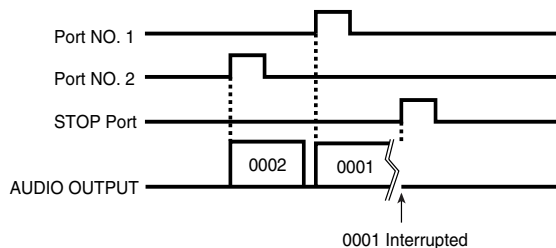

Playback:

Input a control signal to a Port, 1–9.

→ The phrase assigned to the Port is played back.

stopping:

Input a control signal to Port 10 (STOP).

→ Playback of the phrase is stopped.

## Order of Priority

The control input pins have a priority order.

The priority order is as follows:

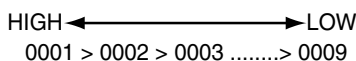

When a new high-priority control signal is input during phrase playback, playback of the current phrase is stopped, and playback of the specified phrase begins.

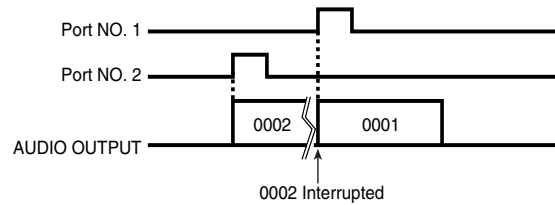

\* If a control signal has a lower priority than that of the phrase currently being played back, the specified phrase is not played back.

Playback is repeated while the control signal is continuously input.

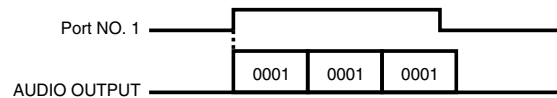

## AR-200 Settings

### Selecting the Control Input Mode

Set the MODE switches on the AR-200's bottom panel to select "PLAYBACK BY CARD DATA" from the control input modes (PLAYBACK BY CARD DATA/DIRECT PLAYBACK/BINARY PLAYBACK/INTERVAL PLAYBACK).

\* You cannot achieve control input playback merely by connecting a device to the port. Be sure to set the control input mode and match the method used for connecting to the connectors.

### Procedure for Setting the Control Input Mode

1. Turn off the power of the AR-200.
2. Set the MODE switches on the AR-200's bottom panel as shown below.

SW1: OFF

SW2: OFF

3. Turn on the power of the AR-200.

\* Use a pointed object to change the ON/OFF settings of the MODE switches.

### Assigning Phrases to the Terminals

Assign phrases 1 through 9 to Port Nos. 1 through 9.

### Settings in Effect When a Card Is Formatted

Port No.	1	2	3	4	5	...	9
Phrase	0001	0002	0003	0004	0005	...	0009

## Playing Back Phrases Assigned to the Connectors (Direct Playback)

What Is Direct Playback (Reverse Priority)?/Use and Applications

By inputting control signals directly to Port Nos. 1 through 9, you can play back the phrases assigned to those numbers. Up to 9 phrases can be played back. Assign phrases 1 through 9 beforehand to Port Nos. 1 through 9.

This is very convenient when you want to specify a desired phrase directly using a switch, relay, sensor, or other such means.

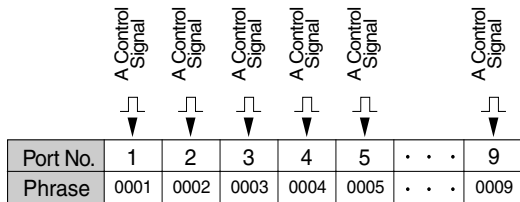

## Connecting External Devices

### Connectors Used for Direct Play (Last-In) (Control I/O Connector)

1 through 9: Inputting a control signal directly to the connector with the number corresponding to the phrase starts playback of the phrase.

"10 (STOP)": Stop phrase playback.

In addition to the connectors just described, shorting the "11/12 (GND)" (ground) connectors enables "On."

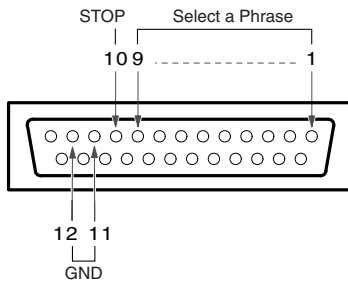

**"Important Notes on Making Connections and Switching the Power On and Off" (p. 9)**

## Operational Specifications for Direct Playback (Last-In)

### Basic Operation of Direct Playback (Reverse Priority)

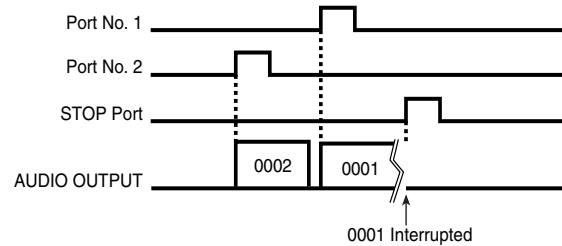

Playback:

Input control signals to Port Nos. 1 through 9.

→ This plays the phrase assigned to the connector.

stopping:

Input control signals to Port No. 10 (STOP).

→ This stops playback of the phrase.



**"Operational Specifications for Control Input Playback"**

(p. 28)

### Priority Order

The most recently input control signal is given priority in playback.

If a new and different control signal is input during playback of a phrase, playback of the current phrase is stopped, and playback of the specified phrase then begins.

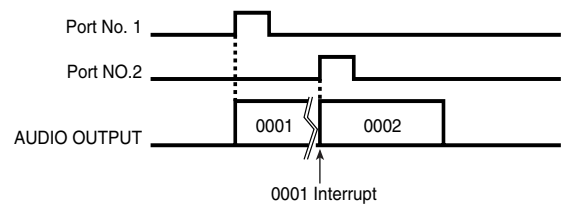

Playback is repeated while the control signal is continuously input.

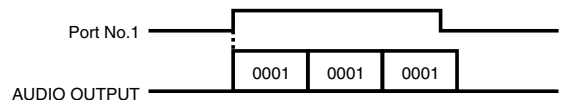

## AR-200 Settings

### Selecting the Control Input Mode

Set the MODE switches on the AR-200's bottom panel to select "DIRECT PLAYBACK" from the control input modes (PLAYBACK BY CARD DATA/DIRECT PLAYBACK/BINARY PLAYBACK/INTERVAL PLAYBACK).

You cannot achieve control input playback merely by connecting a device to the port. Be sure to set the control input mode and match the method used for connecting to the connectors.

### Procedure for Setting the Control Input Mode

1. Turn off the power of the AR-200.
2. Set the MODE switches on the AR-200's bottom panel as shown below.

SW1: ON

SW2: OFF

3. Turn on the power of the AR-200.

\* Use a pointed object to change the ON/OFF settings of the MODE switches.

### Assigning Phrases to the Terminals

Assign phrases 1 through 9 to Port Nos. 1 through 9.

### Settings in Effect When a Card Is Formatted

Port No.	1	2	3	4	5	...	9
Phrase	0001	0002	0003	0004	0005	...	0009

## Specifying Phrases in Binary Notation (Binary Playback)

### What Is Binary Playback?/Use and Applications

By inputting binary (Base 2) signals to Port Nos. 1 through 8 to select a phrase and inputting a start message to the START terminal, you can then play back the selected phrase. A maximum of 250 phrases can be selected and played back with this method.

This allows you to specify 250 phrases with control signals (from a switch or other ON/OFF signal device), without having to use computers or other complicated equipment.

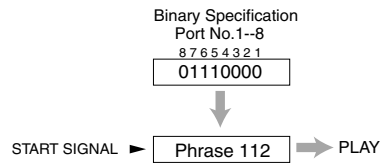

- \* To conduct Binary Playback, you will need to obtain a control device capable of generating binary signals.
- \* Input of binary specifications should be completed in no more than 50 milliseconds.

## Connecting External Devices

### Connectors Used in Binary Playback

"1-8": Phrases are specified in binary format using combinations of 0 (Off) and 1 (On).

"9 (START)": Start phrase playback.

"10 (STOP)": Stop phrase playback.

In addition to the connectors just described, shorting the 11/12 (GND) (Ground) connectors enables "On."

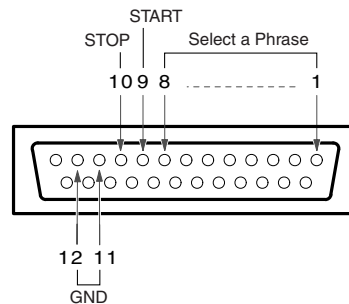

"Important Notes on Making Connections and Switching the Power On and Off" (p. 9)

### MEMO

Even without connecting to all eight connectors used for making the binary specifications, you can still conduct Binary Playback. The number of phrases that can be specified is determined by the formula "two to the nth power minus one" (with "n" being the number of connectors used).

Example:

Using three timers or other such devices capable of outputting the necessary signals gives two to the third power minus one (i.e.,  $8 - 1 = 7$ ), meaning you can specify the seven phrases 001 through 007.

However, start signals feature other special requirements.

## Operational Specifications of Binary Playback

### Basic Operation of Binary Playback

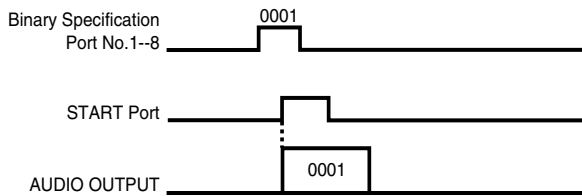

Playback:

Specify the phrases using combinations of 0 (Off) and 1 (On) signals to Port Nos. 1 through 8, and Port Nos. 11 and 12, and input a control signal to the Port No. 9 (START).

→ This plays back the specified phrase.

Stopping:

Input a control signal to Port No. 10 (STOP).

→ This stops playback of the phrase.

The basic operation of Binary Playback is shown below.

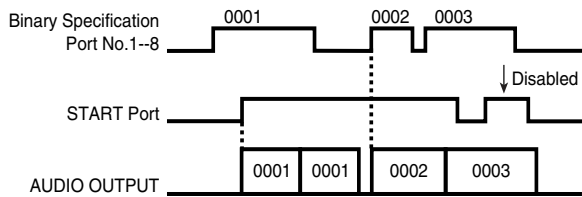

Binary specified phrases are played back repeatedly.

Playback is repeated while the start signal is continuously input.

You can begin playback of phrases by specifying phrases in binary with the start signal continuously being input.

When the START connector control signal switches to Off, the current phrase finishes, and then playback is stopped.

No action results when a new start signal is input while a phrase is being played back.

## AR-200 Settings

### Selecting the Control Input Mode

Set the MODE switches on the AR-200's bottom panel to select "BINARY PLAYBACK" from the control input modes (PLAYBACK BY CARD DATA/DIRECT PLAYBACK/BINARY PLAYBACK/INTERVAL PLAYBACK).

\* You cannot achieve control input playback merely by connecting a device to the port. Be sure to set the control input mode and match the method used for connecting to the connectors.

### Procedure for Setting the Control Input Mode

1. Turn off the power of the AR-200.
2. Set the MODE switches on the AR-200's bottom panel as shown below.

SW1: OFF

SW2: ON

3. Turn on the power of the AR-200.

\* Use a pointed object to change the ON/OFF settings of the MODE switches.

## To Specify Phrases with Binary Signals

Example: Specifying Phrase 0112 (Phrase #: 0112)

1. Convert the phrase number to a binary signal number.

"0" (Off)

"1" (On)



Phrase Number/Binary Signal Correspondence Table (p. 36)

The phrase number "0012" becomes the binary signal "01110000."

With the above step, Phrase No. 0112 is converted to:

Port No. →	8	7	6	5	4	3	2	1
INPUT Signal →	0	1	1	1	0	0	0	0
	Phrase Number (Binary)							



Input of binary specifications should be completed in no more than 50 milliseconds.



## Controlling the AR-200 from an External Device (Control Input Connectors)

### Phrase Number / Binary Signal chart

Phrase No.	Binary (Port 87654321)	Phrase No.	Binary (Port 87654321)	Phrase No.	Binary (Port 87654321)	Phrase No.	Binary (Port 87654321)	Phrase No.	Binary (Port 87654321)
001	00000001	051	00110011	101	01100101	151	10010111	201	11001001
002	00000010	052	00110100	102	01100110	152	10011000	202	11001010
003	00000011	053	00110101	103	01100111	153	10011001	203	11001011
004	00000100	054	00110110	104	01101000	154	10011010	204	11001100
005	00000101	055	00110111	105	01101001	155	10011011	205	11001101
006	00000110	056	00111000	106	01101010	156	10011100	206	11001110
007	00000111	057	00111001	107	01101011	157	10011101	207	11001111
008	00001000	058	00111010	108	01101100	158	10011110	208	11010000
009	00001001	059	00111011	109	01101101	159	10011111	209	11010001
010	00001010	060	00111100	110	01101110	160	10100000	210	11010010
011	00001011	061	00111101	111	01101111	161	10100001	211	11010011
012	00001100	062	00111110	112	01110000	162	10100010	212	11010100
013	00001101	063	00111111	113	01110001	163	10100011	213	11010101
014	00001110	064	01000000	114	01110010	164	10100100	214	11010110
015	00001111	065	01000001	115	01110011	165	10100101	215	11010111
016	00010000	066	01000010	116	01110100	166	10100110	216	11011000
017	00010001	067	01000011	117	01110101	167	10100111	217	11011001
018	00010010	068	01000100	118	01110110	168	10101000	218	11011010
019	00010011	069	01000101	119	01110111	169	10101001	219	11011011
020	00010100	070	01000110	120	01111000	170	10101010	220	11011100
021	00010101	071	01000111	121	01111001	171	10101011	221	11011101
022	00010110	072	01001000	122	01111010	172	10101100	222	11011110
023	00010111	073	01001001	123	01111011	173	10101101	223	11011111
024	00011000	074	01001010	124	01111100	174	10101110	224	11100000
025	00011001	075	01001011	125	01111101	175	10101111	225	11100001
026	00011010	076	01001100	126	01111110	176	10110000	226	11100010
027	00011011	077	01001101	127	01111111	177	10110001	227	11100011
028	00011100	078	01001110	128	10000000	178	10110010	228	11100100
029	00011101	079	01001111	129	10000001	179	10110011	229	11100101
030	00011110	080	01010000	130	10000010	180	10110100	230	11100110
031	00011111	081	01010001	131	10000011	181	10110101	231	11100111
032	00100000	082	01010010	132	10000100	182	10110110	232	11101000
033	00100001	083	01010011	133	10000101	183	10110111	233	11101001
034	00100010	084	01010100	134	10000110	184	10111000	234	11101010
035	00100011	085	01010101	135	10000111	185	10111001	235	11101011
036	00100100	086	01010110	136	10001000	186	10111010	236	11101100
037	00100101	087	01010111	137	10001001	187	10111011	237	11101101
038	00100110	088	01011000	138	10001010	188	10111100	238	11101110
039	00100111	089	01011001	139	10001011	189	10111101	239	11101111
040	00101000	090	01011010	140	10001100	190	10111110	240	11110000
041	00101001	091	01011011	141	10001101	191	10111111	241	11110001
042	00101010	092	01011100	142	10001110	192	11000000	242	11110010
043	00101011	093	01011101	143	10001111	193	11000001	243	11110011
044	00101100	094	01011110	144	10010000	194	11000010	244	11110100
045	00101101	095	01011111	145	10010001	195	11000011	245	11110101
046	00101110	096	01100000	146	10010010	196	11000100	246	11110110
047	00101111	097	01100001	147	10010011	197	11000101	247	11110111
048	00110000	098	01100010	148	10010100	198	11000110	248	11111000
049	00110001	099	01100011	149	10010101	199	11000111	249	11111001
050	00110010	100	01100100	150	10010110	200	11001000	250	11111010

## Repeated Playback of Phrases (Interval Playback)

The specified phrase will be played back at fixed intervals. Make each of the terminal settings beforehand for the playback interval and phrases to be played back.

When making settings in Interval Playback mode, assign Phrases 1 through 9 to the control output connectors 1 through 9.

The playback interval settings are shown below.

Port No.	Playback Interval
1	1 second
2	5 seconds
3	10 seconds
4	15 seconds
5	30 seconds
6	1 minute
7	5 minutes
8	15 minutes
9	30 minutes

## Operational Specifications of Interval Playback

### Basic Operation of Interval Playback

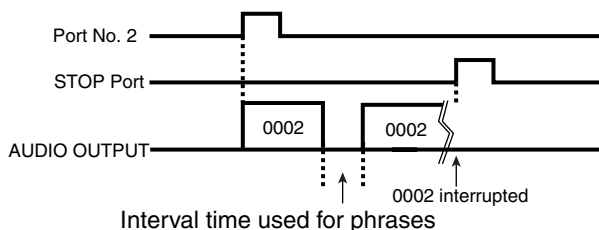

[Interval time used for phrases]

Playback:

Input control signals to the control Input/output connectors No. 1 through 9.

→ Results in the repeated play of the phrase assigned to the terminal.

stopping:

Input a control signal to Port No. 10 (STOP).

→ This stops playback of the phrase.

## AR-200 Settings

### Selecting the Control Input Mode

Set the MODE switches on the AR-200's bottom panel to select "INTERVAL PLAYBACK" from the control input

modes (PLAYBACK BY CARD DATA/DIRECT PLAYBACK/BINARY PLAYBACK/INTERVAL PLAYBACK).

You cannot achieve control input playback merely by connecting a device to the port. Be sure to set the control input mode and match the method used for connecting to the connectors.

### Procedure for Setting the Control Input Mode

1. Turn off the power of the AR-200.
2. Set the MODE switches on the AR-200's bottom panel as shown below.

SW1: ON

SW2: ON

3. Turn on the power of the AR-200.

\* Use a pointed object to change the ON/OFF settings of the MODE switches.

## Controlling Recording with the Control Connectors (Terminal Rec)

### What is Terminal Rec/Use and Applications

You can specify phrases by inputting binary (base 2) signals to the Port Nos. 1 through 8, and perform record, playback, and erase functions by inputting control signals to Port Nos. 9 and 10. A total of 250 phrases can be specified with control signals (On/Off). This is convenient when you want to control recording from an external control device.

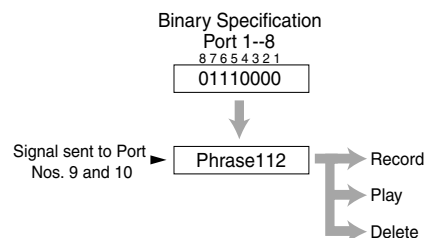

[Signal sent to Port Nos. 9 and 10]

\* To conduct binary control, you need to provide a control device that can generate binary signals.

\* Input of binary specifications should be completed in no more than 50 milliseconds.

## Connecting Equipment

### Connectors Used in Terminal Rec

1-8: Phrases are specified in binary format using combinations of 0 (Off) and 1 (On).

9, 10: Combinations of 0 (Off) and 1 (On) are used to specify record, erase, and playback.

15-18 (CONT OUT): Outputs signals for confirming the presence or absence of phrases.

In addition to the connectors just described, shorting Ports 11 and 12 (Ground) enables "On."

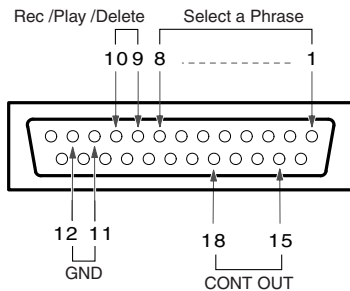

**"Important Notes on Making Connections and Switching the Power On and Off" (p. 9)**

## Operational Specifications for Terminal Rec

Phrases are specified by combinations of signals of 0 (Off) and 1 (On) to the Port Nos. 1 through 8 as well as Port Nos. 11 and 12, and record, playback, and erase functions are specified with combinations of control signals of 0 (Off) and 1 (On) to Port Nos. 9 and 10.

### Presence or Absence of Phrases

If there is a binary-specified phrase that has already been recorded, a signal is output from the CONT OUT connector (Port No. 15). If there is an empty phrase, no signal is output.

- \* During Terminal Rec, the CONT OUT connector functions as a connector for signals confirming the presence or absence of phrases. Note that this differs from the normal function of CONT OUT.

Timing Chart (The presence or absence of phrases)

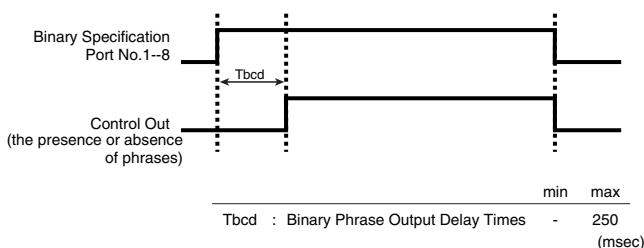

## Recording

9: 0 (Off)

10: 1 (On)

→ While control signals are being input, the specified phrase is recorded. When input of the control signal stops, recording then ends.

Timing Chart (Rec)

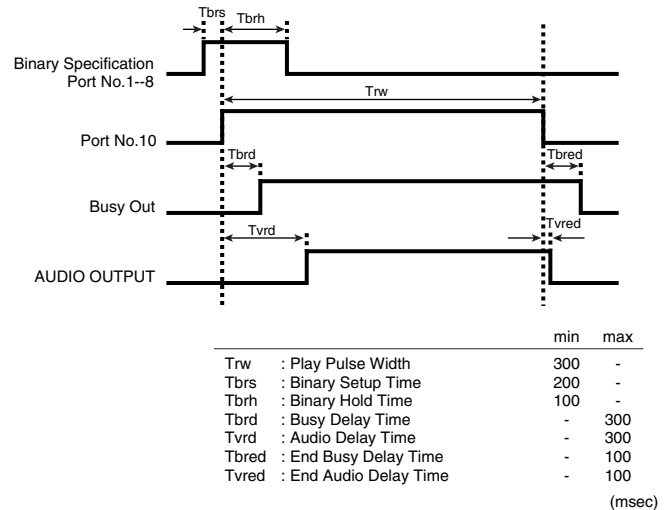

- \* Recording does not start if there is a binary-specified phrase that has already been recorded (the recording instruction is disabled). When recording, either specify an empty phrase or delete the existing phrase before recording the new one. Additionally, in Terminal Rec, since a make signal is output from the CONT OUT connector when a specified phrase has already been recorded, this allows confirmation using a connected external control device.
- \* When headphones are being used, no Busy Out signal is output.
- \* When you're using the Terminal Recording Mode, recording takes place immediately, without entering trigger recording standby.

# Controlling the AR-200 from an External Device (Control Input Connectors)

## Playback

9: 1 (On)

10: 0 (Off)

→ The specified phrase is played back. Even when control signals are input continuously, the phrase is played back one time only and then ends.

Timing Chart (PLAY)

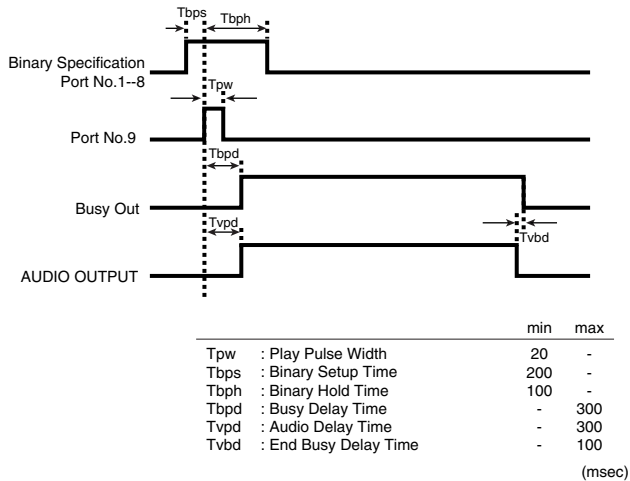

\* Playback does not begin if the binary-specified phrase is empty (the playback instruction is disabled). When playing back, specify a phrase that has already been recorded.

\* When headphones are being used, no Busy Out signal is output.

## Erase

9: 1 (On)

10: 1 (On)

→ First, when ON is input to Port No. 9, and then ON is input to Port No. 10, erasure of the specified phrase begins. Erasure ends when the signal from the CONT-OUT connector confirming the presence or absence of the phrase changes to OFF.

\* Erasure does not begin if the binary-specified phrase is empty (the erase instruction is disabled). When erasing, specify a phrase that has already been recorded.

Timing Chart (Delete)

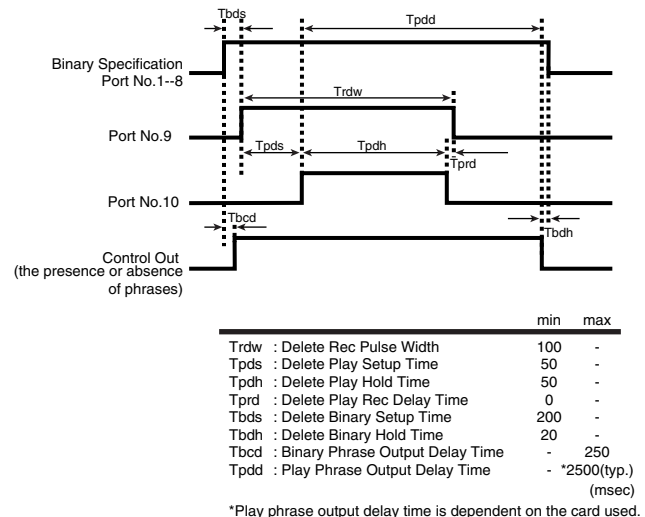

\*Play phrase output delay time is dependent on the card used.

## AR-200 Settings

### Switching the Terminal Recording Mode

Set the MODE switches on the AR-200's bottom panel to select the Terminal Rec (BINARY REC) mode.

You cannot achieve control input playback merely by connecting a device to the port. Be sure to set the control input mode and match the method used for connecting to the connectors.

### Procedure for Setting the Control Input Mode

1. Turn off the power of the AR-200.
2. Set the MODE switches on the AR-200's bottom panel as shown below.

SW6: ON

3. Turn on the power of the AR-200.

\* Use a pointed object to change the ON/OFF settings of the MODE switches.

## To Specify Phrases with Binary Signals

**NOTE**

Note that the way phrases are specified in Terminal Rec differs from that used in Binary Playback.

Example: Binary specification of Phrase 112 (Phrase #: 112)

Convert the phrase number to a binary signal number.

"0" (Off)

"1" (On)

The phrase number "0001" is specified in the binary notation as "00000000," and as shown in the Phrase Number/Binary Signal Correspondence Table below, each subsequent specification is shifted by one.

001	→	00000000			
<table style="width: 100%; border-collapse: collapse;"> <tr> <td style="width: 15%;">Phrase No.</td> <td style="width: 60%;">87654321</td> <td style="width: 25%;">Port No.</td> </tr> </table>			Phrase No.	87654321	Port No.
Phrase No.	87654321	Port No.			
<del>001</del>	↘	00000001			
002	↘	00000010			
003	↘	00000011			
004	↘	00000100			
005	↘	00000101			
006	↘	00000110			
007		00000111			
.		.			
.		.			
.		.			
.		.			
.		.			
248	↘	11111000			
249	↘	11111001			
250	↘	11111010			



"Phrase Number / Binary Signal chart" (p. 37)

The phrase number "112" becomes the binary signal "01101111."

**NOTE**

Input of binary specifications should be completed in no more than 50 milliseconds.

# Controlling Another Device with the AR-200 (Control Output Connectors)

You can use the screw-type control input and DC input terminals (CONT A) and the 25-pin D-sub-type control I/O connector (CONT B) on the AR-200's rear panel to control an external device from the AR-200.

The AR-200 outputs two kinds of control signals, Busy Out and Control Out.

This chapter explains how to connect external devices and make the settings for the AR-200.



For examples describing the use of the control input and DC input terminals and the control I/O connector, refer to the "Examples of Usage and Connection for the AR-200" (p. 12).



For more on the control input specifications, refer to "Control I/O Connector specifications" (p. 57) in the Appendices.

## Important Note on Using the Control Input and Output Ports



When making connections to the ports, be careful not to lose the removed screws. Place the screws out of the reach of small children. If a screw is accidentally swallowed, immediately consult a physician.

## Starting Another Device (Busy Out)

### What is the Busy Out Signal?/ Connecting Devices

Busy Out is a continuous signal output from the BUSY OUT connector during playback (as well as during recording and recording standby) of audio phrases, MIDI phrases, pattern phrases, and song phrases.

This signal can be used to start amplifiers and other external devices in sync with phrase playback.

The Busy Out specifications are no-voltage/make-contact, with a make-contact time of 1 second and a contact capacity of a maximum of DC 30 V at 3 A.

Port Nos. 13 and 17 have Make-contact during output.

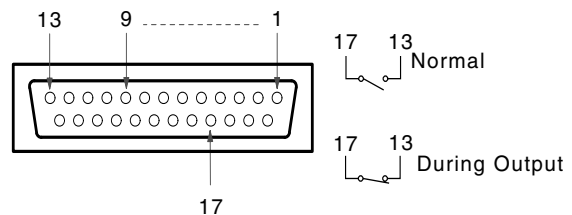

"Important Notes on Making Connections and Switching the Power On and Off" (p. 9)

### Output of Busy Out Signals In Dual Mono Mode (p. 47)

When in Dual Mono mode, the Busy Out signal of the left channel is output from the BUSY OUT connector, and the right channel Busy Out signal is output from the CONT OUT connector.



Dual Mono Mode (p. 47)

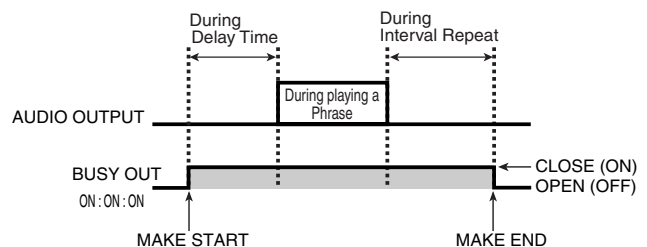

## Controlling Another Device (Control Out)

### What is the Control Out Signal?/ Connecting Devices

The Control Out signal is output for a duration of one second from the CONT OUT connector after playback of audio phrases, MIDI phrases, pattern phrases, and song phrases.

This signal can be used to start amplifiers and other external devices in sync with phrase playback.

You can set the time that is to pass after phrase playback before output is made to anything from 0 seconds to 59 minutes 59 seconds.

Settings are made in phrase units.

The Control Out specifications are no-voltage/make-contact, with a make-contact time of 1 second and a contact capacity of a maximum of DC 30 V at 3 A.

Port Nos. 15 and 18 have Make-contact during output.

#### NOTE

Note that if playback of a phrase in progress is cut off, no Control Out signal is output.

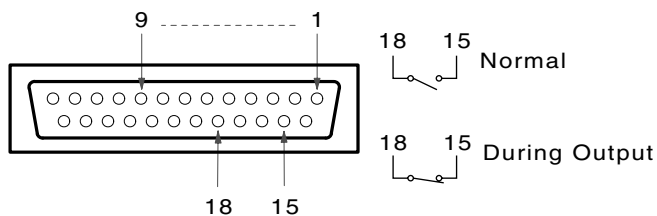

"Important Notes on Making Connections and Switching the Power On and Off" (p. 9)

### Output of Control Out Signals In Dual Mono Mode (p. 47)

Note that Control Out signals are not output in Dual Mono Mode (the Control Out settings are not effective).

In such instances, if the Busy Out output settings have been made, then the Busy Out signal of the left channel is output from the BUSY OUT connector, and right channel's Busy Out signal is output from the CONT OUT connector.

### AR-200 Settings

\* Settings for these parameters cannot be made with the AR-200. Only phrases set on the AR-3000 are effective. For detailed information, please refer to the AR-3000 user's manual.

**MEMO**



AUDIO RECORDER  
**AR-200**

# Applications Guide

(For Use in Conjunction with the AR-3000)

# Controlling the AR-200 with MIDI Signals (MIDI control)

## What is MIDI Control?/What You Can Do Using MIDI Control

MIDI is an acronym for "Musical Instrument Digital Interface," and is a standard by which electronic musical Instruments and computers can exchange musical data. You can connect any device conforming to the MIDI standard with a MIDI cable, and then transmit performance data and control the device's operation and settings.

- You can record and play back MIDI signals from an external MIDI device in the same manner as with audio phrases.
- You can use MIDI signals from an external MIDI device as control signals for controlling playback of audio and MIDI phrases.
- You can use received MMC signals to start and stop recording and playback of audio phrases.

Moreover, by using an optional AR-3000 to create and edit phrases, the following is also possible. For detailed information, please refer to the AR-3000 user's manual.

- You can use MMC and MTC signals from an external MIDI device for remote control and synchronized operation.

## What is MMC (MIDI Machine Control)?

MMC refers to MIDI messages that were devised in accord with certain agreements as to how to facilitate the centralized control of a multiple number of recording devices using one device. In addition to playback, stopping, and fast forwarding of songs, you can also select tracks for recording and carry out other operations merely by operating the one device which functions as the master. Use of MMC signals requires that the other devices be capable of remote operation using MMC signals.

The AR-200 can work as a remote device, starting and stopping recording and playback of audio phrases when MMC signals are received.

However, there is no connection between MMC master (operating device = sending side) and slave (receiving side) and MTC synchronization master and slave.

## What is MTC (MIDI time code)?

MTC consists of MIDI messages that were devised to allow MIDI devices to synchronize correctly with professional-use tape recorders, video equipment, and the like. It differs from MIDI Clock, displaying the absolute time. The master device transmits the current absolute time (in hours/minutes/seconds/frames from the start), and the time of the slave device is advanced to conform with it. Use of MMC signals requires that the other device is capable of synchronization using MTC.

Refer to the "MIDI Implementation" (p. 64) for easy confirmation of the MIDI messages that can be sent and received by the AR-200 along with the more detailed MIDI specifications in "MIDI Implementation" (p. 58).

## Playback of Phrases Using MIDI Signals

MIDI signals from an external MIDI device can be used as control signals in order to play back audio and MIDI phrases. Phrase playback can be controlled by the different types of MIDI messages, including Note On/Off, Note On Velocity, Panpot, and Expression.

- \* *MIDI phrases cannot be played back simultaneously with audio phrases or other MIDI phrases.*

## Connecting External Devices

### When Playing Back Audio Phrases Using MIDI Signals

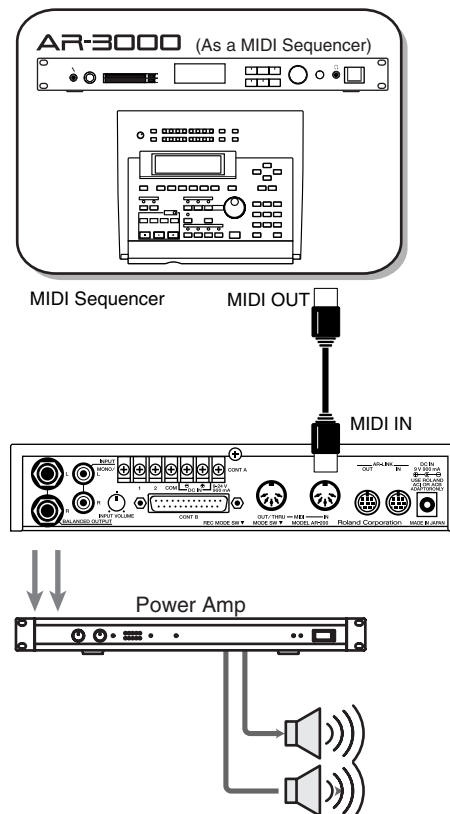

# Controlling the AR-200 with MIDI Signals (MIDI control)

## When Playing Back MIDI Phrases Using MIDI Signals

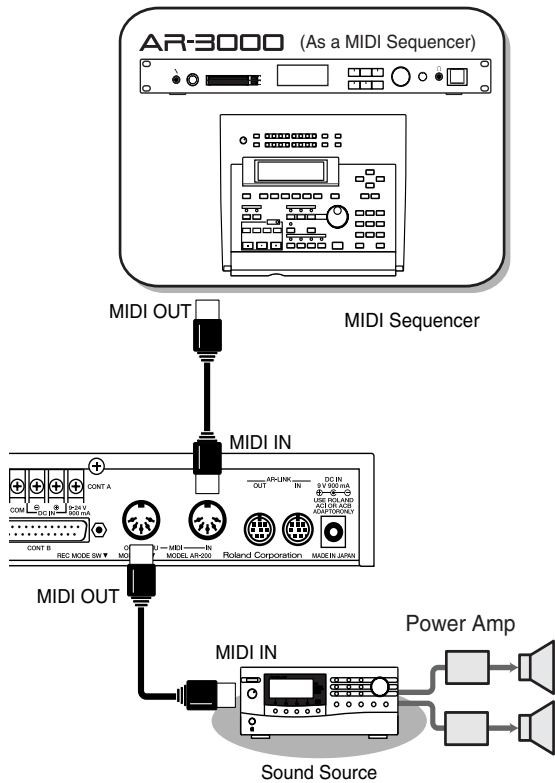

## Assignment of Phrases to Note Numbers (MIDI Note Map)

When a Note On message is sent, the phrase corresponding to the note number is played back. You can specify all phrases by using a Program Change.

### Settings in Effect When a Card Is Formatted

#### Program Change 1

Note No.	Phrase
C-1	A0001
C#-1	A0002
D-1	A0003
:	:
G9	A0128

## MIDI Note Map (Phrase Assignments from Program Changes and Note Numbers)

Program Change	Note No.	Phrase No.
1	C-1 – G9	You can assign 128 phrases however you like
21	C-1 – D#7	A0001 – A0100
22	C-1 – D#7	A0101 – A0200
23	C-1 – D#7	A0201 – A0300
24	C-1 – D#7	A0301 – A0400
25	C-1 – D#7	A0401 – A0500
26	C-1 – D#7	A0501 – A0600
27	C-1 – D#7	A0601 – A0700
28	C-1 – D#7	A0701 – A0800
29	C-1 – D#7	A0801 – A0900
30	C-1 – D#7	A0901 – A1000
2	C-1 – D#7	A0001 – A0100
3	C-1 – D#7	A0101 – A0200
4	C-1 – D#7	A0201 – A0300
5	C-1 – D#7	A0301 – A0400
6	C-1 – D#7	A0401 – A0500
128	C-1 – G9	The phrase being played back is stopped.

< Program Change 1 >

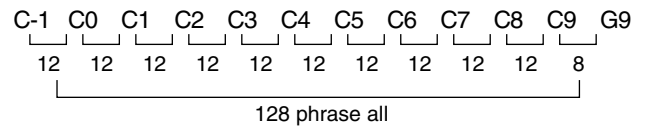

< Program Change 21–30, 71–80, 2–11 >

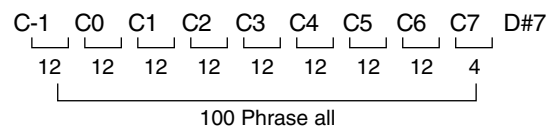

\* By transmitting program change 128, you can then send a Note On message for a note number to interrupt a currently playing phrase.

### AR-200 Settings

#### MIDI Receive channel Settings (MIDI channel)

This sets the MIDI receive channel. MIDI allows you to independently control two or more devices over a single MIDI cable. For example, when the MIDI channel for the sending device is set to "1," then unless the MIDI channel of the receiving device (here, the AR-200) is also set to "1," the MIDI message is not transmitted.

Off : MIDI messages will not playback phrases.

1-16: Only the MIDI messages on the selected channel are received and played back.

All : MIDI messages of any channel will playback phrases.

#### NOTE

With cards formatted on the AR-2000, you can check the MIDI reception channel settings, but they cannot be changed.

#### Procedure for Making the MIDI Receive Channel Settings

1. While holding down the PLAY button, insert the card into the card slot.

The MIDI indicator will blink, and the display will indicate the receive channel.

2. Press the [ ▼ ]/[ ▲ ] dial to select the MIDI Receive channel (OFF/1-16/ALL).
3. Press the PLAY button to set the specified MIDI receive channel.

The MIDI indicator lights, and the phrase number is displayed.

- If you press the STOP button, the MIDI receive channel setting will be canceled.

#### MIDI Control Signals That Can Be Received (Receive Messages)

If you use a card whose settings have been made on the AR-3000, the following MIDI message can be received by the AR-200.

- Note On Velocity: Volume level when playback of the phrase starts
- Panpot (CC10): Changes the positioning of the sound in the left and right channels
- Expression (CC11): Changes the master volume



For more a detailed explanation of MIDI, refer to "MIDI Implementation" and "MIDI Implementation Chart" (p. 58-p. 64).

#### MIDI Note Out

Moreover, by using an optional AR-3000 to create and edit phrases, the following function are also possible.

For detailed information, please refer to the AR-3000 user's manual.

If MIDI Note Out is set to "ON," then when an audio phrase is played back, the MIDI Note Number On/Off signals set in "MIDI Note Map" (p. 43) are output from the MIDI OUT connector.

In this case, if two or more note numbers have been assigned to that playback phrase, only the lowest note number will be transmitted.

The MIDI signals are output through the channel set through the MIDI Receive channel.

If the MIDI Receive channel is set to :

- "OFF": There is no output
- "1-16": Only the MIDI signals in the selected channel are input and output
- "ALL": Output is through Channel 1

\* If you are using Note messages to control two or more AR-200 units, set the MIDI Note Trigger setting of the slave AR-200 units to "Trig." "Trigger" is selected when the card is formatted. However, this setting cannot be changed on the AR-200.

\* Even when playing back MIDI phrases, Note Number On/Off signals are not output.



### AR-200 Settings

#### Selecting the AR-200's Operation (AR-LINK SLAVE)

Set the AR-2000 so as to enable synchronization with AR-LINK.

The AR-200 can only be set to AR-LINK slave.

#### Settings Procedure

1. Turn off the power of the AR-200.
2. Set the MODE switches on the AR-200's bottom panel as shown below.

SW4: ON

3. Turn on the power of the AR-200.

The SLAVE indicator on the front panel lights up.

- \* Use a pointed object to change the ON/OFF settings of the MODE switches.
- \* For more detailed information about synchronized operation with AR-LINK, refer to the AR-3000 Owner's Manual.

# Other Useful Functions During Phrase Playback

Moreover, by using an optional AR-3000 to create and edit phrases, you can also use the following functions.

For detailed information, please refer to the AR-3000 user's manual.

## Playing Data for Two Units on the Left and Right (Dual Mono Mode)

The Dual Mono mode is a feature for playing different mono audio phrases independently on the left and right channels.

By outputting odd-numbered phrases (0001, 0003, ...) from the left channel and even-numbered phrases (0002, 0004, ...) from the right channel, you can play back two units' worth of phrases using only the one device.

You can also play back separate phrases on the left and right channels either simultaneously, or shifted.

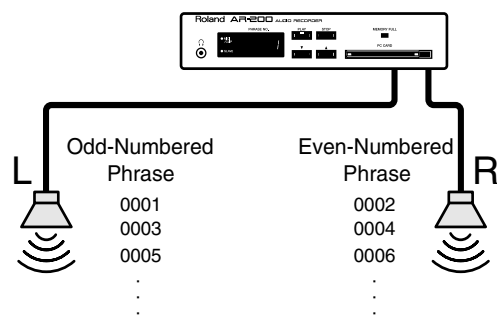

\* You cannot make settings for this parameter on the AR-200. Furthermore, it is effective only with phrases whose settings have been made on the AR-3000. For detailed information, please refer to the AR-3000 user's manual.

### MEMO

#### To Users of the AR-2000/100 (Legacy Models)

On the AR-2000/100 (legacy models), this "Dual Mono Mode" is the function called "Channel Playback Mode." When using them, please try to keep in mind that the two functions are identical.

## Line Out (Thru) Setting During Phrase Playback

You can take audio from Line In, mix it during phrase playback, and mixed it from Line Out (or Line Thru).

CD player or other sound playback device

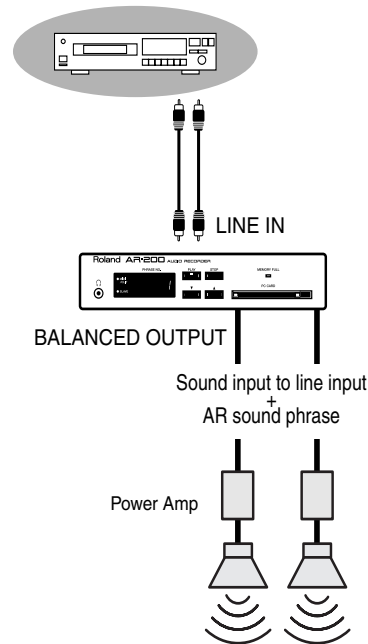

This is useful when you want to do things like taking music from Line In and layering it with narration phrases as background music.

You can also make the Line In sound fade out or in.

### NOTE

Line throughput is possible only for signals connected to the Line In jacks.

## Other Useful Functions During Phrase Playback

### Line Thru Output Specifications

The following output specifications apply, depending on the Line Thru settings.

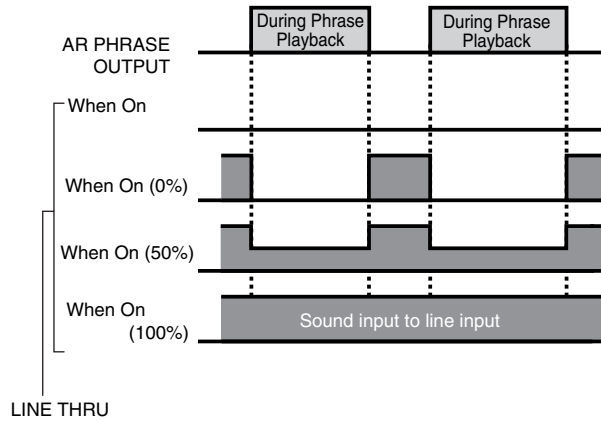

When fade-out or fade-in settings have been made

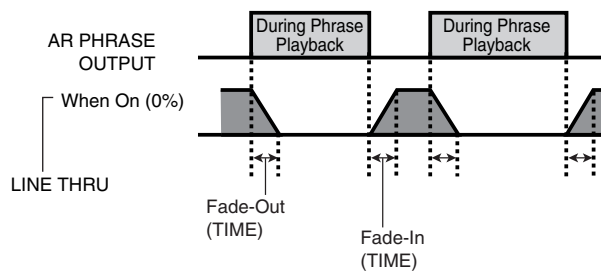

### Adjusting the Sound Quality During Audio Phrase Playback (EQ-Equalizer)

You can adjust the quality of the sound during audio phrase playback with two-band equalization.



AUDIO RECORDER  
**AR-200**

# Appendices

# Troubleshooting

## About recording

### Recording does not start

- In trigger recording, recording starts automatically when the audio input is of a higher level than the trigger level (lever for starting recording). Adjust the input level so that recording is allowed to start.  
→ " **Trigger recording standby.**" (p. 23)

## About playback

### Control Input Playback (Direct/Binary) does not work as intended

- Make sure the MODE switches' settings (Direct/Binary) are selected correctly. You cannot achieve control input playback merely by connecting a device to the port. Be sure to set the control input mode and match the method used for connecting to the connectors.  
→ "MODE SW Settings" (p. 56)

### Phrases in Direct Playback cannot be selected as intended

- When the card is formatted, phrase assignments for Port Nos. 1 through 9 are such that Phrase 0001 is assigned to Port No. 1, Phrase 0002 to Port No. 1, and so on up to Phrase 0001, which is assigned to Port No. 9. Check to make sure that the phrases are properly selected.

### Phrases play repeatedly in Direct Playback

- Check to make sure that "INTERVAL PLAYBACK" is not selected with the MODE switch settings.  
→ "MODE SW Settings" (p. 56)

### The AR-LINK function does not work as intended

- In the AR-LINK settings, is "AR-LINK Mode" set to "Off?"

When using AR-LINK, set this to "Slave" to match your usage conditions. In addition, check the device connections (OUT, IN) for the AR-LINK connector.

## About playback and recording of MIDI phrases

### MIDI phrases cannot be recorded correctly

- Some MIDI sequencers output MIDI sound generator setup messages (tone settings for each part, volume information, effects data, etc.) when a song is selected, and this may prevent MIDI messages from being recorded correctly when recording with the AR-200 begins. In such instances, start recording with the AR-200 first, then after this select and play back the song from the MIDI sequencer.

### MIDI data cannot be recorded

- When recording MIDI data, switch to MIDI Recording mode.  
→ "Recording and Playing MIDI Data (MIDI Phrase)" (p. 26)

### MIDI phrases are not played back

- Is the MIDI Receive channel set to "Off?"  
→ "MIDI Receive channel Settings (MIDI channel)" (p. 44)

## About MIDI Control Playback

### Phrases cannot be played back as intended in MIDI Control Playback

- When a card is formatted, Program Change 1 is set to C-1: 0001-G9:0128. Program Changes 21-30 have Phrases 0001-1000 assigned to them. Phrases 001-500 are assigned to Program Changes 21-30 for compatibility with the AR-2000. Confirm that the phrase you want to play back is correctly specified.
- \* *By transmitting program change 128, you can then send a Note On message for a note number to interrupt a currently playing phrase.*

## Others

### No sound

- Reconfirm that the power to the AR-200 or connected device is on.
- Reconfirm that the volume control on the AR-200 or connected device is turned up.
- Reconfirm that there are no shorts in any connector cables.

### There is a scraping sound coming from the AR-200

- In situations such as when control signals are input continuously, the movement of the internal relays may make a scraping sound, but this does not indicate any malfunction. To prevent overuse and failure of the relay, you may also switch to Interval Playback in order to have the relay move only once.

→ "Interval Playback" (p. 34)

### The volume of the device connected to the output connector is low

- Are you using a connector cable that introduces or adds resistance? Use a cable that does not add resistance (such as Roland's PCS Series).

## Card made on the AR-3000

### Operation cannot be synchronized

- Are the MTC "Sync Source" and "Sync Out" set correctly?

When using the AR-200 as a slave, check to make sure the settings are correctly made for the conditions.

- If using MTC, are both devices set to the same MTC type?
- Check the AR-3000 to confirm that the MIDI device ID settings are correct.

### Phrases are not played back (PLAY indicator is flashing)

- Is the MTC "Sync Source" set to "MTC?"

When not synchronizing playback with MTC and using the AR-200 as a slave, set "Sync Source" on the AR-3000 to "Internal."

### Pattern phrases and song phrases are not played back as intended

- Phrases composed from pattern phrases or song phrases will not be played back properly unless they are saved as actual phrases (if the composed phrase is not saved, the next phrase is sought and then played back). Check the

AR-3000 to confirm whether or not the composite phrase has been saved.

### The start of phrase playback is delayed when playback is controlled from an external device

- Has the "Delay Time" been set for the phrase?

Try playing back the phrase by pressing the AR-200's PLAY button (manual operation). If the start of playback is delayed, check the AR-3000 to confirm whether or not the delay time has been set.

If the playback is correct when you press the AR-200's PLAY button, check the control signals being sent from the external control device, connections and so on once more.

# Error messages

If an incorrect operation is attempted or execution is not possible, an error message will appear in the display. Note the message that appears, and take the appropriate action.

## Er 03

**Situation:** It is possible that the data in the PC card or the PC card itself has been damaged.

**Action:** Delete all phrases (p. 25). If delete card is not possible, or if the same message appears after the card has been delete card, it may be that the PC card is malfunctioning. Use a different PC card.

## Er 04

**Situation:** The card is of a type which the AR-200 is not able to use.

**Action:** Refer to the section "Reccomended PC cards" (p. 66) and use an appropriate PC card.

## Er 05

**Situation:** No more data can be recorded in the card.

**Action:** Either delete unnecessary phrases (p. 25), or use a different card.

## Er 06

**Situation:** Either the phrase data is damaged, or the AR-200 is not able to handle the phrase.

**Action:** Check the phrase for which the message was displayed.

## Er 07

**Situation:** The write protect switch on the PC card is set to the ON position.

**Action:** Refer to the manual for the PC card, and set the write protect switch to the OFF position.

## Er 08

**Situation:** The backup battery in the PC card has run down.

**Action:** Refer to the manual for the PC card and replace the battery.

## Er 09

**Situation:** A large amount of MIDI data was received in a short time, and could not be processed.

**Action:** Change the way in which MIDI data is being transmitted.

## Er 10

**Situation:** Once an Active Sensing message was received, 300 msec elapsed without any message being received.

**Action:** Check the MIDI cable connect or turn off.

## Er 11

**Situation:** The PC card is not formatted for use with the AR-200.

**Action:** Format the PC card.

## Er 12

**Situation:** There is no phrase corresponding to the specified phrase.

**Action:** Select a saved phrase or record a new phrase.

## Er 13

**Situation:** Data was not written to or read from the card in time.

**Action:** Change the RDAC-Grade, RDAC-Mode, or other recording conditions to reduce the amount of data.

## Er 14

**Situation:** Card protect is set to ON, so data cannot be written to the card.

**Action:** Set card protect to OFF.

## Er 15

**Situation:** The AR-200 gets hot.

**Action:** Ventilate well to avoid overheating, and keep the unit cool.

## Er 16

**Situation:** Cannot overwrite or make changes on a card formatted for the AR-2000.

**Action:** Use a card after formatting it on the AR-200, or otherwise use an AR-3000 format card.

## Er 21

**Situation:** Checksum error found in received MIDI data.

**Action:** Check the transmission status and the MIDI data.

# Regarding Cards

## Card Audio Recording Time Chart

The following table shows recording times available for cards formatted for the AR-3000.

\* Recording times listed are for mono recording. Recording times are halved when data is recorded in stereo.

\* These times are for when 1 phrase is recorded continuously, and are provided for your reference when recording. The recording time will depend on the combination of the grade settings of each phrase recorded in each PC card.

PM-004 (4MB)		RDAC-Mode				
		H-LINEAR	LINEAR	MODE3	MODE2*	MODE1
RDAC-Grade	S-HIGH	00:27	00:40	01:48	01:48	02:42
	HIGH	00:29	00:44	01:58	01:58	02:57
	STANDARD	00:40	01:01	02:42	02:42	04:04
	LONG1	00:59	01:28	03:56	03:56	05:54
	LONG2	01:21	02:02	05:25	05:25	08:08
	ANNOUNCE	02:42	04:04	10:51	10:51	16:17

PM-040 (40MB)		RDAC-Mode				
		H-LINEAR	LINEAR	MODE3	MODE2*	MODE1
RDAC-Grade	S-HIGH	04:43	07:04	18:52	18:52	28:18
	HIGH	05:08	07:42	20:32	20:32	30:48
	STANDARD	07:04	10:36	28:18	28:18	42:27
	LONG1	10:16	15:24	41:05	41:05	1:01:38
	LONG2	14:09	21:13	56:36	56:36	1:24:54
	ANNOUNCE	28:18	42:27	1:53:12	1:53:12	2:49:48

PM-008 (8MB)		RDAC-Mode				
		H-LINEAR	LINEAR	MODE3	MODE2*	MODE1
RDAC-Grade	S-HIGH	00:55	01:23	03:42	03:42	05:33
	HIGH	01:00	01:30	04:01	04:01	06:02
	STANDARD	01:23	02:05	05:33	05:33	08:20
	LONG1	02:00	03:01	08:03	08:03	12:05
	LONG2	02:46	04:10	11:06	11:06	16:40
	ANNOUNCE	05:33	08:20	22:13	22:13	33:20

PM-080 (80MB)		RDAC-Mode				
		H-LINEAR	LINEAR	MODE3	MODE2*	MODE1
RDAC-Grade	S-HIGH	09:27	14:10	37:48	37:48	56:42
	HIGH	10:17	15:26	41:09	41:09	1:01:44
	STANDARD	14:10	21:16	56:43	56:43	1:25:04
	LONG1	20:34	30:52	1:22:20	1:22:20	2:03:31
	LONG2	28:21	42:32	1:53:26	1:53:26	2:50:09
	ANNOUNCE	56:42	1:25:04	3:46:52	3:46:52	5:40:18

PM-016 (16MB)		RDAC-Mode				
		H-LINEAR	LINEAR	MODE3	MODE2*	MODE1
RDAC-Grade	S-HIGH	01:52	02:48	07:27	07:27	11:14
	HIGH	02:02	03:03	08:09	08:09	12:14
	STANDARD	02:48	04:12	11:14	11:14	16:51
	LONG1	04:04	06:07	16:18	16:18	24:28
	LONG2	05:37	08:25	22:28	22:28	33:43
	ANNOUNCE	11:14	16:51	44:57	44:57	1:07:26

PM-184 (184MB)		RDAC-Mode				
		H-LINEAR	LINEAR	MODE3	MODE2*	MODE1
RDAC-Grade	S-HIGH	21:46	32:39	1:27:05	1:27:05	2:10:38
	HIGH	23:41	35:32	1:34:48	1:34:48	2:22:11
	STANDARD	32:39	48:59	2:10:38	2:10:38	3:15:57
	LONG1	47:22	1:11:05	3:09:40	3:09:40	4:44:30
	LONG2	1:05:19	1:37:58	4:21:16	4:21:16	6:31:55
	ANNOUNCE	2:10:38	3:15:57	8:42:33	8:42:33	13:03:50

PM-024 (24MB)		RDAC-Mode				
		H-LINEAR	LINEAR	MODE3	MODE2*	MODE1
RDAC-Grade	S-HIGH	02:49	04:13	11:16	11:16	16:55
	HIGH	03:04	04:36	12:16	12:16	18:25
	STANDARD	04:13	06:20	16:55	16:55	25:22
	LONG1	06:08	09:12	24:34	24:34	36:51
	LONG2	08:27	12:41	33:50	33:50	50:45
	ANNOUNCE	16:55	25:22	1:07:41	1:07:41	1:41:31

\*Minimum recording times are listed only for MODE2. Depending on conditions, you may be able to attain recording times longer than listed here.

## Recorded Phrase Data

When a piece of Phrase data recorded by the AR-200, the settings of data on the card will be as follows.

If you will be using the card on the AR-3000, refer to this list.

### Phrase settings

**Playback Volume:** 100

**Delay time:** OFF

### Playback point:

- start: 00h00m00s00f00fsf
- End: The real time of the phrase

**Repeat playback:** OFF

**Loop playback:** OFF

### fade:

- fade in: OFF
- fade out: OFF

**Control output:** OFF

**MIDI playback time:** 120

**Phrase name:** MESSAGE1

(MESSAGE + Phrase number)

## Settings When a Card Is Formatted

When a card is formatted by the AR-200, the settings of the card will be as follows.

If you will be using the card on the AR-3000, refer to this list.

### Recording settings

- Recording jack select: LINE-IN
- RDAC-GRADE: STANDARD
- Recording type: Stereo
- Trigger recording: OFF
- MIDI Time base: 192 (MIDI phrase only)

### Phrase messages

**Playback Volume:** 100

**Delay time:** 00s00f

### Playback point:

- start: 00h00m00s00f00fsf
- End: The real time of the phrase

**Repeat playback:** OFF

**Loop playback:** OFF

### fade:

- fade in: OFF
- fade out: OFF

**Control output:** OFF

**MIDI playback tempo:** 120

**Phrase name:** MESSAGE1  
(MESSAGE + Phrase number)

### Card Edit

**Card protect:** OFF

**card name:** MESSAGE

### Control input settings

**control input MODE:** DIRECT

**Direct playback method:** Normal

- phrase assign

Port No.	Phrase
1	A0001
2	A0002
3	A0003
4	A0004
5	A0005
6	A0006
7	A0007
8	A0008
9	A0009
10	A0010
11	A0011
12	A0012
13	A0013
14	A0014
15	A0015
16	A0016

### Program Playback

Program 1 played back in order

No. 1: Phrase A0001

↓

No.100: Phrase A0100

Programs 2 through 5 played back in order

No. 1: Phrase ----

↓

No.100: Phrase ----

### Binary playback

- Level: ON
- Edge: OFF

### Terminal Rec

- Phrase specify: Binary1

**MIDI settings**

MIDI OUT: OUT  
(MIDI OUT/THRU)

**MIDI note map:**

C-1: Phrase A0001  
↓

G9: PhraseA0128

MIDI note out: OFF

MIDI channel: OFF

MIDI note trigger: Trigger

MIDI receive messages: OFF

- Note on Velocity: OFF
- Panpot: OFF
- Expression: OFF

DEVICE ID: 1

**MTC**

- Sync source: Internal
- Sync out: OFF
- MTC type: 30
- MTC Error level: 5

**MMC Mode**

**RS-232C Settings**

Data transmission speed setting: 9600

**AR-LINK Setting**

AR-LINK Mode: OFF

**System settings**

Dual MONO Mode: OFF(Stereo)

**Line thru setting**

- Line thru select: ON
- Line thru volume level: 0
- Fade out: 0.05
- Fade in: 0.05

**EQ**

- Switch: OFF

Volume thru: Off

**Busy out**

- Delay time: ON
- Phrase playback: ON
- Repeat playback: OFF
- Display Extinguished: OFF

**ETC. settings**

Recording phrase: 250

**AR-3000 settings that can be used**

The following AR-3000 settings can be used by the AR-200. Refer to this list if you will be using a card created by the AR-3000.

Settings Data	With the Card Setting	With the AR-200 Setting
Recording Settings	x	o
Phrase settings(*1)	o	o (*2)
Direct playback setting	o	o (*4)
Program Playback Settings	o	x
Binary Playback Settings	o (*3)	o (*3)
Terminal Rec Settings	o	o (*5)
Dual Mono Mode Settings	o	x
MIDI notes setting	o	x
MIDI receive channel setting	o	o
MIDI note trigger	o	x
MIDI Device ID setting	o	x
Recording phrase	o	o

(\*1) The phrase name will not be displayed on the AR-200.

(\*2) Repeat playback setting of phrase settings will be ignored at Interval Playback.

(\*3) For binary playback, up to 250 phrases can be played back.

(\*4) With Direct Playback, only Reverse Priority is available.

(\*5) Only Binary Recording (equivalent to Terminal Rec Binary2) is possible.

# MODE SW Settings

## MODE Switch Specifications

In addition to the REC MODE switches (p. 20-22), the AR-200's bottom panel also houses the MODE switches. Various applications are possible by changing the settings of the MODE switches.

Each switch is ON when in the upward position, and OFF when in the downward position.

When the AR-200 is shipped from the factory, all switches will be OFF.

\* Use a pointed object to change the ON/OFF settings of the MODE switches.

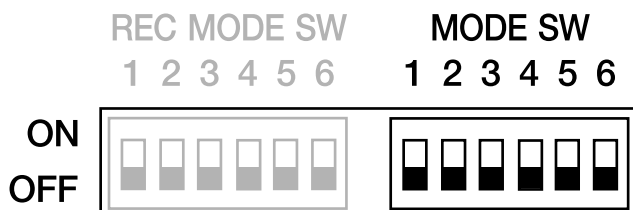

## Playback Mode Settings (SW 1, 2)

The AR-200's playback modes are set by means of varying combinations of ON and OFF settings for SW 1 and 2.

PLAYBACK MODE	SW 1	SW 2
Playback By Card Data	OFF	OFF
Direct Playback (Last-In)	ON	OFF
Binary Playback	OFF	ON
Interval Playback	ON	ON



Types of Control Input Playback (p. 28)

## Output Level Settings (SW 3)

Specifies the output level. Set this in accordance with the specifications for the device to which the playback is being output.

OFF: -10dBV

ON: +4dBu

## AR-LINK Settings (SW 4)

When using AR-LINK, set this to "SLAVE."

OFF: OFF

ON: SLAVE

## Switch Protect Setting (SW 5)

This setting prevents malfunctioning caused when buttons are pressed by mistake. Setting Switch Protect to "ON" disables any action from the buttons on the front panel if they are pressed.

OFF: OFF

ON: ON

## Terminal Rec Settings (SW 6)

When conducting Terminal Rec, set this to "ON."

OFF: OFF

ON: ON



# Control I/O Connector specifications

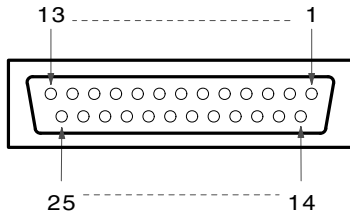

Port No.	Signal Name	
1	1/INC	Control Input
2	2	
3	3/DEC	
4	4	
5	5/EXCHANGE	
6	6	
7	7	
8	8	
9	9/START	
10	STOP	
11	GND	Control Output
12	GND	
13	BUSY OUT	
14	NC	
15	CONT OUT	
16	GND	
17	BUSY OUT	
18	CONT OUT	
19	NC	
20	NC	
21	DC OUT (+5 V, Max :100 mA)	
22	GND	
23	GND	
24	DC IN (+9 – 24 V, 900 mA)	
25	DC IN (+9 – 24 V, 900 mA)	

\* Control Input and DC Input Terminal (CONT A) "1,2" are connected in parallel with Control I/O Connector (CONT B) "1,2."

\* When using Program Playback on a PC card created by the AR-3000, use connectors 1 (INC), 3 (DEC), 5 (EXCHANGE), 9 (START), and 10 (STOP)

\* Do not make any connection to NC pins, since this will cause faulty operation.

## DC power supply

- Power can be supplied to the AR-200 from an external power supply unit (DC power supply) as well as from the AC adaptor.
- To supply power from an external power supply unit (DC power), use the Control Input and DC Input Terminal (CONT A) or the Control I/O Connector (CONT B) DC IN and GND pins.

Power supply specifications:

DC +9—24 V, 900 mA

- The DC OUT pin of the Control I/O Connector (CONT B) can be used as power supply for a sensor, etc.
- \* Never short a power supply pin (21, 24, 25) to the GND pin, since this will damage the unit.
- \* When using the DC OUT, be careful not to exceed the maximum rating (100 mA).

### NOTE

For reasons of safety, do not connect the DC IN + pin of the Control Input and DC Input Terminal (CONT A) to metal parts such as the chassis or the Control I/O Connector (CONT B).

### NOTE

Do not supply electrical power simultaneously to multiple connectors or terminals; doing so may result in damage to the unit.

# MIDI Implementation

Model: AR-200/3000 (Audio Recorder)

Date: Nov.1,2000

Version: 1.00

## 1. Receive data (Media Player Section)

### ■ Channel Voice Message

#### ● Note Off

Status	Second	Third
8nH	kkH	vvH
9nH	kkH	00H

n = MIDI Channel No. : 0H - FH (ch.1 - ch.16)

kk = Note No. : 00H - 7FH (0 - 127)

vv = Velocity : 00H - 7FH (1 - 127)

\* This stops playback of the phrase for the corresponding note number. (For more on the corresponding phrases, refer to the Note On parameter.)

\* This is ignored when "Trigger" is selected for MIDI Trigger Mode.

\* The Note Off Velocity value is ignored.

\* Data is not received if the MIDI Receive channel setting is OFF. When set to 1-16, data is received only on the selected channel. When set to ALL, data is received on all channels.

#### ● Note On

Status	Second	Third
9nH	kkH	vvH

n = MIDI Channel No. : 0H - FH (ch.1 - ch.16)

kk = Note No. : 00H - 7FH (0 - 127)

vv = Velocity : 01H - 7FH (1 - 127)

\* This plays back the phrase for the corresponding note number.

\* With Program Change 1 (normally turning the power on), all note numbers (128 numbers) are received. Corresponding phrase numbers may be selected freely.

\* With Program Changes 21-30, only Note Numbers 00H-63H (0-99) are received. The phrase numbers correspond to 1-1000 on Card A. Phrase assignments cannot be changed.

\* With Program Changes 71 through 80, only Note Numbers 00H through 63H (0 through 99) are received. The phrase numbers correspond to 1 through 1,000 on Card B (AR-3000 only). Phrase assignments cannot be changed.

\* With Program Changes 2-6 and 7-11, only Note Numbers 00H-63H (0-99) are received. The phrase numbers correspond to 1-500 on Card A and 1-500 on Card B (AR-3000 only) respectively. Phrase assignments (AR-2000 compatible) cannot be changed.

\* With Program 128, playback of the phrase in progress is stopped, regardless of the note number.

\* Data is not received if the MIDI Receive channel setting is "OFF." When set to 1-16, data is received only on the selected channel. When set to ALL, data is received on all channels.

\* The Note On Velocity value changes the playback master volume.

\* The Note On Velocity value is ignored in Dual Mono mode and MIDI playback.

\* The Note On Velocity value is ignored when Note On Velocity is set to "Off."

#### ● Control Change

##### ○ Panpot (Controller number 10)

Status	Second	Third
BnH	OAH	vvH

n = MIDI Channel No. : 0H - FH (ch.1 - ch.16)

vv = Panpot : 00H - 7FH (0 - 127)

(0-64-127)

default value = 40H(64)

\* This is adjustable in 127 steps, with 0 being full left, 64 center, and 127 full right.

\* When Panpot is off, this is not received.

\* When MIDI playback is conducted in Dual Mono mode, this is not received.

\* Data is not received if the MIDI Receive channel setting is "OFF." When set to 1-16, data is received only on the selected channel. When set to ALL, data is received on all channels.

##### ○ Expression (Controller number 11)

Status	Second	Third
BnH	0BH	vvH

n = MIDI Channel No. : 0H - FH (ch.1 - ch.16)

vv = Expression : 00H - 7FH (0 - 127)

default value = 7FH (127)

\* This changes the volume level during playback of a phrase.

\* When Expression is off, this is not received.

\* When MIDI playback is conducted in Dual Mono mode, this is not received.

\* Data is not received if the MIDI Receive channel setting is "OFF." When set to 1-16, data is received only on the selected channel. When set to ALL, data is received on all channels.

#### ● Program Change

Status	Second
--------	--------

CnH ppH

n = MIDI Channel No. : 0H - FH (ch.1 - ch.16)

pp = Program number : 00H - 05H (prog.1 - prog.6)

: 06H - 0AH (prog.7 - prog.11) \*Only AR-3000

: 14H - 1DH (prog.21 - prog.11)

: 46H - 4FH (prog.71 - prog.80)

: 7FH (prog.128)

\* This switches the MIDI note map used for the phrase assignments.

\* The change goes into effect with the first new Note On after the Program Change is received. This has no effect on phrases being played before the Program Change is received.

\* Data is not received if the MIDI Receive channel setting is OFF. When set to 1-16, data is received only on the selected channel. When set to ALL, data is received on all channels.

### ■ System Common Message

#### ● Quarter Frame Messages

\* Data is received when Sync Source is set to "MTC." When the Quarter Frame message is received, operation proceeds with the start of the song synchronized to "00h00m00s00f00" with the "MTC Offset" and the "Delay Time" added.

\* This acts upon the currently selected audio phrase.

\* MIDI phrases and pattern phrases are ignored when Dual Mono mode is selected.

Status	Second
--------	--------

F1H mmH (= 0nnndddd)

nnn = Message type: 0 = Frame count LS nibble

1 = Frame count MS nibble

2 = Seconds count LS nibble

3 = Seconds count MS nibble

4 = Minutes count LS nibble

5 = Minutes count MS nibble

6 = Hours count LS nibble

7 = Hours count MS nibble

dddd = 4 bit nibble data : 0h - FH (0 - 15)

Bit Field is assigned as follows.

Frame Count xxxxyyyy

xxx Reserved (000)

yyyyy Frame No.(0-29)

Seconds Count xxxyyyyy

xx Reserved (00)

yyyyyy Seconds (0-59)

Minutes Count xxxyyyyy

xx Reserved (00)

yyyyyy Minutes (0-59)

Hours Count xyyzzzzz

x Reserved (0)

yy Time Code type

0 = 24 Frames / Sec

1 = 25 Frames / Sec

2 = 30 Frames / Sec (Drop Frame)

3 = 30 Frames / Sec (Non Drop Frame)

zzzzz Hours (0-23)

#### ■ System Exclusive Message

Status	Data Bytes	Status
--------	------------	--------

F0H iiH, ddH,..., eeH F7H

FOH :System Exclusive Message status

iiH ID Number :an ID number (manufacturer ID) to indicate the manufacturer whose Exclusive message this is. Roland's manufacturer ID is 41H.

ID numbers 7EH and 7FH are extensions of the MIDI standard; Universal Non-Real time Messages (7EH) and Universal Real time Messages (7FH).

::

dd,..., ee = Data : 00H-7FH (0-127)

F7H : EOX (End of Exclusive Message)

The system Exclusive Messages received by the AR-200/3000 are; Data Set (DT1).

Regarding the Data Set (DT1), please refer to "exclusive Communication".

## ● MIDI Time Code

### ○ Full Messages

\* Data is received when Sync Source is set to "MTC." When the Quarter Frame message is received, operation proceeds with the start of the song synchronized to "00h00m00s00f00" with the "MTC Offset" and the "Delay Time" added.

\* This acts upon the currently selected audio phrase.

\* MIDI phrases and pattern phrases are ignored when Dual Mono mode is selected.

Status	Data Bytes	Status
F0H	7FH, dev, 01H, 01H, 06H, 01H, hrH, mnH, scH, frH	F7H

Byte	Description
F0H	Status of Exclusive Message
7FH	Universal System Exclusive Message Real time Header
dev	device ID (or 7FH)
01H	sub-ID#1 (MIDI Time Code)
01H	sub-ID#1 (Full Messages)
06H	number of bytes
01H	[TARGET] sub command
hrH	Hours Count xyzzzzz x Reserved (0) yy Time Code type 0 = 24 Frames / Sec 1 = 25 Frames / Sec 2 = 30 Frames / Sec (Drop Frame) 3 = 30 Frames / Sec (Non Drop Frame) zzzzz Hours (0-23)
mnH	Minutes Count xyyyyyy xx Reserved (00) yyyyyy Minutes (0-59)
scH	Seconds Count xyyyyyy xx Reserved (00) yyyyyy Seconds (0-59)
frH	Frame Count xyyyyyy xxx Reserved (000) yyyyy Frame No.(0-29)
F7H	EOX (End of Exclusive)

## ● MIDI Machine Control (MMC)

\* This is Received when the MMC mode is set to "SLAVE."

\* This acts upon the currently selected phrase.

### ○ STOP (MCS)

Status	Data Bytes	Status
F0H	7FH, dev, 06H, 01H	F7H

Byte	Description
F0H	Status of Exclusive Message
7FH	Universal System Exclusive Message Real time Header
dev	device ID (or 7FH)
06H	MMC Command Message
01H	STOP (MCS)
F7H	EOX (End of Exclusive Message)

\* Playback is stopped immediately when this command is received if the device ID matches, or if 7FH is received.

### ○ PLAY (MCS)

Status	Data Bytes	Status
F0H	7FH, dev, 06H, 02H	F7H

Byte	Description
F0H	Status of Exclusive Message
7FH	Universal System Exclusive Message Real time Header
dev	device ID (or 7FH)
06H	MMC Command Message
02H	PLAY (MCS)
F7H	EOX (End of Exclusive Message)

\* Playback is started immediately when this command is received if the device ID matches, or if 7FH is received.

### ○ DEFERRED PLAY (MCS)

Status	Data Bytes	Status
F0H	7FH, dev, 06H, 03H	F7H

Byte	Description
F0H	Status of Exclusive Message
7FH	Universal System Exclusive Message Real time Header
dev	device ID (or 7FH)
06H	MMC Command Message
03H	DEFERRED PLAY (MCS)
F7H	EOX (End of Exclusive Message)

\* Playback is started immediately when this command is received if the device ID matches, or if 7FH is received.

### ○ RECORD STROBE (MCS)

Status	Data Bytes	Status
F0H	7FH, dev, 06H, 06H	F7H

Byte	Description
F0H	Status of Exclusive Message
7FH	Universal System Exclusive Message Real time Header
dev	device ID (or 7FH)
06H	MMC Command Message
06H	RECORD STROBE (MCS)
F7H	EOX (End of Exclusive Message)

\* Recording of the phrase begins when this command is received if the device ID matches, or if 7FH is received.

\* If MIDI signal recording is in effect, this command is ignored (MIDI cannot be recorded with MMC).

### ○ RECORD EXIT (MCS)

Status	Data Bytes	Status
F0H	7FH, dev, 06H, 07H	F7H

Byte	Description
F0H	Status of Exclusive Message
7FH	Universal System Exclusive Message Real time Header
dev	device ID (or 7FH)
06H	MMC Command Message
06H	RECORD STROBE (MCS)
F7H	EOX (End of Exclusive Message)

\* Recording is stopped immediately when this command is received if the device ID matches, or if 7FH is received.

\* If MIDI signal recording is in effect, this command is ignored (MIDI cannot be recorded with MMC).

### ○ LOCATE (MCP)

Format 2 - LOCATE [TARGET]

Status	Data Bytes	Status
F0H	7FH, dev, 06H, 44H, 06H, 01H, hrH, mnH, scH, frH, ffH	F7H

Byte	Description
F0H	Status of Exclusive Message
7FH	Universal System Exclusive Message Realtime Header
dev	device ID (or 7FH)
06H	MMC Command Message
44H	LOCATE(MCP)
06H	Number of Bytes
01H	[TARGET] sub command
hrH	Standard time with Sub Frame
mnH	
scH	
frH	
ffH	
F7H	EOX (End of Exclusive Message)

\* If the device ID matches, or if 7FH is received, then when this command is received, the location of the time code specified in the command data is located.

\* MIDI phrases and pattern phrases are ignored when Dual Mono mode is selected.

## 2. Transmitted data (Media Player Section)

### 2.1 Transmitted messages while a phrase is being played back

The stored MIDI message are transmitted When the MIDI phrase will playback after OUT is set in the MIDI OUT.

In this case, AR-200/3000 is not transmitted MIDI messages which are received.

### 2.2 Transmitted message which are received.

When THRU is set in the MIDI OUT, AR-200/3000 transmits message which are received.

### 2.3 Transmitted message which are produced.

When OUT is set in the MIDI OUT, AR-200/3000 transmits the following produced messages.

#### ■ Channel Voice Message

##### ● Note Off

Status	Second	Third
8nH	kkH	40H

n = MIDI Channel No.: 0H -- FH (ch.1--ch.16)

kk = Note No.: 00H--7FH (0--127)

\* After the MIDI Phrase is stopped, AR-200/3000 produces Note off message for received notes remains on.

\* When Note On is sent at the start of an audio performance, the same note number as that of the Note On is transmitted. For more information about sending notes, refer to the Note On section below.

##### ● Note ON

Status	Second	Third
9nH	kkH	7FH

n = MIDI Channel No.: 0H--FH (ch.1--ch.16)

kk = Note No.: 00H--7FH (0--127)

\* At the start of the audio phrase performance, the note number defined in the MIDI note map is sent. In this instance, if multiple note numbers are selected in the phrase, only the lowest note number is transmitted.

\* There is no transmission when the Note Send setting is set to "OFF" (Note Send settings are available only with the AR-3000).

\* Data is not output if the MIDI Receive channel setting is "OFF." When set to 1-16, data is transmitted only on the selected channel. When set to ALL, data is transmitted on Channel 1.

\* There is no transmission during playback of MIDI phrases.

##### ● Control Change

###### ○ Hold1 OFF

Status	Second	Third
BnH	40H	00H

n = MIDI Channel No.: 0H--FH (ch.1--ch.16)

\* \*After the MIDI Phrase is stopped, AR-200/3000 produces Note off message for received notes remains on.

#### ■ Channel Mode Message

##### ● All Note Off (Controller No. 1 2 3)

Status	Second	Third
BnH	7BH	00H

n = MIDI channel No.: 0H--FH (ch.1--ch.16)

\* Transmitted message while a phrase is being played back.

## 2.4 Recognized message for sync

#### ■ System Realtime Message

##### ● Timing Clock

status

F8H

\* Transmitted message while a phrase is being played back.

##### ● Start

status

FAH

##### ● Stop

status

FCH

#### ■ System Common Message

##### ● Quarter Frame

\* This is transmitted when Sync Out is set to "MTC." The time count transmitted is the time with the start of the song set to "00h00m00s00f00" with the "MTC Offset" and the "Delay Time" added.

\* MIDI phrases and pattern phrases are not transmitted when Dual Mono mode is selected.

status

second

F1H

mmH (= 0nnndddd)

Regarding the Quarter Frame, please refer to "Receive data (Media Player Section) ~Quarter Frame~".

#### ■ System Exclusive Message

##### ● MIDI Time Code

###### ○ Full Message

\* This is transmitted when Sync Out is set to "MTC" and the location of the phrase is moved. The time count transmitted is the time with the start of the song set to "00h00m00s00f00," and the "MTC Offset" and the "Delay Time" added.

\* MIDI phrases and pattern phrases are not transmitted when Dual Mono mode is selected.

Status	Data Bytes	Status
F0H	7FH, dev, 01H, 01H	F7H
	hrH, mnH, scH, frH	

Regarding the MIDI Time Code, please refer to "Receive data (Media Player Section) ~MIDI Time Code~".

##### ● MIDI Machine Control (MMC)

\* Data is transmitted when MMC mode is set to "MASTER."

###### ○ STOP (MCS)

Status	Data Bytes	Status
F0H	7FH, dev, 06H, 01H	F7H
Byte	Description	
F0H	Status of System Exclusive Message	
7FH	Universal System Exclusive Message Real time Header	
dev	device ID	
06H	MMC Command Message	
01H	STOP (MCS)	
F7H	EOX (End of System Exclusive Message)	

\* When "STOP" is pressed, a Device ID of 7FH is transmitted.

###### ○ DEFERRED PLAY (MCS)

Status	Data Bytes	Status
F0H	7FH, dev, 06H, 01H	F7H
Byte	Description	
F0H	Status of System Exclusive Message	
7FH	Universal System Exclusive Message Real time Header	
dev	device ID (or 7FH)	
06H	MMC Command Message	
03H	DEFERRED PLAY (MCS)	
F7H	EOX (End of System Exclusive Message)	

\* When "START" is pressed, a Device ID of 7FH is transmitted.

###### ○ RECORD STROBE (MCS)

Status	Data Bytes	Status
F0H	7FH, dev, 06H, 07H	F7H
Byte	Description	
F0H	Status of System Exclusive Message	
7FH	Universal System Exclusive Message Real time Header	
7FH	device ID (or 7FH)	
06H	MMC Command Message	
06H	RECORD STROBE (MCS)	
F7H	EOX (End of System Exclusive Message)	

\* When recording of a phrase begins, a Device ID of 7FH is transmitted.

###### ○ RECORD EXIT (MCS)

Status	Data Bytes	Status
F0H	7FH, dev, 06H, 07H	F7H
Byte	Description	
F0H	Status of System Exclusive Message	
7FH	Universal System Exclusive Message Real time Header	
dev	device ID	
06H	MMC Command Message	
07H	RECORD EXIT	
F7H	EOX (End of System Exclusive Message)	

\* When recording of a phrase is stopped, a Device ID of 7FH is transmitted

## ○ LOCATE (MCP)

format2 - LOCATE [TARGET]

Status	Data Bytes	Status
F0H	7FH, dev, 06H, 44H, 06H	F7H
	01H, hrH, mnH, scH, frH, ffH	
Byte	Description	
F0H	Status of System Exclusive Message	
7FH	Universal System Exclusive Message Real time Header	
dev	device ID (or 7FH)	
06H	MMC Command Message	
44H	LOCATE (MCP)	
06H	Number of byte	
01H	[TARGET] sub command	
hrH	Standard time with Sub Frame	
mnH		
scH		
frH		
ffH		
F7H	EOX (End of System Exclusive Message)	

\* When the location is moved, a Device ID of 7FH is transmitted.

\* MIDI phrases and pattern phrases are not transmitted when Dual Mono mode is selected.

## 3. Receive data (MIDI Recorder Section)

### 3.1 Message memorized during recording

#### ■ Channel Voice Message

##### ● Note Off

Status	Second	Third
8nH	kkH	vvH
9nH	kkH	00H

n = MIDI Channel No. : 0H - FH (ch.1 - ch.16)  
 kk = Note No. : 00H - 7FH (0 - 127)  
 vv = Velocity : 00H - 7FH (1 - 127)

##### ● Note On

Status	Second	Third
9nH	kkH	vvH

n = MIDI Channel No. : 0H - FH (ch.1 - ch.16)  
 kk = Note No. : 00H - 7FH (0 - 127)  
 vv = Velocity : 01H - 7FH (1 - 127)

##### ● Polyphonic Key Pressure

Status	Second	Third
AnH	kkH	vvH

n = MIDI Channel No. : 0H - FH (ch.1 - ch.16)  
 kk = Note No. : 00H - 7FH (0 - 127)  
 vv = value : 00H - 7FH (0 - 127)

##### ● Control Change

status	Second	Third
BnH	kkH	vvH

n = MIDI Channel No. : 0H - FH (ch.1 - ch.16)  
 kk = Controller No. : 00H - 7FH (0 - 127)  
 vv = value : 00H - 7FH (0 - 127)

##### ● Program Change

Status	Second	Third
CnH	ppH	vvH

n = MIDI Channel No. : 0H - FH (ch.1 - ch.16)  
 pp = Program No. : 00H - 7FH (0 - 127)

##### ● Channel Pressure

Status	Second
BnH	kkH

n = MIDI Channel No. : 0H - FH (ch.1 - ch.16)  
 vv = value : 00H - 7FH (0 - 127)

##### ● Pitch Bend Change

Status	Second
EnH	llH

n = MIDI Channel No. : 0H - FH (ch.1 - ch.16)

#### ■ Channel Mode Message

##### ● All Sound Off

Status	Second	Third
BnH	78H	00H

n = MIDI channel No. : 0H - FH (ch.1 --ch 16)

##### ● Reset All Controller

Status	Second	Third
BnH	78H	00H

n = MIDI channel No. : 0H - FH (ch.1 --ch 16)

##### ● Local On / Off

Status	Second	Third
BnH	7AH	vvH

n = MIDI channel No. : 0H - FH (ch.1 --ch 16)  
 vv = value : 00H, 7FH (OFF, ON)

##### ● MONO

Status	Second	Third
BnH	7EH	mmH

n = MIDI channel No. : 0H - FH (ch.1 --ch 16)  
 mm = mono number : 00H - 10H (0 - 16)

\* The same processing will be carried out as when All Notes Off is received.

##### ● POLY

Status	Second	Third
BnH	7EH	00H

n = MIDI channel No. : 0H - FH (ch.1 --ch 16)  
 mm = mono number : 00H - FH (0 - 16)

\* The same processing will be carried out as when All Notes Off is received.

#### ■ System Exclusive Message

Status	Data Bytes	Status
F0H	iiH, ddH,..., eeH	F7H
FOH	:System Exclusive Message status	
iiH ID Number	:an ID number (manufacturer ID) to indicate the manufacturer whose Exclusive message this is. Roland's manufacturer ID is 41H. ID numbers 7EH and 7FH are extensions of the MIDI standard; Universal Non-real time Messages (7EH) and Universal Real time Messages (7FH).	
dd,..., ee = Data :	00H-7FH (0-127)	
F7H :	EOX (End of Exclusive Message)	

### 3.2 Message not memorized during recording

#### ■ Channel Mode Message

##### ● All Note Off

Status	Second	Third
BnH	78H	00H

n = MIDI channel No. : 0H - FH (ch.1 --ch 16)

\* Note Off is generated for any note not set to OFF, and this note off is stored.

##### ● OMNI OFF

Status	Second	Third
BnH	78H	00H

n = MIDI channel No. : 0H - FH (ch.1 --ch 16)

\* The same processing will be carried out as when All Notes Off is received.

##### ● OMNI ON

Status	Second	Third
BnH	7AH	vvH

n = MIDI channel No. : 0H - FH (ch.1 --ch 16)  
 vv = value : 00H, 7FH (OFF, ON)

\* The same processing will be carried out as when All Notes Off is received.

### 3.3 Recognized message for remote control

#### ■ System Real time Message

##### ● Start

status
F8H

\* Not received when recording mode is not "Standby".

##### ● Continue

status
FBH

# MIDI Implementation

- \* Not received when recording mode is not "Standby".
- \* The same processing will be carried out as when Start is received.

## ● Stop

status  
FCH

- \* Not received when recording mode is not "record".

## 3.4 Messages received for detecting trouble in MIDI connection.

### ■ System Realtime message

#### ● Active Sensing

Status  
FEH

- \* When Active Sensing is received, the unit will begin monitoring the intervals of all further messages. While monitoring, if the interval between messages exceeds 400 ms, the same processing will be carried out as when All Sounds Off, All Notes Off and Reset All Controllers are received, and message interval monitoring will be halted.

## 4. Transmit data (MIDI Recorder Section)

When AR-200/3000 is in MIDI Recorder mode, MIDI Messages is not transmitted.

## 5. Exclusive Communication

Exclusive message model IDs that can be used on the AR-200 and AR-3000 are OOH, 38H (AR-200), 00H, and 37H (AR-3000). The Device Id can be set to 00H to 1FH.

Only received when AR-200/3000 is in Media Player Section.

### ● Data Set 1 DT1 (12H)

Byte	Description
F0H	Status of System Exclusive Message
41H	Universal System Exclusive Message Real time Header
dev	device ID (dev : 00H-1FH)
mdl	Model ID (mdl : 00H, 38H) AR-200 (mdl : 00H, 37H) AR-3000
12H	Command ID (DT1)
aaH	address MSB
:	:
ddH	Address LSB
eeH	Data
:	:
llH	Data
sum	Check Sum
F7H	EOX (End of System Exclusive Message)

## 5.1 Parameter Address Map

This map indicates address, size, data (range), Parameter, Description, and default Value of parameters which can be transferred using "Data Set1(DT1)."

All the numbers of address, size, Data, and default Value are indicated in 7-bit Hexadecimal-form.

(AR-200 Model ID=00H,38H)

(AR-3000 Model ID=00H,37H)

### ■ Address Block Map

An outlined address map of the Exclusive Communication is as follows;

#### ○ Exclusive Address Table for recording setting (Only AR-3000)

Address(H)	SIZE(H)	DATA(H)	Parameter	Description
00 00 10	00 00 08	00 - 07	Phrase Number	upper 4bits
11#		00 - 7f	Phrase Number	lower 7bits
12#		00 - 04	Grade	0:ANNOUNCE 1:LONG2 2:LONG1 3:STANDARD 4:HIG 5:S-HIGH 6:MASTER
13#		00 - 02	R-DAC mode	0:Linear 1:Mode1 2:Mode2 3:Mode3 4:H-LINEAR
14#		00 - 01	REC type	0:MONO 1:STEREO

15#	00 - 03	REC Trigger Level	0:OFF 1:LOW 2:MID 3:HIG
16#	00 - 02	REC Source	0:ANALOG-IN 1:DIGITAL-IN 2:MIDI-IN
17#	00 - 01	TimeBase	0:192 1:240

Phrase number	DATA(H)
A0001-A1000	00 00 - 07 67
B0001-B1000	07 68 - 0H 4F

- \* Only received packet data.
- \* When reception of this packet is completed, the AR-3000 goes into REC PAUSE mode. However, if the phrase already exists, the AR-3000 ignores this SysEx message.

(AR-2000 compatible)

Address(H)	SIZE(H)	DATA(H)	Parameter	Description
00 00 00	00 00 08	00 - 07	Phrase Number	upper 3bits
01#		00 - 7f	Phrase Number	lower 7bits
02#		00 - 04	Grade	0:ANNOUNCE 1:LONG2 2:LONG1 3:STANDARD 4:HIG
03#		00 - 02	R-DAC mode	0:Linear 1:Mode1 2:Mode2
04#		00 - 01	REC type	0:MONO 1:STEREO
05#		00 - 03	REC Trigger Level	0:OFF 1:LOW 2:MID 3:HIG
06#		00 - 01	REC Source	0:ANALOG-IN (MIDI REC OFF) 1:MIDI-IN (MIDI REC ON)
07#		00 - 01	TimeBase	0:192 1:240

Phrase number	DATA(H)
A0001 - A0500	00 00 - 03 73
B0001 - B0500	03 74 - 07 67

- \* Only received packet data.
- \* When reception of this packet is completed, the AR-3000 goes into REC PAUSE mode. However, if the phrase already exists, the AR-3000 ignores this SysEx message.

○ Exclusive Address Table Recording setting (Replacement Recording)

Address(H)	SIZE(H)	DATA(H)	Parameter	Description
00 01 10	00 00 08	00 - 07	Phrase Number	upper 4bits
11#		00 - 7f	Phrase Number	lower 7bits
12#		00 - 04	Grade	0:ANNOUNCE 1:LONG2 2:LONG1 3:STANDARD 4:HIGH
13#		00 - 02	R-DAC mode	5:S-HIGH 0:Linear 1:Mode1 2:Mode2 3:Mode3 4:H-Linear
14#		00 - 01	REC type	0:MONO 1:STEREO
15#		00 - 03	REC Trigger Level	0:OFF 1:LOW 2:MID 3:HIGH
16#		00 - 02	REC Source	0:ANALOG-IN 1:DIGITAL-IN 2:MIDI-IN
17#		00 - 01	TimeBase	0:192 1:240

Phrase number	DATA(H)
A0001 - A1000	00 00 - 07 67
B0001 - B1000	07 68 - 0F 4F

- \* Only received packet data.
- \* When reception of this packet is completed, the AR-3000 goes into REC PAUSE mode. However, if a phrase has already been saved, the AR-3000 deletes that phrase and goes into REC PAUSE mode.

(AR-2000 compatible)

Address(H)	SIZE(H)	DATA(H)	Parameter	Description
00 01 00	00 00 08	00 - 07	Phrase Number	upper 3bits
01#		00 - 7f	Phrase Number	lower 7bits
02#		00 - 04	Grade	0:ANNOUNCE 1:LONG2 2:LONG1 3:STANDARD 4:HIGH
03#		00 - 02	R-DAC mode	0:Linear 1:Mode1 2:Mode2
04#		00 - 01	REC type	0:MONO 1:STEREO
05#		00 - 03	REC Trigger Level	0:OFF 1:LOW 2:MID 3:HIGH
06#		00 - 01	REC Source	0:ANALOG-IN (MIDI REC OFF) 1:MIDI-IN (MIDI REC ON)
07#		00 - 01	TimeBase	0:192 1:240

Phrase number	DATA(H)
A0001 - A0500	00 00 - 03 73
B0001 - B0500	03 74 - 07 67

- \* Only received packet data.
- \* When reception of this packet is completed, the AR-3000 goes into REC PAUSE mode. However, if a phrase has already been saved, the AR-3000 deletes that phrase and goes into REC PAUSE mode.

○ Exclusive Address Table Phrase Select AR-200/3000

Address(H)	SIZE(H)	DATA(H)	Parameter	Description
01 00 10	00 00 02	00 - 07	Phrase Number	upper 4bits
11#		00 - 7f	Phrase Number	lower 7bits

Phrase number	DATA(H)
A0001 - A1000	00 00 - 07 67 (AR-200/AR-3000)

B0001 - B1000 07 68 - 0F 4F (AR-3000)

- \* Only received packet data.
- \* V

(AR-100/2000 compatible)

Address(H)	SIZE(H)	DATA(H)	Parameter	Description
01 00 00	00 00 02	00 - 07	Phrase Number	upper 3bits
01#		00 - 7f	Phrase Number	lower 7bits

Phrase number	DATA(H)
A0001 - A0500	00 00 - 03 73 (AR-200/AR-3000)
B0001 - B0500	03 74 - 07 67 (AR-3000)

- \* Only received packet data.
- \* When reception of this packet is completed, the AR-200/3000 changes to the current (currently displayed) phrase number.

○ Exclusive Address Table Recording Settings AR-200/3000

Address(H)	SIZE(H)	DATA(H)	Parameter	Description
01 00 10	00 00 03	00 - 07	Phrase Number	upper 4bits
11#		00 - 7f	Phrase Number	lower 7bits
12#		00 - 02	REC Source	0:ANALOG-IN 1:DIGITAL-IN 2:MIDI-IN

Phrase number	DATA(H)
A0001 - A1000	00 00 - 07 67 (AR-200/AR-3000)
B0001 - B1000	07 68 - 0F 4F (AR-3000)

- \* Only received packet data.
- \* When reception of this packet is completed, the AR-3000 goes into REC PAUSE mode. However, if a phrase has already been saved, the AR-3000 deletes that phrase and goes into REC PAUSE mode.

(AR-100/2000 compatible)

Address(H)	SIZE(H)	DATA(H)	Parameter	Description
01 00 00	00 00 03	00 - 07	Phrase Number	upper 3bits
01#		00 - 7f	Phrase Number	lower 7bits
02#		00 - 02	REC Source	0:ANALOG-IN (MIDI REC OFF) 1:MIDI-IN (MIDI REC ON)

Phrase number	DATA(H)
A0001 - A0500	00 00 - 03 73 (AR-200/AR-3000)
B0001 - B0500	03 74 - 07 67 (AR-3000)

- \* Only received packet data.
- \* When reception of this packet is completed, the AR-3000 goes into REC PAUSE mode. However, if a phrase has already been saved, the AR-3000 deletes that phrase and goes into REC PAUSE mode.

# MIDI Implementation Chart

## Media Player Section

Function ...		Transmitted	Recognized	Remarks
Basic Channel	Default Changed	All channels x	*1 x 1-16	Memorized
Mode	Default Message Altered	x x *****	x x *2 *2	
Note Number :	True Voice	0-127 *****	x x *2	
Velocity	Note ON Note OFF	o o	*1 *1 x x	
After Touch	Key's Ch's	o o	x x	
Pitch Bend		o	x	
Control Change	10 11 0-119	o *1 *1 *1	x *2 *2 x	Panpot Expression Messages other than the above
Program Change :	True #	o *****	*1 x 1-6, 21-30	*2 Program number : 1-11, 21-30, 71-80, 128
System Exclusive		o	*1 o	
System Common	: Quarter Frame : Song Pos : Song Sel : Tune	x x x x	*3 x x x x	*4
System Real Time	: Clock : Commands	o o	*1 x x	
Aux Messages	: All Sounds OFF : Reset All Controllers : Local ON/OFF : All Notes OFF : Active Sensing : System Reset	o o x o x x	*1 *1 *1 x x x	
Notes		*1 Transmitted only during MIDI phrase playback *2 o x is selectable. *3 Transmitted when Sync Out is at MTC. *4 Received when Sync Source is at MTC.		

Mode 1 : OMNI ON, POLY  
Mode 3 : OMNI OFF, POLY

Mode 2 : OMNI ON, MONO  
Mode 4 : OMNI OFF, MONO

o : Yes  
x : No



### MIDI Implementation Chart

#### MIDI Recording Section

Function ...		Transmitted	Recognized	Remarks
Basic Channel	Default Changed	x x	all channels x	Not Basic Channel
Mode	Default Message Altered	x x *****	x x	
Note Number :	True Voice	x *****	0-127 0-127	
Velocity	Note ON Note OFF	x x	o o	
After Touch	Key's Ch's	x x	o o	
Pitch Bend		x	o	
Control Change  0-119		x	o	
Program Change :	True #	x *****	o 0-127	
System Exclusive		x	o	
System Common	: Quarter Frame : Song Pos : Song Sel : Tune	x x x x	x x x x	
System Real Time	: Clock : Commands	x x	x o	
Aux Messages	: All Sounds OFF : Reset All Controllers : Local ON/OFF : All Notes OFF : Active Sensing : System Reset	x x x x x x	o o x o ( 123-127 ) *1 o x	
Notes	Mode messages (123-127) are stored/transmitted after All Note Off processing is performed.			

Mode 1 : OMNI ON, POLY

Mode 2 : OMNI ON, MONO

o : Yes

Mode 3 : OMNI OFF, POLY

Mode 4 : OMNI OFF, MONO

x : No

# Specification

## Recording Format

RDAC (Roland Digital Audio Coding)

## RDAC-GRADE (Sampling rate)

S-HIGH: 48kHz

HIGH: 44.1kHz

STANDARD: 32kHz

LONG1: 22.05kHz

LONG2: 16kHz

ANNOUNCE:8kHz

## Playback rate Area

S-HIGH: 20kHz–22kHz

HIGH: 20kHz–20kHz

STANDARD: 20kHz–15kHz

LONG1: 20kHz–10kHz

LONG2: 20kHz–7.5kHz

ANNOUNCE:20kHz–3.7kHz

## RDAC-Mode (Signal processing method)

H-Linear: 24 bit PCM recording (Playback Only)

Linear: 16 bit PCM recording

Mode 3: 2.5 times extended Recording time than Linear.

Mode 2: 2.5 times more extended Recording time than Linear.

Mode 1: 4 times more extended Recording time than Linear.

## Recording media

PC card (PC Card Standard (1995) compatible, TYPE1.2)

## Recommended PC cards

Roland PC Cards PM series (PCMCIA2.0/2.1, JEDA Ver.4.1/4.2 Spec Standard)

\* In order to recording/playback of audio signal and MIDI data, you will need to purchase one of the PC cards.

## PC Card Slot

1Slot (TYPE1, 2)

## Phrase types

Audio phrases (stereo/mono)

MIDI phrases

## Number of phrases

- Card made on the AR-200

Maximum 250 Phrases

- Card made on the AR-3000

Maximum 1000 phrases

## Playback method

- Card made on the AR-200

Manual playback

Direct playback: 9 phrases, 2 modes(Normal, Last-In)

Interval playback: 9 phrases

Count Playback: 100phrases,5 program

Binary playback: 250 phrases

MIDI playback: 500 phrases

AR-LINK playback: 1000 phrases

- Card made on the AR-3000

Manual playback

Direct playback: 9 phrases,

Interval playback: 9 phrases

Count Playback: 100 phrases,5 program

Binary playback: 250 phrases

MIDI playback: 500 phrases

AR-LINK playback: 1000 phrases

## Equalizer (Functions only when using cards that have been prepared on the AR-3000.)

High : -12dB – +12dB (3/6kHz, Shelving Type)

Low : -12dB – +12dB (200/400Hz, Shelving Type)

## Residual Noise Level (Input Short, front sense: middle, DIN- Audio,typ.)

- 80dBu or less

## S/N Ratio

Output : 84 dB (DIN-Audio, Typ)

## Display

7 Segment 4 characters (LED)

## Controllers

INPUT Volume Knob

Card Eject Button

PLAY Button

STOP Button

INCrement Button

DECrement Button

REC MODE Switch (Bottom Chassis)

MODE Switch (Bottom Chassis)

## Indicators

MIDI /CLIP Indicator

SLAVE Indicator

PLAY Indicator

MEMORY FULL Indicator

**Connectors**

LINE IN jacks (MONO/L, R, RCA phono type)  
Control I/O Terminal (5 pin Terminal Block with M3 bolts)  
Control I/O Connector (25 pin D-sub type)  
MIDI Connectors (OUT/THRU, IN, 5-pin DIN type)  
AR-LINK Connectors (OUT, IN, 8-pin mini DIN type)  
Audio Output jacks (1/4 inch phone type, TRS balanced)  
PHONES jack (Stereo miniature phone type)

**Power Supply**

DC 9 V (AC Adaptor)  
DC 9 V – DC 24 V (Control/Power In Jack, Control I/ O Connector)

**Current Draw**

900 mA

**Dimensions**

218 (W) x 246.2 (D) x 44 (H) mm  
8-5/8 (W) x 9-3/4(D) x 1-3/4 (H) inches

**Weight**

1.4 kg / 31 bs 2 oz.

**Supplied Accessories**

Rubber Feet  
Card Protector (with screws)  
Owner's Manual  
AC Adaptor (ACI/ACB Series)

**Options**

Roland PM Series  
AR-LINK Cable (RSC-15APL)

\*  $0\text{ dBu}=0.775\text{Vrms}$

\* *In the interest of product improvement, the specifications and/or appearance of this unit are subject to change without prior notice.*

# Specification

## Input/Output Standard

### Input Standard

Input Jack	Input Sense	Rated Input Level	Non Clip Max Input Level	Input Impedance	Recommended Source Impedance
Line Input Jack	-10 dBu	0 dBu	+6 dBu	10 k ohms	1 k ohms or less

### Output Standard

Output Jack	Rated Output Level	Non Clip Max Output Level	Output Impedance	Recommended Load Impedance
Audio Output Jack	+4 dBu / -10 dBV	+9 dBu	500 ohms	600 ohms or more
Phones Jack	-----	70mW+70mW *1	270 ohms	30 ohms or more

\*0 dBu = 0.775 Vrms, -10 dBV=-7.79 dBu  
 \*1: 100 ohms with both channels loaded

## Dimensions

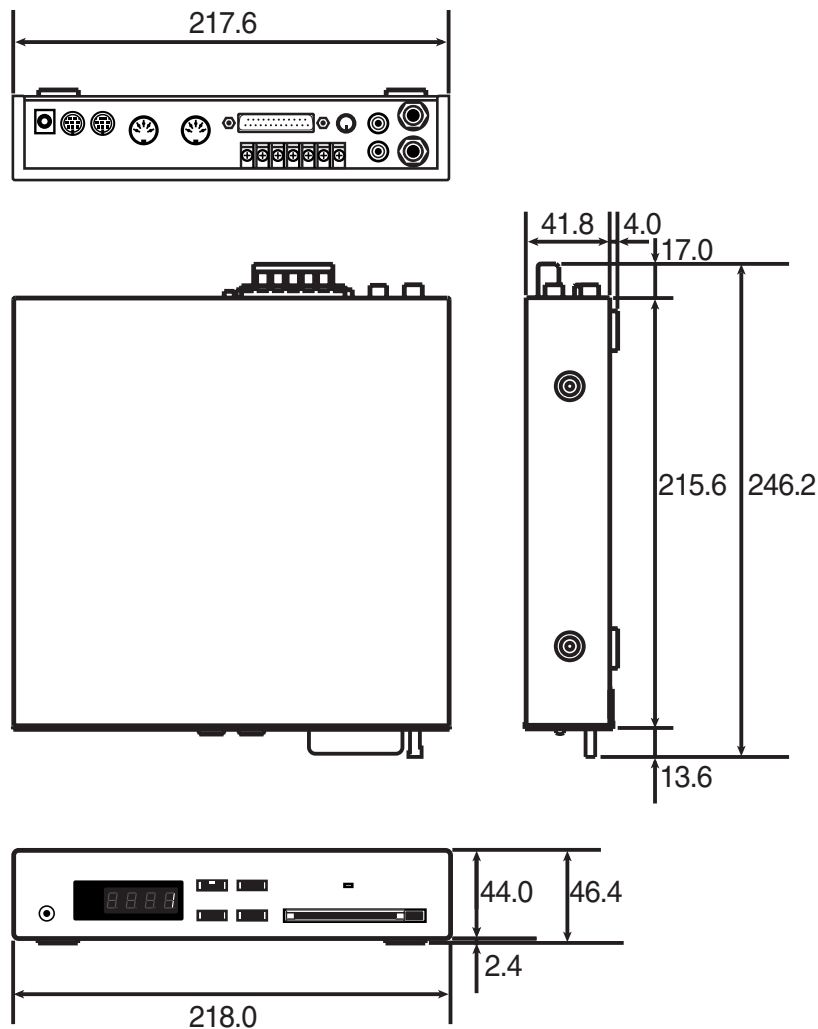

\*Dimensions are with card inserted and rubber feet (included) attached.  
 \*The power cord is not included.

# Index

## A

AR-LINK .....45, 56  
AR-LINK SLAVE .....46

## B

Binary Playback .....31

## C

Card Audio Recording Time Chart .....53  
Card Compatibility .....17  
Card Protector .....11  
control input connectors .....28  
Control Input Playback .....28  
Control Out .....39

## D

Deleting Phrases .....25  
Direct Playback .....30  
Direct playback .....28

## I

Implementation .....58  
Interval Playback .....34

## M

Manual Playback .....24  
MEMORY FULL indicator .....23  
MIDI control .....42  
MIDI Implementation Chart .....64  
MIDI Note Map .....43  
MIDI Note Out .....44  
MIDI Phrase .....26  
MIDI Phrases .....26  
MIDI Receive Channel .....44  
MIDI/CLIP indicator .....22, 26–27  
MMC .....42  
MTC .....42

## N

No-voltage/Make-contact .....28

## O

Output Level .....56

## P

Phrases .....18  
Playback Mode .....56  
Playing Back MIDI Phrases .....27

## R

RDAC .....19–21  
RDAC-Grade .....19  
RDAC-Mode .....20  
REC MODE SW .....19, 21  
REC MODE SW 4, 5 .....20  
Recorded Phrase Data .....54  
Recording Type .....21

## S

sampling frequency .....19  
slave .....46  
Smart Media .....15  
Switch Protect .....56

## T

Terminal Rec .....34  
Terminal Rec Settings .....56  
trigger recording .....23

# Information

When you need repair service, call your nearest Roland Service Center or authorized Roland distributor in your country as shown below.

## AFRICA

### EGYPT

**Al Fanny Trading Office**  
9, EBN Hagar A1 Askalany Street,  
ARD El Golf, Heliopolis,  
Cairo 11341, EGYPT  
TEL: 20-2-417-1828

### REUNION

**Maison FO - YAM Marcel**  
25 Rue Jules Hermann,  
Chaudron - BP79 97 491  
Ste Clotilde Cedex,  
REUNION ISLAND  
TEL: (0262) 218-429

### SOUTH AFRICA

**That Other Music Shop  
(PTY) Ltd.**  
11 Melle St., Braamfontein,  
Johannesburg, SOUTH AFRICA

P.O.Box 32918, Braamfontein 2017  
Johannesburg, SOUTH AFRICA  
TEL: (011) 403 4105

**Paul Bothner (PTY) Ltd.**  
17 Werdmuller Centre,  
Main Road, Claremont 7708  
SOUTH AFRICA

P.O.Box 23032, Claremont 7735,  
SOUTH AFRICA  
TEL: (021) 674 4030

## ASIA

### CHINA

**Roland Shanghai Electronics  
Co.,Ltd.**  
5F, No.1500 Pingliang Road  
Shanghai 200090, CHINA  
TEL: (021) 5580-0800

**Roland Shanghai Electronics  
Co.,Ltd.  
(BEIJING OFFICE)**  
10F, No.18 Anhuaxili  
Chaoyang District, Beijing 100011  
CHINA  
TEL: (010) 6426-5050

**Roland Shanghai Electronics  
Co.,Ltd.  
(GUANGZHOU OFFICE)**  
2/F., No.30 Si You Nan Er Jie Yi  
Xiang, Wu Yang Xin Cheng,  
Guangzhou 510600, CHINA  
Tel: (020) 8736-0428

### HONG KONG

**Tom Lee Music Co., Ltd.  
Service Division**  
22-32 Pun Shan Street, Tsuen  
Wan, New Territories,  
HONG KONG  
TEL: 2415 0911

### Parsons Music Ltd.

8th Floor, Railway Plaza, 39  
Chatham Road South, T.S.T,  
Kowloon, HONG KONG  
TEL: 2333 1863

### INDIA

**Rivera Digitech (India) Pvt. Ltd.**  
409, Nirman Kendra Mahalaxmi  
Flats Compound Off. Dr. Edwin  
Moses Road, Mumbai-400011,  
INDIA  
TEL: (022) 2493 9051

### INDONESIA

**PT Citra IntiRama**  
Jl. Cideng Timur No. 15J-150  
Jakarta Pusat  
INDONESIA  
TEL: (021) 6324170

### KOREA

**Cosmos Corporation**  
1461-9, Seocho-Dong,  
Seocho Ku, Seoul, KOREA  
TEL: (02) 3486-8855

### MALAYSIA

**BENTLEY MUSIC SDN BHD**  
140 & 142, Jalan Bukit Bintang  
55100 Kuala Lumpur, MALAYSIA  
TEL: (03) 2144-3333

### PHILIPPINES

**G.A. Yupangco & Co. Inc.**  
339 Gil J. Puyat Avenue  
Makati, Metro Manila 1200,  
PHILIPPINES  
TEL: (02) 899 9801

### SINGAPORE

**Swee Lee Company**  
150 Sims Drive,  
SINGAPORE 387381  
TEL: 6846-3676

**CRISTOFORI MUSIC PTE  
LTD**  
Blk 3014, Bedok Industrial Park E,  
#02-2148, SINGAPORE 489980  
TEL: 6243-9555

### TAIWAN

**ROLAND TAIWAN  
ENTERPRISE CO., LTD.**  
Room 5, 9fl. No. 112 Chung Shan  
N.Road Sec.2, Taipei, TAIWAN,  
R.O.C.  
TEL: (02) 2561 3339

### THAILAND

**Theera Music Co., Ltd.**  
330 Vereng NakornKasem, Soi 2,  
Bangkok 10100, THAILAND  
TEL: (02) 2248821

### VIETNAM

**Saigon Music  
Suite DP-8**  
40 Ba Huyen Thanh Quan Street  
Hochiminh City, VIETNAM  
Tel: (08) 930-1969

## AUSTRALIA/ NEW ZEALAND

### AUSTRALIA

**Roland Corporation  
Australia Pty., Ltd.**  
38 Campbell Avenue  
Dee Why West. NSW 2099  
AUSTRALIA  
TEL: (02) 9982 8266

### NEW ZEALAND

**Roland Corporation Ltd.**  
32 Shaddock Street, Mount Eden,  
Auckland, NEW ZEALAND  
TEL: (09) 3098 715

## CENTRAL/LATIN AMERICA

### ARGENTINA

**Instrumentos Musicales S.A.**  
Av.Santa Fe 2055  
(1123) Buenos Aires  
ARGENTINA  
TEL: (011) 4508-2700

### BRAZIL

**Roland Brasil Ltda**  
Rua San Jose, 780 Sala B  
Parque Industrial San Jose  
Cotia - Sao Paulo - SP, BRAZIL  
TEL: (011) 4615 5666

### COSTA RICA

**JUAN Bansbach  
Instrumentos Musicales**  
Ave.1. Calle 11, Apartado 10237,  
San Jose, COSTA RICA  
TEL: 258-0211

### CHILE

**Comercial Fancy II S.A.**  
Rut.: 96.919.420-1  
Nataníel Cox #739, 4th Floor  
Santiago - Centro, CHILE  
TEL: (02) 688-9540

### EL SALVADOR

**OMNI MUSIC**  
75 Avenida Norte y Final  
Alameda Juan Pablo II,  
Edificio No.4010 San Salvador,  
EL SALVADOR  
TEL: 262-0788

### MEXICO

**Casa Veerkamp, s.a. de c.v.**  
Av. Toluca No. 323, Col. Olivar  
de los Padres 01780 Mexico D.F.  
MEXICO  
TEL: (55) 5668-6699

### PANAMA

**SUPRO MUNDIAL, S.A.**  
Boulevard Andrews, Albrook,  
Panama City, REP. DE PANAMA  
TEL: 315-0101

### PARAGUAY

**Distribuidora De  
Instrumentos Musicales**  
J.E. Olear y ESQ. Manduvira  
Asuncion PARAGUAY  
TEL: (021) 492-124

### URUGUAY

**Todo Musica S.A.**  
Francisco Acuna de Figueroa 1771  
C.P.: 11.800  
Montevideo, URUGUAY  
TEL: (02) 924-2335

### VENEZUELA

**Musicland Digital C.A.**  
Av. Francisco de Miranda,  
Centro Parque de Cristal, Nivel  
C2 Local 20 Caracas  
VENEZUELA  
TEL: (212) 285-8586

## EUROPE

### AUSTRIA

**Roland Austria GES.M.B.H.**  
Siemensstrasse 4, P.O. Box 74,  
A-6063 RUM, AUSTRIA  
TEL: (0512) 26 44 260

### BELGIUM/HOLLAND/ LUXEMBOURG

**Roland Benelux N. V.**  
Houtstraat 3, B-2260, Oevel  
(Westerlo) BELGIUM  
TEL: (014) 575811

### DENMARK

**Roland Scandinavia A/S**  
Nordhavnsvej 7, Postbox 880,  
DK-2100 Copenhagen  
DENMARK  
TEL: 3916 6200

### FRANCE

**Roland France SA**  
4, Rue Paul Henri SPAAK,  
Parc de l'Esplanade, F 77 462 St.  
Thibault, Lagny Cedex FRANCE  
TEL: 01 600 73 500

### FINLAND

**Roland Scandinavia As,  
Filial Finland**  
Elannontie 5  
FIN-01510 Vantaa, FINLAND  
TEL: (09) 68 24 020

### GERMANY

**Roland Elektronische  
Musikinstrumente HmbH.**  
Oststrasse 96, 22844 Norderstedt,  
GERMANY  
TEL: (040) 52 60090

### GREECE

**STOLLAS S.A.**  
Music Sound Light  
155, New National Road  
Patras 26442, GREECE  
TEL: 2610 435400

### HUNGARY

**Roland East Europe Ltd.**  
Warehouse Area 'DEPO' Pf.83  
H-2046 Torokbalint, HUNGARY  
TEL: (23) 511011

### IRELAND

**Roland Ireland**  
G2 Calmount Park, Calmount  
Avenue, Dublin 12  
Republic of IRELAND  
TEL: (01) 4294444

### ITALY

**Roland Italy S. p. a.**  
Viale delle Industrie 8,  
20020 Arese, Milano, ITALY  
TEL: (02) 937-78300

### NORWAY

**Roland Scandinavia Avd.  
Kontor Norge**  
Lilleakerveien 2 Postboks 95  
Lilleaker N-0216 Oslo  
NORWAY  
TEL: 2273 0074

### POLAND

**P. P. H. Brzostowicz**  
UL. Gibraltarska 4.  
PL-03664 Warszawa POLAND  
TEL: (022) 679 44 19

### PORTUGAL

**Tecnologias Musica e Audio,  
Roland Portugal, S.A.**  
Cais Das Pedras, 8/9-1 Dto  
4050-465 PORTO  
PORTUGAL  
TEL: (022) 608 00 60

### ROMANIA

**FBS LINES**  
Piata Libertatii 1,  
RO-4200 Gheorgheni  
TEL: (095) 169-5043

### RUSSIA

**MuTek**  
3-Bogatyrskaya Str. 1.k.1  
107 564 Moscow, RUSSIA  
TEL: (095) 169 5043

### SPAIN

**Roland Electronics  
de España, S. A.**  
Calle Bolivia 239, 08020  
Barcelona, SPAIN  
TEL: (93) 308 1000

### SWEDEN

**Roland Scandinavia A/S  
SWEDISH SALES OFFICE**  
Danvik Center 28, 2 tr.  
S-131 30 Nacka SWEDEN  
TEL: (08) 702 00 20

### SWITZERLAND

**Roland (Switzerland) AG**  
Landstrasse 5, Postfach,  
CH-4452 Itingen,  
SWITZERLAND  
TEL: (061) 927-8383

### UKRAINE

**TIC-TAC**  
Mira Str. 19/108  
P.O. Box 180  
295400 Munkachevo, UKRAINE  
TEL: (03131) 414-40

### UNITED KINGDOM

**Roland (U.K.) Ltd.**  
Atlantic Close, Swansea  
Enterprise Park, SWANSEA  
SA7 9FJ,  
UNITED KINGDOM  
TEL: (01792) 702701

## MIDDLE EAST

### BAHRAIN

**Moon Stores**  
No.16, Bab Al Bahrain Avenue,  
P.O.Box 247, Manama 304,  
State of BAHRAIN  
TEL: 211 005

### CYPRUS

**Radex Sound Equipment Ltd.**  
17, Diagorou Street, Nicosia,  
CYPRUS  
TEL: (022) 66-9426

### IRAN

**MOCO, INC.**  
No.41 Nike St., Dr.Shariyati Ave.,  
Roberoye Cerahe Mirdamad  
Tehran, IRAN  
TEL: (021) 285-4169

### ISRAEL

**Halilit P. Greenspoon &  
Sons Ltd.**  
8 Retzif Ha'aliya Hashnya St.  
Tel-Aviv-Yafo ISRAEL  
TEL: (03) 6823666

### JORDAN

**AMMAN Trading Agency**  
245 Prince Mohammad St.,  
Amman 1118, JORDAN  
TEL: (06) 464-1200

### KUWAIT

**Easa Husain Al Yousifi Est.**  
Abdullah Salem Street,  
Safat, KUWAIT  
TEL: 243-6399

### LEBANON

**Chahine S.A.L.**  
Gerge Zeidan St., Chahine Bldg.,  
Achrafieh, P.O.Box: 16-5857  
Beirut, LEBANON  
TEL: (01) 20-1441

### QATAR

**Al Emadi Co. (Badie Studio  
& Stores)**  
P.O. Box 62, Doha, QATAR  
TEL: 4423-554

### SAUDI ARABIA

**aDawlah Universal  
Electronics APL**  
Corniche Road, Aldossary Bldg.,  
1st Floor, Alkhobar,  
SAUDI ARABIA

P.O.Box 2154, Alkhobar 31952  
SAUDI ARABIA  
TEL: (03) 898 2081

### SYRIA

**Technical Light & Sound  
Center**  
Khaled Ebn Al Walid St.  
Bldg. No. 47, P.O.Box 13520,  
Damascus, SYRIA  
TEL: (011) 223-5384

### TURKEY

**Barkat muzik aletleri ithalat  
ve ihracat Ltd Sti**  
Siraselsivler Caddesi Siraselsivler  
Pasaji No:74/20  
Taksim - Istanbul, TURKEY  
TEL: (0212) 2499324

### U.A.E.

**Zak Electronics & Musical  
Instruments Co. L.L.C.**  
Zabeel Road, Al Sherooq Bldg.,  
No. 14, Grand Floor, Dubai, U.A.E.  
TEL: (04) 3360715

## NORTH AMERICA

### CANADA

**Roland Canada Music Ltd.  
(Head Office)**  
5480 Parkwood Way Richmond  
B. C., V6V 2M4 CANADA  
TEL: (604) 270 6626

**Roland Canada Music Ltd.  
(Toronto Office)**  
170 Admiral Boulevard  
Mississauga On L5T 2N6  
CANADA  
TEL: (905) 362 9707

### U. S. A.

**Roland Corporation U.S.**  
5100 S. Eastern Avenue  
Los Angeles, CA 90040-2938,  
U. S. A.  
TEL: (323) 890 3700

As of July 1, 2003 (Roland)



This product complies with the requirements of European Directive 89/336/EEC.

For EU Countries

## FEDERAL COMMUNICATIONS COMMISSION RADIO FREQUENCY INTERFERENCE STATEMENT

This equipment has been tested and found to comply with the limits for a Class B digital device, pursuant to Part 15 of the FCC Rules. These limits are designed to provide reasonable protection against harmful interference in a residential installation. This equipment generates, uses, and can radiate radio frequency energy and, if not installed and used in accordance with the instructions, may cause harmful interference to radio communications. However, there is no guarantee that interference will not occur in a particular installation. If this equipment does cause harmful interference to radio or television reception, which can be determined by turning the equipment off and on, the user is encouraged to try to correct the interference by one or more of the following measures:

- Reorient or relocate the receiving antenna.
- Increase the separation between the equipment and receiver.
- Connect the equipment into an outlet on a circuit different from that to which the receiver is connected.
- Consult the dealer or an experienced radio/TV technician for help.

Unauthorized changes or modification to this system can void the users authority to operate this equipment.  
This equipment requires shielded interface cables in order to meet FCC class B Limit.

For the USA

## NOTICE

This Class B digital apparatus meets all requirements of the Canadian Interference-Causing Equipment Regulations.

## AVIS

Cet appareil numérique de la classe B respecte toutes les exigences du Règlement sur le matériel brouilleur du Canada.

For Canada





## Free Manuals Download Website

<http://myh66.com>

<http://usermanuals.us>

<http://www.somanuals.com>

<http://www.4manuals.cc>

<http://www.manual-lib.com>

<http://www.404manual.com>

<http://www.luxmanual.com>

<http://aubethermostatmanual.com>

Golf course search by state

<http://golfingnear.com>

Email search by domain

<http://emailbydomain.com>

Auto manuals search

<http://auto.somanuals.com>

TV manuals search

<http://tv.somanuals.com>