

Roland®

24-bit DIGITAL STUDIO WORKSTATION VS-890

Appendices

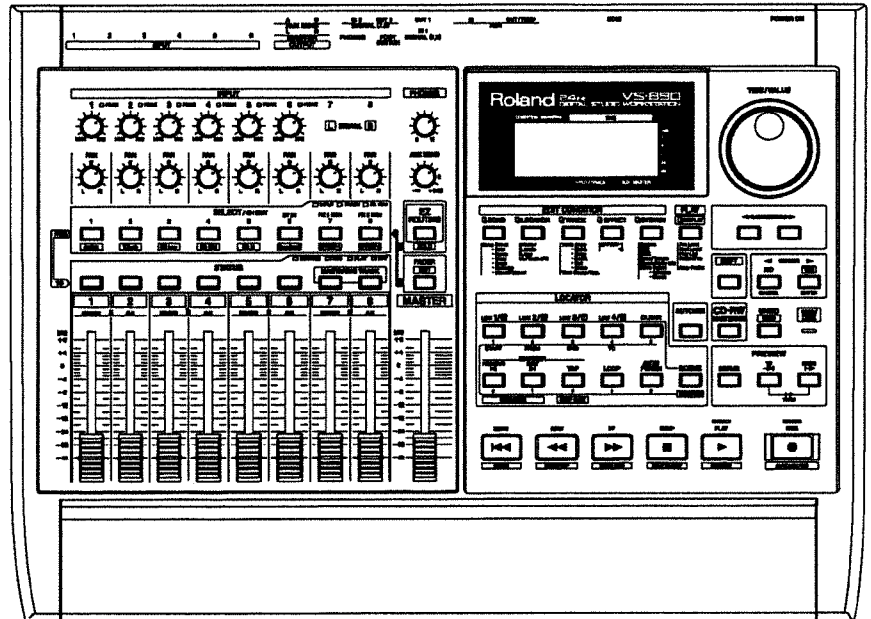

Before using this unit, carefully read the sections entitled: "IMPORTANT SAFETY INSTRUCTIONS" (Owner's Manual p. 2), "USING THE UNIT SAFELY" (Owner's Manual p. 3), and "IMPORTANT NOTES" (Owner's Manual p. 11). These sections provide important information concerning the proper operation of the unit. Additionally, in order to feel assured that you have gained a good grasp of every feature provided by your new unit, User Guide, Owner's Manual, and Appendices should be read in its entirety. These manuals should be saved and kept on hand as a convenient reference.

Copyright © 2000 ROLAND CORPORATION

All rights reserved. No part of this publication may be reproduced in any form without the written permission of ROLAND CORPORATION.

Roland Web Site: <http://www.roland.co.jp/>

Roland US Web Site: <http://www.rolandus.com/>

Contents

Contents	2
About MIDI.....	3
About SCSI.....	4
Troubleshooting	5
Error Messages.....	9
Glossary	12
Special Key Operations.....	14
Parameter List.....	16
Preset Patch List.....	20
Algorithm List	25
MIDI Implementation.....	81
Mixer Section Block Diagram	127
Track Sheet	129
Specifications	130
Index	132

About MIDI

This section explains the basic concepts of MIDI, and how the VS-890 handles MIDI messages.

What is MIDI

MIDI stands for **Musical Instrument Digital Interface**. It is a worldwide standard that allows electronic musical instruments and personal computer to exchange musical performance data and messages such as sound selections. Any MIDI-compatible device can transmit musical data (as appropriate for the type of device) to any other MIDI-compatible device, regardless of its manufacturer or model type.

MIDI connectors

MIDI messages (the data handled by MIDI) are transmitted and received using the following three types of connectors. On the VS-890, MIDI OUT and MIDI THRU are handled by a single connector, which can be switched to act as the desired connector. (Owner's Manual p. 161)

- MIDI IN:** This receives MIDI messages from external MIDI devices.
- MIDI OUT:** This transmits MIDI messages from the VS-890.
- MIDI THRU:** This re-transmits all MIDI messages that were received at MIDI IN, without modifying them.

MIDI channels

MIDI is able to send information over a single MIDI cable independently to two or more MIDI devices. This is made possible by the concept of MIDI channels. You can think of MIDI channels as being somewhat similar in function to the channels on a television. By changing the channel of a TV set, you can view a variety of programs being transmitted by different broadcast stations. This is because data is received only from the transmitter whose channel is selected on the receiver.

In the same way, a MIDI device whose receive channel is set to "1" will receive only the data being transmitted by another MIDI device whose transmit channel is also set to "1."

MIDI messages

The VS-890 uses the following types of MIDI message.

Note messages:

These messages are used to play notes. On a keyboard, these message transmit the key (note number) that was pressed, and how strongly it was pressed (velocity). On the VS-890,

these messages are used when you use a MIDI sound source to play the metronome sound.

Program Change messages:

These messages are for the purpose of selecting sounds, and contain a program number of 1–128. The VS-890 uses these messages to select scenes and effects. (Owner's Manual p. 172)

Control Change messages:

In general, these messages are used to transmit information such as vibrato, hold, and volume etc., that makes a performance more expressive. The various functions are differentiated by a controller number from 0–127, and the controller number is defined for each function. The functions that can be controlled on any given device will depend on that device.

On the VS-890, these messages are used in a completely different way than on most instruments; they are used to control mixer parameters.

Exclusive messages:

Unlike note messages and control change messages, exclusive messages are used to transmit settings that are unique to a particular device. On the VS-890, exclusive messages can be used to control mixer parameters (in the same way as control change messages). Normally, control change messages are easier to handle, so they should be used rather than exclusive messages. Exclusive messages intended for different units are distinguished by their Device ID, rather than by MIDI channel. When exclusive messages are to be transmitted or received, you must set the Device ID of both units to a matching setting.

MIDI implementation chart

MIDI allows a variety of electronic musical instruments to communicate with each other. However it is not necessarily the case that all devices will be able to communicate using all types of MIDI message. They can only communicate using those types of MIDI message that they have in common.

Each owner's manual for a MIDI device includes a MIDI Implementation Chart. This chart shows you at a glance the types of MIDI message that can be transmitted and received. By comparing the implementation charts of two devices, you will be able to see the types of message with which they will be able to communicate.

About SCSI

SCSI stands for **Small Computer System Interface**. It is a data transfer standard that allows large amounts of data to be sent and received. The VS-890 comes prepared with a SCSI connectors allowing you to connect external SCSI devices such as hard disks and Zip drives. This section describes the procedures and precautions taken when using these devices.

Disk drives are precision devices. If they are connected or used incorrectly, not only may they fail to operate correctly, but the data on the disk can be lost or, in the worst case, the disk drive itself may be damaged. Please be sure to read the manual for your disk drive.

NOTE

A disk drive being used for the first time with the VS-890 must be initialized by the VS-890 (Owner's Manual p. 134). When a disk drive is initialized, all data on that disk drive is lost. Before using a disk drive that has been used by another device, make sure that it is all right to erase the data.

About Connections

Up to 7 disk drives can be connected to the SCSI connector of the VS-890. Use SCSI cable to connect the disk drives, connecting as shown below. SCSI connectors are not distinguished by input and output ends, so you may attach either end of the cable to the devices. Devices connected in this fashion are referred to as a **SCSI chain** or **daisy chain**.



VS-890 Disk Drive1 Disk Drive2 Disk Drive7
(Zip Drive, etc) (Zip Drive, etc) (CD-RW Drive, etc)

- The VS-890 features a DB-25 type connector (female). After checking your disk drive to see what kind of SCSI connector it uses, connect it with the appropriate cable.
- Keep SCSI cables as short as possible, and use only cables which have an impedance that is compatible with the SCSI standard ($110\Omega \pm 10\%$), and that are completely shield.
- Do not allow the total length of all SCSI cables connecting the chain of disk drives to exceed 6.5 meters.
- Do not connect or disconnect SCSI cables when the power of any device is turned on.

About Terminators

To protect against return noise, the device at each end of a SCSI chain must have a terminating resistance. This is referred to as a **terminator**. Since the VS-890 is one end of the SCSI chain, its internal terminator is normally in effect. Connect a terminator only to the last external drive in the chain. There are two types of terminators, those that can be switched on and off (internal) and those that are attached using SCSI connections (externally attached). Select the method appropriate for the disk drive you are using.

- Your disk drive may feature a terminator switch that is normally left in the "On" position (i.e., the terminator is usually in effect). Use this type of device as the last piece in a daisy chain.
- Do not use double terminators. For example, don't attach an external terminator to a disk drive that already has an internal terminator.

Active Terminators

If you are using an external terminator, we recommend that you make it an active terminator. In this case, if you are using a disk drive that allows you to turn the power to the terminator on and off, be sure to turn this power on. For details on attaching an active terminator, refer to the owner's manual for your disk drive.



Active Terminator (p. 12), Terminator Power (p. 13)

About SCSI ID Numbers

Each disk drive is distinguished by its SCSI ID number (0-7). This means that when two or more disk drives are connected, you must make settings so that the SCSI ID numbers of the disk drives do not conflict (coincide). If the SCSI ID numbers conflict, the VS-890 will not be able to correctly recognize the disk drives.

With the factory settings, the VS-890 is set to SCSI ID number 7. Set the disk drives you are connected to ID numbers other than 7.

Troubleshooting

When the VS-890 does not perform the way you expect, check the following points before you suspect a malfunction. If this does not resolve the problem, contact servicing by your dealer or qualified Roland Service Center.

Recording and Playback

No Sound

- The power of the VS-890 and the connected devices is not turned on.
- The audio cables are not connected correctly.
- The audio cables are broken.
- The volume is turned down on the connected mixer or amp.
- Each Levels of the VS-890 is turned down.
 - Channel fader
 - Master fader
 - PHONES knob
- The output jacks which are connected are different than the output jacks selected in the master section of the mixer (Owner's Manual p. 183).
- Short phrases less than 0.5 seconds cannot be played back.
- The volume level of the instrument connected to the VS-890 is too low.
 - Could you be using a connection cable that contains a resistor? Use a connection cable that does not contain a resistor.
- I can't record or play back, even when I press **[PLAY]**.
 - Does the he PLAY indicator just blink green? When the SYNC MODE fields in the display indicates "EXT," the VS-890 is receiving MTC receive standby messages from the external MIDI device. Operate the external MIDI device or press **[STOP]**.
 - When "PowerOFF/RESTART" appears in the display it means that the shutdown procedure is being performed. Hold down **[SHIFT]** and press **[PLAY (RESTART)]**. This restarts the VS-890.

A specific channels does not sound

- The input mixer or the track mixer has not selected correctly.
- The volume level of the channel is turned down.
 - When switching between the input mixer and track mixer, recalling Scenes, using Auto Mix, or in other such situation, the actual volume levels may not match the position of the faders. In such cases, bring the faders up or down to match the settings.
- The track is off (the STATUS indicator is off).
- The Mix Send Switch is set to "Off."
- The Solo or Mute function (Owner's Manual p. 174) is being used.
- "Cntrl Local" is set to "Off."
 - In this case, fader movements have no effect.

Cannot record

- The recording track has not been selected (the STATUS indicator is not blinking red).
- Recording source tracks, playback tracks, or effects have not been assigned.
- The disk drive has insufficient capacity.
- The song has an insufficient number of events (Owner's Manual p. 24).
- The number of tracks which can be simultaneously recorded will decrease.
 - When the Sample Rate is selected to "48 kHz," up to 6 tracks can be recorded simultaneously.
 - When the Vari Pitch is selected to "On," up to 4 tracks can be recorded simultaneously.

Cannot record digitally

- The CD player's digital connection is not accepted (Owner's Manual p. 67).
- The **master clock** is set to "INT" (Owner's Manual p. 68).
- The DIGITAL IN connector (optical or coaxial) was not properly selected.

→ Continued...

Troubleshooting

- The sampling rate of the recording destination song is different than the sampling rate of the digital audio device.
 - Match the sample rate setting of the digital audio device to the setting of the song. If it is not possible to change the sample rate of the digital audio device, create a new song with that sample rate.
- The digital signal is not being transmitted from the digital audio device.
 - Some digital audio devices do not output a digital signal unless they are in play mode. If this is the case, put your digital audio device in standby (pause) mode before putting the VS-890 into record mode.
- The digital signal format is different.
 - Some digital audio devices may use a special digital signal format. Please connect to a digital audio device that is compatible with S/P DIF.

Noise and distortion appear in the recorded sound

- Input sensitivity settings are incorrect.
 - If input sensitivity settings are too high, the recorded sound will be distorted. Conversely, if they are too low, the recorded sound will be obscured by noise. Adjust the INPUT knobs so that the level meters move at as high a level as possible, within the range of -12 dB to 0 dB.
- The equalizer is being used with the input mixer.
 - Some equalizer settings may cause the sound to distort even if the PEAK indicator does not light. Readjust the equalizer.
- "ATT" (Attenuator) setting is incorrect. (Owner's Manual p. 182)
 - If noise or distortion occurred as a result of track bouncing, the track output levels were too high.

The playback pitch is strange

- The Vari-Pitch function is turned on.
- The time compression/expansion function is being used (Owner's Manual p. 88).

Disk drive problems

The internal hard disk is not being recognized

- The hard disk has not been installed correctly (User Guide p. 5).
- "IDE Drive" is set to "Off" (Owner's Manual p. 194).
- The "Partition" settings are not right (Owner's Manual p. 134).
 - When a high-capacity hard disk is installed in the VS-890, we recommend setting the partition size to "1000MB."
- Although the Track Erase operation is finished, the available recording time does not increase.
 - The audio data is erased by Track Cut, Track Erase or Phrase Delete etc., the data that is no longer played back is not actually erased from the hard disk. If you wish to increase the available recording time, please read "If "Disk Full!" appears in the display (Song Optimize)" (Owner's Manual p. 122).

The Zip drive is not recognized

- The Zip drive is not connected correctly.
- The same device ID number is assigned to two or more SCSI devices (Zip drives, CD-RW drives, etc.).
- The Zip drive has not been initialized (Owner's Manual p. 134).
- No Zip disk is inserted in the drive.
 - When switching Zip disks, be sure to select the newly inserted disk as the current drive.
- An archives copy Zip disk is inserted.
 - Playable copies and archives copies have different disk formats. Take precautions such as sticking labels on disks saved as archive type data disks to distinguish them from other disks.
- The VS-890 song data saved on Zip disks cannot use the computer's internal Zip drive.
 - The VS-890 song data format is particular to the VS-890. Other than the other VS-series data ported (Song Export) to the VS-890, the data cannot be handled by other devices.
- Initialization is cancelled, with error messages such as "Medium Error," "Not 512 bytes/sector," "Function Failed!" or other messages appearing in the display
 - The Zip disk may be scratched or be otherwise damaged. Try another (new) disk to check whether or not the same condition reappears.
 - The Zip drive may be broken. Connect the Zip drive to a device other than the VS-890 (e.g., your computer) to see if the drive can initialize disks, read files, and perform other operations normally.

Internal Effects

Effects cannot be used

- You are attempting to select the algorithm for Reverb, Gated Reverb, Vocoder 2, Voice Transformer or Mastering Tool Kit with FX2.
- You are already attempting to select the algorithm for Vocoder 2, Voice Transformer or Mastering Tool Kit with FX1 (Owner's Manual p. 119).
- I'd like to change the order of an effect algorithm.
 - The connection orders cannot be altered. They can only be turned on or off. For more detailed information on what goes on with the algorithm orders, please refer to the "Algorithm List" (p. 25).

CD-RW Drive Problems

I made an audio CD on the CD-R/RW drive, but it doesn't play on a consumer CD player.

- The finalized process was not carried out. When making audio CDs, set "Finalize" to "On" or "OnlyFin." (Owner's Manual p. 143).
- Audio CD's created using a CD-RW disc cannot be played on a conventional CD player. Please use a CD-R disc.

The CD-R drive is not being recognized

- The CD-RW drive is not connected correctly.
- The same device ID number is assigned to two or more SCSI devices (Zip drives, CD-RW drives, etc.).
- No CD-R/RW disc is inserted in the drive.
- A CD-RW drive that is not designated by Roland.

Cannot write to CD-R discs

- The song's sample rate is set to something other than 44.1 kHz (Owner's Manual p. 143).
- No IDE hard disk is installed.
- The internal IDE hard disk does not have sufficient free disk space.
- The CD-R disc does not have sufficient free space.
- You are trying to write to a commercial CD software disc.
- You are trying to write to a CD-R disc that has been finalized.

MIDI Devices Problems

With the VS-890 as master, the MIDI sequencer does not respond to commands

- The MIDI cable is not connected correctly.
- The MIDI cable is broken.
- The MIDI Thru switch is not set to "Out" (Owner's Manual p. 160).
- "Sync Gen." (the sync generator) is not set to the appropriate synchronization method (MTC, MIDI Clock, Sync Track) (Owner's Manual p. 160).
- The SYNC MODE fields in the display indicates "EXT." ("Sync Source" is set to "EXT").
- The two devices are not set to the same type of MTC (during MTC synchronization).
- The MIDI clock data has not been recorded on the sync track (if you are using the sync track for synchronization).
- The settings of the MIDI sequencer are not correct.
- The MIDI sequencer is not ready to playback.
- The VS-890 mixer level and pan settings changed by themselves.
 - The VS-890 receives Control Change messages as well as System Exclusive messages. When set to receive Control Change messages transmitted by a MIDI sequencer, the VS-890's mixer can be controlled by external devices. When this feature is not needed, set the "Control Type" to "Off."

When synchronizing using a MIDI sequencer as the master, the VS-890 does not respond to the sequencer messages

- The MIDI cable is not connected correctly.
- The MIDI cable is broken.
- You are trying to synchronize using the MIDI clock.
 - The VS-890 cannot be run in slave mode using a method other than MTC.
- The SYNC MODE fields in the display indicates "INT." ("Sync Source" is set to "INT").
- The two devices are not set to the same type of MTC (during MTC synchronization).
- The settings of the MIDI sequencer are not correct.
- The VS-890 is not in playback standby mode (with the PLAY indicator blinking).
- MTC reception is in poor condition.
 - Setting the **Sync Error Level** to "5" or higher may improve conditions.

With a video device as the master, the VS-890 does not respond

- The cable connected to the L-connector, the SYSTEM E connector or the MIDI cable is not properly connected.
- The MIDI cable is broken.
- The SYNC MODE in the display indicates "EXT." ("Sync Source" is set to "INT").
- "SysEX.Rx." (System Exclusive Receive Switch) is not set to "On."
- "MMC" (MMC mode) is not set to "SLAVE."
- The MTC frame rate of the video device differs from that of the SI-80SP (Roland Video MIDI Sync Interface), or the video and the VS-890 are not set to the same type of MTC.
- MTC reception is in poor condition.
 - Setting the Sync Error Level to "5" or higher may improve conditions.

Other problems

Data on the disk drive was not saved properly

- The VS-890's power was turned off without performing the shutdown process.
- The power was turned off while the disk drive was operating.
- A strong shock was applied to the disk drive.
- The disk drive or SCSI cable was connected or disconnected while the power was still turned on.
 - Reinitialize the disk drive (and also execute physical formatting) (Owner's Manual p. 134). Also, we recommend that you execute Surface Scan as well (Owner's Manual p. 135).

Error Messages

Aborted Command!

Illegal Request!

This disk drive cannot be used by the VS-890.

Already Selected

The currently selected disk drive was selected. If you wish to switch to another disk drive, re-select the disk drive.

Arbitration Failed!

Busy Status!

Check Condition!

Status Error!

Normal communication with the disk drive could not be accomplished. Make sure that the disk drive is connected correctly.

Blank Disc

You have tried to run the CD player function using a disc that has no performance data on it. Insert a commercial CD or CD-R/RW with material already recorded on it.

Can't Communicate!

Drive Time Out!

Message Error!

Phase Mismatch!

Undefined Sense!

Drive Unknown Error!

There is a problem with the connections to the disk drive. Make sure that the disk drive is connected correctly.

Can't REC CD !

With the factory setting, digital connections cannot be made with a CD player. Please read "To Recording Digital Signals" (User Guide p. 36).

Can't Recover

The drive check Recover procedure could not be executed because there was insufficient free space on the disk. Delete unneeded songs. Alternatively, perform the Song Optimize procedure.

Can't Set Marker

No more than two track number mark points can be set within a four-second interval.

Complete

The operation ended normally.

Change Int CLK ?

No digital signal is being received at the DIGITAL IN connector. Select whether or not to switch the sample rate reference clock to the internal clock. Pressing [ENT/YES] switches the VS-890 to the internal clock. After checking to make sure that all digital devices are properly connected and those sample rates for all devices match, carry out the operation once more.

Digital In Lock

The sample rate reference clock is set to the digital signal coming from the DIGITAL IN connector. You can record using the digital connection.

Digital In Unlock

The digital signal is not being input through the DIGITAL IN connector, or the sample rate set for the song and the sample rate of the digital device connected to the DIGITAL IN connector are different. In this state, you cannot record using the digital connection.

The sample rate specified for the song is different than the sample rate of the digital device connected to the DIGITAL IN connector. Press [ENT/YES], and set the sample rates of both devices to match.

Disk Memory Full!

There is insufficient free area on the disk. Erase unneeded data. Or, select a different disk drive. The maximum number of songs that can be recorded on one partition (200) has been exceeded. Delete unneeded songs. Or, select a different disk drive.

Drive Busy!

If this message appears when you first begin using a disk drive with the VS-890, the disk drive is not fast enough. When using this disk, create a new song with a lower sample rate or recording mode, and record using this song. If this message appears after you have been using the disk drive with the VS-890, the data on the disk drive has become fragmented, causing delays in reading and writing data. Either use the track bouncing operation to re-record playback data to another track, or use the optimize operation. If the same message appears even after these measures have been taken, copy the song data to another disk drive and initialize the disk drive that produced the problem.

Event Memory Full!

The VS-890 has used up all the events that can be handled by one song. Delete unneeded auto mix data. Alternatively, perform the Song Optimize operation.

Error Messages

Finalized CD !

This message appears when an attempt is made to write to a commercial CD or a finalized CD-R disc. Replace the disc with a blank disc or one that has not been finalized.

Illegal Track Pair!

You are trying to Track Edit (Copy, Move, or Exchange etc.) between a V-track that has been recorded with "CDR" (Recording Mode or CDRRecMode) and a normal V-track. Please select the source and the destination V-tracks again.

Function Failed

Processing was halted due to insufficient memory or due to an error which occurred in the disk drive itself. Check connections and reliability.

Hardware Error!

There is a problem with the disk drive. Contact the manufacturer or dealer of the disk drive.

Illegal Track!

You are trying to Phase New between a V-track (take) that has been recorded with "CDR" (Recording Mode or CDRRecMode) and a normal V-track (take). Please select the source and the destination V-tracks again.

Lack of CD-R Memory!

There is insufficient free space to write the songs to the CD-R/RW disc.

Lack of EVENT !!

You have tried to UNDO or REDO when the remaining number of Event is less than 200. You cannot continue the current operation.

Lack of IDE Memory!

There is insufficient free space on the internal IDE hard disk to make the image data file.

MARKER Memory Full!

The VS-890 has used up all Marker Memory (1000 Markers) that can be handled by one song. Delete unneeded Marker.

Medium Error!

There is a problem with the disk drive media. This disk cannot be used by the VS-890. In some case's recovery can be achieved by executing Drive Check.

No CD-R Drive !

Either no CD recorder (CD-R/RW drive) is connected, or the power is not turned on.

No Data to Write

The track that you have selected to write to CD-R/RW disc contains no song data.

No Disc

There is no disc in the Roland CD recorder (CD-R/RW drive). Please insert a disc.

No Drive Ready

No disk drive is connected. Or, an internal hard disk is not installed. Make sure that the disk drive is connected correctly.

No IDE Drive !

The unit has no IDE-type disk drive. Install an internal hard disk.

Not 44.1k Song !

The sample rate of the song is not 44.1 kHz, so the data cannot be written to the CD-R/RW disc.

Not 512byte/sector

The disk that you are using is not 512 bytes/sector. This disk cannot be used by the VS-890.

Not Ready!

The disk drive is not ready. Wait a short time.

Obey Copyrights ?

This message asks if you agree to the terms and conditions regarding the reproduction, broadcast, and sale of the software. Please carefully read the License Agreement.

Please Insert CD-R Disc !

Either the Roland CD recorder (CD-R/RW drive) loading tray is still open, there is no CD-R/RW disc loaded, or the CD-R/RW drive is otherwise not ready. Insert CD-R/RW disc.

Please Wait...

Operation is in progress. Please wait momentarily.

SCSI ID Error!

The SCSI ID numbers of two or more disk drives are conflicting. Make settings so that the SCSI ID numbers do not conflict.

SPC Not Available!

The SCSI components of the VS-890 have malfunctioned. Contact servicing by your dealer or qualified Roland service personnel.

Song Protected!

Since Song Protect is ON, the operation cannot be executed.

TOC Read Error!

An error occurred in reading from the CD-R/RW disc. There is a problem with the Roland CD recorder (CD-R/RW drive) or the CD-R/RW disc.

Too Many Markers!

You have tried to set track number mark points in excess of the maximum (98) you can set for one CD.

Unformatted!

The disk drive has not been initialized by the VS-890. Initialize the disk drive.

If this appears for a disk drive that has been initialized by the VS-890, there is a problem with the connections to the disk drive. Make sure that the disk drive is connected correctly.

User Aborted!

The procedure has canceled by pressing [EXIT/NO].

Write Another ?

Writing to the disc is complete. Select whether or not you want to write the same data to a new disc. Press [YES] or [NO].

Write Protected!

The disk drive is protected.

Glossary

Active Terminator

A type of terminator (a terminating resistance) placed at each end of a SCSI chain. A new addition to SCSI-2 specifications, compared with ordinary terminators, it provides greater operating stability for SCSI devices, thus improving signal transmission performance.

CD-R

Short for **Compact Disc Recordable**. This is a system for reading and writing discs in the same format as that used for CDs (CD-ROMs and music CDs). A specialized CD-R drive allows one-time only writing of discs.

However, as long as the data has not been finalized and there is sufficient capacity remaining on the disc, the CD-R drive can be used for multiple additions to, and changes in the material.

Sometimes they are referred to as "Write Once CD," "CD-Write Once," or something similar.

CD-RW

Short for **Compact Disc ReWritable**. This is a system allowing creation of discs that can be read using the same format as regular CDs (CD-ROMs and Music CDs). While resembling the CD-R system in that it uses a special CD-RW drive, these discs can be rewritten any number of times.

COSM

Stands for **Composite Object Sound Modeling**. This is "a technology which combines multiple sound models to create new sounds," which was first used on the Roland's VG-8 V-Guitar System. For example, sounds created on the VG-8 are the result of a variety of sound models (elements) such as the pickup, the body of the guitar, the guitar amp, mic, and speaker etc.

Current Song

The song currently being recorded, played back, or edited is referred to as the current song.

DAT

Short for **Digital Audio Tape**. This refers both to the system of recording digitized sound to magnetic tape, as well as to the tapes themselves. Besides digital audio signals, all song information is recorded on the tape, including starts and track data, information to allow or prevent copying, etc.

Finalize

This is the operation that writes the TOC to a prepared audio disc. Whereas additions and changes can be made to discs that have not yet been finalized, such discs are not playable on regular CD players.

Formants

A formant is an important element which determines the character of a vocal sound. It is a fixed overtone whose location is determined by the size of the vocal chords.

Conventional pitch shifters modify the pitch in a way that changes even the location of the formants (which by nature do not change). For example when a conventional pitch shifter raises the pitch, a "duck voice" is produced as if the vocal chords had shrunk, and when the pitch is lowered a "giant voice" is produced as if the vocal chords had expanded.

The Voice Transformer modifies the basic pitch and the formant separately, allowing a variety of voice characters to be created.

Frame

Similar to the individual frames in a roll of movie film, the numerous still pictures that are displayed in rapid succession to create a moving video image are also known as "frames." About thirty of these frames are shown each second. When hard disk recorders, sequencers, and other such equipment are synchronized with video, it is generally assumed that there should be one frame every 1/30th of a second.

GPI

GPI stands for **General Purpose Interface**. This is a control jack provided on professional and consumer video devices such as video editors and title superimposers. By connecting this control jack to the foot switch jack of the VS-890 and setting the Foot Switch Assign to "GPI," the connected device will be able to playback/stop the VS-890.

IDE

IDE stands for **Integrated Device and Electronics**. This is the standard data transmission method used by the hard disk drives of recent personal computers. The HDP88 series hard disk drives (sold separately) that can be installed in the VS-890 are IDE compatible.

MMC

MMC is an acronym for **MIDI Machine Control**. This is a rule that defines how MIDI system exclusive messages can be used to control multiple recording devices from a single device. The VS-890 supports MMC. In addition to song playback, stop and fast-forward, you can also select the tracks for recording, etc.

MTC

MTC stands for **MIDI Time Code**. This is a group of messages which are transmitted and received between MIDI devices to synchronize their operation. Unlike MIDI Clock messages, MTC specifies an absolute time. Like SMPTE time code, MTC also supports a variety of frame rates. If you wish to use MTC to synchronize the operation of two devices, both devices must be set to the same frame rate.

NTSC Format

Color television format used in Japan, the United States, and other countries. Tapes recorded in the NTSC format cannot be played back on video decks utilizing the SECAM/PAL formats.

R-BUS

Roland's digital communication specification developed to allow audio and control data to be exchanged between devices. Multi-channel audio signals, word clock, and MIDI-compatible operation data and synchronization signals can be exchanged. A single R-BUS connector allows simultaneous bi-directional transfer of eight channels of digital audio data. The connector is a DB-25 type, and uses a special cable for connections. It should NOT be connected to other types of ports that use similar connectors! The VS-890 is NOT provided the R-BUS connector.

Removable Disk Drives

Disk drives that have been able to remove the disk, such as a Zip drive, are referred to as the "removable disk drives."

RSS

RSS stands for **Roland Sound System**. This is an effect which allows a sound source to be placed in three-dimensional space when played back on a conventional stereo system. The sound can be placed not only in front of the listener, but also directly to the side, above, below, and behind the listener.

S/P DIF

S/P DIF stands for **Sony/Philips Digital Interface Format**. This is a specifications for transmitting and receiving stereo digital audio signals between digital audio devices. The VS-890 provides coaxial connectors which support S/P DIF.

SCMS

SCMS stands for **Serial Copy Management System**. This is a function that protects the rights of copyright holders by prohibiting recording via a digital connection for more than two generations. When digital connections are made between digital recorders that implement this function, SCMS data will be recorded along with the audio data. Digital audio data which contains this SCMS data cannot again be recorded via a digital connection.

SCSI

SCSI stands for **Small Computer System Interface**. This is a data transmission method that can transmit large amounts of data in a short time. Since the VS-890 has a SCSI connector, external SCSI devices such as hard disks or removable disk drive etc. can be connected.

SECAM Formats/PAL Formats

Color television formats used in Europe and other areas. Tapes recorded in the SECAM or PAL formats cannot be played back on video decks designed for the NTSC format.

Shutdown

In order to turn the power off safely, you must first make sure that the performance has been saved to hard disk, and that the hard disk heads are parked. This procedure is referred to as Shutdown.

SMPTE time code

This is a signal format defined by the American organization SMPTE (Society of Motion Picture and Television Engineers) which is used to synchronize the operation of video or audio devices. SMPTE specifies "hours:minutes:seconds:frames" to indicate the address of each frame of a video image. For this reason, there are a variety of frame rates.

Terminator Power

This refers to the power supplied to external type active terminators.

TOC

Short for Table of Contents. This is the region on the CD-R disc that handles information such as song times, end times, sequence, and so on. Although the songs on a disc and their playing time can be displayed when an audio CD is placed in a CD player, this is because they can be read automatically from the TOC. The TOC is recorded differently than music data, with its main characteristic being disc access, such as the ability to go to the start of any song instantly.

Track Minutes

The amount of available recording time that is called for a standard unit corresponding to the time of one continuous monaural signal recorded to one track.

Zip Drive

A magnetic disk drive format standardized by Iomega Corporation. Disks that can be used for reading and writing data with Zip drives are call Zip disks. Similar to 3.5-inch floppy disks in size and usage, one Zip disk can store 100 MB of data.

Special Key Operations

Here is a list of the functions that can be performed by pressing multiple buttons, or using the **TIME/VALUE** dial in conjunction with a button.

■ SELECT/CH EDIT buttons

[SHIFT] + [Assign (SELECT 1)]:	To the Assign setting page (Track Mixer)
[SHIFT] + [V.Track (SELECT 2)]:	To the V-track setting page (Track Mixer)
[SHIFT] + [EQ Low (SELECT 3)]:	To the Equalizer low gain/Frequency setting page (When EQ Sw is On)
[SHIFT] + [EQ Mid (SELECT 4)]:	To the Equalizer mid gain setting page (When EQ Sw is On, using 3bandEQ)
[SHIFT] + [EQ HI (SELECT 5)]:	To the Equalizer high gain/Frequency setting page (When EQ Sw is On)
[SHIFT] + [AUX Send (SELECT 6)]:	To the AUX switch setting page
[SHIFT] + [EFFECT-1 (SELECT 7)]:	To the Effect 1 switch setting page
[SHIFT] + [EFFECT-2 (SELECT 8)]:	To the Effect 2 switch setting page
[STATUS] + SELECT buttons:	Select source to be recorded on the track (Input Mixer)
[STATUS] + SELECT buttons:	Select track to be recorded on the track (Track Mixer; Track bouncing)
[STATUS] + SELECT buttons:	Select effect return and stereo in to be recorded on the track (Effect Return Mixer)
[AUTOMIX] + SELECT buttons:	Select whether auto-mix will be recorded/played/ignored for each channel (when Automix is On)
[SHIFT] + [SOLO (EZ ROUTING)]:	Solo mode on/off
[SHIFT] + [EDIT (FADER)]:	To the Master block setting page

■ EDIT CONDITION buttons

[SHIFT] + [SYSTEM]:	Switch the sync source
[SHIFT] + [SONG]:	Display various information about the song (Play condition)
[SHIFT] + [EFFECT]:	Switch between the effect select page, effect name page, and effect on/off page (Effect condition)

■ Transport Control buttons

[SHIFT] + [STORE (ZERO)]:	Store song data to the disk drive
[SHIFT] + [SONG TOP (REW)]:	Move to the time where the first sound of the song is recorded
[SHIFT] + [SONG END (FF)]:	Move to the time where the last sound of the song is recorded
[SHIFT] + [SHUT/EJECT (STOP)]:	Shut down
[SHIFT] + [RESTART (PLAY)]:	Restart (after shut down)
[REC] + [STATUS]:	Switch the track status to REC (STATUS indicator blinks red)
[STOP] + [STATUS]:	Switch the track status to PLAY (STATUS indicator lights green)

■ LOCATOR buttons

[SHIFT] + LOC buttons ([1/5]–[4/8]):	Register a locator 5–8
[CLEAR] + LOC buttons ([1/5]–[4/8]):	Clear the setting of a locator 1–4
[SHIFT] + [CLEAR] + LOC buttons ([1/5]–[4/8]):	Clear the setting of a locator 5–8
[CLEAR] + [TAP]:	Erase marker
[CLEAR] + [SHIFT] + [TAP] → [YES]:	Erase all markers
[CD-RW (MASTERING)] + [TAP]:	Register a marker for audio CD track number
[CD-RW (MASTERING)] + [PREVIOUS ◀]:	Move to the previous track number marker
[CD-RW (MASTERING)] + [NEXT ▶]:	Move to the next track number marker
[LOCATOR] + [LOC1/5]–[LOC4/8]:	Switch locate banks
[TRACK] + [START (LOC1/5)]:	Enter the current time as track edit “St” (start point)
[TRACK] + [FROM (LOC2/6)]:	Enter the current time as track edit “Frm” (from point)
[TRACK] + [END (LOC3/7)]:	Enter the current time as track edit “End” (end point)
[TRACK] + [TO (LOC4/8)]:	Enter the current time as track edit “To” (to point)
[SHIFT] + [TAP]:	To the Tempo Map setting page

■ AUTOMIX buttons

[AUTOMIX] + [TAP]:	Execute Snapshot (when Automix is On)
[AUTOMIX] + [PREVIOUS ◀]:	Gradation to mixer setting of previous marker (when Automix is On)
[AUTOMIX] + [NEXT ▶]:	Gradation to mixer setting of next marker (when Automix is On)
[AUTOMIX] + [REC]:	Automix Realtime recording (when Automix is On)

■ Other

[SHIFT] + [DISPLAY (PLAY)]:	Switch the bar display
[SHIFT] + [AUTOMIX]:	Vari pitch On/Off
[SHIFT] + [REDO (UNDO)]:	Execute Redo (when UNDO indicator lights)
[SHIFT] + [NUMERICS (SCENE)]:	Numerics function On/Off
[SHIFT] + [SCRUB]:	To the Scrub length setting page
[SHIFT] + [TO]:	To the Preview length setting page
[SHIFT] + [FROM]:	To the Preview length setting page
[SHIFT] + CURSOR [◀]:	When modifying the time, move the cursor left
[SHIFT] + CURSOR [▶]:	When modifying the time, move the cursor right
[SHIFT] + PARAMETER [◀◀]:	Select previous effect parameter (Effect edit condition)
[SHIFT] + PARAMETER [▶▶]:	Select next effect parameter (Effect edit condition)
[TO] + [FROM]:	Execute preview thru
STATUS buttons + [CLEAR]:	Cancel all routing
[PLAY] + TIME/VALUE dial:	Adjust the Display contrast
[PLAY (DISPLAY)] + [SCENE]:	Transmit the condition of the mixer as MIDI data from the MIDI OUT connector
[SHIFT] + TIME/VALUE dial:	Modify the value at 10 times the usual speed
	In Play condition, move the current time in 10-frame units
	In Play condition when an “←” is displayed at the beginning of the time code display, move the current time in units of approximately 1/100 frame

Parameter List

■ Input Mixer — Press [FADER (EDIT)] to let the FADER indicator lights orange.

Parameter name	Display	Value, Initial value
Attenuator	ATT	-12-0-+12 dB
Phase	Phase	NRM , INV
Mix Switch	MIX Sw	Off, On
Offset Level	Ofs Level	0- 100 -127 (*1)
Mix Level	MIX Level	0- 100 -127
Offset Balance	Ofs Bal	L63- 0 -R63 (*2)
Mix Pan/Balance	MIX Pan/MIX Bal	L63- 0 -R63 (*3)
Equalizer Switch	EQ Switch	Off, On (*10)
Equalizer Low Gain	EQL	-12- 0 -12 dB (*10)
Equalizer Low Frequency	EQL	40 Hz- 300 Hz -1.5 kHz (*10)
Equalizer Mid Gain	EQM	-12- 0 -12 dB (*4) (*10)
Equalizer Mid Q	EQM Q	0.5 -16 (*4) (*10)
Equalizer Mid Frequency	EQM F	200 Hz- 1.4 kHz -8 kHz (*4) (*10)
Equalizer High Gain	EQH	-12- 0 -12 dB (*10)
Equalizer High Frequency	EQH	500 Hz- 4 kHz -18 kHz (*10)
AUX Switch	AUX Sw	Off , PreFade, PstFade
AUX Level	AUX Level	0- 100 -127 (*7)
AUX Pan/Balance	AUX Pan/AUX Bal	L63- 0 -R63 (*3) (*7)
Channel Link	Channel Link	Off , On
Fader Link	Fader Link	Off , On
Effect 1 Insert Switch	FX1 Ins	Off , Insert, InsertL, InsertR, InsertS
Effect 1 Insert Send Level	FX1 InsSend	0-127 dB (*5)
Effect 1 Insert Return Level	FX1 InsRtn	0-127 dB (*5)
Effect 1 Send Switch	EFFECT1	Off , Prefade, PstFade
Effect 1 Send Level	EFFECT1 Send	0- 100 -127 (*8)
Effect 1 Pan/Balance	EFFECT1 Pan/Bal	L63- 0 -R63 (*3) (*8)
Effect 2 Insert Switch	FX2 Ins	Off , Insert, InsertL, InsertR, InsertS
Effect 2 Insert Send Level	FX2 InsSend	0-127 dB (*6)
Effect 2 Insert Return Level	FX2 InsRtn	0-127 dB (*6)
Effect 2 Send Switch	EFFECT2	Off , PreFade, PstFade
Effect 2 Send Level	EFFECT2 Send	0- 100 -127 (*9)
Effect 2 Pan/Balance	EFFECT2 Pan/Bal	L63- 0 -R63 (*3) (*9)

*1 Valid when Channel Link or Fader Link is "On."

*2 Valid when Channel Link is "On."

*3 If Channel Link is On, the "Pan" parameter will change to the balance parameter.

*4 Valid when Master Block Equalizer Select is "3 Band EQ."

*5 Valid when Effect 1 Insert Switch is except "Off."

*6 Valid when Effect 2 Insert Switch is except "Off."

*7 Valid when AUX Switch is except "Off."

*8 Valid when Effect 1 Send Switch is except "Off."

*9 Valid when Effect 2 Send Switch is except "Off."

*10 Valid when Record Mode is except "VSR."

■ Track Mixer — Press [FADER (EDIT)] to let the FADER indicator lights green.

Parameter name	Display	Value, Initial value
Assign	Assign ***	Off, On (*1)
Attenuator	ATT	-12-0-+12 dB
Phase	Phase	NRM , INV
Mix Switch	MIX Sw	Off, On
Offset Level	Ofs Level	0- 100 -127
Mix Level	MIX Level	0- 100 -127
Offset Balance	Ofs Bal	L63- 0 -R63 (*3)
Mix Pan/Balance	MIX Pan/MIX Bal	L63- 0 -R63 (*4)
V-Track	V.Track	1-8
Equalizer Switch	EQ Switch	Off, On (*11)
Equalizer Low Gain	EQL	-12- 0 -12 dB (*11)
Equalizer Low Frequency	EQL	40 Hz- 300 Hz -1.5 kHz (*11)
Equalizer Mid Gain	EQM	-12- 0 -12 dB (*5) (*11)
Equalizer Mid Q	EQM Q	0.5 -16 (*5) (*11)
Equalizer Mid Frequency	EQM F	200 Hz- 1.4 kHz -8 kHz (*5) (*11)
Equalizer High Gain	EQH	-12- 0 -12 dB (*11)
Equalizer High Frequency	EQH	500 Hz- 4 kHz -18 kHz (*11)

Parameter name	Display	Value, Initial value
AUX Switch	AUX Sw	Off, PreFade, PstFade
AUX Level	AUX Level	0-100-127 (*8)
AUX Pan/Balance	AUX Pan/AUX Bal	L63-0-R63 (*4) (*8)
Channel Link	Channel Link	Off, On
Fader Link	Fader Link	Off, On
Effect 1 Insert Switch	FX1 Ins	Off, Insert, InsertL, InsertR, InsertS
Effect 1 Insert Send Level	FX1 InsSend	0-127 dB (*6)
Effect 1 Insert Return Level	FX1 InsRtn	0-127 dB (*6)
Effect 1 Send Switch	EFFECT1	Off, PreFade, PstFade
Effect 1 Send Level	EFFECT1 Send	0-100-127 (*9)
Effect 1 Pan/Balance	EFFECT1 Pan/Bal	L63-0-R63 (*4) (*9)
Effect 2 Insert Switch	FX2 Ins	Off, Insert, InsertL, InsertR, InsertS
Effect 2 Insert Send Level	FX2 InsSend	0-127 dB (*7)
Effect 2 Insert Return Level	FX2 InsRtn	0-127 dB (*7)
Effect 2 Send Switch	EFFECT2	Off, Prefade, PstFadeOff
Effect 2 Send Level	EFFECT2 Send	0-100-127 (*10)
Effect 2 Pan/Balance	EFFECT2 Pan/Bal	L63-0-R63 (*4) (*10)

- *1 ***=IN1-IN8, TR1-TR8, FX1, FX2, StIn
- *2 Valid when Channel Link or Fader Link is "On."
- *3 Valid when Channel Link is "On."
- *4 If Channel Link is On, the "Pan" parameter will change to the balance parameter.
- *5 Valid when Master Block Equalizer Select is "3 Band EQ."
- *6 Valid when Effect 1 Insert Switch is except "Off."
- *7 Valid when Effect 2 Insert Switch is except "Off."
- *8 Valid when AUX Switch is except "Off."
- *9 Valid when Effect 1 Send Switch is except "Off."
- *10 Valid when Effect 2 Send Switch is except "Off."
- *11 Valid when Record Mode is except "VSR."

■ Stereo In/Effect Return — Press [FADER (EDIT)] to let the FADER indicator lights red.

Parameter name	Display	Value, Initial value
Stereo In Select	StereoIn	Off, Input12, Input34, Input56, Input78
Stereo In Level	StIn Level	0-100-127 (*)
Stereo In Balance	StIn Bal	L63-0-R63 (*)
Effect 1 Return Level	FX1 RTN Lev	0-100-127
Effect 1 Return Balance	FX1 RTN Bal	L63-0-R63
Effect 2 Return Level	FX2 RTN Lev	0-100-127
Effect 2 Return Balance	FX2 RTN Bal	L63-0-R63

- * Valid when Stereo In Select is except "Off."

■ Master Block [SHIFT] + [EDIT (FADER)]

Parameter name	Display	Value, Initial value
Master Select	Master Sel	MIX, AUX, FX1, FX2, REC
Master Level	MasterLevel	0-100-127
Master Balance	Master Bal	L63-0-R63
AUX Out	AUX Out	AUX, FX1, FX2
AUX Send Level	AUX Level	0-100-127
AUX Send Balance	AUX Bal	L63-0-R63
Effect 1 Insert Switch	FX1 Ins Sw	Off, On
Effect 1 Insert Send Level	FX1 Ins Send	0-100-127 (*1)
Effect 1 Insert Return Level	FX1 Ins Rtn	0-100-127 (*1)
Effect 1 Send Level	FX1 SND Lev	0-100-127
Effect 1 Send Balance	FX1 SND Bal	L63-0-R63
Effect 2 Insert Switch	FX2 Ins Sw	Off, On
Effect 2 Insert Send Level	FX2 Ins Send	0-100-127 (*2)
Effect 2 Insert Return Level	FX2 Ins Rtn	0-100-127 (*2)
Effect 2 Send Level	FX2 SND Lev	0-100-127
Effect 2 Send Balance	FX2 SND Bal	L63-0-R63
Equalizer Select	EQ Sel	2BandEQ, 3BandEQ
Digital Out 1	DigitalOut1	MST, AUX, FX1, FX2 1-2, 3-4, 5-6, 7-8

Parameter List

Parameter name	Display	Value, Initial value
Digital Out 2	DigitalOut2	MST , AUX, FX1, FX2 1-2, 3-4, 5-6, 7-8
Direct Out	Direct Out	Off , 1-4, 5-8

*1 Valid when Effect 1 Insert Switch is "On."

*2 Valid when Effect 2 Insert Switch is "On."

■ System Parameter [SHIFT] → "SYSTEM PRM?" → [YES]

Parameter name	Display	Value, Initial value
Master Clock	MasterClk	INT , D, COA, D.OPT, R-BUS
Time Display Format	Time Disp Fmt	ABS , REL
Offset	Ofs	00h00m00s00 -23h59m59s29 (*1)
Marker Stop	Marker Stop	Off , On
Record Monitor	Record Mon	AUTO , SOURCE
Vari Pitch Mode	V.Pitch Mode	Off , On
Vari Pitch	Vari Pitch	21.96- 48.00 kHz -50.43 kHz (48.00 kHz) 22.05- 44.10 kHz -50.48 kHz (44.1 kHz) 21.96- 32.00 kHz -50.43 kHz (32.00 kHz)
Foot Switch Assign	FootSw	Play/Stop , Record, TapMarker, Next, Previous, GPI
Fade Length	Fade Length	2, 10 , 20, 30, 40, 50 ms
Scrub Length	Scrub Len	25- 45 -100 ms
Preview Length	Preview Len	1.0 -10.0 s
Metronome Out	MetroOut	Off , INT, MIDI
Metronome Level	MetroLevel	0- 100 -127 (*2)
Metronome Mode	MetroMd	Rec Only , Rec&Play (*3)
Undo Message	UNDO MSG	Off, On
LCD Contrast	LCD Contrast	0-7-15
Remaining Display	RemainDsp	Time , CapaMB, Capa%, Event
Measure Display	MeasurDsp	Always , Auto
Digital Copy Protect Switch	D.CpyProtect	Off , On
Shift Lock	Shift Lock	Off , On
Numerics Type	NUMERICSType	Up , Dwn
Fader Match	FaderMatch	Null , Jump
Peak Hold Switch	PeakHoldSw	Off , On
System Parameter Keep Switch	SysPrmKeepSw	Off , On
V-Track Bank	V.Track Bank	A , B
Switching Time	SwitchTime	0.3- 0.5 -2.0 sec
Peak Level	Peak Level	CLIP, -3 dB, -6 dB
DC Cut Switch	DC Cut Sw	Off, On
CD Digital Recording	CD DigiREC	Off , On

*1 The settable value for Offset will change slightly depending on the MTC type.

*2 Valid when Metronome Out is "INT."

*3 Valid when Metronome Out is except "Off."

■ MIDI Parameter [SYSTEM] → "MIDI PRM?" → [YES]

Parameter name	Display	Value, Initial value
Device ID	DeviceID	1-17-32
MIDI through Switch	MIDI Thr	Out , Thru
System Exclusive Receive Switch	SysEx.Rx	Off, On
System Exclusive Transmit Switch	SysEx.Tx	Off , On
MMC Mode	MMC	Off/RBUS, MASTER , SLAVE
Metronome Channel	MetroCh	1- 10 -16 (*)
Accent Note	Acc.Note	C_0- C*2 -G_9 (*)
Accent Velocity	Acc.Velo	1- 100 -127 (*)
Normal Note	Nrm.Note	C_0- C*2 -G_9 (*)
Normal Velocity	Nrm.Velo	1- 60 127 (*)
Mixer Local Control Switch	CtrlLocal	Off, On
Control Type	Ctrl Type	Off , C.C., Excl
Program Change Scene	P.C.Scne	Off , On
Program Change Effect	P.C.Eff	Off , On
Control Change Effect	C.C.Eff	Off , On
Model ID	ModelID	890 , 88EX

* Valid when Metronome Out is "MIDI."

■ **Disk Parameter [SYSTEM] → “DISK PRM?” → [YES]**

Parameter name	Display	Value, Initial value
IDE Drive	IDE Drv	Off, On
SCSI Self ID	SCSI Self	0-7

■ **Sync/Tempo Parameter [SYSTEM] → “Sync/Tempo?” → [YES]**

Parameter name	Display	Value, Initial value
Sync Source	Source	INT, EXT
Sync Generator	Gen.	Off, MTC, MIDclk, SyncTr, R-BUS
Error Level	ErrLevel	0-5-10
MTC Type	MTC Type	30, 29N, 29D, 25, 24
Offset	Ofs	00h00m00s00-23h59m59s29 (*)

* The settable value for Offset will change slightly depending on the MTC type.

■ **Sync Track Convert [SYSTEM] → “Sync/Tempo?” → [YES] → PARAMETER [▶▶] → “Sync.Tr Cnv?” → [YES]**

Parameter name	Display	Value, Initial value
Beat	Beat	1/1-8/1, 1/2-8/2, 1/4-4/4-8/4, 1/8-8/8
Tap Beat	Tap Beat	1-4-8
Sync Track Beat	Sync Trk Beat	1/1-8/1, 1/2-8/2, 1/4-4/4-8/4, 1/8-8/8
Start Time	Start Time	00h00m00s00-23h59m59s29 (*)
End Time	End Time	00h00m00s00-23h59m59s29 (*)
Measure	Measure	1-999

* The settable value for Start Time/End Time will change slightly depending on the MTC type.

■ **Tempo Map [SHIFT] + [TAP]**

Parameter name	Display	Value, Initial value
Tempo Map Number	(none)	1-501
Tempo	(none)	25.0-250.0120.0
Measure	MEASURE	1-9991
Beat	BEAT	1/1-8/1, 1/2-8/2, 1/4-8/4, 1/8-8/8/4

■ **Scene/Automix [SYSTEM] → “Sync/Tempo?” → [YES]**

Parameter name	Display	Value, Initial value
Scene Mode	Scene Mode	All, KeepM
Auto Mix Mode	A.Mix Mode	Off, On
Auto Mix Snapshot Mode	A.Mix Snap	ALL, MaskM
Erase From	(none)	0-999
Erase To	(none)	0-999
Erase Mode	Erase Mode	Event, Marker

■ **Drive Initialize [SYSTEM] → “DriveInitialize?” → [YES]**

Parameter name	Display	Value, Initial value
Initialize Drive	Init Drive	IDE, SC0-SC7
Physical Format	PhysicalFmt	Off, On
Partition	Partition	500, 1000 MB
Surface Scan	SurfaceScan	Off, On

Preset Patch List

On the VS-890, you can access the range of effects listed below.

Snd/Rtn: Direct Level is set to "0." Connect this Patch to the effects bus.

Insert: This Patch mixes the direct sound and effected sound. Insert it into a channel.

You cannot select preset Patches A00–A21, A80, A97, B98 or C10–C28 for FX2. These Patches must be used for FX1.

■ Reverb (18 presets)

No.	Patch Name	Algorithm	Type	Input	Comment
A00	RV:LargeHall	Reverb	Snd / Rtn	Mono	Large concert hall reverberation.
A01	RV:SmallHall	Reverb	Snd / Rtn	Mono	Small hall reverberation.
A02	RV:Strings	Reverb	Snd / Rtn	Mono	Reverberation optimized for delicate highs of strings.
A03	RV:PianoHall	Reverb	Snd / Rtn	Mono	Rich and warm reverberation optimized for pianos.
A04	RV:Orch Room	Reverb	Snd / Rtn	Mono	Reverberation of large-capacity rooms such as big banquet halls.
A05	RV:VocalRoom	Reverb	Snd / Rtn	Mono	Room reverb suitable for vocals and chorus.
A06	RV:MediumRm	Reverb	Snd / Rtn	Mono	Warm and naturally spacious room reverb.
A07	RV:LargeRoom	Reverb	Snd / Rtn	Mono	Simulated acoustics of wide rooms with lots of reverberation.
A08	RV:CoolPlate	Reverb	Snd / Rtn	Mono	Distinctive bright plate reverb.
A09	RV:Short Plt	Reverb	Snd / Rtn	Mono	Shorter plate reverb.
A10	RV:Vocal Plt	Reverb	Snd / Rtn	Mono	Crystal-clear reverb optimized for vocals.
A11	RV:Soft Amb.	Reverb	Snd / Rtn	Mono	Simulated reverberation of a room with minimal wall reflections.
A12	RV:Room Amb.	Reverb	Snd / Rtn	Mono	Natural reverberation of rooms with good acoustics, suitable for drums and guitars.
A13	RV:Cathedral	Reverb	Snd / Rtn	Mono	Acoustics of a very large, high-ceilinged church.
A14	RV:Long Cave	Reverb	Snd / Rtn	Mono	Simulated reverberation of deep caves.
A15	RV:GarageDr.	Reverb	Snd / Rtn	Mono	Natural reverb that enhances unique drum sounds.
A16	RV:Rock Kick	Reverb	Snd / Rtn	Mono	Reverb with many low-frequency components, suitable for rock kicks.
A17	RV:RockSnare	Reverb	Snd / Rtn	Mono	Rich and thick sounding reverb suitable for rock snares.

■ Gate Reverb (4 presets)

No.	Patch Name	Algorithm	Type	Input	Comment
A18	RV:BrightGate	Gate Reverb	Snd / Rtn	Mono	Slightly brighter gate reverb.
A19	RV:Fat Gate	Gate Reverb	Snd / Rtn	Mono	Dynamic reverb sound with powerful mids and lows.
A20	RV:ReverseGt	Gate Reverb	Snd / Rtn	Mono	A reverse gate commonly used as a special effect.
A21	RV:PanningGt	Gate Reverb	Snd / Rtn	Mono	A special effect with gate reverb shifting from left to right.

■ Delay (9 presets)

No.	Patch Name	Algorithm	Type	Input	Comment
A22	DL:Short Dly	Delay	Snd / Rtn	Mono	An ambience effect that adds depth to the sound by doubling.
A23	DL:MediumDly	Delay	Snd / Rtn	Mono	Natural echo optimized for vocals.
A24	DL:LongDelay	Delay	Snd / Rtn	Mono	Long delay suited for brass and analog synth solos.
A25	DL:AnalogDly	Delay	Snd / Rtn	Mono	Analog sound with gradually diminishing feedbacking highs.
A26	DL:Tape Echo	Stereo Delay Chorus	Snd / Rtn	Stereo	Simulated tape echo with distinctive wow flutter.
A27	DL:Karaoke	Stereo Delay Chorus	Snd / Rtn	Stereo	Intense reverberation that effectively enhances karaoke vocals.
A28	DL:Multi-Tap	Stereo Delay Chorus	Snd / Rtn	Stereo	Spacious reflections using positioning delay at any point along the stereo soundfield.
A29	DL:MitTapAmb	Multi Tap Delay	Snd / Rtn	Mono	An ambience effect using 10 short delay units.
A30	DL:Ping Pong	Multi Tap Delay	Snd / Rtn	Mono	A special effect using tap delay.

■ Vocal (10 presets)

No.	Patch Name	Algorithm	Type	Input	Comment
A31	VO:Vocal Efx	Vocal Multi	Insert	Mono	Basic setup for recording/mixdown of vocals.
A32	VO:JazzVocal	Vocal Multi	Insert	Mono	A natural sounding jazz club-like ambience for warm reverb well-suited for vocals.
A33	VO:RockVocal	Vocal Multi	Insert	Mono	Sound featuring limiter/enhancer processing as well as a unison effect.
A34	VO:Narration	Vocal Multi	Insert	Mono	An effect with heavy compression, used for narration.
A35	VO:BigChorus	Vocal Multi	Insert	Mono	A spacious-sounding stereo effect similar to increasing the number of vocalists.
A36	VO:Club DJ	Vocal Multi	Insert	Mono	A club DJ-tailored effect that uses a pitch shifter to make voices lower.
A37	VO:AM-Radio	Vocal Multi	Insert	Mono	Sound featuring hard compression and narrower frequency range.
A38	VO:PlusTwo	Stereo PSD	Insert	Stereo	A special effect that adds two more voices using a pitch shifter.
A39	VO:Robot Efx	Stereo PSD	Insert	StereoSF	movie-like effect using a pitch shifter.
A40	VO:Bull Horn	Guitar Multi 3	Insert	Mono	Simulated effect of sound produced from a Bull Horn or old radio.

* PSD = Pitch Shifter Delay

■ Guitar (11 presets)

No.	Patch Name	Algorithm	Type	Input	Comment
A41	GT:Rock Lead	Guitar Multi 2	Insert	Mono	Straight distortion sound with delay.
A42	GT:LA Lead	Guitar Multi 2	Insert	Mono	Lead guitar sound with tasty compression and chorus applied.
A43	GT:MetalLead	Guitar Multi 1	Insert	Mono	Metal sound with dynamic, ultrahigh gain distortion.
A44	GT:Metal Jet	Guitar Multi 1	Insert	Mono	Distortion together with a metallic effect achieved by flanging.
A45	GT:CleanRthm	Guitar Multi 1	Insert	Mono	Clean sound with compression and chorus applied.

No.	Patch Name	Algorithm	Type	Input	Comment
A46	GT:DledClean	Vocal Multi	Insert	Mono	Superclean sound like line recording directly into the console.
A47	GT:Delay Rif	Guitar Multi 2	Insert	Mono	Delay sounds at dotted eighth note intervals when a 120 BPM riff is played.
A48	GT:Acoustic	Vocal Multi	Insert	Mono	Optimized for electroacoustic guitars.
A49	GT:BluesDrv.	Guitar Multi 3	Insert	Mono	Crunchy overdrive sound suited to blues and R&R.
A50	GT:Liverpool	Guitar Multi 3	Insert	Mono	Crunchy sound often heard on '60s British rock.
A51	GT:Country	Guitar Multi 3	Insert	Mono	Clean sound featuring distinctive compression and delay.

■ Guitar Amp Simulator (9 presets)

No.	Patch Name	Algorithm	Type	Input	Comment
A52	GA:JazChorus	Guitar Amp Sim.	Insert	Mono	Roland JC-120 amp. Sounds more authentic when used with chorus for mixdown.
A53	GA:CleanTwin	Guitar Amp Sim.	Insert	Mono	U.S. tube combo amp circa "black panel."
A54	GA:Vin.Tweed	Guitar Amp Sim.	Insert	Mono	'50s U.S. tube amp overdrive.
A55	GA:BluesDrv.	Guitar Amp Sim.	Insert	Mono	Old British amp crunchy overdrive.
A56	GA:MatchLead	Guitar Amp Sim.	Insert	Mono	Hot-rodged British combo amp.
A57	GA:StudioCmb	Guitar Amp Sim.	Insert	Mono	Favourite late '70s amp of studio musicians.
A58	GA:JMP-Stack	Guitar Amp Sim.	Insert	Mono	Late '60s British stacks.
A59	GA:SLDN Lead Sim.	Guitar Amp	Insert	Mono	An '80s amp known for versatile distortion.
A60	GA:5150 Lead Sim.	Guitar Amp	Insert	Mono	Big tube amp standard for American heavy metal.

* Sim. = Simulator

■ Bass (5 presets)

No.	Patch Name	Algorithm	Type	Input	Comment
A61	BS:Dl'edBass	Vocal Multi	Insert	Mono	Slight limiting and equalization optimized, ideal for line recording applications.
A62	BS:MikedBass	Guitar Amp Sim.	Insert	Mono	A miked speaker box with four 12"s.
A63	BS:CompBass	Stereo Multi	Insert	Stereo	Hard-compressed sound optimized for slaps.
A64	BS:Auto Wah	Guitar Multi 2	Insert	Mono	Synth bass like sound added with auto wah essential for '70s funk.
A65	BS:EFX Bass	Stereo Delay Chorus	Insert	Stereo	Solo-optimized sound with depth and spaciousness added through delay and chorus.

* Sim. = Simulator

■ Stereo Multi (5 presets)

No.	Patch Name	Algorithm	Type	Input	Comment
A66	CL:Comp	Stereo Multi	Insert	Stereo	Stereo type compression optimized for broadcast mixing.
A67	CL:Limiter	Stereo Multi	Insert	Stereo	A convenient effect for analog mastering because it can limit peak signals.
A68	EQ:Loudness	Stereo Multi	Insert	Stereo	Applies EQ curve with slightly boosted lows and highs.
A69	EQ:Fat Dance	Stereo Multi	Insert	Stereo	Hard compression plus equalizing for dance music.
A70	EQ:ThinJingl	Stereo Multi	Insert	Stereo	Limiter and EQ processing for FM radio and TV broadcasting.

■ Chorus/Flanger/Phaser/Pitch Shifter (9 presets)

No.	Patch Name	Algorithm	Type	Input	Comment
A71	CH:Lt Chorus	Stereo Delay Chorus	Insert	Stereo	Natural stereo chorus with shallow depth for spacious, crystal-clear sound.
A72	CH:Deep Cho	Stereo Delay Chorus	Insert	Stereo	Intense stereo chorus that adds depth and spaciousness to the sound.
A73	CH:DetuneCho	Stereo PSD	Insert	Stereo	Chorus with left and right channels separately pitch shift-detuned up and down.
A74	FL:LtFlanger	Stereo Flanger	Insert	Stereo	Stereo flanger with slight modulation.
A75	FL:Deep Fl	Stereo Flanger	Insert	Stereo	Deeper stereo flanger for metallic jet swooshing sound.
A76	PH:Lt Phaser	Stereo Phaser	Insert	Stereo	Lighter 4-stage stereo phaser suitable for synth strings.
A77	PH:DeepPhase	Stereo Phaser	Insert	Stereo	Deep phaser effective for electronic piano and clavinet sounds.
A78	PS:4thVoice	Vocal Multi	Insert	Mono	Adds sound down a fourth to the direct sound.
A79	PS:ShimmerUD	Stereo PSD	Insert	Stereo	A special effect with left channel pitch rising and right channel pitch dropping over time.

* PSD = Pitch Shifter Delay

■ Same as Algorithm (20 presets)

No.	Patch Name	Algorithm	Type	Input	Comment
A80	Reverb	Reverb	Snd / Rtn	Mono	(p. 26)
A81	Delay	Delay	Snd / Rtn	Mono	(p. 28)
A82	StDly-Chorus	Stereo Delay Chorus	Insert	Stereo	(p. 30)
A83	StPS-Delay	Pitch Shifter Delay	Insert	Stereo	(p. 32)
A84	Vocoder	Vocoder	Insert	Mono	(p. 34)
A85	2ch RSS	2ch RSS	Insert	2ch	(p. 35)
A86	Delay RSS	Delay RSS	Insert	Mono	(p. 37)
A87	Chorus RSS	Chorus RSS	Insert	Mono	(p. 38)
A88	GuitarMulti1	Guitar Multi 1	Insert	Mono	(p. 39)
A89	GuitarMulti2	Guitar Multi 2	Insert	Mono	(p. 39)
A90	GuitarMulti3	Guitar Multi 3	Insert	Mono	(p. 39)

Preset Patch List

No.	Patch Name	Algorithm	Type	Input	Comment
A91	Vocal Multi	Vocal Multi	Insert	Mono	(p. 42)
A92	Rotary	Rotary	Insert	Mono	(p. 44)
A93	GuitarAmpSim	Guitar Amp Sim.	Insert	Mono	(p. 44)
A94	St Phaser	Stereo Phaser	Insert	Stereo	(p. 47)
A95	St Flanger	Stereo Flanger	Insert	Stereo	(p. 49)
A96	DualComp/Lim	Dual Compressor/Limiter	Insert	2ch	(p. 50)
A97	Gate Reverb	Gate Reverb	Snd/Rtn	Mono	(p. 52)
A98	MultiTapDly	Multi Tap Delay	Insert	Mono	(p. 54)
A99	Stereo Multi	Stereo Multi	Insert	Stereo	(p. 56)

■ Reverb2 (20 presets)

No.	Patch Name	Algorithm	Type	Input	Comment
B00	R2:LargeHall	Reverb2	Snd/Rtn	Mono	Large concert hall reverberation.
B01	R2:SmallHall	Reverb2	Snd/Rtn	Mono	Small hall reverberation.
B02	R2:Strings	Reverb2	Snd/Rtn	Mono	Reverberation optimized for delicate highs of strings.
B03	R2:PianoHall	Reverb2	Snd/Rtn	Mono	Rich and warm reverberation optimized for pianos.
B04	R2:Orch Room	Reverb2	Snd/Rtn	Mono	Reverberation of large-capacity rooms such as big banquet halls.
B05	R2:VocalRoom	Reverb2	Snd/Rtn	Mono	Room reverb suitable for vocals and chorus.
B06	R2:MediumRm	Reverb2	Snd/Rtn	Mono	Warm and naturally spacious room reverb.
B07	R2:LargeRoom	Reverb2	Snd/Rtn	Mono	Simulated acoustics of wide rooms with lots of reverberation.
B08	R2:CoolPlate	Reverb2	Snd/Rtn	Mono	Distinctive bright plate reverb.
B09	R2:Short Plt	Reverb2	Snd/Rtn	Mono	Shorter plate reverb.
B10	R2:Vocal Plt	Reverb2	Snd/Rtn	Mono	Crystal-clear reverb optimized for vocals.
B11	R2:Soft Amb.	Reverb2	Snd/Rtn	Mono	Simulated reverberation of a room with minimal wall reflections.
B12	R2:Room Amb.	Reverb2	Snd/Rtn	Mono	Natural reverberation of rooms with good acoustics, suitable for drums and guitars.
B13	R2:Cathedral	Reverb2	Snd/Rtn	Mono	Acoustics of a very large, high-ceilinged church.
B14	R2:Long Cave	Reverb2	Snd/Rtn	Mono	Simulated reverberation of deep caves.
B15	R2:GarageDr.	Reverb2	Snd/Rtn	Mono	Natural reverb that enhances unique drum sounds.
B16	R2:Rock Kick	Reverb2	Snd/Rtn	Mono	Reverb with many low-frequency components, suitable for rock kicks.
B17	R2:RockSnare	Reverb2	Snd/Rtn	Mono	Rich and thick sounding reverb suitable for rock snares.
B18	R2:BriteGte2	Reverb2	Snd/Rtn	Mono	A high-density and bright sounding gated reverb. Adjust Threshold.
B19	R2:Fat Gate2	Reverb2	Snd/Rtn	Mono	A high-density and warm sounding gated reverb. Adjust Threshold.

■ Mic Simulator (22 presets)

No.	Patch Name	Algorithm	Type	Input	Comment
B20	MS:57'58	Mic Simulator	Insert	2ch	Converts a general-purpose D. mic to a vocal D. mic. Rich mid/low range.
B21	MS:57'421	Mic Simulator	Insert	2ch	Converts a general-purpose D. mic to a large D. mic. For drums and guitar amp.
B22	MS:57'451	Mic Simulator	Insert	2ch	Converts a general-purpose D. mic to a small C. mic. For acoustic guitar and cymbals.
B23	MS:57'87	Mic Simulator	Insert	2ch	Converts a general-purpose D. mic to a large C. mic. For vocals and acoustic inst.
B24	MS:57'47	Mic Simulator	Insert	2ch	Converts a general-purpose D. mic to a vintage C. mic. For vocals and acoustic inst.
B25	MS:57'Line	Mic Simulator	Insert	2ch	Cancels the characteristics of D.mic, giving the sound a flat frequency response.
B26	MS:DR20'421	Mic Simulator	Insert	2ch	Converts a Roland DR-20 to an instrumental D. mic. For drums and guitar amp.
B27	MS:DR20'451	Mic Simulator	Insert	2ch	Converts a Roland DR-20 to a small C. mic. For acoustic guitar and cymbals.
B28	MS:DR20'87	Mic Simulator	Insert	2ch	Converts a Roland DR-20 to a large C. mic. For vocals and acoustic inst.
B29	MS:10'58	Mic Simulator	Insert	2ch	Converts a headset mic to a vocal D. mic.
B30	MS:10'87	Mic Simulator	Insert	2ch	Converts a headset mic to a large C. mic.
B31	MS:Mini'57	Mic Simulator	Insert	2ch	Converts a miniature C. mic to a general-purpose D. mic.
B32	MS:Mini'87	Mic Simulator	Insert	2ch	Converts a miniature C. mic to a large C. mic.
B33	MS:Kick&Snr1	Mic Simulator	Insert	2ch	For the bass drum (L channel) and snare drum (R channel) of a drum set (1).
B34	MS:Kick&Snr2	Mic Simulator	Insert	2ch	For the bass drum (L channel) and snare drum (R channel) of a drum set (2).
B35	MS:HiHat&Tom	Mic Simulator	Insert	2ch	For the hi-hat (L channel) and tom (R channel) of a drum set.
B36	MS:Dr.OvrTop	Mic Simulator	Insert	2ch	A patch for placing mics above the drums mainly to mic the cymbals.
B37	MS:Dr.OvrAll	Mic Simulator	Insert	2ch	A patch for placing mics above the front of the drums to mic the entire set.
B38	MS:Ac.Guitar	Mic Simulator	Insert	2ch	For acoustic guitar. InsertL: brighter, InsertR: warmer.
B39	MS:StudioVcl	Mic Simulator	Insert	2ch	For vocals. InsertL: natural, InsertR: Rock.
B40	MS:StereoMic	Mic Simulator	Insert	2ch	Gives time-lag to a sound miked in stereo, emphasizing spaciousness.
B41	MS:Ambience	Mic Simulator	Insert	2ch	Simulates ambience mics. Add reverb and mix with original source.

* D. mic = dynamic microphone, C. mic = condenser microphone

■ Parametric Equalizer (26 presets)

No.	Patch Name	Algorithm	Type	Input	Comment
B42	PEQ:BassDrum	Parametric EQ	Insert	Stereo	For bass drum. Adjust LowQ and HiG.
B43	PEQ:RockBD	Parametric EQ	Insert	Stereo	For bass drum. A sound suitable for rock with mid-lows emphasized.
B44	PEQ:RockSD	Parametric EQ	Insert	Stereo	For snare drum. Drops the mid-lows and emphasizes the attack and snares.
B45	PEQ:RimShot	Parametric EQ	Insert	Stereo	For rim shot. Emphasizes the feeling of attack unique to a rim shot.
B46	PEQ:Toms	Parametric EQ	Insert	Stereo	For toms. Adjust LowF and LowMidF.
B47	PEQ:Hi Hat	Parametric EQ	Insert	Stereo	For the crisper hi-hat. Adjust bell sound with HiMidG.
B48	PEQ:Cymbals	Parametric EQ	Insert	Stereo	For cymbals. Emphasizes the difference in tone between cymbals and their clarity.
B49	PEQ:Overhead	Parametric EQ	Insert	Stereo	For drum kit. Use when miking the sound of the entire kit.
B50	PEQ:Bass 1	Parametric EQ	Insert	Stereo	For electric bass. Wide-range and tight bass sound.
B51	PEQ:Bass 2	Parametric EQ	Insert	Stereo	For electric bass. Fatter and with more punch than B50. For rock.
B52	PEQ:SlapBass	Parametric EQ	Insert	Stereo	For electric bass. Settings that emphasize the accent of pulled notes with slap technique.
B53	PEQ:Sax	Parametric EQ	Insert	Stereo	For alto/soprano sax. Lower HiG for mellow sound.
B54	PEQ:Baro.Sax	Parametric EQ	Insert	Stereo	For baritone sax. Adjust LoMidF.
B55	PEQ:ElecGtr	Parametric EQ	Insert	Stereo	Settings that keep the lead guitar from being buried in the mix.
B56	PEQ:NylonGtr	Parametric EQ	Insert	Stereo	Emphasize the tone of nylon strings. Adjust fret sound with HiG.
B57	PEQ:BluesGtr	Parametric EQ	Insert	Stereo	Adds a delicate nuance suitable when playing blues on an acoustic guitar.
B58	PEQ:SlideGtr	Parametric EQ	Insert	Stereo	Adds a rich feel to acoustic slide guitar. Adjust HiF.
B59	PEQ:LineGtr	Parametric EQ	Insert	Stereo	For piezo pickups. Adjust brightness with HiG.
B60	PEQ:Male	Parametric EQ	Insert	Stereo	Improves the tone quality of a male vocal. Adjust HiG.
B61	PEQ:RockMale	Parametric EQ	Insert	Stereo	Equalizer that adds energy to a male vocal. Best for rock. Try with Comp.
B62	PEQ:Female	Parametric EQ	Insert	Stereo	Improves the tone quality of a female vocal. Adjust LoMidG.
B63	PEQ:RockFeml	Parametric EQ	Insert	Stereo	Equalizer that adds energy to a female vocal. Best for rock. Try with Comp.
B64	PEQ:Narrator	Parametric EQ	Insert	Stereo	Standard equalizer for male narration. Brings out the character of the voice.
B65	PEQ:Organ	Parametric EQ	Insert	Stereo	Settings to bring out the character of a church organ.
B66	PEQ:St.Piano	Parametric EQ	Insert	Stereo	For miking piano in stereo. Left: low range, right: high range.
B67	PEQ:SmallCho	Parametric EQ	Insert	Stereo	Settings that bring out the chorus without letting it conflict with the main vocal.

■ Graphic Equalizer (3 presets)

No.	Patch Name	Algorithm	Type	Input	Comment
B68	GEQ:TotalEQ1	Graphic EQ	Insert	Stereo	Boosts the low and high ranges.
B69	GEQ:TotalEQ2	Graphic EQ	Insert	Stereo	Attenuates the lows and highs to narrow the range, tightening up the sound.
B70	GEQ:Space EQ	Graphic EQ	Insert	Stereo	Special settings that turn a monaural source into stereo.

■ Space Chorus (3 presets)

No.	Patch Name	Algorithm	Type	Input	Comment
B71	SPCHO:MODE 1	Space Chorus	Insert	Stereo	Simulates MODE1 of the classic SDD-320 ambience processor.
B72	SPCHO:MODE 2	Space Chorus	Insert	Stereo	Simulates MODE2 of the classic SDD-320 ambience processor.
B73	SPCHO:MODE 3	Space Chorus	Insert	Stereo	Simulates MODE3 of the classic SDD-320 ambience processor.

■ Special Effects (16 presets)

No.	Patch Name	Algorithm	Type	Input	Comment
B74	LFP:BreakBts	Lo-Fi Processor	Insert	Stereo	Reproduces the tonal change produced by lowering the bit/rate of a sampled sound.
B75	LFP:1bitDist	Lo-Fi Processor	Insert	Stereo	Extreme distortion sound produced by lowering the number of bits.
B76	LFP:TeknoFlt	Lo-Fi Processor	Insert	Stereo	Emphasizes the out-of-band noise that occurs with low sampling rates.
B77	LFP:Reso Flt	Lo-Fi Processor	Insert	Stereo	Filter with resonance as found on synthesizers. Adjust CutOff.
B78	LFP:FatBotom	Lo-Fi Processor	Snd / Rtn	Stereo	Add heavy low-range for the groove. Mix with original source.
B79	VT:M to Fm	Voice Transformer	Insert	Mono	Converts a male voice into a female voice.
B80	VT:Fm to M	Voice Transformer	Insert	Mono	Converts a female voice into a male voice.
B81	VT:Male Duo	Voice Transformer	Insert	Mono	Turns a single male voice into a duet (by adding a female voice).
B82	VT:FemaleDuo	Voice Transformer	Insert	Mono	Turns a single female voice into a duet (by adding a male voice).
B83	VT:Robot	Voice Transformer	Insert	Mono	Special effect like a robot speaking.
B84	VOC2:M19Band	Vocoder2	Insert	Mono	Clear and crisp vocoder.
B85	VOC2:S19Band	Vocoder2	Insert	Mono	Special stereo vocoder with long decay.
B86	HC:Quiet60Hz	Hum Canceler	Insert	Stereo	Cancels 60 Hz hum noise.
B87	HC:Quiet50Hz	Hum Canceler	Insert	Stereo	Cancels 50 Hz hum noise.
B88	VC:Vocal Cnl	Vocal Canceler	Insert	Stereo	Cancels a vocal located in the center.
B89	VC:CenterCnl	Vocal Canceler	Insert	Stereo	Cancel all sound located in the center.

■ Same as Algorithm (14 presets)

No.	Patch Name	Algorithm	Type	Input	Comment
B90	Reverb2	Reverb2	Snd / Rtn	Mono	(p. 58)
B91	Space Chorus	Space Chorus	Insert	Stereo	(p. 60)
B92	Lo-Fi Proces	Lo-Fi Processor	Insert	Stereo	(p. 61)

Preset Patch List

No.	Patch Name	Algorithm	Type	Input	Comment
B93	ParametricEQ	Parametric Equalizer	Insert	2ch	(p. 62)
B94	Graphic EQ	Graphic Equalizer	Insert	2ch	(p. 63)
B95	Hum Canceler	Hum Canceler	Insert	Stereo	(p. 64)
B96	Vocal Cancel	Vocal Canceler	Insert	Stereo	(p. 65)
B97	Voice Trans	Voice Transformer	Insert	Mono	(p. 67)
B98	Vocoder2 (19)	Vocoder2	Insert	Mono	(p. 68)
B99	MicSimulator	Mic Simulator	Insert	2ch	(p. 70)
C00	3BndIsolator	3BandIsolator	Insert	Stereo	(p. 72)
C01	TapeEcho201	Tape Echo 201	Snd/Rtn	Mono	(p. 73)
C02	AnalogFlnger	Analog Flanger	Insert	Stereo	(p. 74)
C03	AnalogPhaser	Analog Phaser	Insert	Stereo	(p. 75)

■ Tape Echo 201 (4 presets)

No.	Patch Name	Algorithm	Type	Input	Comment
C04	TE:ShortEcho	Tape Echo 201	Snd/Rtn	Mono	Simulates short type tape echo.
C05	TE:LongEcho	Tape Echo 201	Snd/Rtn	Mono	Simulates long type tape echo.
C06	TE:OldTape	Tape Echo 201	Snd/Rtn	Mono	Simulates tape echo using an old tape.
C07	TE:PanEcho	Tape Echo 201	Snd/Rtn	Mono	Simulates tape echo in stereo.

■ Analog Flanger (1 preset)

No.	Patch Name	Algorithm	Type	Input	Comment
C08	AF:SBF-325	Analog Flanger	Insert	Stereo	Simulates Roland SBF-325 analog flanger.

■ Analog Phaser (1 preset)

No.	Patch Name	Algorithm	Type	Input	Comment
C09	AP:FB-Phaser	Analog Phaser	Insert	Stereo	Simulates analog phaser with oscillation on purpose.

■ Mastering Tool Kit (19 presets)

No.	Patch Name	Type	Input	Comment
C10	MTK:Mixdown	Insert	Stereo	Mix down for CD
C11	MTK:PreMastr	Insert	Stereo	Pre-master for video editing
C12	MTK:LiveMix	Insert	Stereo	Final mix of live recording
C13	MTK:PopMix	Insert	Stereo	for Pop music
C14	MTK:DanceMix	Insert	Stereo	for Dance music
C15	MTK:JinglMix	Insert	Stereo	Jingle for FM radio
C16	MTK:HardComp	Insert	Stereo	Heavy compression
C17	MTK:SoftComp	Insert	Stereo	Light compression
C18	MTK:ClnComp	Insert	Stereo	Eliminating the background noise and clean up the sound
C19	MTK:DnceComp	Insert	Stereo	Compression for dance music
C20	MTK:OrchComp	Insert	Stereo	Compression for orchestra
C21	MTK:VocalCmp	Insert	Stereo	Compression for vocal
C22	MTK:Acoustic	Insert	Stereo	Acoustic guitar
C23	MTK:RockBand	Insert	Stereo	for Rock band
C24	MTK:Orchestr	Insert	Stereo	for Orchestra
C25	MTK:LoBoost	Insert	Stereo	Enhancing the low frequency range
C26	MTK:Brighten	Insert	Stereo	Enhancing the high frequency range
C27	MTK:DJsVoice	Insert	Stereo	DJ Microphone
C28	MTK:PhoneVox	Insert	Stereo	Telephone voice simulation

■ Speaker Modeling (11 presets)

No.	Patch Name	Type	Input	Comment
C29	SPM:SuperFlt	Insert	Stereo	Modeling is used to compensate the DS-90, to produce an even flatter sound with a wider range.
C30	SPM:P.GenBlk	Insert	Stereo	A widely used model of powered monitors (two-way type, with a woofer diameter of 170 mm (6-1/2 inches)).
C31	SPM:P.E-Bs	Insert	Stereo	Powered monitors characterized by a bright tone.
C32	SPM:P.Mack	Insert	Stereo	Powered monitors characterized by an extended low-frequency response.
C33	SPM:SmalCube	Insert	Stereo	Small full-range speakers widely used in recording studios.
C34	SPM:WhiteCon	Insert	Stereo	Sealed enclosure two-way speakers known for their white woofers and widely used in recording studios.
C35	SPM:W.C+tiss	Insert	Stereo	A more mild sound, with tissue paper affixed over the tweeters of the above "White Con" speakers.
C36	SPM:S.Radio	Insert	Stereo	Small pocket-type radio.
C37	SPM:SmallTV	Insert	Stereo	Speakers built into a 14 inch size television.
C38	SPM:BoomBox	Insert	Stereo	Radio cassette recorder.
C39	SPM:BB.LowBs	Insert	Stereo	Radio cassette recorder with the Low Boost switched on.

Algorithm List

This section describes the effects associated with the respective algorithms and internal terminations. Read this section when you need to check the algorithms in the built-in library (pre-set library) or before creating a new library.

- **To add reverbs (Reverb-related)**

Reverb	(p. 26)
Gate Reverb	(p. 52)
Reverb2	(p. 58)

- **To add delayed sounds (Delay-related)**

Delay	(p. 28)
StPS-Delay	(p. 32)
MultiTapDly	(p. 54)
TapeEcho201	(p. 73)

- **To expand sounds (Chorus-related)**

StDly-Chorus	(p. 30)
Space Chorus	(p. 60)

- **To swing sounds (Modulation-related)**

St Phaser	(p. 47)
St Flanger	(p. 49)
AnalogFlinger	(p. 74)
AnalogPhaser	(p. 75)

- **To alter the volume increment (Compressor-related)**

Dual Comp/Limi	(p. 50)
----------------------	---------

- **To increase/decrease levels by frequency band (Filter-related)**

Parametric EQ	(p. 62)
Graphic EQ	(p. 63)
3BandIsolator	(p. 72)

- **To make sound quality rough (Lo-Fi-related)**

Lo-Fi Process	(p. 61)
---------------------	---------

- **To add effects suited for the guitar/bass**

Guitar Multi1	(p. 39)
Guitar Multi2	(p. 39)
Guitar Multi3	(p. 39)
GuitarAmpSim	(p. 44)

- **To add effects suited for vocals**

Vocal Multi	(p. 42)
Vocal Cancel	(p. 65)
Voice Trans	(p. 67)

- **To add movement to sounds**

Rotary	(p. 44)
--------------	---------

- **To give three-dimensional location**

2ch RSS	(p. 35)
Delay RSS	(p. 37)
Chorus RSS	(p. 38)

- **Others**

Vocoder	(p. 34)
Stereo Multi	(p. 56)
Hum Canceler	(p. 64)
MicSimulator	(p. 70)
Vocoder2(19)	(p. 68)
Speaker Modeling	(p. 76)
Mastering Tool Kit	(p. 78)

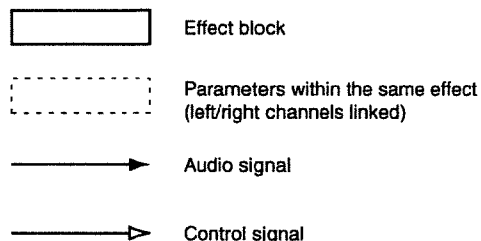

Algorithm List

Reverb

This feature adds reverberation to the sound to simulate the size of space such as a hall and a room.

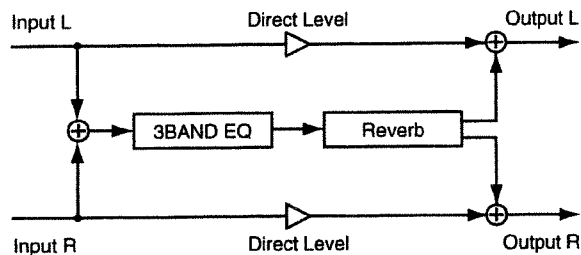

Sound types

Sounds around us can be analyzed and categorized into three types: direct sounds, early reflections and reverberation. A direct sound is the sound that reaches the listener directly from the source. An early reflection is the sound that has rebounded from the wall once, twice or several times. A reverberation is the sound we hear after sound reflections are repeated many times.

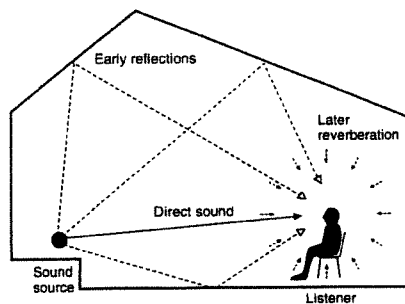

Relationship between sound and time

Reflected sound reach the listener in the following sequence. The pre-delay is the time from when the direct sound is heard until the reverb is heard. The reverb time is the time over which the reverb decays to silence.

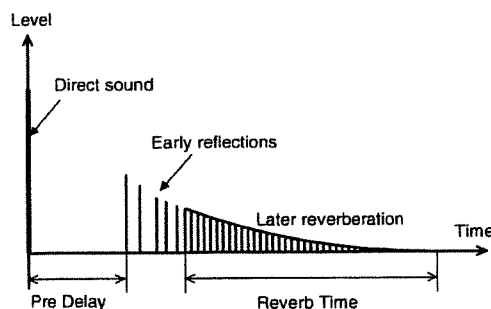

Reverb sound quality

The sound quality of a reverb is affected by materials of the walls and other members from which the sound is rebounded. This is because the degree of attenuation in the high and low frequency bands varies. HF-Damp Gain and LF-Damp Gain are provided so that you can adjust such attenuation degrees. The smaller the value becomes, the steeper the degree of attenuation of the reverberation becomes severer in the high and low frequency bands. In addition, in order to obtain softer reverberation, make the frequency lower by using HF-Damp Frequency (HiFreq-Damp Freq). In order to obtain harder reverberation, make the frequency higher by using LF-Damp Frequency (LoFreq-Damp Freq).

Parameter (full name)	Setting	Function
EQ (Equalizer)		
EQ (Switch)	On, Off	Turns the equalizer on or off.
LowType (Low Type)	Shlv, Peak	Sets the type of the low frequency band equalizer (Shlving type or peaking type).
Low.G (Low Gain)	-12- +12 dB	Sets the boost/cut amount in the low frequency band.
Low.F (Low Frequency)	20 - 2000 Hz	Sets the center frequency in the low frequency band.
Low.Q (Low Q)	0.3-10.0	Sets the width of the area around the low frequency that will be affected by the gain settings. ¹
Mid.G (Middle Gain)	-12- +12 dB	Sets the boost/cut amount in the middle frequency band.
Mid.F (Middle Frequency)	200-8000 Hz	Sets the center frequency in the middle frequency band.
Mid.Q (Middle Q)	0.3-10.0	Sets the width of the area around the middle frequency that will be affected by the gain settings.
Hi Type (High Type)	Shlv, Peak	Sets the type of the high frequency band equalizer (Shlving type or peaking type).
Hi.G (High Gain)	-12- +12 dB	Sets the boost/cut amount in the high frequency band.
Hi.F (High Frequency)	1.4-20.0 kHz	Sets the center frequency in the high frequency band.
Hi.Q (High Q)	0.3-10.0	Sets the width of the area around the high frequency that will be affected by the gain settings. ¹
Out Level (Output Level)	0-100	Sets the volume after passing through the equalizer.

Reverb: Adds reverberation.

RoomSize (Room Size)	5-40 m	Sets the size of the room.
Time (Reverb Time)	0.1-10.0 sec.	Sets the time length of the reverb sound.
EFLevel (Effect Level)	-100-100	Sets the volume of the reverb sound.
DiLevel (Direct Level)	-100-100	Sets the volume of the direct sound.
PreDLY (Pre-Delay)	0-200 ms	Sets the time until the reverb sound appears.
Diffusio (Diffusion)	0-100	Sets the extent of diffusion of the early reflection sound.
Density (Density)	0-100	Sets the density of the reverb sound.
ER Level (Early Reflection Level)	0 to 100	Sets the volume of the early reflection.
LD.G (LF-Damp Gain)	-36-0 dB	Sets the degree of attenuation of the reverb in the low frequency band.
LD.F (LF-Damp Frequency)	50-4000 Hz	Sets the frequency on which the reverb starts attenuating in the low frequency band.
HD.G (HF-Damp Gain)	-36-0 dB	Sets the degree of attenuation of the reverb in the high frequency band.
HD.F (HF-Damp Frequency)	1.0-20.0 kHz	Sets the frequency on which the reverb starts attenuating in the high frequency band.
HiCF (High Cut Frequency)	0.2-20.0 kHz	Sets the frequency for which the high frequency band elements of the reverb are cut.



¹: If Low Type (LowType) or High Type (Hi Type) is set to "Shlv (Shlving Type)," the setting for LowQ or High Q is invalid.

Algorithm List

Delay

Delay is a feature to add a delayed sound to the direct sound in order to add thickness to the sound or to yield a special effect.

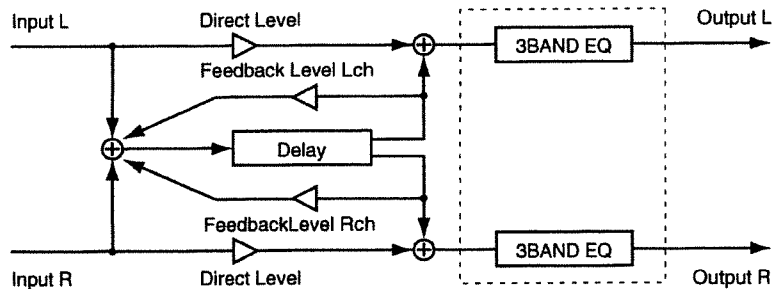

Delay sounds and the spread of sound

As a delay is output in the stereo mode, it sounds from the right and the left sides. These delay sounds can be adjusted by setting Delay Shift (Shift). Set it to the value on the L side to cause the left-side delay sound lag behind and to the value on the R side to cause the right-side delay sound lag behind. Set Shift to "0" to make the delay sounds on the both sides simultaneously. Setting the right and left delay times to different values yields more spreading effect.

* The sum of the Delay Time value and the Delay Shift value should not exceed the setting range of Delay Time. For example, if the setting range of Delay Time is 0 to 1200 ms and Delay Time is set to 1000 ms, the setting range of Delay Shift should be L200 to R200 ms.

Delay repetition

Delay feedback means to return the delay sound to the Delay input. The amount of feedback is set with FBLevel (Feedback Level). The greater this value becomes, the more times the delay sound is repeated. Setting this level to a negative value inverts the phase. Excessively large values may cause oscillation.

Parameter (full name)	Setting	Function
-----------------------	---------	----------

DLY(Delay): Adds a delayed sound to the direct sound, adding depth to the sound or creating special effects.

Parameter (full name)	Setting	Function
Delay (Switch)	On, Off	Turns the delay on or off.
Time (Delay Time)	0–1200 ms	Sets the time from direct sound until when the delay sound is heard. *1
Shft (Delay Shift)	L1200–0–R1200 ms	Sets the delay time difference between the right and left delay sounds.
L-FBLvl (Lch Feedback Level)	-100–100	Sets the amount of the left-side delay should be returned to the delay input.
R-FBLvl (Rch Feedback Level)	-100–100	Sets the amount of the right-side delay should be returned to the delay input.
L-Level (Lch Effect Level)	-100–100	Sets the volume for the left-side delay sound.
R-Level (Rch Effect Level)	-100–100	Sets the volume for the right-side delay sound.
DiLevel (Direct Level)	-100–100	Sets the volume of the direct sound.
LD.G (LF-Damp Gain)	-36–0 dB	Sets the degree of attenuation in the low frequency band for the delay sound fed back.
LD.F (LF-Damp Frequency)	50–4000 Hz	Sets the frequency at which attenuation in the low frequency band starts to the delay sound fed back.
HD.G (HF-Damp Gain)	-36–0 dB	Sets the degree of attenuation in the high frequency band for the delay sound fed back.
HD.F (HF-Damp Frequency)	1.0–20.0 kHz	Sets the frequency at which attenuation in the high frequency band starts to the delay sound fed back.

EQ (Equalizer)

EQ (Switch)	On, Off	Turns the equalizer on or off.
LowType (Low Type)	Shlv, Peak	Sets the type of the low frequency band equalizer (Shlving type or peaking type).
Low.G (Low Gain)	-12~ +12 dB	Sets the boost/cut amount in the low frequency band.
Low.F (Low Frequency)	20 - 2000 Hz	Sets the center frequency in the low frequency band.
Low.Q (Low Q)	0.3-10.0	Sets the width of the area around the low frequency that will be affected by the gain settings.1 *2
Mid.G (Middle Gain)	-12~ +12 dB	Sets the boost/cut amount in the middle frequency band.
Mid.F (Middle Frequency)	200-8000 Hz	Sets the center frequency in the middle frequency band.
Mid.Q (Middle Q)	0.3-10.0	Sets the width of the area around the middle frequency that will be affected by the gain settings.
Hi Type (High Type)	Shlv, Peak	Sets the type of the high frequency band equalizer (Shlving type or peaking type).
Hi.G (High Gain)	-12~ +12 dB	Sets the boost/cut amount in the high frequency band.
Hi.F (High Frequency)	1.4-20.0 kHz	Sets the center frequency in the high frequency band.
Hi.Q (High Q)	0.3-10.0	Sets the width of the area around the high frequency that will be affected by the gain settings.1 *2
Out Level (Output Level)	0-100	Sets the volume after passing through the equalizer.

NOTE

- *1: The sum of the Delay Time (Time) value and the Delay Shift (Shift) value should not exceed the setting range of Delay Time. For example, if Delay Time is set to 1000 ms, the setting range of Delay Shift is L200 to R200 ms.
- *2: If Low Type (LowType) or Hi Type (High Type) is set to "Shlv (Shlving Type)," the setting for LowQ or High Q is invalid.

StDly-Chorus (Stereo Delay Chorus)

Delay and Chorus can be combined to create spaciousness.

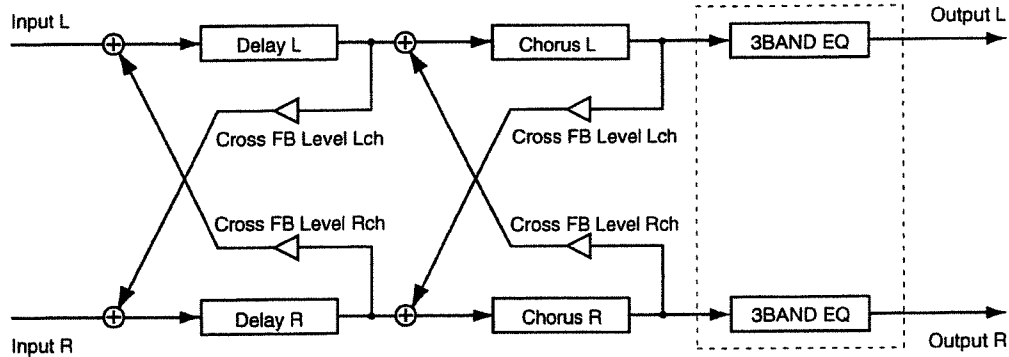

How feedback works for Delay and Chorus

Feedback is the feature to return the effect sound to its input. The amount of feedback is set with FBLevel (Feedback Level). Cross-Feedback is the feature to return the effect sound from the right input to the left input and the effect send from the left input to the right. The amount of cross-feedback is set with Cross-Feedback Level (CrossFB Level).

The greater this value becomes, the more times the delay sound is repeated. Setting this level to a negative value inverts the phase.

For feedback of chorus, the greater the value becomes, the more spaciousness and thickness is added to the sound. Setting this level to a negative value inverts the phase.

* Excessively great values may cause oscillation, leading to abnormal noise.

Parameter (full name)	Setting	Function
-----------------------	---------	----------

DLY(Delay): Adds a delayed sound to the direct sound, adding depth to the sound or creating special effects.

Delay (Switch)	On, Off	Turns the delay on or off.
Time (Delay Time)	0–500 ms	Sets the time from direct sound until when the delay sound is heard. *1
Shift (Delay Shift)	L500–0–R500 ms	Sets the delay time difference between the right and left delay sounds.
L-FBLvl (Lch Feedback Level)	-100–100	Sets the amount of the left-side delay should be returned to the left delay input.
R-FBLvl (Rch Feedback Level)	-100–100	Sets the amount of the right-side delay should be returned to the right delay input.
L-CFBLv (Lch Cross-Feedback Level)	-100–100	Sets the amount of the left-side delay should be returned to the right delay input.
R-CFBLv (Rch Cross-Feedback Level)	-100–100	Sets the amount of the right-side delay should be returned to the left delay input.
EFLvl (Effect Level)	-100–100	Sets the volume of the delay sound.
DiLevel (Direct Level)	-100–100	Sets the volume of the direct sound.

CHO (Chorus): **Adds spaciousness and depth to the sound.**

Chorus (Switch)	On, Off	Turns the chorus on or off.
Rate (Rate)	0.1–10.0 kHz	Sets the rate of modulation.
Depth (Depth)	0–100	Sets the depth of modulation.
EFLevel (Effect Level)	-100–100	Sets the volume of the chorus sound.
DiLevel (Direct Level)	-100–100	Sets the volume of the direct sound.
PreDLY (Pre-Delay)	0–50 ms	Sets the time delay from when the direct sound begins until the processed sound is heard.
L-FBLvl (Lch Feedback Level)	-100–100	Sets the amount of the left-side chorus sound should be returned to the left chorus input.
R-FBLvl (Rch Feedback Level)	-100–100	Sets the amount of the right-side chorus sound should be returned to the right chorus input.
L-CFBLv (Lch Cross-Feedback Level)	-100–100	Sets the amount of the left-side chorus sound should be returned to the right chorus input.
R-CFBLv (Rch Cross-Feedback Level)	-100–100	Sets the amount of the right-side chorus sound should be returned to the left chorus input.

EQ (Equalizer)

EQ (Switch)	On, Off	Turns the equalizer on or off.
LowType (Low Type)	Shlv, Peak	Sets the type of the low frequency band equalizer (Shlving type or peaking type).
Low.G (Low Gain)	-12– +12 dB	Sets the boost/cut amount in the low frequency band.
Low.F (Low Frequency)	20 - 2000 Hz	Sets the center frequency in the low frequency band.
Low.Q (Low Q)	0.3–10.0	Sets the width of the area around the low frequency that will be affected by the gain settings. ¹ *2
Mid.G (Middle Gain)	-12– +12 dB	Sets the boost/cut amount in the middle frequency band.
Mid.F (Middle Frequency)	200–8000 Hz	Sets the center frequency in the middle frequency band.
Mid.Q (Middle Q)	0.3–10.0	Sets the width of the area around the middle frequency that will be affected by the gain settings.
Hi Type (High Type)	Shlv, Peak	Sets the type of the high frequency band equalizer (Shlving type or peaking type).
Hi.G (High Gain)	-12– +12 dB	Sets the boost/cut amount in the high frequency band.
Hi.F (High Frequency)	1.4–20.0 kHz	Sets the center frequency in the high frequency band.
Hi.Q (High Q)	0.3–10.0	Sets the width of the area around the high frequency that will be affected by the gain settings. ¹ *2
Out Level (Output Level)	0–100	Sets the volume after passing through the equalizer.



*1: The sum of the Delay Time (Time) value and the Delay Shift (Shift) value should not exceed the setting range of Delay Time. For example, if the delay time is set to 300 ms, the setting range of Delay Shift is L200 to R200 ms.

*2: If LowType (Low Type) or Hi Type (High Type) is set to "Shlv (Shlving Type)," the setting for LowQ or High Q is invalid.

Algorithm List

StPS-Delay (Stereo Pitch Shifter Delay)

Changes the pitch of the direct sound. Corrects vocals out of tune or adds thickness to the sound by mixing the direct sound and a sound at a shifted pitch.

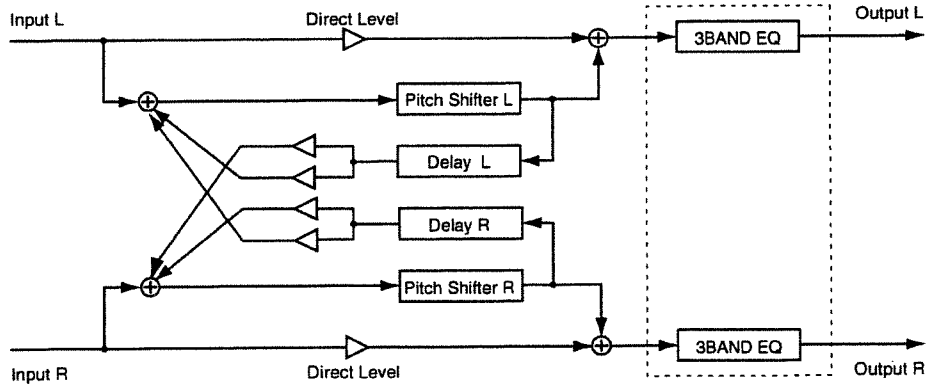

Setting up pitch

Chromatic Pitch (Cromatic) is used for major pitch variation while Fine Pitch (Fine) is used for fine adjustment. Setting up slightly different pitches for the right and left gives thickness to the sound.

Parameter (full name)	Setting	Function
Pitch Shifter Delay : Shifts the pitch.		
PS-Delay (Switch)	On, Off	Turns the pitch shifter on or off.
L-CP (Lch Chromatic Pitch)	-12-12	Sets the left-side pitch variation (by semitone).
R-CP (Rch Chromatic Pitch)	-12-12	Sets the right-side pitch variation (by semitone).
L-F.P (Lch Fine Pitch)	-100-100	Sets the left-side pitch variation (by cent).
R-F.P (Rch Fine Pitch)	-100-100	Sets the right-side pitch variation (by cent).
L-PDLY (Lch Pre-Delay)	0-50 ms	Sets the time from when the direct sound is output until when the left-side sound at a shifted pitch is output.
R-PDLY (Rch Pre-Delay)	0-50 ms	Sets the time from when the direct sound is output until when the right-side sound at a shifted pitch is output.
L-FBD (Lch Feedback Delay Time)	0-500 ms	Sets the feedback repetition cycle for the left-side delay sound.
R-FBD (Rch Feedback Delay Time)	0-500 ms	Sets the feedback repetition cycle for the right-side delay sound.
L-FBLv (Lch Feedback Level)	-100-100	Sets the amount of the left-side sound at a shifted pitch should be returned to the left pitch shifter input.
R-FBLv (Rch Feedback Level)	-100-100	Sets the amount of the right-side sound at a shifted pitch should be returned to the right-side pitch shifter input.
L-CFBLv (Lch Cross-Feedback Level)	-100-100	Sets the amount of the left-side sound at a shifter pitch should be returned to the right-side pitch shifter input.
R-CFBLv (Rch Cross-Feedback Level)	-100-100	Sets the amount of the right-side sound at a shifted pith should be returned to the left-side pitch shifter input.
EFLv (Effect Level)	-100-100	Sets the volume of the sound at a shifter pitch.
DLv (Direct Level)	-100-100	Sets the volume of the direct sound.

EQ (Equalizer)

EQ (Switch)	On, Off	Turns the equalizer on or off.
LowType (Low Type)	Shlv, Peak	Sets the type of the low frequency band equalizer (Shlving type or peaking type).
Low.G (Low Gain)	-12~ +12 dB	Sets the boost/cut amount in the low frequency band.
Low.F (Low Frequency)	20 - 2000 Hz	Sets the center frequency in the low frequency band.
Low.Q (Low Q)	0.3-10.0	Sets the width of the area around the low frequency that will be affected by the gain settings.1 *1
Mid.G (Middle Gain)	-12~ +12 dB	Sets the boost/cut amount in the middle frequency band.
Mid.F (Middle Frequency)	200-8000 Hz	Sets the center frequency in the middle frequency band.
Mid.Q (Middle Q)	0.3-10.0	Sets the width of the area around the middle frequency that will be affected by the gain settings.
Hi Type (High Type)	Shlv, Peak	Sets the type of the high frequency band equalizer (Shlving type or peaking type).
Hi.G (High Gain)	-12~ +12 dB	Sets the boost/cut amount in the high frequency band.
Hi.F (High Frequency)	1.4-20.0 kHz	Sets the center frequency in the high frequency band.
Hi.Q (High Q)	0.3-10.0	Sets the width of the area around the high frequency that will be affected by the gain settings.1 *1
Out Level (Output Level)	0-100	Sets the volume after passing through the equalizer.



*1: If Low Type (LowType) or High Type (Hi Type) is set to "Shlv (Shlving Type)," the setting for LowQ or High Q is invalid.

Algorithm List

Vocoder

The vocoder creates "talking instrument" effects. To use Vocoder, input an instrumental sound into the left channel and a vocal sound into the right channel. The instrumental sound is split into ten frequency bands to be processed according to its frequency components.

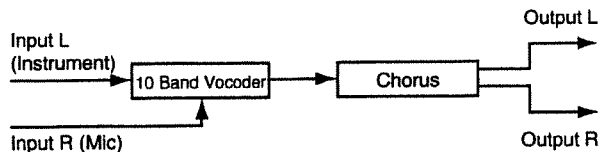

Instrumental sounds are input into the L-channel side of the effect. Therefore, it is required to insert and connect "Lch" of the effect to the channel handling instrumental sounds. Similarly, vocal sounds are input into the R-channel side of the effect. Insert and connect "Rch" of the effect to the channel handling vocal sounds.

Tips for using Vocoder

It is a good idea to choose instrumental sounds containing a lot of overtones. Recommended sounds include those with saw-tooth waveforms such as strings and distorted guitar sounds.

Parameter (full name)	Setting	Function
VOC (Vocoder): The pitch is specified with the instrumental sound while the tone is output in vocals.		
V.Char 1-10 (Voice Characters)	0-100	Sets the volume by frequency band. These are used to change the vocoder tone.
CHO (Chorus): Adds spaciousness and depth to the sound.		
Chorus (Switch)	On, Off	Turns the chorus on or off.
Rate (Rate)	0.1-10.0 Hz	Sets the rate of modulation.
Depth (Depth)	0-100	Sets the depth of modulation.
EFLevel (Effect Level)	-100-100	Sets the volume of the chorus sound.
DiLevel (Direct Level)	-100-100	Sets the volume of the direct sound.
PreDLY (Pre-Delay)	0-50 ms	Sets the time delay from when the direct sound begins until the processed sound is heard.
FBLLevel (Feedback Level)	-100-100	Sets the amount of the chorus sound should be returned to the chorus input.

2ch RSS

Gives each of the sounds input into the respective channels three-dimensional locations.

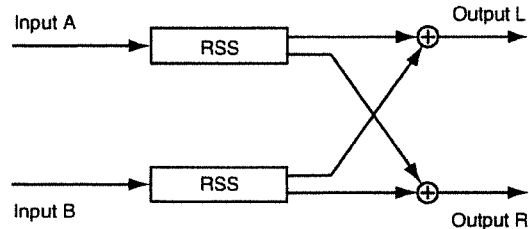

- Input A is input into the L-channel side of the effect. Therefore, it is required to insert and connect "Lch" of the effect to the channel handling Input A. Similarly, Input B is input into the R-channel side of the effect. Insert and connect "Rch" of the effect to the channel handling Input B.
- Do not output the direct sound.

What is RSS?

It stands for Roland Sound Space. This is one of the Roland's proprietary effect technologies that enables three-dimensional location of the sound source on the ordinary stereo system. Not only control on effect for the front and the sides of the audience, this technology provides controls on directions (azimuth) such as up, down and rear as well as control on distance to localize the sound source.

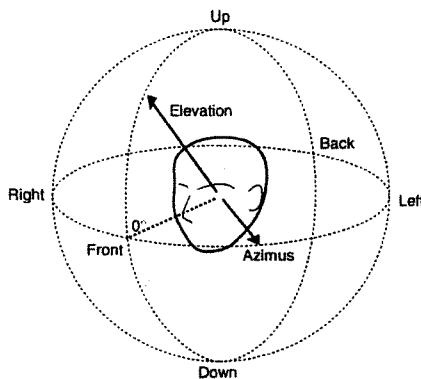

Parameter (full name)	Setting	Function
RSS:	Gives sounds three-dimensional locations.	
A-Azim (Ach Azimuth)	-180–180°	Sets output directions, front, back, right and left, for the Input A channel.
A-Elev (Ach Elevation)	-90–90°	Sets output directions, up and down, for the Input A channel.
B-Azim (Bch Azimuth)	-180–180°	Sets output directions, front, back, right and left, for the Input B channel.
B-Elev (Bch Elevation)	-90–90°	Sets output directions, up and down, for the Input B channel.

→ Continued...

Precautions for using RSS

In order to obtain the maximum effect from the RSS, observe the following points.

- Acoustically "dead" rooms are most suitable.
- A single-way speaker is suited. However, a multi-way type will do if it incorporates the coaxial or virtual coaxial system.
- Place the speakers as far as possible from the walls on the sides.
- Do not separate the right and left speakers too much.
- Recommended sweet spots for listening are as follows:

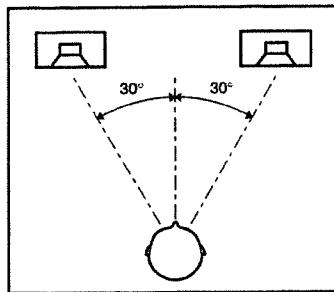

Labeling on RSS product package

In order to allow RSS to demonstrate its maximum performance, it is important to specify listening environment. For sale, we recommend that you should attach the following labeling on the packages of your products produced by using RSS patches.



For Stereo Speakers

This sound is made to be played specifically through speakers.
The proper effect cannot be obtained if listened to through headphones.

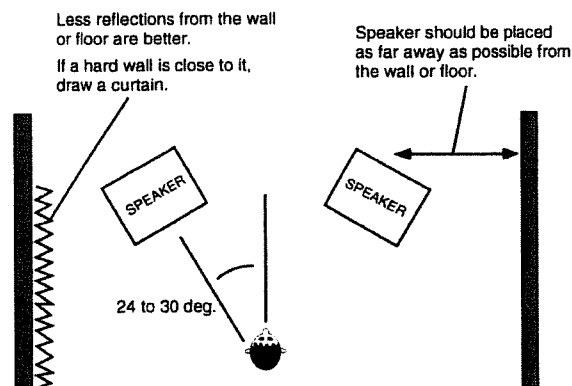

Delay RSS

The right-side, left-side and center Delay sounds can be set separately. As RSS is connected to both the right and left outputs, the sound image of the sound from the left-side channel is localized at 90° to the left and that of the sound from the right-side channel at 90° to the right. The center Delay output can receive the Feedback effect.

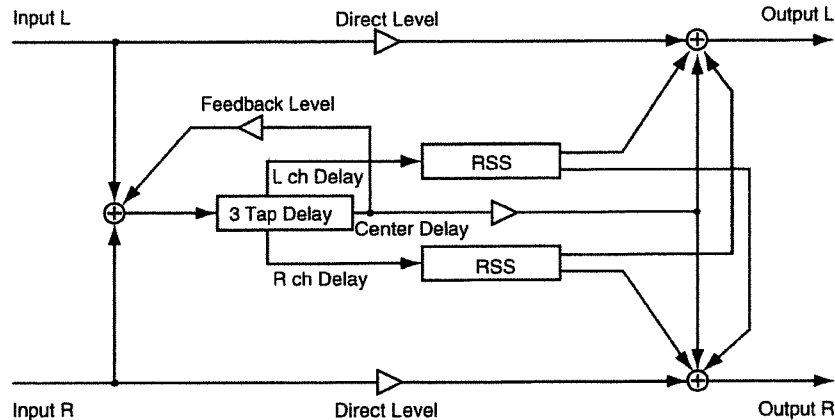

The location is fixed; no azimuth or elevation can be specified.

Parameter (full name)	Setting	Function
DRS (Delay RSS): Gives three-dimensional location to Delay sounds.		
Time (Delay Time)	0–1200 ms	Sets the time from direct sound until when the left and right delay sound is heard.
Shft (Delay Shift)	L1200–0–R1200 ms	Sets the balance of the right and left delay times.
C-Tim (Center Delay Time)	0–1200 ms	Sets the time from direct sound until when the center delay sound is heard.
RSS Lvl (RSS Level)	0–100	Sets the volume of the RSS sound.
C-Lvl (Center Level)	0–100	Sets the volume for the center delay sound.
FBLvl (Feedback Level)	-100–100	Sets the amount of the center delay sound should be returned to the delay input.
EFLvl (Effect Level)	-100–100	Sets the volume of the delay RSS sound.
DiLvl (Direct Level)	-100–100	Sets the volume of the direct sound.
LD.G (LF-Damp Gain)	-36–0 dB	Sets the degree of attenuation in the low frequency band for the center delay sound returned to the input.
LD.F (LF-Damp Frequency)	50–4000 Hz	Sets the frequency at which attenuation in the low frequency band starts for the center delay sound returned to the input.
HD.G (HF-Damp Gain)	-36–0 dB	Sets the degree of attenuation in the high frequency band for the center delay sound returned to the input.
HD.F (HF-Damp Frequency)	1.0–20.0 kHz	Sets the frequency at which attenuation in the high frequency band starts for the center delay sound returned to the input.

Algorithm List

Chorus RSS

RSS is connected to the Chorus output. The sound image is defined with the sound from the left-side channel located at left 90° and the sound from the right-side channel at right 90°.

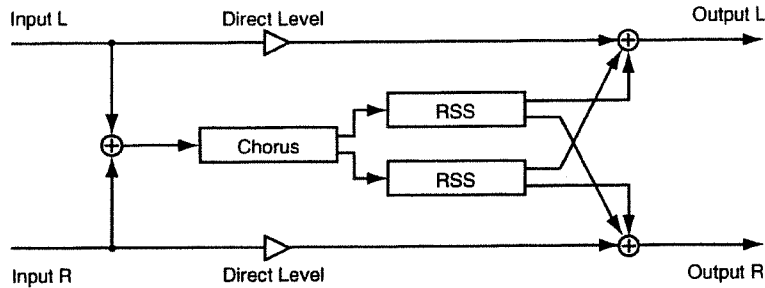

Location is fixed; no azimuth or elevation can be specified.

Parameter (full name)	Setting	Function
CRS (Chorus RSS)	: Locates chorus sounds three-dimensionally.	
Rate (Chorus Rate)	0.1–10.0 Hz	Sets the rate of modulation.
Depth (Chorus Depth)	0–100	Sets the depth of modulation.
EFLevel (Effect Level)	-100–100	Sets the volume of the chorus RSS sound.
DiLevel (Direct Level)	-100–100	Sets the volume of the direct sound.

GuitarMulti 1-3

These provide multi-effects for guitar sounds suited for rock. Guitar Multi 1 through 3 differ in the degree of sound distortion. Guitar Multi 1 provides the highest degree of distortion and Guitar-Multi 3 the lowest.

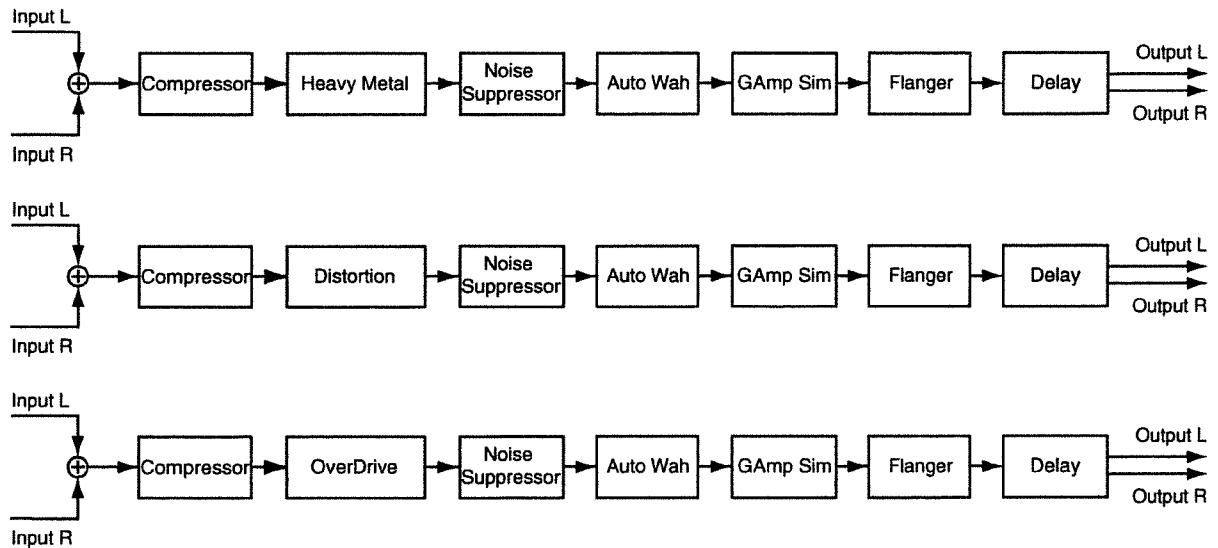

Usage of Guitar Multi 1 through 3

The basic configuration is almost identical for all of Guitar-Multi 1 through 3. The only difference is the type of the second effect (heavy metal, distortion, and overdrive). Select Guitar Multi 1 to add severe distortion to the sound, and select Guitar Multi 3 for soft distortion as that achieved with the vacuum tube amplifier.

Adding Wah effect by changing input volume

Typically, Auto-Wah provides an automatic wah effect at the cycle set with Rate (Rate). Alternatively, you can give wah effect according to changes of input volume. For example, you can apply the wah effect so that it reflects changes in picking on the guitar. First, adjust sensitivity for changes in input volume by using Sense (Sens). Set it to a larger value for finer subtlety. After that, you simply decide the direction into which the filter should be moved by entering a setting for Polarity (Pol).

Selecting Guitar Amplifier

You can select which type of Guitar Amplifier to use with Mode (Mode) under Guitar Amplifier Simulator.

Small:	Small-sized amplifier
Built In:	Built-in type amplifier
2 Stack:	Large-sized two-deck stacked amplifiers
3 Stack:	Large-sized three-deck stacked amplifiers

Compressors used in Guitar Multi 1 through 3

Compressors used in Guitar Multi 1 through 3 are designed to accommodate playing of the guitar, providing a slightly different effect from ordinary compressors. Compressors for the guitar unifies volumes by suppressing signals at high levels and enhancing signals at low levels.

Unlike these, ordinary compressors simply suppress signals at high levels.

→ Continued...

Algorithm List

Parameter (full name)	Setting	Function
CMP (Compressor): Compresses the entire output signals when the input volume exceeds a specified value.		
Comp (Switch)	On, Off	Turns the compressor on or off.
Attack (Attack)	0–100	Sets the strength of attack when a sound is input.
Level (Level)	0–100	Sets the volume of the compressor sound.
Sustain (Sustain)	0–100	Sets the time over which low level signals are boosted to a constant volume.
Tone (Tone)	-50–50	Sets the tone color.
MTL (Heavy Metal) / DST (Distortion) / ODV (Overdrive): Gives distortion to the sound.		
(Switch)	On, Off	Turns the metal, distortion or overdrive on or off.
Gain (Gain)	0–100	Sets the degree of the distortion.
Level (Level)	0–100	Sets the volume of the metal, distortion or overdrive sound.
HiGain (High Gain)	-100–100	Sets the boost/cut amount in the high frequency band. (only for Metal)
MidGain (Middle Gain)	-100–100	Sets the boost/cut amount in the middle frequency band. (only for Metal)
LowGain (Low Gain)	-100–100	Sets the boost/cut amount in the low frequency band. (only for Metal)
Tone (Tone)	0–100	Sets the tone color. (for Distortion/Overdrive only)
NS (Noise Suppressor): Mutes noise in the silent mode.		
NoiseSup (Switch)	On, Off	Turns the noise suppressor on or off.
Thresh (Threshold)	0–100	Sets the level to start muting noise.
Release (Release)	0–100	Sets the time over which the volume will drop to 0 after the noise starts being muted.
WAH (Auto Wah): Adds the wah effect.		
Wah (Switch)	On, Off	Turns the auto wah on or off.
Mode (Mode)	LPF, BPF	Set to "BPF" for the wah effect in a narrow range of frequencies and to "LPF" for wah effect in a broad range of frequencies.
Poi (Polarity)	Up, Down	Activated only for adding the wah effect according to input volume changes. Set to "Up" for moving the filter to a higher frequency and "Down" for moving it to a lower frequency.
Freq (Frequency)	0–100	Sets the frequency at which the wah effect starts working.
Level (Level)	0–100	Sets the volume of the wah sound.
Peak (Peak)	0–100	Sets the degree of the wah effect applied at around the frequency.
Sens (Sense)	0–100	Normally "0." Sets sensitivity for input volume changes for adding the wah effect according to input volume changes.
Rate (Rate)	0.1–10.0 Hz	Sets the rate at which the wah effect will be cyclically modulated.
Depth (Depth)	0–100	Sets the depth at which the wah effect will be cyclically modulated.
AMP (Guitar Amplifier Simulator): Simulates Guitar Amplifier.		
G.AmpSim (Switch)	On, Off	Turns the guitar amplifier simulator on or off.
Mode (Mode)	See the column on the previous page.	Type of the guitar amplifier.

FLG (Flanger): Adds effects similar to ascending/descending sound of a jet.

Flanger (Switch)	On, Off	Turns the flanger on or off.
Rate (Rate)	0.1–10.0 Hz	Sets the rate of modulation for the flanger.
Depth (Depth)	0–100	Sets the depth of modulation for the flanger.
Manual (Manual)	0–100	Sets the center frequency subject to application of the flanger effect.
Reso (Resonance)	0–100	Enhances frequency components at around the center frequency set with Manual.

DLY(Delay): Adds a delayed sound to the direct sound, adding depth to the sound or creating special effects.

Delay (Switch)	On, Off	Turns the delay on or off.
Time (Delay Time)	0–1000 ms	Sets the time from direct sound until when the delay sound is heard.* ¹
Shift (Shift)	L1000–0–R1000 ms	Sets the delay time difference between the right and left delay sounds.
FBTim (Feedback Delay Time)	0–1000 ms	Sets the feedback repetition cycle.
FBLevel (Feedback Level)	-100–100	Sets the amount of the delay sound should be returned to the delay input.
EFLevel (Effect Level)	-100–100	Sets the volume of the delay sound.
DiLevel (Direct Level)	-100–100	Sets the volume of the direct sound.



*1: The sum of the Delay Time value and the Delay Shift value should not exceed the setting range of Delay Time. For example, if Delay Time is set to 800 ms, the setting range of Delay Shift is L200 to R200 ms.

Algorithm List

Vocal Multi

This feature provides a multi-effect suited for vocals.

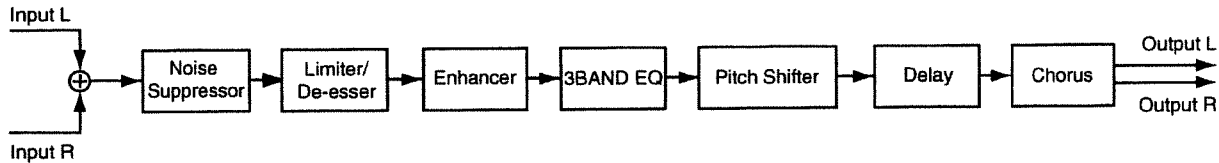

Cutting distortion in vocals

Limiter can be used to suppress signals at a high level to prevent sound distortion. To do this, follow the steps below:

- Mode (Mode): Limiter
 Limiter Threshold (Thresh): Sets the volume at which sound distortion starts being suppressed.
 Limiter Release (Release): Determines the time that elapses before the input level becomes off after it drops below the Limiter Threshold.
 Limiter Level (Level): Decides the volume after passing through Limiter.

Cutting the sibilant sounds of a voice.

De-esser can be used to cut off sibilant sounds contained in vocal sounds to achieve softer sound quality. To do this, follow the steps below:

- Mode (Mode): De-esser
 De-esser Sense (Sens): Sets the degree of the De-esser effect.
 De-esser Frequency (Freq): Sets the frequency at which De-esser effect starts working.

Parameter (full name)	Setting	Function
NS (Noise Suppressor): Mutes noise in the silent mode.		
NoiseSup (Switch)	On, Off	Turns the noise suppressor on or off.
Thresh (Threshold)	0-100	Sets the level to start muting noise.
Release (Release)	0-100	Sets the time over which the volume will drop to 0 after the noise starts being muted.
LD (Limiter / De-esser): Suppresses signals at high levels to control distortion / Suppresses the annoying s-consonant.		
LMT/DES (Switch)	On, Off	Turns the limiter/de-esser on or off.
Mode (Mode)	Limiter, De-esser	Selects limiter or de-esser.
Thresh (Limiter Threshold)	0-100	Sets the volume at which sound distortion starts being suppressed.
Release (Limiter Release)	0-100	Sets the time until when the limiter will turn off after the input level falls the limiter Threshold (Thresh).
Level (Limiter Level)	0-100	Sets the volume of the limiter sound.
ENH (Enhancer): Accentuates the sound and push the sound forward.		
Enhancer (Switch)	On, Off	Turns the enhancer on or off.
Sens (Sense)	0-100	Sets the degree of the enhancer effect desired.
Freq (Frequency)	1.0-10.0 kHz	Sets the frequency at which the enhancer effect starts working.
Mix Lev (Mix Level)	0-100	Sets the amount of the enhancer sound should be mixed into the direct sound.
Level (Level)	0-100	Sets the volume of the enhancer sound.

EQ (Equalizer)

EQ (Switch)	On, Off	Turns the equalizer on or off.
LowType (Low Type)	Shlv, Peak	Sets the type of the low frequency band equalizer (Shlving type or peaking type).
Low.G (Low Gain)	-12– +12 dB	Sets the boost/cut amount in the low frequency band.
Low.F (Low Frequency)	20 - 2000 Hz	Sets the center frequency in the low frequency band.
Low.Q (Low Q)	0.3–10.0	Sets the width of the area around the low frequency that will be affected by the gain settings. ^{*1}
Mid.G (Middle Gain)	-12– +12 dB	Sets the boost/cut amount in the middle frequency band.
Mid.F (Middle Frequency)	200–8000 Hz	Sets the center frequency in the middle frequency band.
Mid.Q (Middle Q)	0.3–10.0	Sets the width of the area around the middle frequency that will be affected by the gain settings.
Hi Type (High Type)	Shlv, Peak	Sets the type of the high frequency band equalizer (Shlving type or peaking type).
Hi.G (High Gain)	-12– +12 dB	Sets the boost/cut amount in the high frequency band.
Hi.F (High Frequency)	1.4–20.0 kHz	Sets the center frequency in the high frequency band.
Hi.Q (High Q)	0.3–10.0	Sets the width of the area around the high frequency that will be affected by the gain settings. ^{*1}
Out Level (Output Level)	0–100	Sets the volume after passing through the equalizer.

PS (Pitch Shifter): Shifts the pitch.

P.Shifter (Switch)	On, Off	Turns the pitch shifter on or off.
C.Pitch (Chromatic Pitch)	-12–12	Pitch variation (by semitone)
F.Pitch (Fine Pitch)	-100–100	Pitch variation (by cent)
EFLevel (Effect Level)	-100–100	Sets the volume of the pitch shift sound.
DiLevel (Direct Level)	-100–100	Sets the volume of the direct sound.

DLY(Delay): Adds a delayed sound to the direct sound, adding depth to the sound or creating special effects.

Delay (Switch)	On, Off	Turns the delay on or off.
Time (Delay Time)	0–1000 ms	Sets the time from direct sound until when the delay sound is heard.
FBLevel (Feedback Level)	-100–100	Sets the amount of the delay sound should be returned to the delay input.
EFLevel (Effect Level)	-100–100	Sets the volume of the delay sound.
DiLevel (Direct Level)	-100–100	Sets the volume of the direct sound.

CHO (Chorus): Adds spaciousness and thickness to the sound.

Chorus (Switch)	On, Off	Turns the chorus on or off.
Rate (Rate)	0.1–10.0 Hz	Sets the rate of modulation.
Depth (Depth)	0–100	Sets the depth of modulation.
EFLevel (Effect Level)	-100–100	Sets the volume of the chorus sound.
DiLevel (Direct Level)	-100–100	Sets the volume of the direct sound.
PreDLY (Pre-Delay)	0–50 ms	Sets the time delay from when the direct sound begins until the processed sound is heard.



*1: If Low Type (LowType) or High Type (Hi Type) is set to "Shlv (Shlving Type)," the setting for LowQ or High Q is invalid.

Algorithm List

Rotary

Simulates a rotary speaker. Behaviors of high and low frequency band Roters can be set up separately, allowing realistic modeling of unique surging sensation. This effect is suited for organ sounds.

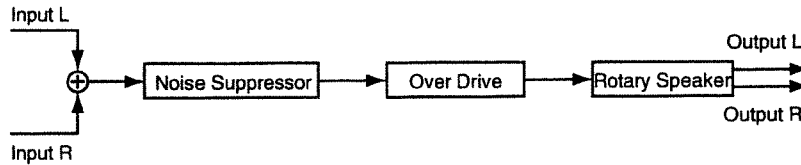

Parameter (full name)	Setting	Function
-----------------------	---------	----------

NS (Noise Suppressor): Mutes noise in the silent mode.

NoiseSup (Switch)	On, Off	Turns the noise suppressor on or off.
Thresh (Threshold)	0–100	Sets the level to start muting noise.
Release (Release)	0–100	Sets the time over which the volume will drop to 0 after the noise starts being muted.

ODV (Overdrive): Adds distortion to the sound.

OvDrive (Switch)	On, Off	Turns overdrive on or off.
Gain (Gain)	0–100	Sets the degree of sound distortion.
Level (Level)	0–100	Sets the volume of the overdrive sound.

ROT (Rotary Speaker): Simulates a rotary speaker.

LRate (Low Rate)	0.1–10.0 Hz	Sets the rotary frequency of the low frequency band roter.
HRate (High Rate)	0.1–10.0 Hz	Sets the rotary frequency of the high frequency band roter.

GuitarAmpSim (Guitar Amplifier Simulator)

Simulates a guitar amplifier.

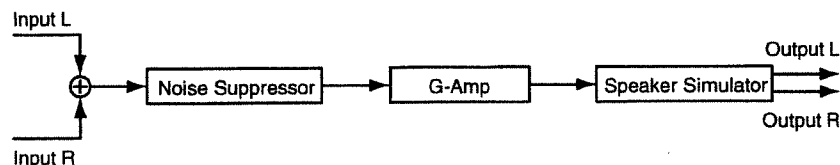

Pre-amplifier

Simulates the pre-amplifier section of a guitar amplifier. 14 types of pre-amplifiers that can be simulated are listed below: The type can be set with pre-amplifier Type.

- JC-120: The sound of a Roland.
- Clean Twin: The sound of standard built-in type vacuum tube amplifier.
- Match Drive: The sound of a recent vacuum tube amplifier widely used in blues, rock and fusion.
- BG Lead: The sound of a vacuum tube amplifier representative of the late 70's through 80's.
- MS1959<I>: The sound of the large vacuum tube amplifier stack that was indispensable to the British hard rock of the 70's, with input I connected.
- MS1959<II>: The same amplifier as MS1959 <I>, but with input II connected.
- MS1959<I+II>: The same amplifier as MS1959 <I>, but with input I and II connected in parallel.
- SLDN Lead: The sound of a vacuum tube amplifier usable in a wide variety of styles.
- Metal 5150: The sound of a large vacuum tube amplifier suitable for heavy metal.
- Metal Lead: A metal lead sound with a distinctive mid-range.
- OD-1: The sound of the BOSS OD-1 compact effector.
- OD-2Turbo: The sound of the BOSS OD-2 compact effector with the Turbo switch on.
- Distortion: Distortion sound
- Fuzz: Fuzz sound

* With JC-120, Clean Twin or BG Lead is selected, turning Bright (Bright) on generates clear-cut bright sound.

Speaker simulator

Simulates a speaker. The 12 types of speakers as listed below can be simulated: The type is set with Speaker Type. The type can be set with Speaker Type.

Type	Cabinet (size (in inch), number of units)	Speaker	Microphone
Small	Small open-back enclosure	10	Dynamic microphone
Middle	Open back enclosure	12 x 1	Dynamic microphone
JC-120	Open back enclosure	12 x 2	Dynamic microphone
Built In 1	Open back enclosure	12 x 2	Dynamic microphone
Built In 2	Open back enclosure	12 x 2	Condenser microphone
Built In 3	Open back enclosure	12 x 2	Condenser microphone
Built In 4	Open back enclosure	12 x 2	Condenser microphone
BG Stack 1	Sealed enclosure	12 x 2	Condenser microphone
BG Stack 2	Large sealed enclosure	12 x 2	Condenser microphone
MS Stack 1	Large sealed enclosure	12 x 4	Condenser microphone
MS Stack 2	Large sealed enclosure	12 x 4	Condenser microphone
Metal Stack	Large double stack	12 x 4	Condenser microphone

Recommended combinations of Pre-amplifier and Speaker

Pre-amplifier Type	Speaker Type
BG Lead	BG Stack 1, BG Stack 2, Middle
MS1959II	BG Stack 1, BG Stack 2, Metal Stack
MS1959I+II	BG Stack 1, BG Stack 2, Metal Stack
SLDN Lead	BG Stack 1, BG Stack 2, Metal Stack
Metal 5150	BG Stack 1, BG Stack 2, Metal Stack
Metal Lead	BG Stack 1, BG Stack 2, Metal Stack
OD-2 Turbo	Built In1 - 4
Distortion	Built In1 - 4
Fuzz	Built In 1 - 4

➔ Continued...

Algorithm List

Parameter (full name)	Setting	Function
NS (Noise Suppressor): Mutes noise in the silent mode.		
NoiseSup (Switch)	On, Off	Turns the noise suppressor on or off.
Thresh (Threshold)	0-100	Sets the level to start muting noise.
Release (Release)	0-100	Sets the time over which the volume will drop to 0 after the noise starts being muted.
AMP (Pre-Amplifier): Simulates the pre-amplifier section of a guitar amplifier.		
PreAmp (Switch)	On, Off	Turns the compressor on or off.
AMP (Pre-amplifier type)	See the column on the previous page.	Sets the type of the guitar amplifier.
Volume (Volume)	0-100	Sets the volume and degree of distortion of the amplifier.
Master (Master)	0-100	Sets the volume of the entire pre-amplifier
Gain (Gain)	Low, Middle, High	Sets the degree of sound distortion on the pre-amplifier.
Bass (Bass)	0-100	Sets the tone of the low range.
Middle (Middle)	0-100	Sets the tone of the middle range. *2
Treble (Treble)	0-100	Sets the tone of the high range.
Presence (Presence)	0-100 (-100-0)	Sets the tone of the ultra-high range. *3
Bright (Bright)	On, Off	You can set this on to generate clear-cut bright sounds. *1
SP (Speaker Simulator): Simulates a speaker.		
Speaker (Switch)	On, Off	Turns the speaker simulator on or off.
SP (Speaker Type)	See the column on the previous page.	Sets the speaker type.
Mic Setting (Microphone Setting)	1, 2, 3	Sets the location of the microphone that is recording the sound of the speaker. This can be adjusted in three steps, with the microphone becoming more distant in the order of 1, 2, and 3.
Mic Level (Microphone Level)	0-100	Sets the microphone volume.
DiLevel (Direct Level)	0-100	Sets the volume of the direct sound.



*1: Can be set only when JC-120, Clean Twin or BG Lead is selected for Pre-amplifier Type.

*2: Cannot be set when Match Drive is selected for the Pre-amplifier Type.

*3: The setting range is -100 to 0 when Match Drive is selected for the Pre-amplifier Type.

St Phaser (Stereo Phaser)

A phaser adds a phase-shifted sound to the direct sound, producing a twisting modulation that creates spaciousness and depth.

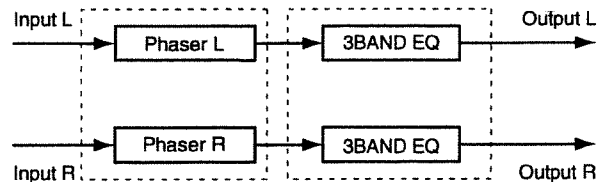

Phaser and Flanger

The effects obtained with Phaser and Flanger are very similar. Both add twisting modulation effects to the sound, creating spaciousness and depth. In other words, they create something like strongly accentuated chorus. Phaser provides a unique surge sounding like bubbles coming up. Flanger works mostly in the same mechanism as for Chorus. Besides that, it can create SE-type sounds like ascending / descending sounds of a jet.

Parameter (full name)	Setting	Function
PHS (Phaser): Adds a sound with a shifted phase to the direct sound to add spaciousness to the sound.		
Phaser (Switch)	On, Off	Turns the phaser on or off.
Mode (Mode)	4, 8, 12, 16	Sets the number of stages in the phaser (p. 75).
Rate (Rate)	0.1–10.0 Hz	Sets the rate at which the phaser will modulate.
Depth (Depth)	0–100	Sets the depth of modulation.
Pol (Polarity)	Sync, Inv	Sets the right and left phases of modulation. *3
Manual (Manual)	0–100	Sets the reference frequency for adding the surging effect to the sound.
Reso (Resonance)	0–100	Enhances frequency components at around the center frequency set with Manual. *1
CrossFB (Cross-Feedback Level)	0–100	Sets the amount of the phaser sound to be returned to the channel opposite to the one used for input. *2
EFLevel (Effect Level)	-100–100	Sets the volume of the phaser sound.
DiLevel (Direct Level)	-100–100	Sets the volume of the direct sound.

→ Continued...

Algorithm List

EQ (Equalizer)

EQ (Switch)	On, Off	Turns the equalizer on or off.
LowType (Low Type)	Shlv, Peak	Sets the type of the low frequency band equalizer (Shlving type or peaking type).
Low.G (Low Gain)	-12~ +12 dB	Sets the boost/cut amount in the low frequency band.
Low.F (Low Frequency)	20 - 2000 Hz	Sets the center frequency in the low frequency band.
Low.Q (Low Q)	0.3-10.0	Sets the width of the area around the low frequency that will be affected by the gain settings.1 *4
Mid.G (Middle Gain)	-12~ +12 dB	Sets the boost/cut amount in the middle frequency band.
Mid.F (Middle Frequency)	200-8000 Hz	Sets the center frequency in the middle frequency band.
Mid.Q (Middle Q)	0.3-10.0	Sets the width of the area around the middle frequency that will be affected by the gain settings.
Hi Type (High Type)	Shlv, Peak	Sets the type of the high frequency band equalizer (Shlving type or peaking type).
Hi.G (High Gain)	-12~ +12 dB	Sets the boost/cut amount in the high frequency band.
Hi.F (High Frequency)	1.4-20.0 kHz	Sets the center frequency in the high frequency band.
Hi.Q (High Q)	0.3-10.0	Sets the width of the area around the high frequency that will be affected by the gain settings.1 *4
Out Level (Output Level)	0-100	Sets the volume after passing through the equalizer.

NOTE

- *1: An excessively great values for Resonance (Reso) may cause oscillation.
- *2: An excessively large value for Cross-Feedback level may cause oscillation.
- *3: When a mono source has been input, set "Inv" to provide spaciousness to the sound. Set "Sync" for inputting a stereo source.
- *4: If Low Type (LowType) or High Type (Hi Type) is set to "Shlv (Shlving Type)," the setting for LowQ or High Q is invalid.

St Flnger (Stereo Flanger)

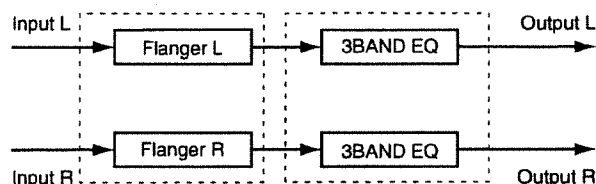

FLG (Flanger): Adds effect similar to ascending/descending sound of a jet.

Flanger (Switch)	On, Off	Turns the flanger on or off.
Rate (Rate)	0.1–10.0 Hz	Sets the rate at which the flanger is modulated.
Depth (Depth)	0–100	Sets the depth of modulation.
Pol (Polarity)	Sync, Inv	Sets the right and left phases of modulation. *3
Manual (Manual)	0–100	Sets the center frequency subject to application of the Flanger effect.
Reso (Resonance)	0–100	Enhances frequency components at around the center frequency set with Manual. *1
CrossFB (Cross-Feedback Level)	0–100	Sets the amount of the flanger sound to be returned to the channel opposite to the one used for input. *2
EFLevel (Effect Level)	-100–100	Sets the volume of the flanger sound.
DLevel (Direct Level)	-100–100	Sets the volume of the direct sound.

EQ (Equalizer)

EQ (Switch)	On, Off	Turns the equalizer on or off.
LowType (Low Type)	Shlv, Peak	Sets the type of the low frequency band equalizer (Shlving type or peaking type).
Low.G (Low Gain)	-12– +12 dB	Sets the boost/cut amount in the low frequency band.
Low.F (Low Frequency)	20 - 2000 Hz	Sets the center frequency in the low frequency band.
Low.Q (Low Q)	0.3–10.0	Sets the width of the area around the low frequency that will be affected by the gain settings.1 *4
Mid.G (Middle Gain)	-12– +12 dB	Sets the boost/cut amount in the middle frequency band.
Mid.F (Middle Frequency)	200–8000 Hz	Sets the center frequency in the middle frequency band.
Mid.Q (Middle Q)	0.3–10.0	Sets the width of the area around the middle frequency that will be affected by the gain settings.
Hi Type (High Type)	Shlv, Peak	Sets the type of the high frequency band equalizer (Shlving type or peaking type).
Hi.G (High Gain)	-12– +12 dB	Sets the boost/cut amount in the high frequency band.
Hi.F (High Frequency)	1.4–20.0 kHz	Sets the center frequency in the high frequency band.
Hi.Q (High Q)	0.3–10.0	Sets the width of the area around the high frequency that will be affected by the gain settings.1 *4
Out Level (Output Level)	0–100	Sets the volume after passing through the equalizer.



*1: An excessively great values for Resonance (Reso) may cause oscillation.

*2: An excessively large value for Cross-Feedback level may cause oscillation.

*3: When a mono source has been input, set “Inv” to provide spaciousness to the sound. Set “Sync” for inputting a stereo source.

*4: If Low Type (LowType) or High Type (Hi Type) is set to “Shlv (Shlving Type),” the setting for LowQ or High Q is invalid.

Algorithm List

Dual Comp/Lim (Dual Compressor/Limiter)

Compressors suppress signals at high levels. Limiter is used to control excessive input. Each of the above is used to prevent sound distortion or to control dynamics.

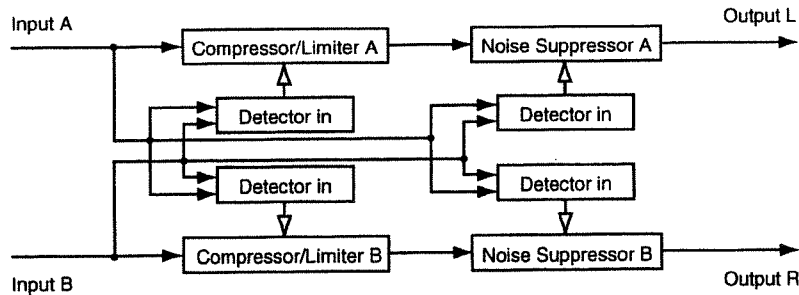

NOTE

Input A is input into the L-channel side of the effect. Therefore, it is required to insert and connect "Lch" of the effect to the channel handling Input A. Similarly, Input B is input into the R-channel side of the effect. Insert and connect "Rch" of the effect to the channel handling Input B.

Difference between Compressor and Limiter

Behaviors of Compressor and Limiter are very similar. Both of them compress the entire output signals if input signals exceed a certain level (threshold level), according to the input level.

Compressor automatically drops the amplitude to suppress all levels in the exceeding section. Limiter suppresses only the maximum level of input signals.

Using as Limiter

Threshold Level (Thresh):	Relatively high
Ratio (Ratio):	100:1
Attack Time (Attack):	Relatively short
Release Time (Release):	Relatively short

Using as Compressor

Threshold Level (Thresh):	A level that does not cause distortion of output sounds.
Ratio (Ratio):	1.5:1, 2:1, 4:1
Attack Time (Attack):	Adjusted according to the input sound type.
Release Time (Release):	Adjusted according to the input sound type.

Parameter (full name)	Setting	Function
CLA, CLB		
(Compressor):	Compresses the entire output signals when the input volume has exceeded a preset value.	
(Limiter):	Suppresses the volume of the section where the input volume has exceeded the preset value.	
Comp/Lmt (Switch)	On, Off	Turns the compressor/limiter on or off.
Detect (Detect In)	A, B, Link	Selects Input A or B for controlling compressor/limiter. Set this to "Link" for controlling by the input at a greater level.
Level (Output Level)	-60–12 dB	Sets the volume of the compressor/limiter sound.
Thresh (Threshold Level)	-60 - 0 dB	Sets the level at which the compressor/limiter starts taking effect.
Attack (Attack Time)	0–100	Sets the time from when the input level exceeds the threshold level to when the effect begins to apply.
Release (Release Time)	0–100	Sets the time from when the input level drops below the threshold level to when the effect ceases to apply.
Ratio (Ratio)	1.5:1, 2:1, 4:1, 100:1	Sets the compression ratio applied when threshold level (Thresh) is exceeded.
NS (Noise Suppressor): Mutes noise in the silent mode.		
NoiseSup (Switch)	On, Off	Turns the noise suppressor on or off.
Detect (Detect In)	A, B, Link	Selects the input (Input A/Input B) for controlling Noise Suppressor. Set this to "Link" for controlling by the input at a greater level.
Thresh (Threshold)	0–100	Sets the level to start muting noise.
Release (Release)	0–100	Sets the time over which the volume will drop to 0 after the noise starts being muted.

Gate Reverb

This is a reverb in which the reverberation is muted during its decay. Its reverse mode can be used in conjunction with Accent sounds to obtain sounds like from reverse playback of a tape.

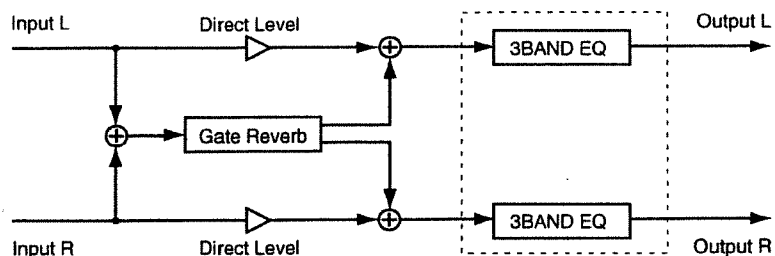

Gate Reverb

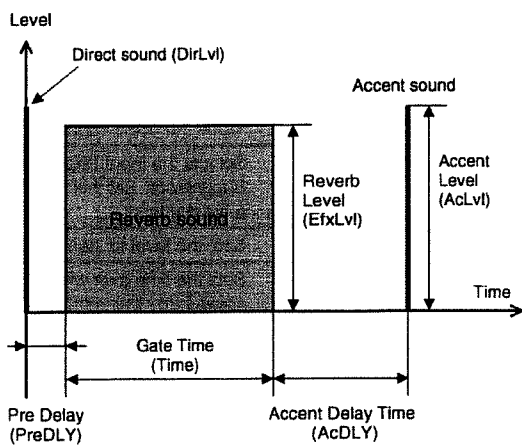

Reverb applications

You can select how reverb sounds can be applied by setting up Gate Mode (Mode).

- Normal: Ordinary Gate Reverb
- L->R: The Gate Reverb sound moves from the left to right side.
- R->L: The Gate Reverb sound moves from the right to left side.
- Reverse1: Reverse Gate (effect as if reverb are replayed backward.)
- Reverse2: Reverse Gate that causes the reverb sound to decay midway.

Parameter (full name)	Setting	Function
GRV (Gate Reverb): Mutes the revert sound midway.		
GtReverb (Switch)	On, Off	Turns the gate reverb on or off.
Time (Gate Time)	10–400 ms	Sets the time from when the reverb sound begins until it is muted.
PreDLY (Pre-Delay)	0–300 ms	Sets the time until the reverb sound appears.
Mode (Gate Mode)	See the column on the previous page.	Defines how the reverb sound is applied.
EFLevel (Effect Level).	-100–100	Sets the volume of the gate reverb sound.
DiLevel (Direct Level)	-100–100	Sets the volume of the direct sound.
Thick (Thickness)	0–100	Sets the thickness of the reverb sound.
Density (Density)	0–100	Sets the density of the reverb sound.
AcDLY (Accent Delay Time)	0–200 ms	Sets the time from when the reverb sound is muted until the accent sound appears.
AcLevel (Accent Level)	0–100	Sets the volume of the accent sound.
AcPan (Accent Pan)	L63–R63	Sets the pan of the accent sound.

EQ (Equalizer)

EQ (Switch)	On, Off	Turns the equalizer on or off.
LowType (Low Type)	Shlv, Peak	Sets the type of the low frequency band equalizer (Shlving type or peaking type).
Low.G (Low Gain)	-12– +12 dB	Sets the boost/cut amount in the low frequency band.
Low.F (Low Frequency)	20 - 2000 Hz	Sets the center frequency in the low frequency band.
Low.Q (Low Q)	0.3–10.0	Sets the width of the area around the low frequency that will be affected by the gain settings.1 *1
Mid.G (Middle Gain)	-12– +12 dB	Sets the boost/cut amount in the middle frequency band.
Mid.F (Middle Frequency)	200–8000 Hz	Sets the center frequency in the middle frequency band.
Mid.Q (Middle Q)	0.3–10.0	Sets the width of the area around the middle frequency that will be affected by the gain settings.
Hi Type (High Type)	Shlv, Peak	Sets the type of the high frequency band equalizer (Shlving type or peaking type).
Hi.G (High Gain)	-12– +12 dB	Sets the boost/cut amount in the high frequency band.
Hi.F (High Frequency)	1.4–20.0 kHz	Sets the center frequency in the high frequency band.
Hi.Q (High Q)	0.3–10.0	Sets the width of the area around the high frequency that will be affected by the gain settings.1 *1
Out Level (Output Level)	0–100	Sets the volume after passing through the equalizer.



*1: If Low Type (LowType) or High Type (Hi Type) is set to "Shlv (Shlving Type)," the setting for LowQ or High Q is invalid.

Algorithm List

MultiTapDly (Multi-Tap Delay)

This is a Delay feature that can set 10 delay sounds separately.

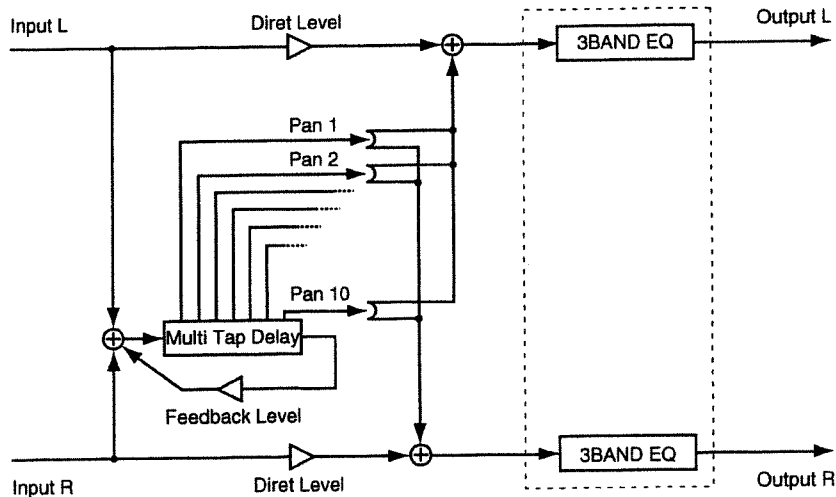

Parameter (full name)	Setting	Function
-----------------------	---------	----------

MTD (Multi-Tap Delay): Issues 10 delay sounds separately.

Parameter (full name)	Setting	Function
Tim 1 - Tim 10 (Delay Time 1 - 10)	0-1200 ms	Sets the time from the direct sound until when the delay sound for channels 1-10 is heard.
Level 1 - Level 10 (Delay Level 1 - 10)	0-100	Sets the volumes of delay sounds for channels 1-10.
Pan 1 - Pan 10 (Pan 1 - 10)	L63-R63	Sets the pan of the delay sounds for channels 1-10.
FB Tim (Feedback Delay Time)	0-1200 ms	Sets the repetition frequency for feedback.
FB Level (Feedback Level)	-100-100	Sets the amount of the delay sound should be returned to the delay input.
EFLevel (Effect Level).	-100-100	Sets the volume of the delay sound.
DiLevel (Direct Level)	-100-100	Sets the volume of the direct sound.

EQ (Equalizer)

EQ (Switch)	On, Off	Turns the equalizer on or off.
LowType (Low Type)	Shlv, Peak	Sets the type of the low frequency band equalizer (Shlving type or peaking type).
Low.G (Low Gain)	-12– +12 dB	Sets the boost/cut amount in the low frequency band.
Low.F (Low Frequency)	20 - 2000 Hz	Sets the center frequency in the low frequency band.
Low.Q (Low Q)	0.3–10.0	Sets the width of the area around the low frequency that will be affected by the gain settings. ^{*1}
Mid.G (Middle Gain)	-12– +12 dB	Sets the boost/cut amount in the middle frequency band.
Mid.F (Middle Frequency)	200–8000 Hz	Sets the center frequency in the middle frequency band.
Mid.Q (Middle Q)	0.3–10.0	Sets the width of the area around the middle frequency that will be affected by the gain settings.
Hi Type (High Type)	Shlv, Peak	Sets the type of the high frequency band equalizer (Shlving type or peaking type).
Hi.G (High Gain)	-12– +12 dB	Sets the boost/cut amount in the high frequency band.
Hi.F (High Frequency)	1.4–20.0 kHz	Sets the center frequency in the high frequency band.
Hi.Q (High Q)	0.3–10.0	Sets the width of the area around the high frequency that will be affected by the gain settings. ^{*1}
Out Level (Output Level)	0–100	Sets the volume after passing through the equalizer.



^{*1}: If Low Type (LowType) or High Type (Hi Type) is set to “Shlv (Shlving Type),” the setting for LowQ or High Q is invalid.

Algorithm List

Stereo Multi

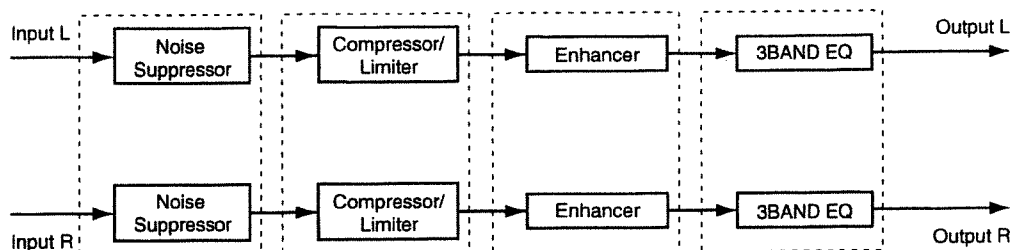

Parameter (full name)	Setting	Function
NS (Noise Suppressor): Mutes noise in the silent mode.		
NoiseSup (Switch)	On, Off	Turns the noise suppressor on or off.
Thresh (Threshold)	0–100	Sets the level to start muting noise.
Release (Release)	0–100	Sets the time over which the volume will drop to 0 after the noise starts being muted.
CL (Compressor/Limiter): Compresses the entire output signals when the input volume exceeds a specified value.		
Comp/Lim (Switch)	On, Off	Turns the compressor on or off.
Level (Output Level)	-60–12 dB	Sets the volume of the compressor sound.
Thresh (Threshold Level)	-60–0 dB	Sets the level at which the compressor starts taking effect.
Attack (Attack Time)	0–100	Sets the time from when the input level exceeds the threshold level to when the effect begins to apply.
Release (Release Time)	0–100	Sets the time from when the input level drops below the threshold level to when the effect ceases to apply.
Ratio (Ratio)	1.5:1, 2:1, 4:1, 100:1	Sets the compression ratio applied when the threshold level is exceeded.
ENH (Enhancer): Accentuates the sound and push the sound forward.		
Enhancer (Switch)	On, Off	Turns the enhancer on or off.
Sens (Sense)	0–100	Sets the degree of the enhancer effect desired.
Freq (Frequency)	1.0–10.0 kHz	Sets the frequency at which the enhancer effect starts working.
MixLvl (Mix Level)	0–100	Sets the amount of the enhancer sound should be mixed into the direct sound.
Level (Level)	0–100	Sets the volume of the enhancer sound.

EQ (Equalizer)

EQ (Switch)	On, Off	Turns the equalizer on or off.
LowType (Low Type)	Shlv, Peak	Sets the type of the low frequency band equalizer (Shlving type or peaking type).
Low.G (Low Gain)	-12- +12 dB	Sets the boost/cut amount in the low frequency band.
Low.F (Low Frequency)	20 - 2000 Hz	Sets the center frequency in the low frequency band.
Low.Q (Low Q)	0.3-10.0	Sets the width of the area around the low frequency that will be affected by the gain settings.1 *1
Mid.G (Middle Gain)	-12- +12 dB	Sets the boost/cut amount in the middle frequency band.
Mid.F (Middle Frequency)	200-8000 Hz	Sets the center frequency in the middle frequency band.
Mid.Q (Middle Q)	0.3-10.0	Sets the width of the area around the middle frequency that will be affected by the gain settings.
Hi Type (High Type)	Shlv, Peak	Sets the type of the high frequency band equalizer (Shlving type or peaking type).
Hi.G (High Gain)	-12- +12 dB	Sets the boost/cut amount in the high frequency band.
Hi.F (High Frequency)	1.4-20.0 kHz	Sets the center frequency in the high frequency band.
Hi.Q (High Q)	0.3-10.0	Sets the width of the area around the high frequency that will be affected by the gain settings.1 *1
Out Level (Output Level)	0-100	Sets the volume after passing through the equalizer.



*1: If Low Type (LowType) or High Type (Hi Type) is set to "Shlv (Shlving Type)," the setting for LowQ or High Q is invalid.

Reverb 2

This gate reverb works in either of two modes of gate operation (Gate/Ducking). In the Gate mode, the gate opens when a certain volume (Threshold Level) is exceeded while in the Ducking mode, the gate opens when the volume becomes as low as or lower than Threshold Level. You can use two reverbs (FX1 and FX2) with different settings, or use it in combination with a previous reverb.

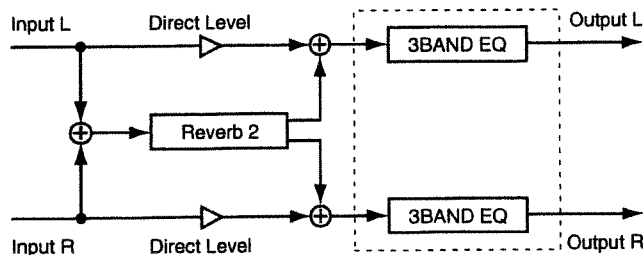

Reverb types

There are five reverb types: You can choose the type with Reverb Type.

Room1:	Ordinary room reverb
Room2:	Room reverb with a softer tone compared with Room1
Hall1:	Ordinary hall reverb
Hall2:	Hall reverb with a softer tone compared with Hall1
Plate:	Plate reverb

Selecting Gate type

Reverb sounds have different effects depending on the gate operation types. Use Gate Mode to select the type.

Gate:	The gate opens when the volume of the direct sound exceeds the value set with Threshold Level (Thres). The gate closes when the volume drops below the Threshold Level value.
Ducking:	Operates in the opposite manner as in the "Gate" mode. The gate closes when the volume of the direct sound exceeds the value set with Threshold Value. The gate opens when the volume becomes as low as or lower than the Threshold Level value.

Parameter (full name)	Setting	Function
REV 2 (Reverb 2): Gate reverb with two modes of gate operation		
Reverb (Switch)	On, Off	Turns the reverb on or off.
Type (Reverb Type)	See the column on the previous page.	Sets the reverb type.
Time (Reverb Time)	0.1–10.0 sec.	Sets the length (time) of the reverb sound.
PreDLY (Pre-Delay)	0–200 ms	Sets the time until the reverb sound is output.
Density (Density)	0–100	Sets the density of the reverb sound.
HPF (High Pass Filter)	Thru, 20 - 2000 Hz	Sets the frequency at which HPF starts taking effect. Set this to "Thru" if HPF is to be disabled.
LPF (Low Pass Filter)	1.0–20.0 kHz, Thru	Sets the frequency at which LPF starts taking effect. Set this to "Thru" if LPF is to be disabled.
EFLevel (Effect Level).	0–100	Sets the volume of the reverb sound.
DiLevel (Direct Level)	0–100	Sets the volume of the direct sound.
Gate (Gate)	On, Off	Opens or closes the gate.
Mode (Gate Mode)	Gate, Ducking	Sets the gate operation type.
Thresh (Threshold)	0–100	Sets the reference volume for controlling gate operations.
Attack (Attack)	1–100	Sets the time from when the direct sound level exceeds the threshold level until when the gate is completely open.
Release (Release)	1–100	Sets the time from when the hold time has elapsed until the sound is completely muted.
Gate Hold Time (Hold Time)	1–100	Sets the time from when the input falls below the threshold level until when the release begins.

EQ (Equalizer)

EQ (Switch)	On, Off	Turns the equalizer on or off.
LowType (Low Type)	Shlv, Peak	Sets the type of the low frequency band equalizer (Shlving type or peaking type).
Low.G (Low Gain)	-12– +12 dB	Sets the boost/cut amount in the low frequency band.
Low.F (Low Frequency)	20 - 2000 Hz	Sets the center frequency in the low frequency band.
Low.Q (Low Q)	0.3–10.0	Sets the width of the area around the low frequency that will be affected by the gain settings. ¹
Mid.G (Middle Gain)	-12– +12 dB	Sets the boost/cut amount in the middle frequency band.
Mid.F (Middle Frequency)	200–8000 Hz	Sets the center frequency in the middle frequency band.
Mid.Q (Middle Q)	0.3–10.0	Sets the width of the area around the middle frequency that will be affected by the gain settings.
Hi Type (High Type)	Shlv, Peak	Sets the type of the high frequency band equalizer (Shlving type or peaking type).
Hi.G (High Gain)	-12– +12 dB	Sets the boost/cut amount in the high frequency band.
Hi.F (High Frequency)	1.4–20.0 kHz	Sets the center frequency in the high frequency band.
Hi.Q (High Q)	0.3–10.0	Sets the width of the area around the high frequency that will be affected by the gain settings. ¹
Out Level (Output Level)	0–100	Sets the volume after passing through the equalizer.



¹: If Low Type (LowType) or High Type (Hi Type) is set to "Shlv (Shlving Type)," the setting for LowQ or High Q is invalid.

Algorithm List

Space Chorus

This is a chorus effect simulating Roland SDD-320. The effect to be changed can be reproduced by turning the four buttons 1 to 4 on or off.



Parameter (full name)	Setting	Function
SCH (Space Chorus): Adds a chorus effect simulating SDD-320.		
SpaceCho (Switch)	On, Off	Turns the space chorus on or off.
InMod (Input Mode)	Mono, Stereo	Specifies whether the input signal is stereo or mono.
Mode (Space Mode)	1, 2, 3, 4, 1+4, 2+4, 3+4	Sets the chorus variation style.
MixBal (Mix Balance)	0-100	Sets the volume balance between the chorus sound and the direct sound.

Lo-Fi Process (Lo-Fi Processor)

This allows you to create a "lo-fi" sound by lowering the sample rate and/or decreasing the number of bits.

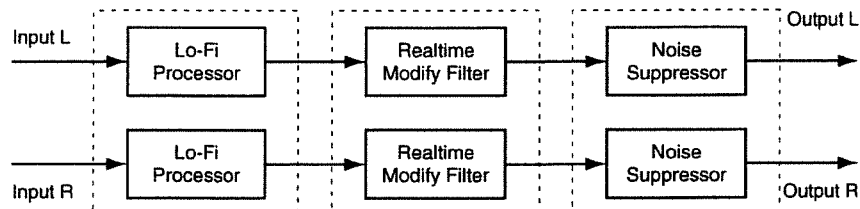

Creating lo-fi sounds

Follow the steps below to create lo-fi sounds essential to dance music including hip-hop and DJ music.

Lo-fi Processor

- Turn Pre Filter and Post Filter off. This provides powerful lo-fi sounds containing digital distortion.
- Set Rate and Bit to relatively low values. Note, however, an excessively low value for Bit may cause big noise even in the silent mode. In that case, increase Threshold (Thresh) of Noise Suppressor.

Realtime Modify Filter

- Increase resonance to add a twist to the sound. Note that excessive resonance may cause oscillation.

LFP (Lo-Fi Processor): Creates lo-fi sounds.

LoFiPros (Switch)	On, Off	Turns the lo-fi processor on or off.
PreFilt (Pre Filter Switch)	On, Off	Turns the filter to reduce digital distortion on or off.
Rate (Rate)	Off, 1/2 - 1/32	Sets the sample rate. Set Rate to "Off" if no change is desired.
Bit (Bit)	Off, 15 bits - 1 bit	Sets the number of bits in data. Set Bit to "Off" if no change is desired.
PostFilt (Post Filter Switch)	On, Off	Turns the filter to reduce digital distortion due to modification to lo-fi sounds on or off.
EFLLevel (Effect Level).	0-100	Sets the volume of the lo-fi sound.
DiLevel (Direct Level)	0-100	Sets the volume of the direct sound.

RMF (Realtime Modify Filter): Creates sounds with a twist.

RMF (Switch)	On, Off	Turns the realtime modify filter on or off.
Type (Type)	LPF, BPF, HPF	Sets the filter type.
CutOff (Cutoff Frequency)	0-100	Sets the cutoff frequency.
Reso (Resonance)	0-100	Enhances the frequency components around cutoff frequency.
Gain (Gain)	0-24 dB	Sets the volume of the realtime modify filter.

NS (Noise Suppressor): Mutes noise in the silent mode.

Thresh (Threshold)	0-100	Sets the level to start muting noise.
Release (Release)	0-100	Sets the time over which the volume will drop to 0 after the noise starts being muted.

Algorithm List

ParametricEQ (4-Band Parametric Equalizer)

This is an equalizer that can freely change the cutoff frequency or the band width (Q). With this equalizer, you can create sounds with subtlety.

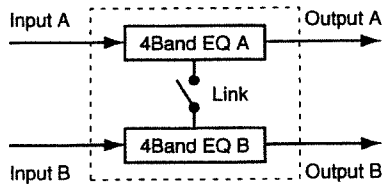

Cutting noise.

4-Band Parametric Equalizer can freely change the cutoff frequency or the band width (Q) at four points, that is, in the high, high middle, low middle and low frequency bands.

Capitalizing on this feature, you can precisely capture the point where any noise or howling is occurring. To find such point, the first step is to increase the gain for easier identification of sound variation and move the cutoff frequency little by little. Then, perform filtering by sharpening "Q."

Controlling Channels A and B separately

Setting Link On enables simultaneous control on the 4-Band Parametric Equalizer via Channel B according to the settings on the Channel A side. To control Channels A and B separately, turn Link off.

Parameter (full name)	Setting	Function
LNK (Link): Makes Channel B follow the settings for Channel A.		
Link (Link Switch)	On, Off	Specifies if Channel B follows or does not follow the settings for Channel A.
EQ A / EQ B (4 Band Parametric Equalizer): Parametric equalizer with four bands.		
EQAch, EQBch (Switch)	On, Off	Turns the parametric equalizer on or off.
InputG (Input Gain)	-60~ +12 dB	Sets the overall volume before passing through the equalizer.
LowType (Low Type)	Shlv, Peak	Sets the type of the low frequency band equalizer (Shlving type or peaking type).
LowG (Low Gain)	-12~ +12 dB	Sets the boost/cut amount in the low frequency band.
LowF (Low Frequency)	20 - 2000 Hz	Sets the center frequency in the low frequency band.
LowQ (Low Q)	0.3-10	Sets the width of the area around the low frequency that will be affected by the gain settings. *1
LowMidG (Low Middle Gain)	-12~ +12 dB	Sets the boost/cut amount in the low middle frequency band.
LoMidF (Low Middle Frequency)	200-8000 Hz	Sets the center frequency in the low middle frequency band.
LoMidQ (Low Middle Q)	0.3-10	Sets the width of the area around the Low middle frequency that will be affected by the gain settings.
HiMidG (High Middle Gain)	-12~ +12 dB	Sets the boost/cut amount in the high middle frequency band.
HiMidF (High Middle Frequency)	200-8000 Hz	Sets the center frequency in the high middle frequency band.
HiMidQ (High Middle Q)	0.3-10	Sets the width of the area around the high middle frequency that will be affected by the gain settings.
HiType (High Type)	Shlv, Peak	Sets the type of the high frequency band equalizer (Shlving type or peaking type).
HiG (High Gain)	-12~ +12 dB	Sets the boost/cut amount in the high frequency band.
HiF (High Frequency)	1.4-20.0 kHz	Sets the center frequency in the high frequency band.
HiQ (High Q)	0.3-10	Sets the width of the area around the high frequency that will be affected by the gain settings. *1
Level (Output Level)	-60~ +12 dB	Sets the overall volume after passing through the equalizer.



*1: If Low Type (LowType) or High Type (Hi Type) is set to "Shlv (Shlving Type)," the setting for LowQ or High Q is invalid.

Graphic EQ (10-Band Graphic Equalizer)

This Equalizer sets the boost / cut amount by each segment of the frequency divided into ten bands. In performing PA at a live, this feature is useful to prevent howling by cutting the site-specific resonance frequency.

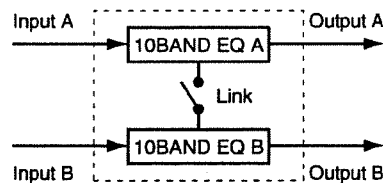

Preventing howling

While performing PA at a live, follow the steps below to prevent howling. First, identify the site-specific resonance frequency to cut its gain.

Controlling Channels A and B separately

Setting Link On enables simultaneous control on the 10-Band Parametric Equalizer via Channel B according to the settings on the Channel A side.

To control Channels A and B separately, turn Link Off.

Parameter (full name)	Setting	Function
LNK (Link): Makes Channel B follow the settings for Channel A.		
Link (Link Switch)	On, Off	Specifies if Channel B follows or does not follow the settings for Channel A.
EQA / EQB (10-Band Graphic Equalizer): Simulates a 10-band graphic equalizer.		
EQA, EQB (Switch)	On, Off	Turns the parametric equalizer on or off.
InputG (Input Gain)	-60~ +12 dB	Sets the overall volume before passing through the equalizer.
31.2 - 16 k (Gain)	-12~ +12 dB	Sets the boost/cut amount at the respective frequencies.
Level (Output Level)	-60~ +12 dB	Sets the overall volume after passing through the equalizer.

Algorithm List

Hum Canceler

Eliminates annoying hum (or "surge" sounding "boon").

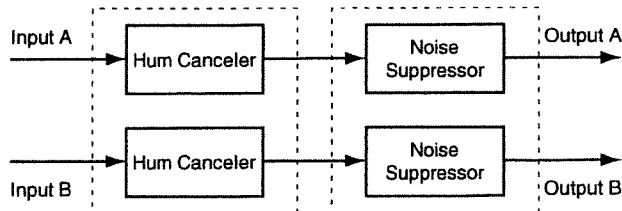

Removing hum

Hum is a noise with a certain low frequency. Hum is generated mostly due to ingress of part of alternating current into signals as alternating current is converted into direct current in the power circuit. Sets Frequency (Freq) to that according with the frequency of the power source (50 Hz/60 Hz), and hum with that frequency and frequencies of its multiples can be removed.

Range Lo and Range Hi can be used to specify the frequency band of hum to be removed.

Parameter (full name)	Setting	Function
HC (Hum Canceler): Removes hum.		
HumCancel (Switch)	On, Off	Turns the hum canceler on or off.
Freq (Frequency)	20.0–800.0 Hz	Sets the frequency of hum to be removed.
Width (Width)	10–40%	Sets the width of the filter which will remove the hum.
Depth (Depth)	0–100	Sets the depth of the filter which will remove the hum.
Thresh (Threshold)	0–100	Sets the level at which the hum is to be removed.
RngL (Range Low)	Unlimit, 20 - 2000 Hz	Sets the lower limit of the frequency of hum to be removed. *1
RngH (Range High)	1.0 - 20.0 kHz, Unlimit	Sets the upper limit of the frequency of hum to be removed. *2
NS (Noise Suppressor): Mutes noise in the silent mode.		
NoiseSup (Switch)	On, Off	Turns the noise suppressor on or off.
Thresh (Threshold)	0–100	Sets the level to start muting noise.
Release (Release)	0–100	Sets the time over which the volume will drop to 0 after the noise starts being muted.

NOTE

*1: Setting to "Unlimit" means that the frequency that can be played back on this unit is the lower limit.

*2: Setting to "Unlimit" means that the frequency that can be played back on this unit is the upper limit.

Vocal Canceled

When a stereo source is being input from CD or DAT and so on, this cancels the sound which is located in the stereo center, such as the vocal or bass.

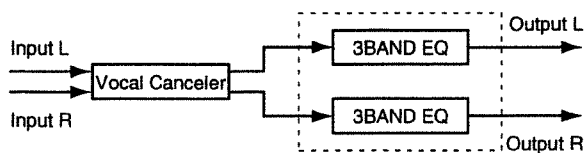

NOTE

Depending on the music source, sounds that you do not wish to be canceled may be canceled as well. In particular if the musical source has heavy reverb or if the sound that you wish to delete is not located in the center, the vocal canceler may not produce the desired result.

Canceling the vocals alone

Vocal Canceled cancels the sound located in the center. That means it cancels sounds such as the bass and sounds of the lead instrument along with vocal sounds. To cancel vocals only to create music for karaoke, for example, set Range Lo to around 100 Hz and Range Hi to around 1 kHz.

Parameter (full name)	Setting	Function
VC (Vocal Canceled):	Cancels sounds located in the center such as vocals and the bass.	
VclCancel (Switch)	On, Off	Turns the vocal canceler on or off.
Balance (Balance)	0-100	If the sound that you wish to cancel is not located in the center, find the point at which it is most effectively cancelled.
RngL (Range Low)	Unlimit, 20 - 2000 Hz	Sets the lower limit of the frequency band to be canceled. *1
RngH (Range High)	1.0 - 20.0 kHz, Unlimit	Sets the upper limit of the frequency band to be canceled. *2
EQ (Equalizer)		
EQ (Switch)	On, Off	Turns the equalizer on or off.
LowType (Low Type)	Shlv, Peak	Sets the type of the low frequency band equalizer (Shlving type or peaking type).
Low.G (Low Gain)	-12- +12 dB	Sets the boost/cut amount in the low frequency band.
Low.F (Low Frequency)	20 - 2000 Hz	Sets the center frequency in the low frequency band.
Low.Q (Low Q)	0.3-10.0	Sets the width of the area around the low frequency that will be affected by the gain settings. *3
Mid.G (Middle Gain)	-12- +12 dB	Sets the boost/cut amount in the middle frequency band.
Mid.F (Middle Frequency)	200-8000 Hz	Sets the center frequency in the middle frequency band.
Mid.Q (Middle Q)	0.3-10.0	Sets the width of the area around the middle frequency that will be affected by the gain settings.
Hi Type (High Type)	Shlv, Peak	Sets the type of the high frequency band equalizer (Shlving type or peaking type).
Hi.G (High Gain)	-12- +12 dB	Sets the boost/cut amount in the high frequency band.
Hi.F (High Frequency)	1.4-20.0 kHz	Sets the center frequency in the high frequency band.
Hi.Q (High Q)	0.3-10.0	Sets the width of the area around the high frequency that will be affected by the gain settings. *3
Out Level (Output Level)	0-100	Sets the volume after passing through the equalizer.

Algorithm List

NOTE

- *1: Setting to "Unlimit" means that the frequency that can be played back on this unit is the lower limit.
- *2: Setting to "Unlimit" means that the frequency that can be played back on this unit is the upper limit.
- *3: If Low Type (LowType) or High Type (Hi Type) is set to "Shlv (Shlving Type)," the setting for LowQ or High Q is invalid.

Voice Transformer

You can convert male voice into female voice, female voice into male voice, and human voice into mechanical voice to create sounds of various qualities by controlling the base pitch and the formant separately.

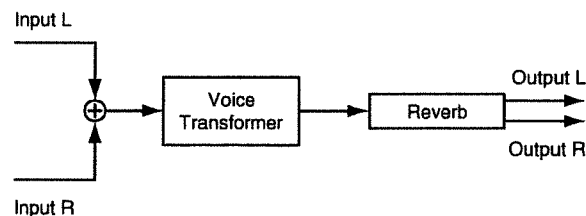

NOTE

- * When inputting voice, use voice of one person only. Inputting voices of more than one person disables normal operation.
- * Be sure that sound from a speaker does not enter the microphone you are using. This will have the same effect as if several voices were input to the unit.
- * A unidirectional microphone is recommended for use. It is also recommended that the person should speak standing as close to the microphone as possible.

Parameter (full name)	Setting	Function
VT (Voice Transformer): Creates various voice characters.		
VoiceTms (Switch)	On, Off	Turns Vocal the transformer on or off.
Robot (Robot)	On, Off	When this is on, the audio will be output at a fixed pitch regardless of the pitch that is input.
C.Pitch (Chromatic Pitch)	-12- +36	Sets the pitch variation of the voice to be output (by semitone).
F.Pitch (Fine Pitch)	-100-100	Sets the pitch variation of the voice to be output (by cent).
C.Formant (Chromatic Formant)	-12- +12	Sets the formant variation of the voice to be output (by semitone).
F.Formant (Fine Formant)	-100- +100	Sets the formant variation of the voice to be output (by cent).
MixBal (Mix Balance)	0-100	Sets the volume balance between the output voice and the input voice.

REV (Reverb): Adds reverberation.		
Reverb (Switch)	On, Off	Turns the reverb on or off.
Time (Reverb Time)	0.1-32.0 sec	Sets the length (time) of the reverb sound.
PreDLY (Pre-Delay)	0-200 ms	Sets the time until the reverberation appears.
Density (Density)	0-100	Sets the density of the reverb sound.
RevLevel (Effect Level).	0-100	Sets the volume of the reverb sound.

Algorithm List

Vocoder 2 (19)

This is a 19-band vocoder. Provides clear sounds that used to be impossible with the previous vocoders.

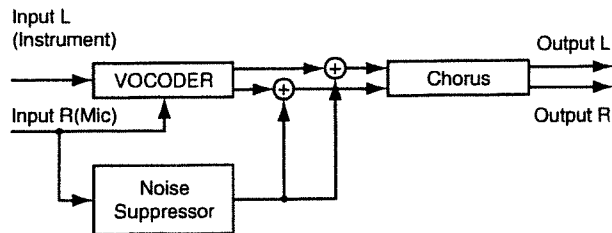

NOTE

- Instrumental sounds are input into the L channel side of Effect. Therefore, it is required to insert-connect "Lch" of Effect to the channel handling instrumental sounds. Similarly, vocal sounds are input into the R channel side of Effect. Insert-connect "Rch" of Effect to the channel handling vocal sounds.

Difference between Vocoder and Vocoder 2

Compared to Vocoder, Vocoder 2 has a significant number of frequency bands as points. It also makes it possible to make fine adjustment including adjustment of the input sensitivity of the microphone and location of sounds as well as setting the input level for instrumental sounds and removing noise. All this yields clear human voices.

"Envelope" for defining sound characteristics

Each sound has its own envelope. An envelope gives characteristics to the sound and functions as a significant factor for the human ear to distinguish different sound types. On Vocoder 2, you can use Envelope to give the following characteristics.

Sharp:	Enhances human voice.
Soft:	Enhances instrumental sound.
Long:	Vintage sound with long reverberation.

Sound location

Pan Mode (PanMode) can be used to specify how Vocoder sounds should be located.

Mono:	Locating in the middle.
Stereo:	Stereo (Odd-number frequencies are located to the left and even-number frequencies to the right.)

Sounding instrumental sounds with the formant fixed

While inputting voice through the microphone, instrumental sounds can be sounded at the same vocal formant. For example, when saying "a-i-u-e-o" into the microphone, set "Hold" On at the moment the speaker is on the "i" sound to issue an instrumental sound with the formant of the "i" sound.

Parameter (full name)	Setting	Function
VOC2 (Vocoder):		
The pitch is specified as in the instrumental sound while the tone is output in the human voice.		
Env (Envelope)	Sharp, Soft, Long	Defines characteristics of the sound.
Pan (Pan Mode)	Mono, Stereo	Defines how the sound is located.
Hold (Hold)	Off, MIDI	Specifies that an instrumental sound is or is not issued with the formant fixed.
MicSens (Microphone Sensitivity)	0–100	Sets the input sensitivity of the microphone.
SynInLev (Synthesizer In Level)	0–100	Sets the input level of the instrumental sound.
V.Char 1 - 19 (Voice Character Channels 1 - 19)	0–100	Sets the tone of the vocoder.
MHPF (Microphone HPF)	Thru, 1.0–20.0 kHz	Sets the frequency at which HPF on the vocal sounds through the microphone starts taking effect. Sets this to "Thru" if HPF is not desired.
MHPFPan (Microphone Pan)	L63–R63	Sets the panning of vocal sounds through the microphone.
MicMix (Microphone Mix)	0–100	Sets the amount of the sound after passing through the microphone HPF should be mixed into the Vocoder output.
NSThresh (Noise Suppressor Threshold)	0–100	Sets the volume to start muting noise on the instrumental sound input.
CHO (Chorus):		
Adds spaciousness and depth to the sound.		
Chorus (Switch)	On, Off	Turns the chorus on or off.
Rate (Rate)	0.1–10.0 Hz	Sets the rate of modulation.
Depth (Depth)	0–100	Sets the depth of modulation.
PreDLY (Pre-Delay)	0–50 ms	Sets the time delay from when the direct sound begins until the chorus sound is heard.
MixBal (Mix Balance)	0–100	Sets the volume balance between the chorus sound and the direct sound.

MicSimulator (Microphone Simulator)

This modifies sound that was recorded by a conventional dynamic mic, lapel mic or direct line, causing it to sound as though it had been recorded by an expensive condenser mic or a special studio mic. The mic simulator can add effects of proximity or distance.

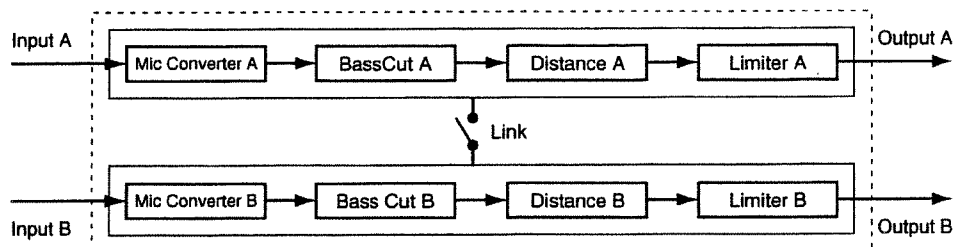

Selecting the microphone used for recording.

Input of Mic Converter selects the type of microphone to be used recording.

DR-20:	Roland DR-20 (dynamic microphone from Roland)
SmlDy:	Small Dynamic Microphone (dynamic microphone used for instruments and vocal)
HedDy:	Head-worn Dynamic Microphone (headset-type dynamic microphone)
MinCn:	Miniature Condenser Microphone (very small condenser microphone)
Flat:	Line input

Microphone types that can be simulated

The characteristics of the low-end general-purpose microphone are converted into the characteristics of the high-end microphone for studio application. You can add sound quality changes to already recorded sounds just as if a different type of microphone were used or if they were recorded at a different distance. In addition, it is possible to add microphone characteristics to line-recorded instrumental sounds. These characteristics can be set up by selecting the relevant value for Out of Mic Converter.

SmlDy:	Dynamic microphone for general musical instruments and vocal sounds. Ideal for a guitar amplifier and snare drums.
VocDy:	Dynamic microphone for standard vocal sounds. Characterized in middle frequency band sounds with tension. Suited for vocal.
LrgDy:	Dynamic microphone with a extended low frequency band. For bass and tom drums.
SmlCn:	Small condenser microphone for musical instruments. Characterized in bright high frequency band sounds. For metal percussion and acoustic guitars.
LrgCn:	Condenser microphone with flat characteristics. For vocal, narration and live musical instruments.
VntCn:	Vintage condenser microphone. For vocal and live musical instruments.
Flat:	Microphone with flat frequency response. For removing peculiarity of the microphone used for recording sounds.

* When a condenser-type mic is selected in OUT, low-range noise transmitted through the mic stand may be accentuated due to the mic's low range characteristics. In such instances, either cut out any unnecessary low end with bass cut filter, or equip the mic stand with an isolation mount (a mic holder with rubber or other shock absorbing material).

Proximity effect of microphone

In nature, a microphone tends to extend the low frequency band characteristics when placed close to the sound source. This is called proximity effect. This effect can be simulated in Proximity Effect (Prox-Efect). Set the parameter to a positive (+) value for a shorter distance to the sound source and a negative (-) value for a longer distance to the sound source. Time of Distance simulates the time difference due to distance from the sound source.

Controlling Channels A and B separately

Setting Link On enables simultaneous control on the 4-Band Parametric Equalizer via Channel B according to the settings on the Channel A side. To control Channels A and B separately, turn Link Off.

Parameter (full name)	Setting	Function
LNK (Link): Channel B follows the settings for Channel A.		
Link (Link Switch)	On, Off	Specifies if Channel B follows or does not follow the settings for Channel A.
MCA, MCB(Mic Converter): Converts the characteristics of the low-end general-purpose microphone into the characteristics of the high-end microphone for studio application.		
MicConv (Switch)	On, Off	Turns the microphone converter on or off.
Input (Input)	See the column on the previous page.	Sets the microphone type used for recording.
Out (Output)	See the column on the previous page.	Sets the microphone types to be simulated.
Phase (Phase)	Normal, Invers	Sets the microphone phase.
BCA, BCB (Bass Cut Filter): Cuts off undesired low frequency band sounds such as pop noise.		
BassCut (Switch)	On, Off	Turns the bass cut filter on or off.
Freq (Frequency)	Thru, 20 - 2000 Hz	Sets the frequency for cutting off undesired low frequency band sounds such as pop noise.
DSA, DSB (Distance): Simulates the frequency characteristics and time difference due to distance difference.		
Distance (Switch)	On, Off	Turns the distance on or off.
Prox.Fx (Proximity Effect)	-12- +12	Corrects the low frequency band characteristics due to the distance from the sound source.
Time (Time)	0-3000 cm	Simulates the time difference due to the distance from the sound source.
LMA, LMB (Limiter): Prevents distortion by suppressing signals at high levels.		
Limiter (Switch)	On, Off	Turns the limiter on or off.
Thresh (Threshold)	-60-0 dB	Sets the volume level to start suppressing excessive input.
Attack (Attack Time)	0-100	Sets the time from when the input level exceeds the threshold level to when the effect begins to apply.
Release (Release Time)	0-100	Sets the time from when the input level drops below the threshold level to when the effect ceases to apply.
Freq (Detect HPF Frequency)	Thru, 20 - 2000 Hz	Normally, sets "Thru". Sets the cutoff frequency of the level detection section.
Output Level (Output Level)	-60- +24 dB	Sets the volume of the compressor sound.

3BndIsolater (3-Band Isolator)

Sharply cuts off components by frequency band to eliminate undesired sounds. Useful to eliminate undesired sounds and take out only specific sounds from a CD. Isolator can make sounds completely perish, unlike ordinary equalizers that leave some sounds even with the gains of the respective frequency bands set to the minimum.

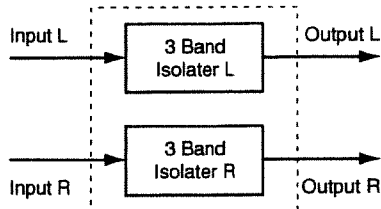

Muting the bass

Set up as follows to eliminate low frequency band sounds such as bass sounds.

Anti-phase Low Mix Switch (APLMixSw): On
 Anti-phase Low Level (APLLev): Relatively high

Muting vocals

Set up as follows to eliminate middle frequency band sounds such as vocal sounds.

Anti-phase Middle Mix Switch (APMMixSw): On
 Anti-phase Middle Level (APMLev): Relatively high

Muting noise

Identify the frequency band of the noise and set the relevant Level (Lo Level, Mid Level or Hi Level) to -60 dB.

Parameter (full name)	Setting	Function
ISO (3-band Isolator):	Divides the input sound into three frequency bands to abstract or eliminate the sound.	
Isolater (Switch)	On, Off	Turns the 3-band isolator on or off.
HiLvl (High Level)	-60- +4 dB	Increases or decreases frequency bands in the high frequency band.
MidLvl (Middle Level)	-60- +4 dB	Increases or decreases frequency bands in the middle frequency band.
LowLvl (Low Level)	-60- +4 dB	Increases or decreases frequency bands in the low frequency band.
APMMixSw (Anti-phase Middle Mix Switch)	On, Off	Mutes or leaves the middle frequency band sound.
APMLev (Anti-phase Middle Level)	0-100	Sets how much of the middle frequency band sound should be muted.
APLMixSw (Anti-phase Low Mix Switch)	On, Off	Mutes or leaves the low frequency band sound.
APLLev (Anti-phase Low Level)	0-100	Sets the amount of the low frequency band sound should be muted.

TapeEcho201

Simulates the tape echo section of the Roland RE-201 Space Echo. Capable of reproducing very subtle behavior at the measuring instrument level as well as adding subtle changes in pitch due to deterioration of the tape or inconsistency in tape rotation



About replay head

RE-201 is equipped with three heads for creating sounds with different delay times (short, middle and long delay sounds). A desired combination of heads for use can be selected with Mode Selector (Mode). In addition, separate panning features for the three replay heads not included in RE-201 are added.

Parameter (full name)	Setting	Function
Tape Echo 201: Simulates the tape echo section of the Roland RE-201 Space Echo.		
SpaceEcho (Switch)	On, Off	Turns the tape echo on or off.
ModeSelect (Mode Selector)	1-7	Selects a combination of the three replay heads.
RepRate (Repeat Rate)	0-100	Sets the tape speed.
Intensity (Intensity)	0-100	Sets the number of repeated the delay sound.
EhoVol (Eho Volume).	0-100	Sets the volume of the tape echo sound.
DirectVol(Direct Volume)	0-100	Sets the volume of the direct sound.
Bass (Tone Bass)	-100- +100	Sets the low frequency band tone of the tape echo sound.
Treble (Tone Treble)	-100- +100	Sets the high frequency band tone of Tape Echo sound.
HeadS Pan (Pan Head S)	L63-R63	Sets the pan settings for the short delay playback head.
HeadM Pan (Pan Head M)	L63-R63	Sets the pan settings for the middle delay playback head.
HeadL Pan (Pan Head L)	L63-R63	Sets the pan settings for the long delay playback head.
TapeDist (Tape Distortion)	0-100	Adds tape-specific distortion.
WahRate (Wah-Flutter Rate)	0-100	Sets the fluttering rate of pitch due to deterioration of the tape or inconsistency in the rotation.
WahDepth (Wah-Flutter Depth)	0-100	Sets the fluttering depth of pitch due to deterioration of the tape or inconsistency in the rotation.

AnalogFinger (Analog Flanger)

Simulates Roland SBF-325 Analog Flanger. Provides three types of flanger effects as well as chorus-like effect.

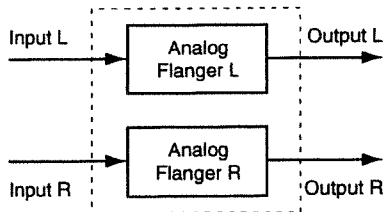

Types of Flanger Effect

Analog Flanger provides a variety of flanger effects or chorus effects. Selecting the desired flanger effect type in Mode.

- FL1: General monaural flanger
- FL2: Stereo flanger that allows stereo location of the direct sound to take effect.
- FL3: Cross mix flanger that provides more powerful effect
- CHO: Chorus effect

Parameter (full name)	Setting	Function
AFL (Analog Flanger): Simulates SBF-325 Analog Flanger.		
Flanger (Switch)	On, Off	Turns the analog flanger on or off.
Mode (Mode)	FL1, FL2, FL3, CHO	Sets the type of flanger effects.
Feedback (Feedback Level)	0-100	Sets the amount of the delayed sound should be returned to the flanger input. *1, *2
Rate (Modulation Rate)	0-100	Sets the flanger's modulation rate.
Depth (Modulation Depth)	0-100	Sets the depth of the flanger modulation.
Freq (Modulation Frequency)	0-100	Sets the center frequency subject to application of the flanger effect.
ChB Mod (Channel B Inverse)	On, Off	"On" indicates that the Flanger effect on Channel B should be inverted. "Off" indicates that it should not be inverted.
ChA Phs (Mix A Inverse)	On, Off	"On" indicates that the phase should be inverted for mixing Channel A Flanger sound into the direct sound. "Off" indicates that the phase should not be inverted.
ChB Phs (Mix B Inverse)	On, Off	"On" indicates that the phase should be inverted for mixing Channel B Flanger sound into the direct sound. "Off" indicates that the phase should not be inverted.



*1: This feature is disabled when Mode is set to "CHO."

*2: Excessively large values may cause oscillation.

AnalogPhaser

Two units of analog phasers are placed in parallel to accommodate stereo sounds. Surges unique to Phaser is created by adding sounds with the phase shifted periodically.

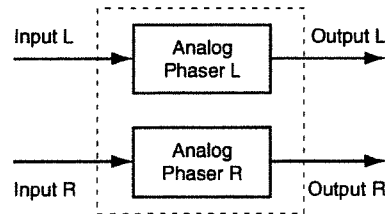

Number of stages of Phaser

As the number of stages of Phaser increases, the number of frequency points suppressed increases as well, generating sharper effect.

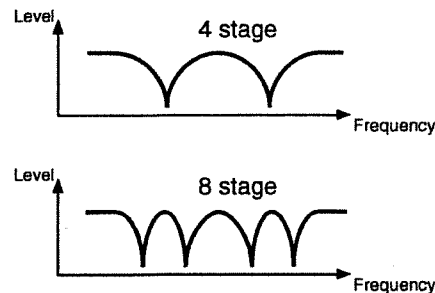

Parameter (full name)	Setting	Function
-----------------------	---------	----------

APH (Analog Phaser): Two units of analog phaser are placed in parallel to accommodate stereo sounds.

Parameter (full name)	Setting	Function
Phaser (Switch)	On, Off	Turns the analog phaser on or off.
Mode (Mode)	8STAGE, 4STAGE	Sets the number of stages of phaser.
Freq (Frequency)	0-100	Sets the center frequency to which the phase effect is applied.
Reso (Resonance)	0-100	Enhances frequency components at around the center frequency set with Frequency.
LFO1/2 Rate (LFO1/2 Rate)	0-100	Sets the phase effect cycle length.
LFO1/2 Dep (LFO1/2 Depth)	0-100	Sets the depth of the phase effect cycle.
LFO1/2 BMode (LFO1/2 Channel B Inverse)	On, Off	"On" indicates that the surge phase should be inverted and "Off" indicates that it should not be inverted.

Algorithm List

Speaker Modeling

Models a variety of speaker characteristics ranging from those of high-end professional monitor speakers used as the standard at studios around the world to those of speakers of small-sized TV sets and portable radios.

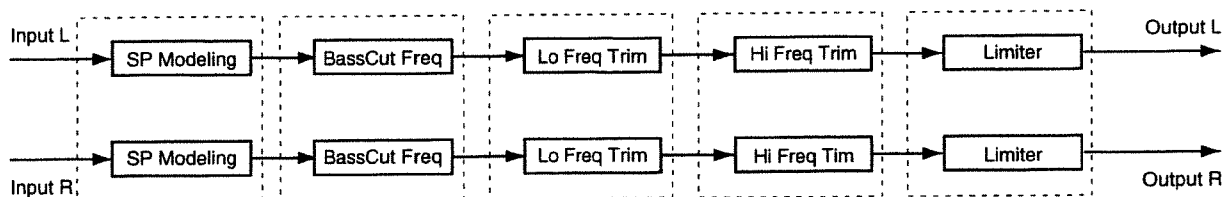

Speaker Modeling is adjusted so that its optimal effect is achieved when a Roland Powered Monitor DS-90A is used in digital connection. Its effect may not be fully achieved with other types of speakers.

Speaker types applicable for modeling

The characteristics of the following types of speakers can be modeled. Set the desired type for Model.

THRU:	No modeling is to be performed.
FLAT:	DS-90A is corrected by modeling to produce wider-range and untwisted sounds.
Pwd.BLK:	Typical model of powered monitor (two-way type, the woofer diameter = 170 mm (6-1/2 inches))
Pwd.E-B:	Powered monitor characterized in delightful sound quality
Pwd.MAC:	Powered monitor characterized in well-extended low frequency band sounds
SmlCUBE:	Small-sized full-range speaker widely used in recording studios
Wh.CONE:	Enclosed-type two-way speaker widely used in recording studios, characterized in white woofers.
WhTISUE:	Mild sounds from "White Cone" Tweeter covered with tissue paper
RADIO:	Pocket-type small-sized radio
SmlTV:	Speaker attached to the 14-inch TV set
BoomBox:	Radio cassette recorder
BoomLoB:	Radio cassette recorder with the low frequency band enhanced

* Use "THRU" for clear comparison between sounds with and without modeling.

Parameter (full name)	Setting	Function
SPM (Speaker Modeling): Selects the speaker subject to characteristics modeling.		
Modeling (Modeling)	Off, On	Turns the Speaker Modeling on or off.
Mdl (Model)	See the column on the previous page.	Specifies the speaker actually generating sounds.
Phase (Phase)	Nor, Inv	Sets the phase of the speaker. "Nor" for the same phase, and "Inv" for the inverted phase.
BC (Bass Cut Filter): Cuts off undesired low sounds such as pop noise.		
BassCut (Switch)	On, Off	Turns the bass cut filter on or off.
Freq (Frequency)	Thru, 20 - 2000 Hz	Sets the frequency for cutting off undesired low frequency band sounds such as pop noise.
LFT (Low Frequency Trimmer): Adjusts the low frequency band sounds.		
L.F.Trim (Switch)	On, Off	Turns the low frequency trimmer on or off.
Gain (Gain)	-12- +12dB	Sets the boost/cut amount.
Freq (Frequency)	20-2000 Hz	Sets the center frequency of the trimmer.
HFT (High Frequency Trimmer): Adjusts the high frequency band sounds.		
H.F.Trim (Switch)	On, Off	Turns the high frequency trimmer on or off.
Gain (Gain)	-12- +12dB	Sets the boost/cut amount.
Freq (Frequency)	1.0-20.0 kHz	Sets the center frequency.
LMT (Limiter): Prevents distortion by suppressing signals at high levels.		
Limiter (Switch)	On, Off	Turns the limiter on or off.
Thres (Threshold)	-60-0 dB	Sets the volume at which the limiter starts working.
Rel (Release)	0-100	Sets the time from when the input level drops below the threshold level to when the effect ceases to apply.
Level (Level)	-60- +24 dB	Sets the volume after passing through the limiter.

Algorithm List

Mastering Tool Kit

This Kit is a compressor that splits sounds into different frequency band to unify their volumes. With this feature, you can perform mastering at the optimized level when mixing down into an MD or a CD or when producing your original audio CD using the CD-R disk.

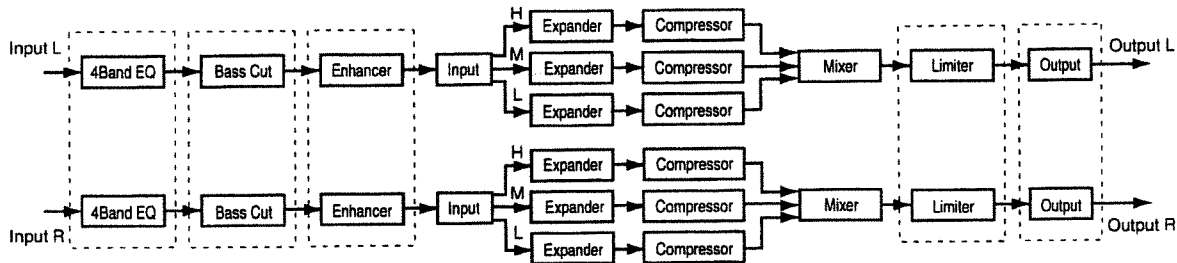

Effect of "Detect Time" under Input

With ordinary compressors, a moment of delay occurs to suppress a level over instance after it has been detected. With this algorithm, this problem is bypassed by using the input sound only for level detection and adding a specified length of delay to the sound for processing and output. "Detect Time" under Input is the setting of the delay time for this purpose. Note that supplying Detect Time causes time difference between input and output of audio signals, requiring due considerations if used for operations other than mastering (ex. channel insertion).

Splitting into frequency bands

To split into high, middle and low frequency bands, Low Split Point (LSP) and High Split Point (HSP) under Input are used to specify frequencies.

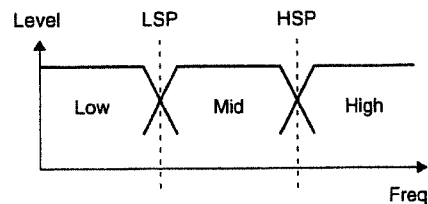

Parameter (full name)	Setting	Function
EQ (Equalizer)		
EQ (Switch)	On, Off	Turns the equalizer on or off.
InputG (Input Gain)	-24- +12 dB	Sets the overall volume before passing through the equalizer.
LowType (Low Type)	Shlv, Peak	Sets the type of the low frequency band equalizer (Shlving type or peaking type).
LowG (Low Gain)	-12- +12 dB	Sets the boost/cut amount in the low frequency band.
LowF (Low Frequency)	20-2000 Hz	Sets the center frequency in the low frequency band.
LowQ (Low Q)	0.3-16.0	Sets the width of the area around the low frequency that will be affected by the gain settings. *1
LoMidG (Low Middle Gain)	-12- +12 dB	Sets the boost/cut amount in the low middle frequency band.
LoMidF (Low Middle Frequency)	20-8000 Hz	Sets the center frequency in the low middle frequency band.
LoMidQ (Low Middle Q)	0.3-16.0	Sets the width of the area around the low middle frequency that will be affected by the gain settings.
HiMidG (High Middle Gain)	-12- +12 dB	Sets the boost/cut amount in the high frequency band.
HiMidF (High Middle Frequency)	20-8000 Hz	Sets the center frequency in the high middle frequency band.
HiMidQ (High Middle Q)	0.3-16.0	Sets the width of the area around the high middle frequency that will be affected by the gain settings.
HiType (High Type)	Shlv, Peak	Sets the type of the high frequency band equalizer (Shlving

		type or peaking type).
HiG (High Gain)	-12– +12 dB	Sets the boost/cut amount in the high frequency band.
HiF (High Frequency)	1.40–20.0 kHz	Sets the center frequency in the high frequency band.
HiQ (High Q)	0.3–16.0	Sets the width of the area around the high frequency that will be affected by the gain settings. *1
Level (Level)	-24– +12 dB	Sets the overall volume after passing through the equalizer.

BC (Bass Cut Filter): **Cuts off undesired low frequency band sounds such as pop noise.**

BassCut (Switch)	On, Off	Turns the bass cut filter on or off.
Freq (Frequency)	Thru, 20 - 2000 Hz	Sets the frequency for cutting off undesired low frequency band sounds such as pop noise.

ENH (Enhancer): **Accentuates the sound and push the sound forward.**

Enhancer (Switch)	On, Off	Turns the enhancer on or off.
Sens (Sensitivity)	0–100	Sets the degree of the enhancer effect desired.
Freq (Frequency)	1.00–10.0 kHz	Sets the frequency at which the enhancer effect starts working.
MixLvl (Mix Level)	-24– +12dB	Set the amount of the enhancer sound to be added to the direct sound.

IN (Input): **Splits the direct sound into three frequency bands, that is, low, middle and high frequency bands.**

Gain (Input Gain)	-24– +12dB	Sets the overall volume before entering expander/compressor.
D-Time (Detect Time)	0–10 ms	Sets the length of delay to add to the direct sound input.
LSP (Low Split Point)	20–800 Hz	Sets the frequency at which the direct sound is split into three bands (on the low frequency band side).
HSP (High Split Point)	1.60–16.0 kHz	Sets the frequency at which the direct sound is split into three bands (on the high frequency band side).

EXP (Expander): **Expands the dynamic range at a certain ratio.**

Expander (Switch)	On, Off	Turns the expander on or off.
L.Thre (Low Threshold)	-80–0 dB	Sets the volume at which the expander for the low frequency band starts working.
LRatio (Low Ratio)	1:1.0–1:16, 1:INF	Sets the ratio at which the output in the low frequency band is increased when the input level has dropped below the low threshold level.
L.Atck (Low Attack)	0–100 ms	Sets the time until when the low frequency band expander starts working after the input level drops below the low threshold level.
L.Rel (Low Release)	50 ms–5.00 s	Sets the time until when the high frequency band expander stops working after the input level exceeds the low threshold level.
M.Thre (High Threshold)	-80–0 dB	Sets the volume at which the expander for the middle frequency band starts working.
M.Ratio (High Ratio)	1:1.0–1:16, 1:INF	Sets the ratio at which the output in the middle frequency band is increased when the input level has dropped below the middle threshold level.
M.Atck (High Attack)	0–100 ms	Sets the time until when the middle frequency band expander starts working after the input level drops below the middle threshold level.
M.Rel (High Release)	50 ms–5.00 s	Sets the time until when the middle frequency band expander stops working after the input level exceeds the middle threshold level.
H.Thre (High Threshold)	-80–0 dB	Sets the volume at which the expander for the high frequency band starts working.
H.Ratio (High Ratio)	1:1.0–1:16, 1:INF	Sets the ratio at which the output in the high frequency band is increased when the input level has dropped below the high threshold level.
H.Atck (High Attack)	0–100 ms	Sets the time until when the high frequency band expander starts working after the input level drops below the high threshold level.

➔ Continued...

Algorithm List

H.Rel (High Release)	50 ms–5.00 s	Sets the time until when the high frequency band expander stops working after the input level exceeds the high threshold level.
----------------------	--------------	---

CMP (Compressor): Compresses the entire output signals when the input volume exceeds a specified value.

Comp (Switch)	On, Off	Turns the compressor on or off.
L.Thre (Low Threshold)	-24–0 dB	Sets the volume at which the compressor for the low frequency band starts working.
LRatio (Low Ratio)	1:1.0–1:16, 1:INF	Sets the ratio at which the output in the low frequency band is suppressed when the input level has exceeded the low threshold level.
L.Atck (Low Attack)	0–100 ms	Sets the time until when the low frequency band compressor starts working after the input level has exceeded the low threshold level.
L.Rel (Low Release)	50 ms–5.00 s	Sets the time until when the low frequency band compressor stops working after the input level has dropped below the low threshold level.
M.Thre (Middle Threshold)	-24–0 dB	Sets the volume at which the compressor in the middle frequency band starts working.
MRatio (Middle Ratio)	1:1.0–1:16, 1:INF	Sets the ratio at which the output in the middle frequency band is suppressed when the input level has exceeded the middle threshold level.
M.Atck (Middle Attack)	0–100 ms	Sets the time until when the middle frequency band compressor starts working after the input level has exceeded the middle threshold level.
M.Rel (Middle Release)	50 ms–5.00 s	Sets the time until when the middle frequency band compressor stops working after the input level has dropped below the middle threshold level.
H.Thre (High Threshold)	-24–0 dB	Sets the volume at which the compressor for the high frequency band starts working.
HRatio (High Ratio)	1:1.0–1:16, 1:INF	Sets the ratio at which the output in the high frequency band is suppressed when the input level has exceeded the high threshold level.
H.Atck (High Attack)	0–100 ms	Sets the time until when the high frequency band compressor starts working after the input level has exceeded the high threshold level.
H.Rel (High Release)	50 ms–5.00 s	Sets the time until when the high frequency band compressor stops working after the input level has dropped below the high threshold level.

MIX (Mixer): Adjusts the volume by frequency band.

LowLvl (Low Level)	-80– +6 dB	Sets the volume in the low frequency band after passing through the expander and compressor.
MidLvl (Middle Level)	-80– +6 dB	Sets the middle frequency band volume after passing through the expander and compressor.
HiLvl (High Level)	-80– +6 dB	Sets the volume in the high frequency band after passing through the expander and compressor.

LMT (Limiter): Prevents distortion by suppressing signals at high levels.

Limiter (Switch)	On, Off	Turns the limiter on or off.
Thre (Threshold)	-24–0 dB	Sets the volume at which the limiter starts working.
Atck (Attack)	0–100 ms	Sets the time until when the limiter starts working after the input level has exceeded threshold level.
Rel (Release)	50 ms–5.00 s	Sets the time until when the limiter stops working after the input level drops below the threshold level.

Output Level: Provides settings concerning overall output.

SoftClip (Soft Clip)	On, Off	Suppresses conspicuous distortion that may occur when the effect of compressor/limiter has been applied excessively.
Dither (Dither)	Off, 8–24 bit	Smooths the transition where the sound disappears.
Level (Level)	-80– +6 dB	Sets the overall volume after passing through the limiter.



With Compressor, the level is automatically adjusted to the optimal with the settings for Threshold (Thres) and Ratio (Ratio). Setting Attack (Atck) to a relatively long time may cause distortion. For this reason, a margin of -6 dB is provided. Adjust the Mixer (Mix) level as required.

*1: If Low Type (LowType) or High Type (Hi Type) is set to "Shlv (Shlving Type)," the setting for LowQ or High Q is invalid.

MIDI Implementation

Model VS-890 Version 1.00 Mar. 09 2000

1. TRANSMITTED DATA AND RECOGNIZED RECEIVE DATA

■ Channel Voice Message

● Note On/Off

Transmit the message which specified MIDI channel as a Metronome when "Metronome Out Mode(*1)" in the SYSTEM parameter is "MIDI." Receive the message when Voice Transformer effect (algorithm 27) is selected and MIDI Control SW is On.

Status	Second	Third
9nH	mmH	lH
n = MIDI Channel No.:	0H - FH (ch.1 - ch.16) (*2)	
	0H - 1H (ch.1 - ch.2) (*3)	
mm = Note No.:	00H - 7FH (0 - 127) (*3)	
l = Velocity:	01H - 7FH (1 - 127) / 00H = NOTE OFF	

- (*1) see "2. Address Map for Data Transfer" section.
- (*2) Only when transmitting Metronome.
- (*3) Only when receiving with MIDI Control SW of Voice Transformer is On.

n = 0 (ch.1): Voice Transformer : Chromatic Pitch
 mm = 24H - 54H (C2 - C6)
 l = ignored

n = 1 (ch.2): Voice Transformer : Chromatic Formant
 mm = 24H - 3CH (C2 - C4)
 l = ignored

● Polyphonic Key Pressure

Transmits the level meter value of VS-890 according to the value of "Level Meter Tx. via MIDI." (see "2. Data Transfer Address Map") (MIDI ch. is fixed to 16.) Ignored when received.
 When VS-890 is booted up, "Level Meter Tx. via MIDI" is set to Off. Level meter value is not transmitted until it is set to On with Data Set (DT1).

Status	Second	Third
AFH	mmH	lH
mm = Note No.:	00H - 27H (0 - 39) (*1)	
l = Level Meter Value:	00H - 10H (0 - 16) (*2)	

Level Meter and Note No. (*1)

Level Meter Ch.	Note No.	Level Meter Ch.	Note No.
TRACK MIX CH. 1	0	INPUT MIX CH. 1	16
TRACK MIX CH. 2	1	INPUT MIX CH. 2	17
TRACK MIX CH. 3	2	INPUT MIX CH. 3	18
TRACK MIX CH. 4	3	INPUT MIX CH. 4	19
TRACK MIX CH. 5	4	INPUT MIX CH. 5	20
TRACK MIX CH. 6	5	INPUT MIX CH. 6	21
TRACK MIX CH. 7	6	INPUT MIX CH. 7	22
TRACK MIX CH. 8	7	INPUT MIX CH. 8	23
AUX BUS Lch	34		
AUX BUS Rch	35		
MASTER Lch	3F		
MASTER Rch	39		

Level Meter Value and Level (*2)

Val	Level	Val	Level	Val	Level	Val	Level
0	infinity	4	-28.0dB	8	-15.0dB	12	-6.0dB
1	-46.0dB	5	-24.0dB	9	-12.0dB	13	-4.0dB
2	-36.0dB	6	-21.0dB	10	-10.0dB	14	-3.0dB
3	-32.0dB	7	-18.0dB	11	-8.0dB	15	-2.0dB

● Control Change

Parameter on the Mixer section can be controlled and transmitted by the control change messages when "MIDI Mixer Control Type (*1)" in the SYSTEM parameter is "C.C." Transmitted data of the level meter parameters respond to the setting of the "Level Meter Tx. via MIDI (*1)".

Status	Second	Third
BnH	mmH	lH
n = MIDI Channel No.:	0H - FH (ch.1 - ch.16 : see the followings)	
mm = Mixer parameter No.:	see the followings	
l = Mixer parameter value:	00H - 7FH (0 - 127) (*1)	

MIDI channels and Control Change No. for Mixer parameters

```
<Channel Strip>
TRACK MIX CH.      1  2  3  4  5  6  7  8
MIDI ch. --       1  2  3  4  5  6  7  8
-----
TRACK STATUS(*3)  3  --> --> --> --> --> -->
MIX Send Level    7  --> --> --> --> --> -->
MIX Send Pan      10 --> --> --> --> --> -->
EQ L Freq.        12 --> --> --> --> --> -->
EQ L Gain         13 --> --> --> --> --> -->
EQ M Freq.        14 --> --> --> --> --> -->
EQ M Gain         15 --> --> --> --> --> -->
EQ M Q           16 --> --> --> --> --> -->
EQ H Freq.        17 --> --> --> --> --> -->
EQ H Gain         18 --> --> --> --> --> -->
FX1 SND Level     19 --> --> --> --> --> -->
FX1 SND Pan/Bal  20 --> --> --> --> --> -->
FX2 SND Level     21 --> --> --> --> --> -->
FX2 SND Pan/Bal  22 --> --> --> --> --> -->
AUX Send Level    23 --> --> --> --> --> -->
AUX Send Pan/Bal  24 --> --> --> --> --> -->
MIX Offset Level  29 --> --> --> --> --> -->
MIX Offset Bal   30 --> --> --> --> --> -->
```

```
INPUT MIX CH.     1  2  3  4  5  6  7  8
MIDI ch. --       1  2  3  4  5  6  7  8
-----
MIX Send Level    68 --> --> --> --> --> -->
MIX Send Pan/Bal  70 --> --> --> --> --> -->
EQ L Freq.        71 --> --> --> --> --> -->
EQ L Gain         72 --> --> --> --> --> -->
EQ M Freq.        73 --> --> --> --> --> -->
EQ M Gain         74 --> --> --> --> --> -->
EQ M Q           75 --> --> --> --> --> -->
EQ H Freq.        76 --> --> --> --> --> -->
EQ H Gain         77 --> --> --> --> --> -->
FX1 SND Level     78 --> --> --> --> --> -->
FX1 SND Pan/Bal  79 --> --> --> --> --> -->
FX2 SND Level     80 --> --> --> --> --> -->
FX2 SND Pan/Bal  81 --> --> --> --> --> -->
AUX Send Level    82 --> --> --> --> --> -->
AUX Send Pan/Bal  83 --> --> --> --> --> -->
MIX Offset Level  88 --> --> --> --> --> -->
MIX Offset Bal   89 --> --> --> --> --> -->
```

stereo in & effect return

	ST	IN	FX1	FX2
MIDI ch. -->	11	12	13	
MIX Send Level	68	-->	-->	
MIX Send Balance	70	-->	-->	

<MASTER Block> MIDI ch.=16

Master Level	68
Master Balance	70
FX1 SND Level	78
FX1 SND Balance	79
FX2 SND Level	80
FX2 SND Balance	81
AUX Level	82
AUX Balance	83

- (*1) see "2. Address Map for Data Transfer" section.
- (*2) Mixer parameters of the paired channels (Channel Link is "On") is only transmitted by odd number MIDI channel.
- (*4) Track status switches corresponding to the value as follows.

(1) While VS-890 stops

MIDI Implementation

MIDI Implementation

Value: 0-31 32-63 64-95 96-127
 Status: MUTE ->MUTE MUTE ->PLAY MUTE ->REC MUTE ->SOURCE
 PLAY ->MUTE PLAY ->PLAY PLAY ->REC PLAY ->SOURCE
 REC ->MUTE REC ->PLAY REC ->REC REC ->SOURCE
 SOURCE->MUTE SOURCE->PLAY SOURCE->REC SOURCE->SOURCE

(2) While playing/ recording

Value: 0-31 32-63 64-95 96-127
 Status: MUTE -> X MUTE ->PLAY MUTE -> X MUTE -> X
 PLAY ->MUTE PLAY ->PLAY PLAY -> X PLAY -> X
 REC -> X REC -> X REC ->REC REC ->SOURCE(*)
 SOURCE->MUTE SOURCE-> X SOURCE->REC(*) SOURCE->SOURCE

(*) Impossible to switch while recording.
 (*) X = ignored

Bank select (MSB/LSB)

Switch the effect bank of Preset/ User.
 VS-890 never transmits this message.

Status Second Third
 BnH 00H mmH
 BnH 20H llH

n = MIDI Channel Number: 0H - 1H (0 - 1) 0 = FX1, 1 = FX2
 num = upper byte of bank number: 00H
 ll = lower byte of bank number: 00H - 03H (0 - 3)

Bank Select MSB LSB	Program Change	Patch Number
00H 00H	00H - 63H (0 - 99)	Preset A #0 - #99
00H 01H	00H - 63H (0 - 99)	Preset B #0 - #99
00H 02H	00H - 63H (0 - 99)	User U #0 - #99
00H 03H	00H - 09H (0 - 09)	Preset C #0 - #09

NRPN(MSB/LSB)

Select a parameter of the effect to be controlled.
 VS-890 never transmits this message.

Status Second Third
 BnH 62H llH
 BnH 63H mmH

n = MIDI Channel Number: 0H - 1H (0 - 1) 0 = FX1, 1 = FX2
 mm = upper byte of parameter number to be assigned with NRPN: 00H
 ll = lower byte of parameter number to be assigned with NRPN: 00H - 2EH (0-46)

Data Entry (MSB/LSB)

Control effect parameter assigned with NRPN.
 VS-890 never transmits this message.

Status Second Third
 BnH 06H mmH
 BnH 26H llH

n = MIDI channel number: 0H - 1H (0 - 1) 0 = FX1, 1 = FX2
 mm = upper byte corresponding to the parameter assigned with NRPN
 ll = lower byte corresponding to the parameter assigned with NRPN

<Ex> mmH llH = 40H 00H = -8192
 = 7FH 7FH = -1
 = 00H 00H = 0
 = 3FH 7FH = +8191

Data Increment

Increment the effect parameter selected with NRPN.
 VS-890 never transmits this message.

Status Second Third
 BnH 60H 00H

n = MIDI channel number: 0H - 1H (0 - 1) 0 = FX1, 1 = FX2

Increment the effect parameter selected with NRPN.

Data Decrement

Decrement the effect parameter selected with NRPN.
 VS-890 never transmits this message.

Status Second Third
 BnH 61H 00H

n = MIDI channel number: 0H - 1H (0 - 1) 0 = FX1, 1 = FX2

Decrement the effect parameter selected with NRPN.

Correspondence table between NRPN and effect parameters

Algorithm 0 Reverb (FX1 Only)

NRPN	Data Entry	
00H 00H	mmH llH	EQ SW 0, 1 = Off, On
00H 01H	mmH llH	EQ: Low EQ Type 0, 1 = Shelving, Peaking
00H 02H	mmH llH	EQ: Low EQ Gain -12...12dB
00H 03H	mmH llH	EQ: Low EQ Frequency 2...200 = 20...2000Hz
00H 04H	mmH llH	EQ: Low EQ Q 3...100 = 0.3...10.0
00H 05H	mmH llH	EQ: Mid EQ Gain -12...12dB
00H 06H	mmH llH	EQ: Mid EQ Frequency 20...800 = 200...8000Hz
00H 07H	mmH llH	EQ: Mid EQ Q 3...100 = 0.3...10.0
00H 08H	mmH llH	EQ: High EQ Type 0, 1 = Shelving, Peaking
00H 09H	mmH llH	EQ: High EQ Gain -12...12dB
00H 0AH	mmH llH	EQ: High EQ Frequency 14...200 = 1.4...20.0kHz
00H 0BH	mmH llH	EQ: High EQ Q 3...100 = 0.3...10.0
00H 0CH	mmH llH	EQ: Out Level 0...100
00H 0DH	mmH llH	Reverb: Room Size 5...40m
00H 0EH	mmH llH	Reverb: Reverb Time 1...320 = 0.1...32.0s
00H 0FH	mmH llH	Reverb: Pre Delay 0...200 = 0...200ms
00H 10H	mmH llH	Reverb: Diffusion 0...100
00H 11H	mmH llH	Reverb: Density 0...100
00H 12H	mmH llH	Reverb: Early Reflection Level 0...100
00H 13H	mmH llH	Reverb: LF Damp Frequency 5...400 = 50...4000Hz
00H 14H	mmH llH	Reverb: LF Damp Gain -36...0dB
00H 15H	mmH llH	Reverb: HF Damp Frequency 10...200 = 1.0...20.0kHz
00H 16H	mmH llH	Reverb: HF Damp Gain -36...0dB
00H 17H	mmH llH	Reverb: HI Cut Frequency 2...200 = 0.2...20.0kHz
00H 18H	mmH llH	Reverb: Effect Level -100...100
00H 19H	mmH llH	Reverb: Direct Level -100...100

00H 1AH	00H 00H	(Reserved)
:	:	:
00H 7FH	00H 00H	

Algorithm 1 Delay

NRFN	Data Entry	Data Entry
00H 00H	mmH 11H	Delay SW 0,1 = Off,On
00H 01H	mmH 11H	EQ SW 0,1 = Off,On
00H 02H	mmH 11H	Delay: Delay Time 0...1200ms
00H 03H	mmH 11H	Delay: Shift -1200...1200 = 11200...11200ms
00H 04H	mmH 11H	Delay: Lch Feedback Level -100...100
00H 05H	mmH 11H	Delay: Rch Feedback Level -100...100
00H 06H	mmH 11H	Delay: Lch Level -100...100
00H 07H	mmH 11H	Delay: Rch Level -100...100
00H 08H	mmH 11H	Delay: LF Damp Frequency 5...400 = 50...4000Hz
00H 09H	mmH 11H	Delay: LF Damp Gain -36...0dB
00H 0AH	mmH 11H	Delay: HF Damp Frequency 10...200 = 1.0...20.0kHz
00H 0BH	mmH 11H	Delay: HF Damp Gain -36...0dB
00H 0CH	mmH 11H	Delay: Direct Level -100...100
00H 0DH	mmH 11H	EQ: Low EQ Type 0,1 = Shelving, Peaking
00H 0EH	mmH 11H	EQ: Low EQ Gain -12...12dB
00H 0FH	mmH 11H	EQ: Low EQ Frequency 2...200 = 20...2000Hz
00H 10H	mmH 11H	EQ: Low EQ Q 3...100 = 0.3...10.0
00H 11H	mmH 11H	EQ: Mid EQ Gain -12...12dB
00H 12H	mmH 11H	EQ: Mid EQ Frequency 20...800 = 200...8000Hz
00H 13H	mmH 11H	EQ: Mid EQ Q 3...100 = 0.3...10.0
00H 14H	mmH 11H	EQ: High EQ Type 0,1 = Shelving, Peaking
00H 15H	mmH 11H	EQ: High EQ Gain -12...12dB
00H 16H	mmH 11H	EQ: High EQ Frequency 14...200 = 1.4...20.0kHz
00H 17H	mmH 11H	EQ: High EQ Q 3...100 = 0.3...10.0
00H 18H	mmH 11H	EQ: Out Level 0...100
00H 19H	00H 00H	(Reserved)
:	:	:
00H 7FH	00H 00H	

* (Delay Time) + (Absolute value of Shift) should be 1,200 or less.

Algorithm 2 Stereo Delay Chorus

NRFN	Data Entry	Data Entry
00H 00H	mmH 11H	Delay SW 0,1 = Off,On
00H 01H	mmH 11H	Chorus SW 0,1 = Off,On

00H 02H	mmH 11H	EQ SW 0,1 = Off,On
00H 03H	mmH 11H	Delay: Delay Time 0...500ms
00H 04H	mmH 11H	Delay: Shift -500...500 = 1500...1500ms
00H 05H	mmH 11H	Delay: Lch Feedback Level -100...100
00H 06H	mmH 11H	Delay: Rch Feedback Level -100...100
00H 07H	mmH 11H	Delay: Lch Cross Feedback Level -100...100
00H 08H	mmH 11H	Delay: Rch Cross Feedback Level -100...100
00H 09H	mmH 11H	Delay: Effect Level -100...100
00H 0AH	mmH 11H	Delay: Direct Level -100...100
00H 0BH	mmH 11H	Chorus: Rate 1...100 = 0.1...10.0Hz
00H 0CH	mmH 11H	Chorus: Depth 0...100
00H 0DH	mmH 11H	Chorus: Pre Delay 0...50ms
00H 0EH	mmH 11H	Chorus: Effect Level -100...100
00H 0FH	mmH 11H	Chorus: Direct Level -100...100
00H 10H	mmH 11H	Chorus: Lch Feedback Level -100...100
00H 11H	mmH 11H	Chorus: Rch Feedback Level -100...100
00H 12H	mmH 11H	Chorus: Lch Cross Feedback Level -100...100
00H 13H	mmH 11H	Chorus: Rch Cross Feedback Level -100...100
00H 14H	mmH 11H	EQ: Low EQ Type 0,1 = Shelving, Peaking
00H 15H	mmH 11H	EQ: Low EQ Gain -12...12dB
00H 16H	mmH 11H	EQ: Low EQ Frequency 2...200 = 20...2000Hz
00H 17H	mmH 11H	EQ: Low EQ Q 3...100 = 0.3...10.0
00H 18H	mmH 11H	EQ: Mid EQ Gain -12...12dB
00H 19H	mmH 11H	EQ: Mid EQ Frequency 20...800 = 200...8000Hz
00H 1AH	mmH 11H	EQ: Mid EQ Q 3...100 = 0.3...10.0
00H 1BH	mmH 11H	EQ: High EQ Type 0,1 = Shelving, Peaking
00H 1CH	mmH 11H	EQ: High EQ Gain -12...12dB
00H 1DH	mmH 11H	EQ: High EQ Frequency 14...200 = 1.4...20.0kHz
00H 1EH	mmH 11H	EQ: High EQ Q 3...100 = 0.3...10.0
00H 1FH	mmH 11H	EQ: Out Level 0...100
00H 20H	00H 00H	(Reserved)
:	:	:
00H 7FH	00H 00H	

* (Delay Time) + (Absolute value of Shift) should be 500 or less.

Algorithm 3 Stereo Pitch Shifter Delay

NRFN	Data Entry	Data Entry
00H 00H	mmH 11H	P.Shifter Delay SW 0,1 = Off,On
00H 01H	mmH 11H	EQ SW 0,1 = Off,On
00H 02H	mmH 11H	P.Shifter Delay: Lch Chromatic Pitch

MIDI Implementation

			-12,,,12
00H 03H	mmH 11H	P.Shifter Delay: Lch Fine Pitch	-100,,,100
00H 04H	mmH 11H	P.Shifter Delay: Lch Pre Delay	0,,,50ms
00H 05H	mmH 11H	P.Shifter Delay: Lch Feedback Delay Time	0,,,500ms
00H 06H	mmH 11H	P.Shifter Delay: Lch Feedback Level	-100,,,100
00H 07H	mmH 11H	P.Shifter Delay: Lch Cross Feedback Level	-100,,,100
00H 08H	mmH 11H	P.Shifter Delay: Rch Chromatic Pitch	-12,,,12
00H 09H	mmH 11H	P.Shifter Delay: Rch Fine Pitch	-100,,,100
00H 0AH	mmH 11H	P.Shifter Delay: Rch Pre Delay	0,,,50ms
00H 0BH	mmH 11H	P.Shifter Delay: Rch Feedback Delay Time	0,,,500ms
00H 0CH	mmH 11H	P.Shifter Delay: Rch Feedback Level	-100,,,100
00H 0DH	mmH 11H	P.Shifter Delay: Rch Cross Feedback Level	-100,,,100
00H 0EH	mmH 11H	P.Shifter Delay: Effect Level	-100,,,100
00H 0FH	mmH 11H	P.Shifter Delay: Direct Level	-100,,,100
00H 10H	mmH 11H	EQ: Low EQ Type	0,1 = Shelving, Peaking
00H 11H	mmH 11H	EQ: Low EQ Gain	-12,,,12dB
00H 12H	mmH 11H	EQ: Low EQ Frequency	2,,,200 = 20,,,2000Hz
00H 13H	mmH 11H	EQ: Low EQ Q	3,,,100 = 0.3,,,10.0
00H 14H	mmH 11H	EQ: Mid EQ Gain	-12,,,12dB
00H 15H	mmH 11H	EQ: Mid EQ Frequency	20,,,800 = 200,,,8000Hz
00H 16H	mmH 11H	EQ: Mid EQ Q	3,,,100 = 0.3,,,10.0
00H 17H	mmH 11H	EQ: High EQ Type	0,1 = Shelving, Peaking
00H 18H	mmH 11H	EQ: High EQ Gain	-12,,,12dB
00H 19H	mmH 11H	EQ: High EQ Frequency	14,,,200 = 1.4,,,20.0kHz
00H 1AH	mmH 11H	EQ: High EQ Q	3,,,100 = 0.3,,,10.0
00H 1BH	mmH 11H	EQ: Out Level	0,,,100
00H 1CH	00H 00H	(Reserved)	
00H 7FH	00H 00H		

Algorithm 4 Vocoder

NRFH	Data Entry		
00H 00H	mmH 11H	Chorus SW	0,1 = Off, On
00H 01H	mmH 11H	Vocoder: Voice Character 1	0,,,100
00H 02H	mmH 11H	Vocoder: Voice Character 2	0,,,100
00H 03H	mmH 11H	Vocoder: Voice Character 3	0,,,100
00H 04H	mmH 11H	Vocoder: Voice Character 4	0,,,100
00H 05H	mmH 11H	Vocoder: Voice Character 5	0,,,100
00H 06H	mmH 11H	Vocoder: Voice Character 6	0,,,100
00H 07H	mmH 11H	Vocoder: Voice Character 7	0,,,100

00H 08H	mmH 11H	Vocoder: Voice Character 8	0,,,100
00H 09H	mmH 11H	Vocoder: Voice Character 9	0,,,100
00H 0AH	mmH 11H	Vocoder: Voice Character 10	0,,,100
00H 0BH	mmH 11H	Chorus: Rate	1,,,100 = 0.1,,,10.0Hz
00H 0CH	mmH 11H	Chorus: Depth	0,,,100
00H 0DH	mmH 11H	Chorus: Pre Delay	0,,,50ms
00H 0EH	mmH 11H	Chorus: Feedback Level	-100,,,100
00H 0FH	mmH 11H	Chorus: Effect Level	-100,,,100
00H 10H	mmH 11H	Chorus: Direct Level	-100,,,100
00H 11H	00H 00H	(Reserved)	
00H 7FH	00H 00H		

Algorithm 5 2CH RSS

NRFH	Data Entry		
00H 00H	mmH 11H	2CH RSS: Ach Azimuth	-30,,,30 = -180,,,180
00H 01H	mmH 11H	2CH RSS: Ach Elevation	-15,,,15 = -90,,,90
00H 02H	mmH 11H	2CH RSS: Bch Azimuth	-30,,,30 = -180,,,180
00H 03H	mmH 11H	2CH RSS: Bch Elevation	-15,,,15 = -90,,,90
00H 04H	00H 00H	(Reserved)	
00H 7FH	00H 00H		

Algorithm 6 Delay RSS

NRFH	Data Entry		
00H 00H	mmH 11H	Delay RSS: Delay Time	0,,,1200ms
00H 01H	mmH 11H	Delay RSS: Shift	-1200,,,1200 = L1200,,,R1200ms
00H 02H	mmH 11H	Delay RSS: Center Delay Time	0,,,1200ms
00H 03H	mmH 11H	Delay RSS: RSS Level	0,,,100
00H 04H	mmH 11H	Delay RSS: Center Level	0,,,100
00H 05H	mmH 11H	Delay RSS: Feedback Level	-100,,,100
00H 06H	mmH 11H	Delay RSS: LF Damp Frequency	5,,,400 = 50,,,4000Hz
00H 07H	mmH 11H	Delay RSS: LF Damp Gain	-36,,,0dB
00H 08H	mmH 11H	Delay RSS: HF Damp Frequency	10,,,200 = 1.0,,,20.0kHz
00H 09H	mmH 11H	Delay RSS: HF Damp Gain	-36,,,0dB
00H 0AH	mmH 11H	Delay RSS: Effect Level	-100,,,100
00H 0BH	mmH 11H	Delay RSS: Direct Level	-100,,,100
00H 0CH	00H 00H	(Reserved)	
00H 7FH	00H 00H		

Algorithm 7 Chorus RSS

NRPN	Data Entry	
00H 00H	mmH 11H	Chorus RSS: Chorus Rate 1...100 = 0.1...10.0Hz
00H 01H	mmH 11H	Chorus RSS: Chorus Depth 0...100
00H 02H	mmH 11H	Chorus RSS: Effect Level -100...100
00H 03H	mmH 11H	Chorus RSS: Direct Level -100...100
00H 04H	00H 00H	(Reserved)
:	:	:
00H 7FH	00H 00H	

Common for Algorithm 8, 9, 10 Guitar Multi 1, 2, 3

NRPN	Data Entry	
00H 00H	mmH 11H	Compressor SW 0,1 = Off,On
00H 01H	mmH 11H	Metal/Distortion/Over Drive SW 0,1 = Off,On
00H 02H	mmH 11H	Noise Suppressor SW 0,1 = Off,On
00H 03H	mmH 11H	Auto Wah SW 0,1 = Off,On
00H 04H	mmH 11H	Guitar Amp Simulator SW 0,1 = Off,On
00H 05H	mmH 11H	Flanger SW 0,1 = Off,On
00H 06H	mmH 11H	Delay SW 0,1 = Off,On
00H 07H	mmH 11H	Compressor: Attack 0...100
00H 08H	mmH 11H	Compressor: Level 0...100
00H 09H	mmH 11H	Compressor: Sustain 0...100
00H 0AH	mmH 11H	Compressor: Tone -50...-50
00H 0BH	mmH 11H	Noise Suppressor: Threshold 0...100
00H 0CH	mmH 11H	Noise Suppressor: Release 0...100
00H 0DH	mmH 11H	Auto Wah: Mode 0,1 = LPF,BFF
00H 0EH	mmH 11H	Auto Wah: Polarity 0,1 = Down,Up
00H 0FH	mmH 11H	Auto Wah: Frequency 0...100
00H 10H	mmH 11H	Auto Wah: Level 0...100
00H 11H	mmH 11H	Auto Wah: Peak 0...100
00H 12H	mmH 11H	Auto Wah: Sens 0...100
00H 13H	mmH 11H	Auto Wah: Rate 1...100 = 0.1...10.0Hz
00H 14H	mmH 11H	Auto Wah: Depth 0...100
00H 15H	mmH 11H	Guitar Amp Simulator: Mode 0...3 = Small,BuiltIn,2Stack,3Stack
00H 16H	mmH 11H	Flanger: Rate 1...100 = 0.1...10.0Hz
00H 17H	mmH 11H	Flanger: Depth 0...100
00H 18H	mmH 11H	Flanger: Manual 0...100
00H 19H	mmH 11H	Flanger: Resonance 0...100
00H 1AH	mmH 11H	Delay: Delay Time 0...1000ms

00H 1BH	mmH 11H	Delay: Shift -1000...1000 = L1000...R1000ms
00H 1CH	mmH 11H	Delay: Feedback Time 0...1000ms
00H 1DH	mmH 11H	Delay: Feedback Level -100...100
00H 1EH	mmH 11H	Delay: Effect Level -100...100
00H 1FH	mmH 11H	Delay: Direct Level -100...100

* (Delay Time) + (Absolute value of Shift) should be 1,000 or less.

Individual : Algorithm 8 Guitar Multi 1

00H 20H	mmH 11H	Metal: Gain 0...100
00H 21H	mmH 11H	Metal: Level 0...100
00H 22H	mmH 11H	Metal: Hi Gain -100...100
00H 23H	mmH 11H	Metal: Mid Gain -100...100
00H 24H	mmH 11H	Metal: Low Gain -100...100
00H 25H	00H 00H	(Reserved)
:	:	:
00H 7FH	00H 00H	

Individual : Algorithm 9 Guitar Multi 2

00H 20H	mmH 11H	Distortion: Gain 0...100
00H 21H	mmH 11H	Distortion: Level 0...100
00H 22H	mmH 11H	Distortion: Tone 0...100
00H 23H	00H 00H	(Reserved)
:	:	:
00H 7FH	00H 00H	

Individual : Algorithm 10 Guitar Multi 3

00H 20H	mmH 11H	Over Drive: Gain 0...100
00H 21H	mmH 11H	Over Drive: Level 0...100
00H 22H	mmH 11H	Over Drive: Tone 0...100
00H 23H	00H 00H	(Reserved)
:	:	:
00H 7FH	00H 00H	

Algorithm 11 Vocal Multi

NRPN	Data Entry	
00H 00H	mmH 11H	Noise Suppressor SW 0,1 = Off,On
00H 01H	mmH 11H	Limiting/De-esser SW 0,1 = Off,On
00H 02H	mmH 11H	Enhancer SW 0,1 = Off,On
00H 03H	mmH 11H	EQ SW 0,1 = Off,On
00H 04H	mmH 11H	P.Shifter SW 0,1 = Off,On
00H 05H	mmH 11H	Delay SW 0,1 = Off,On

MIDI Implementation

00H 06H	mmH 11H	Chorus SW	0,1 = Off,On
00H 07H	mmH 11H	Limiters/De-esser Mode	0,1 = Limiter,De-esser
00H 08H	mmH 11H	Noise Suppressor: Threshold	0...100
00H 09H	mmH 11H	Noise Suppressor: Release	0...100
00H 0AH	mmH 11H	Limiters: Threshold	0...100
00H 0BH	mmH 11H	Limiters: Release	0...100
00H 0CH	mmH 11H	Limiters: Level	0...100
00H 0DH	mmH 11H	De-esser: Sens	0...100
00H 0EH	mmH 11H	De-esser: Frequency	10...100 = 1.0...10.0kHz
00H 0FH	mmH 11H	Enhancer: Sens	0...100
00H 10H	mmH 11H	Enhancer: Frequency	10...100 = 1.0...10.0kHz
00H 11H	mmH 11H	Enhancer: MIX Level	0...100
00H 12H	mmH 11H	Enhancer: Level	0...100
00H 13H	mmH 11H	EQ: Low EQ Type	0,1 = Shelving, Peaking
00H 14H	mmH 11H	EQ: Low EQ Gain	-12...12dB
00H 15H	mmH 11H	EQ: Low EQ Frequency	2...200 = 20...2000Hz
00H 16H	mmH 11H	EQ: Low EQ Q	3...100 = 0.3...10.0
00H 17H	mmH 11H	EQ: Mid EQ Gain	-12...12dB
00H 18H	mmH 11H	EQ: Mid EQ Frequency	20...800 = 200...8000Hz
00H 19H	mmH 11H	EQ: Mid EQ Q	3...100 = 0.3...10.0
00H 1AH	mmH 11H	EQ: High EQ Type	0,1 = Shelving, Peaking
00H 1BH	mmH 11H	EQ: High EQ Gain	-12...12dB
00H 1CH	mmH 11H	EQ: High EQ Frequency	14...200 = 1.4...20.0kHz
00H 1DH	mmH 11H	EQ: High EQ Q	3...100 = 0.3...10.0
00H 1EH	mmH 11H	EQ: Out Level	0...100
00H 1FH	mmH 11H	F.Shifter: Chromatic Pitch	-12...12
00H 20H	mmH 11H	F.Shifter: Fine Pitch	-100...100
00H 21H	mmH 11H	F.Shifter: Effect Level	-100...100
00H 22H	mmH 11H	F.Shifter: Direct Level	-100...100
00H 23H	mmH 11H	Delay: Delay Time	0...1000
00H 24H	mmH 11H	Delay: Feedback Level	-100...100
00H 25H	mmH 11H	Delay: Effect Level	-100...100
00H 26H	mmH 11H	Delay: Direct Level	-100...100
00H 27H	mmH 11H	Chorus: Rate	1...100 = 0.1...10.0Hz
00H 28H	mmH 11H	Chorus: Depth	0...100
00H 29H	mmH 11H	Chorus: Pre Delay	0...50ms
00H 2AH	mmH 11H	Chorus: Effect Level	-100...100
00H 2BH	mmH 11H	Chorus: Direct Level	-100...100
00H 2CH	00H 00H	(Reserved)	

00H 7FH	00H 00H	
---------	---------	--

Algorithm 12 Rotary

NRPN	Data Entry	
00H 00H	mmH 11H	Noise Suppressor SW 0,1 = Off,On
00H 01H	mmH 11H	Over Drive SW 0,1 = Off,On
00H 02H	mmH 11H	Noise Suppressor: Threshold 0...100
00H 03H	mmH 11H	Noise Suppressor: Release 0...100
00H 04H	mmH 11H	Over Drive: Gain 0...100
00H 05H	mmH 11H	Over Drive: Level 0...100
00H 06H	mmH 11H	Rotary: Low Rate 1...100 = 0.1...10.0Hz
00H 07H	mmH 11H	Rotary: Hi Rate 1...100 = 0.1...10.0Hz
00H 08H	00H 00H	(Reserved)
:	:	:
00H 7FH	00H 00H	

Algorithm 13 Guitar AMP Simulator

NRPN	Data Entry	
00H 00H	mmH 11H	Noise Suppressor SW 0,1 = Off,On
00H 01H	mmH 11H	Pre Amp SW 0,1 = Off,On
00H 02H	mmH 11H	Speaker SW 0,1 = Off,On
00H 03H	mmH 11H	Noise Suppressor: Threshold 0...100
00H 04H	mmH 11H	Noise Suppressor: Release 0...100
00H 05H	mmH 11H	Pre Amp: Mode 0...13 = JC-120, Clean Twin, Match Drive, BG Lead, MS1959(I), MS1959(II), MS1959(I+II), SLDN Lead, Metal 5150, Metal Lead, OD-1, OD-2Turbo, Distortion, Fuzz
00H 06H	mmH 11H	Pre Amp: Volume 0...100
00H 07H	mmH 11H	Pre Amp: Bass 0...100
00H 08H	mmH 11H	Pre Amp: Middle 0...100
00H 09H	mmH 11H	Pre Amp: Treble 0...100
00H 0AH	mmH 11H	Pre Amp: Presence 0...100
00H 0BH	mmH 11H	Pre Amp: Master 0...100
00H 0CH	mmH 11H	Pre Amp: Bright 0,1 = Off,On
00H 0DH	mmH 11H	Pre Amp: Gain 0,1,2 = Low,Middle,High
00H 0EH	mmH 11H	Speaker: Type 0...11 = Small, Middle, JC-120, Built In 1, Built In 2, Built In 3, Built In 4, BG Stack 1, BG Stack 2, MS Stack 1, MS Stack 2, Metal Stack
00H 0FH	mmH 11H	Speaker: MIC Setting 0,1,2 = 1,2,3
00H 10H	mmH 11H	Speaker: MIC Level 0...100
00H 11H	mmH 11H	Speaker: Direct Level 0...100
00H 12H	00H 00H	(Reserved)

00H 7FH | 00H 00H |

- Pre Amp Middle is invalid when the Mode = Match Drive.
- When the Mode = Match Drive, Pre Amp Presence works counter to the value (-100,,0).
- Pre Amp Bright is available only when the Mode = JC-120, Clean Twin, or BC Lead.

Algorithm 14 Stereo Phaser

NRPN	Data Entry	
00H 00H	mmH 11H	Phaser SW 0,1 = Off,On
00H 01H	mmH 11H	EQ SW 0,1 = Off,On
00H 02H	mmH 11H	Phaser: Mode 0...3 = 4.8.12.16stage
00H 03H	mmH 11H	Phaser: Rate 1...100 = 0.1...10.0Hz
00H 04H	mmH 11H	Phaser: Depth 0...100
00H 05H	mmH 11H	Phaser: Polarity 0,1 = Inverse, Synchro
00H 06H	mmH 11H	Phaser: Manual 0...100
00H 07H	mmH 11H	Phaser: Resonance 0...100
00H 08H	mmH 11H	Phaser: Cross Feedback 0...100
00H 09H	mmH 11H	Phaser: Effect Level -100...100
00H 0AH	mmH 11H	Phaser: Direct Level -100...100
00H 0BH	mmH 11H	EQ: Low EQ Type 0,1 = Shelving, Peaking
00H 0CH	mmH 11H	EQ: Low EQ Gain -12...12dB
00H 0DH	mmH 11H	EQ: Low EQ Frequency 2...200 = 20...2000Hz
00H 0EH	mmH 11H	EQ: Low EQ Q 3...100 = 0.3...10.0
00H 0FH	mmH 11H	EQ: Mid EQ Gain -12...12dB
00H 10H	mmH 11H	EQ: Mid EQ Frequency 20...800 = 200...8000Hz
00H 11H	mmH 11H	EQ: Mid EQ Q 3...100 = 0.3...10.0
00H 12H	mmH 11H	EQ: High EQ Type 0,1 = Shelving, Peaking
00H 13H	mmH 11H	EQ: High EQ Gain -12...12dB
00H 14H	mmH 11H	EQ: High EQ Frequency 14...200 = 1.4...20.0kHz
00H 15H	mmH 11H	EQ: High EQ Q 3...100 = 0.3...10.0
00H 16H	mmH 11H	EQ: Out Level 0...100
00H 17H	00H 00H	(Reserved)
:	:	:
00H 7FH	00H 00H	

Algorithm 15 Stereo Flanger

NRPN	Data Entry	
00H 00H	mmH 11H	Flanger SW 0,1 = Off,On
00H 01H	mmH 11H	EQ SW 0,1 = Off,On
00H 02H	mmH 11H	Flanger: Rate 1...100 = 0.1...10.0Hz
00H 03H	mmH 11H	Flanger: Depth 0...100
00H 04H	mmH 11H	Flanger: Polarity

NRPN	Data Entry	
00H 05H	mmH 11H	Flanger: Manual 0...100
00H 06H	mmH 11H	Flanger: Resonance 0...100
00H 07H	mmH 11H	Flanger: Cross Feedback Level 0...100
00H 08H	mmH 11H	Flanger: Effect Level -100...100
00H 09H	mmH 11H	Flanger: Direct Level -100...100
00H 0AH	mmH 11H	EQ: Low EQ Type 0,1 = Shelving, Peaking
00H 0BH	mmH 11H	EQ: Low EQ Gain -12...12dB
00H 0CH	mmH 11H	EQ: Low EQ Frequency 2...200 = 20...2000Hz
00H 0DH	mmH 11H	EQ: Low EQ Q 3...100 = 0.3...10.0
00H 0EH	mmH 11H	EQ: Mid EQ Gain -12...12dB
00H 0FH	mmH 11H	EQ: Mid EQ Frequency 20...800 = 200...8000Hz
00H 10H	mmH 11H	EQ: Mid EQ Q 3...100 = 0.3...10.0
00H 11H	mmH 11H	EQ: High EQ Type 0,1 = Shelving, Peaking
00H 12H	mmH 11H	EQ: High EQ Gain -12...12dB
00H 13H	mmH 11H	EQ: High EQ Frequency 14...200 = 1.4...20.0kHz
00H 14H	mmH 11H	EQ: High EQ Q 3...100 = 0.3...10.0
00H 15H	mmH 11H	EQ: Out Level 0...100
00H 16H	00H 00H	(Reserved)
:	:	:
00H 7FH	00H 00H	

Algorithm 16 Dual Compressor/Limiter

NRPN	Data Entry	
00H 00H	mmH 11H	Comp/Limit A SW 0,1 = Off,On
00H 01H	mmH 11H	Noise Suppressor A SW 0,1 = Off,On
00H 02H	mmH 11H	Comp/Limit B SW 0,1 = Off,On
00H 03H	mmH 11H	Noise Suppressor B SW 0,1 = Off,On
00H 04H	mmH 11H	Comp/Limit A: Detect 0,1,2 = A,B,Link
00H 05H	mmH 11H	Comp/Limit A: Level -60...12dB
00H 06H	mmH 11H	Comp/Limit A: Thresh -60...0dB
00H 07H	mmH 11H	Comp/Limit A: Attack 0...100
00H 08H	mmH 11H	Comp/Limit A: Release 0...100
00H 09H	mmH 11H	Comp/Limit A: Ratio 0...3 = 1.5:1.2:1.4:1.100:1
00H 0AH	mmH 11H	Noise Suppressor A: Detect 0,1,2 = A,B,Link
00H 0BH	mmH 11H	Noise Suppressor A: Threshold 0...100
00H 0CH	mmH 11H	Noise Suppressor A: Release 0...100
00H 0DH	mmH 11H	Comp/Limit B: Detect 0,1,2 = A,B,Link
00H 0EH	mmH 11H	Comp/Limit B: Level -60...12dB
00H 0FH	mmH 11H	Comp/Limit B: Thresh -60...0dB

MIDI Implementation

MIDI Implementation

00H 10H	mmH 11H	Comp/Limit B: Attack	0...100
00H 11H	mmH 11H	Comp/Limit B: Release	0...100
00H 12H	mmH 11H	Comp/Limit B: Ratio	0...3 = 1.5:1,2:1,4:1,100:1
00H 13H	mmH 11H	Noise Suppressor B: Detect	0,1,2 = A,B,Link
00H 14H	mmH 11H	Noise Suppressor B: Threshold	0...100
00H 15H	mmH 11H	Noise Suppressor B: Release	0...100
00H 16H	00H 00H	(Reserved)	
:	:		
00H 7FH	00H 00H		

Algorithm 17 Gate Reverb (FX1 Only)

NRPN	Data Entry		
00H 00H	mmH 11H	G.Reverb SW	0,1 = Off,On
00H 01H	mmH 11H	EQ SW	0,1 = Off,On
00H 02H	mmH 11H	G.Reverb: Gate Time	10...400ms
00H 03H	mmH 11H	G.Reverb: Pre Delay	0...300ms
00H 04H	mmH 11H	G.Reverb: Effect Level	-100...100
00H 05H	mmH 11H	G.Reverb: Mode	0...4 = Normal,L->R,R->L,Reverse,Reverse2
00H 06H	mmH 11H	G.Reverb: Thickness	0...100
00H 07H	mmH 11H	G.Reverb: Density	0...100
00H 08H	mmH 11H	G.Reverb: Accent Delay	0...200ms
00H 09H	mmH 11H	G.Reverb: Accent Level	0...100
00H 0AH	mmH 11H	G.Reverb: Accent Pan	1...127 = L63...R63
00H 0BH	mmH 11H	G.Reverb: Direct Level	-100...100
00H 0CH	mmH 11H	EQ: Low EQ Type	0,1 = Shelving, Peaking
00H 0DH	mmH 11H	EQ: Low EQ Gain	-12...12dB
00H 0EH	mmH 11H	EQ: Low EQ Frequency	2...200 = 20...2000Hz
00H 0FH	mmH 11H	EQ: Low EQ Q	3...100 = 0.3...10.0
00H 10H	mmH 11H	EQ: Mid EQ Gain	-12...12dB
00H 11H	mmH 11H	EQ: Mid EQ Frequency	20...800 = 200...8000Hz
00H 12H	mmH 11H	EQ: Mid EQ Q	3...100 = 0.3...10.0
00H 13H	mmH 11H	EQ: High EQ Type	0,1 = Shelving, Peaking
00H 14H	mmH 11H	EQ: High EQ Gain	-12...12dB
00H 15H	mmH 11H	EQ: High EQ Frequency	14...200 = 1.4...20.0kHz
00H 16H	mmH 11H	EQ: High EQ Q	3...100 = 0.3...10.0
00H 17H	mmH 11H	EQ: Out Level	0...100
00H 18H	00H 00H	(Reserved)	
:	:		
00H 7FH	00H 00H		

Algorithm 18 Multi Tap Delay

NRPN	Data Entry		
00H 00H	mmH 11H	EQ SW	0,1 = Off,On
00H 01H	mmH 11H	M.Tap Delay: Time 1	0...1200ms
00H 02H	mmH 11H	M.Tap Delay: Level 1	0...100
00H 03H	mmH 11H	M.Tap Delay: Pan 1	1...127 = L63...R63
00H 04H	mmH 11H	M.Tap Delay: Time 2	0...1200ms
00H 05H	mmH 11H	M.Tap Delay: Level 2	0...100
00H 06H	mmH 11H	M.Tap Delay: Pan 2	1...127 = L63...R63
00H 07H	mmH 11H	M.Tap Delay: Time 3	0...1200ms
00H 08H	mmH 11H	M.Tap Delay: Level 3	0...100
00H 09H	mmH 11H	M.Tap Delay: Pan 3	1...127 = L63...R63
00H 0AH	mmH 11H	M.Tap Delay: Time 4	0...1200ms
00H 0BH	mmH 11H	M.Tap Delay: Level 4	0...100
00H 0CH	mmH 11H	M.Tap Delay: Pan 4	1...127 = L63...R63
00H 0DH	mmH 11H	M.Tap Delay: Time 5	0...1200ms
00H 0EH	mmH 11H	M.Tap Delay: Level 5	0...100
00H 0FH	mmH 11H	M.Tap Delay: Pan 5	1...127 = L63...R63
00H 10H	mmH 11H	M.Tap Delay: Time 6	0...1200ms
00H 11H	mmH 11H	M.Tap Delay: Level 6	0...100
00H 12H	mmH 11H	M.Tap Delay: Pan 6	1...127 = L63...R63
00H 13H	mmH 11H	M.Tap Delay: Time 7	0...1200ms
00H 14H	mmH 11H	M.Tap Delay: Level 7	0...100
00H 15H	mmH 11H	M.Tap Delay: Pan 7	1...127 = L63...R63
00H 16H	mmH 11H	M.Tap Delay: Time 8	0...1200ms
00H 17H	mmH 11H	M.Tap Delay: Level 8	0...100
00H 18H	mmH 11H	M.Tap Delay: Pan 8	1...127 = L63...R63
00H 19H	mmH 11H	M.Tap Delay: Time 9	0...1200ms
00H 1AH	mmH 11H	M.Tap Delay: Level 9	0...100
00H 1BH	mmH 11H	M.Tap Delay: Pan 9	1...127 = L63...R63
00H 1CH	mmH 11H	M.Tap Delay: Time 10	0...1200ms
00H 1DH	mmH 11H	M.Tap Delay: Level 10	0...100
00H 1EH	mmH 11H	M.Tap Delay: Pan 10	1...127 = L63...R63
00H 1FH	mmH 11H	M.Tap Delay: Feedback Delay Time	0...1200ms
00H 20H	mmH 11H	M.Tap Delay: Feedback Level	-100...100
00H 21H	mmH 11H	M.Tap Delay: Effect Level	-100...100
00H 22H	mmH 11H	M.Tap Delay: Direct Level	-100...100
00H 23H	mmH 11H	EQ: Low EQ Type	0,1 = Shelving, Peaking

MIDI Implementation

00H 24H	mmH 11H	EQ: Low EQ Gain	-12...12dB
00H 25H	mmH 11H	EQ: Low EQ Frequency	2...200 = 20...2000Hz
00H 26H	mmH 11H	EQ: Low EQ Q	3...100 = 0.3...10.0
00H 27H	mmH 11H	EQ: Mid EQ Gain	-12...12dB
00H 28H	mmH 11H	EQ: Mid EQ Frequency	20...800 = 200...8000Hz
00H 29H	mmH 11H	EQ: Mid EQ Q	3...100 = 0.3...10.0
00H 2AH	mmH 11H	EQ: High EQ Type	0,1 = Shelving, Peaking
00H 2BH	mmH 11H	EQ: High EQ Gain	-12...12dB
00H 2CH	mmH 11H	EQ: High EQ Frequency	14...200 = 1.4...20.0kHz
00H 2DH	mmH 11H	EQ: High EQ Q	3...100 = 0.3...10.0
00H 2EH	mmH 11H	EQ: Out Level	0...100
00H 2FH	00H 00H	(Reserved)	:
00H 7FH	00H 00H		

Algorithm 19 Stereo Multi

NRFN	Data Entry		
00H 00H	mmH 11H	Noise Suppressor SW	0,1 = Off,On
00H 01H	mmH 11H	Comp/Limit SW	0,1 = Off,On
00H 02H	mmH 11H	Enhancer SW	0,1 = Off,On
00H 03H	mmH 11H	EQ SW	0,1 = Off,On
00H 04H	mmH 11H	Noise Suppressor: Threshold	0...100
00H 05H	mmH 11H	Noise Suppressor: Release	0...100
00H 06H	mmH 11H	Comp/Limit: Level	-60...12dB
00H 07H	mmH 11H	Comp/Limit: Thresh	-60...0dB
00H 08H	mmH 11H	Comp/Limit: Attack	0...100
00H 09H	mmH 11H	Comp/Limit: Release	0...100
00H 0AH	mmH 11H	Comp/Limit: Ratio	0...3 = 1.5:1.2:1.4:1.100:1
00H 0BH	mmH 11H	Enhancer: Sens	0...100
00H 0CH	mmH 11H	Enhancer: Frequency	10...100 = 1.0...10.0kHz
00H 0DH	mmH 11H	Enhancer: MIX Level	0...100
00H 0EH	mmH 11H	Enhancer: Level	0...100
00H 0FH	mmH 11H	EQ: Low EQ Type	0,1 = Shelving, Peaking
00H 10H	mmH 11H	EQ: Low EQ Gain	-12...12dB
00H 11H	mmH 11H	EQ: Low EQ Frequency	2...200 = 20...2000Hz
00H 12H	mmH 11H	EQ: Low EQ Q	3...100 = 0.3...10.0
00H 13H	mmH 11H	EQ: Mid EQ Gain	-12...12dB
00H 14H	mmH 11H	EQ: Mid EQ Frequency	20...800 = 200...8000Hz
00H 15H	mmH 11H	EQ: Mid EQ Q	3...100 = 0.3...10.0
00H 16H	mmH 11H	EQ: High EQ Type	0,1 = Shelving, Peaking

00H 17H	mmH 11H	EQ: High EQ Gain	-12...12dB
00H 18H	mmH 11H	EQ: High EQ Frequency	14...200 = 1.4...20.0kHz
00H 19H	mmH 11H	EQ: High EQ Q	3...100 = 0.3...10.0
00H 1AH	mmH 11H	EQ: Out Level	0...100
00H 1BH	00H 00H	(Reserved)	:
00H 7FH	00H 00H		

Algorithm 20 Reverb 2

NRFN	Data Entry		
00H 00H	mmH 11H	Reverb SW	0,1 = Off,On
00H 01H	mmH 11H	EQ SW	0,1 = Off,On
00H 02H	mmH 11H	Reverb 2: Reverb Type	0...4 = Room1,Room2,Hall1,Hall2,Plate
00H 03H	mmH 11H	Reverb 2: Reverb Time	1...100 = 0.1...10.0sec
00H 04H	mmH 11H	Reverb 2: Pre Delay	0...200msec
00H 05H	mmH 11H	Reverb 2: Density	0...100
00H 06H	mmH 11H	Reverb 2: High Pass Filter	1...200 = Thru,20...2000Hz
00H 07H	mmH 11H	Reverb 2: Low Pass Filter	10...201 = 1.0...20.0kHz,Thru
00H 08H	mmH 11H	Reverb 2: Effect Level	0...100
00H 09H	mmH 11H	Reverb 2: Direct Level	0...100
00H 0AH	mmH 11H	Reverb 2: Gate SW	0,1 = Off,On
00H 0BH	mmH 11H	Reverb 2: Gate Mode	0,1 = Gate,Ducking
00H 0CH	mmH 11H	Reverb 2: Gate Threshold	0...100
00H 0DH	mmH 11H	Reverb 2: Gate Attack Time	1...100
00H 0EH	mmH 11H	Reverb 2: Gate Release Time	1...100
00H 0FH	mmH 11H	Reverb 2: Gate Hold Time	1...100
00H 10H	mmH 11H	EQ: Low EQ Type	0,1 = Shelving, Peaking
00H 11H	mmH 11H	EQ: Low EQ Gain	-12...12dB
00H 12H	mmH 11H	EQ: Low EQ Frequency	2...200 = 20...2000Hz
00H 13H	mmH 11H	EQ: Low EQ Q	3...100 = 0.3...10.0
00H 14H	mmH 11H	EQ: Mid EQ Gain	-12...12dB
00H 15H	mmH 11H	EQ: Mid EQ Frequency	20...800 = 200...8000Hz
00H 16H	mmH 11H	EQ: Mid EQ Q	3...100 = 0.3...10.0
00H 17H	mmH 11H	EQ: High EQ Type	0,1 = Shelving, Peaking
00H 18H	mmH 11H	EQ: High EQ Gain	-12...12dB
00H 19H	mmH 11H	EQ: High EQ Frequency	14...200 = 1.4...20.0kHz
00H 1AH	mmH 11H	EQ: High EQ Q	3...100 = 0.3...10.0
00H 1BH	mmH 11H	EQ: Out Level	0...100
00H 1CH	00H 00H	(Reserved)	:

MIDI Implementation

MIDI Implementation

| 00H 7FH | 00H 00H |

Algorithm 21 Space Chorus

NRPN	Data Entry	
00H 00H	mmH 11H	Chorus SW 0,1 = Off,On
00H 01H	mmH 11H	Chorus: Input Mode 0,1 = Mono,Stereo
00H 02H	mmH 11H	Chorus: Mode 0,,,6 = 1.2.3.4.1+4.2-4.3+4
00H 03H	mmH 11H	Chorus: Mix Balance 0,,,100
00H 04H	00H 00H	(Reserved)
:	:	:
00H 7FH	00H 00H	

Algorithm 22 Lo-Fi Processor

NRPN	Data Entry	
00H 00H	mmH 11H	Lo-Fi Processor SW 0,1 = Off,On
00H 01H	mmH 11H	Realtime Modify Filter SW 0,1 = Off,On
00H 02H	mmH 11H	Lo-Fi Processor: Pre Filter SW 0,1 = Off,On
00H 03H	mmH 11H	Lo-Fi Processor: Rate 0,,,31 = Off,1/2,,,1/32
00H 04H	mmH 11H	Lo-Fi Processor: Number of Bit 0,,,15 = Off,15,,,1bit
00H 05H	mmH 11H	Lo-Fi Processor: Post Filter SW 0,1 = Off,On
00H 06H	mmH 11H	Lo-Fi Processor: Effect Level 0,,,100
00H 07H	mmH 11H	Lo-Fi Processor: Direct Level 0,,,100
00H 08H	mmH 11H	Realtime Modify Filter: Filter Type 0,,,2 = LPF,BPF,HPF
00H 09H	mmH 11H	Realtime Modify Filter: Cut Off 0,,,100
00H 0AH	mmH 11H	Realtime Modify Filter: Resonance 0,,,100
00H 0BH	mmH 11H	Realtime Modify Filter: Gain 0,,,24dB
00H 0CH	mmH 11H	Noise Suppressor: Threshold 0,,,100
00H 0DH	mmH 11H	Noise Suppressor: Release 0,,,100
00H 0EH	00H 00H	(Reserved)
:	:	:
00H 7FH	00H 00H	

Algorithm 23 4 Band Parametric EQ

NRPN	Data Entry	
00H 00H	mmH 11H	Parametric EQ Link SW 0,1 = Off,On
00H 01H	mmH 11H	Parametric EQ Ach SW 0,1 = Off,On
00H 02H	mmH 11H	Parametric EQ Bch SW 0,1 = Off,On
00H 03H	mmH 11H	EQ Ach: Input Gain -60,,,12dB
00H 04H	mmH 11H	EQ Ach: Low EQ Type 0,1 = Shelving, Peaking
00H 05H	mmH 11H	EQ Ach: Low EQ Gain -12,,,12dB
00H 06H	mmH 11H	EQ Ach: Low EQ Frequency

			2,,,200 = 20,,,2000Hz
00H 07H	mmH 11H	EQ Ach: Low EQ Q	3,,,100 = 0.3,,,10.0
00H 08H	mmH 11H	EQ Ach: Low Mid EQ Gain	-12,,,12dB
00H 09H	mmH 11H	EQ Ach: Low Mid EQ Frequency	20,,,800 = 200,,,8000Hz
00H 0AH	mmH 11H	EQ Ach: Low Mid EQ Q	3,,,100 = 0.3,,,10.0
00H 0BH	mmH 11H	EQ Ach: High Mid EQ Gain	-12,,,12dB
00H 0CH	mmH 11H	EQ Ach: High Mid EQ Frequency	20,,,800 = 200,,,8000Hz
00H 0DH	mmH 11H	EQ Ach: High Mid EQ Q	3,,,100 = 0.3,,,10.0
00H 0EH	mmH 11H	EQ Ach: High EQ Type	0,1 = Shelving, Peaking
00H 0FH	mmH 11H	EQ Ach: High EQ Gain	-12,,,12dB
00H 10H	mmH 11H	EQ Ach: High EQ Frequency	14,,,200 = 1.4,,,20.0kHz
00H 11H	mmH 11H	EQ Ach: High EQ Q	3,,,100 = 0.3,,,10.0
00H 12H	mmH 11H	EQ Ach: Output Level	-60,,,12dB
00H 13H	mmH 11H	EQ Bch: Input Gain	-60,,,12dB
00H 14H	mmH 11H	EQ Bch: Low EQ Type	0,1 = Shelving, Peaking
00H 15H	mmH 11H	EQ Bch: Low EQ Gain	-12,,,12dB
00H 16H	mmH 11H	EQ Bch: Low EQ Frequency	2,,,200 = 20,,,2000Hz
00H 17H	mmH 11H	EQ Bch: Low EQ Q	3,,,100 = 0.3,,,10.0
00H 18H	mmH 11H	EQ Bch: Low Mid EQ Gain	-12,,,12dB
00H 19H	mmH 11H	EQ Bch: Low Mid EQ Frequency	20,,,800 = 200,,,8000Hz
00H 1AH	mmH 11H	EQ Bch: Low Mid EQ Q	3,,,100 = 0.3,,,10.0
00H 1BH	mmH 11H	EQ Bch: High Mid EQ Gain	-12,,,12dB
00H 1CH	mmH 11H	EQ Bch: High Mid EQ Frequency	20,,,800 = 200,,,8000Hz
00H 1DH	mmH 11H	EQ Bch: High Mid EQ Q	3,,,100 = 0.3,,,10.0
00H 1EH	mmH 11H	EQ Bch: High EQ Type	0,1 = Shelving, Peaking
00H 1FH	mmH 11H	EQ Bch: High EQ Gain	-12,,,12dB
00H 20H	mmH 11H	EQ Bch: High EQ Frequency	14,,,200 = 1.4,,,20.0kHz
00H 21H	mmH 11H	EQ Bch: High EQ Q	3,,,100 = 0.3,,,10.0
00H 22H	mmH 11H	EQ Bch: Output Level	-60,,,12dB
00H 23H	00H 00H	(Reserved)	
:	:	:	
00H 7FH	00H 00H		

* When Link SW = On, Bch corresponds to Ach.

Algorithm 24 10 Band Graphic EQ

NRPN	Data Entry	
00H 00H	mmH 11H	Graphic EQ Link SW 0,1 = Off,On
00H 01H	mmH 11H	Graphic EQ Ach SW 0,1 = Off,On
00H 02H	mmH 11H	Graphic EQ Bch SW 0,1 = Off,On
00H 03H	mmH 11H	EQ Ach: Input Gain -60,,,12dB

00H 04H	mmH 11H	EQ Ach: 31.25Hz Gain	-12...12dB
00H 05H	mmH 11H	EQ Ach: 62.5Hz Gain	-12...12dB
00H 06H	mmH 11H	EQ Ach: 125Hz Gain	-12...12dB
00H 07H	mmH 11H	EQ Ach: 250Hz Gain	-12...12dB
00H 08H	mmH 11H	EQ Ach: 500Hz Gain	-12...12dB
00H 09H	mmH 11H	EQ Ach: 1.0kHz Gain	-12...12dB
00H 0AH	mmH 11H	EQ Ach: 2.0kHz Gain	-12...12dB
00H 0BH	mmH 11H	EQ Ach: 4.0kHz Gain	-12...12dB
00H 0CH	mmH 11H	EQ Ach: 8.0kHz Gain	-12...12dB
00H 0DH	mmH 11H	EQ Ach: 16.0kHz Gain	-12...12dB
00H 0EH	mmH 11H	EQ Ach: Output Level	-60...12dB
00H 0FH	mmH 11H	EQ Bch: Input Gain	-60...12dB
00H 10H	mmH 11H	EQ Bch: 31.25Hz Gain	-12...12dB
00H 11H	mmH 11H	EQ Bch: 62.5Hz Gain	-12...12dB
00H 12H	mmH 11H	EQ Bch: 125Hz Gain	-12...12dB
00H 13H	mmH 11H	EQ Bch: 250Hz Gain	-12...12dB
00H 14H	mmH 11H	EQ Bch: 500Hz Gain	-12...12dB
00H 15H	mmH 11H	EQ Bch: 1.0kHz Gain	-12...12dB
00H 16H	mmH 11H	EQ Bch: 2.0kHz Gain	-12...12dB
00H 17H	mmH 11H	EQ Bch: 4.0kHz Gain	-12...12dB
00H 18H	mmH 11H	EQ Bch: 8.0kHz Gain	-12...12dB
00H 19H	mmH 11H	EQ Bch: 16.0kHz Gain	-12...12dB
00H 1AH	mmH 11H	EQ Bch: Output Level	-60...12dB
00H 1BH	00H 00H	(Reserved)	:
00H 1CH	:	:	:
00H 1DH	:	:	:
00H 1EH	:	:	:
00H 1FH	00H 00H	:	:

* When Link SW = On, Bch corresponds to Ach.

Algorithm 25 Hum Canceled

NRPN	Data Entry		
00H 00H	mmH 11H	Hum Canceled SW	0,1 = Off,On
00H 01H	mmH 11H	Noise Suppressor SW	0,1 = Off,On
00H 02H	mmH 11H	Hum Canceled: Frequency	200...800G = 20.0...800.0Hz
00H 03H	mmH 11H	Hum Canceled: Width	10...40%
00H 04H	mmH 11H	Hum Canceled: Depth	0...100
00H 05H	mmH 11H	Hum Canceled: Threshold	0...100
00H 06H	mmH 11H	Hum Canceled: Range Low	1...200 = Unlimit,20...2000Hz
00H 07H	mmH 11H	Hum Canceled: Range High	10...201 = 1.0...20.0kHz,Unlimit
00H 08H	mmH 11H	Noise Suppressor: Threshold	0...100

00H 09H	mmH 11H	Noise Suppressor: Release	0...100
00H 0AH	00H 00H	(Reserved)	:
00H 0BH	:	:	:
00H 0CH	00H 00H	:	:

Algorithm 26 Vocal Canceled

NRPN	Data Entry		
00H 00H	mmH 11H	Vocal Canceled SW	0,1 = Off,On
00H 01H	mmH 11H	EQ SW	0,1 = Off,On
00H 02H	mmH 11H	Vocal Canceled: Balance	0...100
00H 03H	mmH 11H	Vocal Canceled: Range Low	1...200 = Unlimit,20...2000Hz
00H 04H	mmH 11H	Vocal Canceled: Range High	10...201 = 1.0...20.0kHz,Unlimit
00H 05H	mmH 11H	EQ: Low EQ Type	0,1 = Shelving, Peaking
00H 06H	mmH 11H	EQ: Low EQ Gain	-12...12dB
00H 07H	mmH 11H	EQ: Low EQ Frequency	2...200 = 20...2000Hz
00H 08H	mmH 11H	EQ: Low EQ Q	3...100 = 0.3...10.0
00H 09H	mmH 11H	EQ: Mid EQ Gain	-12...12dB
00H 0AH	mmH 11H	EQ: Mid EQ Frequency	20...800 = 200...8000Hz
00H 0BH	mmH 11H	EQ: Mid EQ Q	3...100 = 0.3...10.0
00H 0CH	mmH 11H	EQ: High EQ Type	0,1 = Shelving, Peaking
00H 0DH	mmH 11H	EQ: High EQ Gain	-12...12dB
00H 0EH	mmH 11H	EQ: High EQ Frequency	14...200 = 1.4...20.0kHz
00H 0FH	mmH 11H	EQ: High EQ Q	3...100 = 0.3...10.0
00H 10H	mmH 11H	EQ: Out Level	0...100
00H 11H	00H 00H	(Reserved)	:
00H 12H	:	:	:
00H 13H	:	:	:
00H 14H	00H 00H	:	:

Algorithm 27 Voice Transformer (FX1 Only)

NRPN	Data Entry		
00H 00H	mmH 11H	Voice Transformer SW	0,1 = Off,On
00H 01H	mmH 11H	Reverb SW	0,1 = Off,On
00H 02H	mmH 11H	Fader Edit SW	0,1 = Off,On
00H 03H	mmH 11H	MIDI Control SW	0,1 = Off,On
00H 04H	mmH 11H	Voice Transformer: Robot SW	0,1 = Off,On
00H 05H	mmH 11H	Voice Transformer: Chromatic Pitch	-12...36
00H 06H	mmH 11H	Voice Transformer: Fine Pitch	-100...100
00H 07H	mmH 11H	Voice Transformer: Chromatic Formant	-12...12
00H 08H	mmH 11H	Voice Transformer: Fine Formant	-100...100
00H 09H	mmH 11H	Voice Transformer: Mix Balance	0...100
00H 0AH	mmH 11H	Reverb: Reverb Time	

MIDI Implementation

MIDI Implementation

			1...100 = 0.1...10.0sec
00H 08H	nmH 11H	Reverb: Pre Delay	0...200msec
00H 0CH	nmH 11H	Reverb: Density	0...100
00H 0DH	nmH 11H	Reverb: Effect Level	0...100
00H 0EH	nmH 11H	MIDI Control: Bend Range	0...12 = Off,1...12
00H 0FH	nmH 11H	MIDI Control: Portamento	0...100 = Off,1...100
00H 10H	00H 00H	(Reserved)	:
:	:	:	:
00H 7FH	00H 0CH		

Algorithm 28 Vocoder 2 (FX1 Only)

NRPN	Data Entry		
00H 06H	nmH 11H	Chorus SW	0.1 = Off,On
00H 01H	nmH 11H	Vocoder: Envelope Mode	0...2 = Sharp,Soft,Long
00H 02H	nmH 11H	Vocoder: Pan Mode	0...3 = Mono,Stereo,L->R,R->L
00H 03H	nmH 11H	Vocoder: Hold	0.1 = Off,MIDI
00H 04H	nmH 11H	Vocoder: Mic Sens	0...100
00H 05H	nmH 11H	Vocoder: Synth Input Level	0...100
00H 06H	nmH 11H	Vocoder: Voice Char Level 1	0...100
00H 07H	nmH 11H	Vocoder: Voice Char Level 2	0...100
00H 08H	nmH 11H	Vocoder: Voice Char Level 3	0...100
00H 09H	nmH 11H	Vocoder: Voice Char Level 4	0...100
00H 0AH	nmH 11H	Vocoder: Voice Char Level 5	0...100
00H 0BH	nmH 11H	Vocoder: Voice Char Level 6	0...100
00H 0CH	nmH 11H	Vocoder: Voice Char Level 7	0...100
00H 0DH	nmH 11H	Vocoder: Voice Char Level 8	0...100
00H 0EH	nmH 11H	Vocoder: Voice Char Level 9	0...100
00H 0FH	nmH 11H	Vocoder: Voice Char Level 10	0...100
00H 10H	nmH 11H	Vocoder: Voice Char Level 11	0...100
00H 11H	nmH 11H	Vocoder: Voice Char Level 12	0...100
00H 12H	nmH 11H	Vocoder: Voice Char Level 13	0...100
00H 13H	nmH 11H	Vocoder: Voice Char Level 14	0...100
00H 14H	nmH 11H	Vocoder: Voice Char Level 15	0...100
00H 15H	nmH 11H	Vocoder: Voice Char Level 16	0...100
00H 16H	nmH 11H	Vocoder: Voice Char Level 17	0...100
00H 17H	nmH 11H	Vocoder: Voice Char Level 18	0...100
00H 18H	nmH 11H	Vocoder: Voice Char Level 19	0...100
00H 19H	nmH 11H	Vocoder: Mic High Pass Filter	0...200 = Thru,1 0...20.0kHz
00H 1AH	nmH 11H	Vocoder: Mic High Pass Filter Pan	1...127 = L63...R63
00H 1BH	nmH 11H	Vocoder: Mic Mix	0...100

00H 1CH	nmH 11H	Vocoder: Noise Suppressor Threshold	0...100
00H 1DH	nmH 11H	Chorus: Rate	1...100 = 0.1...10.0Hz
00H 1EH	nmH 11H	Chorus: Depth	0...100
00H 1FH	nmH 11H	Chorus: Pre Delay	0...50ms
00H 20H	nmH 11H	Chorus: Mix Balance	0...100
00H 21H	00H 00H	(Reserved)	:
:	:	:	:
00H 7FH	00H 00H		

Algorithm 29 Mic Simulator

NRPN	Data Entry		
00H 00H	nmH 11H	Link SW	0.1 = Off,On
00H 01H	nmH 11H	Mic Converter Ach SW	0.1 = Off,On
00H 02H	nmH 11H	Bass Cut Ach SW	0.1 = Off,On
00H 03H	nmH 11H	Distance Ach SW	0.1 = Off,On
00H 04H	nmH 11H	Limiter Ach SW	0.1 = Off,On
00H 05H	nmH 11H	Mic Converter Bch SW	0.1 = Off,On
00H 06H	nmH 11H	Bass Cut Bch SW	0.1 = Off,On
00H 07H	nmH 11H	Distance Bch SW	0.1 = Off,On
00H 08H	nmH 11H	Limiter Bch SW	0.1 = Off,On
00H 09H	nmH 11H	Mic Converter Ach: Input	0...4 = DR-20,SmlDy,HedDy,MinCn,Flat
00H 0AH	nmH 11H	Mic Converter Ach: Output	0...6 = SmlDy,VocDy,LrgDy,SmlCn,LrgCn,VntCn,Flat
00H 0BH	nmH 11H	Mic Converter Ach: Phase	0.1 = Normal,Inverse
00H 0CH	nmH 11H	Bass Cut Ach: Bass Cut Frequency	1...200 = Thru,20...2000Hz
00H 0DH	nmH 11H	Distance Ach: Proximity Effect	-12...+12
00H 0EH	nmH 11H	Distance Ach: Time	0...1000 = 0...3000cm
00H 0FH	nmH 11H	Limiter Ach: Detect HPF Frequency	1...200 = Thru,20...2000Hz
00H 10H	nmH 11H	Limiter Ach: Level	-60...24dB
00H 11H	nmH 11H	Limiter Ach: Threshold	-60...0dB
00H 12H	nmH 11H	Limiter Ach: Attack	0...100
00H 13H	nmH 11H	Limiter Ach: Release	0...100
00H 14H	nmH 11H	Mic Converter Bch: Input	0...4 = DR-20,SmlDy,HedDy,MinCn,Flat
00H 15H	nmH 11H	Mic Converter Bch: Output	0...5 = SmlDy,VocDy,LrgDy,SmlCn,LrgCn,VntCn,Flat
00H 16H	nmH 11H	Mic Converter Bch: Phase	0.1 = Normal,Inverse
00H 17H	nmH 11H	Bass Cut Bch: Bass Cut Frequency	1...200 = Thru,20...2000Hz
00H 18H	nmH 11H	Distance Bch: Proximity Effect	-12...+12
00H 19H	nmH 11H	Distance Bch: Time	0...1000 = 0...3000cm
00H 1AH	nmH 11H	Limiter Bch: Detect HPF Frequency	1...200 = Thru,20...2000Hz
00H 1BH	nmH 11H	Limiter Bch: Level	-60...24dB

00H 1CH	mmH 11H	Limiters Bch: Threshold	-60...0dB
00H 1DH	mmH 11H	Limiters Bch: Attack	0...100
00H 1EH	mmH 11H	Limiters Bch: Release	0...100
00H 1FH	00H 00H	(Reserved)	
:	:		
00H 7FH	00H 00H		

- When Mic Converter Input = MinCn, Output is fixed to SmlDy or LrgCn.
- When Link SW = On, Bch corresponds to Ach.

Algorithm 30 3 Band Isolator

NRPN	Data Entry		
00H 00H	mmH 11H	Isolator SW	0,1 = Off,On
00H 01H	mmH 11H	Isolator High Volume	-60...-4dB
00H 02H	mmH 11H	Isolator Middle Volume	-60...-4dB
00H 03H	mmH 11H	Isolator Low Volume	-60...-4dB
00H 04H	mmH 11H	Isolator Anti Phase Middle Switch	0,1 = Off,On
00H 05H	mmH 11H	Isolator Anti Phase Middle Level	0...100
00H 06H	mmH 11H	Isolator Anti Phase Low Switch	0,1 = Off,On
00H 07H	mmH 11H	Isolator Anti Phase Low Level	0...100
00H 08H	00H 00H	(Reserved)	
:	:		
00H 7FH	00H 00H		

Algorithm 31 Tape Echo 201

NRPN	Data Entry		
00H 00H	mmH 11H	Tape Echo SW	0,1 = Off,On
00H 01H	mmH 11H	Tape Echo Mode Select	0...6 = 1...7
00H 02H	mmH 11H	Tape Echo Repeat Rate	0...100
00H 03H	mmH 11H	Tape Echo Intensity	0...100
00H 04H	mmH 11H	Tape Echo Effect Level	0...100
00H 05H	mmH 11H	Tape Echo Direct Level	0...100
00H 06H	mmH 11H	Tape Echo Tone Bass	-100...100
00H 07H	mmH 11H	Tape Echo Tone Treble	-100...100
00H 08H	mmH 11H	Tape Echo Tape Head S Pan	1...127 = L63...R63
00H 09H	mmH 11H	Tape Echo Tape Head M Pan	1...127 = L63...R63
00H 0AH	mmH 11H	Tape Echo Tape Head L Pan	1...127 = L63...R63
00H 0BH	mmH 11H	Tape Echo Tape Distortion	0...100
00H 0CH	mmH 11H	Tape Echo Wah Flutter Rate	0...100
00H 0DH	mmH 11H	Tape Echo Wah Flutter Depth	0...100
00H 0EH	00H 00H	(Reserved)	
:	:		
00H 7FH	00H 00H		

Algorithm 32 Analog Flanger

NRPN	Data Entry		
00H 00H	mmH 11H	Analog Flanger SW	0,1 = Off,On
00H 01H	mmH 11H	Analog Flanger Mode	0...3 = FL1,FL2,FL3,CHD
00H 02H	mmH 11H	Analog Flanger Feedback	0...100
00H 03H	mmH 11H	Analog Flanger Modulation Rate	0...100
00H 04H	mmH 11H	Analog Flanger Modulation Depth	0...100
00H 05H	mmH 11H	Analog Flanger Modulation Frequency	0...100
00H 06H	mmH 11H	Analog Flanger Channel B Modulation	0,1 = Nor,Inv
00H 07H	mmH 11H	Analog Flanger Channel A Phase	0,1 = Nor,Inv
00H 08H	mmH 11H	Analog Flanger Channel B Phase	0,1 = Nor,Inv
00H 09H	00H 00H	(Reserved)	
:	:		
00H 7FH	00H 00H		

Algorithm 33 Analog Phaser

NRPN	Data Entry		
00H 00H	mmH 11H	Analog Phaser SW	0,1 = Off,On
00H 01H	mmH 11H	Analog Phaser Mode	0,1 = 4STAGE,8STAGE
00H 02H	mmH 11H	Analog Phaser Frequency	0...100
00H 03H	mmH 11H	Analog Phaser Resonance	0...100
00H 04H	mmH 11H	Analog Phaser LFC 1 Rate	0...100
00H 05H	mmH 11H	Analog Phaser LFC 1 Depth	0...100
00H 06H	mmH 11H	Analog Phaser LFC 1 Channel B Mod	0,1 = Nor,Inv
00H 07H	mmH 11H	Analog Phaser LFC 2 Rate	0...100
00H 08H	mmH 11H	Analog Phaser LFC 2 Depth	0...100
00H 09H	mmH 11H	Analog Phaser LFC 2 Channel B Mod	0,1 = Nor,Inv
00H 0AH	00H 00H	(Reserved)	
:	:		
00H 7FH	00H 00H		

Algorithm 34 Speaker Modeling

NRPN	Data Entry		
00H 00H	mmH 11H	Speaker Modeling SW	0,1 = Off,On
00H 01H	mmH 11H	Bass Cut SW	0,1 = Off,On
00H 02H	mmH 11H	Low Frequency Trimmer SW	0,1 = Off,On
00H 03H	mmH 11H	High Frequency Trimmer SW	0,1 = Off,On
00H 04H	mmH 11H	Limiters SW	0,1 = Off,On
00H 05H	mmH 11H	(Reserved)	
00H 06H	mmH 11H	Speaker Modeling Model	0...11 = THRU,FLAT,Pwd.BLK,Pwd.E-B,Pwd.MAC,SmICUBE,Wd.CONE,WHITISUE,RADIO,SmallTV,

MIDI Implementation

BoomBOX, BoomLoB		
00H 07H	mmH 11H	Speaker Modeling Phase 0,1 = NRM,INV
00H 08H	mmH 11H	Bass Cut Frequency 1,,200 = Thru,20,,2000Hz
00H 09H	mmH 11H	Low Frequency Trimmer Gain -12,,12dB
00H 0AH	mmH 11H	Low Frequency Trimmer Frequency 2,,200 = 20,,2000Hz
00H 0BH	mmH 11H	High Frequency Trimmer Gain -12,,12dB
00H 0CH	mmH 11H	High Frequency Trimmer Frequency 10,,200 = 1.0,,20.0kHz
00H 0DH	mmH 11H	Limiter Threshold -60,,0dB
00H 0EH	mmH 11H	Limiter Release 0,,100
00H 0FH	mmH 11H	Limiter Level -60,,24dB
00H 10H	00H 00H	(Reserved)
:	:	:
00H 7FH	00H 00H	:

Algorithm 35 Mastering Tool Kit (FX1 Only)

NRPN	Data Entry	
00H 00H	mmH 11H	EQ SW 0,1 = Off,On
00H 01H	mmH 11H	Bass Cut SW 0,1 = Off,On
00H 02H	mmH 11H	Enhancer SW 0,1 = Off,On
00H 03H	mmH 11H	Expander SW 0,1 = Off,On
00H 04H	mmH 11H	Compressor SW 0,1 = Off,On
00H 05H	mmH 11H	Limiter SW 0,1 = Off,On
00H 06H	mmH 11H	EQ: Input Gain -24,,12dB
00H 07H	mmH 11H	EQ: Low EQ Type 0,1 = Shelving, Peaking
00H 08H	mmH 11H	EQ: Low EQ Gain -12,,12dB
00H 09H	mmH 11H	EQ: Low EQ Frequency 2,,42 = 20,,2000Hz(*1 Frequency Table)
00H 0AH	mmH 11H	EQ: Low EQ Q 0,,31 = 0.3,,16.0(*2 Q Table)
00H 0BH	mmH 11H	EQ: Low Mid EQ Gain -12,,12dB
00H 0CH	mmH 11H	EQ: Low Mid EQ Frequency 2,,54 = 20,,8000Hz(*1 Frequency Table)
00H 0DH	mmH 11H	EQ: Low Mid EQ Q 0,,31 = 0.3,,16.0(*2 Q Table)
00H 0EH	mmH 11H	EQ: High Mid EQ Gain -12,,12dB
00H 0FH	mmH 11H	EQ: High Mid EQ Frequency 2,,54 = 20,,8000Hz(*1 Frequency Table)
00H 10H	mmH 11H	EQ: High Mid EQ Q 0,,31 = 0.3,,16.0(*2 Q Table)
00H 11H	mmH 11H	EQ: High EQ Type 0,1 = Shelving, Peaking
00H 12H	mmH 11H	EQ: High EQ Gain -12,,12dB
00H 13H	mmH 11H	EQ: High EQ Frequency 39,,62 = 1.4,,20.0kHz(*1 Frequency Table)
00H 14H	mmH 11H	EQ: High EQ Q 0,,31 = 0.3,,16.0(*2 Q Table)
00H 15H	mmH 11H	EQ: Level -24,,12dB
00H 16H	mmH 11H	Bass Cut Frequency 1,,42 = Off,20,,2000Hz(*1 Frequency Table)
00H 17H	mmH 11H	Enhancer Sens 0,,100

00H 18H	mmH 11H	Enhancer Frequency 36,,55 = 1.0,,10.0kHz(*1 Frequency Table)
00H 19H	mmH 11H	Enhancer Mix Level -24,,12dB
00H 1AH	mmH 11H	Input Gain -24,,12dB
00H 1BH	mmH 11H	Input Detect Time 0,,10ms
00H 1CH	mmH 11H	Input Low Split Point 2,,34 = 20,,800Hz(*1 Frequency Table)
00H 1DH	mmH 11H	Input High Split Point 46,,60 = 1.6,,16.0kHz(*1 Frequency Table)
00H 1EH	mmH 11H	Expander Low Threshold 0,,80 = -80,,0dB
00H 1FH	mmH 11H	Expander Mid Threshold 0,,80 = -80,,0dB
00H 20H	mmH 11H	Expander High Threshold 0,,80 = -80,,0dB
00H 21H	mmH 11H	Expander Low Ratio 0,,13 = 1:1.0,,1:INF(*3 Ratio Table)
00H 22H	mmH 11H	Expander Mid Ratio 0,,13 = 1:1.0,,1:INF(*3 Ratio Table)
00H 23H	mmH 11H	Expander High Ratio 0,,13 = 1:1.0,,1:INF(*3 Ratio Table)
00H 24H	mmH 11H	Expander Low Attack 0,,100ms
00H 25H	mmH 11H	Expander Mid Attack 0,,100ms
00H 26H	mmH 11H	Expander High Attack 0,,100ms
00H 27H	mmH 11H	Expander Low Release 0,,100 = 50,,5000ms
00H 28H	mmH 11H	Expander Mid Release 0,,100 = 50,,5000ms
00H 29H	mmH 11H	Expander High Release 0,,100 = 50,,5000ms
00H 2AH	mmH 11H	Compressor Low Threshold -24,,0dB
00H 2BH	mmH 11H	Compressor Mid Threshold -24,,0dB
00H 2CH	mmH 11H	Compressor High Threshold -24,,0dB
00H 2DH	mmH 11H	Compressor Low Ratio 0,,13 = 1:1.0,,1:INF(*3 Ratio Table)
00H 2EH	mmH 11H	Compressor Mid Ratio 0,,13 = 1:1.0,,1:INF(*3 Ratio Table)
00H 2FH	mmH 11H	Compressor High Ratio 0,,13 = 1:1.0,,1:INF(*3 Ratio Table)
00H 30H	mmH 11H	Compressor Low Attack 0,,100ms
00H 31H	mmH 11H	Compressor Mid Attack 0,,100ms
00H 32H	mmH 11H	Compressor High Attack 0,,100ms
00H 33H	mmH 11H	Compressor Low Release 0,,100 = 50,,5000ms
00H 34H	mmH 11H	Compressor Mid Release 0,,100 = 50,,5000ms
00H 35H	mmH 11H	Compressor High Release 0,,100 = 50,,5000ms
00H 36H	mmH 11H	Mixer Low Level 0,,86 = -80,,6dB
00H 37H	mmH 11H	Mixer Mid Level 0,,86 = -80,,6dB
00H 38H	mmH 11H	Mixer High Level 0,,86 = -80,,6dB
00H 39H	mmH 11H	Limiter Threshold -24,,0dB
00H 3AH	mmH 11H	Limiter Attack 0,,100ms
00H 3BH	mmH 11H	Limiter Release 0,,100 = 50,,5000ms
00H 3CH	mmH 11H	Output Level 0,,86 = -80,,6dB
00H 3DH	mmH 11H	Output Soft Clip 0,1 = Off,On

00H 3EH	mmH 11H	Output Dither	0...17 = Off, 24...8Bit
00H 3FH	00H 00H	(Reserved)	
00H 7FH	00H 00H		

1 Frequency Table

Data	Freq(Hz)	Data	Freq(Hz)	Data	Freq(Hz)	Data	Freq(Hz)
0	THRU	16	100	32	630	48	4.00k
1	20.0	17	112	33	710	49	4.50k
2	22.4	18	125	34	800	50	5.00k
3	25.0	19	140	35	900	51	5.60k
4	28.0	20	160	36	1.00k	52	6.30k
5	31.5	21	180	37	1.12k	53	7.10k
6	35.5	22	200	38	1.25k	54	8.00k
7	40.0	23	224	39	1.40k	55	9.00k
8	45.0	24	250	40	1.60k	56	10.0k
9	50.0	25	280	41	1.80k	57	11.2k
10	56.0	26	315	42	2.00k	58	12.5k
11	63.0	27	355	43	2.24k	59	14.0k
12	71.0	28	400	44	2.50k	60	16.0k
13	80.0	29	450	45	2.80k	61	18.0k
14	90.0	30	500	46	3.15k	62	20.0k
15		31	560	47	3.55k	63	22.4k

2 Q Table

Data	Q	Data	Q
0	0.3	16	2.8
1	0.4	17	3.1
2	0.5	18	3.5
3	0.6	19	4.0
4	0.7	20	4.5
5	0.8	21	5.0
6	0.9	22	5.6
7	1.0	23	6.3
8	1.1	24	7.1
9	1.2	25	8.0
10	1.4	26	9.0
11	1.6	27	10.0
12	1.8	28	11.2
13	2.0	29	12.5
14	2.2	30	14.0
15	2.5	31	16.0

3 Ratio Table

Data	RATIO
0	1:1.0 (OFF)
1	1:1.1
2	1:1.2
3	1:1.4
4	1:1.6
5	1:1.8
6	1:2.0
7	1:2.5
8	1:3.1
9	1:4.0
10	1:5.6
11	1:8.0
12	1:16
13	1:INF

Program Change

Work as program change for the effects when MIDI channel number is set to 0H or 1H.
Work as scene switch when channel number is set to EH.
VS-890 never transmits this message.

Status	Second
CnH	ppH

n = MIDI channel number: 0H - 1H (0 - 1) 0 = FX1 1 = FX2
FH (15) 15 = Scene Memory (*)
pp = program number: 00H - 63H (0 - 99) n = 0H, 1H
pp = program number: 00H - 07H (0 - 7) n = FH

(*) If received while VS-890 is playing, playback stops, and then restarts after the scene switched. Never receives while recording.

Pitch Bend Range

Receives when effect algorithm 27(Voice Transformer) is selected and MIDI Control SW is On.

Status	Second	Third
EnH	llH	mmH

n = MIDI channel number: 0H - 1H (ch.1-ch.2)
n = 0 (ch.1):Voice Transformer: Chromatic Pitch
n = 1 (ch.2):Voice Transformer: Chromatic Formant
mm,ll = value: 00H,00H - 40H,00H - 7FH,7FH (-8192 - 0 - -8191)

System Common Messages

MIDI Time Code Quarter Frame Messages

MIDI Time Code Quarter Frame Messages can be transmitted while the VS-890 is running (Playing or Recording) if the SYSTEM parameter "SynSource" is "INT" and "SynGen." is "MTC" in the SYSTEM parameter. The transmitted time counts are summed to "SMPTE(MTC) Offset Time" as the song top is "00:00:00:00."
The VS-890 synchronizes with the time counts which are summed to "SMPTE (MTC) Offset Time" as the song top is "00:00:00:00" if the SYSTEM parameter "SynSource" is "EXT."

Status	Second
F1H	mmH (= 0nnndddd)

nnn = Message type: 0 = Frame count LS nibble
1 = Frame count MS nibble
2 = Seconds count LS nibble
3 = Seconds count MS nibble
4 = Minutes count LS nibble
5 = Minutes count MS nibble
6 = Hours count LS nibble
7 = Hours count MS nibble

dddd = 4 bit nibble data: 0h - FH (0 - 15)

Bit Field is assigned as follows.

Frame Count	xxxxxyyy	Reserved (000)
	xxx	Frame No.(0-29)
	yyyyy	
Seconds Count	xxxxxyyy	Reserved (00)
	xx	Seconds (0-59)
	yyyyyy	
Minutes Count	xxxxxyyy	Reserved (00)
	xx	Minutes (0-59)
	yyyyyy	
Hours Count	xyzzzzz	Reserved (0)
	x	Time Code type
	yy	
	0 = 24 Frames / Sec	
	1 = 25 Frames / Sec	
	2 = 30 Frames / Sec (Drop Frame)	
	3 = 30 Frames / Sec (Non Drop Frame)	
	zzzzz	Hours (0-23)

Song Position Pointer

The current position is transmitted by the Song Position Pointer Message before the VS-890 starts to run and after the locate operation when "SynSource" is "INT" and "SynGen." is "MIDIcl" or "SynTr."

Status	Second	Third
F2H	mmH	nnH

mm, nn = Song Position Point: 00H 00H - 7FH 7FH

System Realtime Message

Transmitted when "SynSource" is "INT" and "SynGen." is "MIDIcl" or "SynTr."

Timing Clock

Status
F8H

MIDI Implementation

●Start

Status
FAH

●Continue

Status
FBH

●Stop

Status
FCH

■System Exclusive Message

Status	Data Bytes	Status
F0H	iiH, ddH, ..., eeH	F7H

Byte	Description
F0H	Status of Exclusive Message
iiH	Manufacture ID
41H	Roland's Manufacture ID
7EH	Universal Non Realtime Message
7FH	Universal Realtime Message
ddH	Data : 00H - 7FH (0-127)
:	:
eeH	Data
F7H	EOX (End of Exclusive Message)

The VS-890 can transfer and receive the internal parameters information using exclusive messages, and also can be controlled by the external devices using exclusive messages. The VS-890 can transmit and receive Universal System Exclusive messages, Data Request(RQ1) and Data set(DS1) as the System Exclusive message.

○About Model ID

The Model ID of the VS-890 is 00H,2FH as for Data Request (RQ1) and Data set(DT1). The VS-890 also can transfer and receive 00H,14H to be compatible with the VS-880EX. The model ID of Data Request (RQ1) and Data set (DT1) transferred from the VS-890 is according to the value of SYSTEM parameter "MID:ModelID."
The VS-890 can receive both model ID's.

○About Device ID

Exclusive messages are not assigned to any particular MIDI channel. Instead, they have their own special control parameter called device ID. The Roland exclusive messages use device IDs to specify various devices. The VS-890 sends exclusive messages using the device ID 00H - 1FH, and receives the exclusive messages which device ID is same as its device ID or 7FH. The value of the device ID is the value set on the SYSTEM parameter "MID:DeviceID" minus one.

●Universal System Exclusive Message

○INQUIRY MESSAGE

Identity Request

Status	Data Bytes	Status
F0H	7EH, Dev, 06H, 01H	F7H

Byte	Description
F0H	Status of Exclusive Message
7EH	Universal System Exclusive Message Non Realtime Header
Dev	Device ID (or 7FH)
06H	General Information (sub ID #1)
01H	Identify Request (sub ID #2)
F7H	EOX (End of Exclusive Message)

The message is used to request the particular information of the VS-890.

The VS-890 does not transmit the message.

If the VS-890 received the message and the device ID of the message is same as its device ID or 7FH, the VS-890 transmits the following Identity Reply message.

Identity Reply

Status	Data Bytes	Status
F0H	7EH, Dev, 06H, 02H, 41H, mmH, mmH, 00H, 00H, 00H, 00H, ssH, ssH	F7H

Byte	Description
F0H	Status of Exclusive Message
7EH	Universal System Exclusive Message Non Realtime Header
Dev	Device ID
06H	General Information (sub ID #1)
02H	Identify Request (sub ID #2)
41H	Manufacture ID (Roland)
mmH mmH	Device Family Code (VS-890/VS-880EX)
00H 00H	Device Family No.
00H	
00H	
ssH ssH	Software Revision Level
F7H	EOX (End of Exclusive Message)

The value of the device family code is according to the value of SYSTEM parameter "MID:ModelID."

If "MID:ModelID" is "890," The value of the device family code is 2FH,01H.

If "MID:ModelID" is "88EX," The value of the device family code is 14H,01H.

MIDI Machine Control Commands

Status	Data Bytes	Status
F0H	7FH, Dev, 06H, aaH, ..., bbH	F7H

Byte	Description
F0H	Status of Exclusive Message
7FH	Universal System Exclusive Message Realtime Header
Dev	Device ID (or 7FH)
06H	MMC Command Message
aaH	Command
:	:
bbH	Command
F7H	EOX (End of Exclusive Message)

(*) see "3. MIDI Machine Control" section

MIDI Machine Control Responses

Status	Data Bytes	Status
F0H	7FH, Dev, 07H, aaH, ..., bbH	F7H

Byte	Description
F0H	Status of Exclusive Message
7FH	Universal System Exclusive Message Realtime Header
Dev	Device ID
07H	MMC Response Message
aaH	Response
:	:
bbH	Response
F7H	EOX (End of Exclusive Message)

(*) see "3. MIDI Machine Control" section

●Data Transfer (RQ1, DT1)

○Data Request (RQ1)

Status	Data Bytes	Status
F0H	41H, Dev, mmH, mmH, 11H, aaH, bbH, ccH, ssH, ssH, ssH, Sum	F7H

Byte	Description
F0H	Status of Exclusive Message
41H	Manufacture ID (Roland)
Dev	Device ID
mmH,mmH	Model ID (VS-890/VS-880EX)
11H	Command ID (RQ1)
aaH	Address MSB
bbH	Address
ccH	Address LSB
ssH	Size MSB
ssH	Size
ssH	Size LSB
Sum	Check Sum
F7H	EOX (End of Exclusive Message)

The message is used to request data to the VS-890.
 The VS-890 does not transmit the message.
 The VS-890 transmits the requested data using Data Set(DT1) under following condition when it received the message.

1. The requested address correspond to the specified parameter base address of the VS-890.
2. The requested size is over 1 byte.

○Data Set (DT1)

Status	Data Bytes	Status
F0H	41H,Dev,mmH,mmH,12H,Sum aaH,bbH,ccH,ddH, ..., eeH	F7H

Byte	Description
F0H	Status of Exclusive Message
41H	Manufacture ID (Roland)
Dev	Device ID
mmH,mmH	Model ID (VS-890/VS-880EX)
12H	Command ID (DT1)
aaH	Address MSB
bbH	Address
ccH	Address LSB
ddH	Data
:	:
eeH	Data
Sum	Check Sum
F7H	EOX (End of Exclusive Message)

The message is received under the following condition.

If the device ID on the message is same as that of the receive device, and the address on the message correspond to the specified parameter base address, the received data are stored from the specified parameter base address.
 If the interval of received messages is shorter than 25 msec, the VS-890 cannot work the receive message procedure correctly.

The message is transmitted under the following condition.

When the VS-890 transmit the data on the requested parameter after receiving the Data Request message (RQ1).

* see "2. Data Transfer Address Map" for more details of the transfer parameters.

2. Data Transfer Address Map

Address are expressed in 7 - bit hexadecimal values.

Address	MSB	LSB
Binary 7 Bit Hex	0aaa aaaa AA	0bbb bbbb BB cccc cccc CC

■Parameter Address Block

< Model ID = 00H,2FH >

Start address	Contents and remarks
00 00 00	System Parameter
01 00 00	Song Parameter
02 00 00	Mixer Parameter
03 00 00	Locate Parameter
04 00 00	FX Parameter
05 00 00	Remote Operation
06 00 00	(Reserved)
07 00 00	
08 00 00	Sync Track Data
09 00 00	
0A 00 00	
0B 00 00	
0C 00 00	
0D 00 00	
0E 00 00	
0F 00 00	
10 00 00	Disk Access
11 00 00	
12 00 00	
13 00 00	
14 00 00	
15 00 00 - 7F 7F 7F	Undefined (Reserved)

●System Parameter

Start address	Data	Contents and remarks
00 00 00	0aaaaaaa	SMPTE(NTC) Offset Time
00 00 01#	0bbbbbbb	aaaaaaaaaaaaaaaaaaaaaaaaaaaa =
00 00 02#	0ccccccc	0...26#435455block (block=16sample)
00 00 03#	0ddddddd	
00 00 04	0aaaaaaa	Vari Pitch
00 00 05#	0bbbbbbb	48kHz -236...22 (21.96...50.43kHz)
00 00 06#	0ccccccc	44.1kHz -197...57 (22.05...50.49kHz)
00 00 07#	0ddddddd	32kHz -91...167 (21.96...50.43kHz)
00 00 08	0aaaaaaa	(Reserved)
00 00 09#	0bbbbbbb	
00 00 0A	00 - 01	Vari Pitch Switch Off,On
00 00 0B	00 - 01	Marker Stop Switch Off,On
00 00 0C	00 - 05	Fade Length 2,10,20,30,40,50mS
00 00 0D	0A - 64	Preview Length 1.0...10.0S
00 00 0E	00 - 05	Foot Switch Assign Play/Stop,Record, TapMarker,Next,Previous,GPI
00 00 0F	00 - 02	Metronome Out Mode Off,INT,MIDI
00 00 10	00 - 01	Metronome Out Type REConly,AnyTime
00 00 11	00 - 02	Master Clock DIN1,INT,DIN2
00 00 12	00 - 1F	MIDI System Exclusive Device ID (*1) 1...32
00 00 13	00 - 01	MIDI OUT/THRU Switch (*1) Out,Thru
00 00 14	00 - 01	MIDI System Exclusive RX Switch (*1) Off,On
00 00 15	00 - 01	MIDI System Exclusive TX Switch (*1) Off,On
00 00 16	00 - 0F	MIDI Metronome Channel 1...16
00 00 17	0C - 7F	MIDI Metronome Accent Note 12...127
00 00 18	01 - 7F	MIDI Metronome Accent Velocity 1...127
00 00 19	0C - 7F	MIDI Metronome Normal Note 12...127
00 00 1A	01 - 7F	MIDI Metronome Normal Velocity 1...127

MIDI Implementation

MIDI Implementation

00 00 1B	00 - 01	MIDI Mixer Control Local Switch	Off, On
00 00 1C	00 - 02	MIDI Mixer Control Type	Off, C.C., Ekcl
00 00 1D	00 - 0A	Sync. Error Level	0...10
00 00 1E	00 - 01	Sync. Source	INT, EXT
00 00 1F	00 - 03	Sync. Generate	Off, MTC, MIDIClk, SyncTr
00 00 20	00 - 04	Sync. MTC Format	24, 25, 29D, 29N, 30
00 00 21	00	(Reserved)	
00 00 22	00	(Reserved)	
00 00 23	00 - 01	Recording Monitor	Auto, Source
00 00 24	00 - 01	Time Display	ABS, REL
00 00 25	00 - 7f	Internal Metronome Level	0-127
00 00 26	00 - 01	Undo Message	Off, On
00 00 27	00	(Reserved)	
00 00 28	0aaaaaa	Tempo Map-1 Tempo Map Time	
00 00 29#	0bbbbbbb		
00 00 2A#	0ccccccc		
00 00 2B#	0ddddddd		
00 00 2C	0aaaaaa	Tempo Map-1 Sync Track Time	
00 00 2D#	0bbbbbbb		
00 00 2E#	0ccccccc		
00 00 2F#	0ddddddd		
00 00 30	0aaaaaa	Tempo Map-1 Tempo	250 - 2500 = 25.0 - 250.0
00 00 31#	0bbbbbbb		
00 00 32	0aaaaaa	Tempo Map-1 Meas	1 - 999
00 00 33#	0bbbbbbb		
00 00 34	00	Tempo Map-1 Beat	0 - 31 = 1/1, 1/2, ..., 7/8, 8/8
00 00 35#	00 - 1F		
00 00 36	00	Tempo Map-1 (Reserved)	
00 00 37#	00		
00 00 38	:	Tempo Map-2 (See Tempo Map-1, 16bytes each)	
00 06 47#	:	Tempo Map-50	
00 06 48	01 - 32	Total Tempo Map Number	(*2) 1 - 50
00 06 49	00 - 4E	Scrub Loop Length	25 - 100 mS
00 06 4A	00 - 02	MHC Mode	Off, Master, Slave
00 06 4B	00 - 01	Level Meter Tx. via MIDI	Off, On
00 06 4C	01	FX Board Available	(*3) On
00 06 4D	00 - 01	Digital Output Copy Protect	Off, On
00 06 4E	00 - 01	Auto Mix Mode	Off, On
00 06 4F	00 - 01	Auto Mix Snap Shot Mode	ALL, MaskF
00 06 50	00 - 03	Display Type of Remaining Time, CapaME, CapaE, Event	
00 06 51	00 - 01	Fader Match Mode	Null, Jump
00 06 52	00 - 01	Peak Hold	Off, On
00 06 53	00 - 01	Scene Change by PG#	Off, On
00 06 54	00 - 01	FX Change by PG#	Off, On
00 06 55	00 - 01	FX Ctrl by Control Change	Off, On
00 06 56	00 - 01	V.Track Bank	A, B
00 06 57	00 - 01	Scene Mode	ALL, KeepF
00 06 58	00 - 01	Mastering Room Sw	Off, On
00 06 59	00 - 01	Mastering Status	REC, PLAY
00 06 5A	00 - 07	Mastering V-Track	VTrk1...VTrk8
00 06 5B	00 - 04	Mastering Track After Rec	0...4 = to ZERO, to Last Phrs: 0s, to Last Phrs: 2s, to Last Phrs: 4s, stay HERE
00 06 5C	00 - 01	Mastering Track Marker Add	Off, On
00 06 5D	00 - 01	Mastering Track Type	Norm, CD-R
00 06 5E	00 - 01	MIDI Model ID Select	VS-890, VS-880EX
00 06 5F	00 - 01	(Reserved)	

* The address marked by "F" are invalid. Transmit the Data Set (DT1) or Data Request (RQ1) message with the specified size to the address without "F" mark.

- (*1) These parameters are read only. The setting is a panel operation only.
- (*2) You must write to the parameter whenever you rewrite the Tempo Map Data. The calculation will be begun when to write the parameter.
- (*3) The flag shows that the FX Board exists or not. It is a read only.

●Song Parameter

Start address	Data	Contents and remarks
01 00 00	00	(Reserved)
01 00 05#	00	
01 00 06	20 - 7E	Current Song Name -1 (ASCII)
01 00 11	20 - 7E	Current Song Name -12
01 00 12	00 - 02	Current Song Sampling Frequency 48K, 44.1K, 32KHz
01 00 15	00 - 07	Current Song R-DAC Mode VSR(7), CD(4), MAS(3), MT1(0), MT2(1), LIV1(2)
01 00 14	00 - xx	Current Song Protect Off, On(=01 or 81)
01 00 15	00	(Reserved)
01 00 16	0000000a	Song List Length abbbbbbb = 1...200
01 00 17#	0bbbbbbb	
01 00 18	00 -	Song-1 (Reserved)
01 00 1D	00 -	
01 00 1E	20 - 7E	Song-1 Name -1 (ASCII)
01 00 13	20 - 7E	Song-1 Name -12
01 00 2A	00 - 02	Song-1 Sampling Frequency 48K, 44.1K, 32KHz
01 00 2B	00 - 07	Song-1 R-DAC Mode VSR(7), CD(4), MAS(3), MT1(0), MT2(1), LIV1(2)
01 00 2C	:	Song-2 (See Song-1, 20bytes each)
01 1F 37#	:	Song-200
01 1F 38	0000000a	VS-880 Song List Length abbbbbbb = 1...200
01 1F 39#	0bbbbbbb	
01 1F 3A	00 -	VS-880 Song-1 (Reserved)
01 1F 3F	00 -	
01 1F 40	20 - 7E	VS-880 Song-1 Name -1 (ASCII)
01 1F 4B	20 - 7E	VS-880 Song-1 Name -12
01 1F 4C	00 - 02	VS-880 Song-1 Sampling Frequency 48K, 44.1K, 32KHz
01 1F 4D	00 - 03	VS-880 Song-1 R-DAC Mode MAS(3), MT1(0), MT2(1), LIV1(2)
01 1F 4E	:	VS-880 Song-2 (See Song-1, 20bytes each)
01 3E 59#	:	VS-880 Song-200
01 3E 5A	0000000a	VS-880EX Song List Length abbbbbbb = 1...200
01 3E 5B#	0bbbbbbb	
01 3E 5C	00 -	VS-880EX Song-1 (Reserved)
01 3F 01	00 -	
01 3F 02	20 - 7E	VS-880EX Song-1 Name -1 (ASCII)
01 3F 0D	20 - 7E	VS-880EX Song-1 Name -12
01 3F 0E	00 - 02	VS-880EX Song-1 Sampling Frequency 48K, 44.1K, 32KHz
01 3F 0F	00 - 03	VS-880EX Song-1 R-DAC Mode MAS(3), MT1(0), MT2(1), LIV1(2)
01 3F 10	:	VS-880EX Song-2 (See Song-1, 20bytes each)
01 5D 7B#	:	VS-880EX Song-200

- (*1) The address marked by "F" are invalid. Request to Data Request (RQ1) message with the specified size to the address without "F" mark.
- (*2) Only the Data Set (DT1) message to the song name is acceptable.

●Mixer Parameter

Start address	Data	Contents and remarks
02 00 00	00 -	Track Status -1 00=SOURCE, 01=PLAY, 02=REC 40=SOURCE_MUTE, 41=PLAY_MUTE, 22=REC_SOURCE
02 00 07	00 -	Track Status -8
02 00 08	00 - 07	V.Track -1 1...8

MIDI Implementation

02 00 0F	00 - 07	V.Track -6	
02 00 10	00 -	(Reserved)	0
02 00 1F	00 -	(Reserved)	
02 00 20	00 - 7F	Track Channel ATT -1	-12,...,+12dB
02 00 27	00 - 7F	Track Channel ATT -8	
02 00 28	00 - 7F	Input Channel ATT -1	-12,...,+12dB
02 00 2F	00 - 7F	Input Channel ATT -8	
02 00 30	00 - 01	Track Channel Phase -1	Ncr,Inv
02 00 37	00 - 01	Track Channel Phase -8	
02 00 38	00 - 01	Input Channel Phase -1	Nor,Inv
02 00 3F	00 - 01	Input Channel Phase -8	
02 00 40	00 -	(Reserved)	0
02 00 4F	00 -	(Reserved)	
02 00 50	00 - 01	Track Channel EQ Switch -1	Off,On
02 00 57	00 - 01	Track Channel EQ Switch -8	
02 00 58	00 - 01	Input Channel EQ Switch -1	Off,On
02 00 5F	00 - 01	Input Channel EQ Switch -8	
02 00 60	00 - 7F	Track Channel EQ L Freq.-1	40,50,60,70,80,90,100,120,140,160,180,200,300,400,500,600,700,800,900,1K,1.1K,1.2K,1.3K,1.4K,1.5KHz
02 00 67	00 - 7F	Track Channel EQ L Freq.-8	
02 00 68	00 - 7F	Input Channel EQ L Freq.-1	40,50,60,70,80,90,100,120,140,160,180,200,300,400,500,600,700,800,900,1K,1.1K,1.2K,1.3K,1.4K,1.5KHz
02 00 6F	00 - 7F	Input Channel EQ L Freq.-8	
02 00 70	00 - 7F	Track Channel EQ L Gain -1	-12,...,+12dB
02 00 77	00 - 7F	Track Channel EQ L Gain -8	
02 00 78	00 - 7F	Input Channel EQ L Gain -1	-12,...,+12dB
02 00 7F	00 - 7F	Input Channel EQ L Gain -8	
02 01 00	00 - 7F	Track Channel EQ M Freq.-1	200,300,400,500,600,700,800,900,1K,1.1K,1.2K,1.3K,1.4K,1.5K,1.6K,1.7K,1.8K,1.9K,2K,3K,4K,5K,6K,7K,8KHz
02 01 07	00 - 7F	Track Channel EQ M Freq.-8	
02 01 08	00 - 7F	Input Channel EQ M Freq.-1	200,300,400,500,600,700,800,900,1K,1.1K,1.2K,1.3K,1.4K,1.5K,1.6K,1.7K,1.8K,1.9K,2K,3K,4K,5K,6K,7K,8KHz
02 01 0F	00 - 7F	Input Channel EQ M Freq.-8	
02 01 10	00 - 7F	Track Channel EQ M Gain -1	-12,...,+12dB
02 01 17	00 - 7F	Track Channel EQ M Gain -8	
02 01 18	00 - 7F	Input Channel EQ M Gain -1	-12,...,+12dB
02 01 1F	00 - 7F	Input Channel EQ M Gain -8	
02 01 20	00 - 7F	Track Channel EQ M Q -1	0.5,1,2,4,8,16
02 01 27	00 - 7F	Track Channel EQ M Q -8	
02 01 28	00 - 7F	Input Channel EQ M Q -1	0.5,1,2,4,8,16
02 01 2F	00 - 7F	Input Channel EQ M Q -8	
02 01 30	00 - 7F	Track Channel EQ H Freq.-1	500,600,700,800,900,1K,1.2K,1.4K,1.6K,1.8K,2K,3K,4K,5K,6K,7K,8K,9K,10K,11K,12K,13K,14K,16K,18KHz
02 01 37	00 - 7F	Track Channel EQ H Freq.-8	
02 01 38	00 - 7F	Input Channel EQ H Freq.-1	500,600,700,800,900,1K,1.2K,1.4K,1.6K,1.8K,2K,3K,4K,5K,6K,7K,8K,9K,10K,11K,12K,13K,14K,16K,18KHz
02 01 3F	00 - 7F	Input Channel EQ H Freq.-8	
02 01 40	00 - 7F	Track Channel EQ H Gain -1	-12,...,+12dB
02 01 47	00 - 7F	Track Channel EQ H Gain -8	
02 01 48	00 - 7F	Input Channel EQ H Gain -1	-12,...,+12dB
02 01 4F	00 - 7F	Input Channel EQ H Gain -8	
02 01 50	00 - 04	Track Channel FX1 Insert Switch -1	

02 01 57	00 - 04	Track Channel FX1 Insert Switch -8	
02 01 58	00 - 04	Input Channel FX1 Insert Switch -1	Off,Ins,Insl,InsR,InsS
02 01 5F	00 - 04	Input Channel FX1 Insert Switch -8	
02 01 60	00 - 7F	Track Channel FX1 Insert Send Level -1	0,...,127
02 01 67	00 - 7F	Track Channel FX1 Insert Send Level -8	
02 01 68	00 - 7F	Input Channel FX1 Insert Send Level -1	0,...,127
02 01 6F	00 - 7F	Input Channel FX1 Insert Send Level -8	
02 01 70	00 - 7F	Track Channel FX1 Insert Return Level -1	0,...,127
02 01 77	00 - 7F	Track Channel FX1 Insert Return Level -8	
02 01 78	00 - 7F	Input Channel FX1 Insert Return Level -1	0,...,127
02 01 7F	00 - 7F	Input Channel FX1 Insert Return Level -8	
02 02 00	00 - 04	Track Channel FX2 Insert Switch -1	Off,Ins,Insl,InsR,InsS
02 02 07	00 - 04	Track Channel FX2 Insert Switch -8	
02 02 08	00 - 04	Input Channel FX2 Insert Switch -1	Off,Ins,Insl,InsR,InsS
02 02 0F	00 - 04	Input Channel FX2 Insert Switch -8	
02 02 10	00 - 7F	Track Channel FX2 Insert Send Level -1	0,...,127
02 02 17	00 - 7F	Track Channel FX2 Insert Send Level -8	
02 02 18	00 - 7F	Input Channel FX2 Insert Send Level -1	0,...,127
02 02 1F	00 - 7F	Input Channel FX2 Insert Send Level -8	
02 02 20	00 - 7F	Track Channel FX2 Insert Return Level -1	0,...,127
02 02 27	00 - 7F	Track Channel FX2 Insert Return Level -8	
02 02 28	00 - 7F	Input Channel FX2 Insert Return Level -1	0,...,127
02 02 2F	00 - 7F	Input Channel FX2 Insert Return Level -8	
02 02 30	00 - 7F	Track Channel Level -1	0,...,127
02 02 37	00 - 7F	Track Channel Level -8	
02 02 38	00 - 7F	Input Channel Level -1	0,...,127
02 02 3F	00 - 7F	Input Channel Level -8	
02 02 40	01 - 7F	Track Channel MIX & BUS Pan -1	L63 ... R63
02 02 47	01 - 7F	Track Channel MIX & BUS Pan -8	
02 02 48	01 - 7F	Input Channel MIX & BUS Pan -1	L63 ... R63
02 02 4F	01 - 7F	Input Channel MIX & BUS Pan -8	
02 02 50	00 - 01	Track Channel MIX Switch -1	Off,On
02 02 57	00 - 01	Track Channel MIX Switch -8	
02 02 58	00 - 01	Input Channel MIX Switch -1	Off,On
02 02 5F	00 - 01	Input Channel MIX Switch -8	
02 02 60	00 - 01	Track Channel BUS Send Switch -1 -1	Off,On
02 02 67	00 - 01	Track Channel BUS Send Switch -1 -8	
02 02 68	00 - 01	Track Channel BUS Send Switch -2 -1	Off,On
02 02 6F	00 - 01	Track Channel BUS Send Switch -2 -8	
02 02 70	00 - 01	Track Channel BUS Send Switch -3 -1	Off,On
02 02 77	00 - 01	Track Channel BUS Send Switch -3 -8	
02 02 78	00 - 01	Track Channel BUS Send Switch -4 -1	Off,On
02 02 7F	00 - 01	Track Channel BUS Send Switch -4 -8	
02 03 00	00 - 01	Track Channel BUS Send Switch -5 -1	Off,On
02 03 07	00 - 01	Track Channel BUS Send Switch -5 -8	
02 03 08	00 - 01	Track Channel BUS Send Switch -6 -1	Off,On
02 03 0F	00 - 01	Track Channel BUS Send Switch -6 -8	
02 03 10	00 - 01	Track Channel BUS Send Switch -7 -1	Off,On
02 03 17	00 - 01	Track Channel BUS Send Switch -7 -8	

MIDI Implementation

02 03 18	00 - 01	Track Channel BUS Send Switch -8 -1	Off,On
02 03 1F	00 - 01	Track Channel BUS Send Switch -8 -8	
02 03 20	00 - 01	Input Channel BUS Send Switch -1 -1	Off,On
02 03 27	00 - 01	Input Channel BUS Send Switch -1 -8	
02 03 28	00 - 01	Input Channel BUS Send Switch -2 -1	Off,On
02 03 2F	00 - 01	Input Channel BUS Send Switch -2 -8	
02 03 30	00 - 01	Input Channel BUS Send Switch -3 -1	Off,On
02 03 37	00 - 01	Input Channel BUS Send Switch -3 -8	
02 03 38	00 - 01	Input Channel BUS Send Switch -4 -1	Off,On
02 03 3F	00 - 01	Input Channel BUS Send Switch -4 -8	
02 03 40	00 - 01	Input Channel BUS Send Switch -5 -1	Off,On
02 03 47	00 - 01	Input Channel BUS Send Switch -5 -8	
02 03 48	00 - 01	Input Channel BUS Send Switch -6 -1	Off,On
02 03 4F	00 - 01	Input Channel BUS Send Switch -6 -8	
02 03 50	00 - 01	Input Channel BUS Send Switch -7 -1	Off,On
02 03 57	00 - 01	Input Channel BUS Send Switch -7 -8	
02 03 58	00 - 01	Input Channel BUS Send Switch -8 -1	Off,On
02 03 5F	00 - 01	Input Channel BUS Send Switch -8 -8	
02 03 60	00 - 02	Track Channel AUX Switch -1	Off,Pre,Post
02 03 67	00 - 02	Track Channel AUX Switch -8	
02 03 68	00 - 02	Input Channel AUX Switch -1	Off,Pre,Post
02 03 6F	00 - 02	Input Channel AUX Switch -8	
02 03 70	00 - 7F	Track Channel AUX Level -1	0,,,127
02 03 77	00 - 7F	Track Channel AUX Level -8	
02 03 78	00 - 7F	Input Channel AUX Level -1	0,,,127
02 03 7F	00 - 7F	Input Channel AUX Level -8	
02 04 00	01 - 7F	Track Channel AUX Pan -1	L63,,,R63
02 04 07	01 - 7F	Track Channel AUX Pan -8	
02 04 08	01 - 7F	Input Channel AUX Pan -1	L63,,,R63
02 04 0F	01 - 7F	Input Channel AUX Pan -8	
02 04 10	00 - 02	Track Channel FX1 Switch -1	Off,Pre,Post
02 04 17	00 - 02	Track Channel FX1 Switch -8	
02 04 18	00 - 02	Input Channel FX1 Switch -1	Off,Pre,Post
02 04 1F	00 - 02	Input Channel FX1 Switch -8	
02 04 20	00 - 7F	Track Channel FX1 Level -1	0,,,127
02 04 27	00 - 7F	Track Channel FX1 Level -8	
02 04 28	00 - 7F	Input Channel FX1 Level -1	0,,,127
02 04 2F	00 - 7F	Input Channel FX1 Level -8	
02 04 30	01 - 7F	Track Channel FX1 Pan -1	L63,,,R63
02 04 37	01 - 7F	Track Channel FX1 Pan -8	
02 04 38	01 - 7F	Input Channel FX1 Pan -1	L63,,,R63
02 04 3F	01 - 7F	Input Channel FX1 Pan -8	
02 04 40	00 - 02	Track Channel FX2 Switch -1	Off,Pre,Post
02 04 47	00 - 02	Track Channel FX2 Switch -8	
02 04 48	00 - 02	Input Channel FX2 Switch -1	Off,Pre,Post
02 04 4F	00 - 02	Input Channel FX2 Switch -8	
02 04 50	00 - 7F	Track Channel FX2 Level -1	0,,,127
02 04 57	00 - 7F	Track Channel FX2 Level -8	
02 04 58	00 - 7F	Input Channel FX2 Level -1	0,,,127
02 04 5F	00 - 7F	Input Channel FX2 Level -8	
02 04 60	01 - 7F	Track Channel FX2 Pan -1	L63,,,R63

02 04 67	01 - 7F	Track Channel FX2 Pan -8	
02 04 68	01 - 7F	Input Channel FX2 Pan -1	L63,,,R63
02 04 6F	01 - 7F	Input Channel FX2 Pan -8	
02 04 70	00 -	(Reserved)	0
02 04 7F	00 -	(Reserved)	
02 05 00	00 - 01	Track Channel Solo Switch -1	Off,On
02 05 07	00 - 01	Track Channel Solo Switch -8	
02 05 08	00 - 01	Input Channel Solo Switch -1	Off,On
02 05 0F	00 - 01	Input Channel Solo Switch -8	
02 05 10	00 - 01	Track Channel Mute Switch -1	Off,On
02 05 17	00 - 01	Track Channel Mute Switch -8	
02 05 18	00 - 01	Input Channel Mute Switch -1	Off,On
02 05 1F	00 - 01	Input Channel Mute Switch -8	
02 05 20	00 - 01	Track Channel Link Switch -1	Off,On
02 05 27	00 - 01	Track Channel Link Switch -8	
02 05 28	00 - 01	Input Channel Link Switch -1	Off,On
02 05 2F	00 - 01	Input Channel Link Switch -8	
02 05 30	00 - 01	Track Channel Fader Link Switch -1	Off,On
02 05 37	00 - 01	Track Channel Fader Link Switch -8	
02 05 38	00 - 01	Input Channel Fader Link Switch -1	Off,On
02 05 3F	00 - 01	Input Channel Fader Link Switch -8	
02 05 40	00 - 7F	Track Channel Offset Level -a	0,,,127
02 05 43	00 - 7F	Track Channel Offset Level -d	
02 05 44	00 - 7F	Input Channel Offset Level -a	0,,,127
02 05 47	00 - 7F	Input Channel Offset Level -d	
02 05 48	00 - 7F	Track Channel Offset Pan -a	L63,,,R63
02 05 4B	00 - 7F	Track Channel Offset Pan -d	
02 05 4C	00 - 7F	Input Channel Offset Pan -a	L63,,,R63
02 05 4F	00 - 7F	Input Channel Offset Pan -d	
02 05 50	00 -	(Reserved)	
02 05 57	00 -	(Reserved)	
02 05 58	00 - 04	Stereo In Select	Off,Input12,Input34,Input56,DigitalIn
02 05 59	00 - 7F	Stereo In Level	0,,,127
02 05 5A	01 - 7F	Stereo In Balance	L63,,,R63
02 05 5B	00 - 01	Stereo In Bus Send Switch -1	Off,On
02 05 62	00 - 01	Stereo In Bus Send Switch -8	
02 05 63	00 - 01	Stereo In Solo Switch	Off,On
02 05 64	00 - 01	Stereo In Mute Switch	Off,On
02 05 65	00 - 01	(Reserved)	
02 05 66	00 - 7F	FX1 Return Level	0,,,127
02 05 67	01 - 7F	FX1 Return Balance	L63,,,R63
02 05 68	00 - 01	FX1 Return Bus Send Switch -1	Off,On
02 05 6F	00 - 01	FX1 Return Bus Send Switch -8	
02 05 70	00 - 01	FX1 Return Solo Switch	Off,On
02 05 71	00 - 01	FX1 Return Mute Switch	Off,On
02 05 72	00 -	(Reserved)	
02 05 73	00 - 7F	FX2 Return Level	0,,,127
02 05 74	01 - 7F	FX2 Return Balance	L63,,,R63
02 05 75	00 - 01	FX2 Return Bus Send Switch -1	Off,On
02 05 7C	00 - 01	FX2 Return Bus Send Switch -8	
02 05 7D	00 - 01	FX2 Return Solo Switch	Off,On
02 05 7E	00 - 01	FX2 Return Mute Switch	Off,On
02 05 7F	00 - 02	(Reserved)	

02 06 00	0C - 01	FX1 Master Insert Sw	Off,Ins
02 06 01	0C - 7F	FX1 Master Send Level	0...127
02 06 02	0C - 7F	FX1 Master Return Level	0...127
02 06 03	00 - 01	FX2 Master Insert Sw	Off,Ins
02 06 04	00 - 7F	FX2 Master Send Level	0...127
02 06 05	00 - 7F	FX2 Master Return Level	0...127
02 06 06	0C - 7F	Master Out Level	0...127
02 06 07	01 - 7F	Master Out Balance	L63...R63
02 06 08	00 - 7F	Master AUX Send Level	0...127
02 06 09	01 - 7F	Master AUX Send Balance	L63...R63
02 06 0A	00 - 7F	Master FX1 Send Level	0...127
02 06 0B	01 - 7F	Master FX1 Send Balance	L63...R63
02 06 0C	00 - 7F	Master FX2 Send Level	0...127
02 06 0D	01 - 7F	Master FX2 Send Balance	L63...R63
02 06 0E	00 -	(Reserved)	
02 06 0F	00 - 04	Master Select	MIX, AUX, FX1, FX2, REC
02 06 10	00 - 02	AUX Output Select	AUX, FX1, FX2,
02 06 11	00 - 03	Digital 1 Output Select	Master, AUX, FX1, FX2 or 1-2, 3-4, 5-6, 7-8
02 06 12	00 - 03	Digital 2 Output Select	Master, AUX, FX1, FX2 or 1-2, 3-4, 5-6, 7-8
02 06 13	00 - 02	Direct Output Switch	Off, 1-4, 5-8
02 06 14	00 - 01	EQ Mode	2Band, 3Band

Locate parameter

Start address	Data	Contents and remarks
03 00 00	0aaaaaaa	LOCATE-1 (*1)
03 00 01#	0bbbbbbb	aaaaaaabbbbbccccccccdddddd =
03 00 02#	0ccccccc	0...268435455block (1block=16sample)
03 00 03#	0ddddddd	
03 00 04	0aaaaaaa	LOCATE-2 (*1)
03 00 05#	0bbbbbbb	aaaaaaabbbbbccccccccdddddd =
03 00 06#	0ccccccc	0...268435455block (1block=16sample)
03 00 07#	0ddddddd	
03 00 08	0aaaaaaa	LOCATE-3 (*1)
03 00 09#	0bbbbbbb	aaaaaaabbbbbccccccccdddddd =
03 00 0A#	0ccccccc	0...268435455block (1block=16sample)
03 00 0B#	0ddddddd	
03 00 0C	0aaaaaaa	LOCATE-4 (*1)
03 00 0D#	0bbbbbbb	aaaaaaabbbbbccccccccdddddd =
03 00 0E#	0ccccccc	0...268435455block (1block=16sample)
03 00 0F#	0ddddddd	
03 00 10	0aaaaaaa	LOCATE-5 (*1)
03 00 11#	0bbbbbbb	aaaaaaabbbbbccccccccdddddd =
03 00 12#	0ccccccc	0...268435455block (1block=16sample)
03 00 13#	0ddddddd	
03 00 14	0aaaaaaa	LOCATE-6 (*1)
03 00 15#	0bbbbbbb	aaaaaaabbbbbccccccccdddddd =
03 00 16#	0ccccccc	0...268435455block (1block=16sample)
03 00 17#	0ddddddd	
03 00 18	0aaaaaaa	LOCATE-7 (*1)
03 00 19#	0bbbbbbb	aaaaaaabbbbbccccccccdddddd =
03 00 1A#	0ccccccc	0...268435455block (1block=16sample)
03 00 1B#	0ddddddd	
03 00 1C	0aaaaaaa	LOCATE-8 (*1)
03 00 1D#	0bbbbbbb	aaaaaaabbbbbccccccccdddddd =
03 00 1E#	0ccccccc	0...268435455block (1block=16sample)
03 00 1F#	0ddddddd	
03 00 20	0aaaaaaa	Loop Start Point (*1,2)
03 00 21#	0bbbbbbb	aaaaaaabbbbbccccccccdddddd =
03 00 22#	0ccccccc	0...268435455block (1block=16sample)
03 00 23#	0ddddddd	
03 00 24	0aaaaaaa	Loop End Point (*1,2)
03 00 25#	0bbbbbbb	aaaaaaabbbbbccccccccdddddd =
03 00 26#	0ccccccc	0...268435455block (1block=16sample)
03 00 27#	0ddddddd	
03 00 28	0aaaaaaa	Punch In Point (*1,2)
03 00 29#	0bbbbbbb	aaaaaaabbbbbccccccccdddddd =
03 00 2A#	0ccccccc	0...268435455block (1block=16sample)
03 00 2B#	0ddddddd	
03 00 2C	0aaaaaaa	Punch Out Point (*1,2)
03 00 2D#	0bbbbbbb	aaaaaaabbbbbccccccccdddddd =
03 00 2E#	0ccccccc	0...268435455block (1block=16sample)
03 00 2F#	0ddddddd	

03 01 00	0aaaaaaa	Marker Time or Marker Number (*1,3)
03 01 01#	0bbbbbbb	aaaaaaabbbbbccccccccdddddd =
03 01 02#	0ccccccc	0...268435455block (1block=16sample)
03 01 03#	0ddddddd	or 0...999 Marker Number, >=1000 All
03 01 04	00 - 04	Marker Locator Command 00=Marker Read (*3) 01=Marker Write (*3) 02=Marker Clear (*3) 03 = Set Locate Bank (*4) 04 = Set Locate Bank (*4)
03 01 05	00 - 01	Marker Category 00=Normal 01=Automix Snapshot 02=Automix Realtime 03=CD-R Index

- (*) The address marked by "#" are invalid. Transmit the Data Set (DT1) or Data Request (RQ1) message with the specified size to the address without "#" mark.
- (*) Time parameters are set to the relocated time(REL) that the time of song top is "00:00:00:00."
- (*) The VS-890 treats the 16 samples as 1 block for managing internal time. Pay attention to the expression of the internal time changes respond to the sampling frequency of each song. And time parameter cannot be set to over 24 hours.

Example 1) Set the time 00:01:00:00 (30 Non-Drop)

Sampling Frequency is 48 kHz :
2880000 sample = 180000 block = 00 0A 7E 20 (7bit Hex)

Sampling Frequency is 44.1 kHz :
2646000 sample = 165375 block = 00 0A 0B 7F (7bit Hex)

Sampling Frequency is 32 kHz :
1920000 sample = 120000 block = 00 07 29 40 (7bit Hex)

Example 2) Set the time 23:59:59:29 (30 Non-Drop)

Sampling Frequency is 48 kHz :
4147198400 sample = 259199900 block = 7B 4C 27 1C (7bit Hex)

Sampling Frequency is 44.1 kHz :
3810238530 sample = 238139908 block = 71 46 74 04 (7bit Hex)

Sampling Frequency is 32 kHz :
2764798933 sample = 172999933 block = 52 32 6F 3D (7bit Hex)

- (*) The Loop Start point must be before the Loop Stop point. The Auto Punch In point must be before the Auto Punch Out point. If the interval of each point is shorter than 1 sec, the VS-890 does not work correctly.
- (*) Read/Write/Erase of the Mark points are done by writing operation mode to the Marker command. Set the value of the Marker Time and Marker Number, before setting the value of the Marker command.

Example 1) Delete all mark points (DeviceID = 10)

(HOST) => F0 41 10 00 14 12 03 01 00 7F 7F 7F 7A F7 => (VS-890)
(HOST) => F0 41 10 00 14 12 03 01 04 02 74 F7 => (VS-890)
(HOST) <= F0 41 10 00 14 12 03 01 00 00 00 00 00 ss F7 <= (VS-890)

The return value "00000000" is a sum of mark points.

Example 2) Write the mark point (DeviceID = 10)

(HOST) => F0 41 10 00 14 12 03 01 00 aa aa aa ss F7 => (VS-890)
aaaaaaa = time of Marker
(HOST) => F0 41 10 00 14 12 03 01 04 01 75 F7 => (VS-890)
(HOST) <= F0 41 10 00 14 12 03 01 00 nn nn nn nn ss F7 <= (VS-890)
nnnn = total marker number, ss = check sum

If the total of mark point is over 1000, the VS-890 ignores the writing and returns the total numbers of the mark points.
If the mark point already exists 0.1 msec near the new mark point, the VS-890 ignores the writing and returns the total numbers of the mark points.

Example 3) Read the mark point #3 (DeviceID = 10)

(HOST) => F0 41 10 00 14 12 03 01 00 00 00 03 75 F7 => (VS-890)
(HOST) => F0 41 10 00 14 12 03 01 04 00 76 F7 => (VS-890)
(HOST) <= F0 41 10 00 14 12 03 01 00 nn nn nn nn ss F7 <= (VS-890)
nnnnnnnn = total marker number, ss = check sum
(HOST) <= F0 41 10 00 14 12 03 01 00 aa aa aa ss F7 <= (VS-890)
aaaaaaa = time of Marker #3

MIDI Implementation

If the mark point is less than 3, the VS-890 does not return the block of "aaaaaaa."

Example 4) Read all mark points (DeviceID = 10)

```
(HOST) => F0 41 10 00 14 12 03 01 00 7F 7F 7F 7A F7 => (VS-890)
7F7F7F7F(>= 1000) means All marker
(HOST) => F0 41 10 00 14 12 03 01 04 00 76 F7 => (VS-890)
(HOST) <= F0 41 10 00 14 12 03 01 00 nn nn nn ss F7 <= (VS-890)
nnnnnnnn = total marker number, ss = check sum
(HOST) <= F0 41 10 00 14 12 03 01 00 aa aa aa ss F7 <= (VS-890)
aaaaaaa = time of Marker #1
(HOST) <= F0 41 10 00 14 12 03 01 00 bb bb bb ss F7 <= (VS-890)
bbbbbbb = time of Marker #2
:
(HOST) <= F0 41 10 00 14 12 03 01 00 xx xx xx ss F7 <= (VS-890)
xxxxxxx = time of the last Marker#
```

If the mark point does not exist, the VS-890 does not return blocks under "aaaaaaa."

Example 5) Delete the mark point (DeviceID = 10)

```
(HOST) => F0 41 10 00 14 12 03 01 00 aa aa aa ss F7 => (VS-890)
aaaaaaa = time of Marker
(HOST) => F0 41 10 00 14 12 03 01 04 02 74 F7 => (VS-890)
(HOST) <= F0 41 10 00 14 12 03 01 00 nn nn nn ss F7 <= (VS-890)
nnnn = total marker number, ss = check sum
```

The VS-890 deletes the mark point which includes specified time, and returns the total numbers of the mark points.

(*4) Write Locate data into a bank memory (Set Locate Bank), and read from a bank memory (Get Locate Bank), according to the Locate Bank number (0-3) set in Marker Number.

FX parameters

Basic Address

Start address	Contents and remarks	
04 00 00	0aaaaaaa	FX1 Algorithm aaaaaaabbcbbbb =
04 00 01#	0bbbbbbb	{ 0:Reverb *1) 1:Delay 2:Stereo Delay Chorus 3:Stereo Pitch Shifter Delay 4:Vocoder 5:2ch RSS 6:Delay RSS 7:Chorus RSS 8:Guitar Multi 1 9:Guitar Multi 2 10:Guitar Multi 3 11:Vocal Multi 12:Rotary 13:Guitar Amp Simulator 14:Stereo Phaser 15:Stereo Flanger 16:Dual Comp/Limiter (17:Gate Reverb *1) 18:Multi Tap Delay 19:Stereo Multi 20:Reverb 2 21:Space Chorus 22:Lo-Fi Processor 23:4Band Parametric Equalizer 24:10Band Graphic Equalizer 25:Hum Canceler 26:Vocal Canceler (27:Voice Transformer *1,*2) (28:Vocoder 2 *1,*2) 29:Mic Simulator 30:3Band Isolator 31:Tape Echo 201 32:Analog Flanger 33:Analog Phaser
04 00 02	20 - 7E	FX1 Name -1 (ASCII)
04 00 0D	20 - 7E	FX1 Name -12
04 00 CE	00 - 7F	FX1 Parameter Area (See Below)
04 00 7F	00 - 7F	
04 01 00	0aaaaaaa	FX2 Algorithm aaaaaaabbcbbbb =
04 01 01#	0bbbbbbb	{ 0:Reverb *1) 1:Delay 2:Stereo Delay Chorus 3:Stereo Pitch Shifter Delay

4:Vocoder	5:2ch RSS	6:Delay RSS	7:Chorus RSS	8:Guitar Multi 1	9:Guitar Multi 2	10:Guitar Multi 3	11:Vocal Multi	12:Rotary	13:Guitar Amp Simulator	14:Stereo Phaser	15:Stereo Flanger	16:Dual Comp/Limiter	17:Gate Reverb *1)	18:Multi Tap Delay	19:Stereo Multi	20:Reverb 2	21:Space Chorus	22:Lo-Fi Processor	23:4Band Parametric Equalizer	24:10Band Graphic Equalizer	25:Hum Canceler	26:Vocal Canceler	27:Voice Transformer *1,*2)	28:Vocoder 2 *1,*2)	29:Mic Simulator	30:3Band Isolator	31:Tape Echo 201	32:Analog Flanger	33:Analog Phaser
04 01 02	20 - 7E	FX2 Name -1	(ASCII)																										
04 01 0D	20 - 7E	FX2 Name -12																											
04 01 0E	1C - 7E	FX2 Parameter Area (See Below)																											
04 01 7F	20 - 7E																												

(*1) cannot select "0:Reverb," "17:Gate Reverb," "27:Voice Transformer" or "28:Vocoder2" on FX2.

(*2) If 27:Voice Transformer or 28:Vocoder2 is selected at FX1, FX2 is invalid.

(*) Two same parameters exist with two system Effects.

(*) A meaning of the parameter area changes correspond with the top of parameter of FX Algorithm. See the following tables. The address shows at FX1.

(*) If select the different Algorithm type from current one, all parameters will be copied from the preset patch data which selected Algorithm.

Algorithm 0 Reverb (FX1 Only)

04 00 0E	0aaaaaaa	EQ SW	
04 00 0F#	0bbbbbbb		0,1 = Off, On
04 00 10	0aaaaaaa	EQ: Low EQ Type	0,1 = Shelving, Peaking
04 00 11#	0bbbbbbb		
04 00 12	0aaaaaaa	EQ: Low EQ Gain	-12...12dB
04 00 13#	0bbbbbbb		
04 00 14	0aaaaaaa	EQ: Low EQ Frequency	2...200 = 20...2000Hz
04 00 15#	0bbbbbbb		
04 00 16	0aaaaaaa	EQ: Low EQ Q	3...100 = 0.3...10.0
04 00 17#	0bbbbbbb		
04 00 18	0aaaaaaa	EQ: Mid EQ Gain	-12...12dB
04 00 19#	0bbbbbbb		
04 00 1A	0aaaaaaa	EQ: Mid EQ Frequency	20...800 = 200...8000Hz
04 00 1B#	0bbbbbbb		
04 00 1C	0aaaaaaa	EQ: Mid EQ Q	3...100 = 0.3...10.0
04 00 1D#	0bbbbbbb		
04 00 1E	0aaaaaaa	EQ: High EQ Type	0,1 = Shelving, Peaking
04 00 1F#	0bbbbbbb		
04 00 20	0aaaaaaa	EQ: High EQ Gain	-12...12dB
04 00 21#	0bbbbbbb		
04 00 22	0aaaaaaa	EQ: High EQ Frequency	14...200 = 1.4...20.0kHz
04 00 23#	0bbbbbbb		
04 00 24	0aaaaaaa	EQ: High EQ Q	3...100 = 0.3...10.0
04 00 25#	0bbbbbbb		
04 00 26	0aaaaaaa	EQ: Out Level	0...100
04 00 27#	0bbbbbbb		
04 00 28	0aaaaaaa	Reverb: Room Size	5...40m
04 00 29#	0bbbbbbb		
04 00 2A	0aaaaaaa	Reverb: Reverb Time	1...320 = 0.1...32.0s
04 00 2B#	0bbbbbbb		
04 00 2C	0aaaaaaa	Reverb: Pre Delay	0...200 = 0...200ms
04 00 2D#	0bbbbbbb		
04 00 2E	0aaaaaaa	Reverb: Diffusion	0...100
04 00 2F#	0bbbbbbb		

04 00 30	04 00 31#	0aaaaaa 0bbbbbb	Reverb: Density	0...100
04 00 32	04 00 33#	0aaaaaa 0bbbbbb	Reverb: Early Reflection Level	0...100
04 00 34	04 00 35#	0aaaaaa 0bbbbbb	Reverb: LF Damp Frequency	5...400 = 50...4000Hz
04 00 36	04 00 37#	0aaaaaa 0bbbbbb	Reverb: LF Damp Gain	-36...0dB
04 00 38	04 00 39#	0aaaaaa 0bbbbbb	Reverb: HF Damp Frequency	10...200 = 1.0...20.0kHz
04 00 3A	04 00 3B#	0aaaaaa 0bbbbbb	Reverb: HF Damp Gain	-36...0dB
04 00 3C	04 00 3D#	0aaaaaa 0bbbbbb	Reverb: HI Cut Frequency	2...200 = 0.2...20.0kHz
04 00 3E	04 00 3F#	0aaaaaa 0bbbbbb	Reverb: Effect Level	-100...100
04 00 40	04 00 41#	0aaaaaa 0bbbbbb	Reverb: Direct Level	-100...100
04 00 42	:	00	(Reserved)	
04 00 7F	:	00		

Algorithm 1 Delay

04 00 0E	04 00 0F#	0aaaaaa 0bbbbbb	Delay SW	0,1 = Off,On
04 00 10	04 00 11#	0aaaaaa 0bbbbbb	EQ SW	0,1 = Off,On
04 00 12	04 00 13#	0aaaaaa 0bbbbbb	Delay: Delay Time	0...1200ms
04 00 14	04 00 15#	0aaaaaa 0bbbbbb	Delay: Shift	-1200...1200 = L1200...R1200ms
04 00 16	04 00 17#	0aaaaaa 0bbbbbb	Delay: Lch Feedback Level	-100...100
04 00 18	04 00 19#	0aaaaaa 0bbbbbb	Delay: Rch Feedback Level	-100...100
04 00 1A	04 00 1B#	0aaaaaa 0bbbbbb	Delay: Lch Level	-100...100
04 00 1C	04 00 1D#	0aaaaaa 0bbbbbb	Delay: Rch Level	-100...100
04 00 1E	04 00 1F#	0aaaaaa 0bbbbbb	Delay: LF Damp Frequency	5...400 = 50...4000Hz
04 00 20	04 00 21#	0aaaaaa 0bbbbbb	Delay: LF Damp Gain	-36...0dB
04 00 22	04 00 23#	0aaaaaa 0bbbbbb	Delay: HF Damp Frequency	10...200 = 1.0...20.0kHz
04 00 24	04 00 25#	0aaaaaa 0bbbbbb	Delay: HF Damp Gain	-36...0dB
04 00 26	04 00 27#	0aaaaaa 0bbbbbb	Delay: Direct Level	-100...100
04 00 28	04 00 29#	0aaaaaa 0bbbbbb	EQ: Low EQ Type	0,1 = Shelving, Peaking
04 00 2A	04 00 2B#	0aaaaaa 0bbbbbb	EQ: Low EQ Gain	-12...12dB
04 00 2C	04 00 2D#	0aaaaaa 0bbbbbb	EQ: Low EQ Frequency	2...200 = 20...2000Hz
04 00 2E	04 00 2F#	0aaaaaa 0bbbbbb	EQ: Low EQ Q	3...100 = 0.3...10.0
04 00 30	04 00 31#	0aaaaaa 0bbbbbb	EQ: Mid EQ Gain	-12...12dB
04 00 32	04 00 33#	0aaaaaa 0bbbbbb	EQ: Mid EQ Frequency	20...800 = 200...8000Hz
04 00 34	04 00 35#	0aaaaaa 0bbbbbb	EQ: Mid EQ Q	3...100 = 0.3...10.0
04 00 36	04 00 37#	0aaaaaa 0bbbbbb	EQ: High EQ Type	0,1 = Shelving, Peaking
04 00 38	04 00 39#	0aaaaaa 0bbbbbb	EQ: High EQ Gain	-12...12dB
04 00 3A	04 00 3B#	0aaaaaa 0bbbbbb	EQ: High EQ Frequency	14...200 = 1.4...20.0kHz
04 00 3C	04 00 3D#	0aaaaaa 0bbbbbb	EQ: High EQ Q	3...100 = 0.3...10.0
04 00 3E	04 00 3F#	0aaaaaa 0bbbbbb	EQ: Out Level	0...100

04 00 40	:	00	(Reserved)
04 00 7F	:	00	

* (Delay Time) + (Absolute Shift) is less than 1,200

Algorithm 2 Stereo Delay Chorus

04 00 0E	04 00 0F#	0aaaaaa 0bbbbbb	Delay SW	0,1 = Off,On
04 00 10	04 00 11#	0aaaaaa 0bbbbbb	Chorus SW	0,1 = Off,On
04 00 12	04 00 13#	0aaaaaa 0bbbbbb	EQ SW	0,1 = Off,On
04 00 14	04 00 15#	0aaaaaa 0bbbbbb	Delay: Delay Time	0...500ms
04 00 16	04 00 17#	0aaaaaa 0bbbbbb	Delay: Shift	-500...500 = L500...R500ms
04 00 18	04 00 19#	0aaaaaa 0bbbbbb	Delay: Lch Feedback Level	-100...100
04 00 1A	04 00 1B#	0aaaaaa 0bbbbbb	Delay: Rch Feedback Level	-100...100
04 00 1C	04 00 1D#	0aaaaaa 0bbbbbb	Delay: Lch Cross Feedback Level	-100...100
04 00 1E	04 00 1F#	0aaaaaa 0bbbbbb	Delay: Rch Cross Feedback Level	-100...100
04 00 20	04 00 21#	0aaaaaa 0bbbbbb	Delay: Effect Level	-100...100
04 00 22	04 00 23#	0aaaaaa 0bbbbbb	Delay: Direct Level	-100...100
04 00 24	04 00 25#	0aaaaaa 0bbbbbb	Chorus: Rate	1...100 = 0.1...10.0Hz
04 00 26	04 00 27#	0aaaaaa 0bbbbbb	Chorus: Depth	0...100
04 00 28	04 00 29#	0aaaaaa 0bbbbbb	Chorus: Pre Delay	0...50ms
04 00 2A	04 00 2B#	0aaaaaa 0bbbbbb	Chorus: Effect Level	-100...100
04 00 2C	04 00 2D#	0aaaaaa 0bbbbbb	Chorus: Direct Level	-100...100
04 00 2E	04 00 2F#	0aaaaaa 0bbbbbb	Chorus: Lch Feedback Level	-100...100
04 00 30	04 00 31#	0aaaaaa 0bbbbbb	Chorus: Rch Feedback Level	-100...100
04 00 32	04 00 33#	0aaaaaa 0bbbbbb	Chorus: Lch Cross Feedback Level	-100...100
04 00 34	04 00 35#	0aaaaaa 0bbbbbb	Chorus: Rch Cross Feedback Level	-100...100
04 00 36	04 00 37#	0aaaaaa 0bbbbbb	EQ: Low EQ Type	0,1 = Shelving, Peaking
04 00 38	04 00 39#	0aaaaaa 0bbbbbb	EQ: Low EQ Gain	-12...12dB
04 00 3A	04 00 3B#	0aaaaaa 0bbbbbb	EQ: Low EQ Frequency	2...200 = 20...2000Hz
04 00 3C	04 00 3D#	0aaaaaa 0bbbbbb	EQ: Low EQ Q	3...100 = 0.3...10.0
04 00 3E	04 00 3F#	0aaaaaa 0bbbbbb	EQ: Mid EQ Gain	-12...12dB
04 00 40	04 00 41#	0aaaaaa 0bbbbbb	EQ: Mid EQ Frequency	20...800 = 200...8000Hz
04 00 42	04 00 43#	0aaaaaa 0bbbbbb	EQ: Mid EQ Q	3...100 = 0.3...10.0
04 00 44	04 00 45#	0aaaaaa 0bbbbbb	EQ: High EQ Type	0,1 = Shelving, Peaking
04 00 46	04 00 47#	0aaaaaa 0bbbbbb	EQ: High EQ Gain	-12...12dB
04 00 48	04 00 49#	0aaaaaa 0bbbbbb	EQ: High EQ Frequency	14...200 = 1.4...20.0kHz
04 00 4A	04 00 4B#	0aaaaaa 0bbbbbb	EQ: High EQ Q	3...100 = 0.3...10.0
04 00 4C	04 00 4D#	0aaaaaa 0bbbbbb	EQ: Out Level	0...100
04 00 4E	:	00	(Reserved)	
04 00 7F	:	00		

MIDI Implementation

MIDI Implementation

* (Delay Time) + (Absolute Shift) is less than 500

Algorithm 3 Stereo Pitch Shifter Delay

04 00 0E	0aaaaaaa	F.Shifter Delay SW	0.1 = Off,On
04 00 0F#	0bbbbbbb		
04 00 10	0aaaaaaa	EQ SW	0.1 = Off,On
04 00 11#	0bbbbbbb		
04 00 12	0aaaaaaa	F.Shifter Delay: Lch Chromatic Pitch	-12,,12
04 00 13#	0bbbbbbb		
04 00 14	0aaaaaaa	P.Shifter Delay: Lch Fine Pitch	-100,,100
04 00 15#	0bbbbbbb		
04 00 16	0aaaaaaa	F.Shifter Delay: Lch Pre Delay	0,,50ms
04 00 17#	0bbbbbbb		
04 00 18	0aaaaaaa	F.Shifter Delay: Lch Feedback Delay Time	0,,500ms
04 00 19#	0bbbbbbb		
04 00 1A	0aaaaaaa	F.Shifter Delay: Lch Feedback Level	-100,,100
04 00 1B#	0bbbbbbb		
04 00 1C	0aaaaaaa	F.Shifter Delay: Lch Cross Feedback Level	-100,,100
04 00 1D#	0bbbbbbb		
04 00 1E	0aaaaaaa	F.Shifter Delay: Rch Chromatic Pitch	-12,,12
04 00 1F#	0bbbbbbb		
04 00 20	0aaaaaaa	P.Shifter Delay: Rch Fine Pitch	-100,,100
04 00 21#	0bbbbbbb		
04 00 22	0aaaaaaa	F.Shifter Delay: Rch Pre Delay	0,,50ms
04 00 23#	0bbbbbbb		
04 00 24	0aaaaaaa	F.Shifter Delay: Rch Feedback Delay Time	0,,500ms
04 00 25#	0bbbbbbb		
04 00 26	0aaaaaaa	F.Shifter Delay: Rch Feedback Level	-100,,100
04 00 27#	0bbbbbbb		
04 00 28	0aaaaaaa	F.Shifter Delay: Rch Cross Feedback Level	-100,,100
04 00 29#	0bbbbbbb		
04 00 2A	0aaaaaaa	F.Shifter Delay: Effect Level	-100,,100
04 00 2B#	0bbbbbbb		
04 00 2C	0aaaaaaa	F.Shifter Delay: Direct Level	-100,,100
04 00 2D#	0bbbbbbb		
04 00 2E	0aaaaaaa	EQ: Low EQ Type	0.1 = Shelving, Peaking
04 00 2F#	0bbbbbbb		
04 00 30	0aaaaaaa	EQ: Low EQ Gain	-12,,12dB
04 00 31#	0bbbbbbb		
04 00 32	0aaaaaaa	EQ: Low EQ Frequency	2,,200 = 20,,2000Hz
04 00 33#	0bbbbbbb		
04 00 34	0aaaaaaa	EQ: Low EQ Q	3,,100 = 0.3,,10.0
04 00 35#	0bbbbbbb		
04 00 36	0aaaaaaa	EQ: Mid EQ Gain	-12,,12dB
04 00 37#	0bbbbbbb		
04 00 38	0aaaaaaa	EQ: Mid EQ Frequency	20,,800 = 200,,8000Hz
04 00 39#	0bbbbbbb		
04 00 3A	0aaaaaaa	EQ: Mid EQ Q	2,,100 = 0.3,,10.0
04 00 3B#	0bbbbbbb		
04 00 3C	0aaaaaaa	EQ: High EQ Type	0.1 = Shelving, Peaking
04 00 3D#	0bbbbbbb		
04 00 3E	0aaaaaaa	EQ: High EQ Gain	-12,,12dB
04 00 3F#	0bbbbbbb		
04 00 40	0aaaaaaa	EQ: High EQ Frequency	14,,200 = 1.4,,20.0kHz
04 00 41#	0bbbbbbb		
04 00 42	0aaaaaaa	EQ: High EQ Q	3,,100 = 0.3,,10.0
04 00 43#	0bbbbbbb		
04 00 44	0aaaaaaa	EQ: Cut Level	0,,100
04 00 45#	0bbbbbbb		
04 00 46	00	(Reserved)	
04 00 47	00		

Algorithm 4 Vocoder

04 00 0E	0aaaaaaa	Chorus SW	0.1 = Off,On
04 00 0F#	0bbbbbbb		
04 00 10	0aaaaaaa	Vocoder: Voice Character 1	0,,100
04 00 11#	0bbbbbbb		
04 00 12	0aaaaaaa	Vocoder: Voice Character 2	0,,100
04 00 13#	0bbbbbbb		

04 00 14	0aaaaaaa	Vocoder: Voice Character 3	0,,100
04 00 15#	0bbbbbbb		
04 00 16	0aaaaaaa	Vocoder: Voice Character 4	0,,100
04 00 17#	0bbbbbbb		
04 00 18	0aaaaaaa	Vocoder: Voice Character 5	0,,100
04 00 19#	0bbbbbbb		
04 00 1A	0aaaaaaa	Vocoder: Voice Character 6	0,,100
04 00 1B#	0bbbbbbb		
04 00 1C	0aaaaaaa	Vocoder: Voice Character 7	0,,100
04 00 1D#	0bbbbbbb		
04 00 1E	0aaaaaaa	Vocoder: Voice Character 8	0,,100
04 00 1F#	0bbbbbbb		
04 00 20	0aaaaaaa	Vocoder: Voice Character 9	0,,100
04 00 21#	0bbbbbbb		
04 00 22	0aaaaaaa	Vocoder: Voice Character 10	0,,100
04 00 23#	0bbbbbbb		
04 00 24	0aaaaaaa	Chorus: Rate	1,,100 = 0.1,,10.0Hz
04 00 25#	0bbbbbbb		
04 00 26	0aaaaaaa	Chorus: Depth	0,,100
04 00 27#	0bbbbbbb		
04 00 28	0aaaaaaa	Chorus: Pre Delay	0,,50ms
04 00 29#	0bbbbbbb		
04 00 2A	0aaaaaaa	Chorus: Feedback Level	-100,,100
04 00 2B#	0bbbbbbb		
04 00 2C	0aaaaaaa	Chorus: Effect Level	-100,,100
04 00 2D#	0bbbbbbb		
04 00 2E	0aaaaaaa	Chorus: Direct Level	-100,,100
04 00 2F#	0bbbbbbb		
04 00 30	00	(Reserved)	
:	:		
04 00 7F	00		

Algorithm 5 2CH RSS

04 00 0E	0aaaaaaa	2CH RSS: Ach Azimuth	-30,,30 = -180,,180
04 00 0F#	0bbbbbbb		
04 00 10	0aaaaaaa	2CH RSS: Ach Elevation	-15,,15 = -90,,90
04 00 11#	0bbbbbbb		
04 00 12	0aaaaaaa	2CH RSS: Bch Azimuth	-30,,30 = -180,,180
04 00 13#	0bbbbbbb		
04 00 14	0aaaaaaa	2CH RSS: Bch Elevation	-15,,15 = -90,,90
04 00 15#	0bbbbbbb		
04 00 16	00	(Reserved)	
:	:		
04 00 7F	00		

Algorithm 6 Delay RSS

04 00 0E	0aaaaaaa	Delay RSS: Delay Time	0,,1200ms
04 00 0F#	0bbbbbbb		
04 00 10	0aaaaaaa	Delay RSS: Shift	-1200,,1200 = L1200,,R1200ms
04 00 11#	0bbbbbbb		
04 00 12	0aaaaaaa	Delay RSS: Center Delay Time	0,,1200ms
04 00 13#	0bbbbbbb		
04 00 14	0aaaaaaa	Delay RSS: RSS Level	0,,100
04 00 15#	0bbbbbbb		
04 00 16	0aaaaaaa	Delay RSS: Center Level	0,,100
04 00 17#	0bbbbbbb		
04 00 18	0aaaaaaa	Delay RSS: Feedback Level	-100,,100
04 00 19#	0bbbbbbb		
04 00 1A	0aaaaaaa	Delay RSS: LF Damp Frequency	5,,400 = 50,,4000Hz
04 00 1B#	0bbbbbbb		
04 00 1C	0aaaaaaa	Delay RSS: LF Damp Gain	-36,,0dB
04 00 1D#	0bbbbbbb		
04 00 1E	0aaaaaaa	Delay RSS: HF Damp Frequency	10,,200 = 1.0,,20.0kHz
04 00 1F#	0bbbbbbb		
04 00 20	0aaaaaaa	Delay RSS: HF Damp Gain	-36,,0dB
04 00 21#	0bbbbbbb		
04 00 22	0aaaaaaa	Delay RSS: Effect Level	-100,,100
04 00 23#	0bbbbbbb		
04 00 24	0aaaaaaa	Delay RSS: Direct Level	-100,,100
04 00 25#	0bbbbbbb		
04 00 26	00	(Reserved)	

04 00 7F	00	
----------	----	--

Algorithm 7 Chorus RSS

04 00 0E	04 00 0F#	0aaaaaa 0bbbbbb	Chorus RSS: Chorus Rate	1,,,100 = 0.1,,,10.0Hz
04 00 10	04 00 11#	0aaaaaa 0bbbbbb	Chorus RSS: Chorus Depth	0,,,100
04 00 12	04 00 13#	0aaaaaa 0bbbbbb	Chorus RSS: Effect Level	-100,,,100
04 00 14	04 00 15#	0aaaaaa 0bbbbbb	Chorus RSS: Direct Level	-100,,,100
04 00 16	00	:	(Reserved)	
04 00 7F	00	:		

Algorithm 8, 9, 10 Common part of Guitar Multi 1, 2, 3

04 00 0E	04 00 0F#	0aaaaaa 0bbbbbb	Compressor SW	0,1 = Off,On
04 00 10	04 00 11#	0aaaaaa 0bbbbbb	Metal:Distortion/Over Drive SW	0,1 = Off,On
04 00 12	04 00 13#	0aaaaaa 0bbbbbb	Noise Suppressor SW	0,1 = Off,On
04 00 14	04 00 15#	0aaaaaa 0bbbbbb	Auto Wah SW	0,1 = Off,On
04 00 16	04 00 17#	0aaaaaa 0bbbbbb	Guitar Amp Simulator SW	0,1 = Off,On
04 00 18	04 00 19#	0aaaaaa 0bbbbbb	Flanger SW	0,1 = Off,On
04 00 1A	04 00 1B#	0aaaaaa 0bbbbbb	Delay SW	0,1 = Off,On
04 00 1C	04 00 1D#	0aaaaaa 0bbbbbb	Compressor: Attack	0,,,100
04 00 1E	04 00 1F#	0aaaaaa 0bbbbbb	Compressor: Level	0,,,100
04 00 20	04 00 21#	0aaaaaa 0bbbbbb	Compressor: Sustain	0,,,100
04 00 22	04 00 23#	0aaaaaa 0bbbbbb	Compressor: Tone	-50,,, -50
04 00 24	04 00 25#	0aaaaaa 0bbbbbb	Noise Suppressor: Threshold	0,,,100
04 00 26	04 00 27#	0aaaaaa 0bbbbbb	Noise Suppressor: Release	0,,,100
04 00 28	04 00 29#	0aaaaaa 0bbbbbb	Auto Wah: Mode	0,1 = LPF,BPF
04 00 2A	04 00 2B#	0aaaaaa 0bbbbbb	Auto Wah: Polarity	0,1 = Down,Up
04 00 2C	04 00 2D#	0aaaaaa 0bbbbbb	Auto Wah: Frequency	0,,,100
04 00 2E	04 00 2F#	0aaaaaa 0bbbbbb	Auto Wah: Level	0,,,100
04 00 30	04 00 31#	0aaaaaa 0bbbbbb	Auto Wah: Peak	0,,,100
04 00 32	04 00 33#	0aaaaaa 0bbbbbb	Auto Wah: Sens	0,,,100
04 00 34	04 00 35#	0aaaaaa 0bbbbbb	Auto Wah: Rate	1,,,100 = 0.1,,,10.0Hz
04 00 36	04 00 37#	0aaaaaa 0bbbbbb	Auto Wah: Depth	0,,,100
04 00 38	04 00 39#	0aaaaaa 0bbbbbb	Guitar Amp Simulator: Mode	0,,,3 = Small,BultIn,2Stack,3Stack
04 00 3A	04 00 3B#	0aaaaaa 0bbbbbb	Flanger: Rate	1,,,100 = 0.1,,,10.0Hz
04 00 3C	04 00 3D#	0aaaaaa 0bbbbbb	Flanger: Depth	0,,,100
04 00 3E	04 00 3F#	0aaaaaa 0bbbbbb	Flanger: Manual	0,,,100
04 00 40	04 00 41#	0aaaaaa 0bbbbbb	Flanger: Resonance	0,,,100
04 00 42	04 00 43#	0aaaaaa 0bbbbbb	Delay: Delay Time	0,,,1000ms

04 00 44	04 00 45#	0aaaaaa 0bbbbbb	Delay: Shift	-1000,,,1000 = L1000...R1000ms
04 00 46	04 00 47#	0aaaaaa 0bbbbbb	Delay: Feedback Time	0,,,1000ms
04 00 48	04 00 49#	0aaaaaa 0bbbbbb	Delay: Feedback Level	-100,,,100
04 00 4A	04 00 4B#	0aaaaaa 0bbbbbb	Delay: Effect Level	-100,,,100
04 00 4C	04 00 4D#	0aaaaaa 0bbbbbb	Delay: Direct Level	-100,,,100

* (Delay Time) + (Absolute Shift) is less than 1,000

Algorithm 8 Individual part of Guitar Multi 1

04 00 4E	04 00 4F#	0aaaaaa 0bbbbbb	Metal: Gain	0,,,100
04 00 50	04 00 51#	0aaaaaa 0bbbbbb	Metal: Level	0,,,100
04 00 52	04 00 53#	0aaaaaa 0bbbbbb	Metal: Hi Gain	-100,,,100
04 00 54	04 00 55#	0aaaaaa 0bbbbbb	Metal: Mid Gain	-100,,,100
04 00 56	04 00 57#	0aaaaaa 0bbbbbb	Metal: Lcw Gain	-100,,,100
04 00 58	00	:	(Reserved)	
04 00 7F	00	:		

Algorithm 9 Individual part of Guitar Multi 2

04 00 4E	04 00 4F#	0aaaaaa 0bbbbbb	Distortion: Gain	0,,,100
04 00 50	04 00 51#	0aaaaaa 0bbbbbb	Distortion: Level	0,,,100
04 00 52	04 00 53#	0aaaaaa 0bbbbbb	Distortion: Tone	0,,,100
04 00 54	00	:	(Reserved)	
04 00 7F	00	:		

Algorithm 10 Individual part of Guitar Multi 3

04 00 4E	04 00 4F#	0aaaaaa 0bbbbbb	Over Drive: Gain	0,,,100
04 00 50	04 00 51#	0aaaaaa 0bbbbbb	Over Drive: Level	0,,,100
04 00 52	04 00 53#	0aaaaaa 0bbbbbb	Over Drive: Tone	0,,,100
04 00 54	00	:	(Reserved)	
04 00 7F	00	:		

Algorithm 11 Vocal Multi

04 00 0E	04 00 0F#	0aaaaaa 0bbbbbb	Noise Suppressor SW	0,1 = Off,On
04 00 10	04 00 11#	0aaaaaa 0bbbbbb	Limitier/De-esser SW	0,1 = Off,On
04 00 12	04 00 13#	0aaaaaa 0bbbbbb	Enhancer SW	0,1 = Off,On
04 00 14	04 00 15#	0aaaaaa 0bbbbbb	EQ SW	0,1 = Off,On
04 00 16	04 00 17#	0aaaaaa 0bbbbbb	F.Shifter SW	0,1 = Off,On
04 00 18	04 00 19#	0aaaaaa 0bbbbbb	Delay SW	0,1 = Off,On
04 00 1A	04 00 1B#	0aaaaaa 0bbbbbb	Chorus SW	0,1 = Off,On

* The "Pre Amp Bright" is valid when "Mode" is "IC-120," "Clean Twin" or "BG Lead."

Algorithm14 Stereo Phaser

04 00 0E	0aaaaaa	Phaser SW	
04 00 0F#	0bbbbbb		0.1 = Off,On
04 00 10	0aaaaaa	EQ SW	
04 00 11#	0bbbbbb		0.1 = Off,On
04 00 12	0aaaaaa	Phaser: Mode	
04 00 13#	0bbbbbb		0,,3 = 4.8.12.16stage
04 00 14	0aaaaaa	Phaser: Rate	
04 00 15#	0bbbbbb		1,,100 = 0.1,,10.0Hz
04 00 16	0aaaaaa	Phaser: Depth	
04 00 17#	0bbbbbb		0,,100
04 00 18	0aaaaaa	Phaser: Polarity	
04 00 19#	0bbbbbb		0.1 = Inverse,Synchro
04 00 1A	0aaaaaa	Phaser: Manual	
04 00 1B#	0bbbbbb		0,,100
04 00 1C	0aaaaaa	Phaser: Resonance	
04 00 1D#	0bbbbbb		0,,100
04 00 1E	0aaaaaa	Phaser: Cross Feedback	
04 00 1F#	0bbbbbb		0,,100
04 00 20	0aaaaaa	Phaser: Effect Level	
04 00 21#	0bbbbbb		-100,,100
04 00 22	0aaaaaa	Phaser: Direct Level	
04 00 23#	0bbbbbb		-100,,100
04 00 24	0aaaaaa	EQ: Low EQ Type	
04 00 25#	0bbbbbb		0.1 = Shelving, Peaking
04 00 26	0aaaaaa	EQ: Low EQ Gain	
04 00 27#	0bbbbbb		-12,,12dB
04 00 28	0aaaaaa	EQ: Low EQ Frequency	
04 00 29#	0bbbbbb		2,,200 = 20,,2000Hz
04 00 2A	0aaaaaa	EQ: Low EQ Q	
04 00 2B#	0bbbbbb		3,,100 = 0.3,,10.0
04 00 2C	0aaaaaa	EQ: Mid EQ Gain	
04 00 2D#	0bbbbbb		-12,,12dB
04 00 2E	0aaaaaa	EQ: Mid EQ Frequency	
04 00 2F#	0bbbbbb		20,,800 = 200,,8000Hz
04 00 30	0aaaaaa	EQ: Mid EQ Q	
04 00 31#	0bbbbbb		3,,100 = 0.3,,10.0
04 00 32	0aaaaaa	EQ: High EQ Type	
04 00 33#	0bbbbbb		0.1 = Shelving, Peaking
04 00 34	0aaaaaa	EQ: High EQ Gain	
04 00 35#	0bbbbbb		-12,,12dB
04 00 36	0aaaaaa	EQ: High EQ Frequency	
04 00 37#	0bbbbbb		14,,200 = 1.4,,20.0kHz
04 00 38	0aaaaaa	EQ: High EQ Q	
04 00 39#	0bbbbbb		3,,100 = 0.3,,10.0
04 00 3A	0aaaaaa	EQ: Cut Level	
04 00 3B#	0bbbbbb		0,,100
04 00 3C	00	(Reserved)	
:	:		
04 00 3F	00		

Algorithm15 Stereo Flanger

04 00 0E	0aaaaaa	Flanger SW	
04 00 0F#	0bbbbbb		0.1 = Off,On
04 00 10	0aaaaaa	EQ SW	
04 00 11#	0bbbbbb		0.1 = Off,On
04 00 12	0aaaaaa	Flanger: Rate	
04 00 13#	0bbbbbb		1,,100 = 0.1,,10.0Hz
04 00 14	0aaaaaa	Flanger: Depth	
04 00 15#	0bbbbbb		0,,100
04 00 16	0aaaaaa	Flanger: Polarity	
04 00 17#	0bbbbbb		0.1 = Inverse,Synchro
04 00 18	0aaaaaa	Flanger: Manual	
04 00 19#	0bbbbbb		0,,100
04 00 1A	0aaaaaa	Flanger: Resonance	
04 00 1B#	0bbbbbb		0,,100
04 00 1C	0aaaaaa	Flanger: Cross Feedback Level	
04 00 1D#	0bbbbbb		0,,100
04 00 1E	0aaaaaa	Flanger: Effect Level	

04 00 1F#	0bbbbbb		-100,,100
04 00 20	0aaaaaa	Flanger: Direct Level	
04 00 21#	0bbbbbb		-100,,100
04 00 22	0aaaaaa	EQ: Low EQ Type	
04 00 23#	0bbbbbb		0.1 = Shelving, Peaking
04 00 24	0aaaaaa	EQ: Low EQ Gain	
04 00 25#	0bbbbbb		-12,,12dB
04 00 26	0aaaaaa	EQ: Low EQ Frequency	
04 00 27#	0bbbbbb		2,,200 = 20,,2000Hz
04 00 28	0aaaaaa	EQ: Low EQ Q	
04 00 29#	0bbbbbb		3,,100 = 0.3,,10.0
04 00 2A	0aaaaaa	EQ: Mid EQ Gain	
04 00 2B#	0bbbbbb		-12,,12dB
04 00 2C	0aaaaaa	EQ: Mid EQ Frequency	
04 00 2D#	0bbbbbb		20,,800 = 200,,8000Hz
04 00 2E	0aaaaaa	EQ: Mid EQ Q	
04 00 2F#	0bbbbbb		3,,100 = 0.3,,10.0
04 00 30	0aaaaaa	EQ: High EQ Type	
04 00 31#	0bbbbbb		0.1 = Shelving, Peaking
04 00 32	0aaaaaa	EQ: High EQ Gain	
04 00 33#	0bbbbbb		-12,,12dB
04 00 34	0aaaaaa	EQ: High EQ Frequency	
04 00 35#	0bbbbbb		14,,200 = 1.4,,20.0kHz
04 00 36	0aaaaaa	EQ: High EQ Q	
04 00 37#	0bbbbbb		3,,100 = 0.3,,10.0
04 00 38	0aaaaaa	EQ: Out Level	
04 00 39#	0bbbbbb		0,,100
04 00 3A	00	(Reserved)	
:	:		
04 00 3F	00		

Algorithm 16 Dual Compressor/Limiter

04 00 0E	0aaaaaa	Comp/Limit A SW	
04 00 0F#	0bbbbbb		0.1 = Off,On
04 00 10	0aaaaaa	Noise Suppressor A SW	
04 00 11#	0bbbbbb		0.1 = Off,On
04 00 12	0aaaaaa	Comp/Limit B SW	
04 00 13#	0bbbbbb		0.1 = Off,On
04 00 14	0aaaaaa	Noise Suppressor B SW	
04 00 15#	0bbbbbb		0.1 = Off,On
04 00 16	0aaaaaa	Comp/Limit A: Detect	
04 00 17#	0bbbbbb		0.1,2 = A,B,Link
04 00 18	0aaaaaa	Comp/Limit A: Level	
04 00 19#	0bbbbbb		-60,,12dB
04 00 1A	0aaaaaa	Comp/Limit A: Thresh	
04 00 1B#	0bbbbbb		-60,,0dB
04 00 1C	0aaaaaa	Comp/Limit A: Attack	
04 00 1D#	0bbbbbb		0,,100
04 00 1E	0aaaaaa	Comp/Limit A: Release	
04 00 1F#	0bbbbbb		0,,100
04 00 20	0aaaaaa	Comp/Limit A: Ratio	
04 00 21#	0bbbbbb		0,,3 = 1.5:1.2:1.4:1.100:1
04 00 22	0aaaaaa	Noise Suppressor A: Detect	
04 00 23#	0bbbbbb		0.1,2 = A,B,Link
04 00 24	0aaaaaa	Noise Suppressor A: Threshold	
04 00 25#	0bbbbbb		0,,100
04 00 26	0aaaaaa	Noise Suppressor A: Release	
04 00 27#	0bbbbbb		0,,100
04 00 28	0aaaaaa	Comp/Limit B: Detect	
04 00 29#	0bbbbbb		0.1,2 = A,B,Link
04 00 2A	0aaaaaa	Comp/Limit B: Level	
04 00 2B#	0bbbbbb		-60,,12dB
04 00 2C	0aaaaaa	Comp/Limit B: Thresh	
04 00 2D#	0bbbbbb		-60,,0dB
04 00 2E	0aaaaaa	Comp/Limit B: Attack	
04 00 2F#	0bbbbbb		0,,100
04 00 30	0aaaaaa	Comp/Limit B: Release	
04 00 31#	0bbbbbb		0,,100
04 00 32	0aaaaaa	Comp/Limit B: Ratio	
04 00 33#	0bbbbbb		0,,3 = 1.5:1.2:1.4:1.100:1
04 00 34	0aaaaaa	Noise Suppressor B: Detect	
04 00 35#	0bbbbbb		0.1,2 = A,B,Link
04 00 36	0aaaaaa	Noise Suppressor B: Threshold	
04 00 37#	0bbbbbb		0,,100

MIDI Implementation

MIDI Implementation

04 00 35	0aaaaaa	Noise Suppressor B: Release	
04 00 39#	0bbbbbbb		0...100
04 00 3A	00	(Reserved)	
04 00 7F	00		

Algorithm 17 Gate Reverb (FX1 Only)

04 00 0E	0aaaaaa	G.Reverb SW	
04 00 0F#	0bbbbbbb		0,1 = Off,On
04 00 10	0aaaaaa	EQ SW	
04 00 11#	0bbbbbbb		0,1 = Off,On
04 00 12	0aaaaaa	G.Reverb: Gate Time	
04 00 13#	0bbbbbbb		10...400ms
04 00 14	0aaaaaa	G.Reverb: Pre Delay	
04 00 15#	0bbbbbbb		0...300ms
04 00 16	0aaaaaa	G.Reverb: Effect Level	
04 00 17#	0bbbbbbb		-100...100
04 00 18	0aaaaaa	G.Reverb: Mode	
04 00 19#	0bbbbbbb	0...4 = Normal,L->R,R->L,Reverse1,Reverse2	
04 00 1A	0aaaaaa	G.Reverb: Thickness	
04 00 1B#	0bbbbbbb		0...100
04 00 1C	0aaaaaa	G.Reverb: Density	
04 00 1D#	0bbbbbbb		0...100
04 00 1E	0aaaaaa	G.Reverb: Accent Delay	
04 00 1F#	0bbbbbbb		0...200ms
04 00 20	0aaaaaa	G.Reverb: Accent Level	
04 00 21#	0bbbbbbb		0...100
04 00 22	0aaaaaa	G.Reverb: Accent Pan	
04 00 23#	0bbbbbbb		1...127 = L63...R63
04 00 24	0aaaaaa	G.Reverb: Direct Level	
04 00 25#	0bbbbbbb		-100...100
04 00 26	0aaaaaa	EQ: Low EQ Type	
04 00 27#	0bbbbbbb	0,1 = Shelving, Peaking	
04 00 28	0aaaaaa	EQ: Low EQ Gain	
04 00 29#	0bbbbbbb		-12...12dB
04 00 2A	0aaaaaa	EQ: Low EQ Frequency	
04 00 2B#	0bbbbbbb		2...200 = 20...2000Hz
04 00 2C	0aaaaaa	EQ: Low EQ Q	
04 00 2D#	0bbbbbbb		3...100 = 0.3...10.0
04 00 2E	0aaaaaa	EQ: Mid EQ Gain	
04 00 2F#	0bbbbbbb		-12...12dB
04 00 30	0aaaaaa	EQ: Mid EQ Frequency	
04 00 31#	0bbbbbbb		20...800 = 200...8000Hz
04 00 32	0aaaaaa	EQ: Mid EQ Q	
04 00 33#	0bbbbbbb		3...100 = 0.3...10.0
04 00 34	0aaaaaa	EQ: High EQ Type	
04 00 35#	0bbbbbbb	0,1 = Shelving, Peaking	
04 00 36	0aaaaaa	EQ: High EQ Gain	
04 00 37#	0bbbbbbb		-12...12dB
04 00 38	0aaaaaa	EQ: High EQ Frequency	
04 00 39#	0bbbbbbb		14...200 = 1.4...20.0kHz
04 00 3A	0aaaaaa	EQ: High EQ Q	
04 00 3B#	0bbbbbbb		3...100 = 0.3...10.0
04 00 3C	0aaaaaa	EQ: Out Level	
04 00 3D#	0bbbbbbb		0...100
04 00 3E	00	(Reserved)	
04 00 7F	00		

Algorithm 18 Multi Tap Delay

04 00 0E	0aaaaaa	EQ SW	
04 00 0F#	0bbbbbbb		0,1 = Off,On
04 00 10	0aaaaaa	M.Tap Delay: Time 1	
04 00 11#	0bbbbbbb		0...1200ms
04 00 12	0aaaaaa	M.Tap Delay: Level 1	
04 00 13#	0bbbbbbb		0...100
04 00 14	0aaaaaa	M.Tap Delay: Pan 1	
04 00 15#	0bbbbbbb		1...127 = L63...R63
04 00 16	0aaaaaa	M.Tap Delay: Time 2	
04 00 17#	0bbbbbbb		0...1200ms

04 00 18	0aaaaaa	M.Tap Delay: Level 2	
04 00 19#	0bbbbbbb		0...100
04 00 1A	0aaaaaa	M.Tap Delay: Pan 2	
04 00 1B#	0bbbbbbb		1...127 = L63...R63
04 00 1C	0aaaaaa	M.Tap Delay: Time 3	
04 00 1D#	0bbbbbbb		0...1200ms
04 00 1E	0aaaaaa	M.Tap Delay: Level 3	
04 00 1F#	0bbbbbbb		0...100
04 00 20	0aaaaaa	M.Tap Delay: Pan 3	
04 00 21#	0bbbbbbb		1...127 = L63...R63
04 00 22	0aaaaaa	M.Tap Delay: Time 4	
04 00 23#	0bbbbbbb		0...1200ms
04 00 24	0aaaaaa	M.Tap Delay: Level 4	
04 00 25#	0bbbbbbb		0...100
04 00 26	0aaaaaa	M.Tap Delay: Pan 4	
04 00 27#	0bbbbbbb		1...127 = L63...R63
04 00 28	0aaaaaa	M.Tap Delay: Time 5	
04 00 29#	0bbbbbbb		0...1200ms
04 00 2A	0aaaaaa	M.Tap Delay: Level 5	
04 00 2B#	0bbbbbbb		0...100
04 00 2C	0aaaaaa	M.Tap Delay: Pan 5	
04 00 2D#	0bbbbbbb		1...127 = L63...R63
04 00 2E	0aaaaaa	M.Tap Delay: Time 6	
04 00 2F#	0bbbbbbb		0...1200ms
04 00 30	0aaaaaa	M.Tap Delay: Level 6	
04 00 31#	0bbbbbbb		0...100
04 00 32	0aaaaaa	M.Tap Delay: Pan 6	
04 00 33#	0bbbbbbb		1...127 = L63...R63
04 00 34	0aaaaaa	M.Tap Delay: Time 7	
04 00 35#	0bbbbbbb		0...1200ms
04 00 36	0aaaaaa	M.Tap Delay: Level 7	
04 00 37#	0bbbbbbb		0...100
04 00 38	0aaaaaa	M.Tap Delay: Pan 7	
04 00 39#	0bbbbbbb		1...127 = L63...R63
04 00 3A	0aaaaaa	M.Tap Delay: Time 8	
04 00 3B#	0bbbbbbb		0...1200ms
04 00 3C	0aaaaaa	M.Tap Delay: Level 8	
04 00 3D#	0bbbbbbb		0...100
04 00 3E	0aaaaaa	M.Tap Delay: Pan 8	
04 00 3F#	0bbbbbbb		1...127 = L63...R63
04 00 40	0aaaaaa	M.Tap Delay: Time 9	
04 00 41#	0bbbbbbb		0...1200ms
04 00 42	0aaaaaa	M.Tap Delay: Level 9	
04 00 43#	0bbbbbbb		0...100
04 00 44	0aaaaaa	M.Tap Delay: Pan 9	
04 00 45#	0bbbbbbb		1...127 = L63...R63
04 00 46	0aaaaaa	M.Tap Delay: Time 10	
04 00 47#	0bbbbbbb		0...1200ms
04 00 48	0aaaaaa	M.Tap Delay: Level 10	
04 00 49#	0bbbbbbb		0...100
04 00 4A	0aaaaaa	M.Tap Delay: Pan 10	
04 00 4B#	0bbbbbbb		1...127 = L63...R63
04 00 4C	0aaaaaa	M.Tap Delay: Feedback Delay Time	
04 00 4D#	0bbbbbbb		0...1200ms
04 00 4E	0aaaaaa	M.Tap Delay: Feedback Level	
04 00 4F#	0bbbbbbb		-100...100
04 00 50	0aaaaaa	M.Tap Delay: Effect Level	
04 00 51#	0bbbbbbb		-100...100
04 00 52	0aaaaaa	M.Tap Delay: Direct Level	
04 00 53#	0bbbbbbb		-100...100
04 00 54	0aaaaaa	EQ: Low EQ Type	
04 00 55#	0bbbbbbb	0,1 = Shelving, Peaking	
04 00 56	0aaaaaa	EQ: Low EQ Gain	
04 00 57#	0bbbbbbb		-12...12dB
04 00 58	0aaaaaa	EQ: Low EQ Frequency	
04 00 59#	0bbbbbbb		2...200 = 20...2000Hz
04 00 5A	0aaaaaa	EQ: Low EQ Q	
04 00 5B#	0bbbbbbb		3...100 = 0.3...10.0
04 00 5C	0aaaaaa	EQ: Mid EQ Gain	
04 00 5D#	0bbbbbbb		-12...12dB
04 00 5E	0aaaaaa	EQ: Mid EQ Frequency	
04 00 5F#	0bbbbbbb		20...800 = 200...8000Hz
04 00 60	0aaaaaa	EQ: Mid EQ Q	
04 00 61#	0bbbbbbb		3...100 = 0.3...10.0
04 00 62	0aaaaaa	EQ: High EQ Type	
04 00 63#	0bbbbbbb	0,1 = Shelving, Peaking	
04 00 64	0aaaaaa	EQ: High EQ Gain	

MIDI Implementation

04 00 65#	0bbbbbb		-12,,12dB
04 00 66	0aaaaaaa	EQ: High EQ Frequency	
04 00 67#	0bbbbbbb		14,,200 = 1.4,,20.0kHz
04 00 68	0aaaaaaa	EQ: High EQ Q	
04 00 69#	0bbbbbbb		3,,100 = 0.3,,10.0
04 00 6A	0aaaaaaa	EQ: Out Level	
04 00 6B#	0bbbbbbb		0,,100
04 00 6C	00	(Reserved)	
:	:		
04 00 7F	00		

Algorithm 19 Stereo Multi

04 00 0E	0aaaaaaa	Noise Suppressor SW	
04 00 0F#	0bbbbbbb		0,1 = Off,On
04 00 10	0aaaaaaa	Comp/Limit SW	
04 00 11#	0bbbbbbb		0,1 = Off,On
04 00 12	0aaaaaaa	Enhancer SW	
04 00 13#	0bbbbbbb		0,1 = Off,On
04 00 14	0aaaaaaa	EQ SW	
04 00 15#	0bbbbbbb		0,1 = Off,On
04 00 16	0aaaaaaa	Noise Suppressor: Threshold	
04 00 17#	0bbbbbbb		0,,100
04 00 18	0aaaaaaa	Noise Suppressor: Release	
04 00 19#	0bbbbbbb		0,,100
04 00 1A	0aaaaaaa	Comp/Limit: Level	
04 00 1B#	0bbbbbbb		-60,,12dB
04 00 1C	0aaaaaaa	Comp/Limit: Thresh	
04 00 1D#	0bbbbbbb		-60,,0dB
04 00 1E	0aaaaaaa	Comp/Limit: Attack	
04 00 1F#	0bbbbbbb		0,,100
04 00 20	0aaaaaaa	Comp/Limit: Release	
04 00 21#	0bbbbbbb		0,,100
04 00 22	0aaaaaaa	Comp/Limit: Ratio	
04 00 23#	0bbbbbbb		0,,3 = 1.5:1.2:1.4:1.100:1
04 00 24	0aaaaaaa	Enhancer: Sens	
04 00 25#	0bbbbbbb		0,,100
04 00 26	0aaaaaaa	Enhancer: Frequency	
04 00 27#	0bbbbbbb		10,,100 = 1.0,,10.0kHz
04 00 28	0aaaaaaa	Enhancer: MIX Level	
04 00 29#	0bbbbbbb		0,,100
04 00 2A	0aaaaaaa	Enhancer: Level	
04 00 2B#	0bbbbbbb		0,,100
04 00 2C	0aaaaaaa	EQ: Low EQ Type	
04 00 2D#	0bbbbbbb		0,1 = Shelving, Peaking
04 00 2E	0aaaaaaa	EQ: Low EQ Gain	
04 00 2F#	0bbbbbbb		-12,,12dB
04 00 30	0aaaaaaa	EQ: Low EQ Frequency	
04 00 31#	0bbbbbbb		2,,200 = 20,,2000Hz
04 00 32	0aaaaaaa	EQ: Low EQ Q	
04 00 33#	0bbbbbbb		3,,100 = 0.3,,10.0
04 00 34	0aaaaaaa	EQ: Mid EQ Gain	
04 00 35#	0bbbbbbb		-12,,12dB
04 00 36	0aaaaaaa	EQ: Mid EQ Frequency	
04 00 37#	0bbbbbbb		20,,800 = 200,,8000Hz
04 00 38	0aaaaaaa	EQ: Mid EQ Q	
04 00 39#	0bbbbbbb		3,,100 = 0.3,,10.0
04 00 3A	0aaaaaaa	EQ: High EQ Type	
04 00 3B#	0bbbbbbb		0,1 = Shelving, Peaking
04 00 3C	0aaaaaaa	EQ: High EQ Gain	
04 00 3D#	0bbbbbbb		-12,,12dB
04 00 3E	0aaaaaaa	EQ: High EQ Frequency	
04 00 3F#	0bbbbbbb		14,,200 = 1.4,,20.0kHz
04 00 40	0aaaaaaa	EQ: High EQ Q	
04 00 41#	0bbbbbbb		3,,100 = 0.3,,10.0
04 00 42	0aaaaaaa	EQ: Out Level	
04 00 43#	0bbbbbbb		0,,100
04 00 44	00	(Reserved)	
:	:		
04 00 7F	00		

Algorithm 20 Reverb 2

04 00 0E	0aaaaaaa	Reverb SW	
04 00 0F#	0bbbbbbb		0,1 = Off,On
04 00 10	0aaaaaaa	EQ SW	
04 00 11#	0bbbbbbb		0,1 = Off,On
04 00 12	0aaaaaaa	Reverb 2: Reverb Type	
04 00 13#	0bbbbbbb		0,,4 = Room1,Room2,Hall1,Hall2,Plate
04 00 14	0aaaaaaa	Reverb 2: Reverb Time	
04 00 15#	0bbbbbbb		1,,100 = 0.1,,10.0sec
04 00 16	0aaaaaaa	Reverb 2: Pre Delay	
04 00 17#	0bbbbbbb		0,,200msec
04 00 18	0aaaaaaa	Reverb 2: Density	
04 00 19#	0bbbbbbb		0,,100
04 00 1A	0aaaaaaa	Reverb 2: High Pass Filter	
04 00 1B#	0bbbbbbb		1,,200 = Thru,20,,2000Hz
04 00 1C	0aaaaaaa	Reverb 2: Low Pass Filter	
04 00 1D#	0bbbbbbb		10,,201 = 1.0,,20.0kHz,Thru
04 00 1E	0aaaaaaa	Reverb 2: Effect Level	
04 00 1F#	0bbbbbbb		0,,100
04 00 20	0aaaaaaa	Reverb 2: Direct Level	
04 00 21#	0bbbbbbb		0,,100
04 00 22	0aaaaaaa	Reverb 2: Gate SW	
04 00 23#	0bbbbbbb		0,1 = Off,On
04 00 24	0aaaaaaa	Reverb 2: Gate Mode	
04 00 25#	0bbbbbbb		0,1 = Gate,Ducking
04 00 26	0aaaaaaa	Reverb 2: Gate Threshold	
04 00 27#	0bbbbbbb		0,,100
04 00 28	0aaaaaaa	Reverb 2: Gate Attack Time	
04 00 29#	0bbbbbbb		1,,100
04 00 2A	0aaaaaaa	Reverb 2: Gate Release Time	
04 00 2B#	0bbbbbbb		1,,100
04 00 2C	0aaaaaaa	Reverb 2: Gate Hold Time	
04 00 2D#	0bbbbbbb		1,,100
04 00 2E	0aaaaaaa	EQ: Low EQ Type	
04 00 2F#	0bbbbbbb		0,1 = Shelving, Peaking
04 00 30	0aaaaaaa	EQ: Low EQ Gain	
04 00 31#	0bbbbbbb		-12,,12dB
04 00 32	0aaaaaaa	EQ: Low EQ Frequency	
04 00 33#	0bbbbbbb		2,,200 = 20,,2000Hz
04 00 34	0aaaaaaa	EQ: Low EQ Q	
04 00 35#	0bbbbbbb		3,,100 = 0.3,,10.0
04 00 36	0aaaaaaa	EQ: Mid EQ Gain	
04 00 37#	0bbbbbbb		-12,,12dB
04 00 38	0aaaaaaa	EQ: Mid EQ Frequency	
04 00 39#	0bbbbbbb		20,,800 = 200,,8000Hz
04 00 3A	0aaaaaaa	EQ: Mid EQ Q	
04 00 3B#	0bbbbbbb		3,,100 = 0.3,,10.0
04 00 3C	0aaaaaaa	EQ: High EQ Type	
04 00 3D#	0bbbbbbb		0,1 = Shelving, Peaking
04 00 3E	0aaaaaaa	EQ: High EQ Gain	
04 00 3F#	0bbbbbbb		-12,,12dB
04 00 40	0aaaaaaa	EQ: High EQ Frequency	
04 00 41#	0bbbbbbb		14,,200 = 1.4,,20.0kHz
04 00 42	0aaaaaaa	EQ: High EQ Q	
04 00 43#	0bbbbbbb		3,,100 = 0.3,,10.0
04 00 44	0aaaaaaa	EQ: Out Level	
04 00 45#	0bbbbbbb		0,,100
04 00 46	00	(Reserved)	
:	:		
04 00 7F	00		

Algorithm 21 Space Chorus

04 00 0E	0aaaaaaa	Chorus SW	
04 00 0F#	0bbbbbbb		0,1 = Off,On
04 00 10	0aaaaaaa	Chorus: Input Mode	
04 00 11#	0bbbbbbb		0,1 = Mono,Stereo
04 00 12	0aaaaaaa	Chorus: Mode	
04 00 13#	0bbbbbbb		0,,6 = 1.2,3,4,1+4,2+4,3+4
04 00 14	0aaaaaaa	Chorus: Mix Balance	
04 00 15#	0bbbbbbb		0,,100
04 00 16	00	(Reserved)	
:	:		

MIDI Implementation

MIDI Implementation

04 00 7F | 00

Algorithm 22 Lo-Fi Processor

04 00 0E	0aaaaaa 0bbbbbb	Lo-Fi Processor SW	0,1 = Off,On
04 00 10	0aaaaaa 0bbbbbb	Realtime Modify Filter SW	0,1 = Off,On
04 00 12	0aaaaaa 0bbbbbb	Lo-Fi Processor: Pre Filter SW	0,1 = Off,On
04 00 14	0aaaaaa 0bbbbbb	Lo-Fi Processor: Rate	0...31 = Off,1/2...1/32
04 00 16	0aaaaaa 0bbbbbb	Lo-Fi Processor: Number of Bit	0...15 = Off,15...1bit
04 00 18	0aaaaaa 0bbbbbb	Lo-Fi Processor: Post Filter SW	0,1 = Off,On
04 00 1A	0aaaaaa 0bbbbbb	Lo-Fi Processor: Effect Level	0...100
04 00 1C	0aaaaaa 0bbbbbb	Lo-Fi Processor: Direct Level	0...100
04 00 1E	0aaaaaa 0bbbbbb	Realtime Modify Filter: Filter Type	0...2 = LFF,BPF,HFF
04 00 20	0aaaaaa 0bbbbbb	Realtime Modify Filter: Cut Off	0...100
04 00 22	0aaaaaa 0bbbbbb	Realtime Modify Filter: Resonance	0...100
04 00 24	0aaaaaa 0bbbbbb	Realtime Modify Filter: Gain	0...24dB
04 00 26	0aaaaaa 0bbbbbb	Noise Suppressor: Threshold	0...100
04 00 28	0aaaaaa 0bbbbbb	Noise Suppressor: Release	0...100
04 00 2A	00	(Reserved)	
04 00 7F	00		

Algorithm 23 4 Band Parametric EQ

04 00 0E	0aaaaaa 0bbbbbb	Parametric EQ Link SW	0,1 = Off,On
04 00 10	0aaaaaa 0bbbbbb	Parametric EQ Ach SW	0,1 = Off,On
04 00 12	0aaaaaa 0bbbbbb	Parametric EQ Bch SW	0,1 = Off,On
04 00 14	0aaaaaa 0bbbbbb	EQ Ach: Input Level	-60...12dB
04 00 16	0aaaaaa 0bbbbbb	EQ Ach: Low EQ Type	0,1 = Shelving, Peaking
04 00 18	0aaaaaa 0bbbbbb	EQ Ach: Low EQ Gain	-12...12dB
04 00 1A	0aaaaaa 0bbbbbb	EQ Ach: Low EQ Frequency	2...200 = 20...2000Hz
04 00 1C	0aaaaaa 0bbbbbb	EQ Ach: Low EQ Q	3...100 = 0.3...10.0
04 00 1E	0aaaaaa 0bbbbbb	EQ Ach: Low Mid EQ Gain	-12...12dB
04 00 20	0aaaaaa 0bbbbbb	EQ Ach: Low Mid EQ Frequency	20...800 = 200...8000Hz
04 00 22	0aaaaaa 0bbbbbb	EQ Ach: Low Mid EQ Q	3...100 = 0.3...10.0
04 00 24	0aaaaaa 0bbbbbb	EQ Ach: High Mid EQ Gain	-12...12dB
04 00 26	0aaaaaa 0bbbbbb	EQ Ach: High Mid EQ Frequency	20...800 = 200...8000Hz
04 00 28	0aaaaaa 0bbbbbb	EQ Ach: High Mid EQ Q	3...100 = 0.3...10.0
04 00 2A	0aaaaaa 0bbbbbb	EQ Ach: High EQ Type	0,1 = Shelving, Peaking
04 00 2C	0aaaaaa 0bbbbbb	EQ Ach: High EQ Gain	-12...12dB
04 00 2E	0aaaaaa 0bbbbbb	EQ Ach: High EQ Frequency	14...200 = 1.4...20.0kHz
04 00 30	0aaaaaa	EQ Ach: High EQ Q	

04 00 31#	0bbbbbb		3...100 = 0.3...10.0
04 00 32	0aaaaaa 0bbbbbb	EQ Ach: Output Level	-60...12dB
04 00 34	0aaaaaa 0bbbbbb	EQ Bch: Input Level	-60...12dB
04 00 36	0aaaaaa 0bbbbbb	EQ Bch: Low EQ Type	0,1 = Shelving, Peaking
04 00 38	0aaaaaa 0bbbbbb	EQ Bch: Low EQ Gain	-12...12dB
04 00 3A	0aaaaaa 0bbbbbb	EQ Bch: Low EQ Frequency	2...200 = 20...2000Hz
04 00 3C	0aaaaaa 0bbbbbb	EQ Bch: Low EQ Q	3...100 = 0.3...10.0
04 00 3E	0aaaaaa 0bbbbbb	EQ Bch: Low Mid EQ Gain	-12...12dB
04 00 40	0aaaaaa 0bbbbbb	EQ Bch: Low Mid EQ Frequency	20...800 = 200...8000Hz
04 00 42	0aaaaaa 0bbbbbb	EQ Bch: Low Mid EQ Q	3...100 = 0.3...10.0
04 00 44	0aaaaaa 0bbbbbb	EQ Bch: High Mid EQ Gain	-12...12dB
04 00 46	0aaaaaa 0bbbbbb	EQ Bch: High Mid EQ Frequency	20...800 = 200...8000Hz
04 00 48	0aaaaaa 0bbbbbb	EQ Bch: High Mid EQ Q	3...100 = 0.3...10.0
04 00 4A	0aaaaaa 0bbbbbb	EQ Bch: High EQ Type	0,1 = Shelving, Peaking
04 00 4C	0aaaaaa 0bbbbbb	EQ Bch: High EQ Gain	-12...12dB
04 00 4E	0aaaaaa 0bbbbbb	EQ Bch: High EQ Frequency	14...200 = 1.4...20.0kHz
04 00 50	0aaaaaa 0bbbbbb	EQ Bch: High EQ Q	3...100 = 0.3...10.0
04 00 52	0aaaaaa 0bbbbbb	EQ Bch: Output Level	-60...12dB
04 00 54	00	(Reserved)	
04 00 7F	00		

* When Link SW = On, Bch corresponds to Ach.

Algorithm 24 10 Band Graphic EQ

04 00 0E	0aaaaaa 0bbbbbb	Graphic EQ Link SW	0,1 = Off,On
04 00 10	0aaaaaa 0bbbbbb	Graphic EQ Ach SW	0,1 = Off,On
04 00 12	0aaaaaa 0bbbbbb	Graphic EQ Bch SW	0,1 = Off,On
04 00 14	0aaaaaa 0bbbbbb	EQ Ach: Input Gain	-60...12dB
04 00 16	0aaaaaa 0bbbbbb	EQ Ach: 31.25Hz Gain	-12...12dB
04 00 18	0aaaaaa 0bbbbbb	EQ Ach: 62.5Hz Gain	-12...12dB
04 00 1A	0aaaaaa 0bbbbbb	EQ Ach: 125Hz Gain	-12...12dB
04 00 1C	0aaaaaa 0bbbbbb	EQ Ach: 250Hz Gain	-12...12dB
04 00 1E	0aaaaaa 0bbbbbb	EQ Ach: 500Hz Gain	-12...12dB
04 00 20	0aaaaaa 0bbbbbb	EQ Ach: 1.0kHz Gain	-12...12dB
04 00 22	0aaaaaa 0bbbbbb	EQ Ach: 2.0kHz Gain	-12...12dB
04 00 24	0aaaaaa 0bbbbbb	EQ Ach: 4.0kHz Gain	-12...12dB
04 00 26	0aaaaaa 0bbbbbb	EQ Ach: 8.0kHz Gain	-12...12dB
04 00 28	0aaaaaa 0bbbbbb	EQ Ach: 16.0kHz Gain	-12...12dB
04 00 2A	0aaaaaa 0bbbbbb	EQ Ach: Output Level	-60...12dB
04 00 2C	0aaaaaa 0bbbbbb	EQ Bch: Input Gain	-60...12dB

MIDI Implementation

04 00 2E	0aaaaaaa	EQ Bch: 31.25Hz Gain	
04 00 2F#	0bbbbbbb		-12...12dB
04 00 30	0aaaaaaa	EQ Bch: 62.5Hz Gain	
04 00 31#	0bbbbbbb		-12...12dB
04 00 32	0aaaaaaa	EQ Bch: 125Hz Gain	
04 00 33#	0bbbbbbb		-12...12dB
04 00 34	0aaaaaaa	EQ Bch: 250Hz Gain	
04 00 35#	0bbbbbbb		-12...12dB
04 00 36	0aaaaaaa	EQ Bch: 500Hz Gain	
04 00 37#	0bbbbbbb		-12...12dB
04 00 38	0aaaaaaa	EQ Bch: 1.0kHz Gain	
04 00 39#	0bbbbbbb		-12...12dB
04 00 3A	0aaaaaaa	EQ Bch: 2.0kHz Gain	
04 00 3B#	0bbbbbbb		-12...12dB
04 00 3C	0aaaaaaa	EQ Bch: 4.0kHz Gain	
04 00 3D#	0bbbbbbb		-12...12dB
04 00 3E	0aaaaaaa	EQ Bch: 8.0kHz Gain	
04 00 3F#	0bbbbbbb		-12...12dB
04 00 40	0aaaaaaa	EQ Bch: 16.0kHz Gain	
04 00 41#	0bbbbbbb		-12...12dB
04 00 42	0aaaaaaa	EQ Bch: Output Level	
04 00 43#	0bbbbbbb		-60...12dB
04 00 44	00	(Reserved)	
:	:	:	:
04 00 7F	00		

* When Link SW = On, Bch corresponds to Ach.

Algorithm 25 Hum Canceler

04 00 0E	0aaaaaaa	Hum Canceler SW	
04 00 0F#	0bbbbbbb		0,1 = Off,On
04 00 10	0aaaaaaa	Noise Suppressor SW	
04 00 11#	0bbbbbbb		0,1 = Off,On
04 00 12	0aaaaaaa	Hum Canceler: Frequency	
04 00 13#	0bbbbbbb		200...800 = 20.0...800.0Hz
04 00 14	0aaaaaaa	Hum Canceler: Width	
04 00 15#	0bbbbbbb		10...40%
04 00 16	0aaaaaaa	Hum Canceler: Depth	
04 00 17#	0bbbbbbb		0...100
04 00 18	0aaaaaaa	Hum Canceler: Threshold	
04 00 19#	0bbbbbbb		0...100
04 00 1A	0aaaaaaa	Hum Canceler: Range Low	
04 00 1B#	0bbbbbbb		1...200 = Unlimit,20...2000Hz
04 00 1C	0aaaaaaa	Hum Canceler: Range High	
04 00 1D#	0bbbbbbb		10...201 = 1.0...20.0kHz,Unlimit
04 00 1E	0aaaaaaa	Noise Suppressor: Threshold	
04 00 1F#	0bbbbbbb		0...100
04 00 20	0aaaaaaa	Noise Suppressor: Release	
04 00 21#	0bbbbbbb		0...100
04 00 22	00	(Reserved)	
:	:	:	:
04 00 7F	00		

Algorithm 26 Vocal Canceler

04 00 0E	0aaaaaaa	Vocal Canceler SW	
04 00 0F#	0bbbbbbb		0,1 = Off,On
04 00 10	0aaaaaaa	EQ SW	
04 00 11#	0bbbbbbb		0,1 = Off,On
04 00 12	0aaaaaaa	Vocal Canceler: Balance	
04 00 13#	0bbbbbbb		0...100
04 00 14	0aaaaaaa	Vocal Canceler: Range Low	
04 00 15#	0bbbbbbb		1...200 = Unlimit,20...2000Hz
04 00 16	0aaaaaaa	Vocal Canceler: Range High	
04 00 17#	0bbbbbbb		10...201 = 1.0...20.0kHz,Unlimit
04 00 18	0aaaaaaa	EQ: Low EQ Type	
04 00 19#	0bbbbbbb		0,1 = Shelving, Peaking
04 00 1A	0aaaaaaa	EQ: Low EQ Gain	
04 00 1B#	0bbbbbbb		-12...12dB
04 00 1C	0aaaaaaa	EQ: Low EQ Frequency	
04 00 1D#	0bbbbbbb		2...200 = 20...2000Hz

04 00 1E	0aaaaaaa	EQ: Low EQ Q	
04 00 1F#	0bbbbbbb		3...100 = 0.3...10.0
04 00 20	0aaaaaaa	EQ: Mid EQ Gain	
04 00 21#	0bbbbbbb		-12...12dB
04 00 22	0aaaaaaa	EQ: Mid EQ Frequency	
04 00 23#	0bbbbbbb		20...800 = 200...8000Hz
04 00 24	0aaaaaaa	EQ: Mid EQ Q	
04 00 25#	0bbbbbbb		3...100 = 0.3...10.0
04 00 26	0aaaaaaa	EQ: High EQ Type	
04 00 27#	0bbbbbbb		0,1 = Shelving, Peaking
04 00 28	0aaaaaaa	EQ: High EQ Gain	
04 00 29#	0bbbbbbb		-12...12dB
04 00 2A	0aaaaaaa	EQ: High EQ Frequency	
04 00 2B#	0bbbbbbb		14...200 = 1.4...20.0kHz
04 00 2C	0aaaaaaa	EQ: High EQ Q	
04 00 2D#	0bbbbbbb		3...100 = 0.3...10.0
04 00 2E	0aaaaaaa	EQ: Out Level	
04 00 2F#	0bbbbbbb		0...100
04 00 30	00	(Reserved)	
:	:	:	:
04 00 7F	00		

Algorithm 27 Voice Transformer (FX1 Only)

04 00 0E	0aaaaaaa	Voice Transformer SW	
04 00 0F#	0bbbbbbb		0,1 = Off,On
04 00 10	0aaaaaaa	Reverb SW	
04 00 11#	0bbbbbbb		0,1 = Off,On
04 00 12	0aaaaaaa	Fader Edit: SW	
04 00 13#	0bbbbbbb		0,1 = Off,On
04 00 14	0aaaaaaa	MIDI Control SW	
04 00 15#	0bbbbbbb		0,1 = Off,On
04 00 16	0aaaaaaa	Voice Transformer: Robot SW	
04 00 17#	0bbbbbbb		0,1 = Off,On
04 00 18	0aaaaaaa	Voice Transformer: Chromatic Pitch	
04 00 19#	0bbbbbbb		-12...36
04 00 1A	0aaaaaaa	Voice Transformer: Fine Pitch	
04 00 1B#	0bbbbbbb		-100...100
04 00 1C	0aaaaaaa	Voice Transformer: Chromatic Formant	
04 00 1D#	0bbbbbbb		-12...12
04 00 1E	0aaaaaaa	Voice Transformer: Fine Formant	
04 00 1F#	0bbbbbbb		-100...100
04 00 20	0aaaaaaa	Voice Transformer: Mix Balance	
04 00 21#	0bbbbbbb		0...100
04 00 22	0aaaaaaa	Reverb: Reverb Time	
04 00 23#	0bbbbbbb		1...100 = 0.1...10.0sec
04 00 24	0aaaaaaa	Reverb: Pre Delay	
04 00 25#	0bbbbbbb		0...200msec
04 00 26	0aaaaaaa	Reverb: Density	
04 00 27#	0bbbbbbb		0...100
04 00 28	0aaaaaaa	Reverb: Effect Level	
04 00 29#	0bbbbbbb		0...100
04 00 2A	0aaaaaaa	MIDI Control: Bend Range	
04 00 2B#	0bbbbbbb		0...12 = Off,1...12
04 00 2C	0aaaaaaa	MIDI Control: Fortamento	
04 00 2D#	0bbbbbbb		0...100 = Off,1...100
04 00 2E	00	(Reserved)	
:	:	:	:
04 00 7F	00		

Algorithm 28 Vocoder 2 (FX1 Only)

04 00 0E	0aaaaaaa	Chorus SW	
04 00 0F#	0bbbbbbb		0,1 = Off,On
04 00 10	0aaaaaaa	Vocoder: Envelope Mode	
04 00 11#	0bbbbbbb		0...2 = Sharp,Soft,Long
04 00 12	0aaaaaaa	Vocoder: Pan Mode	
04 00 13#	0bbbbbbb		0...3 = Mono,Stereo,L>R,R->L
04 00 14	0aaaaaaa	Vocoder: Hold	
04 00 15#	0bbbbbbb		0,1 = Off,MIDI
04 00 16	0aaaaaaa	Vocoder: Mic Sens	
04 00 17#	0bbbbbbb		0...100

MIDI Implementation

MIDI Implementation

04 00 18	0aaaaaaa	Vocoder: Synth Input Level	0,,,100
04 00 19#	0bbbbbbb		
04 00 1A	0aaaaaaa	Vocoder: Voice Char Level 1	0,,,100
04 00 1B#	0bbbbbbb		
04 00 1C	0aaaaaaa	Vocoder: Voice Char Level 2	0,,,100
04 00 1D#	0bbbbbbb		
04 00 1E	0aaaaaaa	Vocoder: Voice Char Level 3	0,,,100
04 00 1F#	0bbbbbbb		
04 00 20	0aaaaaaa	Vocoder: Voice Char Level 4	0,,,100
04 00 21#	0bbbbbbb		
04 00 22	0aaaaaaa	Vocoder: Voice Char Level 5	0,,,100
04 00 23#	0bbbbbbb		
04 00 24	0aaaaaaa	Vocoder: Voice Char Level 6	0,,,100
04 00 25#	0bbbbbbb		
04 00 26	0aaaaaaa	Vocoder: Voice Char Level 7	0,,,100
04 00 27#	0bbbbbbb		
04 00 28	0aaaaaaa	Vocoder: Voice Char Level 8	0,,,100
04 00 29#	0bbbbbbb		
04 00 2A	0aaaaaaa	Vocoder: Voice Char Level 9	0,,,100
04 00 2B#	0bbbbbbb		
04 00 2C	0aaaaaaa	Vocoder: Voice Char Level 10	0,,,100
04 00 2D#	0bbbbbbb		
04 00 2E	0aaaaaaa	Vocoder: Voice Char Level 11	0,,,100
04 00 2F#	0bbbbbbb		
04 00 30	0aaaaaaa	Vocoder: Voice Char Level 12	0,,,100
04 00 31#	0bbbbbbb		
04 00 32	0aaaaaaa	Vocoder: Voice Char Level 13	0,,,100
04 00 33#	0bbbbbbb		
04 00 34	0aaaaaaa	Vocoder: Voice Char Level 14	0,,,100
04 00 35#	0bbbbbbb		
04 00 36	0aaaaaaa	Vocoder: Voice Char Level 15	0,,,100
04 00 37#	0bbbbbbb		
04 00 38	0aaaaaaa	Vocoder: Voice Char Level 16	0,,,100
04 00 39#	0bbbbbbb		
04 00 3A	0aaaaaaa	Vocoder: Voice Char Level 17	0,,,100
04 00 3B#	0bbbbbbb		
04 00 3C	0aaaaaaa	Vocoder: Voice Char Level 18	0,,,100
04 00 3D#	0bbbbbbb		
04 00 3E	0aaaaaaa	Vocoder: Voice Char Level 19	0,,,100
04 00 3F#	0bbbbbbb		
04 00 40	0aaaaaaa	Vocoder: Mic High Pass Filter	9,,,200 = Thru,1.0,,,20.0kHz
04 00 41#	0bbbbbbb		
04 00 42	0aaaaaaa	Vocoder: Mic High Pass Filter Pan	1,,,127 = L63,,,R63
04 00 43#	0bbbbbbb		
04 00 44	0aaaaaaa	Vocoder: Mic Mix	0,,,100
04 00 45#	0bbbbbbb		
04 00 46	0aaaaaaa	Vocoder: Noise Suppressor Threshold	0,,,100
04 00 47#	0bbbbbbb		
04 00 4E	0aaaaaaa	Chorus: Rate	1,,,100 = 0.1,,,10.0Hz
04 00 49#	0bbbbbbb		
04 00 4A	0aaaaaaa	Chorus: Depth	0,,,100
04 00 4B#	0bbbbbbb		
04 00 4C	0aaaaaaa	Chorus: Pre Delay	0,,,50ms
04 00 4D#	0bbbbbbb		
04 00 4E	0aaaaaaa	Chorus: Mix Balance	0,,,100
04 00 4F#	0bbbbbbb		
04 00 50	00	(Reserved)	
:	:		
04 00 7F	00		

Algorithm 29 Mic Simulator

04 00 0E	0aaaaaaa	Link SW	0.1 = Off,On
04 00 0F#	0bbbbbbb		
04 00 10	0aaaaaaa	Mic Converter Ach SW	0.1 = Off,On
04 00 11#	0bbbbbbb		
04 00 12	0aaaaaaa	Bass Cut Ach SW	0.1 = Off,On
04 00 13#	0bbbbbbb		
04 00 14	0aaaaaaa	Distance Ach SW	0.1 = Off,On
04 00 15#	0bbbbbbb		
04 00 16	0aaaaaaa	Limiter Ach SW	0.1 = Off,On
04 00 17#	0bbbbbbb		
04 00 18	0aaaaaaa	Mic Converter Bch SW	0.1 = Off,On
04 00 19#	0bbbbbbb		
04 00 1A	0aaaaaaa	Bass Cut Bch SW	

04 00 1B#	0bbbbbbb		0.1 = Off,On
04 00 1C	0aaaaaaa	Distance Bch SW	0.1 = Off,On
04 00 1D#	0bbbbbbb		
04 00 1E	0aaaaaaa	Limiter Bch SW	0.1 = Off,On
04 00 1F#	0bbbbbbb		
04 00 20	0aaaaaaa	Mic Converter Ach: Input	0,,,4 = DR-20, SmlDy, HedDy, MinCn, Flat
04 00 21#	0bbbbbbb		
04 00 22	0aaaaaaa	Mic Converter Ach: Output	0,,,6 = SmlDy, VocDy, LrgDy, SmlCn, LrgCn, VntCn, Flat
04 00 23#	0bbbbbbb		
04 00 24	0aaaaaaa	Mic Converter Ach: Phase	0,1 = Normal, Inverse
04 00 25#	0bbbbbbb		
04 00 26	0aaaaaaa	Bass Cut Ach: Bass Cut Frequency	1,,,200 = Thru,20,,,2000Hz
04 00 27#	0bbbbbbb		
04 00 28	0aaaaaaa	Distance Ach: Proximity Effect	-12,,, -12
04 00 29#	0bbbbbbb		
04 00 2A	0aaaaaaa	Distance Ach: Time	0,,,1000 = 0,,,3000cm
04 00 2B#	0bbbbbbb		
04 00 2C	0aaaaaaa	Limiter Ach: Detect HPF Frequency	1,,,200 = Thru,20,,,2000Hz
04 00 2D#	0bbbbbbb		
04 00 2E	0aaaaaaa	Limiter Ach: Level	-60,,, 24dB
04 00 2F#	0bbbbbbb		
04 00 30	0aaaaaaa	Limiter Ach: Threshold	-60,,, 0dB
04 00 31#	0bbbbbbb		
04 00 32	0aaaaaaa	Limiter Ach: Attack	0,,,100
04 00 33#	0bbbbbbb		
04 00 34	0aaaaaaa	Limiter Ach: Release	0,,,100
04 00 35#	0bbbbbbb		
04 00 36	0aaaaaaa	Mic Converter Bch: Input	0,,,4 = DR-20, SmlDy, HedDy, MinCn, Flat
04 00 37#	0bbbbbbb		
04 00 38	0aaaaaaa	Mic Converter Bch: Output	0,,,6 = SmlDy, VocDy, LrgDy, SmlCn, LrgCn, VntCn, Flat
04 00 39#	0bbbbbbb		
04 00 3A	0aaaaaaa	Mic Converter Bch: Phase	0.1 = Normal, Inverse
04 00 3B#	0bbbbbbb		
04 00 3C	0aaaaaaa	Bass Cut Bch: Bass Cut Frequency	1,,,200 = Thru,20,,,2000Hz
04 00 3D#	0bbbbbbb		
04 00 3E	0aaaaaaa	Distance Bch: Proximity Effect	-12,,, -12
04 00 3F#	0bbbbbbb		
04 00 40	0aaaaaaa	Distance Bch: Time	0,,,1000 = 0,,,3000cm
04 00 41#	0bbbbbbb		
04 00 42	0aaaaaaa	Limiter Bch: Detect HPF Frequency	1,,,200 = Thru,20,,,2000Hz
04 00 43#	0bbbbbbb		
04 00 44	0aaaaaaa	Limiter Bch: Level	-60,,, 24dB
04 00 45#	0bbbbbbb		
04 00 46	0aaaaaaa	Limiter Bch: Threshold	-60,,, 0dB
04 00 47#	0bbbbbbb		
04 00 48	0aaaaaaa	Limiter Bch: Attack	0,,,100
04 00 49#	0bbbbbbb		
04 00 4A	0aaaaaaa	Limiter Bch: Release	0,,,100
04 00 4B#	0bbbbbbb		
04 00 4C	00	(Reserved)	
:	:		
04 00 7F	00		

- * When Mic Converter Input = MinCn, Output is fixed to SmlDy or LrgCn.
- * When Link SW = On, Bch corresponds to Ach.

Algorithm 30 3 Band Isolator

04 00 0E	0aaaaaaa	Isolator SW	0.1 = Off,On
04 00 0F#	0bbbbbbb		
04 00 10	0aaaaaaa	Isolator High Volume	-60,,, +4dB
04 00 11#	0bbbbbbb		
04 00 12	0aaaaaaa	Isolator Middle Volume	-60,,, +4dB
04 00 13#	0bbbbbbb		
04 00 14	0aaaaaaa	Isolator Low Volume	-60,,, +4dB
04 00 15#	0bbbbbbb		
04 00 16	0aaaaaaa	Isolator Anti Phase Middle Switch	0.1 = Off,On
04 00 17#	0bbbbbbb		
04 00 18	0aaaaaaa	Isolator Anti Phase Middle Level	0,,,100
04 00 19#	0bbbbbbb		
04 00 1A	0aaaaaaa	Isolator Anti Phase Low Switch	0.1 = Off,On
04 00 1B#	0bbbbbbb		
04 00 1C	0aaaaaaa	Isolator Anti Phase Low Level	0,,,100
04 00 1D#	0bbbbbbb		
04 00 1E	00	(Reserved)	

04 00 7F 00

Algorithm 31 Tape Echo 201

04 00 0E	0aaaaaa	Tape Echo SW	0,1 = Off,On
04 00 0F#	0bbbbbb		
04 00 10	0aaaaaa	Tape Echo Mode Select	0...6 = 1...7
04 00 11#	0bbbbbb		
04 00 12	0aaaaaa	Tape Echo Repeat Rate	0...100
04 00 13#	0bbbbbb		
04 00 14	0aaaaaa	Tape Echo Intensity	0...100
04 00 15#	0bbbbbb		
04 00 16	0aaaaaa	Tape Echo Effect Level	0...100
04 00 17#	0bbbbbb		
04 00 18	0aaaaaa	Tape Echo Direct Level	0...100
04 00 19#	0bbbbbb		
04 00 1A	0aaaaaa	Tape Echo Tone Bass	-100...100
04 00 1B#	0bbbbbb		
04 00 1C	0aaaaaa	Tape Echo Tone Treble	-100...100
04 00 1D#	0bbbbbb		
04 00 1E	0aaaaaa	Tape Echo Tape Head S Fan	1...127 = L63...R63
04 00 1F#	0bbbbbb		
04 00 20	0aaaaaa	Tape Echo Tape Head M Fan	1...127 = L63...R63
04 00 21#	0bbbbbb		
04 00 22	0aaaaaa	Tape Echo Tape Head L Fan	1...127 = L63...R63
04 00 23#	0bbbbbb		
04 00 24	0aaaaaa	Tape Echo Tape Distortion	0...100
04 00 25#	0bbbbbb		
04 00 26	0aaaaaa	Tape Echo Wah Flutter Rate	0...100
04 00 27#	0bbbbbb		
04 00 28	0aaaaaa	Tape Echo Wah Flutter Depth	0...100
04 00 29#	0bbbbbb		
04 00 2A	00	(Reserved)	
:	:		
04 00 7F	00		

Algorithm 32 Analog Flanger

04 00 0E	0aaaaaa	Analog Flanger SW	0,1 = Off,On
04 00 0F#	0bbbbbb		
04 00 10	0aaaaaa	Analog Flanger Mode	0...3 = FL1,FL2,FL3,CHO
04 00 11#	0bbbbbb		
04 00 12	0aaaaaa	Analog Flanger Feedback	0...100
04 00 13#	0bbbbbb		
04 00 14	0aaaaaa	Analog Flanger Modulation Rate	0...100
04 00 15#	0bbbbbb		
04 00 16	0aaaaaa	Analog Flanger Modulation Depth	0...100
04 00 17#	0bbbbbb		
04 00 18	0aaaaaa	Analog Flanger Modulation Frequency	0...100
04 00 19#	0bbbbbb		
04 00 1A	0aaaaaa	Analog Flanger Channel B Modulation	0,1 = Nor,Inv
04 00 1B#	0bbbbbb		
04 00 1C	0aaaaaa	Analog Flanger Channel A Phase	0,1 = Nor,Inv
04 00 1D#	0bbbbbb		
04 00 1E	0aaaaaa	Analog Flanger Channel B Phase	0,1 = Nor,Inv
04 00 1F#	0bbbbbb		
04 00 20	00	(Reserved)	
:	:		
04 00 7F	00		

Algorithm 33 Analog Phaser

04 00 0E	0aaaaaa	Analog Phaser SW	0,1 = Off,On
04 00 0F#	0bbbbbb		
04 00 10	0aaaaaa	Analog Phaser Mode	0,1 = 4STAGE,8STAGE
04 00 11#	0bbbbbb		
04 00 12	0aaaaaa	Analog Phaser Frequency	0...100
04 00 13#	0bbbbbb		
04 00 14	0aaaaaa	Analog Phaser Resonance	0...100
04 00 15#	0bbbbbb		
04 00 16	0aaaaaa	Analog Phaser LFO 1 Rate	

04 00 17#	0bbbbbb		0...100
04 00 18	0aaaaaa	Analog Phaser LFO 1 Depth	0...100
04 00 19#	0bbbbbb		
04 00 1A	0aaaaaa	Analog Phaser LFO 1 Channel B Mod	0,1 = Nor,Inv
04 00 1B#	0bbbbbb		
04 00 1C	0aaaaaa	Analog Phaser LFO 2 Rate	0...100
04 00 1D#	0bbbbbb		
04 00 1E	0aaaaaa	Analog Phaser LFO 2 Depth	0...100
04 00 1F#	0bbbbbb		
04 00 20	0aaaaaa	Analog Phaser LFO 2 Channel B Mod	0,1 = Nor,Inv
04 00 21#	0bbbbbb		
04 00 22	00	(Reserved)	
:	:		
04 00 7F	00		

Algorithm 34 Speaker Modeling

04 00 0E	0aaaaaa	Speaker Modeling SW	0,1 = Off,On
04 00 0F#	0bbbbbb		
04 00 10	0aaaaaa	Bass Cut SW	0,1 = Off,On
04 00 11#	0bbbbbb		
04 00 12	0aaaaaa	Low Frequency Trimmer SW	0,1 = Off,On
04 00 13#	0bbbbbb		
04 00 14	0aaaaaa	High Frequency Trimmer SW	0,1 = Off,On
04 00 15#	0bbbbbb		
04 00 16	0aaaaaa	Limiter SW	0,1 = Off,On
04 00 17#	0bbbbbb		
04 00 18	0aaaaaa	(Reserved)	
04 00 19#	0bbbbbb		
04 00 1A	0aaaaaa	Speaker Modeling Model	0...11 = THRU,FLAT,Pwd.BLF,Pwd.E-B,Pwd.MAC,SMICUBE,Wh.CONE,WhTISUE,RADIO,SmallTV,BoomBOX,BoomLOP
04 00 1B#	0bbbbbb		
04 00 1C	0aaaaaa	Speaker Modeling Phase	0,1 = Nor,Inv
04 00 1D#	0bbbbbb		
04 00 1E	0aaaaaa	Bass Cut Frequency	1...200 = Thru,20...2000Hz
04 00 1F#	0bbbbbb		
04 00 20	0aaaaaa	Low Frequency Trimmer Gain	-12...12dB
04 00 21#	0bbbbbb		
04 00 22	0aaaaaa	Low Frequency Trimmer Frequency	2...200 = 20...2000Hz
04 00 23#	0bbbbbb		
04 00 24	0aaaaaa	High Frequency Trimmer Gain	-12...12dB
04 00 25#	0bbbbbb		
04 00 26	0aaaaaa	High Frequency Trimmer Frequency	10...200 = 1.0...20.0kHz
04 00 27#	0bbbbbb		
04 00 28	0aaaaaa	Limiter Threshold	-50...0dB
04 00 29#	0bbbbbb		
04 00 2A	0aaaaaa	Limiter Release	0...100
04 00 2B#	0bbbbbb		
04 00 2C	0aaaaaa	Limiter Level	-60...24dB
04 00 2D#	0bbbbbb		
04 00 2E	00	(Reserved)	
:	:		
04 00 7F	00		

Algorithm 35 Mastering Tool Kit (FX1 Only)

04 00 0E	0aaaaaa	EQ SW	0,1 = Off,On
04 00 0F#	0bbbbbb		
04 00 10	0aaaaaa	Bass Cut SW	0,1 = Off,On
04 00 11#	0bbbbbb		
04 00 12	0aaaaaa	Enhancer SW	0,1 = Off,On
04 00 13#	0bbbbbb		
04 00 14	0aaaaaa	Expander SW	0,1 = Off,On
04 00 15#	0bbbbbb		
04 00 16	0aaaaaa	Compressor SW	0,1 = Off,On
04 00 17#	0bbbbbb		
04 00 18	0aaaaaa	Limiter SW	0,1 = Off,On
04 00 19#	0bbbbbb		
04 00 1A	0aaaaaa	EQ: Input Gain	-24...12dB
04 00 1B#	0aaaaaa	EQ: Low EQ Type	0,1 = Shelving, Peaking
04 00 1C	0aaaaaa	EQ: Low EQ Gain	-12...12dB
04 00 1D#	0aaaaaa	EQ: Low EQ Frequency	2...42 = 20...2000Hz(*1)

MIDI Implementation

MIDI Implementation

04 00 1E	0aaaaaa	EQ: Low EQ Q	0,,31 = 0.3,,16.0(*2)
04 00 1F#	0aaaaaa	EQ: Low Mid EQ Gain	-12,,12dB
04 00 20	0aaaaaa	EQ: Low Mid EQ Frequency	2,,54 = 20,,8000Hz(*1)
04 00 21#	0aaaaaa	EQ: Low Mid EQ Q	0,,31 = 0.3,,16.0(*2)
04 00 22	0aaaaaa	EQ: High Mid EQ Gain	-12,,12dB
04 00 23#	0aaaaaa	EQ: High Mid EQ Frequency	2,,54 = 20,,8000Hz(*1)
04 00 24	0aaaaaa	EQ: High Mid EQ Q	0,,31 = 0.3,,16.0(*2)
04 00 25#	0aaaaaa	EQ: High EQ Type	0.1 = Shelving, Peaking
04 00 26	0aaaaaa	EQ: High EQ Gain	-12,,12dB
04 00 27#	0aaaaaa	EQ: High EQ Frequency	39,,62 = 1.4,,20.0kHz(*1)
04 00 28	0aaaaaa	EQ: High EQ Q	0,,31 = 0.3,,16.0(*2)
04 00 29#	0aaaaaa	EQ: Level	-24,,12dB
04 00 2A	0aaaaaa	Bass Cut Frequency	1,,42 = Off,20,,2000Hz(*1)
04 00 2B#	0aaaaaa	Enhancer Sens	0,,100
04 00 2C	0aaaaaa	Enhancer Frequency	36,,56 = 1.0,,10.0kHz(*1)
04 00 2D#	0aaaaaa	Enhancer Mix Level	-24,,12dB
04 00 2E	0aaaaaa	Input Gain	-24,,12dB
04 00 2F#	0aaaaaa	Input Detect Time	0,,10ms
04 00 30	0aaaaaa	Input Low Split Point	2,,34 = 20,,800Hz(*1)
04 00 31#	0aaaaaa	Input High Split Point	40,,60 = 1.6,,16.0kHz(*1)
04 00 32	0aaaaaa	Expander Low Threshold	0,,80 = -80,,0dB
04 00 33#	0aaaaaa	Expander Mid Threshold	0,,80 = -80,,0dB
04 00 34	0aaaaaa	Expander High Threshold	0,,80 = -80,,0dB
04 00 35#	0aaaaaa	Expander Low Ratio	0,,13 = 1:1.0,,1:INF(*3)
04 00 36	0aaaaaa	Expander Mid Ratio	0,,13 = 1:1.0,,1:INF(*3)
04 00 37#	0aaaaaa	Expander High Ratio	0,,13 = 1:1.0,,1:INF(*3)
04 00 38	0aaaaaa	Expander Low Attack	0,,100ms
04 00 39#	0aaaaaa	Expander Mid Attack	0,,100ms
04 00 3A	0aaaaaa	Expander High Attack	0,,100ms
04 00 3B#	0aaaaaa	Expander Low Release	0,,100 = 50,,5000ms
04 00 3C	0aaaaaa	Expander Mid Release	0,,100 = 50,,5000ms
04 00 3D#	0aaaaaa	Expander High Release	0,,100 = 50,,5000ms
04 00 3E	0aaaaaa	Compressor Low Threshold	-24,,0dB
04 00 3F#	0aaaaaa	Compressor Mid Threshold	-24,,0dB
04 00 40	0aaaaaa	Compressor High Threshold	-24,,0dB
04 00 41#	0aaaaaa	Compressor Low Ratio	0,,13 = 1:1.0,,1:INF(*3)
04 00 42	0aaaaaa	Compressor Mid Ratio	0,,13 = 1:1.0,,1:INF(*3)
04 00 43#	0aaaaaa	Compressor High Ratio	0,,13 = 1:1.0,,1:INF(*3)
04 00 44	0aaaaaa	Compressor Low Attack	0,,100ms
04 00 45#	0aaaaaa	Compressor Mid Attack	0,,100ms
04 00 46	0aaaaaa	Compressor High Attack	0,,100ms
04 00 47#	0aaaaaa	Compressor Low Release	0,,100 = 50,,5000ms
04 00 48	0aaaaaa	Compressor Mid Release	0,,100 = 50,,5000ms
04 00 49#	0aaaaaa	Compressor High Release	0,,100 = 50,,5000ms
04 00 4A	0aaaaaa	Mixer Low Level	0,,86 = -80,,6dB
04 00 4B#	0aaaaaa	Mixer Mid Level	0,,86 = -80,,6dB
04 00 4C	0aaaaaa	Mixer High Level	0,,86 = -80,,6dB
04 00 4D#	0aaaaaa	Limiter Threshold	-24,,0dB
04 00 4E	0aaaaaa	Limiter Attack	0,,100ms
04 00 4F#	0aaaaaa	Limiter Release	0,,100 = 50,,5000ms
04 00 50	0aaaaaa	Output Level	0,,86 = -80,,6dB
04 00 51#	0aaaaaa	Output Soft Clip	0.1 = Off,On
04 00 52	0aaaaaa	Output Dither	0,,17 = Off,24,,8Bit
04 00 53#	00	(Reserved)	
04 00 54	00	(Reserved)	
04 00 7F	00	(Reserved)	

Remote Operations

Start address	Data	Contents and remarks
05 00 00	00 -	Remote Command / Response
05 00 01#	00 -	Parameter
05 nn mm#	00 -	Parameter

- * The address marked by '#' are invalid. Transmit the Data Set (DT1) message with the specified size to the address without '#' mark. Data Request (RQ1) message is ignored.
- * The commands require to set simultaneously the parameter which specified size.

Remote Edit Command List

Command	Remarks
00	NOP (No Operation)
01	Abort Command
02	Track Copy
03	Track Move
04	Track Exchange
05	Track Insert
06	Track Cut
07	Track Erase
08	Track Time Comp/Exp.
09	Preview From
0A	Preview To
0B	Preview Scrub On
0C	Preview Scrub Off
0D	Request Amplitude Profile
0E	Request Wave Data
0F	Request Full Event List
10	Request Simple Event List
11	Request Number of Event List
12	Request Full Event Parameter
13	Request Simple Event Parameter
14	Name Event
15	Undo
16	Redo
17	Create Event
18	Song Select
19	Song Store
1A	Drive Select
1B	Request Drive List
1C	Shut Down

Remote Edit Response List

Response	Remarks
40	Complete (No Error)
41	Error
42	Amplitude Profile
43	Wave Data
44	Full Event List
45	Simple Event List
46	Number of Event List
47	Full Event Parameter
48	Simple Event Parameter
49	Drive List

Command 00 NOP (No operation)

Start address	Data	Contents and remarks
05 00 00	00	NOP (No Operation)

The VS-890 does not operate anything.
If the VS-890 was available to operate commands, it returns the response 40 when it receives the message. And if the VS-890 was busy (operating commands or recording), it returns the response 41.

Command 01 Abort Command

Start address	Data	Contents and remarks
05 00 00	01	Abort Command

The VS-890 aborts the current command.
If no executing command, it returns the response 40. And if the VS-890 aborted the current command, it returns the response 41.

Command 02 Track Copy

Start address	Data	Contents and remarks
05 00 00	02	Track Copy
05 00 01#	0aaaaaaa	Track Copy Start Time aaaaaaabbbbbccccccccdddddd = 0,,,268435455block (lblock=16sample)
05 00 02#	0bbbbbbb	
05 00 03#	0ccccccc	
05 00 04#	0ddddddd	
05 00 05#	0aaaaaaa	Track Copy End Time aaaaaaabbbbbccccccccdddddd = 0,,,268435455block (lblock=16sample)
05 00 06#	0bbbbbbb	
05 00 07#	0ccccccc	
05 00 08#	0ddddddd	
05 00 09#	0aaaaaaa	Track Copy From Time aaaaaaabbbbbccccccccdddddd = 0,,,268435455block (lblock=16sample)
05 00 0A#	0bbbbbbb	
05 00 0B#	0ccccccc	
05 00 0C#	0ddddddd	
05 00 0D#	0aaaaaaa	Track Copy To Time aaaaaaabbbbbccccccccdddddd = 0,,,268435455block (lblock=16sample)
05 00 0E#	0bbbbbbb	
05 00 0F#	0ccccccc	
05 00 10#	0ddddddd	
05 00 11#	01 - 63	Track Copy Time 1,,,99
05 00 12#	0aaaaaaa	The Number Of Target aaaaaabbbbb = 1,,,128
05 00 13#	0bbbbbbb	
05 00 14#	00 - 7F	Source V.Tr. V.Tr.1-A:1,,,V.Tr.8-B:8
05 00 15#	00 - 7F	
:	:	Source V.Tr. V.Tr.1-A:1,,,V.Tr.8-B:8
:	:	
05 nn mm#	00 - 7F	(nn mm = 00 13 + The Number Of Target * 2)

The VS-890 executes the Track Copy command.
If the command succeeded, it returns the response 40. And if any errors occurred, it returns the response 41.

Command 03 Track Move

Start address	Data	Contents and remarks
05 00 00	03	Track Move
05 00 01#	0aaaaaaa	Track Move Start Time aaaaaaabbbbbccccccccdddddd = 0,,,268435455block (lblock=16sample)
05 00 02#	0bbbbbbb	
05 00 03#	0ccccccc	
05 00 04#	0ddddddd	
05 00 05#	0aaaaaaa	Track Move End Time aaaaaaabbbbbccccccccdddddd = 0,,,268435455block (lblock=16sample)
05 00 06#	0bbbbbbb	
05 00 07#	0ccccccc	
05 00 08#	0ddddddd	
05 00 09#	0aaaaaaa	Track Move From Time aaaaaaabbbbbccccccccdddddd = 0,,,268435455block (lblock=16sample)
05 00 0A#	0bbbbbbb	
05 00 0B#	0ccccccc	
05 00 0C#	0ddddddd	
05 00 0D#	0aaaaaaa	Track Move To Time aaaaaaabbbbbccccccccdddddd = 0,,,268435455block (lblock=16sample)
05 00 0E#	0bbbbbbb	
05 00 0F#	0ccccccc	
05 00 10#	0ddddddd	
05 00 11#	0aaaaaaa	The Number Of Target aaaaaabbbbb = 1,,,128
05 00 12#	0bbbbbbb	
05 00 13#	00 - 7F	Source V.Tr. V.Tr.1-A:1,,,V.Tr.8-B:8
05 00 14#	00 - 7F	
:	:	Source V.Tr. V.Tr.1-A:1,,,V.Tr.8-B:8
:	:	
05 nn mm#	00 - 7F	(nn mm = 00 12 + The Number Of Target * 2)

The VS-890 executes the Track Move command.
If the command succeeded, it returns the response 40. And if any errors occurred, it returns the response 41.

Command 04 Track Exchange

Start address	Data	Contents and remarks
05 00 00	04	Track Exchange
05 00 01#	0aaaaaaa	The Number Of Target aaaaaabbbbb = 1,,,128
05 00 02#	0bbbbbbb	
05 00 03#	00 - 7F	Source V.Tr. V.Tr.1-A:1,,,V.Tr.8-B:8
05 00 04#	00 - 7F	
:	:	Source V.Tr. V.Tr.1-A:1,,,V.Tr.8-B:8
:	:	
05 nn mm#	00 - 7F	(nn mm = 00 02 + The Number Of Target * 2)

The VS-890 executes the Track Exchange command.
If the command succeeded, it returns the response 40. And if any errors occurred, it returns the response 41.

Command 05 Track Insert

Start address	Data	Contents and remarks
05 00 00	05	Track Insert
05 00 01#	0aaaaaaa	Track Insert From Time aaaaaaabbbbbccccccccdddddd = 0,,,268435455block (lblock=16sample)
05 00 02#	0bbbbbbb	
05 00 03#	0ccccccc	
05 00 04#	0ddddddd	
05 00 05#	0aaaaaaa	Track Insert Length Time aaaaaaabbbbbccccccccdddddd = 0,,,268435455block (lblock=16sample)
05 00 06#	0bbbbbbb	
05 00 07#	0ccccccc	
05 00 08#	0ddddddd	
05 00 09#	0aaaaaaa	The Number Of Target aaaaaabbbbb = 1,,,128
05 00 0A#	0bbbbbbb	
05 00 0B#	00 - 7F	Insert V.Tr. V.Tr.1-A:1,,,V.Tr.8-B:8
:	:	
05 nn mm#	00 - 7F	(nn mm = 00 0A + The Number Of Target)

The VS-890 executes the Track Insert command.
If the command succeeded, it returns the response 40. And if any errors occurred, it returns the response 41.

Command 06 Track Cut

Start address	Data	Contents and remarks
05 00 00	06	Track Cut
05 00 01#	0aaaaaaa	Track Cut Start Time aaaaaaabbbbbccccccccdddddd = 0,,,268435455block (lblock=16sample)
05 00 02#	0bbbbbbb	
05 00 03#	0ccccccc	
05 00 04#	0ddddddd	
05 00 05#	0aaaaaaa	Track Cut End Time aaaaaaabbbbbccccccccdddddd = 0,,,268435455block (lblock=16sample)
05 00 06#	0bbbbbbb	
05 00 07#	0ccccccc	
05 00 08#	0ddddddd	
05 00 09#	0aaaaaaa	The Number Of Target aaaaaabbbbb = 1,,,128
05 00 0A#	0bbbbbbb	
05 00 0B#	00 - 7F	Cut V.Tr. V.Tr.1-A:1,,,V.Tr.8-B:8
:	:	
05 nn mm#	00 - 7F	(nn mm = 00 0A + The Number Of Target)

The VS-890 executes the Track Cut command.
If the command succeeded, it returns the response 40. And if any errors occurred, it returns the response 41.

Command 07 Track Erase

Start address	Data	Contents and remarks
05 00 00	07	Track Erase
05 00 01#	0aaaaaaa	Track Erase Start Time aaaaaaabbbbbccccccccdddddd = 0,,,268435455block (lblock=16sample)
05 00 02#	0bbbbbbb	
05 00 03#	0ccccccc	

MIDI Implementation

05 00 04#	0ddddd		
05 00 05#	0aaaaaa	Track Erase End Time	aaaaaaabbbbbccccccddddd =
05 00 06#	0bbbbbb		0,,268435455block (1block=16sample)
05 00 07#	0cccccc		
05 00 08#	0ddddd		
05 00 09#	0aaaaaa	The Number Of Target	aaaaaaabbbbb = 1,,128
05 00 0A#	0bbbbbb		
05 00 0E#	00 - 7F	Erase V.Tr.	V.Tr.1-A:1,,V.Tr.8-B:8
:	:	:	:
05 nn mm#	00 - 7F	Erase V.Tr.	V.Tr.1-A:1,,V.Tr.8-B:8 (nn mm = 00 0A + The Number Of Target)

The VS-890 executes the Track Erase command.
If the command succeeded, it returns the response 40. And if any errors occurred, it returns the response 41.

Command 08 Track Time Comp/Exp.

Start address	Data	Contents and remarks	
05 00 00	08	Track Time Comp/Exp.	
05 00 01#	0aaaaaa	Track Time Comp/Exp. Start Time	aaaaaaabbbbbccccccddddd =
05 00 02#	0bbbbbb		0,,268435455block (1block=16sample)
05 00 03#	0cccccc		
05 00 04#	0ddddd		
05 00 05#	0aaaaaa	Track Time Comp/Exp. End Time	aaaaaaabbbbbccccccddddd =
05 00 06#	0bbbbbb		0,,268435455block (1block=16sample)
05 00 07#	0cccccc		
05 00 08#	0ddddd		
05 00 09#	0aaaaaa	Track Time Comp/Exp. To Time	aaaaaaabbbbbccccccddddd =
05 00 0A#	0bbbbbb		0,,268435455block (1block=16sample)
05 00 0B#	0cccccc		
05 00 0C#	0ddddd		
05 00 0D#	00 - 01	Track Time Comp/Exp. Pitch Mode	Fix, Vari
05 00 0E#	00 - 02	Track Time Comp/Exp. Type	A, B, C
05 00 0F#	01 - 64	Track Time Comp/Exp. Amplitude	1,,100%
05 00 10#	0aaaaaa	The Number Of Target	aaaaaaabbbbb = 1,,128
05 00 11#	0bbbbbb		
05 00 12#	00 - 7F	Comp/Exp V.Tr.	V.Tr.1-A:1,,V.Tr.8-B:8
:	:	:	:
05 nn mm#	00 - 7F	Comp/Exp V.Tr.	V.Tr.1-A:1,,V.Tr.8-B:8 (nn mm = 00 11 + The Number Of Target)

The VS-890 executes the Time Stretch (Track Time Comp/Exp.) command.
If the command succeeded, it returns the response 40. And if any errors occurred, it returns the response 41.

Command 09 Preview From

Start address	Data	Contents and remarks	
05 00 00	09	Preview From	

The VS-890 executes the Preview From command.
If the command succeeded, it returns the response 40. And if any errors occurred, it returns the response 41.

Command 0A Preview To

Start address	Data	Contents and remarks	
05 00 00	0A	Preview To	

The VS-890 executes the Preview To command.
If the command succeeded, it returns the response 40. And if any errors occurred, it returns the response 41.

Command 0B Preview Scrub On

Start address	Data	Contents and remarks	
05 00 00	0B	Preview Scrub On	
05 00 01#	00 - 07	Target Track	1,,8

The VS-890 executes the Preview Scrub On command.
If the command succeeded, it returns the response 40. And if any errors occurred, it returns the response 41.

Command 0C Preview Scrub Off

Start address	Data	Contents and remarks	
05 00 00	0C	Preview Scrub Off	

The VS-890 executes the Preview Scrub Off command.
If the command succeeded, it returns the response 40. And if any errors occurred, it returns the response 41.

Command 0D Request Amplitude Profile

Start address	Data	Contents and remarks	
05 00 00	0D	Request Amplitude Profile	
05 00 01#	00 - 7F	Target V.Tr.	1-A:1,,8-B:8
05 00 02#	0aaaaaa	From Time	aaaaaaabbbbbccccccddddd =
05 00 03#	0bbbbbb		0,,268435455block (1block=16sample)
05 00 04#	0cccccc		
05 00 05#	0ddddd		
05 00 06#	0aaaaaa	Length Time	aaaaaaabbbbbccccccddddd =
05 00 07#	0bbbbbb		0,,268435455block (1block=16sample)
05 00 08#	0cccccc		
05 00 09#	0ddddd		
05 00 0A#	0aaaaaa	Resolution	aaaaaaabbbbb = sample(0).blocks
05 00 0B#	0bbbbbb		
05 00 0C#	0aaaaaa	Packet Byte Length	aaaaaaabbbbb = 5,,16384(=00)
05 00 0D#	0bbbbbb		

The VS-890 returns the Amplitude Profile Data (the response 42).
If the command succeeded, it returns the response 40. And if any errors occurred, it returns the response 41.

* The data size of the Data Set (DT1) (Bytes as a unit) is set to the Packet Byte Length. It is efficient to set the maximum size that is available for hosts to the Packet Byte Length.

Command 0E Request Wave Data

Start address	Data	Contents and remarks	
05 00 00	0E	Request Wave Data	
05 00 01#	00 - 7F	Target V.Tr.	1-A:1,,8-B:8
05 00 02#	0aaaaaa	From Time	aaaaaaabbbbbccccccddddd =
05 00 03#	0bbbbbb		0,,268435455block (1block=16sample)
05 00 04#	0cccccc		
05 00 05#	0ddddd		
05 00 06#	0aaaaaa	Length Time	aaaaaaabbbbbccccccddddd =
05 00 07#	0bbbbbb		0,,268435455block (1block=16sample)
05 00 08#	0cccccc		
05 00 09#	0ddddd		
05 00 0A#	0aaaaaa	Packet Byte Length	aaaaaaabbbbb = 5,,16384(=00)
05 00 0B#	0bbbbbb		

The VS-890 returns the Wave Data (the response 43).
If the command succeeded, it returns the response 40. And if any errors occurred, it returns the response 41.

* The data size of the Data Set (DT1) (Bytes as a unit) is set to the Packet Byte Length. It is efficient to set the maximum size that is available for hosts to the Packet Byte Length.

Command 0F Full Event List

Start address	Data	Contents and remarks
05 00 00	0F	Full Event List
05 00 01#	0aaaaaaa	Target V.Tr.
05 00 02#	0bbbbbbb	aaaaaaaaabbbbbbb = 1-A:1,,,8-B:8,Take
05 00 03#	0aaaaaaa	Packet Byte Length
05 00 04#	0bbbbbbb	aaaaaaaaabbbbbbb = 5,,,16384(=00)

The VS-890 returns the Full Event List which specified track (the response 44).
If the command succeeded, it returns the response 40. And if any error occurred, it returns the response 41.

- * The data size of the Data Set (DT1) (Bytes as a unit) is set to the Packet Byte Length. It is efficient to set the maximum size that is available for hosts to the Packet Byte Length.

Command 10 Simple Event List

Start address	Data	Contents and remarks
05 00 00	10	Simple Event List
05 00 01#	0aaaaaaa	Target V.Tr.
05 00 02#	0bbbbbbb	aaaaaaaaabbbbbbb = 1-A:1,,,8-B:8,Take
05 00 03#	0aaaaaaa	Packet Byte Length
05 00 04#	0bbbbbbb	aaaaaaaaabbbbbbb = 5,,,16384(=00)

The VS-890 returns the Simple Event List which specified track (the response 45).
If the command succeeded, it returns the response 40. And if any errors occurred, it returns the response 41.

- * The data size of the Data Set (DT1) (Bytes as a unit) is set to the Packet Byte Length. It is efficient to set the maximum size that is available for hosts to the Packet Byte Length.

Command 11 Number of Event List

Start address	Data	Contents and remarks
05 00 00	11	Number of Event List
05 00 01#	0aaaaaaa	Target V.Tr.
05 00 02#	0bbbbbbb	aaaaaaaaabbbbbbb = 1-A:1,,,8-B:8,Take
05 00 03#	0aaaaaaa	Packet Byte Length
05 00 04#	0bbbbbbb	aaaaaaaaabbbbbbb = 5,,,16384(=00)

The VS-890 returns the Number of Event List which specified track (the response 46).
If the command succeeded, it returns the response 40. And if any errors occurred, it returns the response 41.

- * The data size of the Data Set (DT1) (Bytes as a unit) is set to the Packet Byte Length. It is efficient to set the maximum size that is available for hosts to the Packet Byte Length.

Command 12 Full Event Parameter

Start address	Data	Contents and remarks
05 00 00	12	Full Event Parameter
05 00 01#	0aaaaaaa	Target V.Tr.
05 00 02#	0bbbbbbb	aaaaaaaaabbbbbbb = 1-A:1,,,8-B:8,Take
05 00 03#	000000aa	Event Number
05 00 04#	0bbbbbbb	aabbbbbbbccccccc
05 00 05#	0bbbbbbb	
05 00 06#	0aaaaaaa	Packet Byte Length
05 00 07#	0bbbbbbb	aaaaaaaaabbbbbbb = 5,,,16384(=00)

The VS-890 returns the Full Event Parameter which specified track (the response 47).
If the command succeeded, it returns the response 40. And if any errors occurred, it returns the response 41.

- * The data size of the Data Set (DT1) (Bytes as a unit) is set to the Packet Byte Length. It is

efficient to set the maximum size that is available for hosts to the Packet Byte Length.

Command 13 Simple Event Parameter

Start address	Data	Contents and remarks
05 00 00	13	Simple Event Parameter
05 00 01#	0aaaaaaa	Target V.Tr.
05 00 02#	0bbbbbbb	aaaaaaaaabbbbbbb = 1-A:1,,,8-B:8,Take
05 00 03#	000000aa	Event Number
05 00 04#	0bbbbbbb	aabbbbbbbccccccc
05 00 05#	0bbbbbbb	
05 00 06#	0aaaaaaa	Packet Byte Length
05 00 07#	0bbbbbbb	aaaaaaaaabbbbbbb = 5,,,16384(=00)

The VS-890 returns the Simple Event Parameter which specified track (the response 48).
If the command succeeded, it returns the response 40. And if any errors occurred, it returns the response 41.

- * The data size of the Data Set (DT1) (Bytes as a unit) is set to the Packet Byte Length. It is efficient to set the maximum size that is available for hosts to the Packet Byte Length.

Command 14 Name Event

Start address	Data	Contents and remarks
05 00 00	13	Simple Event Parameter
05 00 01#	0aaaaaaa	Target V.Tr.
05 00 02#	0bbbbbbb	aaaaaaaaabbbbbbb = 1-A:1,,,8-B:8,Take
05 00 03#	000000aa	Event Number
05 00 04#	0bbbbbbb	aabbbbbbbccccccc
05 00 05#	0bbbbbbb	
05 00 06#	20 - 7E	Name - 1 (ASCII)
05 00 07#	20 - 7E	Name - 2
:	:	:
05 00 11#	20 - 7E	Name - 12

The VS-890 writes the Name of Event which specified track.
If the command succeeded, it returns the response 40. And if any errors occurred, it returns the response 41.

- * The data size of the Data Set (DT1) (Bytes as a unit) is set to the Packet Byte Length. It is efficient to set the maximum size that is available for hosts to the Packet Byte Length.

Command 15 Undo

Start address	Data	Contents and remarks
05 00 00	15	Undo
05 00 01#	000000aa	Undo Level
05 00 02#	0bbbbbbb	aabbbbbbbccccccc = 1,,,999
05 00 03#	0bbbbbbb	

The VS-890 cancels the last command such as the Edit.
If the command succeeded, it returns the response 40. And if any errors occurred, it returns the response 41.

Command 16 Redo

Start address	Data	Contents and remarks
05 00 00	16	Redo

The VS-890 cancels the last Undo command.
If the command succeeded, it returns the response 40. And if any errors occurred, it returns the response 41.

MIDI Implementation

Command 17 Create Event

Start address	Data	Contents and remarks
05 00 00	17	Create Event
05 00 01#	00 - 7F	Target V.Tr. 1-A:1,,,8-B:8
05 00 02#	000000aa	Original Take Event Number
05 00 03#	0bbbbbbb	aabbbbbbbccccccc
05 00 04#	0bbbbbbb	
00 00 05#	0aaaaaaa	Start Time
00 00 06#	0bbbbbbb	aaaaaaaaabbbbbbbcccccccccccccccc
00 00 07#	0ccccccc	
00 00 08#	0ddddddd	
00 00 09#	0aaaaaaa	End Time
00 00 0A#	0bbbbbbb	aaaaaaaaabbbbbbbcccccccccccccccc
00 00 0B#	0ccccccc	
00 00 0C#	0ddddddd	
00 00 0D#	0aaaaaaa	Offset Time
00 00 0E#	0bbbbbbb	aaaaaaaaabbbbbbbcccccccccccccccc
00 00 0F#	0ccccccc	
00 00 10#	0ddddddd	

The VS-890 create the track Event with the specified original take event. The time(Start, Stop, Offset) of the create Event are set the specified value. If the command succeeded, it returns the response 40. And if any errors occurred, it returns the response 41.

Command 18 Song Select

Start address	Data	Contents and remarks
05 00 00	18	Song Select
05 00 01#	00 - 01	Store Current Song No, Yes
05 00 02#	0000000a	Song Number abbbbbbb = 0...199
05 00 03#	0bbbbbbb	

Select the VS-890 song. If the command succeeded, it returns the response 40. And if any errors occurred, it returns the response 41.

Command 19 Song Store

Start address	Data	Contents and remarks
05 00 00	19	Song Store

Store the current VS-890 song. If the command succeeded, it returns the response 40. And if any errors occurred, it returns the response 41.

Command 1A Drive Select

Start address	Data	Contents and remarks
05 00 00	1A	Drive Select
05 00 01#	00 - 01	Store Current Song No, Yes
05 00 02#	00 - 3f	Select Drive

Change the current VS-890 drive. If the command succeeded, it returns the response 40. And if any errors occurred, it returns the response 41.

Command 1B Request Drive List

Start address	Data	Contents and remarks
05 00 00	1B	Request Drive List

The VS-890 returns the Drive List (the response 49). If any errors occurred, it returns the response 41.

Command 1C Shut Down

Start address	Data	Contents and remarks
05 00 00	1C	Shut Down
05 00 01#	00 - 01	Store Current Song No, Yes

The VS-890 executes shut down. If the command succeeded, it returns the response 40. And if any errors occurred, it returns the response 41.

Response 40 Complete (No Error)

Start address	Data	Contents and remarks
05 00 00	40	Complete (No Error)

It shows the command was complete.

Response 41 Error

Start address	Data	Contents and remarks
05 00 00	41	Error
05 00 01#	00 - 7F	Error Code (00=No Error(complete, end of data) 01=Busy 02=Command Aborted 03=Illegal Command 04=Command Error

It shows the command was not complete by any error.

Response 42 Amplitude Profile

Start address	Data	Contents and remarks
05 00 00	42	Amplitude Profile
05 00 01#	00 - 7F	V. Track 1-A:1,,,8-B:8
05 00 02#	0aaaaaaa	Packet Number
05 00 03#	0bbbbbbb	aaaaaaaaabbbbbbb = 0 - 16383
05 00 04#	00 - 7F	Packet Data Buffer
:	:	:
05 nn mm#		(nn mm = Packet Byte Length - 1)

Data Sequence
00 00 00 00 - 7F Amplitude Data 0=-127dB, 1=-126dB, ..., 126=-1dB, 127=0dB

The VS-890 frequently writes the Amplitude Profile data to the Data Buffer until specified length.

Last packet size may be shorter than specified one. If the command succeeded, it returns the response 40. And if any errors occurred, it returns the response 41.

Response 43 Wave Data

Start address	Data	Contents and remarks
05 00 00	43	Wave Data

05 00 01#	00 - 7F	V. Track	1-A:1...8-B:8
05 00 02#	0aaaaaa 0bbbbbb	Packet Number	aaaaaabbbbbbb = 0 - 16383
05 00 04#	00 - 7F	Packet Data Buffer	
05 nn mm#			(nn mm = Packet Byte Length - 1)

Data Sequence			
00 00 00	000000aa	Wave Data	
00 00 01	0bbbbbb	aabbbbbbbcccccc = 16bit 2's Complement data	
00 00 02	0cccccc		

The VS-890 frequently writes the Wave Data to the Data Buffer until specified length.

Last packet size may be shorter than specified one.

If the command succeeded, it returns the response 40. And if any errors occurred, it returns the response 41.

Response 44 Full Event List

Start address	Data	Contents and remarks	
05 00 00	44	Full Event List	
05 00 01#	0aaaaaa 0bbbbbb	V. Track	aaaaaabbbbbbb = 1-A:1...8-B:8,Take
05 00 03#	0aaaaaa 0bbbbbb	Packet Number	aaaaaabbbbbbb = 0 - 16383
05 00 04#	00 - 7F	Packet Data Buffer	
05 nn mm#			(nn mm = Packet Byte Length - 1)

Data Sequence			
00 00 00	000000aa	Event Number	aabbbbbbbcccccc = 0 - 16383
00 00 01	0bbbbbb		
00 00 02	0cccccc		
00 00 03	0aaaaaa	Start Time	aaaaaabbbbbbbccccccdddddd
00 00 04	0bbbbbb		
00 00 05	0cccccc		
00 00 06	0dddddd		
00 00 07	0aaaaaa	End Time	aaaaaabbbbbbbccccccdddddd
00 00 08	0bbbbbb		
00 00 09	0cccccc		
00 00 0A	0dddddd		
00 00 0B	0aaaaaa	Offset Time	aaaaaabbbbbbbccccccdddddd
00 00 0C	0bbbbbb		
00 00 0D	0cccccc		
00 00 0E	0dddddd		
00 00 0F	0000aaaa	Start Offset in Start Cluster	aaaabbbbbbb
00 00 10	0bbbbbb		
00 00 11	0000aaaa	End Offset in End Cluster	
00 00 12	0bbbbbb		
00 00 13	000000aa	Previous Event	aabbbbbbbcccccc
00 00 14	0bbbbbb		
00 00 15	0cccccc		
00 00 16	000000aa	Next Event	aabbbbbbbcccccc
00 00 17	0bbbbbb		
00 00 18	0cccccc		
00 00 19	000000aa	Top Cluster	aabbbbbbbcccccc
00 00 1A	0bbbbbb		
00 00 1B	0cccccc		
00 00 1C	000000aa	Bottom Cluster	aabbbbbbbcccccc
00 00 1D	0bbbbbb		
00 00 1E	0cccccc		
00 00 1F	000000aa	Cluster Number	aabbbbbbbcccccc
00 00 20	0bbbbbb		
00 00 21	0cccccc		
00 00 22	000000aa	Start Cluster	aabbbbbbbcccccc
00 00 23	0bbbbbb		
00 00 24	0cccccc		
00 00 25	000000aa	End Cluster	aabbbbbbbcccccc
00 00 26	0bbbbbb		
00 00 27	0cccccc		
00 00 28	000000aa	Archive Flag	aabbbbbbbcccccc
00 00 29	0bbbbbb		
00 00 2A	0cccccc		
05 00 2B	00 - 7F	Target V.Tr.	1-A:1...8-B:8
00 00 2C	00 - 01	Sub Take	ORG, SUB

00 00 2D	20 - 7e	Name - 1	ASCII
00 00 2E	20 - 7e	Name - 2	
:	:	:	
00 00 38	20 - 7e	Name - 12	

The VS-890 frequently writes the all parameters of Full Event which specified track to the Data Buffer by continuous.

Last packet size may be shorter than specified one.

If the command succeeded, it returns the response 40. And if any errors occurred, it returns the response 41.

Response 45 Simple Event List

Start address	Data	Contents and remarks	
05 00 00	45	Simple Event List	
05 00 01#	0aaaaaa 0bbbbbb	V. Track	aaaaaabbbbbbb = 1-A:1...8-B:8,Take
05 00 03#	0aaaaaa 0bbbbbb	Packet Number	aaaaaabbbbbbb = 0 - 16383
05 00 04#	00 - 7F	Packet Data Buffer	
05 nn mm#			(nn mm = Packet Byte Length - 1)

Data Sequence			
00 00 00	000000aa	Event Number	aabbbbbbbcccccc = 0 - 16383
00 00 01	0bbbbbb		
00 00 02	0cccccc		
00 00 03	0aaaaaa	Start Time	aaaaaabbbbbbbccccccdddddd
00 00 04	0bbbbbb		
00 00 05	0cccccc		
00 00 06	0dddddd		
00 00 07	0aaaaaa	End Time	aaaaaabbbbbbbccccccdddddd
00 00 08	0bbbbbb		
00 00 09	0cccccc		
00 00 0A	0dddddd		
00 00 0B	000000aa	Top Cluster	aabbbbbbbcccccc
00 00 0C	0bbbbbb		
00 00 0D	0cccccc		
05 00 0E	00 - 7F	Target V.Tr.	1-A:1...8-B:8
00 00 0F	00 - 01	Sub Take	ORG, SUB
00 00 10	20 - 7e	Name - 1	ASCII
00 00 11	20 - 7e	Name - 2	
:	:	:	
00 00 1b	20 - 7e	Name - 12	

The VS-890 frequently writes the principal parameters of Event which specified track to the Data Buffer by continuous.

Last packet size may be shorter than specified one.

If the command succeeded, it returns the response 40. And if any errors occurred, it returns the response 41.

Response 46 Number of Event List

Start address	Data	Contents and remarks	
05 00 00	46	Number of Event List	
05 00 01#	0aaaaaa 0bbbbbb	V. Track	aaaaaabbbbbbb = 1-A:1...8-B:8,Take
05 00 03#	0aaaaaa 0bbbbbb	Packet Number	aaaaaabbbbbbb = 0 - 16383
05 00 04#	00 - 7F	Packet Data Buffer	
05 nn mm#			(nn mm = Packet Byte Length - 1)

Data Sequence			
00 00 00	000000aa	Event Number	aabbbbbbbcccccc = 0 - 16383
00 00 01	0bbbbbb		
00 00 02	0cccccc		

MIDI Implementation

MIDI Implementation

The VS-890 frequently writes the all Event Number which specified track to the Data Buffer by continuous.

Last packet size may be shorter than specified one.
If the command succeeded, it returns the response 40. And if any errors occurred, it returns the response 41.

Response 47 Full Event Parameter

Start address	Data	Contents and remarks
05 00 00	47	Full Event Parameter
05 00 01#	0aaaaaaa	V. Track
05 00 02#	0bbbbbbb	aaaaaaaaaaaaaaaa = 1-A:1,,,8-B:8,Take
05 00 03#	0aaaaaaa	Packet Number
05 00 04#	0bbbbbbb	aaaaaaaaaaaaaaaa = 0 - 16383
05 00 05#	00 - 7F	Packet Data Buffer
:	:	:
05 nn mm#	:	(nn mm = Packet Byte Length - 1)

The VS-890 frequently writes the Event Parameter which specified track to the Data Buffer by continuous (same as response 44 Full Event List).

Last packet size may be shorter than specified one.
If the command succeeded, it returns the response 40. And if any errors occurred, it returns the response 41.

Response 48 Simple Event Parameter

Start address	Data	Contents and remarks
05 00 00	48	Simple Event Parameter
05 00 01#	0aaaaaaa	V. Track
05 00 02#	0bbbbbbb	aaaaaaaaaaaaaaaa = 1-A:1,,,8-B:8,Take
05 00 03#	0aaaaaaa	Packet Number
05 00 04#	0bbbbbbb	aaaaaaaaaaaaaaaa = 0 - 16383
05 00 05#	00 - 7F	Packet Data Buffer
:	:	:
05 nn mm#	:	(nn mm = Packet Byte Length - 1)

The VS-890 frequently writes the principal parameters of Event which specified track to the Data Buffer by continuous (same as response 45 Simple Event List).

Last packet size may be shorter than specified one.
If the command succeeded, it returns the response 40. And if any errors occurred, it returns the response 41.

Response 49 Drive List

Start address	Data	Contents and remarks
05 00 00	49	Drive List
05 00 01#	00 - 01	IDE Partition1
:	:	:
05 00 0a#	00 - 01	IDE Partition10
05 00 0b#	00 - 01	SCSI ID:0 Partition1
:	:	:
05 00 14#	00 - 01	SCSI ID:0 Partition10
05 00 15#	00 - 01	SCSI ID:1 Partition1
:	:	:
05 00 1e#	00 - 01	SCSI ID:1 Partition10
05 00 1f#	00 - 01	SCSI ID:2 Partition1
:	:	:
05 00 20#	00 - 01	SCSI ID:2 Partition10
05 00 29#	00 - 01	SCSI ID:3 Partition1
:	:	:
05 00 32#	00 - 01	SCSI ID:3 Partition10
05 00 33#	00 - 01	SCSI ID:4 Partition1
:	:	:
05 00 3c#	00 - 01	SCSI ID:4 Partition10

05 00 3d#	00 - 01	SCSI ID:5 Partition1
:	:	:
05 00 46#	00 - 01	SCSI ID:5 Partition10
05 00 47#	00 - 01	SCSI ID:6 Partition1
:	:	:
05 00 50#	00 - 01	SCSI ID:6 Partition10
05 00 51#	00 - 01	SCSI ID:7 Partition1
:	:	:
05 00 5a#	00 - 01	SCSI ID:7 Partition10

It shows the drive lists.

●Sync Track Data

Start address	Data	Contents and remarks
08 00 00	0000aaaa	Sync Track Data 1
08 00 01	0000bbbb	aaaabbbbccccdddd
08 00 02	0000cccc	
08 00 03	0000dddd	
08 00 04	0000aaaa	Sync Track Data 2
08 00 05	0000bbbb	aaaabbbbccccdddd
08 00 06	0000cccc	
08 00 07	0000dddd	
08 00 08	0000aaaa	Sync Track Data 3
:	:	:
0f 7f 7b	0000dddd	Sync Track Data 32767
0f 7f 7c	0000aaaa	Sync Track Data 32768
0f 7f 7d	0000bbbb	aaaabbbbccccdddd
0f 7f 7e	0000cccc	
0f 7f 7f	0000dddd	

●Disk Access

Start address	Data	Contents and remarks
10 00 00	0000aaaa	Data Buffer Byte-1
10 00 01	0000bbbb	aaaabbbb = Data Byte-1
10 00 02	0000aaaa	Data Buffer Byte-2
10 00 03	0000bbbb	aaaabbbb = Data Byte-2
:	:	:
11 7f 7c	0000aaaa	Data Buffer Byte-16382
11 7f 7d	0000bbbb	aaaabbbb = Data Byte-16382
11 7f 7e	0000aaaa	Data Buffer Byte-16383
11 7f 7f	0000bbbb	aaaabbbb = Data Byte-16383
12 00 00	0aaaaaaa	Data Size
12 00 01	0bbbbbbb	aaaaaaaaaaaaaaaa = Data Size 1 - 16384(= 0) byte
12 00 02	00 - 7F	Command / Result or Status

You can access the disk file using the parameter. There are 16K Bytes Data Buffer area, the Data Size of the effective bytes in the Buffer and the Command / Result or Status area. Use the DT1 for writing the Buffer, the Data Size and the Command. Use the RQ1 for reading the Buffer which is stored the Result of the Command, the Data Size and the Result.

Command List for Disk Access

Command	Remarks
00	Reset
01	Read Open
02	Write Open
03	Read
04	Write
05	Read Close
06	Write Close
07	Check File
08	Delete File

Response (result of the Command) List for Disk Access

Response	Remarks
00	Complete (No Error)
01	Busy
02	Error: No disk
03	Error: File Not Exist
04	Error: Can Not Delete File
05	Error: Can Not Create File
06	Error: End of File
07	Error: Read Error
08	Error: Write Error
09	Error: Can Not Close File

Description of Commands (the following section)

00 Reset

Start address	Data	Contents and remarks
12 00 02	00	Reset Command

It resets the Disk Access, closes all files and clears the Buffer. You should execute the command before any file access.

01 Read Open

Start address	Data	Contents and remarks
10 00 00	20 - 7E	File Name - 1 (ASCII)
10 00 01	20 - 7E	File Name - 2 (ASCII)
10 00 02	20 - 7E	File Name - 3 (ASCII)
10 00 03	20 - 7E	File Name - 4 (ASCII)
10 00 04	20 - 7E	File Name - 5 (ASCII)
10 00 05	20 - 7E	File Name - 6 (ASCII)
10 00 06	20 - 7E	File Name - 7 (ASCII)
10 00 07	20 - 7E	File Name - 8 (ASCII)
10 00 08	20 - 7E	File Extension - 1 (ASCII)
10 00 09	20 - 7E	File Extension - 2 (ASCII)
10 00 0A	20 - 7E	File Extension - 3 (ASCII)
:	:	:
12 00 02	01	Read Open Command

It opens the specified file for reading, sets the reading pointer to the top of file and sets the result to the Result(same as Read Open Command) Area. You can open only one file at the same time. (cannot open the Reading File and the Writing File simultaneously) The File Name is based on MS-DOS format.

02 Write Open

Start address	Data	Contents and remarks
10 00 00	20 - 7E	File Name - 1 (ASCII)
10 00 01	20 - 7E	File Name - 2 (ASCII)
10 00 02	20 - 7E	File Name - 3 (ASCII)
10 00 03	20 - 7E	File Name - 4 (ASCII)
10 00 04	20 - 7E	File Name - 5 (ASCII)
10 00 05	20 - 7E	File Name - 6 (ASCII)
10 00 06	20 - 7E	File Name - 7 (ASCII)
10 00 07	20 - 7E	File Name - 8 (ASCII)
10 00 08	20 - 7E	File Extension - 1 (ASCII)
10 00 09	20 - 7E	File Extension - 2 (ASCII)
10 00 0A	20 - 7E	File Extension - 3 (ASCII)
:	:	:
12 00 02	02	Write Open Command

It opens the specified file for writing, sets the writing pointer to the top of file and sets the result to the Result(same as Write Open Command) Area. If the same name's file already existed, it is deleted. You can open only one file at the same time. (cannot open the Reading File and the Writing File simultaneously) The File Name is based on MS-DOS format.

03 Read

Start address	Data	Contents and remarks
12 00 00	0aaaaaaa	Data Size
12 00 01	0bbbbbbb	aaaaaaaabbbbbbb = Data Size 1 - 16384 byte
12 00 02	03	Read Command

It reads the Data which has specified size of Bytes to the Buffer area from current read pointer of the File, after that puts forward the pointer and sets the result to the Result(same as Read Command) Area.

If the remainder of the file data was less than specified size of Bytes, it reads all data to the buffer and writes the actual size to the Data Size area. If you read the data from over the end of file, the error occurs.

04 Write

Start address	Data	Contents and remarks
12 00 00	0aaaaaaa	Data Size
12 00 01	0bbbbbbb	aaaaaaaabbbbbbb = Data Size 1 - 16384 byte
12 00 02	04	Write Command

It writes the Data which has specified size of Bytes to current write pointer area from the Buffer area, after that puts forward the pointer and sets the result to the Result(same as Write Command) Area.

05 Read Close

Start address	Data	Contents and remarks
12 00 02	05	Read Close Command

It closes the File which is opened for reading, and sets the result to the Result (same as Read Close Command) area.

06 Write Close

Start address	Data	Contents and remarks
12 00 02	06	Write Close Command

It closes the File which is opened for writing, and sets the result to the Result (same as Write Close Command) Area.

07 Check File

Start address	Data	Contents and remarks
10 00 00	20 - 7E	File Name - 1 (ASCII)
10 00 01	20 - 7E	File Name - 2 (ASCII)
10 00 02	20 - 7E	File Name - 3 (ASCII)
10 00 03	20 - 7E	File Name - 4 (ASCII)
10 00 04	20 - 7E	File Name - 5 (ASCII)
10 00 05	20 - 7E	File Name - 6 (ASCII)
10 00 06	20 - 7E	File Name - 7 (ASCII)
10 00 07	20 - 7E	File Name - 8 (ASCII)
10 00 08	20 - 7E	File Extension - 1 (ASCII)
10 00 09	20 - 7E	File Extension - 2 (ASCII)
10 00 0A	20 - 7E	File Extension - 3 (ASCII)
:	:	:
12 00 02	07	Check File Command

It sets the File information which has specified name to the Buffer area.

Start address	Data	Contents and remarks

MIDI Implementation

10 00 C0	20 - 7E	File Name - 1	(ASCII)
10 00 C1	20 - 7E	File Name - 2	(ASCII)
10 00 C2	20 - 7E	File Name - 3	(ASCII)
10 00 C3	20 - 7E	File Name - 4	(ASCII)
10 00 C4	20 - 7E	File Name - 5	(ASCII)
10 00 C5	20 - 7E	File Name - 6	(ASCII)
10 00 C6	20 - 7E	File Name - 7	(ASCII)
10 00 C7	20 - 7E	File Name - 8	(ASCII)
10 00 C8	20 - 7E	File Extension - 1	(ASCII)
10 00 C9	20 - 7E	File Extension - 2	(ASCII)
10 00 CA	20 - 7E	File Extension - 3	(ASCII)
10 00 CB	0000aaaa	File Size	
10 00 CC	0bbbbbbb	aaaaaaaaaaaaaaaaaaaaaaaaaaaaaaaa	
10 00 CD	0ccccccc		
10 00 CE	0ddddddd		0 - 4.2Gbyte
10 00 CF	0eeeeeee		

It sets the error code if no file existed, and sets the result to the Result (same as Check File Command) Area.

08 Delete File

Start address	Data	Contents and remarks	
10 00 00	20 - 7E	File Name - 1	(ASCII)
10 00 01	20 - 7E	File Name - 2	(ASCII)
10 00 02	20 - 7E	File Name - 3	(ASCII)
10 00 03	20 - 7E	File Name - 4	(ASCII)
10 00 04	20 - 7E	File Name - 5	(ASCII)
10 00 05	20 - 7E	File Name - 6	(ASCII)
10 00 06	20 - 7E	File Name - 7	(ASCII)
10 00 07	20 - 7E	File Name - 8	(ASCII)
10 00 08	20 - 7E	File Extension - 1	(ASCII)
10 00 09	20 - 7E	File Extension - 2	(ASCII)
10 00 0A	20 - 7E	File Extension - 3	(ASCII)
12 00 02	08	Delete File Command	

It deletes the File which has specified name, and sets the result to the Result (Delete File Command) Area.

Description of Result Area (the following section)

00 Complete (No error) / Ready

Start address	Data	Contents and remarks	
12 00 02	00	Complete	

It is complete the last command, and ready to the next command.

01 Busy

Start address	Data	Contents and remarks	
12 00 02	01	Busy	

It is busy and does not accept the any command. (on Recording or Playing)

02 Error : No disk

Start address	Data	Contents and remarks	
12 00 02	02	Error : No disk	

The valid Disk Drive is not connected.

03 Error : File not exist

Start address	Data	Contents and remarks	
12 00 02	03	Error : File not exist	

The File does not exist.

04 Error : Can not delete file

Start address	Data	Contents and remarks	
12 00 02	04	Error : Can not delete file	

It cannot delete the file.

05 Error : Can not create file

Start address	Data	Contents and remarks	
12 00 02	05	Error : Can not create file	

It cannot create the new file.

06 Error : End of file

Start address	Data	Contents and remarks	
12 00 02	06	Error : End of file	

It reads the data from over the end of file.

07 Error : Read error

Start address	Data	Contents and remarks	
12 00 02	07	Error : Read error	

The error occurs on the reading file.

08 Error : Write error

Start address	Data	Contents and remarks	
12 00 02	08	Error : Write error	

The error occurs on the writing file. It may not be disk space for writing.

09 Error : Can not close file

Start address	Data	Contents and remarks	
12 00 02	09	Error : Can not close file	

The error occurs on the closing file. It may not be disk space.

3. MIDI Machine Control

■MIDI Machine Control Command Reference

●STOP (MCS)

Status	Data Bytes	Status
F0H	7FH,Dev,06H,01H	F7H

Byte	Description
F0H	Status of Exclusive Message
7FH	Universal System Exclusive Message Realtime Header
Dev	Device ID (or 7FH)
06H	MMC Command Message
01H	STOP (MCS)
F7H	EOX (End of Exclusive Message)

If the device ID on the message was as same as that of the receiving device or 7FH, the VS-890 stops immediately.

If the transport switch [STOP] was pressed, the VS-890 transmits as the device ID 7FH.

●PLAY (MCS)

Status	Data Bytes	Status
F0H	7FH,Dev,06H,02H	F7H

Byte	Description
F0H	Status of Exclusive Message
7FH	Universal System Exclusive Message Realtime Header
Dev	Device ID (or 7FH)
06H	MMC Command Message
02H	PLAY (MCS)
F7H	EOX (End of Exclusive Message)

If the device ID on the message was as same as that of the receiving device or 7FH, the VS-890 goes into the playback condition.

The VS-890 does not transmit the message.

●DEFERRED PLAY (MCS)

Status	Data Bytes	Status
F0H	7FH,Dev,06H,03H	F7H

Byte	Description
F0H	Status of Exclusive Message
7FH	Universal System Exclusive Message Realtime Header
Dev	Device ID (or 7FH)
06H	MMC Command Message
03H	DEFERRED PLAY (MCS)
F7H	EOX (End of Exclusive Message)

If the device ID on the message was as same as that of the receiving device or 7FH, the VS-890 goes into the playback condition after the locate operation.

If the transport switch [PLAY] was pressed, the VS-890 transmits as the device ID 7FH.

●FAST FORWARD (MCS)

Status	Data Bytes	Status
F0H	7FH,Dev,06H,04H	F7H

Byte	Description
F0H	Status of Exclusive Message
7FH	Universal System Exclusive Message Realtime Header
Dev	Device ID (or 7FH)
06H	MMC Command Message
04H	FAST FORWARD (MCS)
F7H	EOX (End of Exclusive Message)

If the device ID on the message was as same as that of the receiving device or 7FH, the VS-890 goes into the Fast Forward condition.

The VS-890 does not transmit the message.

●REWIND (MCS)

Status	Data Bytes	Status
F0H	7FH,Dev,06H,05H	F7H

Byte	Description
F0H	Status of Exclusive Message
7FH	Universal System Exclusive Message Realtime Header
Dev	Device ID (or 7FH)
06H	MMC Command Message
05H	REWIND (MCS)
F7H	EOX (End of Exclusive Message)

If the device ID on the message was as same as that of the receiving device or 7FH, the VS-890 goes into the rewind condition.

The VS-890 does not transmit the message.

●RECORD STROBE

Status	Data Bytes	Status
F0H	7FH,Dev,06H,06H	F7H

Byte	Description
F0H	Status of Exclusive Message
7FH	Universal System Exclusive Message Realtime Header
Dev	Device ID (or 7FH)
06H	MMC Command Message
06H	RECORD STROBE
F7H	EOX (End of Exclusive Message)

If the device ID on the message was as same as that of the receiving device or 7FH, the VS-890 goes into the following condition.

1. The VS-890 is in the playback condition.
Start Recording the tracks that status are the record standby mode.
2. The VS-890 is in the stop condition.
Start Playing back, and Start Recording the track that status are the record standby mode.

If the transport switch [REC] was pressed out of the recording condition, the VS-890 transmits as the device ID 7FH.

●RECORD EXIT

Status	Data Bytes	Status
F0H	7FH,Dev,06H,07H	F7H

Byte	Description
F0H	Status of Exclusive Message
7FH	Universal System Exclusive Message Realtime Header
Dev	Device ID (or 7FH)
06H	MMC Command Message
07H	RECORD EXIT
F7H	EOX (End of Exclusive Message)

If the device ID on the message was as same as that of the receiving device or 7FH, the VS-890 exits from the record condition.

If the transport switch [REC] was pressed while recording, the VS-890 transmits as the device ID 7FH.

●MMC RESET

Status	Data Bytes	Status
F0H	7FH,Dev,06H,0DH	F7H

Byte	Description
F0H	Status of Exclusive Message
7FH	Universal System Exclusive Message Realtime Header
Dev	Device ID (or 7FH)
06H	MMC Command Message
0DH	MMC RESET

MIDI Implementation

F7H EOX (End of Exclusive Message)

If the device ID on the message was as same as that of the receiving device or 7FH, the VS-890 resets all communication channels related with MMC.
When powered on the VS-890 transmits as the device ID 7FH.

●WRITE

Status	Data Bytes	Status
F0H	7FH,Dev,06H,40H, ccH,ddH,eeH,,,ffH,,	F7H

Byte	Description
F0H	Status of Exclusive Message
7FH	Universal System Exclusive Message Realtime Header
Dev	Device ID (or 7FH)
06H	MMC Command Message
40H	WRITE
ccH	Information Bytes follows the command
ddH	The name of the writable Information Field
eeH	Information Field Format
:	:
ffH	Field names and data
:	:
F7H	EOX (End of Exclusive Message)

If the device ID on the message was as same as that of the receiving device or 7FH, the VS-890 writes the data to the specified information field.
The VS-890 does not transmit the message.

●MASKED WRITE

Status	Data Bytes	Status
F0H	7FH,Dev,06H,41H,04H, ddH,eeH,ffH,gg	F7H

Byte	Description
F0H	Status of Exclusive Message
7FH	Universal System Exclusive Message Realtime Header
Dev	Device ID (or 7FH)
06H	MMC Command Message
41H	MASKED WRITE
04H	Number of Bytes follows the command
ddH	The name of the masked type writable Information Field
eeH	Byte number to write in the Bit Map
ffH	Bit location of the bit map byte to change
ggH	New data to write to the specified bit map byte
F7H	EOX (End of Exclusive Message)

If the device ID on the message was as same as that of the receiving device or 7FH, the VS-890 writes the data to the specified bit map byte.
The VS-890 does not transmit the message.

●LOCATE (MCP)

○Format 1 - LOCATE [I/F]

Status	Data Bytes	Status
F0H	7FH,Dev,06H,44H,02H,00H,nnH	F7H

Byte	Description
F0H	Status of Exclusive Message
7FH	Universal System Exclusive Message Realtime Header
Dev	Device ID (or 7FH)
06H	MMC Command Message
44H	LOCATE (MCP)
02H	Number of Bytes
00H	"I/F" sub command
nnH	Information Field (08H, 09H, 0AH, 0BH, 0CH, 0DH, 0EH, 0FH)
F7H	EOX (End of Exclusive Message)

If the device ID on the message was as same as that of the receiving device or 7FH, the VS-890 locates the selected time location stored to the specified information field.

The VS-890 does not transmit the message.

○Format 2 - LOCATE [TARGET]

Status	Data Bytes	Status
F0H	7FH,Dev,06H,44H,06H,01H, hrH,mnH,scH,frH,ffH	F7H

Byte	Description
F0H	Status of Exclusive Message
7FH	Universal System Exclusive Message Realtime Header
Dev	Device ID (or 7FH)
06H	MMC Command Message
44H	LOCATE(MCP)
06H	Number of Bytes
01H	"TARGET" sub command
hrH, mnH, scH, frH, ffH	Standard Time with Sub Frame
F7H	EOX (End of Exclusive Message)

If the device ID on the message was as same as that of the receiving device or 7FH, the VS-890 locates the specified time location received from the command.
If the efficient locate switch [LOC?] or Marker switch [PREVIOUS], [NEXT] is pressed, the VS-890 transmits as the device ID 7FH.

●MOVE

Status	Data Bytes	Status
F0H	7FH,Dev,06H,4CH,02H,ddH,ssH	F7H

Byte	Description
F0H	Status of Exclusive Message
7FH	Universal System Exclusive Message Realtime Header
Dev	Device ID (or 7FH)
06H	MMC Command Message
4CH	MOVE
02H	Number of Bytes
ddH	Name of the Efficient Destination Information Field (08H,09H,0AH,0BH,0CH,0DH,0EH,0FH)
ssH	Name of the Efficient Source Information Field (01H)
F7H	EOX (End of Exclusive Message)

If the device ID on the message was as same as that of the receiving device or 7FH, the VS-890 transfers the data on the selected source information field to the destination Information Field, if the name of both information fields is efficient.
The VS-890 does not transmit the message.

●The efficient Information Field

The followings are the efficient Information Field on the VS-890.

The name of the efficient destination Information Field :

- 01H SELECTED TIME CODE
- 08H GP0 / LOCATE POINT
- 09H GP1
- 0AH GP2
- 0BH GP3
- 0CH GP4
- 0DH GP5
- 0EH GP6
- 0FH GP7
- 4FH TRACK RECORD READY

4. Appendices

● Decimal and Hexadecimal table

(Hexadecimal number is shown with H.)

In MIDI documentation, data values and addresses/sizes of system exclusive messages etc. are expressed as hexadecimal values for each 7 bits.

The following table shows how these correspond to decimal numbers.

dec	hex	dec	hex	dec	hex	dec	hex
0	00H	32	20H	64	40H	96	60H
1	01H	33	21H	65	41H	97	61H
2	02H	34	22H	66	42H	98	62H
3	03H	35	23H	67	43H	99	63H
4	04H	36	24H	68	44H	100	64H
5	05H	37	25H	69	45H	101	65H
6	06H	38	26H	70	46H	102	66H
7	07H	39	27H	71	47H	103	67H
8	08H	40	28H	72	48H	104	68H
9	09H	41	29H	73	49H	105	69H
10	0AH	42	2AH	74	4AH	106	6AH
11	0BH	43	2BH	75	4BH	107	6BH
12	0CH	44	2CH	76	4CH	108	6CH
13	0DH	45	2DH	77	4DH	109	6DH
14	0EH	46	2EH	78	4EH	110	6EH
15	0FH	47	2FH	79	4FH	111	6FH
16	10H	48	30H	80	50H	112	70H
17	11H	49	31H	81	51H	113	71H
18	12H	50	32H	82	52H	114	72H
19	13H	51	33H	83	53H	115	73H
20	14H	52	34H	84	54H	116	74H
21	15H	53	35H	85	55H	117	75H
22	16H	54	36H	86	56H	118	76H
23	17H	55	37H	87	57H	119	77H
24	18H	56	38H	88	58H	120	78H
25	19H	57	39H	89	59H	121	79H
26	1AH	58	3AH	90	5AH	122	7AH
27	1BH	59	3BH	91	5BH	123	7BH
28	1CH	60	3CH	92	5CH	124	7CH
29	1DH	61	3DH	93	5DH	125	7DH
30	1EH	62	3EH	94	5EH	126	7EH
31	1FH	63	3FH	95	5FH	127	7FH

* Decimal values such as MIDI channel, bank select, and program change are listed as one (1) greater than the values given in the above table.

* A 7-bit byte can express data in the range of 128 steps. For data where greater precision is required, we must use two or more bytes. For example, two hexadecimal numbers aa bbH expressing two 7-bit bytes would indicate a value of $aa \times 128 + bb$.

* In the case of values which have a +/- sign, 00H = -64, 40H = +/- 0, and 7FH = +63, so that the decimal expression would be 64 less than the value given in the above chart. In the case of two types, 00 00H = -8192, 40 00H = +/- 0, and 7F 7FH = +8191.

* Data marked "nibbled" is expressed in hexadecimal in 4-bit units. A value expressed as a 2-byte nibble 0a 0bH has the value of $a \times 16 + b$.

<Ex.1> What is 5AH in decimal system?

5AH = 90 according to the above table.

<Ex.2> What in decimal system is 12034H in hexadecimal of every 7 bit?

12H = 18, 34H = 52 according to the above table. So $18 \times 128 + 52 = 2356$.

<Ex.3> What in decimal system is 0A 03 09 0D in nibble system?

0AH = 10, 03H = 3, 09H = 9, 0DH = 13 according to the table.

So $((10 \times 16 + 3) \times 16 + 9) \times 16 + 13 = 41885$.

<Ex. 4> What in nibble system is 1258 in decimal system?

```

16|1258
16| 78 ... 10
16|  4 ... 14
   0 ...  4
    
```

0 = 00H, 4 = 04H, 14 = 0EH, 10 = 0AH According to the table.

So it is 00 04 0E 0AH.

● Example of system exclusive message and Checksum calculation

On Roland system exclusive message (DT1), checksum is added at the end of transmitted data (in front of F7) to check the message is received correctly. Value of checksum is defined by address and data (or size) of the system exclusive message to be transmitted.

How to calculate checksum

(Hexadecimal number is shown with H.)

Checksum is a value which lower 7 bit of the sum of address, size and checksum itself turns to be 0.

If the address of the system exclusive message to be transmitted is aa bb cccH and data or size is dd ee ffH,

$aa + bb + cc + dd + ee + ff = \text{sum}$

$\text{sum} / 128 = \text{quotient and odd}$

When odd is 0, 0 = checksum

When odd is other than 0, 128 - odd = checksum

■ MIDI Machine Control (MMC) Command, Information Field / Response Reference

● Commands Recognized

Command	Action
01H STOP	STOP
02H PLAY	PLAY
03H DEFERRED PLAY	PLAY
04H FAST FORWARD	FF
05H REWIND	REW
06H RECORD STROBE	REC / PUNCH IN
07H RECORD EXIT	PUNCH OUT
0DH MMC RESET	RESET
40H WRITE	Write to Information Fields
41H MASKED WRITE	Set Track Status Information Fields
44H 00H LOCATE I/F	LOCATE (Read Locator)
44H 01H LOCATE TARGET	LOCATE (Designated Time)
4CH MOVE	Move between Information fields

● Commands Transmitted

Command	Action
01H STOP	STOP
03H DEFERRED PLAY	PLAY
06H RECORD STROBE	REC / PUNCH IN
07H RECORD EXIT	PUNCH OUT
0DH MMC RESET	RESET
44H 01H LOCATE TARGET	LOCATE

● Valid Information Fields / Response

Information Field	Interpret	Valid Commands
01H SELECTED TIME CODE	Current Time	MOVE(FROM)
08H CP0 / LOCATE POINT	Locator 1	MOVE(FROM), MOVE(TO), WRITE
09H CP1	Locator 2	MOVE(FROM), MOVE(TO), WRITE
0AH CP2	Locator 3	MOVE(FROM), MOVE(TO), WRITE
0BH CP3	Locator 4	MOVE(FROM), MOVE(TO), WRITE
0CH CP4	Locator 5	MOVE(FROM), MOVE(TO), WRITE
0DH CP5	Locator 6	MOVE(FROM), MOVE(TO), WRITE
0EH CP6	Locator 7	MOVE(FROM), MOVE(TO), WRITE
0FH CP7	Locator 8	MOVE(FROM), MOVE(TO), WRITE
4FH TRACK RECORD READY	Track Status	MASKED WRITE, WRITE

Mixer Section Block Diagram

Input Mixer and Track Mixer

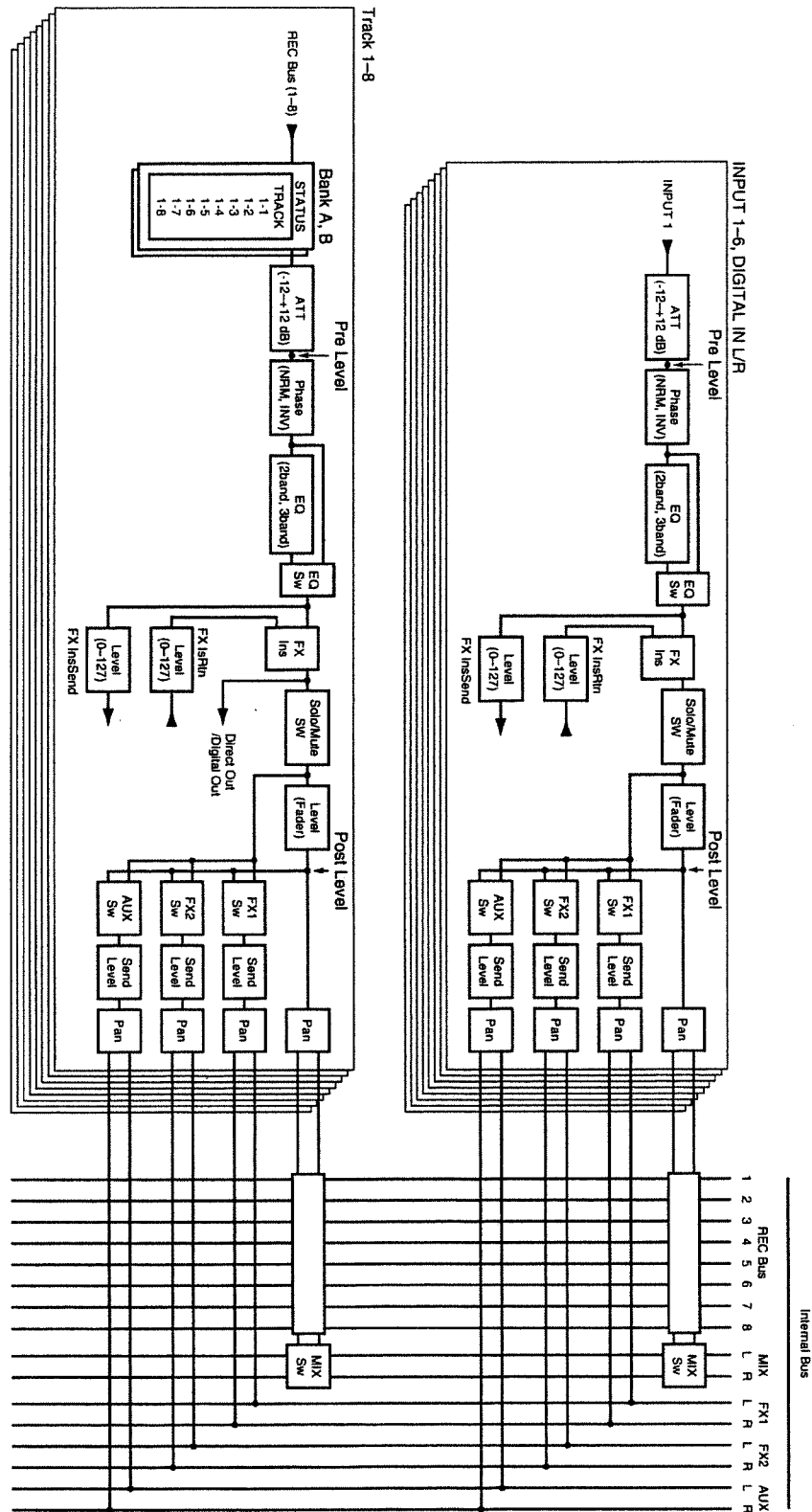

Mixer Section Block Diagram

Mixer Section Block Diagram

Masterblock

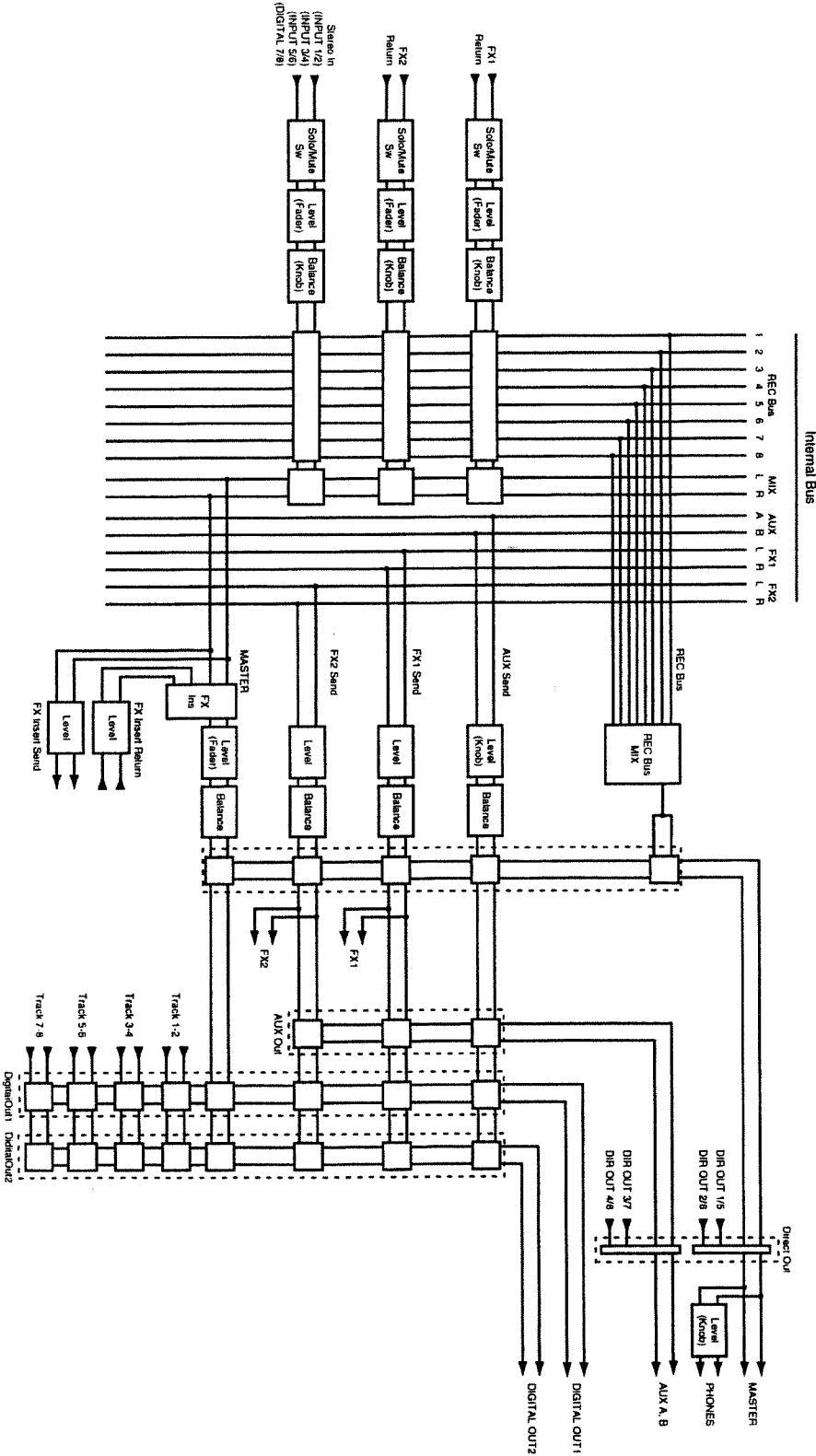

Specifications

VS-890

24-bit Digital Studio Workstation

Number of Tracks

Tracks: 8

V-Tracks: 128 (8 Tracks x 8 V-Tracks x 2 Banks)

- * Up to 8 tracks can be recorded simultaneously, and up to 8 tracks can be played back simultaneously.
- * When set the Sample Rate to "48 kHz," up to 6 tracks can be recorded simultaneously.
- * When also set the Vari Pitch to "On," up to 4 tracks can be recorded simultaneously.

Maximum Useful Capacity

32 G bytes: 1 G bytes (partition capacity)
x 32 (number of Partition)

- * Up to 10 partitions can be created in each disk drive.

Internal Memory

Songs: 200 songs for each device (VS-880, VS-1680,
VS-880EX or VS-890: each partition)

- * Songs Recorded with the VSR-880 are recognized as the VS-890 songs.
- * The total songs is limited to 500.

Channel Equalizer

3-Band (HI, MID, LOW) or 2-Band (HI, LOW) selectable

- * Up to 8 channels can be used with the 3-Band equalizers. Up to 16 channels can be used with the 2-Band equalizers.
- * If the "VSR" mode is selected for the Recording Mode, the equalizer cannot be used.

Recording Mode

VSR

CDR (CD Writing)

MAS (Mastering)

MT1 (Multitrack 1)

MT2 (Multitrack 2)

LIV (Live)

Signal Processing

AD Conversion: 24 bits, 64 times oversampling

DA Conversion: 24 bits, 128 times oversampling

Sample Rate

48.0 kHz, 44.1 kHz, 32.0 kHz

- * Sample rate can be adjusted around 21.96–50.48 kHz (maximum) by using the Vari-Pitch function.

Frequency Response

Sample Rate

48.0 kHz: 20 Hz–22 kHz (+0.2 dB/-0.2 dB)

44.1 kHz: 20 Hz–20 kHz (+0.2 dB/-0.2 dB)

32.0 kHz: 20 Hz–14 kHz (+0.2 dB/-0.2 dB)

Total Harmonic Distortion (INPUT SENS: LINE, 1 kHz at nominal output level)

0.005% or less (recording mode: MAS)

Recording Time (1 GB partition, conversion in 1 track, unit: minutes)

Recording Mode	Sample Rate		
	48.0 kHz	44.1 kHz	32.0 kHz
VSR	371	404	557
CDR	185	202	278
MAS	185	202	278
MT1	371	404	557
MT2	495	539	742
LIV	594	646	891

- * The above-listed recording times are approximate. Times may be slightly depending on the specifications of the disk drive. For example, if you are using a hard disk that is 6,000 MB, above-listed recording times will be sixfold.
- * Times may be slightly depending on the number of songs that were created.
- * When set the Record Mode to "CDR," the VS-890 will function as a four-pair stereo recorder, and above-listed recording times will be half.

Nominal Input Level (variable)

Input1–6: -50– +4 dBu (maximum +26 dBu: Balanced,
maximum +20 dBu: Unbalanced)

Input Impedance

Input1–6: 30 k ohm

Nominal Output Level

Master Out (L, R): 0 dBu

AUX (A, B): 0 dBu

Output Impedance

Master Out (L, R): 1 k ohm

AUX (A, B): 1 k ohm

Headphones: 22 ohm

Recommended load Impedance

Master Out (L, R): 10 k ohm or greater

AUX (A, B): 10 k ohm or greater

Headphones: 8–50 ohm

Residual Noise Level (input terminated with 1 k ohm, INPUT: LINE, IHF-A, type.)

Master Out (L, R): -82 dBu or less
AUX (A, B): -82 dBu or less

Interface Connectors

SCSI: DB-25 type
Digital I/O: Coaxial, Optical (conforms to S/P DIF)

Display

70.6 x 24.5 mm, LCD (with backlit)

Connectors

SCSI Connector (DB-25 type)
MIDI Connectors (IN, OUT/THRU)
Input Jack 1-6 (1/4 inch phone type, TRS balanced)
Digital In Connectors (Coaxial type, Optical type)
Digital Out Connectors (Coaxial type, Optical type)
Headphones Jack (Stereo 1/4 inch phone type)
Foot Switch Jack (1/4 inch phone type)
Master Out Jack L/R (RCA phone type)
AUX Send Jack A/B (RCA phone type)

Power Supply

AC 117 V, AC 230 V or AC 240 V

Power Consumption

20 W (Including internal hard disk)

Dimensions

434 (W) x 317 (D) x 89 (H) mm
17-1/8 (W) x 12-1/2 (D) x 3-9/16 (H) inches

Weight

4.7 kg (Excluding internal hard disk)
10 lbs 6 oz

Accessories

AC Cord
User Guide
Owner's Manual
Appendices

Options

Internal Hard Disk Drive Unit:
Roland CD Recorder
Dynamic Microphone: DR-20
Bi-Amp Monitor: DS-90A
Pedal Switch: DP-2
Foot Switch: FS-5U (BOSS)
Video MIDI Sync Interface: SI-80SP

(0 dBu = 0.775 V rms)

Index

- A**
Aborted Command! 9
Active Terminator 4, 12
active terminator 4
Algorithm 21, 23
algorithm 7
Already Selected 9
Analog Flanger 24
Analog Phaser 24
Arbitration Failed! 9
Attenuator 6
audio cable 5
AUTOMIX buttons 15
- B**
Bass 21
Blank Disc 9
Busy Status! 9
- C**
Can't Communicate! 9
Can't REC CD ! 9
Can't Recover 9
Can't Set Marker 9
CD-R 12
CD-R disc 7
CD-R/RW drive 7
CD-RW 12
CD-RW drive 6
Change Int CLK ? 9
Channel fader 5
Check Condition! 9
Chorus 21
Compact Disc Recordable 12
Compact Disc ReWritable 12
Complete 9
Composite Object Sound Modeling 12
Control Change messages 3
COSM 12
Current Song 12
- D**
daisy chain 4
DAT 12
DB-25 type 4
Delay 20, 28
Device ID 3
Digital Audio Tape 12
Digital In Lock 9
Digital In Unlock 9
Disk Memory Full! 9
Disk Parameter 19
Drive Busy! 9
Drive Initialize 19
Drive Time Out! 9
Drive Unknown Error! 9
- E**
EDIT CONDITION buttons 14
Effect Return 17
Event Memory Full! 9
events 5
Exclusive messages 3
- F**
Finalize 12
Finalized CD ! 10
Flanger 21
Formants 12
Frame 12
Function Failed 10
- G**
Gate Reverb 20
General Purpose Interface 12
GPI 12
Graphic Equalizer 23
Guitar 20
Guitar Amp Simulator 21
- H**
Hardware Error! 10
- I**
IDE 12
Illegal Request! 9
Illegal Track Pair! 10
Illegal Track! 10
Input Mixer 16, 127
Insert 20
Integrated Device and Electronics 12
- L**
Lack of CD-R Memory! 10
Lack of EVENT !! 10
Lack of IDE Memory! 10
LOCATOR buttons 15
- M**
MARKER Memory Full! 10
Marker Block 17
master clock 5
Master fader 5
Masterblock 128
Mastering Tool Kit 24
Medium Error! 10
Message Error! 9
Mic Simulator 22
MIDI

- | | |
|--|--------|
| channels | 3 |
| connectors | 3 |
| implementation chart | 3 |
| IN | 3 |
| messages | 3 |
| OUT | 3 |
| sequencer | 7 |
| THRU | 3 |
| MIDI Machine Control | 12 |
| MIDI messages | 3 |
| Control Change messages | 3 |
| Exclusive messages | 3 |
| Note messages | 3 |
| Program Change messages | 3 |
| MIDI Parameter | 18 |
| MIDI Time Code | 12 |
| Mix Send Switch | 5 |
| Mixer Section Block Diagram | 127 |
| MMC | 12 |
| MTC | 12 |
| Musical Instrument Digital Interface | 3 |
| Mute | 5 |
| N | |
| No CD-R Drive ! | 10 |
| No Data to Write | 10 |
| No Disc | 10 |
| No Drive Ready | 10 |
| No IDE Drive ! | 10 |
| Not 44.1k Song ! | 10 |
| Not 512byte/sector | 10 |
| Not Ready! | 10 |
| Note messages | 3 |
| note number | 3 |
| NTSC Format | 13 |
| O | |
| Obey Copyrights ? | 10 |
| Other | 15 |
| P | |
| PAL Formats | 13 |
| Parametric Equalizer | 23 |
| Phase Mismatch! | 9 |
| Phaser | 21 |
| PHONES knob | 5 |
| Phrase | |
| Delete | 6 |
| Pitch Shifter | 21 |
| Please Insert CD-R Disc ! | 10 |
| Please Wait... | 10 |
| Program Change messages | 3 |
| R | |
| R-BUS | 13 |
| Removable Disk Drives | 13 |
| Reverb | 20, 26 |
| Reverb2 | 22 |
| Roland Sound System | 13 |
| RSS | 13 |
| S | |
| S/P DIF | 13 |
| Scene/Automix | 19 |
| SCMS | 13 |
| SCSI | 4, 13 |
| cable | 4 |
| ID number | 4 |
| SCSI chain | 4 |
| SCSI ID Error! | 10 |
| SECAM Formats | 13 |
| SELECT/CH EDIT buttons | 14 |
| Shutdown | 13 |
| Small Computer System Interface | 4 |
| SMPTE time code | 13 |
| Snd/Rtn | 20 |
| Solo | 5 |
| Song | |
| Optimize | 6 |
| Song Protected! | 11 |
| Space Chorus | 23 |
| SPC Not Available! | 10 |
| Speaker Modeling | 24 |
| Special Effects | 23 |
| Special Key | 14 |
| Status Error! | 9 |
| STATUS indicator | 5 |
| StDly-Chorus | 30 |
| Stereo Delay Chorus | 30 |
| Stereo In | 17 |
| Stereo Multi | 21 |
| Stereo Pitch Shifter Delay | 32 |
| StPS-Delay | 32 |
| Sync Track Convert | 19 |
| Sync/Tempo Parameter | 19 |
| System Parameter | 18 |
| T | |
| Tape Echo 201 | 24 |
| Tempo Map | 19 |
| terminator | 4 |
| externally attached | 4 |
| internal | 4 |
| Terminator Power | 4, 13 |
| time compression | 6 |
| time expansion | 6 |
| TOC | 13 |
| TOC Read Error! | 11 |
| Too Many Markers! | 11 |

Index

Track	
Cut	6
Erase	6
Track Minutes	13
Track Mixer	16, 127
Track Sheet	129
Transport Control buttons	14
U	
Undefined Sense!	9
Unformatted!	11
User Aborted!	11
V	
velocity	3
video device	8
Vocal	20
W	
Write Another ?	11
Write Protected!	11
Z	
Zip Drive	13
Zip drive	4, 6

...MEMO...

...MEMO...



Information

When you need repair service, call your nearest Roland Service Center or authorized Roland distributor in your country as shown below.

AFRICA

EGYPT

Al Fanny Trading Office
P.O. Box 2904,
El Horrieh Heliopolos, Cairo,
EGYPT
TEL: (02) 4185531

REUNION

Maison FO - YAM Marcel
25 Rue Jules MermanZL
Chaudron - BP79 97491
Ste Clotilde REUNION
TEL: 28 29 16

SOUTH AFRICA

**That Other Music Shop
(PTY) Ltd.**
11 Melle Street (Cnr Melle and
Juta Street)
Braamfontein 2001
Republic of SOUTH AFRICA
TEL: (011) 403 4105

Paul Bothner (PTY) Ltd.
17 Werdmuller Centre Claremont
7700
Republic of SOUTH AFRICA
TEL: (021) 64 4030

P.O. Box 23032
Claremont, Cape Town
SOUTH AFRICA 7735
TEL: (021) 64 4030

ASIA

CHINA

**Beijing Xinghai Musical
Instruments Co., Ltd.**
6 Huangmunchang Chao Yang
District, Beijing, CHINA
TEL: (010) 6774 7491

HONG KONG

**Tom Lee Music Co., Ltd.
Service Division**
22-32 Pun Shan Street, Tsuen
Wan, New Territories,
HONG KONG
TEL: 2415 0911

INDIA

Rivera Digitec (India) Pvt. Ltd.
409, Nirman Kendra Mahalaxmi
Flats Compound Off. Dr. Edwin
Moses Road, Mumbai-400011,
INDIA
TEL: (022) 498 3079

INDONESIA

PT Citra Inti Rama
Jl. Cideng Timur No. 15J-150
Jakarta Pusat
INDONESIA
TEL: (021) 6324170

KOREA

**Cosmos Corporation
Service Station**
261 2nd Floor Nak-Won Arcade
Jong-Ro ku, Seoul, KOREA
TEL: (02) 742 8844

MALAYSIA

Bentley Music SDN BHD
140 & 142, Jalan Bukit Bintang,
55100 Kuala Lumpur, MALAYSIA
TEL: (03) 2443333

PHILIPPINES

G.A. Yupangco & Co. Inc.
339 Gil J. Puyat Avenue
Makati, Metro Manila 1200,
PHILIPPINES
TEL: (02) 899 9801

SINGAPORE

Swee Lee Company
150 Sims Drive,
SINGAPORE 387381
TEL: 748-1669

CRISTOFORI MUSIC PTE LTD

BK 3014, Bedok Industrial Park E,
#02-2148, SINGAPORE 489980
TEL: 243 9555

TAIWAN

**ROLAND TAIWAN
ENTERPRISE CO., LTD.**
Room 5, 9fl. No. 112 Chung Shan
N.Road Sec.2, Taipei, TAIWAN,
R.O.C.
TEL: (02) 2561 3339

THAILAND

Theera Music Co., Ltd.
330 Vergn NakornKasem, Soi 2,
Bangkok 10100, THAILAND
TEL: (02) 2248821

VIETNAM

Saigon Music
138 Tran Quang Khai St.,
District 1
Ho Chi Minh City
VIETNAM
TEL: (08) 844-4068

AUSTRALIA/ NEW ZEALAND

AUSTRALIA

**Roland Corporation
Australia Pty., Ltd.**
38 Campbell Avenue
Dee Why West. NSW 2099
AUSTRALIA
TEL: (02) 9982 8266

NEW ZEALAND

Roland Corporation (NZ) Ltd.
97 Mt. Eden Road, Mt. Eden,
Auckland 3, NEW ZEALAND
TEL: (09) 3098 715

CENTRAL/LATIN AMERICA

ARGENTINA

Instrumentos Musicales S.A.
Florida 656 2nd Floor
Office Number 206A
Buenos Aires
ARGENTINA, CP1005
TEL: (54-11) 4- 393-6057

BRAZIL

Roland Brasil Ltda.
R. Coronel Octaviano da Silveira
203 05522-010
Sao Paulo BRAZIL
TEL: (011) 3743 9377

CHILE

Comercial Fancy S.A.
Avenida Rancagua #0330
Providencia Santiago, CHILE
TEL: 56-2-373-9100

EL SALVADOR

OMNI MUSIC
75 Avenida Notre y Alameda
Juan Pablo 2 No. 4010
San Salvador, EL SALVADOR
TEL: (503) 262-0788

MEXICO

Casa Veerkamp, s.a. de c.v.
Av. Toluca No. 323 Col. Olivar de
los Padres 01780 Mexico D.F.
MEXICO
TEL: (525) 668 04 80

**La Casa Wagner de
Guadalajara s.a. de c.v.**
Av. Corona No. 202 S.J.
Guadalajara, Jalisco Mexico
C.P.44100 MEXICO
TEL: (3) 613 1414

PANAMA

Productos Superiores, S.A.
Apartado 655 - Panama 1
REP. DE PANAMA
TEL: (507) 270-2200

URUGUAY

Todo Musica
Cuareim 1488, Montevideo,
URUGUAY
TEL: 5982-924-2335

VENEZUELA

Musiland Digital C.A.
Av. Francisco de Miranda,
Centro Parque de Cristal, Nivel
C2 Local 20 Caracas
VENEZUELA
TEL: (02) 285 9218

EUROPE

AUSTRIA

Roland Austria GES.M.B.H.
Siemensstrasse 4, P.O. Box 74,
A-6063 RUM, AUSTRIA
TEL: (0512) 26 44 260

BELGIUM/HOLLAND/ LUXEMBOURG

Roland Benelux N. V.
Houtstraat 3 B-2260 Oevel
(Westerlo) BELGIUM
TEL: (014) 575811

DENMARK

Roland Scandinavia A/S
Nordhavnsvej 7, Postbox 880
DK-2100 Copenhagen
DENMARK
TEL: (039)16 6200

FRANCE

Roland France SA
4, Rue Paul Henri SPAAK
Parc de l'Esplanade F 77 462 St.
Thibault Lagny Cedex FRANCE
TEL: 01 600 73 500

FINLAND

**Roland Scandinavia As,
Filial Finland**
Lauttasaarentie 54 B
Fin-00201 Helsinki, FINLAND
TEL: (9) 682 4020

GERMANY

**Roland Elektronische
Musikinstrumente
Handelsgesellschaft mbH.**
Oststrasse 96, 22844 Norderstedt,
GERMANY
TEL: (040) 52 60090

GREECE

STOLLAS S.A.
Music Sound Light
155, New National Road
26422 Patras, GREECE
TEL: 061-435400

HUNGARY

Intermusica Ltd.
Warehouse Area 'DEPO' Pf.83
H-2046 Torokbalint, HUNGARY
TEL: (23) 511011

IRELAND

Roland Ireland
Audio House, Belmont Court,
Donnybrook, Dublin 4,
Republic of IRELAND
TEL: (01) 2603501

ITALY

Roland Italy S. p. A.
Viale delle Industrie, 8
20020 Arese Milano, ITALY
TEL: (02) 937-78300

NORWAY

**Roland Scandinavia Avd.
Kontor Norge**
Lilleakerveien 2 Postboks 95
Lilleaker N-0216 Oslo
NORWAY
TEL: 273 0074

POLAND

P. P. H. Brzostowicz
UL. Gibraltarska 4.
PL-03664 Warszawa POLAND
TEL: (022) 679 44 19

PORTUGAL

**Tecnologias Musica e Audio,
Roland Portugal, S.A.**
RUA SANTA CATARINA
131 - 4000 Porto -PORTUGAL
TEL: (02) 208 44 56

ROMANIA

FBS LINES
Plata Libertatii 1.
RO-4200 Cheorgheni
TEL: (066) 164-609

RUSSIA

Siarni Music Company
Sadovaya-Triumfalnaja st. 16
103006 Moscow, RUSSIA
TEL: 095 209 2193

SPAIN

**Roland Electronics
de España, S. A.**
Calle Bolivia 239 08020 Barcelona,
SPAIN
TEL: (93) 308 1000

SWEDEN

**Roland Scandinavia A/S
SWEDISH SALES OFFICE**
Danvik Center 28, 2 tr.
S-131 30 Nacka SWEDEN
TEL: (08) 702 0020

SWITZERLAND

**Roland (Switzerland) AG
Musitronic AG**
Gerberstrasse 5, CH-4410 Liestal,
SWITZERLAND
TEL: (061) 921 1615

UKRAINE

TIC-TAC
Mira Str. 19/108
P.O. Box 180
295400 Munkachevo, UKRAINE
TEL: (03131) 414-40

UNITED KINGDOM

Roland (U.K.) Ltd.
Atlantic Close, Swansea
Enterprise Park SWANSEA
SA7 9FJ,
UNITED KINGDOM
TEL: (01792) 700139

MIDDLE EAST

BAHRAIN

Moon Stores
Bab Al Bahrain Road,
P.O. Box 20077
State of BAHRAIN
TEL: 211 005

CYPRUS

Radex Sound Equipment Ltd.
17 Diagorou St., P.O. Box 2046,
Nicosia CYPRUS
TEL: (02) 453 426

ISRAEL

**Halilit P. Greenspoon &
Sons Ltd.**
8 Retzif Fa'aliya Hashnya St.
Tel-Aviv-Yaho ISRAEL
TEL: (03) 6823666

JORDAN

AMMAN Trading Agency
Prince Mohammed St. P.O. Box
825 Amman 11118 JORDAN
TEL: (06) 4641200

KUWAIT

Easa Husain Al-Yousifi
P.O. Box 126 Safat 13002
KUWAIT
TEL: 5719499

LEBANON

A. Chahine & Fils
P.O. Box 16-5857 Gergi Zeidan St.
Chahine Building, Achrafieh
Beirut, LEBANON
TEL: (01) 335799

OMAN

**OHI Electronics & Trading
Co. LLC**
P.O. Box 889 Muscat
Sultanate of OMAN
TEL: 959085

QATAR

Badie Studio & Stores
P.O. Box 62,
DOHA QATAR
TEL: 423554

SAUDI ARABIA

**aDawlah Universal
Electronics APJ**
P.O. Box 2154 ALKHOBAR 31952,
SAUDI ARABIA
TEL: (03) 898 2081

SYRIA

**Technical Light & Sound
Center**
Khaled Ibn Al Walid St.
P.O. Box 13520
Damascus - SYRIA
TEL: (011) 2235 384

TURKEY

**Barkat Muzik aletleri ithalat
ve ihracat limited ireketi**
Siraselviler Cad. Billurcu Sok.
Mucadelle Cikmeze No. 11-13
Taksim. Istanbul. TURKEY
TEL: (0212) 2499324

U.A.E.

**Zak Electronics & Musical
Instruments Co.**
Zabeel Road, Al Sherooq Bldg.,
No. 14, Grand Floor DUBAI
U.A.E.
P.O. Box 8050 DUBAI, U.A.E.
TEL: (04) 360715

NORTH AMERICA

CANADA

**Roland Canada Music Ltd.
(Head Office)**
5480 Parkwood Way Richmond
B. C., V6V 2M4 CANADA
TEL: (0604) 270 6626

**Roland Canada Music Ltd.
(Toronto Office)**
Unit 2, 109 Woodbine Downs
Blvd, Etobicoke, ON
M9W 6Y1 CANADA
TEL: (0416) 213 9707

U. S. A.

Roland Corporation U.S.
5100 S. Eastern Avenue
Los Angeles, CA 90040-2938,
U. S. A.
TEL: (323) 890 3700

Concerning Copyright

The law prohibits the unauthorized recording, public performance, broadcast, sale, or distribution etc. of a work (CD recording, video recording, broadcast, etc.) whose copyright is owned by a third party. The VS-890 does not implement SCMS. This design decision was made with the intent that SCMS should not restrict the creation of original compositions which do not violate copyright law. Roland will take no responsibility for any infringement of copyright that you may commit in using the VS-890. SCMS (Appendices p. 13)

Disclaimer of liability

Roland will take no responsibility for any "direct damages," "consequential damages," or "any other damages" which may result from your use of the VS-890. These damages may include but are not limited to the following events which can occur when using the VS-890.

- Any loss of profit that may occur to you
- Permanent loss of your music or data
- Inability to continue using the VS-890 itself or a connected device

About the License Agreement

The VS-890 and its CD-R capability are designed to allow you to reproduce material to which you have copyright, or material which the copyright owner has granted you permission to copy. Accordingly, reproduction of music CDs or other copyrighted material without the permission of the copyright owner, other than for your own personal use and enjoyment (private use) constitutes copyright infringement, which may incur penalties. Consult a copyright specialist or special publications for more detailed information on obtaining such permission from copyright holders.

- Microsoft and Windows are registered trademarks of Microsoft Corporation.
- Windows® 95 is known officially as: "Microsoft® Windows® 95 operating system."
- Windows® 98 is known officially as: "Microsoft® Windows® 98 operating system."
- Apple and Macintosh are trademarks of Apple Computer, Inc., registered in the U.S. and other countries.
- Iomega is a registered trademark of Iomega Corporation.
- ZIP is a trademark of Iomega Corporation.
- Cakewalk is a registered trademark of Twelve Tone systems, Inc.
- Cakewalk Pro Audio and Cakewalk Professional are trademarks of Twelve Tone systems, Inc.
- All product names mentioned in this document are trademarks or registered trademarks of their respective owners.

Roland®

71674401

UPC

71674401



18981

Roland

Free Manuals Download Website

<http://myh66.com>

<http://usermanuals.us>

<http://www.somanuals.com>

<http://www.4manuals.cc>

<http://www.manual-lib.com>

<http://www.404manual.com>

<http://www.luxmanual.com>

<http://aubethermostatmanual.com>

Golf course search by state

<http://golfingnear.com>

Email search by domain

<http://emailbydomain.com>

Auto manuals search

<http://auto.somanuals.com>

TV manuals search

<http://tv.somanuals.com>