

VG-99

V-Guitar System

Owner's Manual

Thank you, and congratulations on your choice of the Roland VG-99.

Before using this unit, carefully read the sections entitled: "USING THE UNIT SAFELY" (p. 2-3), and "IMPORTANT NOTES" (p. 4-5). These sections provide important information concerning the proper operation of the unit. Additionally, in order to feel assured that you have gained a good grasp of every feature provided by your new unit, Handbook and Owner's manual should be read in its entirety. The manual should be saved and kept on hand as a convenient reference.



Copyright © 2007 ROLAND CORPORATION

All rights reserved. No part of this publication may be reproduced in any form without the written permission of ROLAND CORPORATION.

Roland Website <http://www.roland.com/>

USING THE UNIT SAFELY

INSTRUCTIONS FOR THE PREVENTION OF FIRE, ELECTRIC SHOCK, OR INJURY TO PERSONS

About ⚠ WARNING and ⚠ CAUTION Notices

⚠ WARNING	Used for instructions intended to alert the user to the risk of death or severe injury should the unit be used improperly.
⚠ CAUTION	Used for instructions intended to alert the user to the risk of injury or material damage should the unit be used improperly. * Material damage refers to damage or other adverse effects caused with respect to the home and all its furnishings, as well to domestic animals or pets.

About the Symbols

	The ⚠ symbol alerts the user to important instructions or warnings. The specific meaning of the symbol is determined by the design contained within the triangle. In the case of the symbol at left, it is used for general cautions, warnings, or alerts to danger.
	The ⚡ symbol alerts the user to items that must never be carried out (are forbidden). The specific thing that must not be done is indicated by the design contained within the circle. In the case of the symbol at left, it means that the unit must never be disassembled.
	The ● symbol alerts the user to things that must be carried out. The specific thing that must be done is indicated by the design contained within the circle. In the case of the symbol at left, it means that the power-cord plug must be unplugged from the outlet.

ALWAYS OBSERVE THE FOLLOWING

⚠ WARNING

- Before using this unit, make sure to read the instructions below, and the Owner's Manual.
- Do not open (or modify in any way) the unit or its AC adaptor.
- Do not attempt to repair the unit, or replace parts within it (except when this manual provides specific instructions directing you to do so). Refer all servicing to your retailer, the nearest Roland Service Center, or an authorized Roland distributor, as listed on the "Information" page.
- Never use or store the unit in places that are:
 - Subject to temperature extremes (e.g., direct sunlight in an enclosed vehicle, near a heating duct, on top of heat-generating equipment); or are
 - Damp (e.g., baths, washrooms, on wet floors); or are
 - Humid; or are
 - Exposed to rain; or are
 - Dusty; or are
 - Subject to high levels of vibration.
- This unit should be used only with a rack-mount adaptor (RAD-99) or stand (PDS-10) that is recommended by Roland. (p. 98)
- When using the unit with a stand (PDS-10) recommended by Roland, the stand must be carefully placed so it is level and sure to remain stable. If not using a stand, you still need to make sure that any location you choose for placing the unit provides a level surface that will properly support the unit, and keep it from wobbling.

⚠ WARNING

- Be sure to use only the AC adaptor supplied with the unit. Also, make sure the line voltage at the installation matches the input voltage specified on the AC adaptor's body. Other AC adaptors may use a different polarity, or be designed for a different voltage, so their use could result in damage, malfunction, or electric shock.
- Connect only the specified device (FC-300) to the RRC2 IN connector (which provide a supply of power).
- Use only the attached power-supply cord. Also, the supplied power cord must not be used with any other device.
- Do not excessively twist or bend the power cord, nor place heavy objects on it. Doing so can damage the cord, producing severed elements and short circuits. Damaged cords are fire and shock hazards!
- This unit, either alone or in combination with an amplifier and headphones or speakers, may be capable of producing sound levels that could cause permanent hearing loss. Do not operate for a long period of time at a high volume level, or at a level that is uncomfortable. If you experience any hearing loss or ringing in the ears, you should immediately stop using the unit, and consult an audiologist.
- Do not allow any objects (e.g., flammable material, coins, pins); or liquids of any kind (water, soft drinks, etc.) to penetrate the unit.

⚠ WARNING

- Immediately turn the power off, remove the AC adaptor from the outlet, and request servicing by your retailer, the nearest Roland Service Center, or an authorized Roland distributor, as listed on the “Information” page when:
 - The AC adaptor, the power-supply cord, or the plug has been damaged; or
 - If smoke or unusual odor occurs
 - Objects have fallen into, or liquid has been spilled onto the unit; or
 - The unit has been exposed to rain (or otherwise has become wet); or
 - The unit does not appear to operate normally or exhibits a marked change in performance.



- In households with small children, an adult should provide supervision until the child is capable of following all the rules essential for the safe operation of the unit.



- Protect the unit from strong impact. (Do not drop it!)



- Do not force the unit’s power-supply cord to share an outlet with an unreasonable number of other devices. Be especially careful when using extension cords—the total power used by all devices you have connected to the extension cord’s outlet must never exceed the power rating (watts/amperes) for the extension cord. Excessive loads can cause the insulation on the cord to heat up and eventually melt through.



- Before using the unit in a foreign country, consult with your retailer, the nearest Roland Service Center, or an authorized Roland distributor, as listed on the “Information” page.



- DO NOT play a CD-ROM disc on a conventional audio CD player. The resulting sound may be of a level that could cause permanent hearing loss. Damage to speakers or other system components may result.



⚠ CAUTION

- The unit and the AC adaptor should be located so their location or position does not interfere with their proper ventilation.



- This VG-99 for use only with Roland rack-mount adaptor RAD-99 or Stand PDS-10. Use with other rack-mount adaptors or stands are capable of resulting in instability causing possible injury.



- Always grasp only the plug on the AC adaptor cord when plugging into, or unplugging from, an outlet or this unit.



⚠ CAUTION

- At regular intervals, you should unplug the AC adaptor and clean it by using a dry cloth to wipe all dust and other accumulations away from its prongs. Also, disconnect the power plug from the power outlet whenever the unit is to remain unused for an extended period of time. Any accumulation of dust between the power plug and the power outlet can result in poor insulation and lead to fire.



- Try to prevent cords and cables from becoming entangled. Also, all cords and cables should be placed so they are out of the reach of children.



- Never climb on top of, nor place heavy objects on the unit.



- Never handle the AC adaptor or its plugs with wet hands when plugging into, or unplugging from, an outlet or this unit.



- If you need to move the instrument, take note of the precautions listed below. It should be handled carefully, all the while keeping it level. Make sure to have a firm grip, to protect yourself from injury and the instrument from damage.



- Check to make sure the screws or the attached knob bolts securing the unit to the stand have not become loose. Fasten them again securely whenever you notice any loosening.

- Disconnect the power cord.

- Disconnect all cords coming from external devices.

- Before cleaning the unit, turn off the power and unplug the AC adaptor from the outlet (p. 24).



- Whenever you suspect the possibility of lightning in your area, disconnect the AC adaptor from the outlet.



- Keep any screws you may remove and the included screws in a safe place out of children’s reach, so there is no chance of them being swallowed accidentally.



IMPORTANT NOTES

In addition to the items listed under “USING THE UNIT SAFELY” on page 2–3, please read and observe the following:

Power Supply

- Do not connect this unit to same electrical outlet that is being used by an electrical appliance that is controlled by an inverter (such as a refrigerator, washing machine, microwave oven, or air conditioner), or that contains a motor. Depending on the way in which the electrical appliance is used, power supply noise may cause this unit to malfunction or may produce audible noise. If it is not practical to use a separate electrical outlet, connect a power supply noise filter between this unit and the electrical outlet.
- The AC adaptor will begin to generate heat after long hours of consecutive use. This is normal, and is not a cause for concern.
- Before connecting this unit to other devices, turn off the power to all units. This will help prevent malfunctions and/or damage to speakers or other devices.

Placement

- Using the unit near power amplifiers (or other equipment containing large power transformers) may induce hum. To alleviate the problem, change the orientation of this unit; or move it farther away from the source of interference.
- This device may interfere with radio and television reception. Do not use this device in the vicinity of such receivers.
- Noise may be produced if wireless communications devices, such as cell phones, are operated in the vicinity of this unit. Such noise could occur when receiving or initiating a call, or while conversing. Should you experience such problems, you should relocate such wireless devices so they are at a greater distance from this unit, or switch them off.
- Do not expose the unit to direct sunlight, place it near devices that radiate heat, leave it inside an enclosed vehicle, or otherwise subject it to temperature extremes. Excessive heat can deform or discolor the unit.
- When moved from one location to another where the temperature and/or humidity is very different, water droplets (condensation) may form inside the unit. Damage or malfunction may result if you attempt to use the unit in this condition. Therefore, before using the unit, you must allow it to stand for several hours, until the condensation has completely evaporated.

- Depending on the material and temperature of the surface on which you place the unit, its rubber feet may discolor or mar the surface.
You can place a piece of felt or cloth under the rubber feet to prevent this from happening. If you do so, please make sure that the unit will not slip or move accidentally.

Maintenance

- For everyday cleaning wipe the unit with a soft, dry cloth or one that has been slightly dampened with water. To remove stubborn dirt, use a cloth impregnated with a mild, non-abrasive detergent. Afterwards, be sure to wipe the unit thoroughly with a soft, dry cloth.
- Never use benzine, thinners, alcohol or solvents of any kind, to avoid the possibility of discoloration and/or deformation.

Repairs and Data

- Please be aware that all data contained in the unit’s memory may be lost when the unit is sent for repairs. Important data should always be backed up on another MIDI device (e.g., a sequencer), or written down on paper (when possible). During repairs, due care is taken to avoid the loss of data. However, in certain cases (such as when circuitry related to memory itself is out of order), we regret that it may not be possible to restore the data, and Roland assumes no liability concerning such loss of data.

Additional Precautions

- Please be aware that the contents of memory can be irretrievably lost as a result of a malfunction, or the improper operation of the unit. To protect yourself against the risk of losing important data, we recommend that you periodically save a backup copy of important data you have stored in the unit’s memory in another MIDI device (e.g., a sequencer).
- Unfortunately, it may be impossible to restore the contents of data that was stored in another MIDI device (e.g., a sequencer), once it has been lost. Roland Corporation assumes no liability concerning such loss of data.
- Use a reasonable amount of care when using the unit’s buttons, sliders, or other controls; and when using its jacks and connectors. Rough handling can lead to malfunctions.
- Never strike or apply strong pressure to the display.
- When connecting / disconnecting all cables, grasp the connector itself—never pull on the cable. This way you will avoid causing shorts, or damage to the cable’s internal elements.
- To avoid disturbing your neighbors, try to keep the unit’s volume at reasonable levels. You may prefer to use headphones, so you do not need to be concerned about those around you (especially when it is late at night).

- When you need to transport the unit, package it in the box (including padding) that it came in, if possible. Otherwise, you will need to use equivalent packaging materials.
- Use only the specified expression pedal (Roland EV-5, BOSS FV-500L/500H with a connection cable (stereo 1/4" phone – stereo 1/4" phone); sold separately). By connecting any other expression pedals, you risk causing malfunction and/or damage to the unit.
- Some connection cables contain resistors. Do not use cables that incorporate resistors for connecting to this unit. The use of such cables can cause the sound level to be extremely low, or impossible to hear. For information on cable specifications, contact the manufacturer of the cable.
- Unauthorized duplication, reproduction, hiring, and lending prohibited.
- The usable range of D Beam controller will become extremely small when used under strong direct sunlight. Please be aware of this when using the D Beam controller outside.
- The sensitivity of the D Beam controller will change depending on the amount of light in the vicinity of the unit. If it does not function as you expect, adjust the sensitivity as appropriate for the brightness of your location.
- Avoid touching or scratching the shiny underside (encoded surface) of the disc. Damaged or dirty CD-ROM discs may not be read properly. Keep your discs clean using a commercially available CD cleaner.
- In the interest of product improvement, the specifications, appearance of this unit and/or contents of this package are subject to change without prior notice.
- While under most conditions, a computer similar to the above will permit normal operation of the VG-99, Roland cannot guarantee compatibility solely on these factors. This is due to numerous variables that may influence the processing environment, such as differences in motherboard design and the particular combination of other devices involved.

Printing Conventions and icons in This Manual

Text or numerals enclosed in square brackets []	Indicate buttons. [WRITE] WRITE button
NOTE	Indicates information that you should be aware of when using the VG-99.
MEMO	Indicates supplementary information about an operation.
TIP	Indicates information about a convenient operation.
cf.  (p.**)	Indicates a reference page.

Contents

IMPORTANT NOTES	4
Main Features	11
Ultimate guitar modeling system provides unlimited possibilities in creating sounds.....	11
Two complete sound creation systems	11
Equipped with D-Beam, ribbon, and other new realtime controllers	11
Console style accommodates a variety of usage environments.....	11
Combine with the FC-300 to create the perfect live system.....	11
Includes pitch/MIDI conversion function	11
Features V-LINK function.....	11
Names of Things and What They Do.....	12
Top Panel	12
Rear Panel	14
Chapter 1 Outputting Sounds	15
Installing the Divided Pickup	15
Before Connecting	15
Making the Connections.....	16
Turning On the Power	18
About the Play Screen	19
About the Information in the Display (Basic Operation)	19
Adjusting the Volume	20
Setting the Device (Amp) Connected to MAIN OUT (Output Select)	20
Inputting the Divided Pickup Settings (GK Settings)	21
Tuning the Guitar (TUNER)	22
Switching Tones (Patch)	23
About the Patch Numbers	23
Switching with the PATCH/VALUE Dial	24
Turning Off the Power.....	24
Chapter 2 Creating Sounds.....	25
Setting the COSM GUITAR Tone.....	25
Setting the Alternate Tuning.....	26
Setting AB LINK.....	26
Setting TUNING.....	27
Setting BEND.....	27
Setting 12-STRING	28
Setting USER TUNING	29
Setting DETUNE	29
Setting HARMONY	30
Setting the COSM AMP Tone	30
Setting the Effects	31
POLY FX (Poly Effect)	31
FX (Effects)	31
Rearranging the Effect and Amp Connection Sequence (CHAIN).....	32
Specifying the tempo and key of the song to be played	32
Setting the Tempo	32
Setting the Key.....	33
Mixing the Normal Pickup Sound	33
Setting the Volume Balance	33
Setting the Point at Which the COSM Guitar is Connected.....	34
Mixing Two Tones (MIXER)	35
Setting the Volume and Panning for Each Channel.....	35
Setting the Mix Balance	35
Setting the Delay and Reverb (DELAY/REVERB).....	35
Using Picking Dynamics to Control the Mix Between the Two Channels (DYNAMIC).....	36

Setting the Overall Patch Volume Level (PATCH LEVEL)	36
Adjusting the Overall Patch Tone (TOTAL EQ).....	36
Setting the Output Signal and Level (OUTPUT)	37
Naming a Patch (PATCH NAME)	37
Saving a Patch (WRITE)	38
Chapter 3 Creating Your Own Effect Types (CUSTOMIZE)	39
Customizing the Preamp.....	39
Customizing the Speaker	40
Customizing the Overdrive/Distortion	40
Customizing Pedal Wah.....	41
Chapter 4 Global Device Settings (SYSTEM)	42
Inputting the Divided Pickup Settings.....	42
Selecting the Settings	42
Naming GK Settings (GK NAME).....	42
Selecting the Divided Pickup Type	43
Inputting the Guitar's Scale	43
Matching the Divided Pickup and Normal Pickup Phase	43
Setting the Direction for the Installed Divided Pickup	43
Setting the DOWN/S1, UP/S2 Switch Arrangement.....	44
Setting the Gap Between the Pickup and the Bridge (PICKUP ^ BRIDGE)	44
Adjusting the Sensitivity for Each String	45
Setting Whether or Not the Divided Pickup Is Used (GK CONNECT)	45
Using Different Guitar Settings in Each Patch (SET MODE).....	46
Determining the Function of the GK Volume Control and DOWN/S1, UP/S2 Switches (GK FUNC)	46
Adjusting Overall Tone According to the Environment (GLOBAL/OUTPUT SELECT)	46
Selecting the Settings	46
Naming the Settings (GLOBAL NAME).....	47
Setting the Types of Connected Devices (OUTPUT SELECT).....	47
Adjusting the Overall Tone (GLOBAL EQ)	48
Controlling the Overall Effect of the Noise Suppressor (Total NS)	48
Controlling the Overall Reverb Level (Total REVERB).....	49
Setting the Sounds Output from SUB OUT (SUB OUT LEVEL)	49
Setting the GK VOLUME Control and Switch and the Pedal Function (SYSTEM CONTROL ASSIGN).....	49
Having Values from an External Pedal, GK VOLUME Control, or Other Controller Carried Over When Patches are Called Up (ASSIGN HOLD)	50
Limiting the Patches That Can Be Switched (PATCH EXTENT)	50
Adjusting the Screen's Contrast	51
Setting the Output Signal and Level (SYSTEM OUTPUT).....	51
Chapter 5 Using the VG-99 in Combination with an FC-300	52
Connecting with the RRC2 IN Connector.....	52
Settings Related to the FC-300	52
Settings for Control of the FC-300	52
Setting the Operation When Patches Are Switched	53
Activating the VG-99's Tuner from the FC-300 (QUICK TUNER)	53
Setting the FC-300 Amp Control	54
Chapter 6 Using MIDI	55
About MIDI	55
What You Can Do Using MIDI	55
Main Types of MIDI Messages Handled by the VG-99	56
About the MIDI Implementation	57
Exchanging MIDI Messages	57

About MIDI Channels 57
 Bank Select and Program Change..... 58
 Setting the MIDI-Related Functions 58
 Syncing to the MIDI CLOCK from an External Device 64
 Playing an External Synthesizer Sound Module (GUITAR TO MIDI)..... 64
 Setting the GUITAR TO MIDI Function (System Parameters)..... 64
 Setting the GUITAR TO MIDI Function (Patch Parameters)..... 67

Chapter 7 Using the VG-99 Connected to a Computer Via USB.....71

Before Using the USB Connection..... 71
 Switching the Driver Mode 72
 Setting the USB Functions..... 73
 Setting the Digital Audio Signal Input and Output..... 73
 Setting the Direct Monitor 74
 Recording the VG-99's Output with a Computer..... 75
 Using the VG-99 to Add Effects to Audio Playback from a Computer..... 75

Chapter 8 Other Functions.....76

Changing the Tone in Real Time with the D Beam and Ribbon Controllers..... 76
 Adjusting the D Beam (CALIBRATION)..... 76
 Disabling the D Beam (DISABLE) 77
 Controlling Sounds by Hand Motion or the Guitar Neck (D Beam Controller)..... 77
 Adjusting the Ribbon Controller (CALIBRATION)..... 78
 Controlling the Sounds with the Movement of Your Fingertip (Ribbon Controller) 79
 Holding Sounds for Extended Periods (FREEZE)..... 79
 Changing the Pitch as with a Tremolo Arm (T-ARM)..... 80
 Adding Nuance to the Sound (FILTER) 81
 Changing the Sounds with the Knobs as You Play (DIRECT EDIT) 82
 Using the Switches, Pedals, and MIDI to Control the Sounds (CONTROL ASSIGN)..... 82
 One Touch Call Up of Favorite Patches (DIRECT PATCH)..... 86
 Setting DIRECT PATCH 86
 Managing the Patches..... 87
 Copying the Current Patch to a Different Patch (PATCH COPY)..... 87
 Exchanging the Current Patch with a Different Patch (PATCH EXCHANGE) 87
 Initializing User Patches (PATCH INITIALIZE) 88
 Copying Settings Between Channel A and Channel B (A/B COPY) 88
 Exchanging the Channel A and Channel B Settings (A/B EXCHANGE) 88
 Partially Copying Parameters in a Different Patch (MODULE COPY) 89
 Partially Initializing Patch Parameters (MODULE INITIALIZE)..... 89
 Separating Patches into Groups (CATEGORY) 90
 Using CATEGORY to Call Up Patches 90
 Setting Patch Categories..... 90
 Naming User Categories (CATEGORY NAME) 91
 Storing Your Preferred Settings Individually (FAVORITE SETTINGS)..... 91
 What are Favorite Settings? 91
 Calling Up Favorite Settings..... 92
 Changing Tone Settings 92
 Saving Changed Tones..... 93
 Naming Favorite Settings (FAVORITE NAME)..... 94
 Searching for Patches That Use the Same Favorite Settings 94
 Activating the Virtual Expression Pedal at the Start of Operations (Internal Pedal System) 95
 Internal Pedal..... 95
 Wave Pedal 95
 Controlling Video Images with Your Guitar (V-LINK)..... 96
 What is V-LINK? 96
 Connecting the V-LINK Device 96
 Switching V-LINK On and Off..... 96

Setting V-LINK 97
 Using the VG-99 on a Stand 98
 Using the VG-99 Mounted in a Rack 99
 Restoring the VG-99 to its Original Factory Condition (FACTORY RESET)..... 100

Chapter 9 Parameters Guide..... 101

COSM GUITAR 101
 Modeling Type List..... 101
 ALTERNATE TUNING..... 116
 POLY FX (Poly Effect)..... 118
 FX (Effects)..... 120
 Using the HOLD (Hold Delay) 125
 PHASER..... 127
 FLANGER 128
 TREML (Tremolo) 128
 PAN..... 128
 T.WAH (Touch Wah)..... 129
 AUTO WAH 129
 OCTAVE..... 129
 PITCH SHIFT (Pitch Shifter) 130
 HARMONIST 130
 Creating Harmonist Scales (User Scale)..... 131
 PEDAL BEND..... 132
 2x2 CHORUS 132
 ROTARY..... 133
 UNI-V..... 133
 VIB (Vibrato)..... 133
 SLICER..... 134
 HUMANIZER..... 134
 SLOW GEAR..... 135
 DEFRET 135
 FEEDBACKER..... 135
 RING MOD (Ring Modulator)..... 136
 ANTI FB (Anti-feedback)..... 136
 ADV.COMP (Advanced Compressor)..... 136
 LIMITR (Limiter)..... 137
 SUB EQ (Sub Equalizer)..... 137
 SUB DELAY (Sub Delay) 138
 COSM AMP 140
 MIXER 146
 MIXER A, B (MIXER CHANNEL A, B) 146
 PATCH LEVEL..... 146
 TOTAL EQ 146
 OUTPUT 147
 DELAY 148
 MASTER 150
 GK VOL (GK Volume) 150
 GK S1, S2 (DOWN/S1, UP/S2 Switch)..... 150
 PANEL CTL1/CTL2 (Control Button 1/2) 151
 D BEAM..... 151
 RIBBON 153
 EXP PEDAL (Expression Pedal)..... 154
 CTL3, CTL4 (Control3, Control4) 154
 FC-300 CONTROL 155
 ASSIGN 1-16..... 155
 DIRECT EDIT F1-F6..... 156
 GUITAR TO MIDI..... 164

SYSTEM	166
Parameters That Can Be Assigned to Separate Controllers	168
V-LINK PATCH	174
V-LINK SYSTEM.....	176
GLOBAL	177
TUNER.....	178
Chapter 10 Appendices	179
MIDI Implementation Chart	179
Signal Flow	183
Specifications.....	184
VG-99: V-Guitar System.....	184
VG-99 Software System Requirements	185
For Windows	185
For Mac OS.....	185
Error Messages.....	186
Troubleshooting.....	186
Problems with Sounds.....	186
Other Problems.....	188
Index.....	189

Main Features

Ultimate guitar modeling system provides unlimited possibilities in creating sounds

The VG-99 is the culmination of Roland's COSM technology based guitar modeling systems. Featuring advanced software supported by the very latest custom DSP chips, the instrument also offers a large-sized high-contrast LCD, top-quality AD/DA converters, balanced XLR output connectors, digital output connectors, USB connector, and other features that all add up to a truly pro-spec system.

About COSM (Composite Object Sound Modeling)

Composite Object Sound Modeling—or "COSM" for short—is BOSS/Roland's innovative and powerful technology that's used to digitally recreate the sound of classic musical instruments and effects. COSM analyzes the many factors that make up the original sound—including its electrical and physical characteristics—and creates a digital model that accurately reproduces the original.

Two complete sound creation systems

The VG-99 features two separate guitar and COSM amp systems. You can use two different types of modeled guitars simultaneously and create different amp sounds to use with each guitar. What's more, the VG-99 comes equipped with two effects systems featuring a huge selection of BOSS effects, including COSM effects. This all enables you to achieve the perfect processing for each individual guitar.

Equipped with D-Beam, ribbon, and other new realtime controllers

The VG-99 now enables new and heretofore unimaginable forms of musical expression, including new ways of using the guitar's neck and your hands. Of course, you can still connect expression pedals and control switches as well, just as with previous V-Guitar systems.

Console style accommodates a variety of usage environments

The VG-99 can be set up in a number of different ways to suit the needs of the user—as a desktop unit for recording or when using computer input, attached to its stand (optional) and set up right by the performer, or placed in a rack with the (optional) rack mount adaptor.

Combine with the FC-300 to create the perfect live system

Connecting a Roland FC-300 MIDI Foot Controller (optional) to the VG-99 allows you to switch tones and carry out other tasks using the FC-300's multiple foot pedals for easy hands-free operation. These units also feature an RRC2 connector, allowing you to connect the VG-99 and FC-300 with a single cable. This RRC2 function enables two-way communications between the devices, while further acting as a power supply to the FC-300, thus reducing the number of cables used to connect the devices.

Includes pitch/MIDI conversion function

The VG-99 can convert and output guitar performance data as MIDI information, allowing you to connect a synthesizer sound module or similar device and use the setup as a guitar synthesizer.

Features V-LINK function

This function enables you to use performance data and pedal operations in controlling video.

V-LINK

V-LINK is a function that allows music and images to be performed together. By using MIDI to connect two or more V-LINK compatible devices, you can easily enjoy a wide range of visual effects that are linked to the expressive elements of a music performance.

Names of Things and What They Do

Top Panel

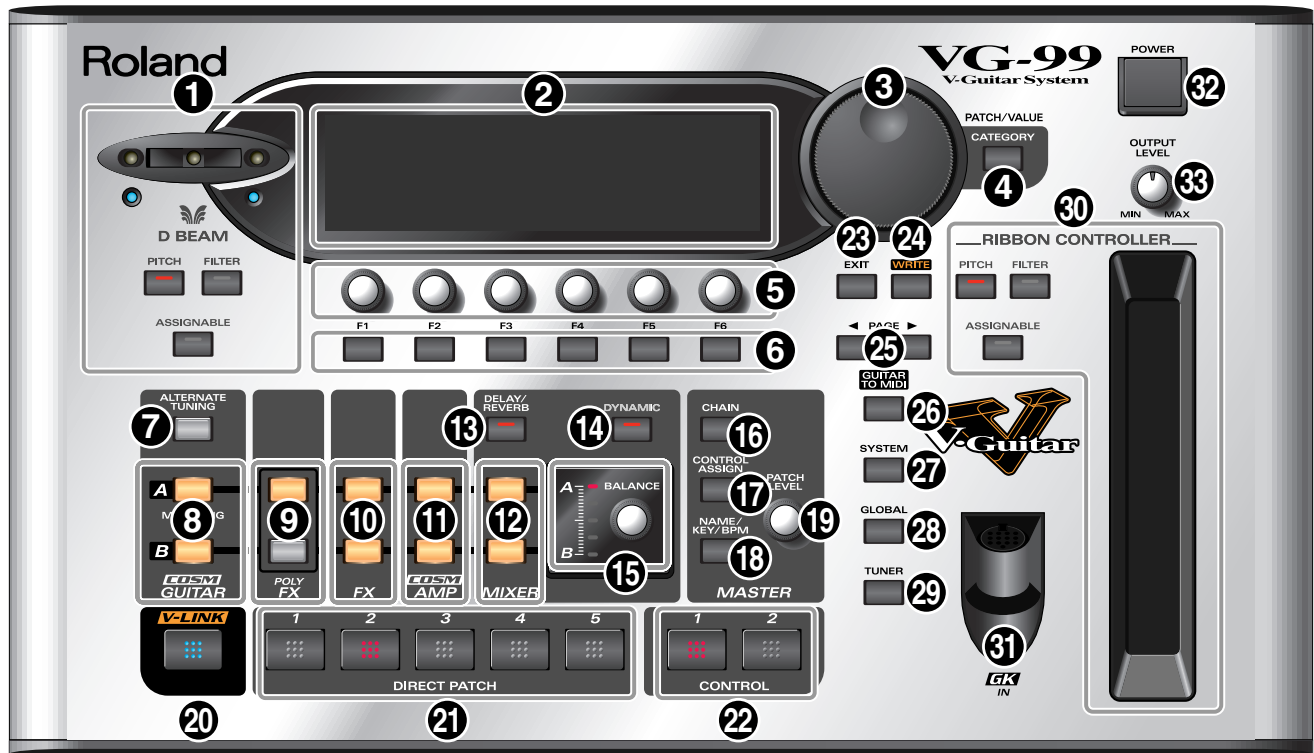

1. D BEAM

Switches the D Beam on and off. You can add a variety of effects to your sounds by moving your hand or the guitar neck within the range of the beam. (p. 76)

- **PITCH Button**
In addition to changing the pitch of the guitar, this can be used for the Freeze function, which continuously holds the guitar's tone.
- **FILTER Button**
This changes the guitar's tone.
- **ASSIGNABLE Button**
Use this to assign different parameters and functions to the D-Beam and change the tone in real time.

2. LCD

Various information regarding the VG-99 is indicated here.

3. PATCH/VALUE Dial

Used to switch patches and change settings values.

4. CATEGORY Button

Used to select and change categories.

5. FUNCTION Knob

Changes the value of the setting for the parameter indicated in the LCD.

6. FUNCTION Buttons

Used to select the parameters indicated in the LCD.

7. ALTERNATE TUNING Button

Sets the Alternate Tuning function. (p. 26)

8. MODELING TYPE Buttons

These set the COSM guitar type and tone. (p. 25)

9. POLY FX (Poly Effects) Buttons

These set the poly effects. (p. 31)

10. FX (Effects) Buttons

These set the effects. (p. 31)

11. COSM AMP Buttons

Used to make settings for the COSM amp. (p. 30)

12. MIXER Buttons

Used to make settings for the mixer. (p. 35)

13. DELAY/REVERB Button

Used to make settings for the mixer section's delay and reverb. (p. 35)

14. DYNAMIC Button

Used for setting the dynamics. (p. 36)

15. BALANCE Knob

Sets the mix balance. (p. 35)

16. CHAIN Button

Used to make settings for the effect and COSM guitar/COSM amp connection sequence. (p. 34)

17. CONTROL ASSIGN Button

This sets the functions assigned to pedals and switches. (p. 82)

18. NAME/KEY/BPM Button

Used to specify patch names and the tempo and key for songs to be played. (p. 32)

19. PATCH LEVEL Knob

Adjusts the volume of a patch.

20. V-LINK Button

This switches the V-LINK function on and off. (p. 96)

21. DIRECT PATCH Buttons

Use these to directly call up the patches you have assigned to them. (p. 86)

22. CONTROL Buttons

You can assign and control a variety of different functions with these buttons. (p. 82)

23. EXIT Button

Used to return previous screens and to undo operations.

24. WRITE Button

Use for storing settings in patches and executing operations. (p. 38) (p. 87)

25. PAGE Buttons

This switches the screens displayed in the LCD.

26. GUITAR TO MIDI Button

This sets the GUITAR TO MIDI function (the function that converts what is played on the guitar into MIDI signals). (p. 64)

27. SYSTEM Button

Used for making settings related to the VG-99's operating environment. (p. 42)

28. GLOBAL Button

This sets the GLOBAL function (which affects the tone of all patches). (p. 46)

29. TUNER Button

This turns the tuning function on. (p. 22)

30. RIBBON CONTROLLER

This allows you to change the tone by sliding your finger along the ribbon. (p. 77)

You can switch a variety of effects on and off directly with the three buttons.

- **PITCH Button**
Changes the guitar's pitch.
- **FILTER Button**
Alters the brightness of the sound.
- **ASSIGNABLE Button**
Use this to assign different parameters and functions to the ribbon controller and change the tone in real time. (p. 82)

31. GK IN Connector

Connect the GK cable here.

32. POWER Switch

Switches the power on and off. (p. 18) (p. 24)

33. OUTPUT LEVEL Knob

This adjusts the volume level for the MAIN OUT jacks and headphone jack.

Rear Panel



1. Security Slot ()

Connect a commercially available anti-theft security cable here.

<http://www.kensington.com/>

2. GUITAR INPUT Jack

Use this jack when directly inputting a normal guitar.

3. GUITAR OUTPUT Jack

This outputs sounds from normal guitars connected to a GK-3 and unaltered signals from the GUITAR INPUT jack.

4. SUB OUT Connectors L, R

These balanced output jacks use XLR type connectors.

- * The SUB OUT L and R connectors are unaffected by the OUTPUT LEVEL knob settings; output is constant at a fixed output level (+4 dBu).

5. GND LIFT Switch

You can disconnect the SUB OUT connectors' No. 1 pin from the VG-99's ground.

Switch this to LIFT if a ground loop or similar problem is causing output of hum or noise. Normally, this is set to GND.

6. MAIN OUT Jacks L/MONO, R

These are unbalanced phone jack outputs. Use these to connect to amps, mixers, and similar equipment.

7. PHONES Jack

Connect headphones here.

8. DIGITAL OUT Connector

Digital audio signals are output here. (p. 37) (p. 147)

9. EXP PEDAL (EXPRESSION PEDAL) Jack

Connect an optional expression pedal (such as a Roland EV-5) here. (p. 16)

- * The VG-99 is set at the factory so that the pedal is automatically enabled to function as a foot volume.

10. CTL3,4 (CONTROL 3,4) Jack

An optional footswitch (such as an FS-6) can be connected here. (p. 16)

- * The patch up/down function is assigned to this jack at the factory.

11. USB Connector

Use a USB cable to connect a computer to this connector and enable exchange of data between the VG-99 and the computer. (p. 71)

12. RRC2 IN Connector

Accepts connection of an FC-300 (optional).

This connector supplies power to the FC-300 and provides for two-way communications with it. (p. 52)

- * The RRC2 IN connector is for use exclusively with the FC-300. It cannot be used with other devices.

13. MIDI OUT, IN Connector

Connect an external MIDI device here to transmit and receive MIDI messages to and from the device. (p. 58)

14. DC IN (AC Adaptor) Jack

Connect the included AC adaptor here.

To prevent damaging the VG-99, please be sure not to use any AC adaptor other than the one included with the VG-99.

15. Cord Hook

Fasten the AC adaptor cord using this hook to prevent the cord from being disconnected accidentally. (p. 17)

- * Disconnecting the AC adaptor while the VG-99 is in use may result in corruption of important data.

Chapter 1 Outputting Sounds

Installing the Divided Pickup

First install the GK-3 divided pickup (optional) on the guitar to be used. For installation instructions, refer to the GK-3 Owner's Manual.

NOTE

The GK-3 cannot be used with the following guitars (the pickup will not function properly even when installed).

- 12-string guitars, pedal steel guitars, and guitars with other than six strings
- Nylon-stringed or gut-stringed guitars and guitars using any non-steel strings
- Bass guitars
- Other guitars whose construction does not provide adequate space to properly attach the GK-3

About the GK-3's GK Volume Control

With the VG-99, you can assign various different functions to the GK-3's GK volume control. p. 82

You may not be able to control the VG-99's volume level with the GK volume control another parameter is assigned to the GK volume control.

About the GK-3's Select Switches

As the VG-99 allows you to set the balance between the COSM guitar and the normal guitar volume in each individual patch, we recommend that MIX be the basic function used for the select switch. Also note that if a parameter other than volume is assigned as the GK volume control function, the GK-3's select switch will stop functioning normally.

Before Connecting

To perform with the VG-99, first set up the following devices.

- A guitar on which the GK-3 has been installed or equipped with internal GK function
- Guitar amp/speaker or headphones

Performing can be made even more convenient using the following devices:

- MIDI foot controller (Roland FC-300; optional)
- Expression pedal (Roland EV-5 or BOSS FV-500L/500H with a connection cable (stereo 1/4" phone – stereo 1/4" phone); optional)
- Pedal switch (BOSS FS-5U or FS-6; optional)

Making the Connections

Top Panel

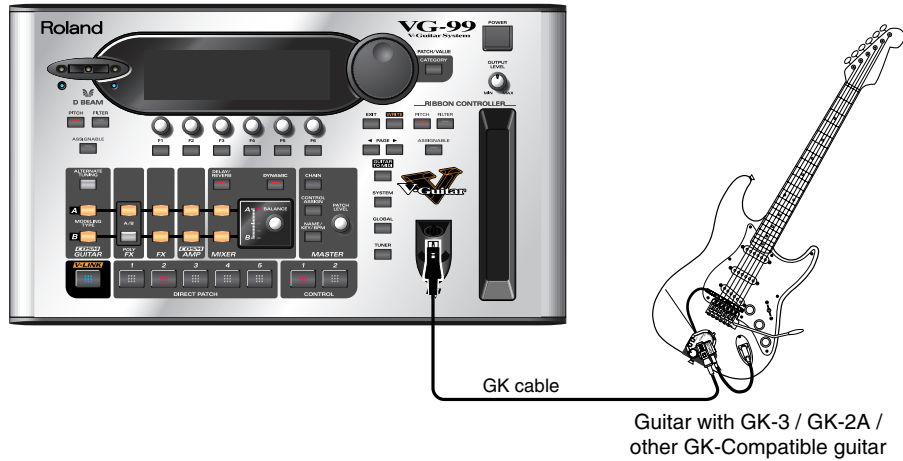

Rear Panel

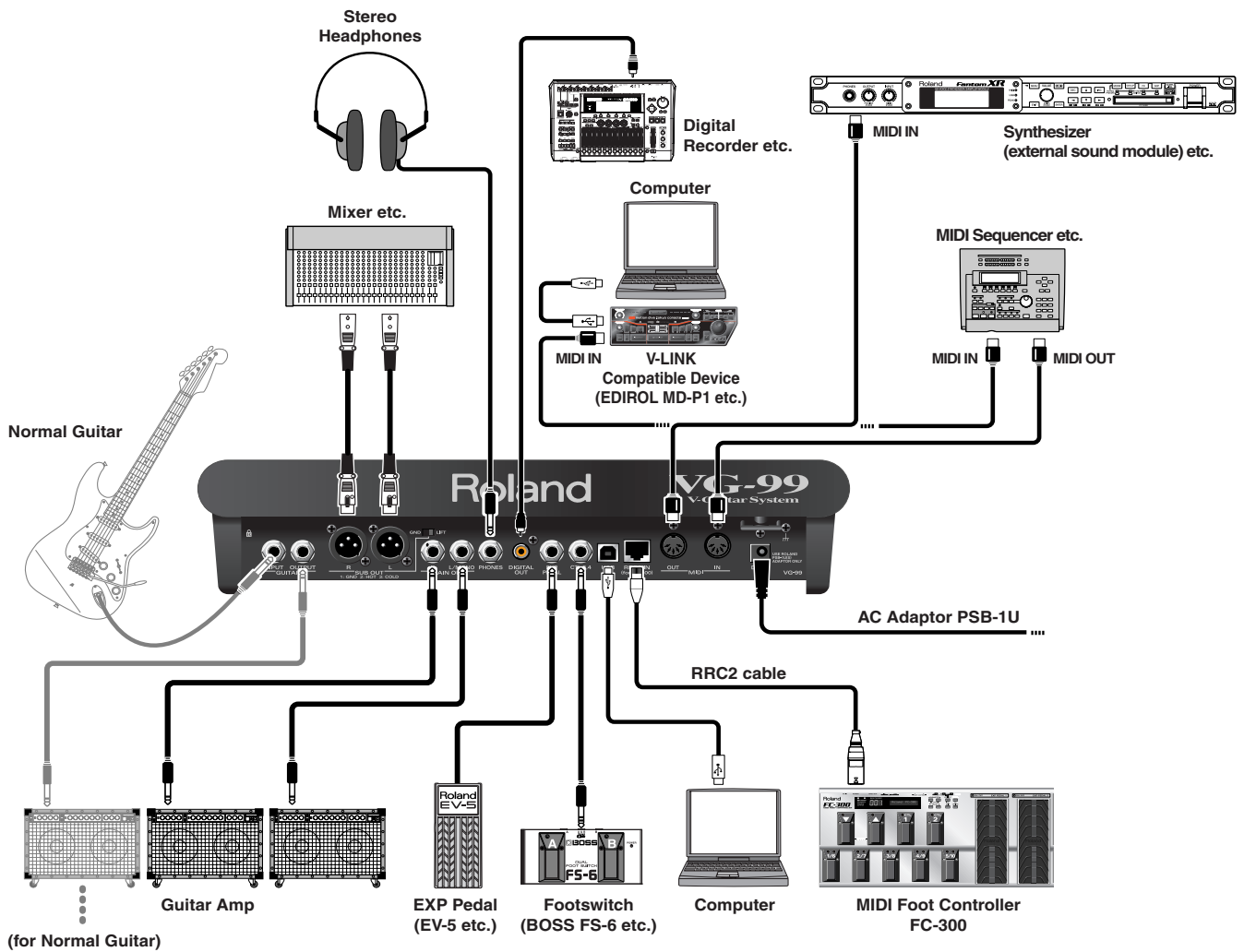

- To prevent malfunction and/or damage to speakers or other devices, always turn down the volume, and turn off the power on all devices before making any connections.
- This instrument is equipped with balanced type jacks (TRS=CTL3,4; XLR=SUB OUT). Wiring diagrams for these jacks are shown below. Make connections after first checking the wiring diagrams of other equipment you intend to connect.

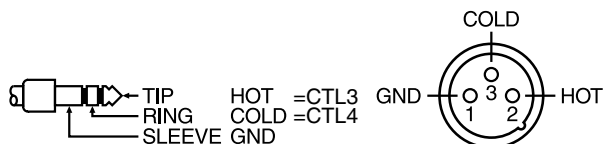

- To prevent the inadvertent disruption of power to your unit (should the plug be pulled out accidentally), and to avoid applying undue stress to the AC adaptor jack, anchor the power cord using the cord hook, as shown in the illustration.

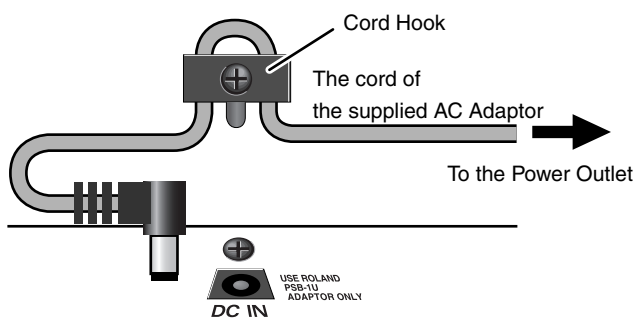

- Use only the specified expression pedal (Roland EV-5, BOSS FS-500L/500H with a connection cable (stereo 1/4" phone – stereo 1/4" phone); sold separately). By connecting any other expression pedals, you risk causing malfunction and/or damage to the unit.
- Depending on the circumstances of a particular setup, you may experience a discomforting sensation, or perceive that the surface feels gritty to the touch when you touch this device, microphones connected to it, or the metal portions of other objects, such as guitars. This is due to an infinitesimal electrical charge, which is absolutely harmless. However, if you are concerned about this, connect the ground terminal (see figure) with an external ground. When the unit is grounded, a slight hum may occur, depending on the particulars of your installation. If you are unsure of the connection method, contact the nearest Roland Service Center, or an authorized Roland distributor, as listed on the "Information" page.



Unsuitable places for connection

- Water pipes (may result in shock or electrocution)
- Gas pipes (may result in fire or explosion)
- Telephone-line ground or lightning rod (may be dangerous in the event of lightning)

- When connection cables with resistors are used, the volume level of equipment connected to the GUITAR INPUT may be low. If this happens, use connection cables that do not contain resistors.

* Never connect anything other than the FC-300's RRC2 OUT connector to the VG-99's RRC2 IN connector. Connecting to a LAN or other devices that use modular jacks of the same size and shape (RJ45) may result in damage to the VG-99 and/or the connected device.

* If using a commercially available ethernet cable as the RRC2 connecting cable, be sure that the cable meets the following specifications:

- Category 5 (Cat5) or above
- Maximum length of 15 meters
- Cable designed for straight-through connections

* Crossover cables cannot be used.

* Do not subject the ethernet cable to stress or physical shock.

* Carefully connect the RRC2 cable all the way in—until it is firmly connected to the RRC2 IN connector.

* When outputting in mono, connect a cable only to the MAIN OUT L/MONO jack.

* You cannot use COSM GUITAR or POLY FX with signals input via GUITAR IN. The GT-PRO's internal FX, COSM AMP, MIXER, and other settings can be used fully in two channels.

* When connecting an expression pedal to the EXP PEDAL jack, use the pedal with the minimum level at the MIN position.

* When connecting an FS-6 footswitch (optional) to the CTL3/4 jack, set the MODE switch and POLARITY switch as shown below.

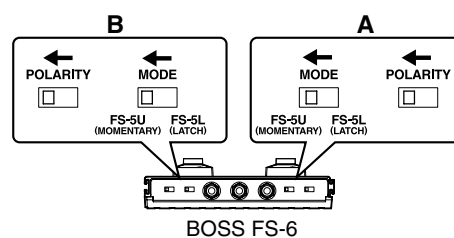

* When connecting an FS-5U footswitch (optional) to the CTL3/4 jack, set the POLARITY switch as shown below.

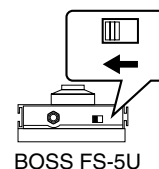

- * You can connect two FS-5Us using the special Roland PCS-31 connection cable (optional).
- * When an FS-6 is connected to the CTL3,4 jack with an optional connection cable (stereo 1/4" phone – stereo 1/4" phone), pedal switch B operates according to the CONTROL 3 settings, and pedal switch A operates according to the CONTROL 4 settings.

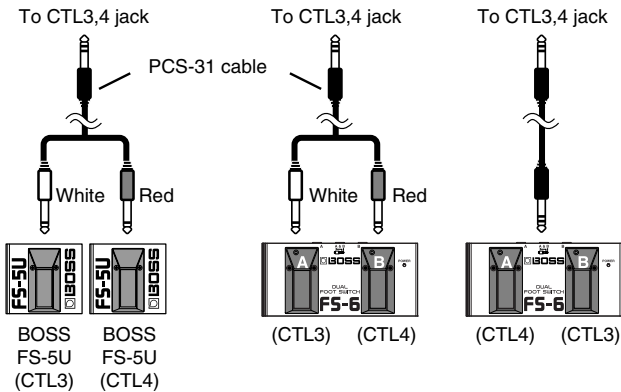

cf.

- When using the VG-99 with an expression pedal connected to the EXP PEDAL jack, make the settings described on p. 154.
- When using the VG-99 with a footswitch connected to the CTL3/4 jack, make the settings described on p. 154.

Turning On the Power

Once the connections have been completed p. 16, turn on power to your various devices in the order specified. By turning on devices in the wrong order, you risk causing malfunction and/or damage to speakers and other devices.

- This unit is equipped with a protection circuit. A brief interval (a few seconds) after power up is required before the unit will operate normally.
- Always make sure to have the volume level turned down before switching on power. Even with the volume all the way down, you may still hear some sound when the power is switched on, but this is normal, and does not indicate a malfunction.
- * *Turning on devices in the wrong sequence may result in malfunction and/or damage to speakers and other devices.*

1. Switch on the POWER switch on the VG-99's top panel.

The display changes as described below, and after several seconds the VG-99 is ready for normal performance.

This screen is called the "Play screen."

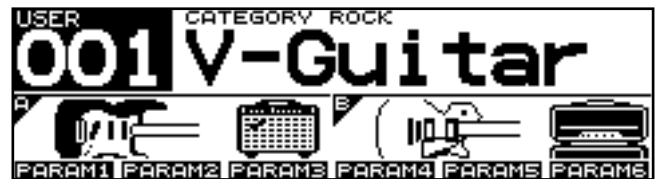

Unless special note is made otherwise, the operations described in this manual are carried out with the Play screen displayed.

- * *When the power to the VG-99 is turned on, the patch selected at the time the power was last turned off is called up.*
- The explanations in this manual include illustrations that depict what should typically be shown by the display. Note, however, that your unit may incorporate a newer, enhanced version of the system (e.g., includes newer sounds), so what you actually see in the display may not always match what appears in the manual.

2. Turn on the power to the guitar amp or mixer.

- * *Raise amp volume levels only after turning on the power to all the devices.*

About the Play Screen

The VG-99 has a variety of Play screen variations, each providing different information about the current state of the VG-99. You can switch the information shown in the Play screen by pressing PAGE [◀][▶].

Screen 1:

The first nine characters of the patch name are displayed in large type; also shown are icons for the guitars and amps in both channels.

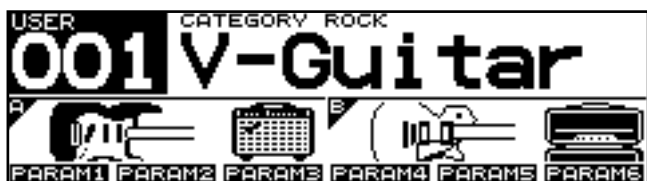

Screen 2:

All sixteen characters of the patch name are displayed.



Screen 3:

The effects used, as well as their connection sequence (CHAIN) in both channels are indicated.



Screen 4:

The screen shows level meters for the GK IN strings 1-6, normal pickup, MAIN OUT, and SUB OUT levels.

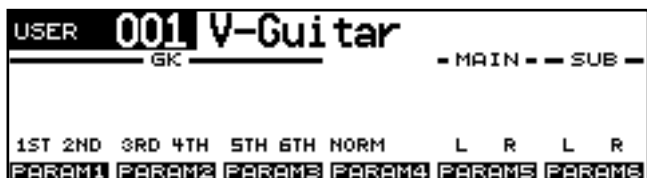

TIP

By assigning parameters to the F1-F6 knobs, as described in “Changing the Sounds with the Knobs as You Play (DIRECT EDIT)” (p. 82), you can use them to control values while in the Play screen. Additionally, you can display a popup for the assigned parameters and their values by pressing the [F1]-[F6] buttons.

About the Information in the Display (Basic Operation)

Some screens may contain parameters spanning multiple pages. The page number is indicated at the upper right of the screen.

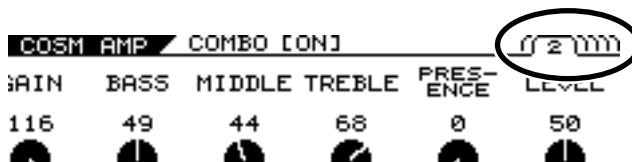

1. Use PAGE [◀][▶] to switch pages.
2. Use [F1]-[F6] or the F1-F6 knobs to change the values.

TIP

Pressing a FUNCTION button while SET** appears in the lower part of the screen sets the corresponding function to the indicated value of **.



Adjusting the Volume

Turn the OUTPUT LEVEL knob to set the volume to a suitable level.



- * The output from the SUB OUT connector (XLR type) remains constant, regardless of the OUTPUT LEVEL knob setting.
- * You can adjust the volume level by assigning this function to the expression pedal or GK-3 GK volume control. For details, see “Using the Switches, Pedals, and MIDI to Control the Sounds (CONTROL ASSIGN)” (p. 82).

Setting the Device (Amp) Connected to MAIN OUT (Output Select)

Use this procedure to set the type of device connected to the MAIN OUT jacks.

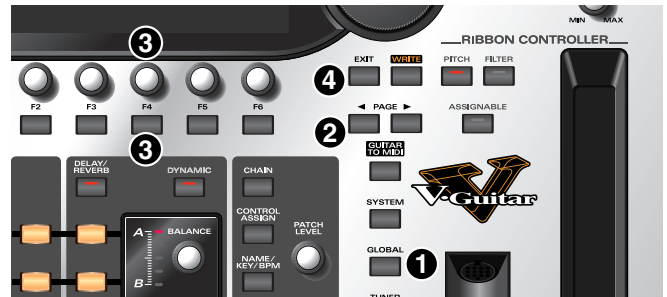

1. Press [GLOBAL].
The Global screen is displayed.



2. Press PAGE [◀] to go to Page 1.
3. Press [F4] (SELECT) or turn the F4 knob to set the type of device to be connected to the MAIN OUT jacks.

Value	Explanation
JC-120	Use this setting when connecting to Roland's JC-120 guitar amp.
SMALL AMP	Use this setting when connecting to a small guitar amp.
COMBO AMP	Use this setting when connecting to the guitar input of a combo amp other than the JC-120 guitar amp (where the amp and speaker or speakers are combined in a single unit). * Depending on your guitar amp, you may be able to obtain good results with the JC-120 setting.
STACK AMP	Use this setting when connecting to the guitar input of a stack-type guitar amp (where the amp and speaker or speakers are separated).
JC-120 Return	Use this setting when connecting to the RETURN of a JC-120.
COMBO Return	Use this setting when connecting to the RETURN of a combo amp.
STACK Return	Use this setting when connecting to the RETURN of a stack amp or the input of a rack mounted power amp. Set to STACK Return also when using a guitar power amp and speaker cabinet combination.
LINE/PHONES	Use this setting when using headphones or when connecting to a multi-track recorder for recording.

4. Press [EXIT] to return to the Play screen.

Inputting the Divided Pickup Settings (GK Settings)

The VG-99's sound characteristics vary greatly depending on how the divided pickup is installed. To ensure consistent conditions for optimal sound production, be sure to make the settings affecting the divided pickup (the GK settings). With these settings appropriately made, the VG-99 can then operate under optimal conditions.

* For information on parameters not described in this chapter, refer to "GK SETTING" (p. 166).

MEMO

When using more than one guitar with the VG-99, you can save the settings for each guitar separately.

NOTE

The GK settings are extremely important to getting good tones from the VG-99. Be sure to input the settings correctly.



1. Press [SYSTEM].

The System screen is displayed



2. Press PAGE [◀] to go to Page 1.

3. Press [F3] (GK).

The GK Settings screen is displayed.



4. Press PAGE [◀] [▶] to go to Page 2.

5. Select the divided pickup type.

Use the F1 knob to set the type of divided pickup installed in the guitar you are using.

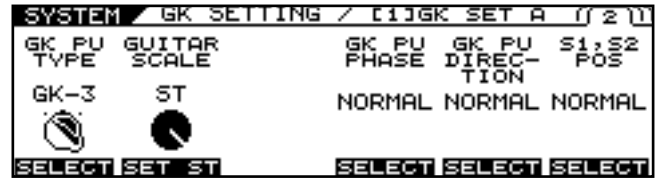

Settings	Explanation
GK-3	Specifies the GK-3.
GK-2A	Specifies the GK-2A.
PIEZO	Specifies a piezo pickup.

* Piezo pickups are a type of pickup that are installed at the guitar's bridge and use piezoelectric elements to determine the string vibrations.

6. Set the scale length.

Use the F3 knob to set the scale length (the distance from the bridge to the nut) of the guitar you are using. Select the closest value within the 620-660 mm range. 648 mm corresponds to the ST setting, 628 mm to the LP setting.

7. Press PAGE [◀] [▶] to go to Page 3.

8. Input the gap between the pickup and the bridge.

Set the clearance from the center of the divided pickup to the bridge's saddle.



* This setting is not required when piezo pickups are used.

9. Press PAGE [◀] [▶] to go to Page 4.

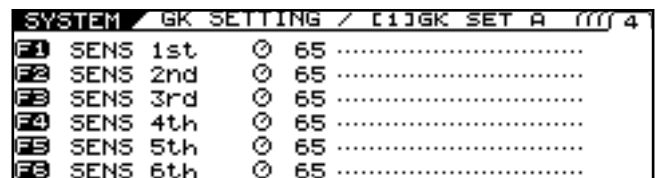

10. Rotate the F1-F6 knobs to adjust the divided pickup sensitivity for each string.

First play the sixth string with the maximum force to be used during actual performance, and as you play the string, set the sensitivity with the F1 knob until the meter registers at a point just before it crosses beyond the maximum level.

Set the sensitivity for the fifth through first strings in the same manner.

Chapter 1 Outputting Sounds

- * If the level meter registers in excess of the maximum level, it means the level is set too high. Lower the sensitivity setting.
- * Depending on the guitar you are using, the level meter may move to the maximum level even when the sensitivity is set to the minimum setting. If this occurs, adjust the clearance separating the divided pickup and the strings so the distance is slightly greater than specified.

11. Check the volume balance of the six strings.

Play the sixth through first strings with the normal amount of force; if any string sounds particularly loud, lower the sensitivity setting for that string, and keep adjusting until the differences in the strings' volume levels are minimal.

12. Press [EXIT] several times to return to the Play screen.

- * Making these settings is necessary whenever you install the divided pickup on a new or different guitar and when the divided pickup height is changed. Once the settings are completed properly, they are saved when the power is turned off. Afterwards, you need not make the settings each time you play the instrument.

cf.

For more information on other parameters in the GK Settings, refer to "GK SETTING" (p. 166).

Tuning the Guitar (TUNER)

Tune the guitar using the VG-99's tuner function.

- * To get the best tone quality from the VG-99, make sure the tuning is accurate.

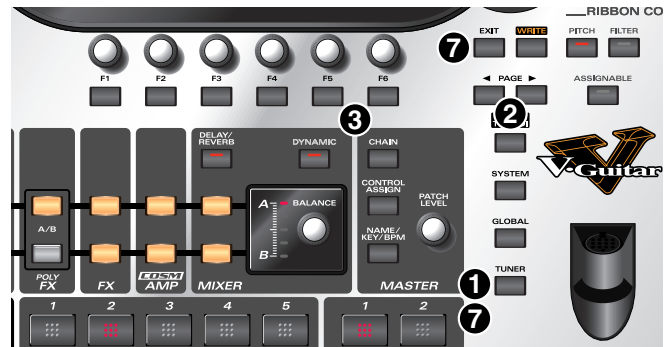

1. Press [TUNER].

The tuner function is switched on.

2. Set the following with the PAGE [◀] [▶] buttons.

TUNER	Explanation
MULTI MODE	You can play and tune six strings simultaneously.
SINGLE MODE	You can play one individual string to tune that string.

3. Press the function button ([F5] [F6]) corresponding to the function you want to set, then rotate the knobs to select the value for the setting.

If you do not want to change these settings, proceed to Step 4.

- [F5] (PITCH: 435 Hz–445 Hz)

This sets the reference pitch.

- * With the factory settings, this is set to 440 Hz.
- * This reference pitch is referenced by effects controlled by the KEY parameter.

TERM

What is the Reference Pitch?

This is the frequency at A4 (the note played with the A key at the middle of the piano keyboard) played by the instrument (e.g. piano) used as the reference for tuning for performances.

- [F6] (MUTE OFF, MUTE ON)
This setting determines whether sounds from the output jacks are output or not while tuning is in progress.

TUNER	Explanation
MUTE OFF	Sounds are output during tuning.
MUTE ON	Sounds are not output during tuning. * With the factory settings, this is set to MUTE ON.

4. Play a single note, open, on the string being tuned.
5. Tune the string until the name of the string is shown in the display.

When you choose the MULTI MODE

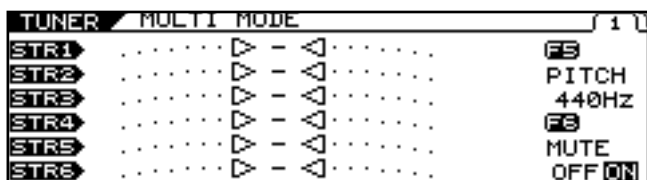

When you choose the SINGLE MODE

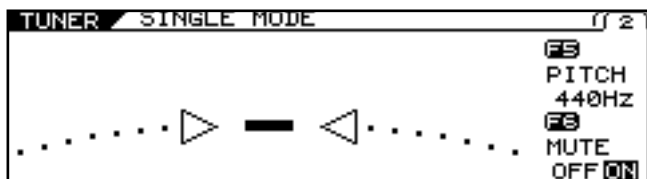

6. Keep checking the screen, tuning until the center indicator lights up.
Repeat Steps 3-5 to tune all the strings.
* When tuning a guitar equipped with a tremolo arm, you may find that when one string is in tune, other strings may not be. If this occurs, first tune the string until its name is indicated in the display, then continue to fine tune each string a number of times until the tuning is correct.
7. When you have finished tuning, press [TUNER] or [EXIT].

This completes the preparations for playing the instrument. Now try playing some sounds.

Switching Tones (Patch)

TERM

What is a patch?

The VG-99 can store 400 configurations of tone-related settings, including the COSM guitar, COSM amp, and effects. Each one of these is called a patch.

Each time you switch a patch, you can instantly change to a different tone.

About the Patch Numbers

Patch numbers (bank numbers) and patch names are indicated in the Play screen as shown below.

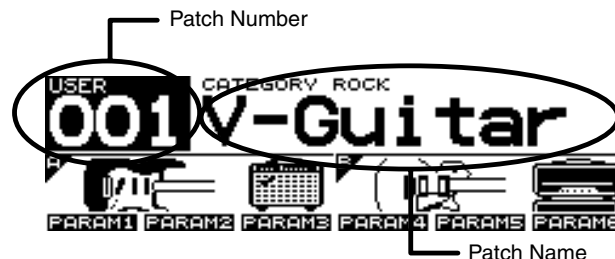

Patches are categorized into User patches and Preset patches.

User Patches

These include 200 preprogrammed patches. You can freely change the tones and save the your changes.

Preset Patches

Included here are 200 preprogrammed patches. Although you can make changes to these tones, you cannot save these changes in a Preset Patch. If you want to save a changed tone, save it as a User patch.

Switching with the PATCH/VALUE Dial

You can switch patches consecutively with the PATCH/VALUE Dial.

1. **Confirm that the Play screen is displayed.**
If a screen other than the Play screen is shown, press [EXIT] several times until the Play screen appears.
2. **Rotate the PATCH/VALUE dial to switch the patches.**

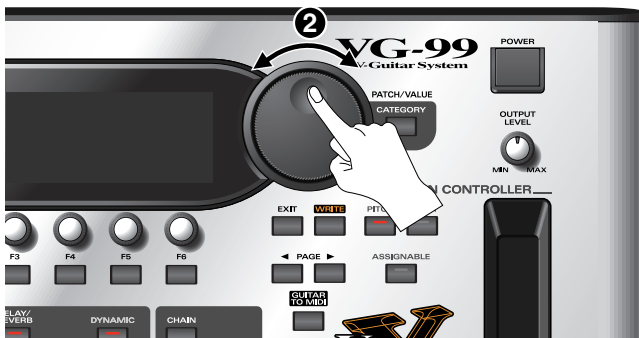

Turn the dial to the right (clockwise) to switch to the next patch number, or to the left (counterclockwise) to switch to the previous patch number.

Turning Off the Power

1. **Confirm the following before turning off the power.**
 - Are the volume levels for the VG-99 and connected amp and other devices turned down completely?
2. **Turn off the power to the guitar amp (power amp).**
3. **Press [POWER] to turn off the VG-99's power.**



NOTE

The message "NOW SHUTDOWN..." appears when the power is switched off. The VG-99's current settings are saved to memory at this time. Do not disconnect the AC adaptor until this message is no longer displayed.

Chapter 2 Creating Sounds

First, let's take a look at how the VG-99 is organized internally.

● COSM Guitars

You can use COSM modeling to create the tones of a variety of different guitars. Available sounds include not just electric and acoustic guitar tones, but extend beyond to include the sounds of synthesizers and other instruments and even non-existent, imaginary guitars. Since the created sounds are based on the signals sent by the GK-3 for each individual string, the system allows you to play these sounds while still retaining all the flavor created by the unique playing techniques and picking nuances that the guitar offers.

The VG-99 allows you to make settings for two different COSM guitar types at the same time, enabling you to instantly switch what amounts to two actual guitars and create sounds in which two guitars seem to be playing at the same time.

MEMO

You can use the Alternate Tuning function to change the pitch of each COSM guitar string individually.

● Poly Effects

These are original VG effects that can be applied independently to each string. You can choose which of the two COSM guitars the effects are applied to.

● COSM Amps

Since this technology models the guitar amp circuitry and speaker characteristics, the modeled amps simulate exactly the behavior of the actual amps, even in the way distortion is added and the way the tone controls work.

You can configure preamps and speaker cabinets as you like—you can even model the amp's studio miking. The VG-99 produces two independent COSM amp systems at the same time, which allows you to process each of the two COSM guitars through a different amp.

● Effects

The VG-99 is equipped with two BOSS GT-PRO class multi-effects systems. You can apply effects separately to each of the two COSM guitars.

● Mixer

In addition to having full freedom in mixing the sounds from the two COSM guitars, you can also output the two guitars separately to MAIN OUT and SUB OUT. The Dynamifunction further allows you to use the force of your picking attack to switch between the two guitar sounds or for many other functions. Furthermore, the mixer section also includes delay/reverb and an equalizer, enabling you to adjust the overall tone of the patches.

Setting the COSM GUITAR Tone

1. Press [MODELING TYPE].
2. Press PAGE [◀] several times to display Page 1.



3. Use [F1] (ON/OFF) or the F1 knob to switch the COSM GUITAR ON/OFF setting.
4. Use [F2] (SELECT) or the F2 knob to select the Modeling type.
5. Use [F3] (SELECT) or the F3 knob to select the COSM GUITAR type.
6. Press PAGE [▶].



* Each press of PAGE [▶] takes you to the next screen in which parameter settings are made.

7. Adjust the desired parameter with [F1]–[F6] or the F1–F6 knobs.
8. Adjust the parameters until you achieve the sound you want.

cf. ➔

For detailed information about each of the parameters, refer to "COSM GUITAR" (p. 101).

9. If you want to save the edited settings, perform the Write procedure (p. 38).

* If you do not want to save, press [EXIT] to return to the Play screen.

Setting the Alternate Tuning

About Alternate Tuning

Maybe insert a sentence in the beginning of this:

The Alternate Tuning feature allows you to change the tuning of a COSM guitar without changing the actual pitch of the guitar's strings. To accomplish this, the VG-99 analyzes the pitch of the signals transmitted by the divided pickup for each individual string while keeping best possible sound quality.

Alternate Tuning includes the following five functions.

TUNING

Use this to convert the tuning to open tunings such as OPEN-D and OPEN-G, raise or lower all of the strings an octave, and achieve various other tunings.

BEND

You can use a pedal to have pitches change from the current tuning to the set tuning in a continuous transition, just as with a string bender or pedal steel guitar.

12-STRING

This changes the sound of a regular six-string guitar to that of a twelve-string guitar.

This function also gives you the freedom to set the pitch and volume of each secondary string independently, enabling you to create 12-string guitar models with entirely original tunings.

DETUNE

This allows you to set a subtle shift in the pitch of each individual string.

HARMONY

This analyzes the pitch of each string, then converts the pitches into harmonies matched to the key.

These functions can be set for each of the two COSM guitars A and B individually, meaning you can now play six-string and twelve-string guitars simultaneously, produce twin twin leads by creating harmonies on your own, achieve fat unison sounds, and come up with sounds never before possible, all with a single VG-99.

Additionally, the VG-99 includes an AB LINK function, which allows you to set the TUNING and BEND for the two COSM guitars (A and B) simultaneously for even quicker settings.

MEMO

The pitches output with GUITAR TO MIDI (the MIDI Note messages) change according to the Channel A Alternate Tuning settings (TUNING, BEND, HARMO).

- * The Channel B Alternate Tuning settings have no bearing on these output pitches.
- * If the pitch output with GUITAR TO MIDI (the MIDI Note messages) is excessively low (or high) due to the influence of the Channel A Alternate Tuning settings, the pitch is then automatically set one octave higher (or lower).

Setting AB LINK

Setting AB LINK to ON allows you to use the same TUNING and BEND settings for COSM GUITAR [A] and COSM GUITAR [B].

When this is set to OFF, you can use different settings for COSM GUITAR [A] and COSM GUITAR [B].

1. Press [ALTERNATE TUNING].
2. Press PAGE [◀] to display Page 1.

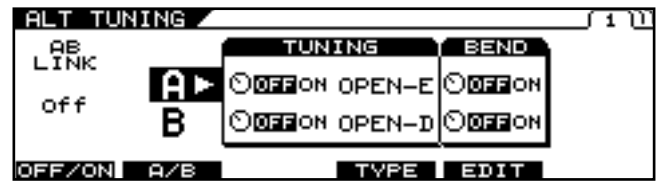

3. Switch AB LINK on or off with [F1] (OFF/ON) or the F1 knob.

cf.

For detailed information on all the parameters, refer to "ALTERNATE TUNING" (p. 116).

Setting TUNING

1. Press [ALTERNATE TUNING].
2. Press PAGE [◀] to display Page 1.

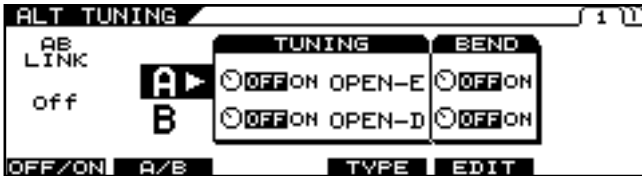

3. Select A or B with [F2] (A/B) or the F2 knob.
* You cannot select this when AB LINK is on.
4. Switch the function on or off with the F3 knob.
5. Select the tuning TYPE with [F4] (TYPE) or the F4 knob.

TIP

You can set original user tunings when USER is selected for TYPE. (p. 29)

- Press [F3] (USER).
- Set the desired parameter with [F1]–[F6] or with the F1–F6 knobs.
- Press [EXIT].

6. If you want to save the edited settings, perform the Write procedure (p. 38).
* If you do not want to save, press [EXIT] to return to the Play screen.

cf.

For detailed information on all the parameters, refer to “ALTERNATE TUNING” (p. 116).

Setting BEND

1. Press [ALTERNATE TUNING].
2. Press PAGE [◀] to display Page 1.

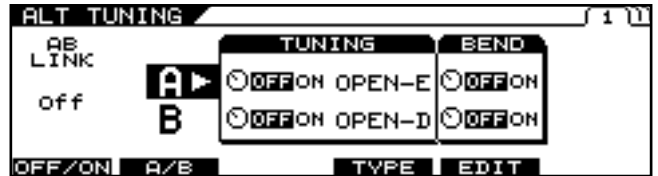

3. Select A or B with [F2] (A/B) or the F2 knob.
* You cannot select this when AB LINK is on.
4. Switch the function on or off with the F5 knob.
5. Press [F5] (EDIT).



6. Set the pitches you want the strings to bend to with the F1–F6 knobs.
7. Press PAGE [▶] to display Page 2.



8. Confirm the change in pitch with the F1 knob.
9. With Control Assign, set BEND as the target parameter for the pedal being used to control the pitch.

cf.

For detailed information on Control Assign, refer to “Using the Switches, Pedals, and MIDI to Control the Sounds (CONTROL ASSIGN)” (p. 82).

TIP

Example of BEND Parameter Settings

By making the parameter settings shown below, you can achieve a string bender-like effect which smoothly raises the pitch of the second string a whole step.

Values Set for the Alternate Tuning Parameter [ALT TUNING]

AB LINK = ON

BEND SW = ON

BEND TUNING 1st = E 0

BEND TUNING 2nd = D, +2

BEND TUNING 3rd = G 0

BEND TUNING 4th = D 0

BEND TUNING 5th = A 0

BEND TUNING 6th = E 0

Values Set for the Control Assign Parameter [CONTROL ASSIGN]

SOURCE = FC-300 EXP 1 or RIBBON POS

(Set the RIBBON CONTROLLER's ASSIGNABLE setting to ON.)

SW = ON

TARGET PARAMETER = ALT TUNE/[A]BEND/BEND

10. If you want to save the edited settings, perform the Write procedure (p. 38).

- * If you do not want to save, press [EXIT] to return to the Play screen.
- * Although parameter assignments set with Control Assign are saved with the Write procedure, the BEND parameter values in Step 8 are not saved.

cf. ➔

For detailed information on all the parameters, refer to "ALTERNATE TUNING" (p. 116).

Setting 12-STRING

1. Press [ALTERNATE TUNING].
2. Press PAGE [▶] to go to Page 2.



3. Switch the function on or off with the F1 or F4 knob.
 - * You can make separate 12 STRING settings for COSM GUITAR [A] and COSM GUITAR [B].
4. If making detailed parameter settings for 12 STRINGS, press [F1] (12STR) or [F4] (12STR).
5. Press PAGE [◀] [▶] to display the parameter you want to set.



6. Set the desired parameter with [F1]–[F6] or with the F1–F6 knobs.
7. If you want to save the edited settings, perform the Write procedure (p. 38).
 - * If you do not want to save, press [EXIT] to return to the Play screen.

cf. ➔

For detailed information on all the parameters, refer to "ALTERNATE TUNING" (p. 116).

Setting USER TUNING

1. Press [ALTERNATE TUNING].
2. Press PAGE [◀] to display Page 1.

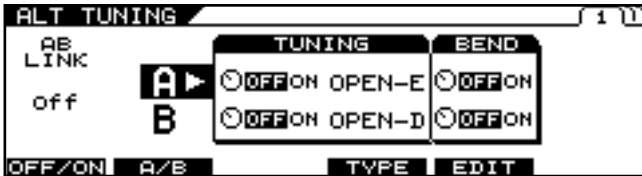

3. Select A or B with [F2] (A/B) or the F2 knob.
* You cannot select this when AB LINK is on.
4. Switch the function on or off with the F3 knob.
5. Use [F4] (TYPE) or the F4 knob to select USER.
6. Press [F3] (USER).
The USER TUNING screen appears.
7. Set the desired key of string with [F1]–[F6] or with the F1–F6 knobs.

8. If you want to save the edited settings, perform the Write procedure (p. 38).
* If you do not want to save, press [EXIT] to return to the Play screen.

cf. ➔

For detailed information on all the parameters, refer to “ALTERNATE TUNING” (p. 116).

Setting DETUNE

1. Press [ALTERNATE TUNING].
2. Press PAGE [▶] to go to Page 2.



3. Switch the function on or off with the F2 or F5 knob.
4. If making detailed parameter settings for DETUNE, press [F2] (DETUNE) or [F5] (DETUNE).



5. Set the desired parameter with [F1]–[F6] or with the F1–F6 knobs.
6. If you want to save the edited settings, perform the Write procedure (p. 38).
* If you do not want to save, press [EXIT] to return to the Play screen.

cf. ➔

For detailed information on all the parameters, refer to “ALTERNATE TUNING” (p. 116).

Setting HARMONY

1. Press [ALTERNATE TUNING].
2. Press PAGE [▶] to go to Page 2.



3. Switch the function on or off with the F3 or F6 knob.
4. If making detailed parameter settings for HARMONY, press [F3] (HARMO) or [F6] (HARMO).

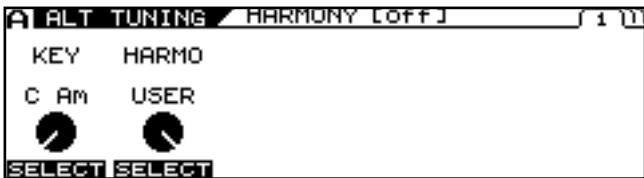

5. Set the desired parameter with [F1] (SELECT), [F2] (SELECT) or with the F1–F2 knobs.

TIP

You can set the pitch for each key when the HARMO parameter is set to USER.

Press PAGE [◀] [▶] to display the parameter you want to set.

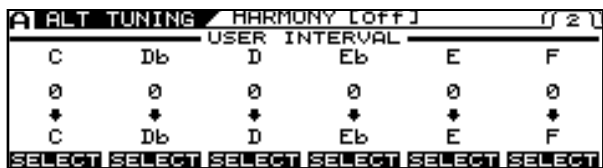

6. If you want to save the edited settings, perform the Write procedure (p. 38).

* If you do not want to save, press [EXIT] to return to the Play screen.

cf.

For detailed information on all the parameters, refer to “ALTERNATE TUNING” (p. 116).

Setting the COSM AMP Tone

1. Press [COSM AMP].
2. Press PAGE [◀] several times to display Page 1.
3. Use [F1] (ON/OFF) or the F1 knob to switch the COSM AMP ON/OFF setting.

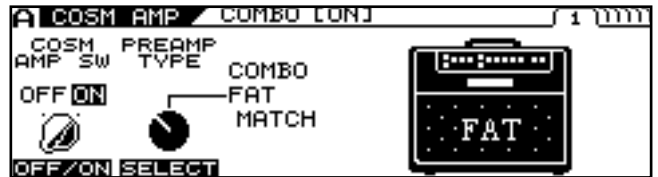

4. Use [F2] (SELECT) or the F2 knob to select the COSM AMP type.
5. Press PAGE [▶].



* Each press of PAGE [▶] takes you to the next screen in which parameter settings are made.

6. Adjust the desired parameter with [F1]–[F6] or the F1–F6 knobs.
7. Adjust the parameters until you achieve the sound you want.

cf.

For detailed information on all the parameters, refer to “COSM AMP” (p. 140).

8. If you want to save the edited settings, perform the Write procedure (p. 38).

* If you do not need to save the settings, press [EXIT] to return to the Play screen.

Setting the Effects

POLY FX (Poly Effect)

* You can use POLY FX in only one channel at a time (A or B).

1. Press [POLY FX] for the channel, either A or B, in which you want to use it.
2. Press PAGE [◀] several times to display Page 1.

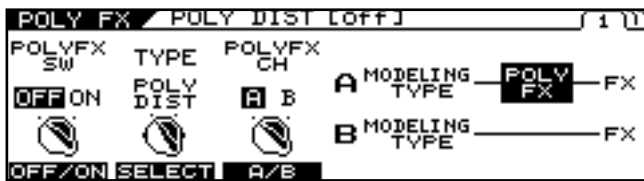

3. Switch the function on or off with the [F1] (ON/OFF) or the F1 knob.
4. Select the POLYFX TYPE with [F2] (SELECT) or the F2 knob.
5. Using [F3] (A/B) or the F3 knob, switch the channel to the one in which POLY FX is to be used.
6. Press PAGE [▶].

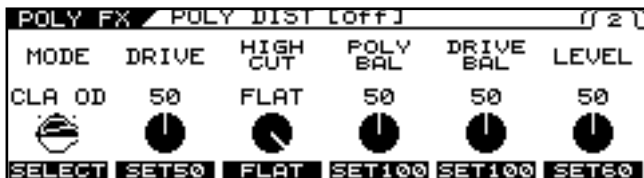

* Each press of PAGE [▶] takes you to the settings screen for the next parameter.

7. Set the desired parameter with [F1]–[F6] or with the F1–F6 knobs.
8. Adjust the parameters until you achieve the desired sound.

cf.

For detailed information on all the parameters, refer to “POLY FX (Poly Effect)” (p. 118).

9. If you want to save the edited settings, perform the Write procedure (p. 38).

* If not saving the values, press [EXIT] to return to the Play screen.

FX (Effects)

Here's how to make settings for the effects.

1. Press [FX].



2. Switch the individual effects on or off with the [F1]–[F6] (ON/OFF).

* Each press of PAGE [◀][▶] takes you to another effect screen in which parameter settings are made.

TIP

All effects that are on can be alternately switched off (indicator unlit) and on (indicator lit) together by pressing [FX].

3. Press [F1]–[F6] to select the effect you want to edit.
4. Adjust the desired parameter with [F1]–[F6] or the F1–F6 knobs.

* Each press of PAGE [▶] takes you to the settings screen for the next parameter.

5. Adjust the parameters until you achieve the sound you want.

cf.

For detailed information on all the parameters, refer to “FX (Effects)” (p. 120).

6. If you want to save the edited settings, perform the Write procedure (p. 38).

* If you do not need to save the settings, press [EXIT] to return to the Play screen.

Rearranging the Effect and Amp Connection Sequence (CHAIN)

You can freely set the order in which the effects and COSM amps are connected.

1. Press [CHAIN].

The Chain screen is displayed.



* If the effects and COSM amps are off, OFF is indicated.

2. Select the channel for which you want to change the connection sequence with [F1] (A/B).

3. Press [F2] (◀ SEL) [F3] (SEL ▶) to select the effect, COSM guitar, or COSM amp to be shifted in the sequence.

The output level for the selected effect is indicated in the upper right of the screen.

4. Press [F4] (← MOVE) [F5] (MOVE →) to move to the position in the sequence you want the shifted item inserted.

5. To make any additional changes in the connection sequence, repeat Steps 2–4.

* You can also switch effects, COSM guitars, and COSM amps on and off while setting the connection sequence. Pressing [F6] while the effect, COSM guitar, or COSM amp is selected switches the function's ON/OFF setting.

6. Press [EXIT] to return to the Play screen.

7. If you want to save the edited settings, perform the Write procedure (p. 38).

Specifying the tempo and key of the song to be played

Here's how to specify the tempo and key of a song you'll be playing. Set these when you want to specify a delay time or rate that suits a song's tempo (specifying it in terms of the note length) and when using the HARMONY function.

Setting the Tempo

1. Press [NAME/KEY/BPM].

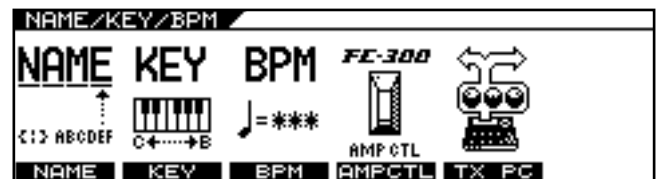

2. Press [F3] (BPM).

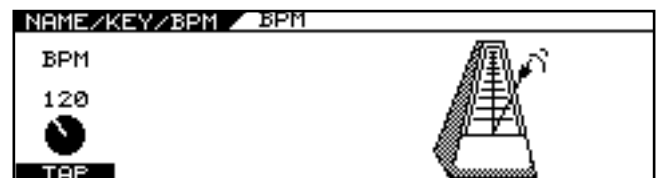

3. Tap [F1] (TAP) in time with the song tempo (quarter notes), or adjust the tempo with the F1 knob.

* If you want to control a patch parameter with the adjusted tempo, set the corresponding effect parameter to BPM ♪ -BPM ∘ .

TERM

BPM stands for "beats per minute," and represents the number of quarter notes played in one minute.

cf.

If you want to use the MIDI SYNC function, the SYNC CLOCK parameter must be set to AUTO (USB), AUTO (MIDI), or AUTO (RRC2). For detailed information, refer to "Syncing to the MIDI CLOCK from an External Device" (p. 64).

MEMO

To use Tap Input

Press [F5] (TAP) at least two times, at quarter note intervals of the desired tempo. The tempo will be calculated automatically, and set to the interval at which you pressed the button.

4. If you want to save the edited settings, perform the Write procedure (p. 38).

* If you do not want to save, press [EXIT] to return to the Play screen.

Setting the Key

1. Press [NAME/KEY/BPM].
2. Press [F2] (KEY).

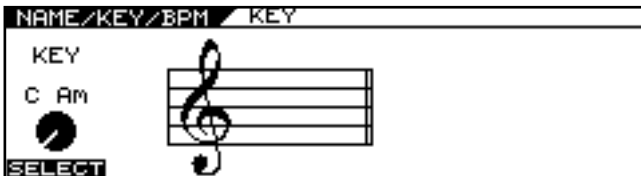

3. Set the song's key with [F1] (SELECT) or the F1 knob.
 - * The Alternate Tuning HARMONY and FX MOD 1/2 HARMONIST functions operate in accordance with the key set here.
4. If you want to save the edited settings, perform the Write procedure (p. 38).
 - * If you do not want to save, press [EXIT] to return to the Play screen.

Mixing the Normal Pickup Sound

Creating Sounds Combining the Normal and GK Inputs.

It is possible to combine the sound of the COSM guitars and the normal guitar pickups at the same time.

Setting the Volume Balance

1. Press [COSM GUITAR].



2. Set the COSM GTR SW to ON with [F1] or with the F1 knob.

MEMO

The sounds from the normal pickup and COSM guitar are not played when COSM GTR SW is set to OFF.

3. Press PAGE [▶] several times to move to the screen for setting the volume balance.

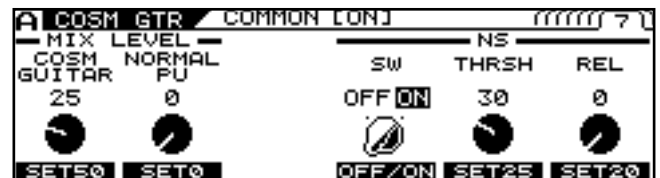

4. Use the F1 and F2 knobs to set the balance between the COSM guitar sound and the normal pickup sound.

F1 Knob

Adjusts the COSM guitar's volume level. When POLY FX is set to ON, it adjusts the volume level of the signal after it has passed through POLY FX.

F2 Knob

This adjusts the volume of the normal pickup. When the COSM guitar is connected in CHAIN at a point other than the beginning of the effects chain, you can adjust the volume of the sounds that have passed through effects from the beginning of the chain up to the point where the guitar is connected.

5. If you want to save the edited settings, perform the Write procedure (p. 38).

* If you do not want to save, press [EXIT] to return to the Play screen.

Setting the Point at Which the COSM Guitar is Connected

1. Press [CHAIN].



2. Use [F2] (◀ SEL) and [F3] (SEL ▶) to select the arrow indicating the connection point.
3. Use [F4] (← MOVE) and [F5] (MOVE →) to shift the COSM guitar's connection point.



4. If you want to save the edited settings, perform the Write procedure (p. 38).

* If you do not need to save the settings, press [EXIT] to return to the Play screen.

Normal Pickup Sound

When you are using the CHAIN function and the COSM guitar is connected at a point other than the beginning of the chain, the normal pickup sound that is mixed using the BALANCE knob is the sound processed from the beginning of the effects chain.

Using this function, you can combine the following two methods to create sounds.

1. Sounds that include COMPRESSOR, WAH, AMP, etc., with the normal pickup sound
2. Sounds that have only special effects applied to the COSM section's synthesizer or other source.



When the volume of (1) above is to be controlled independently, the level of effects before the COSM guitar should be assigned to the GK volume control of the GK-3 or to a similar controller. (p. 82)

TIP

If you want to use only the normal pickup sound without using the COSM GUITAR or POLY FX, set the COSM guitar as shown below.

COSM GTR SW = ON

MIX LEVEL

COSM GUITAR = 0

NORMAL PU = 100

Mixing Two Tones (MIXER)

cf. ➔

For detailed about the block diagram, refer to “Signal Flow” (p. 183).

Setting the Volume and Panning for Each Channel

1. Press [MIXER].
2. Press PAGE [◀] to display Page 1.

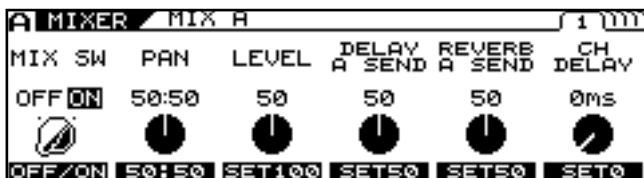

Make the settings for each channel on this page.

* Page 2 and later pages contain the mixer section's common settings.

3. Set the volume and panning with [F1]–[F6] or with the F1–F6 knobs.
4. If you want to save the edited settings, perform the Write procedure (p. 38).

* If not saving the settings, press [EXIT] to return to the Play screen.

TIP

When mixing two channels, you can produce a more realistic twin guitar tone by setting a channel delay in one of the channels, thus causing the two guitar sounds to be output at different times.

cf. ➔

For detailed information on all the parameters, refer to “MIXER” (p. 146).

Setting the Mix Balance

You can set the balance in the mix of Channel A and Channel B with the BALANCE knob. Soon after the knob is turned, the balance value pops up in the screen.



* You can also adjust this parameter in Page 2 of the Mixer screen.

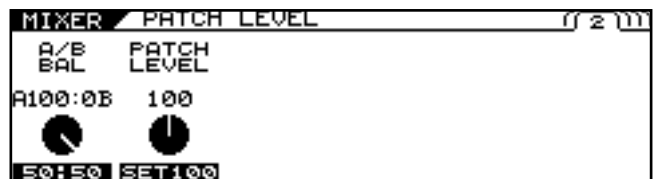

* This knob is disabled when the Dynamic function is switched on.

Setting the Delay and Reverb (DELAY/REVERB)

This sets the mixer section's delay and reverb.

1. Press [DELAY/REVERB].
2. Press PAGE [◀] to display Page 1.



3. Switch the delay on or off with [F1] (OFF/ON); switch the reverb on or off with [F4] (OFF/ON).
4. Set the parameters with [F1]–[F6] or with the F1–F6 knobs.

* Each press of PAGE [▶] takes you to the settings screen for the next parameter.

5. Adjust the parameters until you achieve the desired sound.
6. If you want to save the edited settings, perform the Write procedure (p. 38).

* If not saving the values, press [EXIT] to return to the Play screen.

cf. ➔

For detailed information on all the parameters, refer to “DELAY/REVERB” (p. 148).

Using Picking Dynamics to Control the Mix Between the Two Channels (DYNAMIC)

You can control the mix between the two channels according to how strongly the strings are picked.

1. Press [DYNAMIC].
2. Press PAGE [◀] to display Page 1.

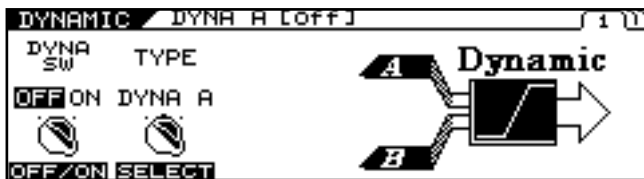

3. Switch the Dynamic function on or off with [F1] (OFF/ON).
4. Select the Dynamic function type.
5. Press PAGE [◀] [▶] to display Page 2.

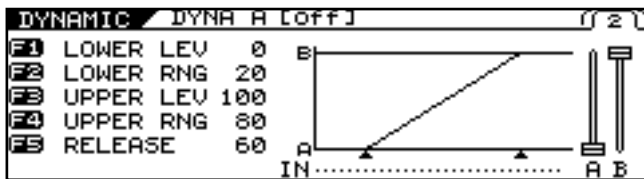

6. Set the parameters with the F1–F5 knobs.

cf. ➔

For detailed information on all the parameters, refer to “DYNAMIC” (p. 149).

Setting the Overall Patch Volume Level (PATCH LEVEL)

You can set the overall patch volume level with the PATCH LEVEL knob. Soon after the knob is turned, the patch level settings value pops up in the screen.



* You can also adjust this parameter in Page 2 of the Mixer screen.

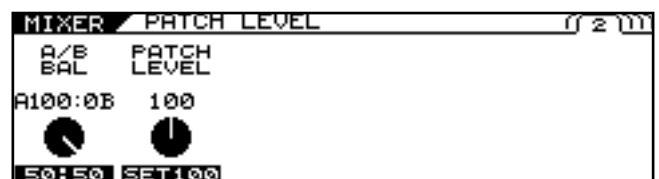

Adjusting the Overall Patch Tone (TOTAL EQ)

You can make separate settings in each individual patch for the overall tone after sounds have passed through the mixer.

1. Press [MIXER].
2. Press PAGE [◀] [▶] to display Page 3 or 4.



3. Switch the EQ on or off with [F1] (ON/OFF) on Page 3.
4. Set the tonal quality with [F1]–[F6] or with the F1–F6 knobs.
5. If you want to save the edited settings, perform the Write procedure (p. 38).

* If not saving the settings, press [EXIT] to return to the Play screen.

cf. ➔

For detailed information on all the parameters, refer to “TOTAL EQ” (p. 146).

Setting the Output Signal and Level (OUTPUT)

This sets the signals and levels output for each of the VG-99's output jacks and connectors.

1. Press [MIXER].
2. Press PAGE [▶] to display Page 5.

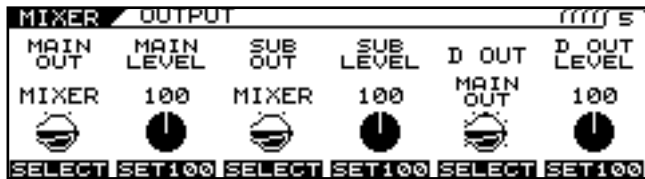

3. Set the signal and level output to MAIN OUT, SUB OUT, and DIGITAL OUT with [F1]–[F6] or with the F1–F6 knobs.

cf. ▶

For detailed information on the parameters that can be set, refer to "OUTPUT" (p. 147).

4. If you want to save the edited settings, perform the Write procedure (p. 38).
* If not saving the settings, press [EXIT] to return to the Play screen.

MEMO

You can also set the output signal and level for the entire system.

1. Press [SYSTEM].
2. Press PAGE [◀] [▶] to display Page 2.
3. Press [F1].
4. Set the OUTPUT MODE parameter to SYSTEM with [F1] or the F1 knob.

The value in the MIXER screen is disregarded, and instead the SYSTEM value is applied.

The value in the MIXER screen is disregarded, and instead the value <> is applied.

Naming a Patch (PATCH NAME)

You can give names to the patches you create.

1. Press [NAME/KEY/BPM].

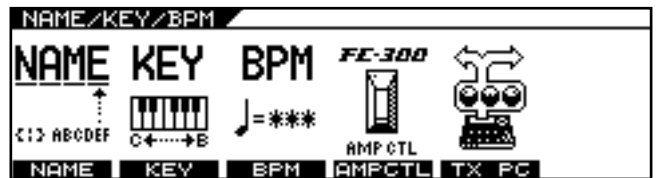

2. Press [F1] (NAME).



3. Press PAGE [◀] [▶] to move the cursor to the position at which you want to change a character.

4. Select the character with the PATCH/VALUE dial.

As you continue to rotate the PATCH/VALUE dial, the character guide automatically switches from uppercase letters to lowercase letters, numerals, and symbols.

You can use the following convenient operations by pressing [F1]–[F5].

Function Button	Description
[F1] (INSERT)	Inserts a blank space at the cursor position.
[F2] (DELETE)	Deletes the character and shifts the characters that follow to the left.
[F3] (SPACE)	Inserts a blank space at the cursor position.
[F4] (A0!)	Switches between letters, numerals, and symbols.
[F5] (A<=>a)	Switches between uppercase and lowercase letters.
[F6] (CATGRY)	Sets the category for the current patch. Refer to "Setting Patch Categories" (p. 90)

5. Repeat Steps 3 and 4 to complete the patch name.

6. If you want to save the edited settings, perform the Write procedure (p. 38).

* If not saving the settings, press [EXIT] to return to the Play screen.

Saving a Patch (WRITE)

The settings made to change a sound are temporary; when you switch to a different patch, the settings revert to the values in effect before the changes were made.

If you want to save the changes in the settings, carry out the Write procedure. If you do not want to save your changes, press EXIT to return to the Play screen.

1. Press [WRITE].

The Write screen appears.

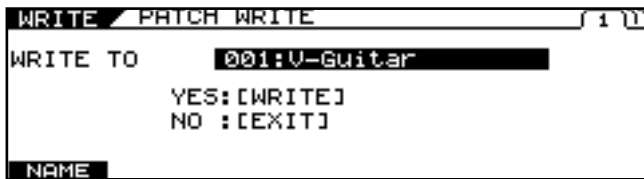

2. Rotate the PATCH/VALUE dial to select the save-destination patch number.

3. To save the patch, press [WRITE].

"NOW WRITING..." is displayed while the patch is being saved, and then the Play screen returns to the display.



* If you do not want to save, press [EXIT] to return to the Play screen.

Chapter 3 Creating Your Own Effect Types (CUSTOMIZE)

The Customize function allows you to make even more detailed changes to settings for COSM AMP (Preamp section, Speaker section), Overdrive/Distortion, and Pedal Wah, just like designing your own original effects processors.

Customizing the Preamp

1. Press [COSM AMP].

The COSM AMP Edit screen appears.

2. Press PAGE [◀] to display Page 1.

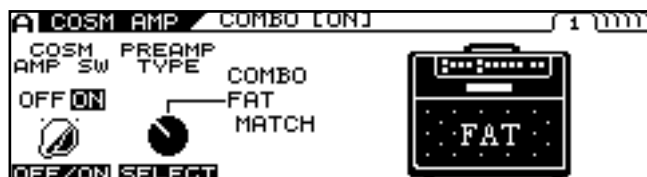

3. Select CUSTOM as the PREAMP TYPE with [F2] (SELECT) or the F2 knob.



4. Press PAGE [▶] to display Page 2.

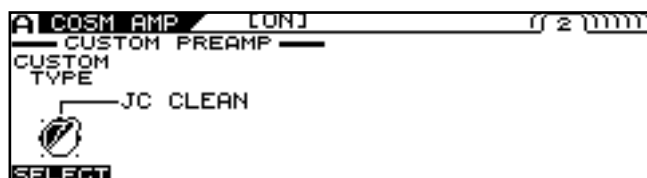

5. Select the basic preamp type to customize with [F1] (SELECT) or the F1 knob.

6. Press PAGE [▶] to display Page 3.



7. Adjust the desired parameter with [F1]–[F6] or with the F1–F6 knobs.

If there are other parameters you want to adjust, press PAGE [▶].

8. Repeat Steps 5–7 as needed.



For detailed information on all the parameters, refer to “COSM AMP” (p. 140).

9. If you want to save the edited settings, perform the Write procedure (p. 38).

* If not saving the settings, press [EXIT] to return to the Play screen.

Customizing the Speaker

* You cannot customize the speaker when BASS AMP VINTAGE or BASS AMP MODERN is selected with PREAMP TYPE.

1. Press [COSM AMP].

The COSM AMP Edit screen appears.

2. Press PAGE [◀] [▶] to display the Speaker Type selection screen.

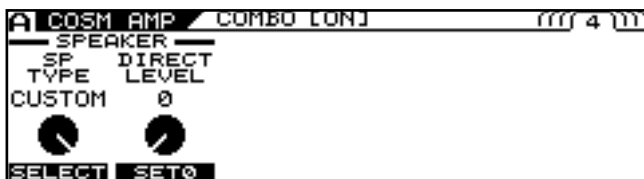

3. Select CUSTOM as the SP TYPE with [F1] (SELECT) or the F1 knob.

4. Press PAGE [▶] to display the speaker customization screen.



5. Adjust the desired parameter with [F1]–[F5] or with the F1–F5 knobs.

cf.

For detailed information on all the parameters, refer to “COSM AMP” (p. 140).

6. If you want to save the edited settings, perform the Write procedure (p. 38).

* If not saving the settings, press [EXIT] to return to the Play screen.

Customizing the Overdrive/ Distortion

1. Press [FX].

The FX Edit screen appears.

2. Press PAGE [◀] to display Page 1.



3. Press [F2] (OD/DS).

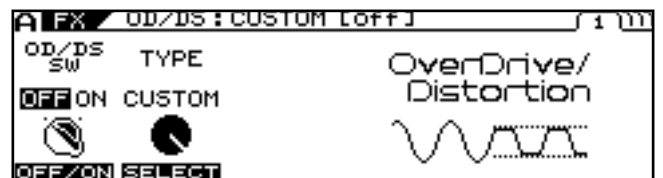

4. Select CUSTOM as the OD/DS TYPE with [F2] (SELECT) or the F2 knob.

5. Press PAGE [▶] to display Page 2.



6. Select the basic type with [F1] (SELECT) or the F1 knob.

7. Adjust the desired parameter with [F1]–[F5] or with the F1–F5 knobs.

If there are other parameters you want to adjust, press PAGE [▶].

8. Repeat Steps 6 and 7 as needed.

cf.

For detailed information on all the parameters, refer to “OD/DS (Overdrive/Distortion)” (p. 120).

9. If you want to save the edited settings, perform the Write procedure (p. 38).

* If not saving the settings, press [EXIT] to return to the Play screen.

Customizing Pedal Wah

1. Press [FX].

The FX Edit screen appears.

2. Press PAGE [◀] to display Page 1.



3. Press [F3] (WAH).

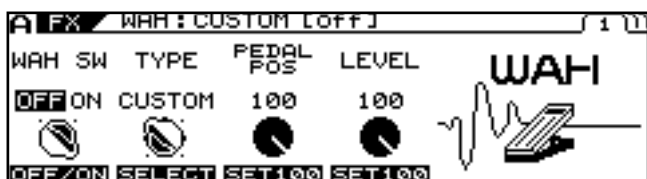

4. Select CUSTOM as the WAH TYPE with [F2] (SELECT) or the F2 knob.

5. Press PAGE [▶] to display Page 2.

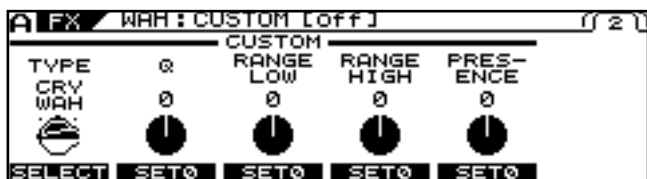

6. Select the basic type with [F1] (SELECT) or the F1 knob.

7. Adjust the desired parameter with [F1]–[F5] or with the F1–F5 knobs.

If there are other parameters you want to adjust, press PAGE [▶].

8. Repeat Steps 6 and 7 as needed.

cf.

For detailed information on all the parameters, refer to “WAH” (p. 122).

9. If you want to save the edited settings, perform the Write procedure (p. 38).

* If not saving the settings, press [EXIT] to return to the Play screen.

Chapter 4 Global Device Settings (SYSTEM)

* The parameters described in this chapter are saved when the power is turned off. There is no need to carry out the Write procedure (p. 38).

Inputting the Divided Pickup Settings

To ensure optimal conditions for producing sounds with the VG-99, making the correct settings affecting the Divided pickup (the GK settings) is required.

Selecting the Settings

The VG-99 can store ten separate sets of GK settings. If you are playing more than one guitar using the VG-99, you can store separate settings for each one, allowing you to be ready in moments with the necessary settings when the guitars are switched.

After you have finished inputting the various settings, press [EXIT] one or more times to return to the Play screen.

1. Press [SYSTEM].
2. Press PAGE [◀] to display Page 1.



3. Press [F3] (GK) to display the GK SETTING screen.
4. Press PAGE [◀] to display Page 1.



5. Press [F4] (SELECT) or turn the F4 knob to select the GK setting (1–10).

This specifies the setting to be stored as the GK setting.

- * Pressing [EXIT] at this point and returning to the Play screen enables the selected GK setting.
- * When PATCH is selected for the SETTING MODE parameter, the GK settings specified in each patch take priority. For detailed information, refer to “Using Different Guitar Settings in Each Patch (SET MODE)” (p. 46).

The following section describes parameters related to the GK settings.

After you have finished inputting the various settings, press [EXIT] one or more times to return to the Play screen.

Naming GK Settings (GK NAME)

You can give names to each of the GK settings.

1. Follow Steps 1–3 in “Selecting the Settings” (p. 42) to display the GK SETTING screen.
2. Press PAGE [◀] to display Page 1.



3. Press [F6] (NAME).



4. Set the name using PAGE [◀][▶], [F1]–[F5], and the PATCH/VALUE dial.

Function Button	Explanation
[F1] (INSERT)	Insert a space at the cursor location.
[F2] (DELETE)	Delete a character. The characters that follow get shifted to the left.
[F3] (SPACE)	Input a space at the cursor location.
[F4] (AO!)	Switch between uppercase letters and lowercase letters.
[F5] (A<=>a)	Switch between uppercase letters, lowercase letters, numbers, and characters.

* Press [EXIT] one or more times to return to the previous screen.

Selecting the Divided Pickup Type

1. Follow Steps 1–3 in “Selecting the Settings” (p. 42) to display the GK SETTING screen.
2. Press PAGE [◀] [▶] to display Page 2.

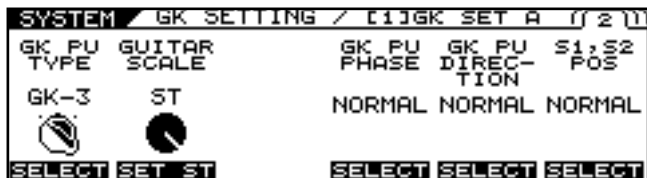

3. Use F1 (SELECT) or the F1 knob to select the pickup type.

Settings	Explanation
GK-3	Specifies the GK-3.
GK-2A	Specifies the GK-2A.
PIEZO	Specifies a piezo pickup.

* Piezo pickups are a type of pickup that are installed at the guitar’s bridge and use piezoelectric elements to determine the string vibrations.

Inputting the Guitar’s Scale

Set the scale length (the distance from the bridge to the nut).

1. Follow Steps 1–3 in “Selecting the Settings” (p. 42) to display the GK SETTING screen.
2. Press PAGE [◀] [▶] to display Page 2.
3. Use the F3 knob to set the scale length of the guitar you are using. Presets include 648 mm (ST) and 628 mm (LP).

Settings	Explanation
620–660 mm, ST(648 mm), LP(628 mm)	Specifies the scale of your guitar.

Matching the Divided Pickup and Normal Pickup Phase

Certain peculiarities in the sound may appear when the COSM guitar and normal pickup sounds are mixed. If this occurs, adjust this parameter and switch the COSM guitar’s phase.

1. Follow Steps 1–3 in “Selecting the Settings” (p. 42) to display the GK SETTING screen.
2. Press PAGE [◀] [▶] to display Page 2.
3. Use [F4] (SELECT) or the F4 knob to select the phase.

Settings	Explanation
NORMAL	Leave the phase unchanged.
REVRSE	Invert the phase.

Setting the Direction for the Installed Divided Pickup

* Make this setting if the divided pickup has been installed with the first-string end and sixth-string end reversed.

1. Follow Steps 1–3 in “Selecting the Settings” (p. 42) to display the GK SETTING screen.
2. Press PAGE [◀] [▶] to display Page 2.
3. Use [F5] (SELECT) or the F5 knob to select the pickup direction.

Settings	Explanation
NORMAL	The cable extends from the 6th string side. Ordinarily, you should use this setting.
REVRSE	The cable extends from the 1st string side.

Setting the DOWN/S1, UP/S2 Switch Arrangement

On some guitars with the Divided pickup built in, the positions of the DOWN/S1 and UP/S2 switches are reversed from those of the Divided pickup. Set this so that the functions match.

1. Follow Steps 1–3 in “Selecting the Settings” (p. 42) to display the GK SETTING screen.
2. Press PAGE [◀] [▶] to display Page 2.

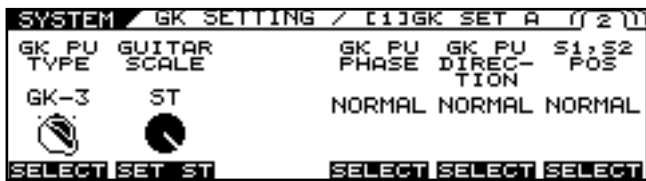

3. Use [F6] (SELECT) or the F6 knob to select the arrangement.

Settings	Explanation
NORMAL	The switches will not be reversed.
REVRSE	The DOWN/S1 switch and UP/S2 switch will be reversed.

Setting the Gap Between the Pickup and the Bridge (PICKUP ↔ BRIDGE)

Set the clearance from the center of the Divided pickup to the bridge’s saddle for each string.

* This setting is not required when piezo pickups are used.

1. Follow Steps 1–3 in “Selecting the Settings” (p. 42) to display the GK SETTING screen.
2. Press PAGE [◀] [▶] to display Page 3.



3. Rotate the F1–F6 knobs to set the clearance for strings 1–6.

Settings	Explanation
10.0–30.0 mm	Specify the distance between the center of the Divided pickup and the center of each bridge saddle.

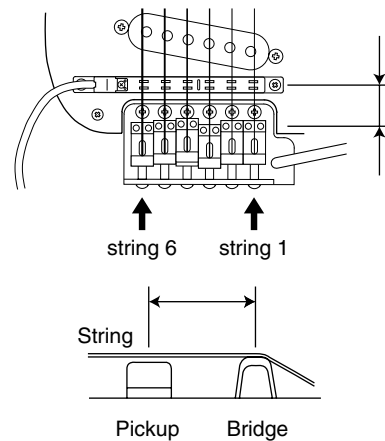

Adjusting the Sensitivity for Each String

Adjust the Divided pickup sensitivity for each string.

1. Follow Steps 1–3 in “Selecting the Settings” (p. 42) to display the GK SETTING screen.
2. Press PAGE [▶] to display Page 4.

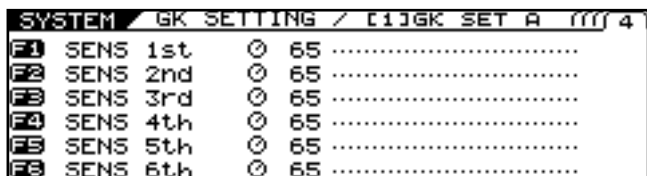

3. Rotate the F1–F6 knobs to adjust the sensitivity.
 - Play each open string with the maximum force you’d use in an actual performance, and set the sensitivity such that the meter registers a level just before reaching the maximum level.
 - * If the large segments at the right end of the level meter appear, it means the level is set too high. Lower the sensitivity setting.
 - * Pressing [F1]–[F6] initializes each string’s value to 65.
 - * Depending on the guitar you use, the level meter may move to the maximum level even when the sensitivity is set to the minimum setting. If this occurs, adjust the clearance separating the divided pickup and the strings so the distance is slightly greater than specified.
4. Play the sixth through first strings with the normal amount of force; if any strings sounds particularly loud, lower the sensitivity setting for that string, and keep adjusting until the differences in the strings’ volume levels are minimal.

Settings	Explanation
0–100	Adjust the input sensitivity of each Divided pickup.

Setting Whether or Not the Deviced Pickup Is Used (GK CONNECT)

The VG-99 comes equipped with a function that automatically determines whether or not a GK connection exists and switches the internal settings accordingly. This makes it possible for you to all functions other than a COSM guitar (COSM amp, effects, tuner, etc.) when you’ve connected only to the GUITAR INPUT.

1. Follow Steps 1–3 in “Selecting the Settings” (p. 42) to display the GK SETTING screen.
2. Press PAGE [◀] to display Page 1.



3. Use [F1] (SELECT) or the F1 knob to select the setting.

Settings	Explanation
AUTO	The presence of a GK connection is detected automatically and the internal settings are switched accordingly.
ON	Settings appropriate for a GK connection are always used.
OFF	Settings appropriate for a GUITAR INPUT connection are always used.

* You should ordinarily use AUTO (the default setting). In cases where the auto-detect function does not operate correctly, (for example, when you are using a Divided pickup other than the GK-3), pickup, use [F2] or the F2 dial to change the setting.

Using Different Guitar Settings in Each Patch (SET MODE)

This setting determines whether the VG-99 uses a single global GK setting or if the GK settings can be specified individually for each patch.

1. Follow Steps 1–3 in “Selecting the Settings” (p. 42) to display the GK SETTING screen.
2. Press PAGE [◀] to display Page 1.
3. Use [F3] (SELECT) or the F3 knob to select the setting.

Settings	Explanation
SYSTEM	The GK SETTING set here is used globally for the entire VG-99. This is the default factory setting.
PATCH	The GK Settings can be specified individually for each patch. Use this setting when switching among multiple guitars as you perform.

Determining the Function of the GK Volume Control and DOWN/S1, UP/S2 Switches (GK FUNC)

This sets the function for the GK-3's GK Volume and DOWN/S1, UP/S2 switches.

1. Follow Steps 1–3 in “Selecting the Settings” (p. 42) to display the GK SETTING screen.
2. Press PAGE [◀] to display Page 1.
3. Press [F2] (GKFUNC).

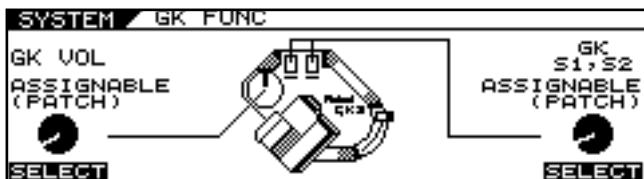

4. Set the parameter you want to assign with [F1] (SELECT), [F6] (SELECT) or the F1, F6 knob.

cf.

For detailed information on the parameters that can be assigned, refer to “GK VOL (GK Volume)” (p. 166) and “GK S1, S2 (GK S1, S2 Switch)” (p. 166).

- * When assigning functions to each patch for DOWN/S1 and UP/S2, set Control Assign to ASSIGNABLE (PATCH). With other settings, the assignment settings in the patches are disregarded.
- * This is the same setting as that set with GK VOL or GK S1, S2 in [SYSTEM] (CTL).

Adjusting Overall Tone According to the Environment (GLOBAL/OUTPUT SELECT)

The VG-99 includes a function for adjusting the overall tone produced by the device. This is referred to as the Global function. You can use the Global function to adjust the overall sound of the VG-99 to suit the equipment being used or environment you are in without altering the individual patches.

Selecting the Settings

The VG-99 can store ten separate Global function settings (1–10).

After you have finished inputting the various settings, press [EXIT] one or more times to return to the Play screen.

1. Press [GLOBAL].
2. Press PAGE [◀] to display Page 1.
The Global screen appears.



3. Select any setting 1–10 with [F1] (SELECT) or the F1 knob.

The following parameter settings are stored to their corresponding areas in memory.

Naming the Settings (GLOBAL NAME)

You can assign up to ten user names, each containing up to eight characters. For example, you could create names that suggest the gear used in a certain setting or a place where you perform.

1. Press [GLOBAL].
2. Press PAGE [◀] to display Page 1.



3. Press [F3] (NAME).



4. Set the name using PAGE [◀] [▶] and [F1]–[F5].

Function Button	Explanation
[F1] (INSERT)	Insert a space at the cursor location.
[F2] (DELETE)	Delete a character. The characters that follow get shifted to the left.
[F3] (SPACE)	Input a space at the cursor location.
[F4] (A0!)	Switch between uppercase letters and lowercase letters.
[F5] (A<=>a)	Switch between uppercase letters, lowercase letters, numbers, and characters.

Setting the Types of Connected Devices (OUTPUT SELECT)

You can match the VG-99's output response to that of the connected device. Making this setting helps keep differences in sound qualities respective to the connected device to a minimum.

1. Press [GLOBAL].
2. Press PAGE [◀] to display Page 1.



3. Use [F4] (OUTPUT SELECT) or the F4 knob to set the type of device to be connected to the MAIN OUT jacks.

Value	Explanation
JC-120	Use this setting when connecting to Roland's JC-120 guitar amp.
SMALL AMP	Use this setting when connecting to a small guitar amp.
COMBO AMP	Use this setting when connecting to the guitar input of a combo amp other than the JC-120 guitar amp (where the amp and speaker or speakers are combined in a single unit). <i>* Depending on your guitar amp, you may be able to obtain good results with the JC-120 setting.</i>
STACK AMP	Use this setting when connecting to the guitar input of a stack-type guitar amp (where the amp and speaker or speakers are separated).
JC-120 Return	Use this setting when connecting to the RETURN of a JC-120.
COMBO Return	Use this setting when connecting to the RETURN with a combo amp.
STACK Return	Use this setting when connecting to the RETURN of a stack amp or the INPUT of a rack mounted power amp. Set to STACK Return also when using a guitar power amp and speaker cabinet combination.
LINE/PHONES	Use this setting when using headphones or when connecting to a multi-track recorder for recording. <i>* When using COSM Speaker cabinets, use the LINE/PHONES setting.</i>

Adjusting the Overall Tone (GLOBAL EQ)

Both MAIN OUT and SUB OUT feature four-band EQs. EQ (MAIN) is applied to the output from MAIN OUT; EQ (SUB) is applied to the output from SUB OUT.

1. Press [GLOBAL].
2. Press PAGE [◀][▶] to display Page 2–5.



3. Use [F1] – [F6] or the F1 – F6 knobs to adjust the tone.

Parameter/Range	Explanation
MAIN EQ (Main Equalizer), SUB EQ (Sub Equalizer)	
A four-band equalizer with high and low ranges is provided. The sound processed by the effect can be boosted by frequency range before it is output.	
MAIN EQ SW (Main Equalizer Switch), SUB EQ SW (Sub Equalizer Switch)	
OFF, ON	Turns the EQ effect on/off.
TOTAL GAIN	
-12~+12dB	Adjusts the volume before the equalizer.
LOW GAIN	
-12~+12dB	Adjusts the low frequency range tone.
HIGH GAIN	
-12~+12dB	Adjusts the high frequency range tone.
LOW MID FREQ (Low Middle Frequency)	
20Hz–10.0kHz	Specifies the center of the frequency range that will be adjusted by the LOW MID GAIN.
LOW MID Q (Low Middle Q)	
0.5–16	Adjusts the width of the area affected by the EQ centered at the LOW MID FREQ. Higher values will narrow the area.
LOW MID GAIN (Low Middle Gain)	
-12~+12dB	Adjusts the low-middle frequency range tone.
HIGH MID FREQ (High Middle Frequency)	
20Hz–10.0kHz	Specifies the center of the frequency range that will be adjusted by the HIGH MID GAIN.
HIGH MID Q (High Middle Q)	
0.5–16	Adjusts the width of the area affected by the EQ centered at the HIGH MID FREQ. Higher values will narrow the area.
HIGH MID GAIN (High Middle Gain)	
-12~+12dB	Adjusts the high-middle frequency range tone.

Controlling the Overall Effect of the Noise Suppressor (Total NS)

This controls the overall threshold value for the noise suppressor settings in the individual patches. This is an effective tool when guitars are changed during performances and for making adjustments in response to noise levels at the performance venue. This is an overall setting and does not alter the individual patch settings.

1. Press [GLOBAL].
2. Press PAGE [▶] to display Page 6.

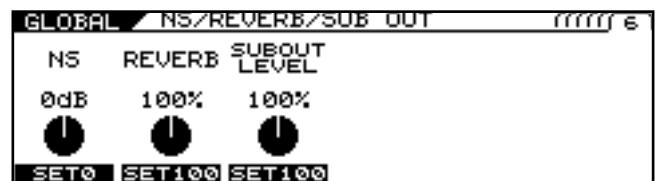

3. Adjust the level with the F1 knob.
 - This adjusts the noise suppressor threshold levels set in each patch.
 - 20 dB – +20 dB
 - * This adjustment has no effect on patches in which the noise suppressor is off.
 - * To use the levels set in the individual patches, set this to 0 dB.

Controlling the Overall Reverb Level (Total REVERB)

This controls the overall reverb level settings in the individual patches. This is effective for adjusting to the acoustics of the performance venue. This setting does not affect the individual patch settings.

1. Press [GLOBAL].
2. Press PAGE [▶] to display Page 6.

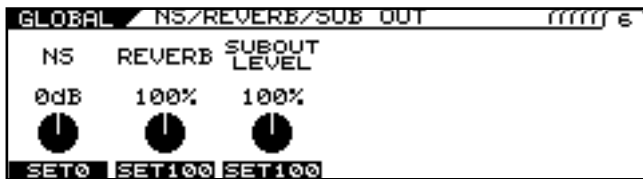

3. Adjust the level with the F2 knob.
 - This adjusts the noise suppressor threshold levels set in each patch.
 - 0–200%
 - * This adjustment has no effect on patches in which reverb is switched off.
 - * To use the levels set in the individual patches, set this to 100%.

Setting the Sounds Output from SUB OUT (SUB OUT LEVEL)

This setting selects which signals are output from the SUB OUT jacks.

1. Press [GLOBAL].
2. Press PAGE [▶] to display Page 6.

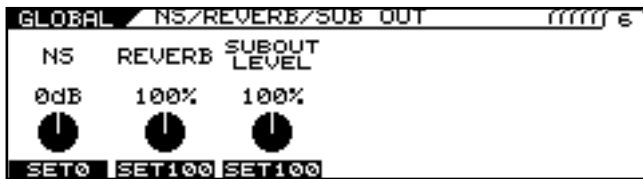

3. Adjust the setting with the F3 knob.
 - This adjusts the output level set in each patch.
 - 0–200%
 - * To use the levels set in the individual patches, set this to 100%.

Setting the GK VOLUME Control and Switch and the Pedal Function (SYSTEM CONTROL ASSIGN)

1. Press [SYSTEM].
2. Press PAGE [◀] to display Page 1.



3. Press [F4] (CTL).
4. Press PAGE [◀] to display Page 1.



5. Select any setting from GK VOL to FC-300 CTL8 with [F2] (SEL) or [F3] (SEL) or the F2 or F3 knobs, then use [F5] (SELECT) or the F5 knob to select the function you want to assign.

MEMO

If you want to be able to assign the functions for the controllers on an individual patch basis, set Control Assign to ASSIGNABLE (PATCH). With Control Assign set to ASSIGNABLE (PATCH), the unit operates in accordance with the assignments set in each patch, as described in “Using the Switches, Pedals, and MIDI to Control the Sounds (CONTROL ASSIGN)” (p. 82).

* With other settings, the assignment settings in the patches are disregarded.

cf.

For information on assigned controllers, refer to “Using the Switches, Pedals, and MIDI to Control the Sounds (CONTROL ASSIGN)” (p. 82); for more on assignable parameters, refer to “Parameters That Can Be Assigned to Separate Controllers” (p. 168).

Having Values from an External Pedal, GK VOLUME Control, or Other Controller Carried Over When Patches are Called Up (ASSIGN HOLD)

This setting determines whether or not the current settings for each controller (the expression pedals, the FC-300's expression pedals, control pedals or other controllers) are applied to the patch when patches are switched.

* *Assign Hold is not performed when the SW MODE parameter in Control Assign Source is set to LATCH. (LATCH toggles between the minimum and maximum value each time the switch is pressed.)*

1. Press [SYSTEM].
2. Press PAGE [◀] to display Page 1.



3. Press [F4] (CTL).
4. Press PAGE [▶] to display Page 2.
The ASSIGN HOLD screen appears.

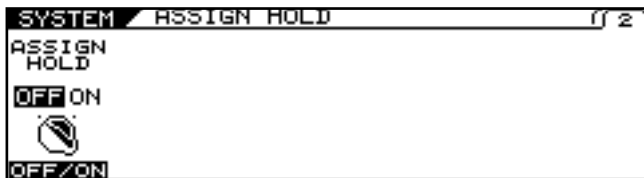

5. Select ON or OFF for the Assign Hold function with [F1] (OFF/ON) or the F1 knob.

Settings	Explanation
ON	Current values of controllers are applied when patches are called up.
OFF	Stored values (at the time of Patch Write) of controllers are used when patches are called up. (Current controller values ignored.)

Limiting the Patches That Can Be Switched (PATCH EXTENT)

Setting upper and lower limits for the patches that can be switched allows you to select only the patches you need.

1. Press [SYSTEM].
2. Press PAGE [◀] [▶] to display Page 2.



3. Press [F6] (MISC).

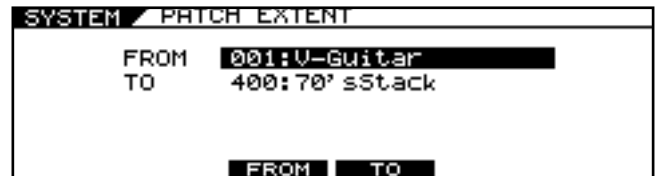

4. Press [F3] (FROM).
5. Set the lower limit of the patch selection with the PATCH/VALUE dial and [F3] (FROM) or the F3 knob.
6. Press [F4] (TO).
7. Set the upper limit of the patch selection with the PATCH/VALUE dial and [F4] (TO) or the F4 knob.

* *This setting applies to patches switched with the PATCH/VALUE dial, control switches, or other such controls. Adjustments made with a connected FC-300 or external MIDI device are not affected by this setting.*

Adjusting the Screen's Contrast

The text and icons in the LCD screen may be difficult to make out sometimes, such as immediately after the VG-99 is turned on or after extended use. The conditions at the place where you are using the VG-99 can also affect visibility. Should you run into this problem, try adjusting the contrast.

1. Press [SYSTEM].
2. Press PAGE [◀] to display Page 1.



3. Press [F1] (LCD).

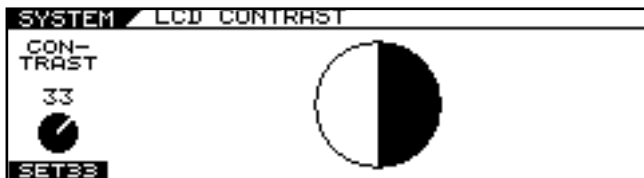

4. Turn the F1 knob to adjust the contrast.

Setting the Output Signal and Level (SYSTEM OUTPUT)

This sets the signals and levels output for each of the VG-99's output jacks and connectors (MAIN OUT, SUB OUT, and DIGITAL OUT).

1. Press [SYSTEM].
2. Press PAGE [◀] [▶] to display Page 2.



3. Press [F1] (OUTPUT).



4. Set the OUTPUT MODE parameter to SYSTEM with [F1] (SELECT) or with the F1 knob.

* If set to PATCH, the values set under "Setting the Output Signal and Level (OUTPUT)" (p. 37) are enabled. The value in the MIXER screen is disregarded, and instead the value < > is applied.



5. Set the signal and level output to each output with PAGE [◀] [▶] or with the F1–F6 knobs.

cf. ➤

For detailed information on the parameters that can be set, refer to "OUTPUT" (p. 147).

Chapter 5 Using the VG-99 in Combination with an FC-300

With an FC-300 (optional) connected to the VG-99, you can perform the following operations:

- Switch patches
- Have patch names be shown in the FC-300's display
- Control tones with the FC-300's pedals (Control Assign)
- Show the VG-99's tuner in the FC-300's display when the TUNER function is used
- Switch the FC-300's Amp Control on and off

Connecting with the RRC2 IN Connector

Connect the VG-99 and FC-300 using the RRC2 cable included with the unit.

TERM

What is RRC2?

RRC2 is a Roland protocol that provides for the supply of power and two-way data communications over a single cable.

Devices can also be connected using a commercially available ethernet cable instead of the included RRC2 cable.

NOTE

- Be sure to connect the RRC2 OUT connector to a device with an RRC2 IN connector. Use of the connection with LAN or other devices may cause generation of heat and damage to the equipment.
- Carefully connect the RRC2 cable the way in—until it is firmly to the RRC2 IN connector.
- Do not subject the RRC2 cable to stress or physical shock.
- If using commercially available ethernet cable as the RRC2 connecting cable, be sure that the cable meets the following specifications:
 - Category 5 (Cat5) or above
 - Maximum length of 15 meters
 - Cable designed for straight-through connection.

* Ethernet cables designed for crossover connections cannot be used.

Settings Related to the FC-300

If connecting the VG-99 with an FC-300 using an RRC2 cable, make the settings below as needed.

Settings for Control of the FC-300

This sets the method for controlling the FC-300.

1. Press [SYSTEM].
2. Press PAGE [◀] to display Page 1.



3. Press [F5] (FC-300).



4. Set the SYS EX MODE with [F1] (OFF/ON) or with the F1 knob.

Available Settings	Description
ON	When connected to the VG-99, the FC-300 automatically changes to Exclusive mode and functions in accordance with the settings made with the VG-99. This is the setting normally selected. You can control the FC-300 even without matching the VG-99's and FC-300's Device IDs. Connecting an FC-300 automatically switches the FC-300 to Exclusive mode. Normally, you should select this setting.
OFF	Select OFF when using the FC-300 in a mode other than System Exclusive mode. The mode does not switch automatically.

Setting the Operation When Patches Are Switched

This sets the timing at which patches are switched when you press [▼][▲] pedals on the FC-300.

1. Press [SYSTEM].
2. Press PAGE [◀] to display Page 1.



3. Press [F5] (FC-300).



4. Set BANK CHANGE with [F2] (SELECT) or with the F2 knob.

Available Settings	Description
IMMEDIATE	The patch changes immediately when the FC-300's [▼][▲] pedals are pressed.
WAIT NUM	Even after the FC-300's [▼][▲] pedals are pressed, the patch does not change until the NUMBER is set.

Activating the VG-99's Tuner from the FC-300 (QUICK TUNER)

You can use the FC-300's number pedals to switch the Tuner function on and off.

- * The Quick Tuner function is enabled only in the Play screen.
- * The Quick Tuner function is enabled only when the FC-300's MODE is set to SYS EX.

1. Press [SYSTEM].
2. Press PAGE [◀] to display Page 1.
3. Press [F5] (FC-300).
4. Set QUICK TUNER with [F3] (SELECT) or with the F3 knob.

Available Settings	Description
OFF	The QUICK TUNER function is not operational.
ON	The QUICK TUNER function is operational. The TUNER function is alternately switched on and off each time the currently selected number pedal is pressed.

Setting the FC-300 Amp Control

This switches the FC-300's AMP CTL 1 and AMP CTL 2 parameters on and off.

When the guitar amp's channel switch jack is connected to the FC-300's AMP CONTROL 1 jack (or AMP CONTROL 2 jack), you can then switch the guitar amp channels with the VG-99's AMP CTL1 (or AMP CTL2) parameter.

1. Use the PATCH/VALUE dial to select the patch you want to set.
2. Press [NAME/KEY/BPM].

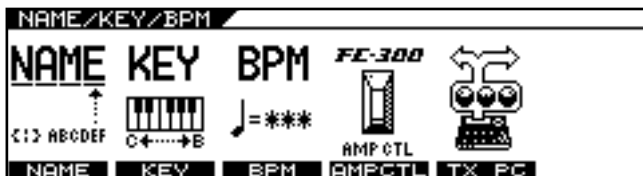

3. Press [F4] (AMPCTL).

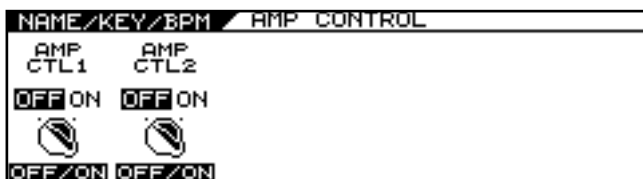

4. Use [F1] and [F2] or the F1 and F2 knobs to set AMP CTL1 and AMP CTL2 to ON or OFF.

Available Settings	Description
OFF	The FC-300's AMP CTL1 and AMP CTL2 parameters are set to OFF.
ON	The FC-300's AMP CTL1 and AMP CTL2 parameters are set to ON.

Chapter 6 Using MIDI

About MIDI

MIDI, an abbreviation for Musical Instrument Digital Interface, is a universal standard that enables musical instruments to exchange musical performance data, messages concerning changes in the sounds, and other information. Any device that conforms to the MIDI specifications can communicate (to the extent that is relevant to both devices) with any other MIDI device, even those that were made by a different manufacturer or that belong to a different category of instrument.

Under the MIDI specifications, performance data produced by such actions as playing a keyboard or pressing a pedal is handled as MIDI messages.

What You Can Do Using MIDI

Using MIDI, you can carry out the following operations with the VG-99.

If using the VG-99 with an FC-300 connected, also refer to “**Chapter 5 Using the VG-99 in Combination with an FC-300**” (p. 52).

* Use of MIDI requires that the MIDI channels of connected devices be matched.

Data cannot be transmitted to or received from other MIDI devices unless the MIDI channels are set correctly.

Operating from the VG-99

Outputting Program Change Messages

When a patch is selected with the VG-99, the VG-99 simultaneously transmits a Program Change message corresponding to the selected number. The external MIDI device switches its settings in response to the received Program Change message.

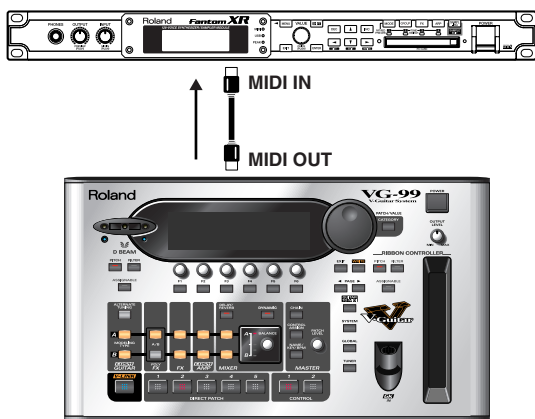

Outputting Control Change Messages

Data describing the action of an external device (expression pedal or footswitch) connected to the VG-99 is output as Control Change messages. These messages can be used for such tasks as adjusting external MIDI devices' parameters.

Outputting Performance Data

The guitar's performance data can be output as Note messages and Bend messages, allowing you to perform through synthesizer sound modules and other devices connected to the VG-99. For more detailed information, refer to “**Playing an External Synthesizer Sound Module (GUITAR TO MIDI)**” (p. 64).

Transmitting Data

You can use Exclusive messages to transmit settings for effect sounds and other data stored in the VG-99 to other MIDI devices. This allows you to give another VG-99 the identical settings and to save effect sound settings to MIDI sequencers and other such devices.

Controlling the VG-99 from an External MIDI Device

Switching Patch Numbers

The VG-99's patches switch immediately in response to Program Change messages received from external MIDI devices.

MEMO

You can set the correspondence between MIDI Program Change messages and the VG-99's patches with the “**RX PC MAP (RECEIVE PROGRAM CHANGE MAP)**” (p. 61). Set this to ensure correspondence of the VG-99's effect sounds with those of other MIDI devices.

The connections shown in the diagram below are used when playing your guitar backed by an automatic sequencer performance. The VG-99's patches change automatically when a Program number is entered with the performance data at the point where you want the VG-99's patches to change.

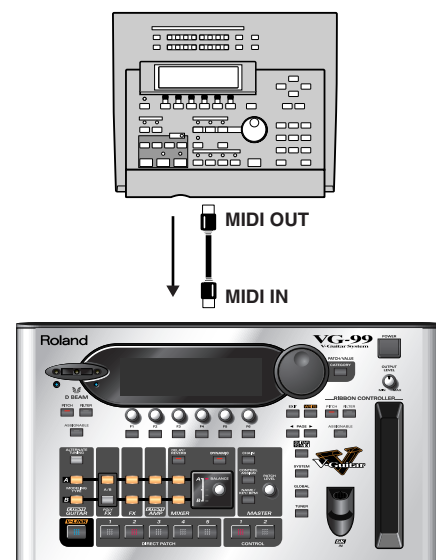

Receiving Control Change Messages

MEMO

The VG-99 can receive Control Change messages to control specified parameters while a performance is in progress. Set the parameters to be controlled with **“Using the Switches, Pedals, and MIDI to Control the Sounds (CONTROL ASSIGN)”** (p. 82).

Receiving Data

The VG-99 can receive data transmitted from other VG-99's and data saved to MIDI sequencers.

Main Types of MIDI Messages Handled by the VG-99

In order to be able to convey the full range of expression that is possible during performance, MIDI provides for different types of MIDI messages. MIDI messages can be categorized broadly into two groups; messages handled on an individual MIDI channel basis (Channel messages), and those handled independently of MIDI channels (System messages).

Channel Messages

These are messages used for conveying the events that take place during performance. Normally, you can control most performances using only these messages. The action controlled with each MIDI message is determined by the receiving device's settings.

Program Change Messages

These message are generally used for switching sounds; sounds are switched with Program Change numbers 1–128. Furthermore, with the VG-99, you can also use Control Change Bank Select messages together with the Program Change messages, allowing you to switch 400 different patch numbers.

Control Change Messages

Control Change messages are used for enhancing performance expression. Functions are distinguished from one another with Control numbers; the particular functions that can be controlled varies with the MIDI device. With the VG-99, you can control specified parameters.

Note On Messages

These messages convey to the device the pitches and volumes at which sounds are played.

Note Off Messages

These messages instruct the device to stop sounds currently being played.

Bend Messages

These messages are sent to produce continuous changes in the pitch.

System Messages

System messages include Exclusive messages, messages required for synchronized performances, and messages designed to prevent problems with operation.

Exclusive Messages

Exclusive messages are used for handling sounds unique to a particular device and other such messages. Basically, you can exchange messages between devices of the same type from the same manufacturer. Using Exclusive messages, you can store parameter settings to sequencers and transmit parameter settings to other VG-99s.

To exchange Exclusive messages, the Device ID numbers for each of the instruments must match.

About the MIDI Implementation

While the use of MIDI allows various devices to communicate with each other, this does not mean that it enables exchanges of all information. The data that can be exchanged between any two connected devices is limited to the messages common to both devices.

Therefore, MIDI device owner's manuals always contain a MIDI Implementation chart, which allows the user to determine quickly what MIDI messages the particular device supports. Comparing the MIDI Implementation charts for each device allows you to confirm what information can be exchanged and how to accomplish this. Since these charts are uniform in size, you can overlay the charts for the transmitting and receiving devices when checking the information.

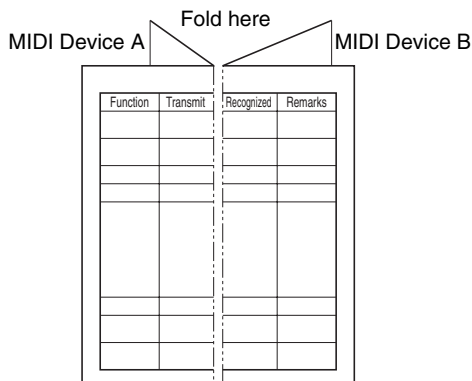

A separate publication titled "MIDI Implementation" is also available. It provides complete details concerning the way MIDI has been implemented on this unit. If you should require this publication (such as when you intend to carry out byte-level programming), please access the Roland web site.
<http://www.roland.com/>

Exchanging MIDI Messages

This section provides a simple description of how MIDI messages are exchanged.

About MIDI Connectors

MIDI messages are exchanged via the connectors described below. Connect MIDI cables to these connectors according to the use.

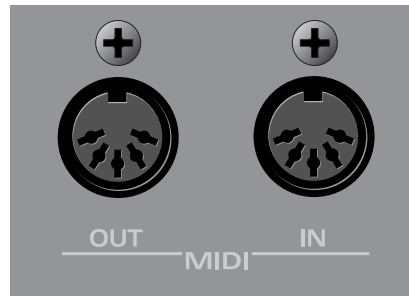

MIDI Connector	Description
MIDI IN	Messages from other MIDI devices are received here.
MIDI OUT	Messages from the VG-99 are transmitted here.

About MIDI Channels

MIDI allows various different messages to be sent separately to multiple MIDI devices over a single MIDI cable. This is possible thanks to the concept of MIDI channels.

MIDI channels use an approach similar to that of television channels. Switching channels on the TV allows the viewer to watch programs from a variety of broadcasters. This is because information is transferred over the channel to which both the transmitter and receiver are tuned.

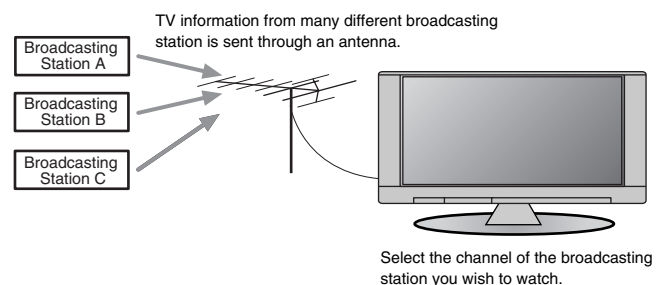

MIDI includes channels numbered 1–16; MIDI messages are transmitted to (receiving) instruments set to the same channel as the transmitting device's.

Bank Select and Program Change

Bank Select and Program Change are MIDI messages generally used for switching patches.

Normally, patches are switched using Program Change messages. However, if Program Changes alone are used, you'll only be able to select up to a maximum of 128 different patches. Because of this, some devices also employ the Bank Select, expanding the number of selectable patches.

Patches for these devices are assigned numbers combining Bank Select MSB, LSB numbers 0–127 and Program numbers 1–128.

* The VG-99 disregards the Bank Select LSB.

Setting the MIDI-Related Functions

This section describes the VG-99's MIDI-related functions. Set these according to how they are to be used.

1. Press [SYSTEM].
The System screen appears.
2. Press PAGE [◀] to display Page 1.



3. Press [F6] (MIDI).
The MIDI settings screen appears.

The following section describes the settings used with MIDI.

MIDI Channel

This sets the channel used for transmitting and receiving MIDI messages corresponding to the VG-99's patches and operations.

Also refer to "Playing an External Synthesizer Sound Module (GUITAR TO MIDI)" (p. 64) if you are using the GUITAR TO MIDI function, and refer to "Controlling Video Images with Your Guitar (V-LINK)" (p. 96) if you are using the V-LINK function.

1. Follow Steps 1–3 in "Setting the MIDI-Related Functions" (p. 58) to display the MIDI screen.
2. Press PAGE [◀] to display Page 1.
3. Rotate the F1 knob to set the MIDI channel (1–16).

MEMO

Be sure not to set the same MIDI channel as the channel used for the GUITAR TO MIDI or V-LINK functions.

MIDI Omni Mode

When set to MIDI Omni mode, the VG-99 receives messages on all MIDI channels, regardless of the MIDI channel settings. You can use Omni mode whenever you do not need to use specific MIDI channels in controlling the VG-99.

1. Follow Steps 1–3 in “Setting the MIDI-Related Functions” (p. 58) to display the MIDI screen.
2. Press PAGE [◀] to display Page 1.



3. Set Omni mode on or off with [F2] or the F2 knob.

MEMO

Even with Omni mode set to ON, the only Exclusive messages received will be those carrying the Device ID set for Device ID.

MEMO

Omni mode is set to ON at the factory.

MIDI Device ID

This sets the Device ID to be used for the transmission and reception of Exclusive messages.

MEMO

Device ID is set to 1 at the factory.

1. Follow Steps 1–3 in “Setting the MIDI-Related Functions” (p. 58) to display the MIDI screen.
2. Press PAGE [◀] to display Page 1.
3. Rotate the F3 knob to set the Device ID (1–32).

SYNC CLOCK

You can synchronize the VG-99 to the MIDI Clock (tempo) transmitted from a MIDI sequencer or other external MIDI device.

1. Follow Steps 1–3 in “Setting the MIDI-Related Functions” (p. 58) to display the MIDI screen.
2. Press PAGE [◀] to display Page 1.
3. Use [F6] (SELECT) or the F6 knob to select the MIDI Clock to use as the tempo reference.

cf.

For detailed information on the parameters that can be set, refer to “Syncing to the MIDI CLOCK from an External Device” (p. 64).

MIDI ROUTING

Set the VG-99’s control signal path.

The VG-99 features three types of connectors for data input and output: the MIDI connectors (IN/OUT), a USB connector, and the RRC2 IN connector. When connecting the VG-99 to devices other than the FC-300, you need to consider the routing of the control signals.

Check the display as you set the necessary connections.

You can make the settings for MIDI IN and OUT on Page 2, for the USB connector on Page 3, and for the RRC2 IN connector on Page 4.

1. Follow Steps 1–3 in “Setting the MIDI-Related Functions” (p. 58) to display the MIDI screen.
2. Press PAGE [◀] [▶] to display Pages 2–4.

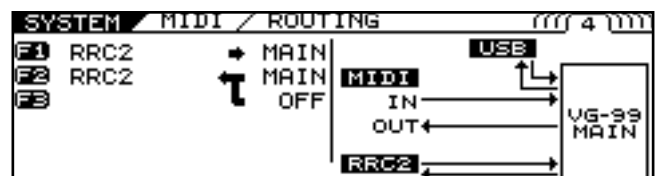
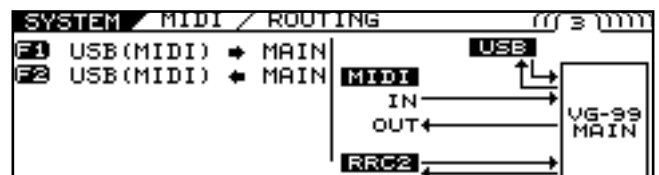
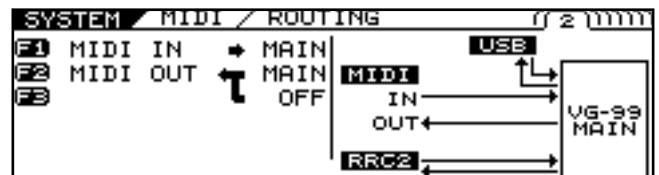

3. Set the connections with [F1]–[F3] or the F1–F3 knobs.

MIDI PC OUT

This setting determines whether or not Program Change messages are output when the VG-99's patches are switched.

1. Follow Steps 1–3 in “Setting the MIDI-Related Functions” (p. 58) to display the MIDI screen.
2. Press PAGE [◀] [▶] to display Page 5.



3. Set PC OUT ON/OFF with [F1] or the F1 knob.

MEMO

When outputting Program Change messages, the VG-99 simultaneously outputs MIDI Bank Select messages.

TX PC MAP (TRANSMIT PROGRAM CHANGE MAP)

This setting determines the sequence of Program Change messages output when the VG-99's patches are changed.

You can select whether to output Program Change messages set for the patches in advance or the Program Change messages programmed in each patch.

1. Follow Steps 1–3 in “Setting the MIDI-Related Functions” (p. 58) to display the MIDI screen.
2. Press PAGE [◀] [▶] to display Page 5.



3. Use [F2] or the F2 knob to set whether or not the Transmit Program channel is used.

Available Settings	Description
FIX	Regardless of the patch settings, Program Change messages predetermined for each patch number are output.
PROG	The Program Change messages programmed in each patch are output.

The table below shows the correspondence between the patches and Program Change messages when TX PC MAP is set to FIX.

Patch Number	Bank Select	Program Number
001	0	1
:	:	:
100	0	100
101	1	1
:	:	:
200	1	100
201	2	1
:	:	:
400	3	100

Setting the TX PC MAP

To set Program Change messages to be transmitted with individual patches, make the settings described below.

MEMO

Patch parameters are settings made individually for each patch. The Write procedure is required to save changes in the settings.

1. Select the patch to which you want to assign the predetermined Program Change message to be transmitted.
2. Press [NAME/KEY/BPM].
3. Press [F5] (TX PC).

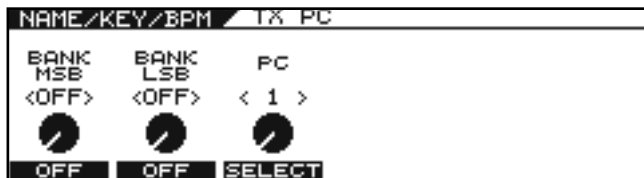

4. Use [F1] – [F3] or F1 – F3 knob to set the Program Change Number and the Bank Select.
5. If you want to save the edited settings, perform the Write procedure (p. 38).

* If not saving the settings, press [EXIT] to return to the Play screen.

RX PC MAP (RECEIVE PROGRAM CHANGE MAP)

You can select whether to use a fixed or freely set correspondence between program numbers received and the patches switched to when the VG-99's patches are switched by Program Change messages transmitted by an external MIDI device.

1. Follow Steps 1–3 in “Setting the MIDI-Related Functions” (p. 58) to display the MIDI screen.
2. Press PAGE [◀] [▶] to display Page 5.



3. Use [F3] or the F3 knob to set whether or not the Receive Program Change Map is used.

Available Settings	Description
FIX	The VG-99 switches to the patches predetermined for the corresponding received Program Change messages, regardless of the Receive Program Change Map settings.
PROG	The VG-99 switches to the patches set in the Receive Program Change Map.

4. To change the patch assigned to a received Program Number, press [LEFT] [RIGHT] to display Page 6.

The RX PC MAP screen appears.

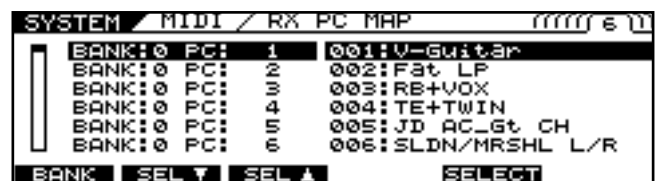

5. Assign the patch to a received Program Number.

- [F1] (BANK)/F1 Knob
Selects the Bank number.
- [F2] (SEL ▼) or [F3] (SEL ▲)/F2 or F3 Knob
Selects the Program number.
- [F5] (SELECT)/F5 Knob
Selects the patch.

When the combination of the Bank number and Program number selected with F1, F2, and F3 is received, the VG-99 switches to the patch selected with F5.

Chapter 6 Using MIDI

The table below shows the correspondence between the factory default Program change Map and the Program Change messages received when RX PC MAP is set to FIX.

Bank Select	Program Number	Patch Number
0	1	001
:	:	:
0	128	128
1	1	101
:	:	:
2	128	328
3	1	301
:	:	:
3	100	400
:	:	:
3	128	400

* When setting "OMNI MODE" (p. 170) to OFF, be sure to match "MIDI CH (MIDI Channel)" (p. 170) to the external MIDI device's transmit channel beforehand.

Setting the MIDI Output Control Change Number

This sets the Control Change numbers output when the VG-99's pedals and external pedals or the FC-300's pedals and external pedals are operated.

- Follow Steps 1–3 in "Setting the MIDI-Related Functions" (p. 58) to display the MIDI screen.
- Press PAGE [◀] [▶] to display Page 7. The TX CC screen appears.



- Use [F2] (SEL ▼) or [F3] (SEL ▲), the F2 or F3 knobs to select the controller you want to set.
- Use [F5] or the F5 knob to assign the Control Change number to be transmitted when the controller is adjusted.

When the controller selected with F2 or F3 is operated, the Control Change message selected with F5 is transmitted.

* Control Changes message cannot be output if OFF is selected.

Bulk Dump

With the VG-99, you can use Exclusive messages to set another VG-99 to the same settings or to save effect sound settings to MIDI sequencers and other such devices.

This transmission of data is referred to as bulk dump.

Data that can be transmitted is described below.

Displayed	Data Transmitted
ALL	All transmittable data (SYSTEM, GK SETTING, GLOBAL, PATCH 001–200, FAVORITE SETTING)
SYSTEM	SYSTEM parameters.
GK SETTING	Settings content for GK SETTING
GLOBAL	GLOBAL function settings
PATCH	Settings for patch numbers 001–200
FAVORITE SETTING	Settings content in FAVORITE SETTINGS 01–10 for all effects

How to Transmit the Data

When Saving Data to a MIDI Sequencer

Connect the devices as shown below, then place the MIDI sequencer in standby mode, so it is ready to receive Exclusive messages.

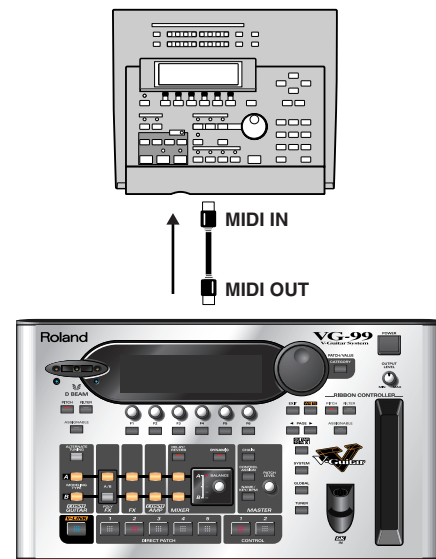

MEMO

For information on how to operate the sequencer you are using, refer to the owner's manual that came with it.

When Transmitting Data to Another VG-99

Connect the devices as shown below, then match the Device IDs for the transmitting and receiving devices.



1. Follow Steps 1–3 in “Setting the MIDI-Related Functions” (p. 58) to display the MIDI screen.
2. Press PAGE [◀] [▶] to display Page 8.



3. Use [F2] (SEL) or [F3] (SEL) to select the data you want to transmit.
4. Press [F1] (CHECK).

Only the types of data with a check mark are transmitted.

MEMO

When selecting PATCH FROM/TO, you can use the PATCH/VALUE dial to specify the range of patch numbers to be transmitted

5. Repeat Steps 2 and 3 as needed.
6. Press [F6] (DUMP).

Transmission begins. Once the transmission is complete, you're returned to the screen you were in prior to transmission.

MEMO

You can cancel the procedure in progress by pressing [EXIT].

Bulk Load

Reception of VG-99 data saved to MIDI sequencers and other devices is referred to as bulk load.

When Receiving Data Saved to a MIDI Sequencer

1. Connect the devices as shown below. Set the VG-99's Device ID to the same one used when the data was transmitted to the MIDI sequencer.

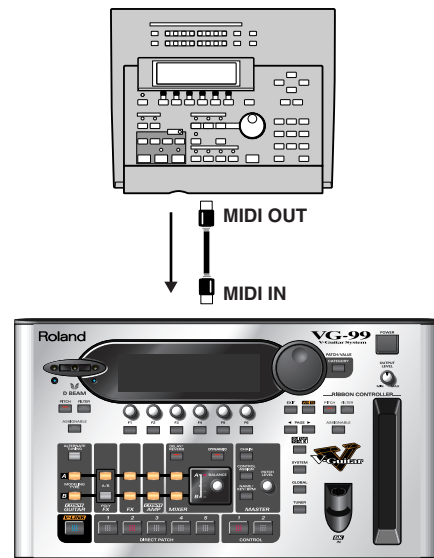

2. Transmit the bulk data from the MIDI sequencer.

The message “SYSTEM EXCLUSIVE MESSAGE RECEIVING...” is displayed while the data is being received. Once the reception is complete, you're returned to the screen you were in prior to reception.

In this state, the VG-99 can then receive further data.

MEMO

If the message “MIDI BUFFER FULL” appears, check the connections and reduce the tempo of the transmitting MIDI device.

Syncing to the MIDI CLOCK from an External Device

1. Follow Steps 1–3 in “Setting the MIDI-Related Functions” (p. 58) to display the MIDI screen.
2. Press PAGE [◀] to display Page 1.



3. Use [F6] (SELECT) or the F6 knob to select the synchronizing signal.

This specifies the setting to be stored as the SYNC CLOCK setting.

- INTERNAL
The VG-99 operates independently.
- AUTO (USB)
The VG-99 is synchronized to the MIDI Clock received via USB. However, operations are automatically synchronized to the VG-99's internal Clock if the VG-99 is unable to receive the external Clock.
- AUTO (MIDI)
The VG-99 is synchronized to the MIDI Clock received via MIDI. However, operations are automatically synchronized to the VG-99's internal Clock if the VG-99 is unable to receive the external Clock.
- AUTO (RRC2)
The VG-99 is synchronized to the MIDI Clock received via RRC2. However, operations are automatically synchronized to the VG-99's internal Clock if the VG-99 is unable to receive the external Clock.

Playing an External Synthesizer Sound Module (GUITAR TO MIDI)

The VG-99 can convert performance data to MIDI Note and Bend messages and output these messages. Using this function allows you to record performances to sequencers and play sounds through external sequencer sound modules.

The GUITAR TO MIDI function features system parameters, whose settings affect the overall functionality of the device, and patch parameters, which are set on an individual patch basis.

MEMO

Pitches output with GUITAR TO MIDI (the MIDI Note messages) are affected by the Channel A Alternate Tuning settings (TUNING, BEND, HARMO) and the D Beam/ribbon controller settings (T-ARM).

- * The Channel B Alternate Tuning settings have no bearing on these output pitches.
- * If the pitch output with GUITAR TO MIDI (the MIDI Note messages) is excessively low (or high) due to the influence of the Channel A Alternate Tuning settings, the pitch is then automatically set one octave higher (or lower).

Setting the GUITAR TO MIDI Function (System Parameters)

These procedures are used for making settings for the device as a whole. Changes are saved at the same time they are changed. The Write procedure is not required.

After entering these parameters, press [EXIT] several times to return to the Play screen.

Switching the GUITAR TO MIDI Function On and Off

1. Press [GUITAR TO MIDI].

The GUITAR TO MIDI screen appears.

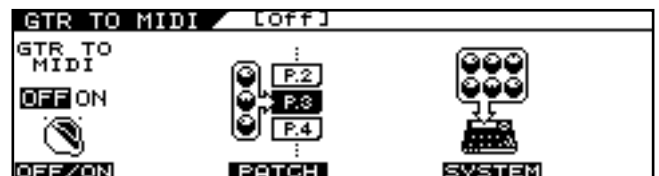

2. Set GTR TO MIDI to ON with [F1] (OFF/ON) or the F1 knob.

Setting this to OFF prevents the output of all MIDI messages related to the GUITAR TO MIDI function.

Selecting the Controller Used to Control the Hold Function (HOLD CTL)

1. Press [GUITAR TO MIDI].

The GUITAR TO MIDI screen appears.

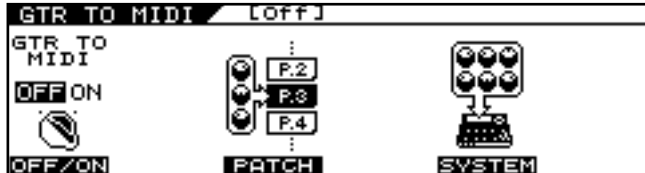

2. Press [F5] (SYSTEM).



3. Use [F1] (SELECT) or the F1 knob to select the controller you want to set.

HOLD CTL	Controller
GK S1, S2	GK-3 DOWN/S1, UP/S2 switch
CTL 1-4	VG-99's CONTROL 1, 2 buttons or foot switch connected to CTL 3,4 jack
FC-300 CTL1-8	FC-300's CTL 1, 2 pedals or foot switch connected to CTL jacks 3-8

MEMO

Controllers to which HOLD CTL is assigned are enabled simultaneously with parameters set in the SYSTEM CONTROL ASSIGN settings (p. 167). Set CONTROL ASSIGN to OFF if you want to use only the Hold function.

cf.

You can select the way the Hold function operates. For more details, refer to “**Selecting How the Hold Functions (HOLD TYPE)**” (p. 69).

Thinning Out Bend Messages (BEND THIN)

Vibrato, slides, and other such data in guitar performances are output as Pitch Bend messages.

For this reason, the receiving MIDI device may encounter problems with operation when Pitch Bend messages containing large amounts of data are included.

You can use the BEND THIN function to thin out the Pitch Bend messages and control the volume of MIDI data.

1. Follow Steps 1–2 in “Selecting the Controller Used to Control the Hold Function (HOLD CTL)” (p. 65) to display the GTR TO MIDI screen.



2. Set the function to ON with [F2] (OFF/ON) or the F2 knob.

Select OFF when you do not want to reduce the amount of data transmitted in the Pitch Bend messages.

Setting the MIDI Transmit Channel (BASIC CH)

This sets the MIDI channel used for output of string performance data from the VG-99.

Set the MIDI channels according to the POLY/MONO mode as shown below.

- When set to POLY mode
The performance data for all of the strings is transmitted over the basic channel.
- When set to MONO mode
1st string: Transmitted over the basic channel.
2nd string: Transmitted over the channel number one higher than the basic channel.
:
6th string: Transmitted over the channel number five higher than the basic channel.

cf.

For more details about the mode, refer to “Setting the Transmission Mode (MODE)” (p. 67).

1. Follow Steps 1–2 in “Selecting the Controller Used to Control the Hold Function (HOLD CTL)” (p. 65) to display the GTR TO MIDI screen.



2. Set the channel with [F3] (SELECT) or the F3 knob.

Preventing Transmission of Program Change Messages (PC MASK)

You can prevent transmission of Program Change messages that can be set in “Outputting Program Change Messages Simultaneously When Switching Patches (PC)” (p. 70).

* This does not affect such Program Changes as those set in “MIDI PC OUT” (p. 60).

1. Follow Steps 1–2 in “Selecting the Controller Used to Control the Hold Function (HOLD CTL)” (p. 65) to display the GTR TO MIDI screen.



2. Set the function to ON with [F4] (OFF/ON) or the F4 knob.

When PC MASK is set to ON, the Program Change messages set with the PC parameter (p. 70) in GUITAR TO MIDI are not transmitted.

Setting the GUITAR TO MIDI Function (Patch Parameters)

MEMO

Patch parameters are settings made individually for each patch. The Write procedure is required to save changes in the settings. Carry out the Write procedure as needed.

Setting the Transmission Mode (MODE)

1. Press [GUITAR TO MIDI].

The GTR TO MIDI screen appears.

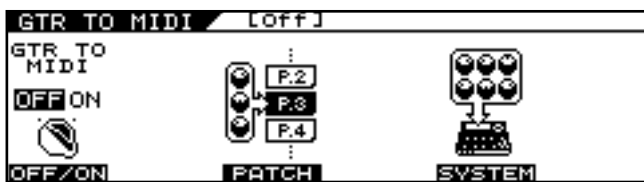

2. Press [F3] (PATCH).

3. Press PAGE [◀] to display Page 1.



4. Set the mode with [F1] (SELECT) or the F1 knob.

- MONO (MONO Mode)



In this mode, one channel per string is used, thus using a total of six channels.

Since each string uses a different MIDI channel, you can select a different tone for each string, using string bending or continuously varying the pitch on a specific string; however, this requires use of a multitimbral sound module.

- POLY (POLY Mode)



In this mode, the messages for all six strings are transmitted over a single channel.

While transmitting the MIDI messages for all of the strings over one channel does simplify the settings needed for the sound module and reduces the number of MIDI channels

used, it does impose certain limitations; for example, permitting only one tone to be selected for all of the strings.

MEMO

All patches are set to MONO mode at the factory.

MEMO

When chords are played in POLY mode, pitch bends and glides change in semitone increments, while vibrato cannot be used. Pitch bends and glides work normally in POLY Mode when playing single notes.

Adjusting the Feel Produced in Playing the Guitar (PLAY FEEL)

This selects the response of the synth sound relative to the picking dynamics.

Changing this setting depending on the performance style used with the guitar or the tone allows you to express dynamics more naturally.

1. Follow Steps 1–2 in “Setting the Transmission Mode (MODE)” (p. 67) to display the GTR TO MIDI screen.

2. Press PAGE [◀] to display Page 1.



3. Adjust the setting with [F2] (SELECT) or the F2 knob.

- FEEL1–FEEL4
FEEL1 is the mode that gives sounds the broadest variation in volume based on the picking dynamics. As the setting number is increased, it becomes easier to produce high volume sounds even with weaker picking.
This allows you to play with consistent volume, whether you tap the strings or use rough picking.
- NO DYNA
In this mode, sounds are played at a fixed volume regardless of the picking strength.
- STRUM
This suppresses the output of sounds from weaker picking.
This setting allows you to prevent undesired sounds produced when playing rhythm or due to incidental contact with strings from incorrect picking.

Changing the Pitch in Semitone Units (CHROMATIC)

When using string bending or other such techniques to gradually change the pitch with the guitar or bass, you can set the VG-99 so that the pitch of the MIDI messages being output changes in semitone increments.

1. Follow Steps 1–2 in “Setting the Transmission Mode (MODE)” (p. 67) to display the GTR TO MIDI screen.

2. Press PAGE [◀] to display Page 1.



3. Adjust the setting with [F3] (SELECT) or the F3 knob.

- OFF
Normal Pitch Bend messages are output. The pitch varies continuously in keeping with the string bending or vibrato.
- TYPE 1
When the pitch changes, this setting applies the results of the pitch change information without stopping the note that is playing.
This produces a unique effect, whereby there is no attack sound when the pitches change, similar to slurring on a recorder.
- TYPE 2
When the pitch changes, the VG-99 retriggers (replays) the sound at the changed pitch, producing pitch changes only at the semitone increments.
As a result, the attack sound plays each time the pitch changes. The attenuation of the string vibration following the moment the string is played is reflected in the gradual fading of the retriggered sound.
- TYPE 3
As with TYPE 2, sounds are retriggered at the changed pitch, expressing the pitch changes only in semitones.
However, instead of reflecting the attenuation of the string vibration, the retriggered sound is the same as that when the string was initially played.

Selecting How the Hold Functions (HOLD TYPE)

This selects the Hold function type when the controller set with the HOLD CTL parameter (p. 65) is adjusted.

1. Follow Steps 1–2 in “Setting the Transmission Mode (MODE)” (p. 67) to display the GTR TO MIDI screen.
2. Press PAGE [◀] to display Page 1.



3. Use [F1] (SELECT) or the F1 knob to select MONO.
4. Adjust the setting with [F4] (SELECT) or the F4 knob.

- HOLD 1

The Note On messages are held when the Hold function is switched on with the controller.

If the Hold function remains on as you continue to play the strings, each successive Note On message is held, and when a Note message is already being played from the same string, the previous Note message is cancelled, and the next Note On message is held. This allows you to prevent any interruption in the sounds, even sounds from releasing the strings over the frets.

- HOLD 2

The Note On messages are held when the Hold function is switched on with the controller.

However, subsequent Note On messages are not output if you continue to play the instrument with the Hold effect left on.

- HOLD 3

The Note On messages are held when the Hold function is switched on with the controller.

If the Hold function remains on as you continue to play the strings, Note On messages for strings other than the one already being held can be output, but they are not held.

Outputting Control Changes by Operating the Controllers (CC)

You can operate the panel knobs and pedals to output Control Change messages.

There are two different settings.

1. Follow Steps 1–2 in “Setting the Transmission Mode (MODE)” (p. 67) to display the GTR TO MIDI screen.
2. Press PAGE [◀] [▶] to display Page 2.



3. Use [F1] (SELECT) or the F1 knob, or [F4] (SELECT) or the F4 knob, to select the controller you want to set.

SRC	Controller
GK VOL	GK-3 Volume knob
GK S1	GK-3 DOWN/S1 Switch
GK S2	GK-3 UP/S2 Switch
CTL1	Control Button 1
CTL2	Control Button 2
EXP PEDAL	External Expression Pedal
CTL3	External Footswitch 3
CTL4	External Footswitch 4
D BEAM V	D BEAM Height
D BEAM H	D BEAM Left-Right
RIBBON ACT	Ribbon Controller Touch
RIBBON POS	Ribbon Controller Touch Position
FC-300 EXP1	FC-300's EXP PEDAL 1
FC-300 EXP SW1	FC-300's EXP PEDAL SW1
FC-300 EXP2	FC-300's EXP PEDAL 2
FC-300 EXP SW2	FC-300's EXP PEDAL SW2
FC-300 CTL1	FC-300's CTL1
FC-300 CTL2	FC-300's CTL2
FC-300 E3/C3	FC-300's External Expression Pedal 3, External Footswitch 3
FC-300 CTL4	FC-300's External Footswitch 4
FC-300 E4/C5	FC-300's External Expression Pedal 4, External Footswitch 5
FC-300 CTL6	FC-300's External Footswitch 6
FC-300 E5/C7	FC-300's External Expression Pedal 5, External Footswitch 7
FC-300 CTL8	FC-300's External Footswitch 8

4. Use [F2] (SELECT) or the F2 knob, or [F5] (SELECT) or the F5 knob, to select the Control Change number you want to output.

Off, CC #1–#31, CC #64–#95

MEMO

The MIDI channel over which the messages are output in POLY mode is only the basic channel. In MONO mode, the messages are output over the six channels spanning from the basic channel up to the channel numbered five above the basic channel.

Outputting Program Change Messages Simultaneously When Switching Patches (PC)

This sets the Program Change messages that are output when the VG-99's patches are switched.

* Program Change messages are not output while PC MASK (p. 66) is set to ON.

1. Follow Steps 1–2 in “Setting the Transmission Mode (MODE)” (p. 67) to display the GTR TO MIDI screen.
2. Press PAGE [◀] [▶] to display Pages 3–5.



When MODE (p. 67) is set to MONO, you can make settings individually for each of the six strings of STRING 1–6.

3. Make the settings with [F1]–[F6] or the F1–F6 knobs.

Set the following parameters.

BANK MSB	Explanation
OFF, 0–127	This sets the Bank Select (MSB).

BANK LSB	Explanation
OFF, 0–127	This sets the Bank Select (LSB).

PC	Explanation
OFF, 1–128	This sets the Program Number.

MEMO

The MIDI channel over which the messages are output in POLY mode is only the basic channel. In MONO mode, the messages are output over the six channels spanning from the basic channel up to the channel numbered five above the basic channel.

Chapter 7 Using the VG-99 Connected to a Computer Via USB

Before Using the USB Connection

By using USB with the VG-99, you'll be able to exchange digital audio signals and MIDI messages with your computer.

Installing and Setting the USB Driver

Use of the VG-99's USB functionality requires that the USB driver first be installed on the computer.

The dedicated VG-99 driver is contained on the "VG-99 Software CD-ROM" included with the VG-99.

As the program and procedures used in installing the driver vary according to the operating environment, carefully read the following Readme file contained on the "VG-99 Software CD-ROM" before use.

Using OS	Contained location
Windows XP	\Driver\XP\Readme_E.htm
Windows Vista	\Driver\Vista\Readme_E.htm
Mac OS X	\Driver\Readme_E.htm

What is a USB Driver?

A USB driver is software that acts as a go-between in transferring data between computer applications (such as recording software and sequencer software) and the USB device when the computer and USB device are connected using a USB cable.

The USB driver transmits data from the applications to the USB device, and conversely, passes messages from the USB device to the applications.

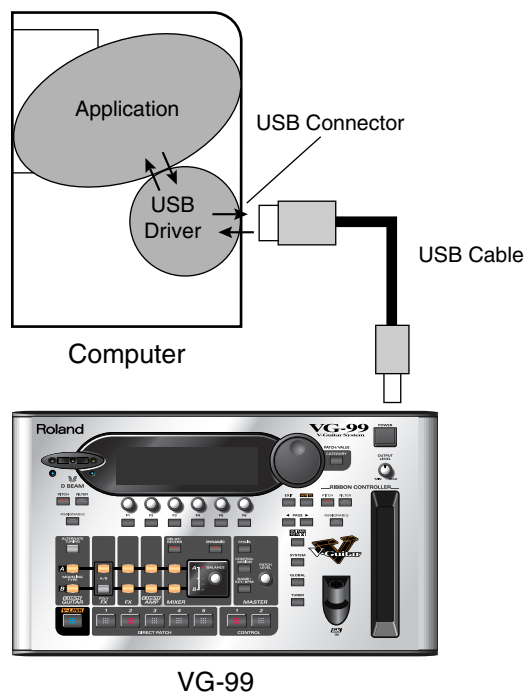

About the Included Software

In addition to the USB drivers, the included "VG-99 Software CD-ROM" also contains special software that can be used when the VG-99 is connected with a computer. The CD-ROM contains different versions for use with Windows and Macintosh operating systems.

VG-99 Editor

You can use this to make settings for the VG-99 from your computer. You can also save tone setting (patch) data you have created as files on the computer.

VG-99 Librarian

You can manage the VG-99's settings and patches all together using your computer.

Driver Mode

The VG-99 features two operational modes, one which uses the special driver contained on the included CD-ROM, and one in which the OS's (Windows/Mac OS) standard driver is used.

Using the specialized driver, you can record, play back, and edit audio with high-quality sound and stable timing.

It also allows you to control the VG-99 using MIDI messages.

Switching the Driver Mode

1. Press [SYSTEM].
2. Press PAGE [◀] [▶] to go to Page 2.



3. Press [F2] (USB).
4. Press PAGE [▶] to go to Page 2.

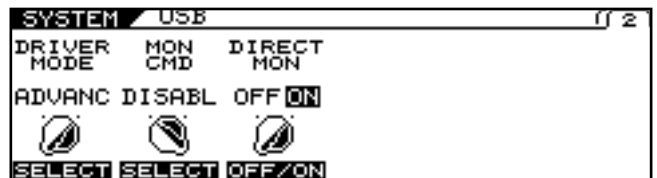

5. Set the DRIVER MODE with [F1] (SELECT) or the F1 knob.

Setting	Explanation
STNDRD	This mode uses the OS's standard USB driver.
ADVANC	This mode uses the dedicated driver contained on the CD-ROM.

* When using VG-99 Editor/Librarian, set this to ADVANC.

* The message "PLEASE RESTART" appears when DRIVER MODE is switched.

6. Press [EXIT] one or more times to return to the Play screen.

* If you have not yet installed the driver for the mode you have set, turn off the power to the VG-99 in this condition and install the driver.

7. Quit all sequencer software and other applications on the computer that are using the VG-99.

8. Turn on the power to the VG-99 again.

* The functions of a mode won't become available until after the power has been turned off, then on again.

About MIDI in Standard Driver Mode

You cannot use MIDI when STNDRD is selected as the driver mode. If you want to use MIDI with the USB connection, set the VG-99 to the advanced driver mode.

Setting the USB Functions

The following section describes the VG-99's USB-related functions. Make these settings in accordance with how you plan to use the VG-99.

Setting the Digital Audio Signal Input and Output

1. Press [SYSTEM].
2. Press PAGE [▶] to go to Page 2.



3. Press [F2] (USB).
4. Press PAGE [◀] to go to Page 1.



5. Change the setting's value with [F1]–[F4] or the F1–F4 knobs.
6. Press [EXIT] one or more times to return to the Play screen.

Parameter/Range	Explanation
USB IN	
This sets the point at which digital audio signals received via USB (from your computer) are connected within the VG-99.	
* Unless this is set to OFF, make sure the software is not set to thru for audio signals.	
* If the USB IN parameter is set to COSM GTR A, COSM GTR B, or NORMAL PU, the setting automatically changes to MAIN & SUB the next time the VG-99 is powered up. If you plan to use COSM GTR A, COSM GTR B, or NORMAL PU, make the setting each time you turn on the power to the VG-99.	
OFF	The signals are not connected at any point.
COSM GTR A	The signals are connected at the point where the COSM GUITAR A is output. The audio output from the computer, instead of the COSM guitar sounds played by the connected guitar, is input to the effects. * POLY FX are not applied.

Parameter/Range	Explanation
COSM GTR B	The signals are connected at the point where the COSM GUITAR B is output. The audio output from the computer, instead of the COSM guitar sounds played by the connected guitar, is input to the effects. * POLY FX are not applied.
NORMAL PU	The signals are connected at the normal pickup input. The audio output from the computer, instead of the normal sounds played by the connected guitar, is input to the effects.
MAIN OUT	The signals are connected at the point where MAIN OUT is output. The signals from the VG-99's MAIN OUT and the audio output from the computer are mixed and output.
SUB OUT	The signals are connected at the point where SUB OUT is output. The signals from the VG-99's SUB OUT and the audio output from the computer are mixed and output.
MAIN&SUB	The signals are connected at the point where both MAIN OUT and SUB OUT are output. Each of the signals from the VG-99's MAIN OUT and the audio output from the computer are mixed, SUB OUT and the audio output from the computer are mixed from the output.
IN LEVEL	
0–200	Adjusts the volume level of the digital audio received via USB (from the computer).
USB OUT	
This sets the point internally within the VG-99 from which signals are output via USB (to the computer).	
COSM GTR A	The output from COSM GUITAR A is output.
COSM GTR B	The output from COSM GUITAR B is output.
NORMAL PU	The normal pickup input is output.
CH A	The output from Channel A is output.
CH B	The output from Channel B is output.
MIXER (DRY)	The signals that have been mixed with the mixer, but before application of DELAY/REVERB, are output.
MIXER	The signals that have been mixed with the mixer and have DELAY/REVERB applied are output.
MAIN OUT	The same signals as those from MAIN OUT are output.
SUB OUT	The same signals as those from SUB OUT are output.
OUT LEVEL	
0–200	Adjusts the volume level of the digital audio output via USB (to the computer).

Setting the Direct Monitor

1. Press [SYSTEM].
2. Press PAGE [◀] [▶] to go to Page 2.



3. Press [F2] (USB).
4. Press PAGE [▶] to go to Page 2.



5. Change the setting's value with [F2] (SELECT), [F3] (OFF/ON) or the F2, F3 knobs.

cf.

For more information on signal paths set by the Direct Monitor parameter settings, refer to “Signal Flow” (p. 183).

6. Press [EXIT] one or more times to return to the Play screen.

Parameter/Range	Explanation
MON CMD (Monitor Command)	
This setting determines whether or not the command (the Direct Monitor command) controlling the Direct Monitor (described later) setting is enabled.	
DISABL	The Direct Monitor command is disabled, maintaining the Direct Monitor mode set by the VG-99.
ENABLE	The Direct Monitor command is enabled, allowing the Direct Monitor mode to be switched from an external device.
DIRECT MON (Direct Monitor)	
Switches the output of the VG-99 sound to the PHONES jack, MAIN OUT jacks, or SUB OUT jacks.	
OFF	Set this to Off if transmitting audio data internally through a computer (Thru).
ON	The VG-99 sound is output. Set this to On when using the VG-99 as a standalone device, without connecting to a computer (only USB IN input sound will be output if this is set to Off).
* This setting cannot be saved. It is set to ON when the power is turned on.	
* If you are using the special driver, you can control DIRECT MON On/Off from ASIO 2.0-compatible application.	

Recording the VG-99's Output with a Computer

In the computer application, set the audio input port to the VG-99. You can freely set the point at which signals are sent to the computer with "USB OUT" (p. 73)

For example, by selecting COSM GTR A or COSM GTR B, you can listen to the performance with the effects applied, while recording it without the effects.

* If passing audio data through the software you're using, switch the direct monitor off.

Using the VG-99 to Add Effects to Audio Playback from a Computer

In the computer application, set the audio output port to the VG-99. You can use the VG-99 to apply effects to the audio data played by the computer, then record the data again with the computer.

Use this process when, for example, you want to add effects to existing audio data.

* Set the software so audio is not passed through it.

1. Press [SYSTEM].
2. Press PAGE [◀] [▶] to go to Page 2.



3. Press [F2] (USB).
4. Press PAGE [◀] to go to Page 1.



5. Use [F1] or the F1 knob to set the point within the VG at which you want the connection to be made.

Here, set either COSM GTR A, COSM GTR B, or NORMAL PU.

cf. ➔

For more information about the USB IN parameter settings, refer to "Setting the Digital Audio Signal Input and Output" (p. 73).

6. Use [F2] or the F2 knob to adjust the level of the digital audio from the USB (computer).
7. Press [EXIT] one or more times to return to the Play screen.

Chapter 8 Other Functions

Changing the Tone in Real Time with the D Beam and Ribbon Controllers

Adjusting the D Beam (CALIBRATION)

The sensitivity of the D Beam controller can vary depending on the amount of light in the vicinity of the controller and the object (e.g., hand, guitar neck) used to operate it. Perform this adjustment so you can control the tone in the intended range.

1. Press [SYSTEM].
2. Press PAGE [◀] [▶] to go to Page 2.



3. Press [F5] (CALIB).
4. Press PAGE [◀] to go to Page 1.



5. Set the beam's responsive range as you actually operate the D Beam controller.
 - First, hold the object you will use to activate the controller (your hand, guitar neck, etc.) at the point farthest from the VG-99 in the range you want the controller to respond, and press [F1] (SetMIN).
 - Next, hold the object at the closest point in the range you want the controller to respond, and press [F4] (SetMAX).
6. Press [EXIT] several times to return to the Play screen.

NOTE

- The D Beam controller's response may also vary with the stage lighting used. Confirm operation of the controller by testing it onstage under the actual illumination.
- If the set range is too narrow or if the positioning is not suitable, the message "OUT OF RANGE! SET AGAIN." appears. To keep this message from appearing, change the range or position and recalibrate.
- The controller may not function properly with spot lights or other such lighting shining directly on it.

MEMO

- Be sure to adjust the CALIBRATION directly above the D Beam controller.

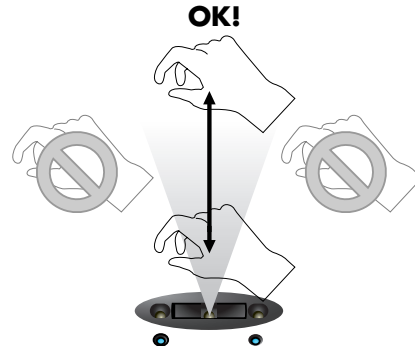

- When the message "MISSING THE TARGET!" appears, it indicates that the calibration is not being performed correctly.
- The CALIBRATION setting is a system parameter, so the Write procedure is not required.

Disabling the D Beam (DISABLE)

You can disable the D Beam controller for the entire device. If you are using the VG-99 rack-mounted or otherwise not using the D Beam controller, we recommend disabling the D Beam controller by setting D BEAM DISAB to OFF.

1. Press [SYSTEM].
2. Press PAGE [◀] [▶] to go to Page 2.
3. Press [F5] (CALIB).
4. Press PAGE [◀] to go to Page 1.

The D BEAM CALIB screen appears.



5. Switch the controller on or off with [F6] (OFF/ON).

Available Settings	Explanation
OFF	The D Beam is enabled.
ON	The D Beam is disabled. * Pressing the D BEAM [PITCH], [FILTER], or [ASSIGNABLE] button to switch the D Beam controller on will have no effect.

6. Press [EXIT] several times to return to the Play screen.

MEMO

The DISABLE setting is a system parameter, so the Write procedure is not required.

Controlling Sounds by Hand Motion or the Guitar Neck (D Beam Controller)

The D Beam controller allows you to change the sounds played by moving your hand or guitar neck over it. You can apply various effects to the sound by changing the functions assigned to this controller.

MEMO

Before using the D Beam controller, you need to adjust its sensitivity “Adjusting the D Beam (CALIBRATION)” (p. 76).

1. Press the D BEAM [PITCH], [FILTER], or [ASSIGNABLE] button to switch the D Beam controller on.

MEMO

The D Beam controller ON/OFF setting is a patch parameter. Carry out the Write procedure as required. (p. 38)

Available Settings	Explanation
PITCH	You can use the T-Arm function to control the guitar’s pitch, and the Freeze function to hold guitar sounds. * The PITCH effect is applied only to COSM guitars. Use this with the COSM guitar volume raised. (p. 33)
FILTER	You can change the tone using the D Beam controller.
ASSIGNABLE	The D Beam controller controls the function assigned to it. You can assign a variety of functions to the controller.

cf.

For instructions on how to set these functions and tones, please read “Using the Switches, Pedals, and MIDI to Control the Sounds (CONTROL ASSIGN)” (p. 82).

2. While you play the guitar to produce sound, place your hand or guitar neck above the D Beam controller and move it slowly up and down.

MEMO

Use of the D Beam ASSIGNABLE setting also enables detection horizontally (left to right).

3. The effect is applied to the sound in accordance with the function assigned to the D Beam controller.

The blue indicator under the D Beam controller lights while the D Beam effect is being applied.

- To turn off the D Beam controller, press the button you pressed in Step 1 again so the indicator goes off.

Effective Range of the D Beam Controller

The D Beam controller's effective range is shown in the figure below. Moving your hand outside this effective range produces no effect.

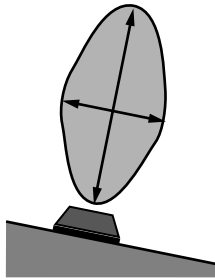

NOTE

The effective range of the D Beam controller will be extremely limited when used under strong, direct sunlight. Please be aware of this when using the D Beam controller outdoors.

NOTE

The sensitivity of the D Beam controller can vary depending on the amount of light in the vicinity of the unit. If it does not function as you expect, adjust the D Beam. (p. 76)

MEMO

The parameter values set by holding your hand or other object over the D Beam controller change as shown below.

D BEAM vertical movements	Explanation
Closer to the D Beam	The value approaches the MAX value.
Farther from the D Beam	The value approaches the MIN value.

D BEAM horizontal movements	Explanation
To the right of the D Beam	The value approaches the MAX value.
To the left of the D Beam	The value approaches the MIN value.

Adjusting the Ribbon Controller (CALIBRATION)

While the ribbon controller has been adjusted at the factory for optimum performance, the responsive range may vary with the width of the finger used to activate the controller.

If this occurs, use the procedure below to readjust the range.

- Press [SYSTEM].
- Press PAGE [◀] [▶] to go to Page 2.



- Press [F5] (CALIB).
- Press PAGE [▶] to go to Page 2.

The RIBBON CALIB screen appears.



- Set the responsive range as you actually operate the ribbon controller.

- First, while holding your finger against the near end of the ribbon controller, press [F1] (SetMIN).
- Next, hold your finger against the far end and press [F4] (SetMAX).

NOTE

If the message "OUT OF RANGE! SET AGAIN." is displayed, carry out the calibration process once more. If the message continues to appear even after the calibration is correctly performed, it may indicate damage or malfunction. Consult your Roland dealer or contact Roland Service.

- Press [EXIT] several times to return to the Play screen.

MEMO

The CALIBRATION setting is a system parameter, so the Write procedure is not required.

Controlling the Sounds with the Movement of Your Fingertip (Ribbon Controller)

The ribbon controller allows you to change sounds by “scratching” or tracing your finger along the ribbon. You can apply various effects to the sound by changing the functions assigned to this controller.

1. Press the RIBBON CONTROLLER [PITCH], [FILTER], or [ASSIGNABLE] button to switch on the ribbon controller.

Available Settings	Explanation
PITCH	You can use the T-Arm function to control the guitar’s pitch, and the Freeze function to hold guitar sounds. * The PITCH effect is applied only to COSM guitars. Use this with the COSM guitar volume raised. (p. 33)
FILTER	You can change the tone using the ribbon controller.
ASSIGNABLE	The ribbon controller controls the function assigned to it. You can assign a variety of functions to the controller.

cf. ➔

For more on how to set functions and tones, please read “Using the Switches, Pedals, and MIDI to Control the Sounds (CONTROL ASSIGN)” (p. 82).

2. While you play the guitar to produce sound, scratch your finger along the ribbon controller.
3. The effect is applied to the sound in accordance with the function assigned to the ribbon controller.
4. To turn off the ribbon controller, press the button you pressed in Step 1 again so the indicator goes off.

MEMO

The setting switching the ribbon controller on and off is a patch parameter. Carry out the Write procedure as required.

NOTE

A light touch is sufficient when operating the ribbon controller. Never press the ribbon controller forcefully or with a hard object or a pointed object.

Holding Sounds for Extended Periods (FREEZE)

You can press the D BEAM [PITCH] button to use the FREEZE effect, which allows you to hold sounds indefinitely.

1. Press [CONTROL ASSIGN]
2. Press PAGE [◀] [▶] to go to Page 2.

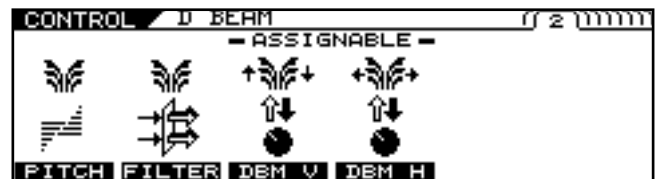

3. Press [F1] (PITCH).
4. Select FREEZE with [F1] (SELECT) or the F1 knob.

The D BEAM FREEZE screen appears.



5. Use [F2] (SELECT) or the F2 knob to select the channel with the sounds you want to freeze.
6. Set each of the FREEZE parameters on Page 1 or Page 2

cf. ➔

For more detailed information on the parameters that can be set, refer to (p. 151).

7. Press [EXIT] several times to return to the Play screen.
8. Press the D BEAM [PITCH] button, causing the indicator to light.
9. Play the guitar, and while the sounds are playing, cut across the D Beam with your hand or guitar neck.
10. The FREEZE function switches on and the same sound continues to hold, while the D Beam controller’s blue indicator lights up.
11. To switch FREEZE off, swipe your hand or guitar neck across the D Beam controller’s beam.

* With D BEAM:FREEZE:SW set as the target in Control Assign, you can control the FREEZE effect ON/OFF using an external

pedal, MIDI device, or any of a variety of other controllers.

Changing the Pitch as with a Tremolo Arm (T-ARM)

You can press the D BEAM or RIBBON CONTROLLER [PITCH] button to use T-ARM, which changes the pitch of the COSM guitar like a tremolo arm.

1. Press [CONTROL ASSIGN]
2. Press PAGE [◀] [▶] to go to Page 2 for the D Beam, or Page 3 for the ribbon controller.

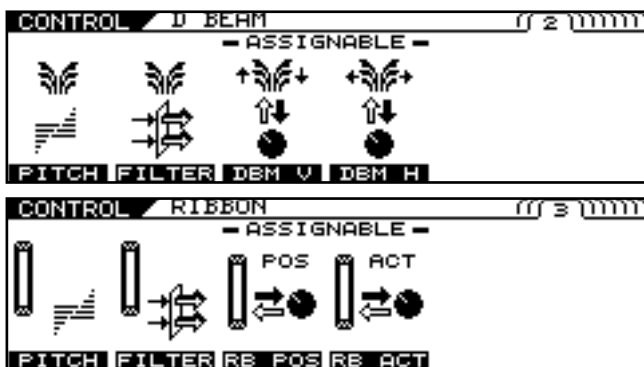

3. Press [F1] (PITCH).
4. Press PAGE [◀] to go to Page 1.
5. Select T-ARM with [F1] (SELECT) or the F1 knob.

The D BEAM T-ARM or the RIBBON T-ARM screen appears.

* This step is not necessary if you are using the ribbon controller. In this case, proceed to Step 5.

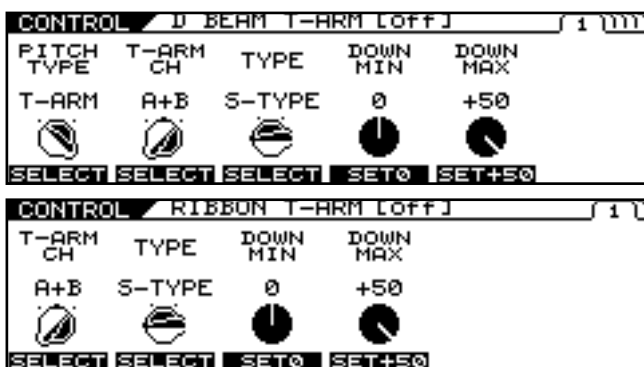

6. Use [F2] (SELECT) or the F2 knob in the D Beam screen or [F1] (SELECT) or the F1 knob in the Ribbon Controller screen to select the channel to which you want to apply the effect.
7. Set each of the T-ARM parameters on Page 1 or Page 2

cf.

For more detailed information on the parameters that can be set, refer to "PITCH" (p. 151), (p. 153).

8. Press [EXIT] several times to return to the Play screen.
9. Press the D BEAM or RIBBON CONTROLLER [PITCH] button, causing the indicator to light.
10. Use the D Beam or ribbon controller like a tremolo arm to change the pitch.

* With D BEAM:T-ARM:SW or RIBBON:T-ARM:SW and "BEAM:T-ARM:CONTROL and RIBBON:T-ARM:CONTROL set as the target in Control Assign, you can control the T-ARM effect using an external pedal, MIDI device, or any of a variety of other controllers.

Adding Nuance to the Sound (FILTER)

You can press the D BEAM or RIBBON CONTROLLER [FILTER] button to apply the FILTER effect and add nuance to the tone in Channel A or B, or both channels.

1. Press [CONTROL ASSIGN]
2. Press PAGE [◀] [▶] to go to Page 2 for the D Beam, or Page 3 for the ribbon controller.

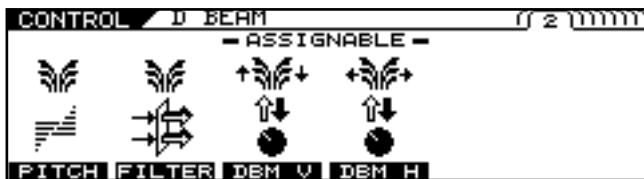

3. Press [F2] (FILTER).
4. Press PAGE [◀] to go to Page 1.

The D BEAM FILTER or the RIBBON FILTER screen appears.



5. Use [F1] (SELECT) or the F1 knob to select the channel to which you want the effect to be applied.
6. Set each of the FILTER parameters on Page 1.

cf. ➔

For more detailed information on the parameters that can be set, refer to "FILTER" (p. 152), (p. 153).

7. Press [EXIT] several times to return to the Play screen.
8. Press the D BEAM or RIBBON CONTROLLER [FILTER] button, causing the indicator to light.

9. Use the D Beam or ribbon controller to apply the filter and add nuance to the sound.
 - * With D BEAM:FILTER:SW or RIBBON:FILTER:SW and D BEAM:FILTER:CONTROL and RIBBON:FILTER:CONTROL set as the target in Control Assign, you can control FILTER:CONTROL using an external pedal, MIDI device, or any of a variety of other controllers.

Changing the Sounds with the Knobs as You Play (DIRECT EDIT)

You can assign parameters to the F1–F6 knobs to control the parameters as you play.

Additionally, you can check (display) the assigned parameters by pressing [F1]–[F6].

1. Press [CONTROL ASSIGN]
2. Press PAGE [▶] to go to the last page.

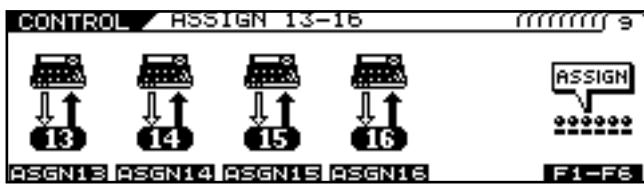

3. Press [F6] (F1–F6) to enter the DIRECT EDIT screen.

The DIRECT EDIT screen appears.

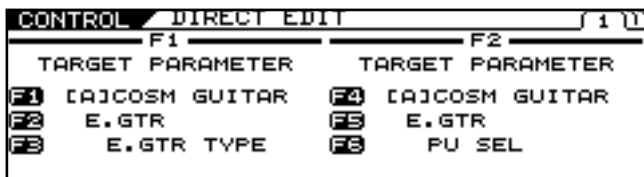

4. Press Page [◀] [▶] to go to the page for the knob you want to set.
5. Use the [F1]–[F6] or F1–F6 knobs to select the parameters you want to assign to the knob.
6. If you want to save the edited settings, perform the Write procedure (p. 38).

* If not saving the settings, press [EXIT] to return to the Play screen.

Using the Switches, Pedals, and MIDI to Control the Sounds (CONTROL ASSIGN)

These settings are made when parameters are to be controlled with the GK-3 VOLUME knob or DOWN/S1, UP/S2 switches, the VG-99's CONTROL buttons, an external pedal or other connected controller, or a connected MIDI device.

In addition to settings already assigned to controllers, the VG-99 also features sixteen prepared general-purpose control assigns that let you freely assign settings to controllers as you like.

- * If you intend to control the parameters of effects and the like, be sure to set the effect to ON beforehand.
- * For more detailed information on the parameters, refer to "CONTROL ASSIGN" (p. 150).
- * Enabling the settings requires setting each of the controller assignments to ASSIGNABLE in the SYSTEM CONTROL ASSIGN screen. For detailed information, refer to "Setting the GK VOLUME Control and Switch and the Pedal Function (SYSTEM CONTROL ASSIGN)" (p. 49).

1. Press [CONTROL ASSIGN]
2. Select the controller you want to set with PAGE [◀] [▶] and [F1]–[F6].

The various controllers' setting screens appear.

* The following section describes the controllers you can set.

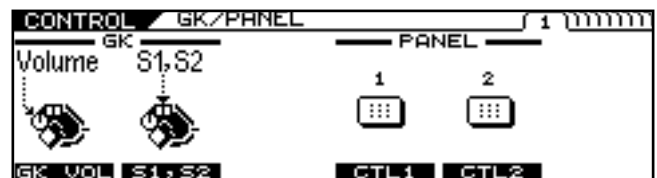

	Displayed screen	Controller
GK VOL	GK VOL	Settings for the volume knob on the GK-3.
S1, S2	GK S1, S2	Settings for the switches on the GK-3.
CTL1	CONTROL1	Settings for the CONTROL 1 Button on the VG-99's top panel.
CTL2	CONTROL2	Settings for the CONTROL 2 Button on the VG-99's top panel.

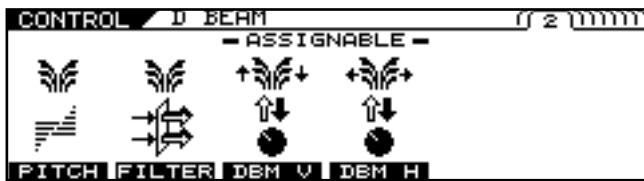

	Displayed screen	Controller
PITCH	D BEAM T-ARM/ D BEAM FREEZE	Control of TREMOLO ARM/ FREEZE with the D Beam controller
FILTER	D BEAM FILTER	Control of FILTER with the D Beam controller
DBM V	D BEAM V	D Beam controller vertical sensor
DBM H	D BEAM H	D Beam controller horizontal sensor



	Displayed screen	Controller
PITCH	RIBBON PITCH	Control of PITCH with the Ribbon controller
FILTER	RIBBON FILTER	Control of FILTER with the Ribbon controller
RB POS	RIBBON POS	Ribbon controller position sensor
RB ACT	RIBBON ACT	Ribbon controller touch sensor



	Displayed screen	Controller
EXP	EXP PEDAL	Settings for the expression pedal connected to the EXP PEDAL jack on the VG-99's rear panel.
CTL3	CTL3	Settings for the footswitch connected to the CTL3 jack on the VG-99's rear panel.
CTL4	CTL4	Settings for the footswitch connected to the CTL4 jack on the VG-99's rear panel.

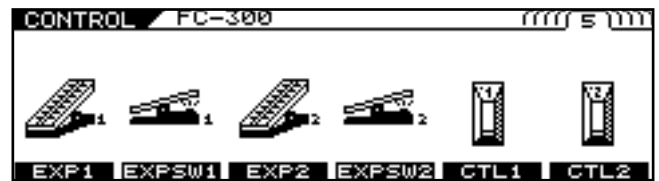

	Displayed screen	Controller
EXP1	FC EXP1	Settings for the expression pedal 1 on the FC-300 connected to the VG-99.
EXP1SW1	FC EXP1SW1	Settings for the expression pedal switch 1 on the FC-300 connected to the VG-99.
EXP2	FC EXP2	Settings for the expression pedal 2 on the FC-300 connected to the VG-99.
EXP2SW2	FC EXP2SW2	Settings for the expression pedal switch 2 on the FC-300 connected to the VG-99.
CTL1	FC CTL1	Settings for the CTL1 on the FC-300 connected to the VG-99.
CTL2	FC CTL2	Settings for the CTL2 on the FC-300 connected to the VG-99.



	Displayed screen	Controller
E3/C3	FC E3/C3	Settings for the expression pedal 3 or footswitch 3 connected to the FC-300's rear panel.
CTL4	FC CTL4	Settings for the footswitch 4 connected to the FC-300's rear panel.
E4/C5	FC E4/C5	Settings for the expression pedal 4 or footswitch 5 connected to the FC-300's rear panel.
CTL6	FC CTL6	Settings for the footswitch 6 connected to the FC-300's rear panel.
E5/C7	FC E5/C7	Settings for the expression pedal 5 or footswitch 7 connected to the FC-300's rear panel.
CTL8	FC CTL8	Settings for the footswitch 8 connected to the FC-300's rear panel.

Chapter 8 Other Functions

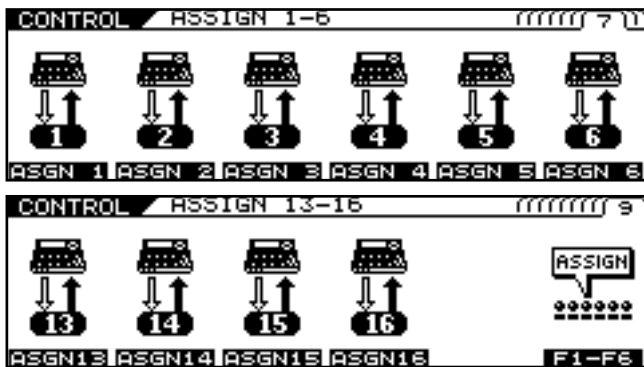

	Displayed screen	Controller
ASGN 1 : ASGN16	ASSIGN1 : ASSIGN16	Settings for general purpose assigns you can set freely as controllers for MIDI messages and other controllers in addition to those described above.
F1-F6	DIRECT EDIT	Settings for the function knobs arranged below the VG-99's LCD.

3. Select the function you want to assign with PAGE [◀] [▶], [F1]–[F6], and the F1–F6 knobs.

TIP

You can assign two different functions to one controller. For example, you can assign separate functions to the GK VOL (1) and GK VOL (2) displayed in the screen.

cf.

For more on PITCH and FILTER of the D BEAM controller, refer to “Controlling Sounds by Hand Motion or the Guitar Neck (D Beam Controller)” (p. 77). For more on PITCH and FILTER of the Ribbon controller, refer to “Controlling the Sounds with the Movement of Your Fingertip (Ribbon Controller)” (p. 79).

The following section describes the parameters you can set on each page.

* The screen shown in the example is for ASSIGN1.

Page 1, 3



F1: SOURCE (ASSIGN1–16 only)

This selects the controller assigned to the function.

F3: SW (ON/OFF)

Setting this to ON enables the controller.

F4–F6: TARGET PARAMETER

Use these to select the parameter you want to assign.

You can quickly locate and select the desired parameter by first narrowing down the parameter type with F4, then using F5 and then F6 to reach the right parameter.

cf.

For more details on the parameters, refer to “CONTROL ASSIGN” (p. 150).

Page 2, 4



F2: MIN

This sets the minimum value for the target's controllable range.

F3: MAX

This sets the maximum value for the target's controllable range.

F4: SW MODE (only when a switch type controller is selected for SOURCE)

This specifies how the switches function.

Available Settings	Explanation
MOMENT	The parameter switches to the maximum value only while the switch is held down, and switches to the minimum value when the switch is released.
LATCH	The value alternately switches between maximum and minimum each time the switch is pressed.

F4: MODE (GK S1, S2 only)

This specifies how the switches function.

* *Combinations of the actions below are possible.*

S1: DEC / S2: INC

S1: INC / S2: DEC

S1: MIN / S2: MAX

S1: MAX / S2: MIN

Available Settings	Explanation
INC	The value increases.
DEC	The value decreases.
MIN	The value is set to the minimum.
MAX	The value is set to the maximum.

F5: RANGE LOW (only when an expression pedal or other controller that changes values in a continuous, non-discrete way is set as the source)

This sets the minimum for the range in which the value of the setting can be changed.

F6: RANGE HIGH (only when an expression pedal or other controller that changes values in a continuous, non-discrete way is set as the source)

This sets the maximum for the range in which the value of the setting can be changed.

About the Range of Targets' Change

The target's value changes between MIN (the minimum value) and MAX (the maximum value).

When a foot switch or other controller that switches settings on and off is used, OFF sets the minimum value and ON sets the maximum value.

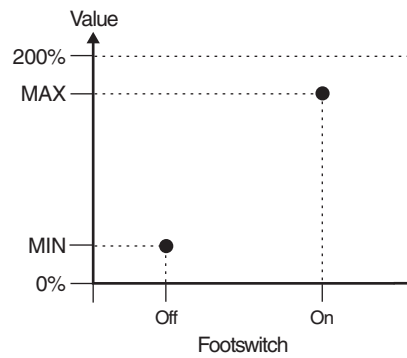

When an expression pedal or other controller that changes values in a consecutive manner is used, the value changes within the range between MIN and MAX.

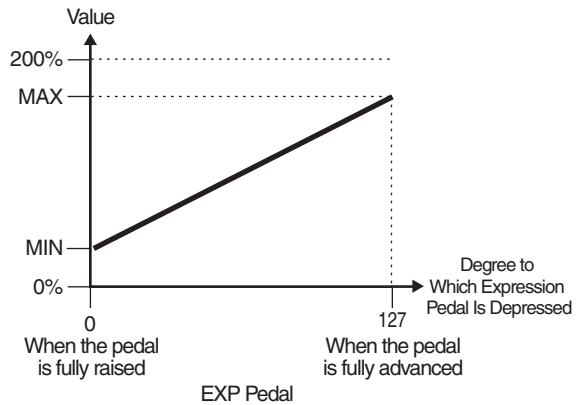

When an expression pedal or other controller that changes values in a consecutive manner is used to control a two-value (On/Off) parameter, the controller functions as shown below.

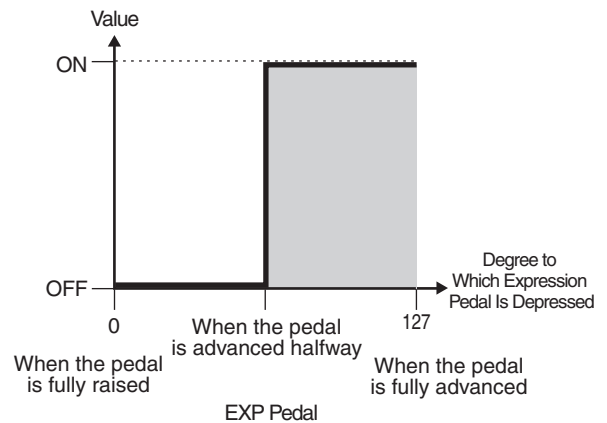

About the Range of Controllers' Change

This sets the operational range (range in which the value actually changes) for an expression pedal, or similar controller that changes the value of a setting in a continuous fashion, when it has been set as the source.

If the controller adjustment moves beyond the enabled range of operation, the value of the setting remains at the maximum value or minimum value, without changing any further.

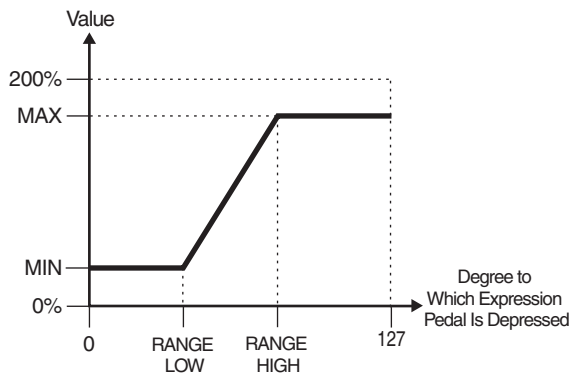

- If you want to save the edited settings, perform the Write procedure (p. 38).

* If you do not want to save, press [EXIT] to return to the Play screen.

One Touch Call Up of Favorite Patches (DIRECT PATCH)

You can assign your favorite patches to the [DIRECT PATCH 1] – [DIRECT PATCH 5] buttons, then call up these patches just by pressing the buttons.

Setting DIRECT PATCH

- Press [SYSTEM].
- Press PAGE [◀] to go to Page 1.



- Press [F2] (DIRECT).

The DIRECT PATCH screen appears.

SYSTEM		DIRECT PATCH	
F1	DIR. PATCH 1	001:V-Guitar	
F2	DIR. PATCH 2	002:Fat LP	
F3	DIR. PATCH 3	003:RB+VOX	
F4	DIR. PATCH 4	004:TE+TWIN	
F5	DIR. PATCH 5	005:JD AC_Gt CH	

- Use the F1–F5 knobs to select the patches to be assigned to [DIRECT PATCH 1]–[DIRECT PATCH 5].

The numbers correspond, with DIR. PATCH 1 assigned with the F1 knob, DIR. PATCH 2 assigned with the F2 knob, and so on.

- Press [EXIT] several times to return to the Play screen.

Managing the Patches

Copying the Current Patch to a Different Patch (PATCH COPY)

1. Confirm that the Play screen is displayed.
2. Press [WRITE].

The PATCH WRITE screen appears.

"WRITE TO" is displayed, and the write-destination patch number and name are indicated.

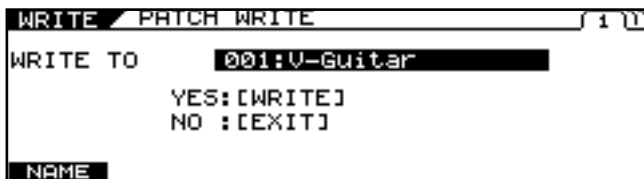

3. Use the PATCH/VALUE dial to select the copy-destination patch.
4. Press [WRITE] again.

The message "NOW WRITING..." is displayed as the patch is copied, and the VG-99 changes to the copy-destination patch number.



* If you are not saving the settings, press [EXIT] to return to the Play screen.

Exchanging the Current Patch with a Different Patch (PATCH EXCHANGE)

This exchanges the user patch with the different patch.

* You cannot exchange tones in preset patches.

1. Confirm that the Play screen for a user patch is displayed.
2. Press [WRITE].
3. Press PAGE [▶] to go to Page 2.

"EXCHANGE" is displayed.

The exchange-destination patch number and name are indicated.

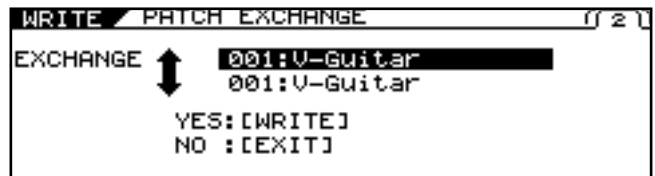

4. Use the PATCH/VALUE dial to select the exchange-destination patch.
5. Press [WRITE] again.

The message "NOW EXCHANGING..." is displayed as the current patch and the selected patch are exchanged, and the VG-99 changes to the exchange-destination patch number.



* If you are not saving the settings, press [EXIT] to return to the Play screen.

Initializing User Patches (PATCH INITIALIZE)

You can set user patches to their initial conditions, with all effects switched off.

This is convenient when you want to create a patch from scratch.

* You cannot initialize preset patches.

1. Confirm that the Play screen for a user patch is displayed.
2. Press [WRITE].
3. Press PAGE [▶] to go to Page 3.

The PATCH INITIALIZE screen appears.

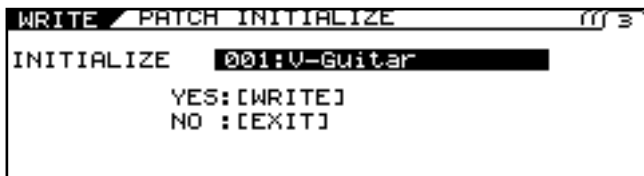

"INITIALIZE" is displayed, and the number and name of the patch to be initialized are indicated.

4. Use the PATCH/VALUE dial to select the patch you want to initialize.
5. Press [WRITE] again.

The message "NOW INITIALIZING..." is displayed as the VG-99 switches to the patch to be initialized, then the Play screen returns.



Copying Settings Between Channel A and Channel B (A/B COPY)

1. Go to the settings screen for the parameters whose settings you want to copy.
2. Press PAGE [▶] several times to go to the last page.
3. Use [F1] (SELECT) or the F1 knob to select A/B COPY.

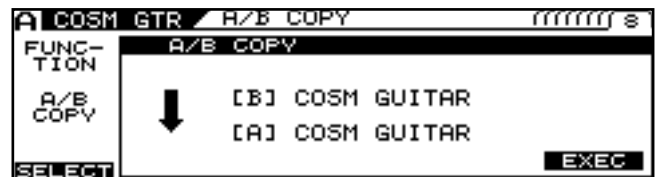

4. Press [F6] (EXEC) to copy the settings.

Exchanging the Channel A and Channel B Settings (A/B EXCHANGE)

1. Go to the settings screen for the parameters whose settings you want to exchange.
2. Press PAGE [▶] several times to go to the last page.
3. Use [F1] (SELECT) or the F1 knob to select A/B EXCHNG.



4. Press [F6] (EXEC) to exchange the settings.

Partially Copying Parameters in a Different Patch (MODULE COPY)

You can copy and reuse portions of patch parameters (such as COSM amps, effects, and other modules).

1. Go to the settings screen for the parameters whose settings you want to copy.
2. Press PAGE [►] several times to go to the last page.
3. Use [F1] (SELECT) or the F1 knob to select MODULE COPY.

The MODULE COPY screen appears.

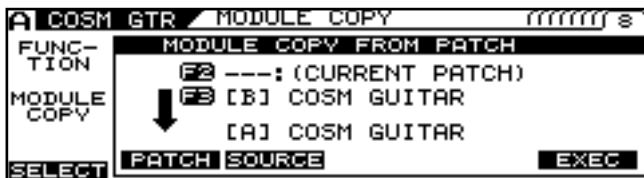

4. Use [F2] (PATCH) or the F2 knob and [F3] (SOURCE) or the F3 knob to select the copy source.
5. Press [F6] (EXEC) to copy the settings.

Partially Initializing Patch Parameters (MODULE INITIALIZE)

1. Go to the settings screen for the parameter whose settings you want to initialize.
2. Press PAGE [►] several times to go to the last page.
3. Use [F1] (SELECT) or the F1 knob to select MODULE INIT.

The MODULE INITIALIZE screen appears.

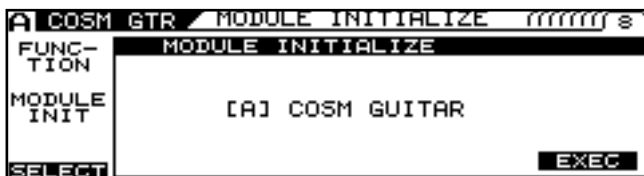

4. Press [F6] (EXEC) to initialize the settings.

The following parameters can be handled as modules.

- ALTERNATE TUNING
- COSM GUITAR
- POLY FX
- Overall FX for Channel A and B
- Each of the effects in FX
- COSM AMP
- MIXER section DELAY and REVERB
- MIXER section DYNAMIC

Separating Patches into Groups (CATEGORY)

The VG-99 includes a function that allows you to categorize patches into a number of different groups. This is called the CATEGORY function. Specifying the category for each patch makes searching for patches more convenient. The CATEGORY function also features ten user categories you can name however you like.

Using CATEGORY to Call Up Patches

1. Confirm that the Play screen is displayed.
2. Press [CATEGORY].

The Category screen appears.



The categories and the patches in these categories are shown in list format.

3. Use [F1] (SEL ▼) and [F2] (SEL ▲) or the F1 and F2 knobs to select the category.
4. Use the PATCH/VALUE dial or [F3] (SEL ▼), [F4] (SEL ▲) to select a patch.
5. Press [CATEGORY] again.

The VG-99 switches to the selected patch.

MEMO

If no operation is performed within a set period of time, the display returns to the Play screen.

Setting Patch Categories

You can assign categories to patches and separate them into groups.

1. From the PLAY screen, use the PATCH/VALUE dial to select the patch you want to include in a category.
2. Press [NAME/KEY/BPM].

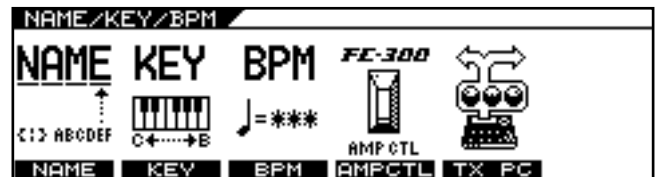

3. Press [F1] (NAME).

The Name settings screen appears.



4. Press [F6] (CATGRY).

The Category settings popup appears.



5. Use the F6 knob to select the category.
6. Press [EXIT].
7. If you want to save the edited settings, perform the Write procedure (p. 38).

* If you do not want to save, press [EXIT] to return to the Play screen.

Naming User Categories (CATEGORY NAME)

1. Confirm that the Play screen is displayed.
2. Press [SYSTEM].
3. Press PAGE [◀] [▶] to go to Page 2.



4. Press [F4] (CATGRY).
The Category Name settings screen appears.



5. Use [F6] or the F6 knob to select User Category with the name you want to change.
6. Press PAGE [◀] [▶] to move the cursor to the position with the character you want to change.
7. Select the character with the PATCH/VALUE dial.

As you continue to rotate the PATCH/VALUE dial, the character guide automatically switches from uppercase letters to lowercase letters, numerals, and symbols.

You can carry out the following operations by pressing [F1]–[F6].

Buttons	Functions
[F1] (INSERT)	Inserts a blank space at the cursor position.
[F2] (DELETE)	Deletes the character and shifts the following characters to the left.
[F3] (SPACE)	Enters a blank space at the cursor position.
[F4] (A0!)	Switches between letters, numerals, and symbols.
[F5] (A<=>a)	Switches between uppercase and lowercase letters.
[F6] (CATGRY)	Select the user category you want to name.

8. Repeat Steps 6 and 7 to complete the category name.
9. Press [EXIT] several times to return to the Play screen.

* Category names are system parameters. They are saved at the time they are entered, even without the Write procedure.

Storing Your Preferred Settings Individually (FAVORITE SETTINGS)

What are Favorite Settings?

The VG-99 includes a function that, apart from the patches, stores the settings you like for each effects processor. These are called Favorite Settings.

By storing the settings you like for each of a variety of effects processors, you can then easily create sounds simply by combining these settings.

Furthermore, creating patches using the Favorite Settings vastly simplifies editing when multiple similar tones are used.

For example, if you beforehand select the same Favorite Settings for a multiple number of patches, you'll later be able to implement changes in all those patches at once simply by editing the Favorite settings.

Calling Up Favorite Settings

Here is an example using the compressor effect.

1. Press [FX].
2. Press PAGE [◀] to go to Page 1.



3. Press [F1] (COMP).

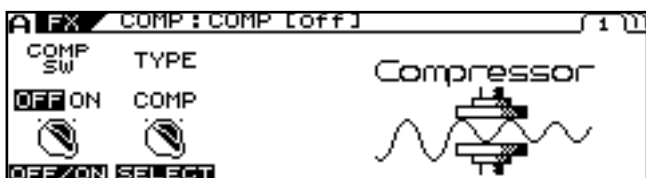

4. Press PAGE [▶] to display the last page (in this case, Page 3).
5. Use [F1] (SELECT) or the F1 knob to select FAVORITE.

The Favorite Settings selection screen appears.

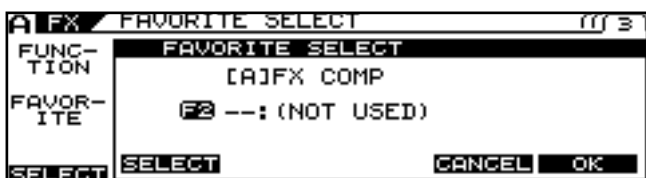

6. Use [F2] (SELECT) or the F2 knob to select your preferred setting.
7. When you have made your choice, press [F6] (OK); to cancel the procedure, press [F5] (CANCEL) or press [EXIT] several times to return to the Play screen.
8. If you want to save the edited settings, perform the Write procedure (p. 38).

* If you do not want to save, press [EXIT] to return to the Play screen.

Changing Tone Settings

This procedure changes the tones in patches using the Favorite Settings. The method below can also be used to edit the Favorite Settings themselves.

Here is an example using the compressor effect.

1. Press [FX].
2. Press PAGE [◀] to go to Page 1.



3. Press [F1] (COMP).

The number and name of the currently selected Favorite Settings are displayed.

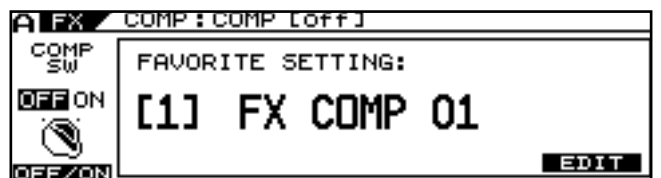

4. Press [F6] (EDIT).

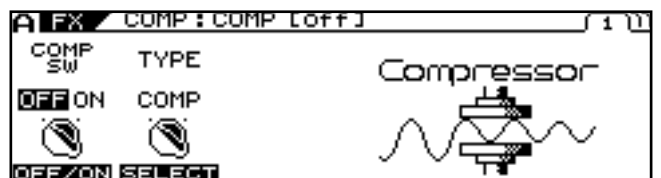

5. Use [F1]–[F4] or the F1–F4 knobs to adjust the desired parameters on Pages 1 and 2.
6. To store the content of the settings, carry out the steps described below.

Saving Changed Tones

There are two methods you can use to save changed tones.

Saving to Patches

1. Press [WRITE].

The PATCH WRITE screen appears.

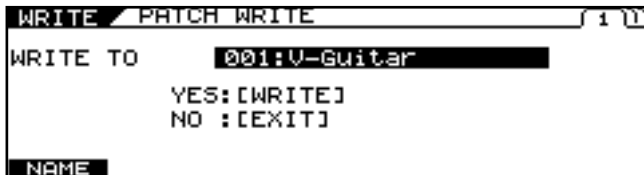

2. Use the PATCH/VALUE dial to select the save-destination patch.

3. Press [WRITE].



“NOW WRITING...” is displayed as the patch is being saved, and then the Play screen returns to the display.

NOTE

Saving tones with this process undoes the link between the patch and the Favorite Settings. Afterwards, any changes to tones with Favorite Settings used earlier will not be reflected in the tone for this patch.

Saving to the Favorite Settings

The following describes an example with the status indicated in the Compressor edit screen in Step 4 of “Changing Tone Settings” (p. 92).

1. Press PAGE [▶] to display the last page (in this case, Page 3).
2. Rotate the F1 (SELECT) knob to select FAVORITE WRITE.

The Favorite Settings save screen appears.



3. Rotate the F2 (SELECT) knob to select the write destination.

MEMO

At this point, you can press [F3] (SEARCH) to display a list of patches using the write-destination Favorite Settings. For more detailed information, refer to “Searching for Patches That Use the Same Favorite Settings” (p. 94).



4. Press [F6] (WRITE) to save the settings.

“NOW WRITING...” is displayed as the Favorite Settings are being saved, and the number and name of the currently selected Favorite Settings are displayed.



5. Press [EXIT] several times to return to the Play screen.

NOTE

This procedure only saves information to the Favorite Settings. Nothing is saved to the patches. To save parameters to patches, carry out the Write procedure. (p. 38)

Naming Favorite Settings (FAVORITE NAME)

When storing Favorite Settings, you can also give the settings names. Carry out the following procedure in Step 2 of "Saving to the Favorite Settings" (p. 93).

1. Press [F5] (NAME).

The Name edit screen appears.



2. Press PAGE [◀] [▶] to move the cursor to the position with the character you want to enter.
3. Select the character with the PATCH/VALUE dial.

As you continue to rotate the PATCH/VALUE dial, the character guide automatically switches from uppercase letters to lowercase letters, numerals, and symbols.

You can carry out the following operations by pressing [F1]–[F5].

Buttons	Functions
[F1] (INSERT)	Inserts a blank space at the cursor position.
[F2] (DELETE)	Deletes the character and shifts the following characters to the left.
[F3] (SPACE)	Enters a blank space at the cursor position.
[F4] (A0!)	Switches between letters, numerals, and symbols.
[F5] (A<=>a)	Switches between uppercase and lowercase letters.

4. Repeat Steps 2 and 3 to complete the Favorite Setting name.
5. When you have finished editing the name, press [EXIT].
The Favorite Settings save screen returns to the display.
6. Press [F6] (WRITE); the settings are saved.
7. Press [EXIT] several times to return to the Play screen.

Searching for Patches That Use the Same Favorite Settings

Here is an example using the compressor effect.

1. Press [FX].
2. Press PAGE [◀] to go to Page 1.



3. Press [F1] (COMP).

The number and name of the currently selected Favorite Settings are displayed.



If not using the Favorite Settings, proceed to Step 4.

4. Press [F6] (EDIT).

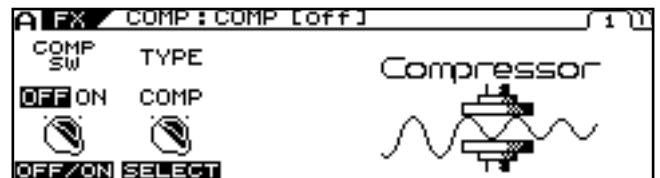

5. Press PAGE [▶] to display the last page (in this case, Page 3).
6. Use [F1] (SELECT) or the F1 knob to select FAVORITE WRITE.



7. Rotate F2 (SELECT) to select the Favorite Settings you want to search for.
8. Press [F3] (SEARCH).

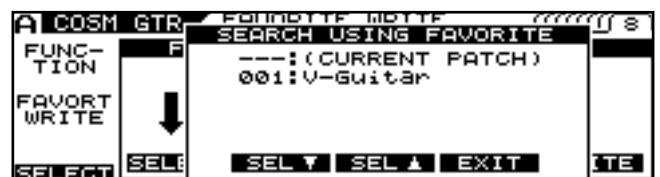

A list of patches using the selected Favorite Setting is displayed.

9. You can scroll through the list using [F3] and [F4] or the F3 and F4 knobs.
10. Press [F5] (EXIT).
The list disappears from the screen.
11. Press [EXIT] several times to return to the Play screen.

Activating the Virtual Expression Pedal at the Start of Operations (Internal Pedal System)

The VG-99 features a function called Internal Pedal system. This function assigns specified parameters to a virtual expression pedal (the internal pedal), providing an effect automatically that changes volume and tone in real time just the way an expression pedal functions.

The Internal Pedal system features the following two functions, allowing you to set Source for each assign 1-16 of the Assign.

- Internal Pedal
- Wave Pedal

* When the Internal Pedal or the Wave Pedal is used, set the ASSIGN SW MODE to MOMENT.

Internal Pedal

With the trigger you have set, the assumed expression pedal starts working. If you have set INTERNAL PEDAL to SOURCE, set the TRIGGR parameter (p. 156).

Wave Pedal

This changes the parameter selected as a target in a certain cycle with the assumed expression pedal. When you have set WAVE PEDAL for SOURCE, the RATE parameter (p. 156) and FORM parameter (p. 156) should be set.

Controlling Video Images with Your Guitar (V-LINK)

The VG-99 features the V-LINK function.

With the VG-99 connected to another V-LINK compatible device, you can use your guitar performance to control playback of video images.

What is V-LINK?

V-LINK is a function that synchronizes the performance of music and video.

Connecting V-LINK compatible devices to each other via MIDI makes it simple to enjoy using a variety of video effects linked with what you express in your performances.

For example, combining the VG-99 with the EDIROL motion dive. tokyo performance package lets you do the following.

- Set the required information for motion dive. tokyo performance package performances.
- Switch motion dive. tokyo performance package video images (palettes/clips) and control the video brightness and hue.
- Enjoy synchronized performances of music and video.

TIP

Be sure also to read the owner's manual for the connected V-LINK compatible device.

Connecting the V-LINK Device

Connect the VG-99's MIDI OUT connector to the V-LINK compatible device.

NOTE

When connecting these and other devices, turn down the volume completely on all the devices and turn off their power before connecting to prevent malfunction and damage to speakers and other equipment.

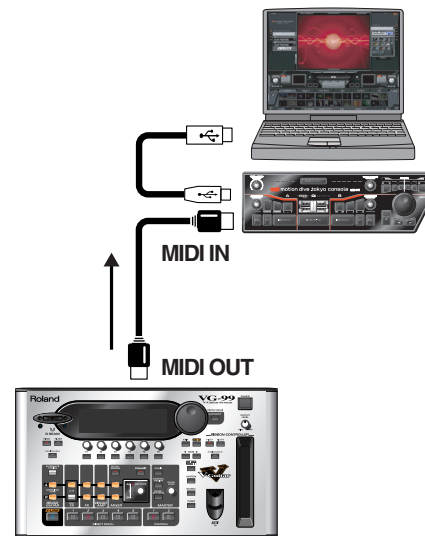

Switching V-LINK On and Off

1. Connect the VG-99's MIDI OUT connector to the V-LINK compatible device.
2. Turn on the power to the device to start it up.
3. Press [V-LINK].

V-LINK is switched on, and [V-LINK] lights up.

The function set in "Setting V-LINK" (p. 97) is enabled, allowing you to control the video images and have them linked with the performance on the VG-99.

MEMO

Even with the V-LINK on, the still usual function operates.

MEMO

Depending on the settings in "MIDI ROUTING" (p. 59), signals may not be output from MIDI OUT. In such cases, V-LINK signals are not output either.

4. Press [V-LINK] once more.

The [V-LINK] light goes off, and the V-LINK function is switched off.

MEMO

When the V-LINK function is switched off, all V-LINK-related MIDI messages are no longer output.

Setting V-LINK

1. Press [SYSTEM].
2. Press PAGE [◀] [▶] to go to Page 2.



3. Press [F3] (V-LINK).
The V-LINK screen appears.



4. Press [F1] (CLIP).
The PATCH/CLIP screen appears.



5. Use [F1] and [F2] or the F1 or F2 knobs to set the palette and clip for V-LINK Channel A; set the palette and clip for V-LINK Channel B with [F4] and [F5] or the F4 or F5 knobs.

Parameter	Available Setting	V-LINK Function	Transmitted MIDI Messages
PALETTE	OFF, 1-32	Changing the palette.	CC00 (Bank Select): 00H-1FH
CLIP	OFF, 1-32	Changing the clip.	Program Change: 00H-1FH

6. Press [EXIT] to return to the V-LINK screen.
7. Press [F4] (STR CH) to select the channel to be controlled with each string.

STRING CH 1st-6th	Explanation
OFF	No channel is controlled.
A CH	Channel A of the V-LINK compatible device is controlled.
B CH	Channel B of the V-LINK compatible device is controlled.
C CH	MIDI Note plug-in is controlled.

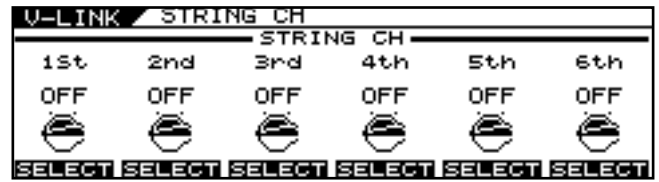

MEMO

Some V-LINK compatible models such as the EDIROL DV-7PR allow only Channel A to be used.

MEMO

Note messages output with the V-LINK function are affected by the parameters set in "Playing an External Synthesizer Sound Module (GUITAR TO MIDI)" (p. 64) as well as the STRING CH settings.

8. Press [EXIT] to return to the V-LINK screen.
9. Press [F2] (ASGN1) or [F3] (ASGN2) to select Assign 1 or Assign 2.



10. Use [F1] (SELECT) or the F1 knob to set the source to be used in operating the target.
11. Use [F2] (SELECT) or the F2 knob to set the target.

cf.

For more on the source and target parameters, refer to "V-LINK PATCH" (p. 174).

12. Rotate the F3 knob to set the minimum value for the TARGET parameter's control range.
13. Rotate the F4 knob to set the maximum value for the TARGET parameter's control range.
14. Press [EXIT] several times to return to the Play screen.

Using the VG-99 on a Stand

You can use the VG-99 while attached to a PDS-10 stand (optional).

1. Turn the VG-99 over and remove the screws from the bottom panel.

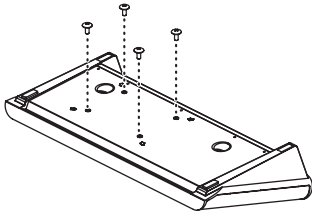

2. Attach the mounting plate as shown in the figure, using the screws removed in Step 1 or the knob nuts included with the kit.

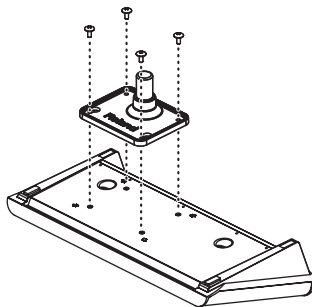

3. Attach the VG-99 to the stand.

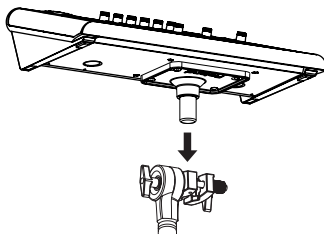

MEMO

For instructions on how to assemble the PDS-10 and attach the mounting plate, refer to the Owner's Manual that came with the PDS-10.

NOTE

- To prevent the PDS-10 stand from falling, use the attached cable ties to wind all cables around the stand, as shown in the figure below.

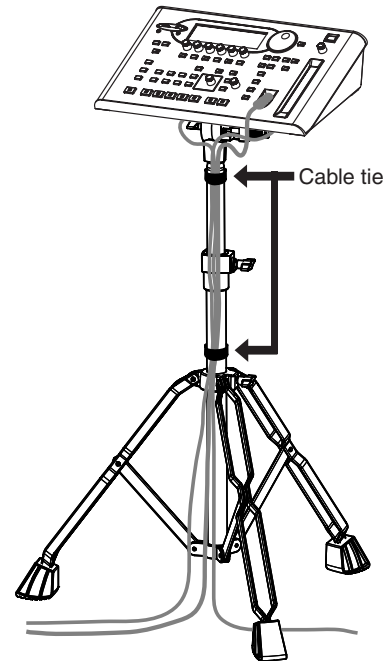

- Use the screws (M5 x 10) included with the VG-99 to attach the PDS-10 mounting plate. Use of other screws may damage the device internally or cause the unit to be inadequately secured.
- When turning the unit over, place some newspapers, magazines, or other such material under the four corners or at both ends to prevent damage to the buttons, dials, and other controls. Also, try to orient the unit so no buttons or controls are damaged.
- When turning the unit upside-down, handle with care to avoid dropping it, or allowing it to fall or tip over.
- When removing the screws, be sure to keep them out of the reach of children to prevent smaller children from accidentally swallowing them.
- Take care not to allow hands and fingers to become pinched when attaching and removing the units.

Using the VG-99 Mounted in a Rack

By employing the separately available RAD-99 rack mount adaptor, you can use the VG-99 in a rack-mounted configuration.

1. Turn the VG-99 over and remove the screws from the bottom panel.

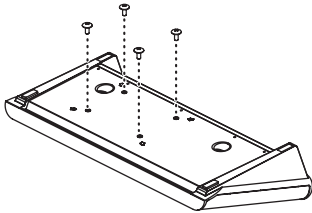

2. Attach the RAD-99 as shown in the figure, using the screws removed in Step 1 or the knob nuts included with the kit.

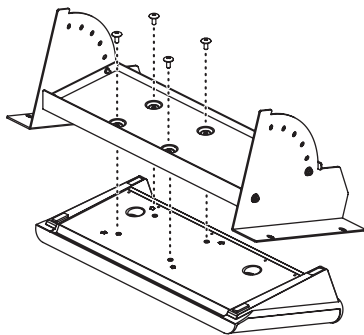

3. Mount the VG-99 in the rack.

Use screws (in four places) to securely affix the unit to the rack.

* Use the screws included with the rack.

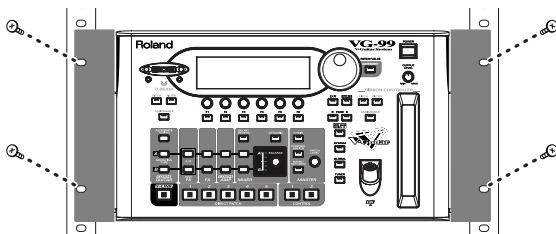

MEMO

For instructions on how to assemble the RAD-99 and adjust the angle of attachment, refer to the RAD-99 Setting Manual.

NOTE

- Use the screws (M5 x 10) included with the VG-99 to attach the RAD-99. Use of other screws may damage the device internally or cause the unit to be inadequately secured.
- When turning the unit over, place some newspapers, magazines, or other such material under the four corners or at both ends to prevent damage to the buttons, dials, and other controls. Also, try to orient the unit so no buttons or controls are damaged.
- When turning the unit upside-down, handle with care to avoid dropping it, or allowing it to fall or tip over.
- When removing the screws, be sure to keep them out of the reach of children to prevent smaller children from accidentally swallowing them.
- Take care not to allow hands and fingers to become pinched when attaching and removing the units.

Restoring the VG-99 to its Original Factory Condition (FACTORY RESET)

1. Press [SYSTEM].
2. Press PAGE [▶] to display Page 3.



3. Press [F1] (F.RST).



4. Select the parameters you want to restore to the original factory condition.

Available Settings	Explanation
ALL	All data
SYSTEM	System Parameter, Harmonist Scale, Auto Riff Phrase, Pre Amp/Speaker, Overdrive/Distortion, Wah
GK SETTING	Content of GK settings
GLOBAL	Content of settings for GLOBAL function
PATCH	Content of settings for PATCH 001-200
FAVORITE SETTING	Content of settings for FAVORITE SETTINGS 01-10 for all effects

5. Press [F6] (EXEC).

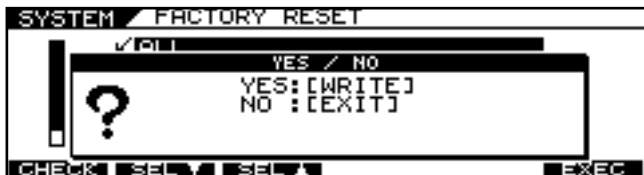

6. To execute Factory Reset, press [WRITE].

* To cancel Factory Reset, press [EXIT].

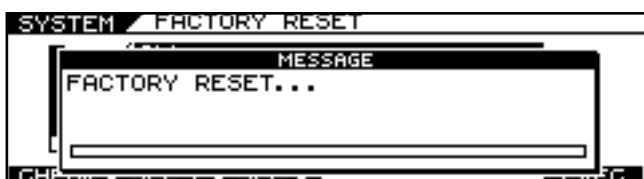

When Factory Reset is completed, the Play screen returns to the display.

Chapter 9 Parameters Guide

In this chapter you will find detailed descriptions for each of the VG-99's parameters used to control them.

The trademarks listed in this document are trademarks of their respective owners, which are separate companies from Roland. Those companies are not affiliated with Roland and have not licensed or authorized Roland's VG-99. Their marks are used solely to identify the equipment whose sound is simulated by Roland's VG-99.

COSM GUITAR

By making settings for the various elements that make up the tone of a guitar, you can create a wide variety of sounds. You can set actual guitar parameters, such as pickup, body, and the pitch of each string.

Parameter/Range	Explanation
COSM GTR SW (COSM Guitar Switch)	
OFF, ON	Turns the COSM guitar on/off.
MODLNG TYPE	
E. GTR	Select the electric guitar type.
AC	Select the acoustic guitar type.
BASS	Select the bass guitar type.
SYNTH	Select the synthesizer sound type.
E. GTR TYPE/AC TYPE/BASS TYPE/SYNTH TYPE	
refer to Type List	Select the COSM guitar from each modeling type. * <i>The parameters that can be set will depend on the type. For details on the parameters, refer to the corresponding item.</i>

Modeling Type List

E. GTR (Electric Guitar) (p. 103)

Parameter/Range	Explanation
CLA-ST (Classic ST)	The sound of a Fender Stratocaster. Simulates the installation of three single-coil pickups (passive type).
MOD-ST (Modern ST)	The sound of a Stratocaster type guitar. Simulates the installation of the EMG's three single-coil pickups (active type).
TE (Telecaster)	The sound of a Fender Telecaster. A particular characteristic of the sound is the boosted high end when the volume is turned down.
LP (Les Paul)	The sound of a Gibson Les Paul Standard. Simulates the installation of two humbucking pickups (passive type).
P-90	The sound of a Gibson Les Paul Junior. This provides two single-coil pickups of the type used on fixed-neck guitars and affectionately known as soap-bar or dog-ear pickups.
LIPS (Lipstick)	The sound of a Danelectro 56-U3. This provides two single-coil pickups, and characterized by an external case reminiscent of a tube of lipstick.
RICK (Rickenbacker)	The sound of a Rickenbacker 360. Semi-hollow body guitar with two unique single-coil pickups.
335	The sound of a Gibson ES-335 DOT. Typical semi-acoustic guitar with two humbucking pickups.
L4	The sound of a Gibson L-4 CES. Acoustic body guitar suited for jazz. Equipped with two humbucking pickups and strung with flat wound strings.
VARI (Variable Guitar)	This allows you to design your own guitar: you can use up to two pickups of your choice, selecting from double-coil, single-coil, piezo, and acoustic. If you use double-coil or single-coil type pickups, you may freely adjust the location of the pickups. This lets you make settings for the pickup, body, and the pitch of each string to specify the sound of the guitar.

AC (Acoustic Guitar) (p. 105)

Parameter/ Range	Explanation
STEEL (Steel String Guitar)	This is the sound of steel strings.
NYLON (Nylon String Guitar)	This is the sound of nylon strings.
SITAR	This is the sound of a Coral electric sitar. The settings adjust the sitar's characteristic buzzing sound and tone.
BANJO	This models a general banjo strung with five strings.
RESO (Resonator)	This models a Dobro-type resonator guitar.
VARI (Variable Guitar)	This lets you make settings for the pickup, body, and the pitch of each string to specify the sound of the guitar.

BASS (Bass Guitar) (p. 109)

Parameter/ Range	Explanation
JB (Jazz Bass)	The sound of a Fender Jazz Bass.
PB (Precision Bass)	The sound of a Fender Precision Bass.

SYNTH (Synthesizer) (p. 110)

Parameter/ Range	Explanation
GR-300	This models the Roland GR-300, the famed analog polyphonic guitar synthesizer of yesteryear. With the HEXA-DISTORTION effect and pitch-shifting six-string sawtooth wave generation from the instrument's HEXA VCO and VCF (variable frequency filter) brings out all the nuance from guitar performance, yet with the tone of an analog synthesizer.
BOWED	This Instrument represents stringed musical instruments played with a bow.
DUAL	This Instrument takes the string vibration that is input and adds both distortion and portions which have the pitch glided.
FILTER BASS	This Instrument is like a bass whose sound is passed through a filter.
PIPE	This Instrument produces sounds like a soft woodwind lead instrument.
SOLO	This is a soft lead Instrument.
PWM (Pulse-width Modulation)	This Instrument represents the pulse-width modulation (PWM) of an analog synthesizer. The pulse width of the waveform produced by the vibrating string is varied cyclically to create a characteristic sound.
CRYSTL	This is an Instrument providing a metallic luster.
ORGAN	This is a Long Tone Instrument suitable for playing solo parts or slow songs. Like an organ, you should balance out the volume levels for the three parameters (FEET 16, 8, 4) to create just the sound you're after.
BRASS	This instrument detects the pitch of the electric guitar and creates a synthesizer sound.
WAVE (Wave Synth)	This algorithm creates synth sounds by directly processing the string signal from the Divided pickup. It allows a natural feeling of playability.

E.GTR (Electric Guitar)

Setting the parameter of electric guitar.

CLA-ST/MOD-ST

Parameter/Range	Explanation
PU SEL (Pickup Select)	
REAR	Use the rear pickup.
R+C	Use both center and rear pickups.
CENTER	Use the center pickup.
C+F	Use both front and center pickups.
FRONT	Use the front pickup.
VOL (Volume)	
0-100	Sets the volume. With a setting of 0, there will be no sound.
TONE	
0-100	Adjusts the tone. The standard value is 100; lowering the value creates a softer tone.

TE/LP/P90/RICK/335/L4

Parameter/Range	Explanation
PU SEL (Pickup Select)	
REAR	Use the rear pickup.
R+F	Use both rear and front pickups.
FRONT	Use the front pickup.
VOL (Volume)	
0-100	Sets the volume. With a setting of 0, there will be no sound.
TONE	
0-100	Adjusts the tone. The standard value is 100; lowering the value creates a softer tone.

LIPS

Parameter/Range	Explanation
PU SEL (Pickup Select)	
REAR	Use the rear pickup.
R+C	Use both center and rear pickups.
CENTER	Use the center pickup.
C+F	Use both front and center pickups.
FRONT	Use the front pickup.
ALL	Use all pickups.
VOL (Volume)	
0-100	Sets the volume. With a setting of 0, there will be no sound.
TONE	
0-100	Adjusts the tone. The standard value is 100; lowering the value creates a softer tone.

VARI

Parameter/Range	Explanation
PU SEL (Pickup Select)	
REAR	Use the rear pickup.
R+F	Use both rear and front pickups.
FRONT	Use the front pickup.
VOL (Volume)	
0-100	Sets the volume. With a setting of 0, there will be no sound.
TONE	
0-100	Adjusts the tone. The standard value is 100; lowering the value creates a softer tone.
STRING	
ROUND	Selects the sound of round wound strings.
FLAT	Selects the sound of flat wound strings.
VOL CURVE (Volume Curve)	
Sets the curve for the change in volume with the VOL parameter.	
A, B	
TYPE	
SINGLE	Single-coil pickup.
DOUBLE	Double-coil pickup.
PIEZO	Piezo pickup.
AC	A hypothetical pickup ideal for picking up the sound of an acoustic guitar.
POS (Position)	
5-320mm	Specifies the distance from the bridge at which the pickup is placed. Larger values will produce the effect of the pickup being further from the bridge. * If the Pickup Type has been set to PIEZO or AC the POS setting will not be available.

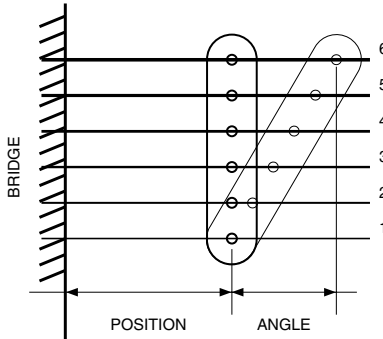
Parameter/Range	Explanation
ANGLE	
-315--+315mm	<p>This simulates the angle of the pickup relative to the strings. The setting indicates the distance from the POS setting that the sixth string will be located. With positive (+) settings, the sixth string will be further from the bridge. With negative (-) values, the sixth string will be closer to the bridge. With a setting of 0, the pickup will be perpendicular with the strings.</p>  <p>* If PIEZO or AC is selected as the pickup type, the Angle setting will not be available.</p> <p>* Angle settings which would exceed the range of the Position setting (5-320 mm) will have no effect. For example, if the Position is set to 100 mm, and valid range of the Angle setting will be -95--+220 mm.</p>
PHASE	
<p>When pickups FRONT and REAR are mixed, this setting determines the phase of pickup REAR relative to pickup FRONT. This is valid only when two pickups are being used.</p> <p>* The phase setting that is part of the pickup FRONT parameters is the same as the corresponding parameter for pickup REAR. Modifying one of them will cause the other parameter to change correspondingly.</p>	
IN	It will have the same phase as pickup FRONT.
OUT	It will be mixed in opposite phase.

E. GTR Common Parameters

Besides the other COSM E.GTR parameters, the VG-99 also includes the following shared parameters.

Parameter/Range	Explanation
EQ (Equalizer)	
A four-band equalizer with high and low ranges is provided. The sound processed by the effect can be boosted by frequency range before it is output.	
EQ SW (Equalizer Switch)	
OFF, ON	Turns the EQ effect on/off.
TOTAL GAIN	
-12--+12dB	Adjusts the volume before the equalizer.
LOW GAIN	
-12--+12dB	Adjusts the low frequency range tone.
HIGH GAIN	
-12--+12dB	Adjusts the high frequency range tone.
LOW MID FREQ (Low Middle Frequency)	
20Hz-10.0kHz	Specifies the center of the frequency range that will be adjusted by the LOW MID GAIN.
LOW MID Q (Low Middle Q)	
0.5-16	Adjusts the width of the area affected by the EQ centered at the LOW MID FREQ. Higher values will narrow the area.
LOW MID GAIN (Low Middle Gain)	
-12--+12dB	Adjusts the low-middle frequency range tone.
HIGH MID FREQ (High Middle Frequency)	
20Hz-10.0kHz	Specifies the center of the frequency range that will be adjusted by the HIGH MID GAIN
HIGH MID Q (High Middle Q)	
0.5-16	Adjusts the width of the area affected by the EQ centered at the HIGH MID FREQ. Higher values will narrow the area.
HIGH MID GAIN (High Middle Gain)	
-12--+12dB	Adjusts the high-middle frequency range tone.
Parameter/Range	
Explanation	
STRING PAN 1st-6th	
0:100-100:0	<p>This sets the left/right pan of each string.</p> <p>* The pan effect is cancelled if a monaural effect or COSM amp is connected after the COSM GUITAR effect.</p>
STRING LEVEL 1st-6th	
0-100	Specifies the output level of each string.

Parameter/Range	Explanation
MIX LEVEL	
COSM GUITAR	
0–100	Specifies the level of the COSM GUITAR.
NORMAL PU (Normal Pickup)	
0–100	Adjusts the volume of the normal pickup.

Parameter/Range	Explanation
NS (Noise Suppressor)	
This effect reduces the noise and hum picked up by guitar pickups. Since it suppresses the noise in synchronization with the envelope of the guitar sound (the way in which the guitar sound decays over time), it has very little effect on the guitar sound, and does not harm the natural character of the sound.	
SW (Noise Suppressor Switch)	
OFF, ON	Turns the NS effect on/off.
THRSH (Threshold)	
0–100	Adjust this parameter as appropriate for the volume of the noise. If the noise level is high, a higher setting is appropriate. If the noise level is low, a lower setting is appropriate. Adjust this value until the decay of the guitar sound is as natural as possible.
REL (Release)	
0–100	Adjusts the amount of time from the point at which application of the noise suppressor begins to when the volume is fully attenuated.

AC (Acoustic Guitar)

Setting the parameter of acoustic guitar.

STEEL

Parameter/Range	Explanation
BODY TYPE	
Selects the type of resonating body.	
MA28	The sound of a Martin D-28. Older model known for its exquisitely balanced sound.
TRP-0	The sound of a Martin 000-28. This model features a full low-end resonance and crisp, distinct contour.
GB45	The sound of a Gibson J-45. This vintage model features a unique, seasoned tone with good response.
GB SML	The sound of a Gibson B-25. Featuring a compact body, this vintage model is often used in blues.
GLD 40	The sound of a GUILD D-40. This model features warm resonance from the body along with a delicate string resonance.
BODY	
0–100	Adjusts the body resonance. Raising the value produces more of a sense of the guitar body in the sound. Lower the value in conditions where feedback is prone to occur.
TONE	
-50–+50	Adjusts the tone of the body. The standard value is 0; raising the value boosts the high range.
LEVEL	
0–100	Adjusts the volume of the body. With a setting of 0, there will be no sound.

NYLON

Parameter/Range	Explanation
BODY	
0-100	Adjusts the body resonance. Raising the value produces more of a sense of the guitar body in the sound. Lower the value in conditions where feedback is prone to occur. * <i>The body resonance is monophonic. This means that if this Body parameter is set to 100, the panning of each string will have less effect.</i>
ATTACK	
0-100	Specifies the strength of the attack when you pluck the string strongly. As this setting is increased, the attack will be sharper, and the sound will be crisper.
TONE	
-50+50	Adjusts the tone of the body. The standard value is 0; raising the value boosts the high range.
LEVEL	
0-100	Adjusts the volume of the body. With a setting of 0, there will be no sound.

SITAR

Parameter/Range	Explanation
PU (Pickup)	
FRONT	Use the front pickup.
R+F	Use both front and rear pickups.
REAR	Use the rear pickup.
PIEZO	Piezo pickup.
SENS (Sensitivity)	
0-100	Adjusts the input sensitivity.
BODY	
0-100	Adjusts the body resonance. Raising the value produces more of a sense of the guitar body in the sound. Lower the value in conditions where feedback is prone to occur.
COLOR	
0-100	Adjusts the overall tone quality of the sitar.
DECAY	
0-100	Adjusts the time it takes following the attack for the tone to change.
BUZZ	
0-100	Adjusts the amount of characteristic buzz produced by the buzz bridge when the strings make contact with it.
ATTACK LEVEL	
0-100	Adjusts the volume level of the attack.
TONE	
-50+50	Adjusts the tone of the body. The standard value is 0; raising the value boosts the high range.
LEVEL	
0-100	Adjusts the volume of the body. With a setting of 0, there will be no sound.

BANJO

Parameter/Range	Explanation
ATTACK	
0-100	Specifies the strength of the attack when you pluck the string strongly. As this setting is increased, the attack will be sharper, and the sound will be crisper.
RESO (Resonation)	
0-100	Adjusts the body resonance. The resonation increases as the value is raised.
TONE	
-50+50	Adjusts the tone of the body. The standard value is 0; raising the value boosts the high range.
LEVEL	
0-100	Adjusts the volume of the body. With a setting of 0, there will be no sound.

RESO

Parameter/Range	Explanation
SUSTAIN	
You can specify how the resulting volume will be affected by changes (loud/soft dynamics) in the guitar string vibrations that are input.	
0-100	Adjusts the range (time) over which low-level signals are boosted. Larger values will result in longer sustain.
RESO (Resonation)	
0-100	Adjusts the body resonance. The resonation increases as the value is raised.
TONE	
-50-+50	Adjusts the tone of the body. The standard value is 0; raising the value boosts the high range.
LEVEL	
0-100	Adjusts the volume of the body. With a setting of 0, there will be no sound.

VARI

Parameter/Range	Explanation
BODY TYPE	
Selects the type of acoustic body.	
FLAT	The body of an acoustic guitar with a flat top and back.
ROUND	The body of a flat top acoustic guitar with a round back made of resin.
f-HOLE	An f-hole body with an arched top and back. This is suitable for simulating semi-acoustic or full acoustic electric guitars.
METAL	A metal body with a single round cone resonator. This is suitable for bottle-neck (slide) playing, etc.
BANJO	This models a general banjo strung with five strings. Changing the size will produce an effect as if the tuning were changed.
SIZE	
-50-+50	Specifies the size of the body. This modifies the resonant frequency to simulate changes in body size. A setting of 0 will produce a normal resonance.
RESO (Resonation)	
0-100	Adjusts the body resonance. The resonation increases as the value is raised.
ATTACK	
0-100	Specifies the strength of the attack when you pluck the string strongly. As this setting is increased, the attack will be sharper, and the sound will be crisper. * <i>The effect is easier to discern with chords than with single notes.</i>

Parameter/Range	Explanation
BODY	
0-100	Adjusts the body resonance. Raising the value produces more of a sense of the guitar body in the sound. Lower the value in conditions where feedback is prone to occur. * <i>The body resonance is monophonic. This means that if this Body parameter is set to 100, the panning of each string will have less effect.</i> * <i>To produce the sound of a solid body, set ATTACK and BODY to 0.</i>
LOW CUT	
THRU, 55-800Hz	Specifies the cutoff frequency of the low-cut filter for the bypass sound.
LEVEL	
0-100	Adjusts the volume. With a setting of 0, there will be no sound.
PU TYPE (Pickup Type)	
PIEZO	Piezo pickup.
MIC	A hypothetical mic ideal for picking up the sound of an acoustic guitar.
PU TONE (Pickup Tone)	
-50-+50	Adjusts the tone.
PU LEVEL (Pickup Level)	
0-100	Adjusts the volume. With a setting of 0, there will be no sound.

AC Common Parameters

Besides the other COSM AC parameters, the VG-99 also includes the following shared parameters.

Parameter/Range	Explanation
EQ (Equalizer)	
A four-band equalizer with high and low ranges is provided. The sound processed by the effect can be boosted by frequency range before it is output.	
EQ SW (Equalizer Switch)	
OFF, ON	Turns the EQ effect on/off.
TOTAL GAIN	
-12~+12dB	Adjusts the volume before the equalizer.
LOW GAIN	
-12~+12dB	Adjusts the low frequency range tone.
HIGH GAIN	
-12~+12dB	Adjusts the high frequency range tone.
LOW MID FREQ (Low Middle Frequency)	
20Hz~10.0kHz	Specifies the center of the frequency range that will be adjusted by the LOW MID GAIN.
LOW MID Q (Low Middle Q)	
0.5~16	Adjusts the width of the area affected by the EQ centered at the LOW MID FREQ. Higher values will narrow the area.
LOW MID GAIN (Low Middle Gain)	
-12~+12dB	Adjusts the low-middle frequency range tone.
HIGH MID FREQ (High Middle Frequency)	
20Hz~10.0kHz	Specifies the center of the frequency range that will be adjusted by the HIGH MID GAIN.
HIGH MID Q (High Middle Q)	
0.5~16	Adjusts the width of the area affected by the EQ centered at the HIGH MID FREQ. Higher values will narrow the area.
HIGH MID GAIN (High Middle Gain)	
-12~+12dB	Adjusts the high-middle frequency range tone.

Parameter/Range	Explanation
STRING PAN 1st~6th	
100:0~100:0	This sets the left/right pan of each string. * You cannot adjust the STRING PAN parameter when AC TYPE is set to STEEL. * The pan effect is cancelled if a monaural effect or COSM amp is connected after the COSM GUITAR effect.
STRING LEVEL 1st~6th	
0~100	Specifies the output level of each string.

Parameter/Range	Explanation
MIX LEVEL	
COSM GUITAR	
0~100	Specifies the level of the COSM GUITAR.
NORMAL PU (Normal Pickup)	
0~100	Adjusts the volume of the normal pickup.

Parameter/Range	Explanation
NS (Noise Suppressor)	
This effect reduces the noise and hum picked up by guitar pickups. Since it suppresses the noise in synchronization with the envelope of the guitar sound (the way in which the guitar sound decays over time), it has very little effect on the guitar sound, and does not harm the natural character of the sound.	
SW (Noise Suppressor Switch)	
OFF, ON	Turns the NS effect on/off.
THRSH (Threshold)	
0~100	Adjust this parameter as appropriate for the volume of the noise. If the noise level is high, a higher setting is appropriate. If the noise level is low, a lower setting is appropriate. Adjust this value until the decay of the guitar sound is as natural as possible.
REL (Release)	
0~100	Adjusts the amount of time from the point at which application of the noise suppressor begins to when the volume is fully attenuated.

BASS (Bass Guitar)

Setting the parameter of bass guitar.

JB

Parameter/Range	Explanation
REAR VOL (Rear Volume)	
0-100	Sets the volume of the rear pickup. With a setting of 0, there will be no sound.
FRONT VOL (Front Volume)	
0-100	Sets the volume of the front pickup. With a setting of 0, there will be no sound.
MASTER VOL (Master Volume)	
0-100	Sets the overall bass volume level. With a setting of 0, there will be no sound.
TONE	
0-100	Adjusts the tone.

PB

Parameter/Range	Explanation
VOL (Volume)	
0-100	Sets the volume. With a setting of 0, there will be no sound.
TONE	
0-100	Adjusts the tone.

BASS Common Parameters

Besides the other COSM BASS parameters, the VG-99 also includes the following shared parameters.

Parameter/Range	Explanation
EQ (Equalizer)	
A four-band equalizer with high and low ranges is provided. The sound processed by the effect can be boosted by frequency range before it is output.	
EQ SW (Equalizer Switch)	
OFF, ON	Turns the EQ effect on/off.
TOTAL GAIN	
-12--+12dB	Adjusts the volume before the equalizer.
LOW GAIN	
-12--+12dB	Adjusts the low frequency range tone.
HIGH GAIN	
-12--+12dB	Adjusts the high frequency range tone.
LOW MID FREQ (Low Middle Frequency)	
20Hz-10.0kHz	Specifies the center of the frequency range that will be adjusted by the LOW MID GAIN.
LOW MID Q (Low Middle Q)	
0.5-16	Adjusts the width of the area affected by the EQ centered at the LOW MID FREQ. Higher values will narrow the area.
LOW MID GAIN (Low Middle Gain)	
-12--+12dB	Adjusts the low-middle frequency range tone.
HIGH MID FREQ (High Middle Frequency)	
20Hz-10.0kHz	Specifies the center of the frequency range that will be adjusted by the HIGH MID GAIN.
HIGH MID Q (High Middle Q)	
0.5-16	Adjusts the width of the area affected by the EQ centered at the HIGH MID FREQ. Higher values will narrow the area.
HIGH MID GAIN (High Middle Gain)	
-12--+12dB	Adjusts the high-middle frequency range tone.
Parameter/Range	
Explanation	
STRING PAN 1st-6th	
100:0-100:0	This sets the left/right pan of each string. * The pan effect is cancelled if a monaural effect or COSM amp is connected after the COSM GUITAR effect.
STRING LEVEL 1st-6th	
0-100	Specifies the output level of each string.

Parameter/Range	Explanation
MIX LEVEL	
COSM GUITAR	
0-100	Specifies the level of the COSM GUITAR.
NORMAL PU (Normal Pickup)	
0-100	Adjusts the volume of the normal pickup.

Parameter/Range	Explanation
NS (Noise Suppressor)	
This effect reduces the noise and hum picked up by guitar pickups. Since it suppresses the noise in synchronization with the envelope of the guitar sound (the way in which the guitar sound decays over time), it has very little effect on the guitar sound, and does not harm the natural character of the sound.	
SW (Noise Suppressor Switch)	
OFF, ON	Turns the NS effect on/off.
THRSH (Threshold)	
0-100	Adjust this parameter as appropriate for the volume of the noise. If the noise level is high, a higher setting is appropriate. If the noise level is low, a lower setting is appropriate. Adjust this value until the decay of the guitar sound is as natural as possible.
REL (Release)	
0-100	Adjusts the amount of time from the point at which application of the noise suppressor begins to when the volume is fully attenuated.

SYNTH (Synthesizer)

Setting the parameter of synthesizer sound.

GR-300

Parameter/Range	Explanation
MODE	
This setting determines whether the HEXA-VCO (sawtooth wave) or the HEXA-DISTORTION (rectangular wave) is played, or if both are played.	
VCO	The HEXA-VCO sound is played.
V+D	The HEXA-VCO and HEXA-DISTORTION sounds are played simultaneously.
DIST	The HEXA-DISTORTION sound is played.
LEVEL	
0-100	Sets the volume. With a setting of 0, there will be no sound.
COMP (Compression)	
OFF, ON	When this is set to ON, the HEXA-VCO's decay time is extended. When ENV MOD SW is set to ON, the VCF (variable frequency filter) decay time is also extended * The HEXA-DISTORTION decay time is not extended.
CUTOFF FREQ (Cutoff Frequency)	
0-100	Adjusts the cutoff frequency, setting the brightness (hardness) of the sound. The sound gets brighter (harder) as the value is raised.
RESO (Resonance)	
0-100	Adjusts the resonance (distinctiveness of the sound). As the value is increased, sounds in the frequency range near the cutoff frequency are boosted, making the sound more distinctive and unique.
ENV MOD (Envelope Modulation)	
This automatically changes the VCF cutoff frequency according to the amplitude of the string vibration. This allows you to change the tone with a wah-like effect each time you pick a string.	
SW (Switch)	
OFF	Envelope modulation is not used.
ON	This causes the VCF cutoff frequency to change from a high to low frequency each time the string is picked. This produces a wah-like effect, with the sound going from low frequencies to high. TIP Setting the cutoff frequency to an extremely high value makes the effect difficult to discern.
INV	As opposed to the ON setting, this allows you to have the VCF cutoff frequency change from a low to high frequency each time the string is picked. This produces a reverse wah-like effect, with the sound going from high frequencies to low. TIP Setting the cutoff frequency to a relatively high value makes the effect easier to discern.

Parameter/Range	Explanation
SENS (Sensitivity)	
0–100	Adjusts the input sensitivity for the envelope modulation function. As the value is raised, the change from the envelope modulation broadens with even weaker picking. TIP Confirm the change in the tone as you make the adjustment. Try setting the value near 0, then gradually raise it as you pick a string. Setting the attack time to 0 makes the changes easier to confirm.
ATTACK	
0–100	Adjusts the attack time for the change in the envelope modulation produced by picking. Raising the value slows the attack for this change.
PITCH A/PITCH A FINE, PITCH B/PITCH B FINE	
These adjust the amount of pitch shift. * This is enabled when the PITCH SW parameter is set to anything other than OFF. * The final amount of shift in the pitch is the sum of the pitch shift set with PITCH and PITCH FINE.	
PITCH A PITCH B -12–+12	This sets the amount of shift in pitch from the original sound in semitone increments. A setting of -12 lowers the pitch one octave, while +12 raises the pitch one octave.
PITCH A FINE PITCH B FINE -50–+50	This finely adjusts the pitch. A setting of -50 lowers the pitch one semitone; +50 raises the pitch by one semitone. You can use this FINE setting effectively in the DUET feature that follows.
PITCH SW (Pitch Switch)	
This setting allows you to switch on and off the pitch shift, which enables the pitch of the HEXA-VCO sound to shift in response to the pitch of the sound caused by the string's vibration. * PITCH SHIFT is applied only to the HEXA-VCO, not the HEXA-DISTORTION. Set MODE to VCO or V+D when using the pitch shift function.	
OFF	The pitch of the original source sound is unchanged.
A	The shift in pitch set with PITCH A and PITCH A FINE is applied.
B	The shift in pitch set with PITCH B and PITCH B FINE is applied.
DUET	
OFF, ON	When DUET is set to ON, then in addition to the HEXA-VCO, a sawtooth wave is played at the same pitches as the source sound, adding greater breadth to the sound. TIP Setting HEXA-VCO pitch shifts to values such as PITCH+/-12 (up or down an octave), +/-7 (perfect fifth), or +/-5 (perfect fourth) produces a thicker sound like that from a synthesizer. You can add further depth to the sound by setting PITCH FINE to +/-5, thus slightly shifting the pitch of the HEXA-VCO.

Parameter/Range	Explanation
SWEEP	
This SWEEP function smoothly changes the amount of pitch shift when the amount of pitch shift is changed with PITCH SW.	
SW (Switch)	
OFF, ON	Turns the SWEEP function on/off. TIP PITCH SW is normally controlled after the settings for the operation of PITCH SW are made in Control Assign. * The SWEEP function is enabled when the amount of shift in the pitch of the HEXA-VCO is changed through the operation of PITCH SW. It is not activated in response to changes in the pitch of the input when the amount of pitch shift does not change. No effect is produced when the SWEEP SW in RISE and FALL is set to OFF.
RISE	
0–100	Adjusts the amount of time for the pitch to shift when the PITCH SW parameter is switched and the sound changes to a higher pitch. When set to zero, the pitch changes instantly; at higher values, the pitch rises more slowly.
FALL	
0–100	Adjusts the amount of time for the pitch to shift when the PITCH SW parameter is switched and the sound changes to a lower pitch. When set to zero, the pitch changes instantly; at higher values, the pitch falls more slowly.
VIBRATO	
You can apply an electronic vibrato effect to the HEXA-VCO.	
SW (Switch)	
OFF, ON	Turns the VIBRATO function on/off. TIP By setting VIBRATO SW as the function to be controlled in Control Assign and then switching the VIBRATO SW to ON as you are playing, you can apply stronger vibrato at whatever point in a performance you want. * You cannot apply vibrato to the HEXA-DISTORTION.
RATE	
0–100	This adjusts the rate of the vibrato. Raising the value increases the rate.
DEPTH	
0–100	This adjusts the depth of the vibrato. No vibrato is added when the value is set to 0. The vibrato deepens as the value is raised.

* With the GR-300 selected as the COSM guitar, expression of sounds may become unstable when the Alternate Tuning 12STR is set to ON or when pitches are shifted excessively.

BOWED/PIPE

Parameter/Range	Explanation
FILTER CUTOFF	
0-100	Adjusts the cutoff frequency, setting the brightness (hardness) of the sound. The sound gets brighter (harder) as the value is raised.
FILTER RESO (Filter Resonance)	
0-100	Adjusts the resonance (distinctiveness of the sound). As the value is increased, sounds in the frequency range near the cutoff frequency are boosted, making the sound more distinctive and unique.
TOUCH SENS (Touch Sensitivity)	
0-100	This sets the sensitivity when the filter is shifted according to the picking. The shifting of the filter caused by the picking increases as the value is raised. When the value is set to 0, the filter remains set, with no movement.
POWER BEND	
A higher setting results in a darker sound. At the same time, the tone and volume also change with respect to fluctuations in pitch produced by using a tremolo bar or other techniques.	
0-100	The higher the value, the more strained the sound becomes.
POWER BEND Q	
0-100	The higher the value, the more the sound will consist of mainly the harmonic components, thus creating a sound that exhibits almost no attack.
SUSTAIN	
0-100	Adjusts the range (time) over which low-level signals are boosted. Larger values will result in longer sustain.

DUAL

Parameter/Range	Explanation
FILTER CUTOFF	
0-100	Adjusts the cutoff frequency, setting the brightness (hardness) of the sound. The sound gets brighter (harder) as the value is raised.
FILTER RESO (Filter Resonance)	
0-100	Adjusts the resonance (distinctiveness of the sound). As the value is increased, sounds in the frequency range near the cutoff frequency are boosted, making the sound more distinctive and unique.
TOUCH SENS (Touch Sensitivity)	
0-100	This sets the sensitivity when the filter is shifted according to the picking. The shifting of the filter caused by the picking increases as the value is raised. When the value is set to 0, the filter remains set, with no movement.
GLIDE SENS (Glide Sensitivity)	
Picking dynamics can affect the amount of pitch change over time. This is known as the Glide effect. With softly played notes for which no attack can be detected, a glide effect may not be obtainable.	
0-100	This sets the sensitivity for the glide effect.
GLIDE TIME	
0-100	This sets the speed of the glide. Larger values result in longer glides. * <i>GLIDE TIME is no longer applied once GLIDE SENS decreases.</i>
SUSTAIN	
0-100	Adjusts the range (time) over which low-level signals are boosted. Larger values will result in longer sustain.

FILTER BASS

Parameter/Range	Explanation
FILTER CUTOFF	
0-100	Adjusts the cutoff frequency, setting the brightness (hardness) of the sound. The sound gets brighter (harder) as the value is raised.
FILTER RESO (Filter Resonance)	
0-100	Adjusts the resonance (distinctiveness of the sound). As the value is increased, sounds in the frequency range near the cutoff frequency are boosted, making the sound more distinctive and unique.
TOUCH SENS (Touch Sensitivity)	
0-100	This sets the sensitivity when the filter is shifted according to the picking. The shifting of the filter caused by the picking increases as the value is raised. When the value is set to 0, the filter remains set, with no movement.
FILTER DECAY	
0-100	This sets the speed at which the filter stops. The speed increases as the value of the setting is reduced. * <i>The decay effect cannot be obtained if the TOUCH SENS value is too low.</i>
COLOR	
0-100	Adjusts the strength of the low range. As the value is increased, the low range will become stronger.

SOLO

Parameter/Range	Explanation
FILTER CUTOFF	
0-100	Adjusts the cutoff frequency, setting the brightness (hardness) of the sound. The sound gets brighter (harder) as the value is raised.
FILTER RESO (Filter Resonance)	
0-100	Adjusts the resonance (distinctiveness of the sound). As the value is increased, sounds in the frequency range near the cutoff frequency are boosted, making the sound more distinctive and unique.
TOUCH SENS (Touch Sensitivity)	
0-100	This sets the sensitivity when the filter is shifted according to the picking. The shifting of the filter caused by the picking increases as the value is raised. When the value is set to 0, the filter remains set, with no movement.
COLOR	
0-100	Adjusts the amount of harmonics in the sound when the guitar strings are played with greater force. The harmonic components become more prominent as the value is raised. TIP To make adjustment easier, set FILTER CUTOFF to 100 and FILTER RESO and TOUCH SENS to 0, then gradually increase the FILTER RESO setting as you play the guitar.
SUSTAIN	
0-100	Adjusts the range (time) over which low-level signals are boosted. Larger values will result in longer sustain.

PWM

Parameter/Range	Explanation
FILTER CUTOFF	
0-100	Adjusts the cutoff frequency, setting the brightness (hardness) of the sound. The sound gets brighter (harder) as the value is raised.
FILTER RESO (Filter Resonance)	
0-100	Adjusts the resonance (distinctiveness of the sound). As the value is increased, sounds in the frequency range near the cutoff frequency are boosted, making the sound more distinctive and unique.
TOUCH SENS (Touch Sensitivity)	
0-100	This sets the sensitivity when the filter is shifted according to the picking. The shifting of the filter caused by the picking increases as the value is raised. When the value is set to 0, the filter remains set, with no movement.
PWM DEPTH	
0-100	This sets the depth to which the waveform's pulse width is varied. Higher values result in deeper undulations.
PWM RATE	
0-100	This sets the speed at which the filter stops. The speed increases as the value of the setting is reduced.
SUSTAIN	
0-100	Adjusts the range (time) over which low-level signals are boosted. Larger values will result in longer sustain.

CRYSTL

Parameter/Range	Explanation
ATTACK LENGTH	
0-100	This sets the decay time for the attack portion of the sound. A smaller setting results in a shorter attack.
MOD TUNE (Modulation Tune)	
0-100	This sets the tuning for the modulation applied to the attack.
MOD DEPTH (Modulation Depth)	
0-100	This sets the depth of the modulation applied to the attack. Larger values result in deeper undulations.
ATTACK LEVEL	
0-100	This sets the volume level of the attack portion.
BODY LEVEL	
0-100	This sets the volume level for the sustained portion of the sound.
SUSTAIN	
0-100	Adjusts the range (time) over which low-level signals are boosted. Larger values will result in longer sustain.

ORGAN

Parameter/Range	Explanation
FEET 16'	
0-100	This is a Long Tone one octave lower than the guitar.
FEET 8'	
0-100	This is a Long Tone at the same pitch as the guitar.
FEET 4'	
0-100	This is a Long Tone one octave higher than the guitar.
SUSTAIN	
0-100	Adjusts the range (time) over which low-level signals are boosted. Larger values will result in longer sustain.

BRASS

Parameter/Range	Explanation
FILTER CUTOFF	
0-100	Adjusts the cutoff frequency, setting the brightness (hardness) of the sound. The sound gets brighter (harder) as the value is raised.
FILTER RESO (Filter Resonance)	
0-100	Adjusts the resonance (distinctiveness of the sound). As the value is increased, sounds in the frequency range near the cutoff frequency are boosted, making the sound more distinctive and unique.
TOUCH SENS (Touch Sensitivity)	
0-100	This sets the sensitivity when the filter is shifted according to the picking. The shifting of the filter caused by the picking increases as the value is raised. When the value is set to 0, the filter remains set, with no movement.
SUSTAIN	
0-100	Adjusts the range (time) over which low-level signals are boosted. Larger values will result in longer sustain.

WAVE

Parameter/Range	Explanation
WAVE SHAPE	
Selects the wave type on which the synth sound is based.	
SAW	Creates a synth sound with a sawtooth waveform.
SQUARE	Creates a synth sound with a square waveform.
WAVE SENS (Wave Sensitivity)	
0–100	This controls the input sensitivity of the wave synth.
WAVE ATTACK	
0–100	Adjusts the time it takes for the synth sound to rise after a string is plucked. When it is set to a lower value, the sound will rise quickly. When it is set higher, the sound will rise slowly.
WAVE DECAY	
0–100	Adjusts the time it takes for the synth sound to decay. The synth sound decays more quickly when this parameter is set to a lower value. Setting a higher value increases the decay time.
WAVE LEVEL	
0–100	Adjusts the volume of the synth sound.
CUTOFF	
0–100	Adjusts the cutoff frequency at which the filter cuts off the sound's harmonic components. This parameter determines the sound that will result after the filter has stopped varying due to FILTER DEPTH.
RESO (Resonance)	
0–100	Adjusts the resonance (distinctiveness of the sound). As the value is increased, sounds in the frequency range near the cutoff frequency are boosted, making the sound more distinctive and unique.
FILTER TYPE	
-12 dB, -24 dB	Selects the curve of attenuation in the filter. The -24 dB setting has very steep filtering characteristics.
FILTER ATTACK	
0–100	Sets the filter attack time.
FILTER DECAY	
0–100	Sets the filter decay time.
FILTER DEPTH	
-50–+50	Adjusts the depth of the filter's change. When set to a positive value, the VCF cutoff frequency shifts from a high value to a low value. When set to a negative value, the VCF cutoff frequency shifts from a low value to a high value.

SYNTH Common Parameters

Besides the other COSM SYNTH parameters, the VG-99 also includes the following shared parameters.

Parameter/Range	Explanation
EQ (Equalizer)	
A four-band equalizer with high and low ranges is provided. The sound processed by the effect can be boosted by frequency range before it is output.	
EQ SW (Equalizer Switch)	
OFF, ON	Turns the EQ effect on/off.
TOTAL GAIN	
-12–+12dB	Adjusts the volume before the equalizer.
LOW GAIN	
-12–+12dB	Adjusts the low frequency range tone.
HIGH GAIN	
-12–+12dB	Adjusts the high frequency range tone.
LOW MID FREQ (Low Middle Frequency)	
20Hz–10.0kHz	Specifies the center of the frequency range that will be adjusted by the LOW MID GAIN.
LOW MID Q (Low Middle Q)	
0.5–16	Adjusts the width of the area affected by the EQ centered at the LOW MID FREQ. Higher values will narrow the area.
LOW MID GAIN (Low Middle Gain)	
-12–+12dB	Adjusts the low-middle frequency range tone.
HIGH MID FREQ (High Middle Frequency)	
20Hz–10.0kHz	Specifies the center of the frequency range that will be adjusted by the HIGH MID GAIN.
HIGH MID Q (High Middle Q)	
0.5–16	Adjusts the width of the area affected by the EQ centered at the HIGH MID FREQ. Higher values will narrow the area.
HIGH MID GAIN (High Middle Gain)	
-12–+12dB	Adjusts the high-middle frequency range tone.

Parameter/Range	Explanation
STRING PAN 1st–6th	
100:0–0:100	This sets the left/right pan of each string. * The pan effect is cancelled if a monaural effect or COSM amp is connected after the COSM GUITAR effect.
STRING LEVEL 1st–6th	
0–100	Specifies the output level of each string.

Parameter/Range	Explanation
MIX LEVEL	
COSM GUITAR	
0–100	Specifies the level of the COSM GUITAR.
NORMAL PU (Normal Pickup)	
0–100	Adjusts the volume of the normal pickup.

ALTERNATE TUNING

With the Alternate Tuning function, you can convert the pitch of each individual string of a COSM guitar, without changing the guitar's actual tuning.

Alternate Tuning includes the five following functions.

- TUNING
- BEND
- 12-STRING
- DETUNE
- HARMONY

You can use all of these functions simultaneously, in any combination.

TUNING

This shifts the tuning of each string in semitone increments. With the guitar left with the standard tuning (EADGBE), you can convert the tuning to an open tuning such as OPEN-D or OPEN-G, raise or lower all of the strings an octave, and achieve various other tunings, all without changing the guitar's actual tuning. When the type set in TUNING is something other than a preset tuning, you can also create your own tunings as you like for each individual patch with the USER tunings. Using the TUNING function allows you to change tunings instantly during songs, without having to change instruments, and perform using tunings that are easier to play in, without changing the string tension.

BEND

You can produce a pitch bend effect on any individual string or combination of strings. This feature lets you make separate settings for the amount of bend for each individual string, just as with a string bender or pedal steel guitar. This is mainly used with Control Assign.

12-STRING

This changes the sound of a regular six-string guitar to that of a twelve-string guitar featuring secondary strings. For each individual string, you can set the shift in pitch for the secondary string relative to the respective main string, the amount of delay, and the volume.

DETUNE

This allows you to subtly shift the pitch of each individual string. When playing sounds from both COSM GUITAR [A] and [B], switching DETUNE to ON in one of the channels to slightly alter the pitch produces an effect resembling double tracking, creating a sound with greater breadth and depth.

HARMONY

This analyzes the pitch of each string and adjusts the amount of shift in the pitch to convert the pitches into harmonies matched to the key. You can create and use the harmonies you like in each individual patch with the USER TYPE function.

* With the GR-300 selected as the COSM guitar, expression of sounds may become unstable when the Alternate Tuning 12STR is set to ON or when pitches are shifted excessively.

Parameter/Range	Explanation
AB LINK	
OFF, ON	This setting switches the AB LINK on and off. When AB LINK is on, you can use the same settings for the functions below on both COSM GUITAR [A] and COSM GUITAR [B]. <ul style="list-style-type: none"> • TUNING • BEND When set to OFF, you can use set COSM GUITAR [A] differently than COSM GUITAR [B]. <div style="border: 1px solid black; border-radius: 10px; padding: 2px; display: inline-block; margin-top: 5px;">TIP</div> Unless you particularly want to change the TUNING or BEND settings for COSM GUITAR [A] and COSM GUITAR [B], leaving AB LINK set to ON is normally more convenient.
A/B	
A, B	This selects the channel used in setting Alternate Tuning. <p>* You cannot set this when AB LINK is on.</p>
TUNING	
SW	
OFF, ON	This setting switches TUNING function on and off.
TYPE	
You can create and use your own original harmonies in each individual patch with the USER TYPE function.	
OPEN-D	This tuning produces a D chord when the strings are played open.
OPEN-E	This tuning produces an E chord when the strings are played open.
OPEN-G	This tuning produces a G chord when the strings are played open.
OPEN-A	This tuning produces an A chord when the strings are played open.
DROP-D	This tuning drops the note only on the 6th string (D).
D-MODAL	Also referred to as DADGAD, this tuning drops the 6th, 2nd, and 1st strings one note, lending the sounds an exotic air.
-1 STEP	This tuning lowers the strings one semitone (half-step). All strings are lowered a semitone (corresponding to one fret).
-2 STEP	This tuning lowers the strings one whole step. All strings are lowered a whole step (corresponding to two frets).
BARITONE	This tuning lowers all strings a perfect fourth (five frets), making it well suited for heavy phrasing.
NASHVL	With this tuning, the 6th, 5th, 4th, and 3rd strings are raised an octave, just like having only the secondary string for these string pairs on a twelve-string guitar.

Parameter/Range	Explanation
-1 OCT	This tuning lowers all the strings one octave.
-2 OCT	This tuning raises all the strings one octave.
USER	This assigns the tuning set in USER TUNING.
USER TUNING 1st-6th	
-24+24	This sets the amount of shift for each individual string.
BEND	
SW	
OFF, ON	This setting switches BEND function on and off.
BEND TUNING 1st-6th	
-24+24	This sets the amount of pitch shift in each string when the bend is set to 100. The amount of shift from the current pitch is set in semitone increments.
BEND	
0-100	When set to 0, bending causes no shift in the pitch; when set to 100, the strings' pitches are shifted by the amount set in 1st-6th. Normally, this pitch bend is set to 0, and the setting 0-100 assigned with Control Assign is used. <i>* This setting cannot be saved to patches. This is reset to 0 when patches are switched.</i>
12STR (12-String)	
SW	
OFF, ON	This setting switches 12STR function on and off.
SHIFT 1st-6th	
-24+24	This sets the amount the pitch that each secondary string is shifted relative to the respective main string in semitone increments.
FINE 1st-6th	
-50+50	This sets the amount the pitch that each secondary string is shifted relative to the respective main string in one cent (1/100 of a semitone) increments.
LEVEL 1st-6th	
0-100	Adjusts the volume level for each secondary string.
DELAY 1st-6th	
0-100ms	Adjusts the time the sound of each secondary string is delayed relative to the respective main string.
<p>TIP</p> <p>With conventional twelve-string guitars, the 1st and 2nd secondary strings are tuned to the same pitch as the main strings, while the 3rd through 6th are tuned one octave higher. Slightly raising the FINE settings and adding a little delay produces a more realistic twelve-string sound.</p>	

Parameter/Range	Explanation
DETUNE	
SW	
OFF, ON	This setting switches DETUNE function on and off.
1st-6th	
-50+50	This sets the shift in pitch in one cent (1/100 of a half-step) units.
<p>TIP</p> <p>When playing both COSM GUITAR [A] and COSM GUITAR [B], slightly detuning produces an effect resembling double tracking (a recording technique whereby the same phrase is recorded twice on separate tracks), creating a sound with greater breadth and depth. Using PAN in the MIXER section to pan A to the left and B to the right further emphasizes the effect.</p>	
HARMO (Harmony)	
SW	
OFF, ON	This setting switches HARMO function on and off.
KEY	
C Am-B G#m	Specify the key of the song you are playing.
<p>TIP</p> <p>This KEY parameter is the same as the Key setting in the [NAME/KEY/BPM] section (p. 163) and FX MOD1, 2 HARMONIST. Altering either one changes the key.</p>	
HARMO (Harmony)	
-2oct-TONIC+2oct, USER	This sets the pitch for the harmony interval relative to the input sound. When this is set to USER, you can set this to the desired harmony in USER INTERVAL.
USER INTERVAL C-B	
-24+24	This sets the output pitch relative to the input pitch for the selected key.

Creating Harmony Scales (User Scale)

When HARMO is set to any value from -2oct to +2oct, and the harmony does not sound the way you intend, use a User scale. You can set the corresponding pitches to be output for each input pitch.

1. Set HARMO to USER in the Harmony screen.
2. Press PAGE [▶] to display Page 2. The User Interval screen appears.

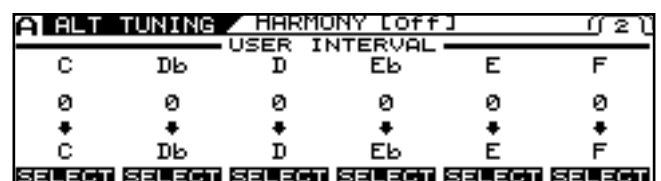

3. Use PAGE [◀] [▶], [F1]-[F6], and the F1-F6 knob to set the amount of pitch shift for each voice.

POLY FX (Poly Effect)

Parameter/ Range	Explanation
POLYFX SW (Poly Effect Switch)	
OFF, ON	Turns the poly effect on/off.
TYPE	
POLY COMP POLY DIST POLY OCTAVE POLY SG	Select the poly effect type. * <i>The parameters that can be set differ with each type. Refer to each of the parameters cited later.</i>
POLYFX CH (Poly Effect Channel)	
A, B	This selects the channel to which the POLY FX are applied.

POLY COMP (Poly Compressor)

The compressor is an effect that attenuates loud input levels and boosts soft input levels, thus evening out the volume to create sustain without distortion.

Parameter/ Range	Explanation
COMP TYPE	
Select the compressor type.	
COMP	The effect will function as a compressor.
LIMITR	The effect will function as a limiter.
SUSTAIN (COMP TYPE = COMP)	
0–100	Adjusts the range (time) over which low-level signals are boosted. Larger values will result in longer sustain.
ATTACK (COMP TYPE = COMP)	
0–100	Adjusts the strength of the picking attack. Larger values will result in a sharper attack, creating a more clearly defined sound.
THRSH (COMP TYPE = LIMITR)	
0–100	Adjusts the level to match the signals input from the guitar. Signal levels are suppressed when the signals input are in excess of the set level.
REL (COMP TYPE = LIMITR)	
0–100	Adjusts the amount of time from the point at which the signals fall below the threshold level to when the effect is no longer applied.
TONE	
-50+50	Adjusts the tone.
LEVEL	
0–100	Adjusts the volume.
COMP BAL (Compression Balance)	
0–100	Adjusts the balance of the input levels for the 2nd–6th strings based on the 1st string's input level. When this is set to 100, all of the strings are input at the same level. The level of the 2nd through 6th strings decreases as the value is lowered.

POLY DIST (Poly Distortion)

You can individually distort the sound of each string to get a sound that can be played chordally without breaking up.

Parameter/ Range	Explanation
MODE	
Selects the type of distortion.	
CLA OD	A classical overdrive sound is obtained.
TURBO OD	Allows you to obtain a rich effect just like distortion, without losing the subtle nuance of the overdrive.
DS1	Allows you to obtain a standard distortion sound.
DS2	Allows you to obtain a distortion sound with a rich middle.
FUZZ	This produces a basic fuzz sound.
DRIVE	
0–100	This sets the degree of sound distortion.
HIGH-CUT	
700Hz–11.0kHz, FLAT	Adjusts the tone of the distorted sound.
POLY BAL (Poly Balance)	
0–100	Adjusts the degree of distortion for chordal playing.
DRIVE BAL (Drive Balance)	
0–100	Adjusts the degree of distortion between low and high strings, to even out the volume balance.
LEVEL	
0–100	Adjusts the output level that is raised by being distorted.

POLY OCTAVE (Poly Octave)

This supports playing technique related to octaves.

* When 12STR (p. 116) in ALTERNATE TUNING is switched on, noise may occur in the octave sound.

Parameter/ Range	Explanation
-1 OCTAVE LEVEL 1st-6th	
0-100	This adds sound one octave lower than the original sound.
+1 OCTAVE LEVEL 1st-6th	
0-100	This adds sound two octaves lower than the original sound.
DIRECT LEVEL 1st-6th	
0-100	Adjusts the level of the original sound.

POLY SG (Poly Slow Gear)

This produces a volume-swell effect ("violin-like" sound).

Parameter/ Range	Explanation
RISE TIME	
0-100	Adjusts the time needed for the volume to reach its maximum from the moment you begin picking.
SENS (Sensitivity)	
0-100	Adjusts the sensitivity.

FX (Effects)

COMP (Compressor)

This is an effect that produces a long sustain by evening out the volume level of the input signal. You can switch it to a limiter to suppress only the sound peaks and prevent distortion.

Parameter/Range	Explanation
COMP SW	
OFF, ON	Turns the COMP effect on/off.
TYPE	
Select the compressor type.	
COMP	The effect will function as a compressor.
LIMITR	The effect will function as a limiter.
SUSTAIN (TYPE = COMP)	
0-100	Adjusts the range (time) over which low-level signals are boosted. Larger values will result in longer sustain.
ATTACK (TYPE = COMP)	
0-100	Adjusts the strength of the picking attack when the strings are played. Higher values result in a sharper attack, creating a more clearly defined sound.
THRSH (TYPE = LIMITER)	
0-100	Adjust this as appropriate for the input signal from your guitar. When the input signal level exceeds this threshold level, limiting will be applied.
REL (TYPE = LIMITER)	
0-100	Adjusts the time from when the signal level drops below the threshold until when limiting is removed.
TONE	
-50-+50	Adjusts the tone.
LEVEL	
0-100	Adjusts the volume.

OD/DS (Overdrive/Distortion)

This effect distorts the sound to create long sustain. It provides 30 types of distortion and custom settings.

Parameter/Range	Explanation
OD/DS SW	
OFF, ON	Turns the OD/DS effect on/off.
TYPE	
Selects the type of distortion.	
BOOST	This is a booster that works very well with COSM amps.
BLUES OD	This is a crunch sound of the BOSS BD-2.
CRUNCH	A lustrous crunch sound with an added element of amp distortion.
NATURAL OD	This is an overdrive sound that provides distortion with a natural feeling.
TURBO OD	This is the high-gain overdrive sound of the BOSS OD-2.
FAT OD	This is a mellow overdrive sound.
OD-1	This is the sound of the BOSS OD-1.
T SCREAM	This models an Ibanez TS-808.
WARM OD	Overdrive with special mid range tone.
DIST	This gives a basic, traditional distortion sound.
MILD DS	This is a distortion sound that provides a mild distortion.
DRIVE DS	This is a powerful distortion sound.
RAT	This models a Proco RAT.
GUV DS	This models an Marshall GUV' NOR.
DST+	This models an MXR DISTORTION+.
SOLID DS	This is a distortion sound featuring an edge effect.
MID DS	This distortion sound features a boosted midrange.
STACK	A fat sound with an added element of a stack amp's distortion.
MODERN DS	Sound of a large high gain amp.
POWER DS	Sound of Overdrive through a stack amp.
R-MAN	This models a ROCKMAN.
METAL ZONE	This is the sound of the BOSS MT-2.
HEAVY METAL	This creates a heavier distortion sound.
LEAD	Produces a distortion sound with both the smoothness of an overdrive along with a deep distortion.
LOUD	This is a distortion sound with a boosted low end.
SHARP	This is a distortion sound with a boosted high end.
MECHANICAL	This distortion sound boosts the low and high ends, yielding a mechanical-sounding distortion.
'60S FUZZ	This models a FUZZFACE.

Parameter/ Range	Explanation
OCT FUZZ	This models an ACETONE FUZZ.
MUFF FUZZ	This models an Electro-Harmonix Big Muff π .
CUSTOM	Custom OD/DS
DRIVE	
0–120	Adjusts the depth of distortion.
BOTTOM	
-50–+50	Adjusts the tone for the low frequency range. Turning this to the left (counterclockwise) produces a sound with the low end cut; turning it to the right boosts the low end in the sound.
STONE	
-50–+50	Adjusts the tone.
EFFECT LEVEL	
0–100	Adjusts the volume of the overdrive/distortion sound.
DIRECT LEVEL	
0–100	Adjusts the volume of the direct sound.

Parameter/ Range	Explanation
CUSTOM *1	
TYPE	
This selects the basic sound when the TYPE parameter is set to CUSTOM.	
OD-1	This is the sound of the BOSS OD-1.
OD-2	OD-2 This is a overdrive sound with high gain.
CRUNCH	This is a crunch sound.
DS-1	This gives a basic, traditional distortion sound.
DS-2	This creates a heavier distortion sound.
METAL1	This is a metal sound with a characteristic midrange.
METAL2	This gives a heavy metal sound.
FUZZ	This gives a basic, traditional fuzz sound.
BOTTOM	
-50–+50	This controls the input sound's low-frequency range and adjusts the amount of distortion in the low-frequency range.
TOP	
-50–+50	This controls the input sound's low-frequency range and adjusts the amount of distortion in the high-frequency range.
LOW	
-50–+50	Adjusts the low-range tones after distortion is applied.
HIGH	
-50–+50	Adjusts the high-range tones after distortion is applied.

*1 Setting available when TYPE is set to CUSTOM.

WAH

You can control the wah effect in real time by adjusting the EXP pedal connected to the EXP PEDAL jack or FC-300 EXP pedal.

Parameter/Range	Explanation
WAH SW	
OFF, ON	Turns the WAH effect on/off.
TYPE	
Selects the type of wah.	
CRY WAH	This models the sound of the CRY BABY wah pedal popular in the '70s.
VO WAH	This models the sound of the VOX V846.
FAT WAH	This a wah sound featuring a bold tone.
LIGHT WAH	This wah has a refined sound with no unusual characteristics.
7STR WAH	This expanded wah features a variable range compatible with seven-string and baritone guitars.
RESO WAH	This completely original effect offers enhancements on the characteristic resonances produced by analog synth filters.
CUSTOM	Custom wah
PEDAL POS (Pedal Position)	
0-100	Adjusts the position of the wah pedal. * <i>This expanded wah features a variable range compatible with seven-string and baritone guitars.</i>
LEVEL	
0-100	Adjusts the volume.

Parameter/Range	Explanation
CUSTOM *1	
TYPE	
This selects the basic sound when the TYPE parameter is set to CUSTOM.	
CRY WAH	This models the sound of the CRY BABY wah pedal popular in the '70s.
VO WAH	This models the sound of the VOX V846.
FAT WAH	This a wah sound featuring a bold tone.
LIGHT WAH	This wah has a refined smooth sound.
7STR WAH	Wah featuring a broader range of variations for the seven-string guitar.
Q	
-50-+50	Adjusts the amount of characteristic effect applied to the wah tone.
RANGE LOW	
-50-+50	Selects the tone produced when the pedal is back.
RANGE HIGH	
-50-+50	Selects the tone produced when the pedal is forward.
PRESENCE	
-50-+50	Adjusts the tonal quality of the wah effect.

*1 Setting available when TYPE is set to CUSTOM.

EQ (Equalizer)

This adjusts the tone as a sub equalizer. A parametric type is adopted for the high-middle and low-middle range.

Parameter/Range	Explanation
EQ SW (Equalizer Switch)	
OFF, ON	Turns the EQ effect on/off.
TOTAL GAIN	
-20~+20dB	Adjusts the overall volume level of the equalizer.
LOW GAIN	
-20~+20dB	Adjusts the low frequency range tone.
HIGH GAIN	
-20~+20dB	Adjusts the high frequency range tone.
LOW MID FREQ (Low Middle Frequency)	
20Hz~10.0kHz	Specifies the center of the frequency range that will be adjusted by the LOW MID GAIN.
LOW MID Q (Low Middle Q)	
0.5~16	Adjusts the width of the area affected by the EQ centered at the LOW MID FREQ. Higher values will narrow the area.
LOW MID GAIN (Low Middle Gain)	
-20~+20dB	Adjusts the low-middle frequency range tone.
HIGH MID FREQ (High Middle Frequency)	
20Hz~10.0kHz	Specifies the center of the frequency range that will be adjusted by the HIGH MID GAIN.
HIGH MID Q (High Middle Q)	
0.5~16	Adjusts the width of the area affected by the EQ centered at the HIGH MID FREQ. Higher values will narrow the area.
HIGH MID GAIN (High Middle Gain)	
-20~+20dB	Adjusts the high-middle frequency range tone.
LOW CUT (Low Cut Filter)	
FLAT, 55 Hz~800 Hz	This lets you cut the low-end component below the set frequency to create a clear, distinct low end, thereby bringing out the high end of the effect. When FLAT is selected, the low cut filter will have no effect.
HIGH CUT (High Cut Filter)	
700 Hz~11kHz, FLAT	This allows you to get a mild effect sound by cutting the high-end component above the set frequency. When it is set to FLAT, the high cut filter is off or has no effect.

DELAY

This effect adds delayed sound to the direct sound, giving more body to the sound or for creating special effects.

Parameter/Range	Explanation
DELAY SW	
OFF, ON	Turns the DELAY effect on/off.
DELAY TYPE	
Selects the type of delay.	
SINGLE	This is a simple monaural delay.
PAN	This delay is specifically for stereo output. This allows you to obtain the tap delay effect that divides the delay time, then deliver them to L and R channels. <div style="text-align: center;"> </div>
STEREO	The direct sound is output from the left channel, and the effect sound is output from the right channel.
DUAL-S (Dual Series)	This is a delay comprising two different delays connected in series. Each delay time can be set in a range from 1 ms to 900 ms. <div style="text-align: center;"> </div>
DUAL-P (Dual Parallel)	This is a delay comprising two delays connected in parallel. Each delay time can be set in a range from 1 ms to 900 ms. <div style="text-align: center;"> </div>
DUAL-L/R	This is a delay with individual settings available for the left and right channels. Delay 1 goes to the left channel, Delay 2 to the right. <div style="text-align: center;"> </div>
REVRSE	This produces an effect where the sound is played back in reverse.
ANALOG	This gives a mild analog delay sound. The delay time can be set within the range of 1 to 1800 ms
TAPE	This setting provides the characteristic wavering sound of the tape echo. The delay time can be set within the range of 1 to 1800 ms.
WARP	This simultaneously controls the delay sound's feedback level and volume to produce a totally unreal delay. <div style="text-align: center;"> </div>

Parameter/Range	Explanation
MOD (Modulate)	This delay adds a pleasant wavering effect to the sound.
HOLD	Up to 2.8 seconds of performance content is recorded, then played back repeatedly. You can also layer this as you perform something else, then record these together (over-dub), allowing you to produce what is called sound-on-sound or looping.
<p>* For more detail the operation, refer to “Using the HOLD (Hold Delay)” (p. 125).</p> <p>* If you switch patches with the TYPE set to either DUAL-S, DUAL-P, or DUAL L/R and then begin to play immediately after the patches change, you may be unable to attain the intended effect in the first portion of what you perform.</p> <p>* The stereo effect is cancelled if a monaural effect or COSM amp is connected after a stereo delay effect.</p>	

DELAY Common Parameters

Parameter/Range	Explanation
DELAY TIME	
1 ms–1800 ms, BPM ♪ –BPM ◉	This determines the delay time.
<p>When set to BPM, the value of each parameter will be set according to the value of the BPM (p. 163) specified for each patch. This makes it easier to achieve effect sound settings that match the tempo of the song.</p> <p>* If, due to the tempo, the time is longer than the range of allowable settings, it is then synchronized to a period either 1/2 or 1/4 of that time.</p> <p>* When TYPE is set to DUAL-S, DUAL-P, or DUAL-L/R, the delay time can be set to any value from 1 to 900 ms.</p> <p>* After setting DELAY TIME to BPM (♪ – ◉), if you tap [F1] (TAP), the BPM value will change to match the timing of your tapping.</p>	
FEEDBACK	
0–100	<p>This sets the amount of delay sound returned to the input. A higher value will increase the number of the delay repeats.</p> <p>TERM</p> <p>Feedback is returning a delay signal to the input.</p>
HIGH CUT (High Cut Filter)	
700 Hz–11 kHz, FLAT	This allows you to get a mild effect sound by cutting the high-end component above the set frequency. When it is set to FLAT, the high cut filter is off or has no effect.
EFFECT LEVEL	
0–120	Adjusts the volume of the delay sound.
DIRECT LEVEL	
0–100	Adjusts the volume of the direct sound.

PAN

Parameter/Range	Explanation
TAP TIME TYPE=PAN *1	
0%–100%	Adjusts the delay time of the left channel delay. This setting adjusts the L channel delay time relative to the R channel delay time (considered as 100%).

DUAL-S, DUAL-P, DUAL-L/R

Parameter/Range	Explanation
DELAY1 TIME	
1 ms–900 ms, BPM ♪ –BPM ◉	This determines the delay time.
<p>When set to BPM, the value of each parameter will be set according to the value of the BPM (p. 163) specified for each patch. This makes it easier to achieve effect sound settings that match the tempo of the song.</p> <p>* If, due to the tempo, the time is longer than the range of allowable settings, it is then synchronized to a period either 1/2 or 1/4 of that time.</p> <p>* After setting DELAY TIME to BPM (♪ – ◉), if you tap [F1] (TAP), the BPM value will change to match the timing of your tapping.</p>	
DELAY1 FEEDBACK	
0–100	Adjusts the amount of feedback of the Delay1. A higher value will increase the number of the delay repeats.
DELAY HI-CUT (Delay 1 High Cut Filter)	
700 Hz–11 kHz, FLAT	This sets the frequency at which the high cut filter of the Delay1 begins to take effect. When it is set to FLAT, the high cut filter is off or has no effect.
DELAY1 LEVEL	
0–120	Adjusts the volume of the Delay1.
DELAY2 TIME	
1 ms–900 ms, BPM ♪ –BPM ◉	This determines the delay time of the Delay2.
DELAY2 FEEDBACK	
0–100	Adjusts the amount of feedback of the Delay2.
DELAY2 FEEDBACK (Delay 2 High Cut Filter)	
700 Hz–11 kHz, FLAT	This sets the frequency at which the high cut filter of the Delay2 begins to take effect. When it is set to FLAT, the high cut filter is off or has no effect.
DELAY2 LEVEL	
0–120	Adjusts the volume of the Delay2.

WARP

Parameter/Range	Explanation
WARP SW	
OFF, ON	Turns the WARP effect on/off. MEMO This parameter is assigned to the footswitch (CTL 1/2, CTL 3/4) and/or FC-300's CTL pedal.
RISE TIME	
0-100	Adjusts how rapidly the warped delay sound rises.
FEEDBACK DEPTH	
0-100	Adjusts the feedback level of the warped delay sound.
LEVEL DEPTH	
0-100	Adjusts the volume of the warped delay sound.

MOD

Parameter/Range	Explanation
MOD RATE (Modulation Rate)	
0-100	Adjusts the modulation rate of the delay sound.
MOD DEPTH (Modulation Depth)	
0-100	Adjusts the modulation depth of the delay sound.

Using the HOLD (Hold Delay)

* Recording and playback of performances and other operations are carried out with pedals while Hold is in effect. Connect external pedals (footswitches) or an FC-300.

1. Referring to "Using the Switches, Pedals, and MIDI to Control the Sounds (CONTROL ASSIGN)" (p. 82), assign the following functions to the connected external pedals (footswitches) or FC-300 CTL pedals.

Controller	TARGET PARAMETER	SW MODE
CTL3, etc	[A] FX (or [B] FX) DELAY (HOLD) REC	LATCH
CTL4, etc	[A] FX (or [B] FX) DELAY (HOLD) STOP	---

2. Set TYPE to HOLD in the Delay screen.
3. Press the pedal to which REC is assigned.
Recording starts when you press the pedal.
4. Press the pedal to which REC is assigned again to stop recording.

* The maximum recording time is 2.8 seconds. If the recording time exceeds 2.8 seconds, the recording stops automatically, and the recorded content is then played back.

* An oscillating sound may be audible with extremely short recording times.
5. When layering recordings, repeat Steps 4 and 5.



* The recorded content is cleared when the TYPE or patch is switched to a different setting or when the power is turned off.
6. To return to recording standby, press the pedal to which STOP is assigned.
The unit returns to recording standby.

* When playback is stopped, the recorded content is erased.

* You can also set REC SW MODE to MOMENT.
If you use this setting, be sure to keep the pedal held down during recording.

CHORUS

In this effect, a slightly detuned sound is added to the original sound to add depth and breadth.

Parameter/Range	Explanation
CHORUS SW	
OFF, ON	Turns the CHORUS effect on/off.
CHORUS MODE	
Selection for the chorus mode.	
MONO	This chorus effect outputs the same sound from both L channel and R channel.
ST1 (Stereo1)	This is a stereo chorus effect that adds different chorus sounds to L channel and R channel.
ST2 (Stereo2)	This stereo chorus uses spatial synthesis, with the direct sound output in the L channel and the effect sound output in the R channel.
RATE	
0–100, BPM  –BPM 	Adjusts the rate of the chorus effect.
When set to BPM, the value of each parameter will be set according to the value of the BPM (p. 163) specified for each patch. This makes it easier to achieve effect sound settings that match the tempo of the song.	
* If, due to the tempo, the time is longer than the range of allowable settings, it is then synchronized to a period either 1/2 or 1/4 of that time.	
DEPTH	
0–100	Adjusts the depth of the chorus effect.
 <p>To use it for doubling effect, set the value to 0.</p>	
PRE DELAY	
0.0 ms–40.0 ms	Adjusts the time needed for the effect sound to be output after the direct sound has been output. By setting a longer pre delay time, you can obtain an effect that sounds like more than one sound is being played at the same time (doubling effect).
LOW CUT (Low Cut Filter)	
FLAT, 55 Hz–800 Hz	This lets you cut the low-end component below the set frequency to create a clear, distinct low end, thereby bringing out the high end of the effect. When FLAT is selected, the low cut filter will have no effect.
HIGH CUT (High Cut Filter)	
700 Hz–11 kHz, FLAT	This allows you to get a mild effect sound by cutting the high-end component above the set frequency. When FLAT is selected, the high cut filter will have no effect.
EFFECT LEVEL	
0–100	Adjusts the volume of the effect sound.

REVERB

This effect adds reverberation to the sound.

Parameter/Range	Explanation
REVERB SW	
OFF, ON	Turns the REVERB effect on/off.
TYPE	
This selects the reverb type. Various different simulations of space are offered.	
AMB (Ambience)	Simulates an ambience mic (off-mic, placed at a distance from the sound source) used in recording and other applications. Rather than emphasizing the reverberation, this reverb is used to produce a sense of openness and depth.
ROOM	Simulates the reverberation in a small room. Provides warm reverberations.
HALL1	Simulates the reverberation in a concert hall. Provides clear and spacious reverberations.
HALL2	Simulates the reverberation in a concert hall. Provides warm reverberations.
PLATE	Simulates plate reverberation (a reverb unit that uses the vibration of a metallic plate). Provides a metallic sound with a distinct upper range.
SPRING	This simulates the sound of a guitar amp's built-in spring reverb.
MOD (Modulate)	This reverb adds the wavering sound found in hall reverb to provide an extremely pleasant reverb sound.
REVERB TIME	
0.1 s–10.0 s	Adjusts the length (time) of reverberation.
PRE DELAY	
0 ms–100 ms	Adjusts the time until the reverb sound appears.
LOW CUT (Low Cut Filter)	
FLAT, 55 Hz–800 Hz	This lets you cut the low-end component below the set frequency to create a clear, distinct low end, thereby bringing out the high end of the effect. When FLAT is selected, the low cut filter will have no effect.
High Cut (High Cut Filter)	
700 Hz–11 kHz, FLAT	This allows you to get a mild effect sound by cutting the high-end component above the set frequency. When FLAT is selected, the high cut filter will have no effect.
DENSTY (Density)	
0–10	Adjusts the density of the reverb sound.
EFFECT LEVEL	
0–100	Adjusts the volume of the reverb sound.
DIRECT LEVEL	
0–100	Adjusts the volume of the direct sound.

MOD1, MOD2

With MOD1 and MOD2, you can select the effect to be used from the following.

You can select the same effect for FX-1 and FX-2.

MOD TYPE			
MOD1 MOD2 Common	PHASER	Phaser	(p. 127)
	FLANGR	Flanger	(p. 128)
	TREML	Tremolo	(p. 128)
	PAN	Pan	(p. 128)
	T.WAH	Touch Wah	(p. 129)
	AUTO WAH	Auto Wah	(p. 129)
	OCTAVE	Octave	(p. 129)
	PITCH SHIFT	Pitch Shifter	(p. 130)
	HARMONIST	Harmonist	(p. 130)
	PEDAL BEND	Pedal Bend	(p. 132)
	2x2 CHORUS	2x2 Chorus	(p. 132)
	ROTARY	Rotary	(p. 133)
	UNI-V	Uni-V	(p. 133)
	VIB	Vibrato	(p. 133)
	SLICER	Slicer	(p. 134)
	HUMANIZER	Humanizer	(p. 134)
	SLOW GEAR	Slow Gear	(p. 135)
	DEFRET	Defretter	(p. 135)
	FEEDBACKER	Feedbacker	(p. 135)
	RING MOD	Ring Modulator	(p. 136)
ANTI FB	Anti Feedback	(p. 136)	
ADV.COMP	Advanced Compressor	(p. 136)	
LIMITR	Limiter	(p. 137)	
SUB EQ	Sub Equalizer	(p. 137)	
SUB DELAY	Sub Delay	(p. 138)	

Parameter/Range	Explanation
MOD1 SW, MOD2 SW (MODE Switch)	
OFF, ON	Turns the MOD-1 (MOD-2) effect on/off.
MOD 1 TYPE, MOD 2 TYPE (MODE Type)	
see above	Selects the effect to be used.

PHASER

By adding varied-phase portions to the direct sound, the phaser effect gives a whooshing, swirling character to the sound.

Parameter/Range	Explanation
TYPE	
Selects the number of stages that the phaser effect will use.	
4STG	This is a four-phase effect. A light phaser effect is obtained.
8STG	This is an eight-phase effect. It is a popular phaser effect.
12STG	This is a twelve-phase effect. A deep phase effect is obtained.
BI-PHS	This is the phaser with two phase shift circuits connected in series.
RATE	
0-100, BPM ♪ -BPM ♪	This sets the rate of the phaser effect.
When set to BPM, the value of each parameter will be set according to the value of the BPM (p. 163) specified for each patch. This makes it easier to achieve effect sound settings that match the tempo of the song.	
* If, due to the tempo, the time is longer than the range of allowable settings, it is then synchronized to a period either 1/2 or 1/4 of that time.	
DEPTH	
0-100	Determines the depth of the rotation effect.
MANUAL	
0-100	Adjusts the center frequency of the rotation effect.
RESO (Resonance)	
0-100	Determines the amount of resonance (feedback). Increasing the value will emphasize the effect, creating a more unusual sound.
STEP RATE	
Off, 0-100, BPM ♪ -BPM ♪	This sets the cycle of the step function that changes the rotation. When it is set to a higher value, the change will be finer. Set this to Off when not using the Step function.
When set to BPM, the value of each parameter will be set according to the value of the BPM (p. 163) specified for each patch. This makes it easier to achieve effect sound settings that match the tempo of the song.	
* If, due to the tempo, the time is longer than the range of allowable settings, it is then synchronized to a period either 1/2 or 1/4 of that time.	
EFFECT LEVEL	
0-100	Adjusts the volume of the phaser.
DIRECT LEVEL	
0-100	Adjusts the volume of the direct sound.

FLANGER

The flanging effect gives a twisting, jet-airplane-like character to the sound.

Parameter/Range	Explanation
RATE	
0–100, BPM ◦ –BPM 🎵	This sets the rate of the flanging effect.
When set to BPM, the value of each parameter will be set according to the value of the BPM (p. 163) specified for each patch. This makes it easier to achieve effect sound settings that match the tempo of the song.	
* <i>If, due to the tempo, the time is longer than the range of allowable settings, it is then synchronized to a period either 1/2 or 1/4 of that time.</i>	
DEPTH	
0–100	Determines the depth of the flanging effect.
MANUAL	
0–100	Adjusts the center frequency at which to apply the effect.
RESO (Resonance)	
0–100	Determines the amount of resonance (feedback). Increasing the value will emphasize the effect, creating a more unusual sound.
SEPARATION	
0–100	Adjusts the diffusion. The diffusion increases as the value increases.
LOW CUT (Low Cut Filter)	
FLAT, 55 Hz–800 Hz	This lets you cut the low-end component below the set frequency to create a clear, distinct low end, thereby bringing out the high end of the effect. When FLAT is selected, the low cut filter will have no effect.
EFFECT LEVEL	
0–100	Adjusts the volume of the flanger.
DIRECT LEVEL	
0–100	Adjusts the volume of the direct sound.

TREML (Tremolo)

Tremolo is an effect that creates a cyclic change in volume.

Parameter/Range	Explanation
WAVE SHAPE	
0–100	Adjusts the curve for the volume change. Raising the value makes the changes occur more rapidly.
RATE	
0–100, BPM ◦ –BPM 🎵	Adjusts the frequency (speed) of the change.
When set to BPM, the value of each parameter will be set according to the value of the BPM (p. 163) specified for each patch. This makes it easier to achieve effect sound settings that match the tempo of the song.	
* <i>If, due to the tempo, the time is longer than the range of allowable settings, it is then synchronized to a period either 1/2 or 1/4 of that time.</i>	
DEPTH	
0–100	Adjusts the depth of the effect.

PAN

With the volume level of the left and right sides alternately changing, when playing sound in stereo, you can get an effect that makes the guitar sound appear to fly back and forth between the speakers.

Parameter/Range	Explanation
WAVE SHAPE	
0–100	Adjusts the curve for the volume change. Raising the value makes the changes occur more rapidly.
RATE	
0–100, BPM ◦ –BPM 🎵	Adjusts the frequency (speed) of the change.
When set to BPM, the value of each parameter will be set according to the value of the BPM (p. 163) specified for each patch. This makes it easier to achieve effect sound settings that match the tempo of the song.	
* <i>If, due to the tempo, the time is longer than the range of allowable settings, it is then synchronized to a period either 1/2 or 1/4 of that time.</i>	
DEPTH	
0–100	Adjusts the depth of the effect.

* *The pan effect is cancelled if a monaural effect or COSM amp is connected after the COSM GUITAR effect.*

T.WAH (Touch Wah)



You can produce a wah effect with the filter changing in response to the guitar level.

Parameter/Range	Explanation
MODE	
Selects the wah mode.	
LPF (Low Pass Filter)	This creates a wah effect over a wide frequency range.
BPF (Band Pass Filter)	This creates a wah effect in a narrow frequency range.
POLARITY	
Selects the direction in which the filter will change in response to the input.	
UP	The frequency of the filter will rise.
DOWN	The frequency of the filter will fall.
SENS (Sensitivity)	
0–100	Adjusts the sensitivity at which the filter will change in the direction determined by the polarity setting. Higher values will result in a stronger response. With a setting of 0, the strength of picking will have no effect.
FREQ (Frequency)	
0–100	Adjusts the center frequency of the Wah effect.
PEAK	
Higher values will produce a stronger tone which emphasizes the wah effect more.	
0–100	Adjusts the way in which the wah effect applies to the area around the center frequency. With a value of 50 a standard wah sound will be produced.
LEVEL	
0–100	Adjusts the volume of the effect sound.
DIRECT LEVEL	
0–100	Adjusts the volume of the direct sound.

AUTO WAH

This changes the filtering over a periodic cycle, providing an automatic wah effect.

Parameter/Range	Explanation
MODE	
Selects the wah mode.	
LPF (Low Pass Filter)	This creates a wah effect over a wide frequency range.
BPF (Band Pass Filter)	This creates a wah effect in a narrow frequency range.
FREQ (Frequency)	
0–100	Adjusts the center frequency of the Wah effect.
PEAK	

Parameter/Range	Explanation
0–100	Adjusts the amount of wah effect applied in the range near the reference frequency. Higher values will produce a stronger tone which emphasizes the wah effect more. With a value of 50 a standard wah sound will be produced.
RATE	
0–100, BPM  –BPM 	Adjusts the frequency (speed) of the change.
When set to BPM, the value of each parameter will be set according to the value of the BPM (p. 163) specified for each patch. This makes it easier to achieve effect sound settings that match the tempo of the song.	
* If, due to the tempo, the time is longer than the range of allowable settings, it is then synchronized to a period either 1/2 or 1/4 of that time.	
DEPTH	
0–100	Adjusts the depth of the effect.
LEVEL	
0–100	Adjusts the volume of the effect sound.
DIRECT LEVEL	
0–100	Adjusts the volume of the direct sound.

OCTAVE

This adds a note one octave lower, creating a richer sound.

* Because of the need to analyze the pitch, chords (two or more sounds played simultaneously) cannot be played.

Parameter/Range	Explanation
RANGE	
This selects the register to which the effect is applied.	
RANGE1	B1 (corresponds to the sound of an open 7th string) to E6 (corresponds to the 1st string played at the 24th fret)
RANGE2	B1 (corresponds to the sound of an open 7th string) to E5 (corresponds to the 1st string played at the 12th fret)
RANGE3	B1 (corresponds to the sound of an open 7th string) to E4 (corresponds to the sound of an open 1st string)
RANGE4	B1 (corresponds to the sound of an open 7th string) to E3 (corresponds to the 4th string played at the 2nd fret)
OCTAVE LEVEL	
0–100	Adjusts the volume of the sound one octave below.
DIRECT LEVEL	
0–100	Adjusts the volume of the direct sound.

PITCH SHIFT (Pitch Shifter)

This effect changes the pitch of the original sound (up or down) within a range of two octaves.



Parameter/Range	Explanation
VOICE	
Selects the number of voices for the pitch shift sound.	
1VOICE	One-voice pitch-shifted sound output in monaural.
2MONO	Two-voice pitch-shifted sound (PS1, PS2) output in monaural.
2ST (2Stereo)	Two-voice pitch-shifted sound (PS1, PS2) output through left and right channels.
LEVEL1, LEVEL2 *1	
0-100	Adjusts the volume of the pitch shift sound
DIRECT LEVEL	
0-100	Adjusts the volume of the direct sound.
PITCH SHIFT1, PITCH SHIFT2	
MODE1, MODE2 *1	
Selection for the pitch shifter mode.	
FAST, MEDIUM, SLOW	A chord can be input with a normal pitch shifter. The response is slower in the order of FAST, MEDIUM and SLOW, but the modulation is lessened in the same order.
MONO	MONO is used for inputting single notes. * You may be unable to produce the intended effect when playing chords (two or more notes played simultaneously).
PITCH 1, PITCH2 *1	
-24-+24	Adjusts the amount of pitch shift (the amount of interval) in semitone steps.
FINE1, FINE2 *1	
-50-+50	Make fine adjustments to the interval. The amount of the change in the Fine 100 is equivalent to that of the Pitch 1.
PRE DELAY1, PRE DELAY2 *1	
0 ms -300 ms, BPM ♪ -BPM ♫	Adjusts the time from when the direct sound is heard until the pitch shifted sounds are inputted. Normally you can leave this set at 0ms.
When set to BPM, the value of each parameter will be set according to the value of the BPM (p. 163) specified for each patch. This makes it easier to achieve effect sound settings that match the tempo of the song.	
* If, due to the tempo, the time is longer than the range of allowable settings, it is then synchronized to a period either 1/2 or 1/4 of that time.	
FEEDBACK1	
0-100	Adjusts the feedback amount of the pitch shift sound.

*1 With VOICE set to 2MONO or 2ST, you can select two sounds.

HARMONIST

Harmonist is an effect where the amount of shifting is adjusted according to an analysis of the guitar input, allowing you to create harmonics based on diatonic scales.

- * Because of the need to analyze the pitch, chords (two or more sounds played simultaneously) cannot be played.
- * You cannot use the Harmonist effect with audio input via USB IN.

Parameter/Range	Explanation
KEY	
C (Am)-B (G#m)	Specify the key of the song you are playing. By specifying the key, you can create harmonies that fit the key of the song. TIP This KEY parameter is the same as the Key setting in the [NAME/KEY/BPM] section (p. 163) and FX MOD1, 2 HARMONIST. Altering either one changes the key.
The key setting corresponds to the key of the song (#, b) as follows.	
<p>Major C F B^b E^b A^b D^b</p>  <p>Minor Am Dm Gm Cm Fm B^bm</p> <p>Major G D A E B F[#]</p>  <p>Minor Em Bm F[#]m C[#]m G[#]m D[#]m</p>	
VOICE	
Selects the number of voices for the pitch shift sound.	
1VOICE	One-voice pitch-shifted sound output in monaural.
2MONO	Two-voice pitch-shifted sound (PS1, PS2) output in monaural.
2ST (2Stereo)	Two-voice pitch-shifted sound (PS1, PS2) output through left and right channels.
FEEDBACK1	
0-100	Adjusts the feedback amount of the harmonist sound.
DIRECT LEVEL	
0-100	Adjusts the volume of the direct sound.

Parameter/Range	Explanation
HARMONY1, HARMONY2 *1	
HARM1, HARM2 (Harmony) *1	
This determines the pitch of the sound added to the input sound, when you are making a harmony.	
-2 oct→+2 oct, USER	It allows you to set it by up to 2 octaves higher or lower than the input sound. When the scale is set to USER, this parameter sets the user scale number to be used.
PRE DELAY1, PRE DELAY2 *1	
0 ms–300 ms, BPM ♪ –BPM ♪	Adjusts the time from when the direct sound is heard until the harmonist sounds are heard. Normally you can leave this set at 0ms.
When set to BPM, the value of each parameter will be set according to the value of the BPM (p. 163) specified for each patch. This makes it easier to achieve effect sound settings that match the tempo of the song.	
* If, due to the tempo, the time is longer than the range of allowable settings, it is then synchronized to a period either 1/2 or 1/4 of that time.	
LEVEL1, LEVEL2 *1	
0–100	Adjusts the volume of the harmony sound.
VOICE1 INTERVAL C-B, VOICE2 INTERVAL C-B *2	
-24→+24	Sets the output pitch for the set key relative to the input pitch.

*1 HARM1 and HARM2 are set individually.

*2 VOICE1 INTERVAL (VOICE2 INTERVAL) is enabled when HARM1 (HARM2) is set to USER.

Creating Harmonist Scales (User Scale)

When HARM is set to any value from -2oct to +2oct, and the harmony does not sound the way you intend, use a User scale. You can set the corresponding pitches to be output for each input pitch.

1. Set HARM1 (or HARM2) to USER in the Harmonist screen.
2. Select VOICE1 INTERVAL (or VOICE2 INTERVAL) with PAGE [▶].

The Voice Interval screen appears.



3. Use PAGE [◀] [▶], [F1]–[F6], and the F1–F6 knob to set the amount of pitch shift for each voice.

PEDAL BEND

This lets you use the pedal to get a pitch bend effect.

- * Because of the need to analyze the pitch, chords (two or more sounds played simultaneously) cannot be played.

cf.

“Chapter 5 Using the VG-99 in Combination with an FC-300” (p. 52)

Parameter/Range	Explanation
PITCH MIN (Pitch Minimum)	
-24+24	This sets the pitch at the point where the expression pedal is fully lifted.
PITCH MAX (Pitch Maximum)	
-24+24	This sets the pitch at the point where the expression pedal is all the way down.
PEDAL POS (Pedal Position)	
0-100	Adjusts the pedal position for pedal bend. * This parameter is used after it's been assigned to an expression pedal or similar controller.
EFFECT LEVEL	
0-100	Adjusts the volume of the pitch bend sound.
DIRECT LEVEL	
0-100	Adjusts the volume of the direct sound.





2x2 CHORUS

Frequency band division is employed to produce two different choruses, one for low frequencies and one for higher frequencies, for both the left and right channels (for a total of four). This allows you to achieve a more natural chorus sound.

Parameter/Range	Explanation
X-OVER FREQ (Crossover Frequency)	
100 Hz-4.00 kHz	This sets the frequency dividing the low- and high-frequency ranges.
LOW RATE	
0-100, BPM -BPM	Adjust the speed of the chorus effect for the low frequency range.
When set to BPM, the value of each parameter will be set according to the value of the BPM (p. 163) specified for each patch. This makes it easier to achieve effect sound settings that match the tempo of the song. * If, due to the tempo, the time is longer than the range of allowable settings, it is then synchronized to a period either 1/2 or 1/4 of that time.	
LOW DEPTH	
0-100	Adjust the depth of the chorus effect for the low frequency range. If you wish to use this as a doubling effect, use a setting of 0.
LOW PREDLY (Low Pre Delay)	
0.0 ms-40.0 ms	Adjusts the delay of the effect sound in the low-frequency range. Extending the pre-delay will produce the sensation of multiple sounds (doubling effect).
LOW LEVEL	
0-100	Adjusts the volume of the effect sound in the low-frequency range.
HIGH RATE	
0-100, BPM -BPM	Adjust the speed of the chorus effect for the high frequency range.
When set to BPM, the value of each parameter will be set according to the value of the BPM (p. 163) specified for each patch. This makes it easier to achieve effect sound settings that match the tempo of the song. * If, due to the tempo, the time is longer than the range of allowable settings, it is then synchronized to a period either 1/2 or 1/4 of that time.	
HIGH DEPTH	
0-100	Adjust the depth of the chorus effect for the high frequency range. If you wish to use this as a doubling effect, use a setting of 0.
HIGH PREDLY (High Pre Delay)	
0.0 ms-40.0 ms	Adjusts the delay of the effect sound in the high-frequency range. Extending the pre-delay will produce the sensation of multiple sounds (doubling effect).
HIGH LEVEL	
0-100	Adjusts the volume of the effect sound in the high-frequency range.

ROTARY



This produces an effect like the sound of a rotary speaker.

Parameter/ Range	Explanation
SPEED	
SLOW, FAST	This parameter changes the simulated speaker's rotating speed (Slow or Fast).
RATE SLOW	
0–100, BPM  –BPM 	This parameter adjusts the speed of rotation when set to Slow.
RATE FAST	
0–100, BPM  –BPM 	This parameter adjusts the speed of rotation when set to Fast.
When the Rate (Slow) or Rate (Fast) set to BPM, the value of each parameter will be set according to the value of the BPM (p. 163) specified for each patch. This makes it easier to achieve effect sound settings that match the tempo of the song.	
* If, due to the tempo, the time is longer than the range of allowable settings, it is then synchronized to a period either 1/2 or 1/4 of that time.	
RISE TIME	
0–100	This parameter adjusts the time it takes for the rotation speed to change when switched from Slow to Fast.
FALL TIME	
0–100	This parameter adjusts the time it takes for the rotation speed to change when switched from Fast to Slow.
DEPTH	
0–100	This parameter adjusts the amount of depth in the rotary effect.

UNI-V



This models the sound of the Uni-vibe.

Although the same type of effect as a phaser, its characteristic feature is a unique twisting effect, which you can't get from an ordinary phaser.

Parameter/ Range	Explanation
RATE	
0–100, BPM  –BPM 	Adjusts the rate of the Uni-V effect.
When set to BPM, the value of each parameter will be set according to the value of the BPM (p. 163) specified for each patch. This makes it easier to achieve effect sound settings that match the tempo of the song.	
* If, due to the tempo, the time is longer than the range of allowable settings, it is then synchronized to a period either 1/2 or 1/4 of that time.	
DEPTH	
0–100	Adjusts the depth of the Uni-V effect.
LEVEL	
0–100	Adjusts the volume.

VIB (Vibrato)

This effect creates vibrato by slightly modulating the pitch.

Parameter/ Range	Explanation
RATE	
0–100, BPM  –BPM 	Adjusts the rate of the vibrato.
When set to BPM, the value of each parameter will be set according to the value of the BPM (p. 163) specified for each patch. This makes it easier to achieve effect sound settings that match the tempo of the song.	
* If, due to the tempo, the time is longer than the range of allowable settings, it is then synchronized to a period either 1/2 or 1/4 of that time.	
DEPTH	
0–100	Adjusts the depth of the vibrato.
RISE TIME	
0–100	This sets the time passing from the moment the trigger is turned on until the set vibrato is obtained.
* When a patch with TRIG set to ON is called up, the effect obtained is identical to what happens when TRIG is switched from OFF to ON. If you want the vibrato effect to be produced immediately after the patches are switched, set RISE TIME to 0.	
TRIG (Trigger)	
OFF, ON	This selects on/off of the vibrato. It is assumed that this parameter will be assigned to the footswitch. (p. 49)

SLICER

This consecutively interrupts the sound to create the impression that a rhythm backing phrase is being played.

Parameter/Range	Explanation
PATTERN	
P1-P20	Select the slice pattern that will be used to cut the sound.
RATE	
0-100, BPM ◦ -BPM 🎵	Adjust the rate at which the sound will be cut.
When set to BPM, the value of each parameter will be set according to the value of the BPM (p. 163) specified for each patch. This makes it easier to achieve effect sound settings that match the tempo of the song.	
* If, due to the tempo, the time is longer than the range of allowable settings, it is then synchronized to a period either 1/2 or 1/4 of that time.	
TRIG SENS (Trigger Sensitivity)	
0-100	Adjust the sensitivity of triggering. With low settings of this parameter, softly picked notes will not retrigger the phrase (i.e., the phrase will continue playing), but strongly picked notes will retrigger the phrase so that it will playback from the beginning. With high settings of this parameter, the phrase will be retriggered even by softly picked notes.

HUMANIZER

This can create human vowel-like sounds.

Parameter/Range	Explanation
MODE	
This sets the mode that switches the vowels.	
PICK (Picking)	It changes from vowel 1 to vowel 2 along with the picking. The time spent for the change is adjusted with the rate.
AUTO	By adjusting the rate and depth, two vowels (Vowel 1 and Vowel 2) can be switched automatically.
RANDOM	Five vowels (A, E, I, O, U) are called out at random by adjusting the rate and depth.
VOWEL 1 *1	
A, E, I, O, U	Selects the first vowel.
VOWEL 2 *1	
A, E, I, O, U	Selects the second vowel.
SENS (Sensitivity) *2	
0-100	Adjusts the sensitivity of the humanizer. When it is set to a lower value, no effect of the humanizer is obtained with weaker picking, while stronger picking produces the effect. When it is set to a higher value, the effect of the humanizer can be obtained whether the picking is weak or strong.
RATE	
0-100, BPM ◦ -BPM 🎵	Adjusts the cycle for changing the two vowels.
When set to BPM, the value of each parameter will be set according to the value of the BPM (p. 163) specified for each patch. This makes it easier to achieve effect sound settings that match the tempo of the song.	
* If, due to the tempo, the time is longer than the range of allowable settings, it is then synchronized to a period either 1/2 or 1/4 of that time.	
MANUAL *3	
0-100	This determines the point where the two vowels are switched. When it is set to 50, vowel 1 and vowel 2 are switched in the same length of time. When it is set to lower than 50, the time for vowel 1 is shorter. When it is set to higher than 50, the time for vowel 1 is longer.
DEPTH	
0-100	Adjusts the depth of the effect.
LEVEL	
0-100	Adjusts the volume.

*1 Setting available with MODE set to PICK or AUTO.

*2 Setting available with MODE set to PICK.

*3 Setting available with MODE set to AUTO.

SLOW GEAR

This produces a volume-swell effect (“violin-like” sound).

Parameter/Range	Explanation
SENS (Sensitivity)	
0–100	Adjusts the sensitivity.
RISE TIME	
0–100	Adjusts the time needed for the volume to reach its maximum from the moment you begin picking.

DEFRET

This simulates a fretless guitar.

Parameter/Range	Explanation
TOPE	
-50–+50	Adjusts the amount of blurring between the notes.
SENS (Sensitivity)	
0–100	This controls the input sensitivity of the defretter.
ATTACK	
0–100	Adjusts the attack of the picking sound.
DEPTH	
0–100	This controls the volume of the harmonics.
RESO (Resonance)	
0–100	Adds a characteristically resonant quality to the sound.
EFFECT LEVEL	
0–100	Adjust the volume of the defretter sound.
DIRECT LEVEL	
0–100	Adjust the volume of the direct sound.

FEEDBACKER

This allows you to use feedback playing techniques.

- * Note that the notes you want to apply feedback to must be played singly and cleanly.
- * You can use the footswitch to switch the effect on and off. For more details, refer to p. 49.

Parameter/Range	Explanation
MODE	
OSC (Oscillator)	An artificial feedback sound will be created internally. When OSC is selected, the effect is activated after a single note is played and the note stabilizes. A feedback effect is created when the effect switches on; the feedback disappears when the OSC effect switches off.
NATURAL	Analyzes the pitch of the guitar sound being input, and then creates a feedback sound.
RISE TIME *1	
0–100	This determines the time needed for the volume of the feedback sound to reach its maximum from the moment the effect is turned on.
RISE TIME+ *1	
0–100	This determines the time needed for the volume of the one octave higher feedback sound to reach its maximum from the moment the effect is turned on.
FB LEVEL (Feedback Level)	
0–100	Adjusts the volume of the feedback sound.
FB LEVEL+ (Feedback Level+) *1	
0–100	Adjusts the volume of the one octave higher feedback sound.
VIB RATE (Vibrato Rate) *1	
0–100, BPM ♪ –BPM ♪	Adjusts the rate of the vibrato when the feedbacker is on.
When set to BPM, the value of each parameter will be set according to the value of the BPM (p. 163) specified for each patch. This makes it easier to achieve effect sound settings that match the tempo of the song.	
* If, due to the tempo, the time is longer than the range of allowable settings, it is then synchronized to a period either 1/2 or 1/4 of that time.	
VIB DEPTH (Vibrato Depth) *1	
0–100	Adjusts the depth of the vibrato when the feedbacker is on.

*1 Setting available with MODE set to OSC.

RING MOD (Ring Modulator)

This creates a bell-like sound by ring-modulating the guitar sound with the signal from the internal oscillator. The sound can be unmusical and lack distinctive pitches.

Parameter/Range	Explanation
MODE	
This selects the mode for the ring modulator.	
NORMAL	This is a normal ring modulator.
INTELLIGENT	By ring-modulating the input signal, a bell like sound is created. The intelligent ring modulator changes the oscillation frequency according to the pitch of the input sound and therefore produces a sound with the sense of pitch, which is quite different from Normal. This effect does not give a satisfactory result if the pitch of the guitar sound is not correctly detected. So, you must use single notes, not chords.
FREQ (Frequency)	
0–100	Adjusts the frequency of the internal oscillator.
EFFECT LEVEL	
0–100	Adjusts the volume of the effect sound.
DIRECT LEVEL	
0–100	Adjusts the volume of the direct sound.

ANTI FB (Anti-feedback)

This prevents the acoustic feedback that can be produced by the body resonances of a guitar.

Parameter/Range	Explanation
FREQ1–3 (Frequency 1–3)	
0–100	Set the fixed frequency point at which feedback will be cancelled. You can set up to three cancellation points.
DEPTH1–3	
0–100	Adjusts the degree of the anti-feedback at each of the three cancellation points.

ADV.COMP (Advanced Compressor)

This is an effect that produces a long sustain by evening out the volume level of the input signal. You can also use it as a limiter to suppress only the sound peaks and prevent distortion.

Parameter/Range	Explanation
TYPE	
Selects the compressor type.	
BOSS COMP	This models a BOSS CS-3.
HIBAND	This is a compressor that adds an even stronger effect in the high end.
LIGHT	This is a compressor with a light effect.
D-COMP	This models a MXR DynaComp.
ORANGE	This is modeled on the sound of the Dan Armstrong ORANGE SQUEEZER.
FAT	When applied heavily, this compressor effect provides a fat tone with a boosted midrange.
MILD	When applied heavily, this compressor effect produces a sweet tone with the high end cut.
STEREO COMP	This selects a stereo compressor.
SUSTAIN	
0–100	Adjusts the range (time) over which low-level signals are boosted. Larger values will result in longer sustain.
ATTACK	
0–100	Adjusts the strength of the picking attack. Larger values will result in a sharper attack, creating a more clearly defined sound.
STONE	
-50–+50	Adjusts the tone.
LEVEL	
0–100	Adjusts the volume.

LIMITR (Limiter)

The limiter attenuates loud input levels to prevent distortion.

Parameter/Range	Explanation
TYPE	
Selects the limiter type.	
BOSS LIMITR	This selects a stereo limiter.
RACK 160D	This models a dbx 160X.
VTG RACK U	This models a UREI 1178.
ATTACK	
0–100	Adjusts the strength of the picking attack when the strings are played. Higher values result in a sharper attack, creating a more clearly defined sound.
THRSH (Threshold)	
0–100	Adjust this as appropriate for the input signal from your guitar. When the input signal level exceeds this threshold level, limiting will be applied.
RATIO	
1: 1–∞: 1	This selects the compression ratio used with signals in excess of the threshold level.
REL (Release)	
0–100	Adjusts the time from when the signal level drops below the threshold until when limiting is removed.
LEVEL	
0–100	Adjusts the volume.

SUB EQ (Sub Equalizer)

This adjusts the tone as a sub equalizer. A parametric type is adopted for the high-middle and low-middle range.

Parameter/Range	Explanation
TOTAL GAIN	
-12–+12dB	Adjusts the overall EQ volume.
LOW GAIN	
-12–+12dB	Adjusts the low frequency range tone.
HIGH GAIN	
-12–+12dB	Adjusts the high frequency range tone.
LOW MID FREQ (Low Middle Frequency)	
20Hz–10.0kHz	Specifies the center of the frequency range that will be adjusted by the LOW MID GAIN.
LOW MID Q (Low Middle Q)	
0.5–16	Adjusts the width of the area affected by the EQ centered at the LOW MID FREQ. Higher values will narrow the area.
LOW MID GAIN (Low Middle Gain)	
-12–+12dB	Adjusts the low-middle frequency range tone.
HIGH MID FREQ (High Middle Frequency)	
20Hz–10.0kHz	Specifies the center of the frequency range that will be adjusted by the HIGH MID GAIN.
HIGH MID Q (High Middle Q)	
0.5–16	Adjusts the width of the area affected by the EQ centered at the HIGH MID FREQ. Higher values will narrow the area.
HIGH MID GAIN (High Middle Gain)	
-12–+12dB	Adjusts the high-middle frequency range tone.
LOW CUT (Low Cut Filter)	
FLAT, 55 Hz–800 Hz	This lets you cut the low-end component below the set frequency to create a clear, distinct low end, thereby bringing out the high end of the effect. When FLAT is selected, the low cut filter will have no effect.
HIGH CUT (High Cut Filter)	
700 Hz–11 kHz, FLAT	This allows you to get a mild effect sound by cutting the high-end component above the set frequency. When it is set to FLAT, the high cut filter is off or has no effect.

SUB DELAY (Sub Delay)

This is a delay with the maximum delay time of 400 ms. This effect is useful for making the sound fatter.

Parameter/Range	Explanation
DELAY TIME	
1 ms–400 ms, BPM ♪ –BPM ♪	Adjusts the delay time.
When set to BPM, the value of each parameter will be set according to the value of the BPM (p. 163) specified for each patch. This makes it easier to achieve effect sound settings that match the tempo of the song.	
* If, due to the tempo, the time is longer than the range of allowable settings, it is then synchronized to a period either 1/2 or 1/4 of that time.	
* After setting DELAY TIME to BPM (♪ – ∞), if you tap [F1] (TAP), the BPM value will change to match the timing of your tapping.	
FEEDBACK	
0–100	Adjusts the volume that is returned to the input. Feedback refers to returning the delayed signal back into the input of the delay. Higher settings will result in more delay repeats.
EFFECT LEVEL	
0–120	Adjusts the volume of delay sound.

NS (Noise Suppressor)

This effect reduces the noise and hum picked up by guitar pickups. Since it suppresses the noise in synchronization with the envelope of the guitar sound (the way in which the guitar sound decays over time), it has very little effect on the guitar sound, and does not harm the natural character of the sound.

- * Please connect the noise suppressor in the signal path prior to the reverb type effect. This setup will prevent a natural break of the reverb type effect.

Parameter/Range	Explanation
NS SW (Noise Suppressor Switch)	
OFF, ON	Turns the NS effect on/off.
THRSH (Threshold)	
0–100	Adjust this parameter as appropriate for the volume of the noise. If the noise level is high, a higher setting is appropriate. If the noise level is low, a lower setting is appropriate. Adjust this value until the decay of the guitar sound is as natural as possible. * High settings for the threshold parameter may result in there being no sound when you play with your guitar volume turned down.
REL (Release)	
0–100	Adjusts the amount of time from the point at which application of the noise suppressor begins to when the volume is fully attenuated.
DETECT	
This controls the noise suppressor based on the volume level for the point specified in Detect.	
INPUT	Volume of the COSM guitar and normal pickup
NS IN (NS Input)	Noise suppressor input volume.

FV (Foot Volume)

This is a volume control effect.

Normally, this is controlled with the expression pedal connected to the EXP PEDAL jack or the FC-300's EXP pedal.

* When making the settings determining each pedal's foot volume operations, refer to **"Using the Switches, Pedals, and MIDI to Control the Sounds (CONTROL ASSIGN)"** (p. 82).

Parameter/Range	Explanation
LEVEL	
0-100	Adjusts the volume.
VOL CURVE (Volume Curve)	
You can select how the actual volume changes relative to the amount the pedal is pressed.	
SLOW1, SLOW2, NORMAL, FAST	

NOTE

You may be unable to properly obtain the foot volume effect if **"FEEDBACKER"** (p. 135) is connected at a point after FV in the effects chain (p. 32).

COSM AMP

COSM technology simulates different preamp characteristics, speaker sizes, and cabinet shapes.

* You can make separate settings for Channel A and Channel B.

Parameter/Range	Explanation
COSM AMP SW (COSM AMP Switch)	
OFF, ON	Turns the COSM AMP effect on/off.
PREAMP TYPE	
refer to Preamp Type List	This sets the type of the guitar preamp.

Preamp Type List

Type	Explanation
JC CLEAN (p. 141)	
JC-120	This is the sound of the Roland JC-120.
WARM CLEAN	This gives a mellow, clean sound.
JAZZ COMBO	This is a sound suited to jazz.
FULL RANGE	This is a sound with flat response. Good for acoustic guitar
BRIGHT CLEAN	A bright, clean tone.
TW CLEAN (p. 141)	
CLEAN TWIN	This models a Fender Twin Reverb.
PRO CRUNCH	This models a Fender Pro Reverb.
TWEED	This models a Fender Bassman 4 x 10" Combo.
WARM CRUNCH	This gives a mellow, crunch sound.
CRUNCH (p. 141)	
CRUNCH	This is a crunch sound that can produce natural distortion.
BLUES	This is a sound suited to blues.
WILD CRUNCH	This is a crunch sound with wild distortion.
STACK CRUNCH	This is a crunch sound with high gain.
COMBO (p. 141)	
VO DRIVE	This models the drive sound of a VOX AC-30TB.
VO LEAD	This models the lead sound of the VOX AC-30TB.
VO CLEAN	This models the clean sound of the VOX AC-30TB.
MATCH DRIVE	This models the sound input to left input on a Matchless D/C-30.
FAT MATCH	This models the sound of a Matchless with a modified high gain.
MATCH LEAD	This models the sound input to right input on a Matchless D/C-30.

Type	Explanation
BG LEAD (p. 141)	
BG LEAD	This models the lead sound of the MESA/Boogie combo amp.
BG DRIVE	This models a MESA/Boogie with TREBLE SHIFT SW on.
BG RHYTHM	This models the rhythm channel of a MESA/Boogie.
SMOOTH DRIVE	This is a smooth drive sound.
MILD DRIVE	This is a mellow drive sound.
MS STACK (p. 141)	
MS1959 (I)	This models the sound input to Input I on a Marshall 1959.
MS1959 (II)	This models the sound input to Input II on a Marshall 1959.
MS1959 (I+II)	This models the sound of a Marshall 1959 with Inputs I and II connected in parallel.
MS HI-GAIN	This models the sound of a Marshall with a modified midrange boost.
POWER STACK	This provides the sound of a stack amp with active type tone circuitry.
R-FIER (p. 141)	
CLEAN	Models the sound of the Channel 1 CLEAN Mode on the MESA/Boogie DUAL Rectifier.
RAW	Models the sound of the Channel 2 RAW Mode on the MESA/Boogie DUAL Rectifier.
VINTAGE 1	Models the sound of the Channel 2 VINTAGE Mode on the MESA/Boogie DUAL Rectifier.
MODERN 1	Models the sound of the Channel 2 MODERN Mode on the MESA/Boogie DUAL Rectifier.
VINTAGE 2	Models the sound of the Channel 3 VINTAGE Mode on the MESA/Boogie DUAL Rectifier.
MODERN 2	Models the sound of the Channel 3 MODERN Mode on the MESA/Boogie DUAL Rectifier.
T-AMP (p. 141)	
CLEAN	This models a Hughes & Kettner Triamp AMP1.
CRUNCH	This models a Hughes & Kettner Triamp AMP2.
LEAD	This models a Hughes & Kettner Triamp AMP3.
EDGE LEAD	A sharp lead sound.
HI-GAIN (p. 141)	
SLDN	This models a Soldano SLO-100.
DRIVE STACK	This is a drive sound with high gain.
LEAD STACK	This is a lead sound with high gain.
HEAVY LEAD	A powerful lead sound featuring extreme distortion.

Type	Explanation
METAL (p. 141)	
5150 DRIVE	This models the lead channel of a Peavey EVH 5150.
METAL STACK	This is a drive sound suited to metal.
METAL LEAD	This is a lead sound suited to metal.
CUSTOM (p. 143)	
CUSTOM	Custom amp
BASS AMP (p. 144)	
VINTAGE	Models the Ampeg B-15.
MODERN	Models the SWR SM-400.

JC CLEAN / TW CLEAN / CRUNCH / COMBO / BG LEAD / MS STACK / R-FIRE / T-AMP / HI-GAIN / METAL

Parameter/Range	Explanation
GAIN	
0-120	Adjusts the distortion of the amp.
BASS	
0-100	Adjusts the tone for the low frequency range.
MIDDLE	
0-100	Adjusts the tone for the middle frequency range.
TREBLE	
0-100	Adjusts the tone for the high frequency range.
PRESENCE	
0-100	Adjusts the tone for the ultra high frequency range.
LEVEL	
0-100	Adjusts the volume of the entire preamp. * <i>Be careful not to raise the Level setting too high.</i>
BRIGHT	
Turns the bright setting on/off. *1	
OFF	Bright is not used.
ON	Bright is switched on to create a lighter and crisper tone.
GAIN SW	
LOW, MIDDLE, HIGH	Provides for selection from three levels of distortion: LOW, MIDDLE, and HIGH. Distortion will successively increase for settings of LOW, MIDDLE and HIGH. * <i>The sound of each Type is created on the basis that the Gain is set to MIDDLE. So, normally set it to MIDDLE.</i>
SOLO SW	
OFF, ON	Pressing [SOLO] switches the tone to one suitable for solos.
SOLO LEVEL	
0-100	Adjusts the volume level when the Solo switch is ON.

*1 The BRIGHT parameter setting is only partially available with some JC CLEAN, CRUNCH, or BASS AMP settings in PREAMP TYPE.

Parameter/Range	Explanation
SP TYPE (Speaker Type)	
Select the speaker type.	
OFF	This turns off the speaker simulator.
ORIG	This is the built-in speaker of the amp you selected with PREAMP TYPE.
1x8"	This is a compact open-back speaker cabinet with one 8-inch speaker.
1x10"	This is a compact open-back speaker cabinet with one 10-inch speaker.
1X12"	This is a compact open-back speaker cabinet with one 12-inch speaker.
2X12"	This is a general open-back speaker cabinet with two 12-inch speakers.
4X10"	This is an optimal speaker cabinet for a large enclosed amp with four 10-inch speakers.
4X12"	This is an optimal speaker cabinet for a large enclosed amp with four 12-inch speakers.
8X12"	This is a double stack of two cabinets, each with four 12-inch speakers.
CUSTOM	Custom speaker
DIRECT LEVEL	
0-100	Adjusts the volume of the direct sound.
MIC TYPE	
This setting selects the simulated mic type.	
DYN57	This is the sound of the SHURE SM-57. General dynamic mic used for instruments and vocals. Optimal for use in miking guitar amps.
DYN421	This is the sound of the SENNHEISER MD-421. Dynamic mic with extended low end.
CND451	This is the sound of the AKG C451B. Small condenser mic for use with instruments.
CND87	This is the sound of the NEUMANN U87. Condenser mic with flat response.
FLAT	Simulates a mic with perfectly flat response. Produces a sonic image close to that of listening to the sound directly from the speakers (on site).
MIC DIS (Mic Distance)	
Simulates the distance between the mic and speaker.	
Off MIC	This setting points the mic away from the speaker.
On MIC	Provides conditions whereby the mic is directed more towards the speaker.

Parameter/Range	Explanation
MIC POS (Mic Position)	
This simulates the microphone position.	
CENTER	Simulates the condition that the microphone is set in the middle of the speaker cone.
1-10cm	Simulates the condition that the microphone is moved away from the center of the speaker cone.
MIC LEVEL	
0-100	Adjusts the volume of the microphone.

Parameter/Range	Explanation
CUSTOM SPEAKER *1	
SIZE	
5"-15"	Selects the size of speaker.
LOW	
-10-+10	Adjusts the speaker section's low-frequency tone.
HIGH	
-10-+10	Adjusts the speaker section's high-frequency tone.
NUMBER	
x1, x2, x4, x8	Sets the number of speakers.
CABINET	
Selects the speaker cabinet type.	
OPEN	This is an open-backed cabinet.
CLOSE	This type of cabinet features an enclosed rear panel.

*1 Setting available when SP TYPE is set to CUSTOM.

CUSTOM

Parameter/Range	Explanation
CUSTOM TYPE	
Selects the basic type of preamp.	
JC CLEAN	This is the sound of the Roland JC-120.
TW CLEAN	This models a Fender Twin Reverb.
CRUNCH	This is a crunch sound that can produce natural distortion.
VO DRIVE	This models the drive sound of a VOX AC-30TB.
BG LEAD	This models the lead sound of the MESA/Boogie combo amp.
MS HI-GAIN	This models the sound of a Marshall with a modified midrange boost.
MODERN STACK	Models the sound of the Channel 2 MODERN Mode on the MESA/Boogie DUAL Rectifier.
BOTTOM	
-50+50	This controls the input sound's low-frequency range and adjusts the amount of distortion in the low-frequency range.
EDGE	
-50+50	This controls the input sound's high-frequency range and adjusts the amount of distortion in the high-frequency range.
BASS FREQ (Bass Frequency)	
-50+50	Adjusts the frequency affected by the BASS knob.
TREBLE FREQ (Treble Frequency)	
-50+50	Adjusts the frequency affected by the TREBLE knob.
LOW	
-50+50	Adjusts the preamp section's low-frequency tone.
HIGH	
-50+50	Adjusts the preamp section's high-frequency tone.
GAIN	
0-120	Adjusts the distortion of the amp.
BASS	
0-100	Adjusts the tone for the low frequency range.
MIDDLE	
0-100	Adjusts the tone for the middle frequency range.
TREBLE	
0-100	Adjusts the tone for the high frequency range.
PRESENCE	
0-100	Adjusts the tone for the ultra high frequency range.

Parameter/Range	Explanation
LEVEL	
0-100	Adjusts the volume of the entire preamp. * <i>Be careful not to raise the Level setting too high.</i>
BRIGHT	
Turns the bright setting on/off. *1	
OFF	Bright is not used.
ON	Bright is switched on to create a lighter and crisper tone.
GAIN SW	
LOW, MIDDLE, HIGH	Provides for selection from three levels of distortion: LOW, MIDDLE, and HIGH. Distortion will successively increase for settings of LOW, MIDDLE and HIGH. * <i>The sound of each Type is created on the basis that the Gain is set to MIDDLE. So, normally set it to MIDDLE.</i>
SOLO SW	
OFF, ON	Pressing [SOLO] switches the tone to one suitable for solos.
SOLO LEVEL	
0-100	Adjusts the volume level when the Solo switch is ON.
SP TYPE (Speaker Type)	
Select the speaker type.	
OFF	This turns off the speaker simulator.
ORIGNL	This is the built-in speaker of the amp you selected with PREAMP TYPE.
1x8"	This is a compact open-back speaker cabinet with one 8-inch speaker.
1x10"	This is a compact open-back speaker cabinet with one 10-inch speaker.
1X12"	This is a compact open-back speaker cabinet with one 12-inch speaker.
2X12"	This is a general open-back speaker cabinet with two 12-inch speakers.
4X10"	This is an optimal speaker cabinet for a large enclosed amp with four 10-inch speakers.
4X12"	This is an optimal speaker cabinet for a large enclosed amp with four 12-inch speakers.
8X12"	This is a double stack of two cabinets, each with four 12-inch speakers.
CUSTOM	Custom speaker
DIRECT LEVEL	
0-100	Adjusts the volume of the direct sound.

*1 The BRIGHT parameter setting is only partially available with some JC CLEAN, CRUNCH, or BASS AMP settings in PREAMP TYPE.

Parameter/Range	Explanation
MIC TYPE	
This setting selects the simulated mic type.	
DYN57	This is the sound of the SHURE SM-57. General dynamic mic used for instruments and vocals. Optimal for use in miking guitar amps.
DYN421	This is the sound of the SENNHEISER MD-421. Dynamic mic with extended low end.
CND451	This is the sound of the AKG C451B. Small condenser mic for use with instruments.
CND87	This is the sound of the NEUMANN U87. Condenser mic with flat response.
FLAT	Simulates a mic with perfectly flat response. Produces a sonic image close to that of listening to the sound directly from the speakers (on site).
MIC DIS (Mic Distance)	
Simulates the distance between the mic and speaker.	
Off MIC	This setting points the mic away from the speaker.
On MIC	Provides conditions whereby the mic is directed more towards the speaker.
MIC POS (Mic Position)	
This simulates the microphone position.	
CENTER	Simulates the condition that the microphone is set in the middle of the speaker cone.
1–10cm	Simulates the condition that the microphone is moved away from the center of the speaker cone.
MIC LEVEL	
0–100	Adjusts the volume of the microphone.

Parameter/Range	Explanation
CUSTOM SPEAKER *1	
SIZE	
5"–15"	Selects the size of speaker.
LOW	
-10+10	Adjusts the speaker section's low-frequency tone.
HIGH	
-10+10	Adjusts the speaker section's high-frequency tone.
NUMBER	
x1, x2, x4, x8	Sets the number of speakers.
CABINET	
Selects the speaker cabinet type.	
OPEN	This is an open-backed cabinet.
CLOSE	This type of cabinet features an enclosed rear panel.

*1 Setting available when SP TYPE is set to CUSTOM.

BASS AMP VINTAGE

Parameter/Range	Explanation
GAIN	
0–100	Adjusts the distortion of the amp.
BASS	
-50+50	Adjusts the tone for the low frequency range.
MIDDLE	
-50+50	Adjusts the tone for the middle frequency range.
MIDDLE FREQ (Middle Frequency)	
220Hz, 800Hz, 3.0kHz	This control adjusts the center frequency of the frequency range adjusted with the Middle control.
TREBLE	
-50+50	Adjusts the tone for the high frequency range.
LEVEL	
0–100	Adjusts the volume of the entire preamp. * Be careful not to raise the Level setting too high.
BRIGHT	
Turns the bright setting on/off.	
OFF	Bright is not used.
ON	Bright is switched on to create a lighter and crisper tone.
RESPONSE	
BASS, FLAT	This controls the overall amp characteristics. Select the position corresponding to the characteristics for one of the two types of sound.
SP TYPE (Speaker Type)	
Select the speaker type.	
OFF	This turns off the speaker simulator.
ORIG	This is the built-in speaker of the amp you selected with PREAMP TYPE.
1x15"	Models the Trace Elliot 1518.
1x18"	Models the SWR Big Ben.
2x15"	Models the Acoustic 402.
4x10"	Models the SWR Goliath.
8x10"	Models the Ampeg 810E.
MIC POS (Mic Position)	
This simulates the microphone position.	
CENTER	Simulates the condition that the microphone is set in the middle of the speaker cone.
1–10cm	Simulates the condition that the microphone is moved away from the center of the speaker cone.
MIC LEVEL	
0–100	Adjusts the volume of the microphone.
DIRECT LEVEL	
0–100	Adjusts the volume of the direct sound.

BASS AMP MODERN

Parameter/ Range	Explanation
GAIN	
0–100	Adjusts the distortion of the amp.
BASS	
-50–+50	Adjusts the tone for the low frequency range.
MIDDLE	
-50–+50	Adjusts the tone for the middle frequency range.
MIDDLE FREQ (Middle Frequency)	
220Hz, 800Hz, 3.0kHz	This control adjusts the center frequency of the frequency range adjusted with the Middle control.
TREBLE	
-50–+50	Adjusts the tone for the high frequency range.
LEVEL	
0–100	Adjusts the volume of the entire preamp. * <i>Be careful not to raise the Level setting too high.</i>
ENHANCER	
0–100	This controls the clarity and presence of the sound.
SP TYPE (Speaker Type)	
Select the speaker type.	
OFF	This turns off the speaker simulator.
ORIG	This is the built-in speaker of the amp you selected with PREAMP TYPE.
1x15"	Models the Trace Elliot 1518.
1x18"	Models the SWR Big Ben.
2x15"	Models the Acoustic 402.
4x10"	Models the SWR Goliath.
8x10"	Models the Ampeg 810E.
MIC POS (Mic Position)	
This simulates the microphone position.	
CENTER	Simulates the condition that the microphone is set in the middle of the speaker cone.
1–10cm	Simulates the condition that the microphone is moved away from the center of the speaker cone.
MIC LEVEL	
0–100	Adjusts the volume of the microphone.
DIRECT LEVEL	
0–100	Adjusts the volume of the direct sound.

MIXER

MIXER

This mixes the signals in Channel A and Channel B.

MIXER A, B (MIXER CHANNEL A, B)

Parameter/ Range	Explanation
MIX SW	
OFF, ON	This setting switches mixing of Channel A (or Channel B) on and off. The sounds in the respective channel are not mixed when this is set to OFF.
PAN	
100:0–0:100	This sets the panning for Channel A (or Channel B).
LEVEL	
0–100	This sets the Channel A (or Channel B) volume level.
DELAY A SEND, DELAY B SEND	
0–100	Adjusts the send level from Channel A (or Channel B) to the mixer's delay.
REVERB A SEND, REVERB B SEND	
0–100	Adjusts the send level from Channel A (or Channel B) to the mixer's reverb.
CH DELAY (Channel Delay)	
0–50ms	Adjusts the time that the overall sound in Channel A (or B) is delayed. Although this is normally set to 0 ms, you can produce greater breadth along with a chorus effect by setting a difference in the time the sounds are played relative to the sounds from Channel B.

PATCH LEVEL

Parameter/ Range	Explanation
A/B BAL (A/B Balance)	
A0:100B–A100:0B	Adjusts the volume balance of Channel A and Channel B. You can set this parameter in the Mixer screen or with the BALANCE knob. This parameter is disabled when DYNAMIC is on.
PATCH LEVEL	
0–200	Adjusts the overall patch volume.

TOTAL EQ

This adjusts the tone of the mixed signals from Channel A and Channel B.

Parametric EQ is used for the low-middle and high-middle frequency ranges.

Parameter/ Range	Explanation
EQ SW (Equalizer Switch)	
OFF, ON	Turns the EQ effect on/off.
TOTAL GAIN	
-12–+12dB	Adjusts the volume before the equalizer.
LOW GAIN	
-12–+12dB	Adjusts the low frequency range tone.
HIGH GAIN	
-12–+12dB	Adjusts the high frequency range tone.
LOW MID FREQ (Low Middle Frequency)	
20Hz–10.0kHz	Specifies the center of the frequency range that will be adjusted by the LOW MID GAIN.
LOW MID Q (Low Middle Q)	
0.5–16	Adjusts the width of the area affected by the EQ centered at the LOW MID FREQ. Higher values will narrow the area.
LOW MID GAIN (Low Middle Gain)	
-12–+12dB	Adjusts the low-middle frequency range tone.
HIGH MID FREQ (High Middle Frequency)	
20Hz–10.0kHz	Specifies the center of the frequency range that will be adjusted by the HIGH MID GAIN.
HIGH MID Q (High Middle Q)	
0.5–16	Adjusts the width of the area affected by the EQ centered at the HIGH MID FREQ. Higher values will narrow the area.
HIGH MID GAIN (High Middle Gain)	
-12–+12dB	Adjusts the high-middle frequency range tone.

OUTPUT

This setting determines which signals are output at each output and the level at which they are output.

Parameter/Range	Explanation
MAIN OUT	
This switches the signals output from the MAIN OUT.	
CH A	This outputs Channel A. This output also reflects the mixer's MIX SW, PAN, LEVEL, and A/B BAL settings.
CH B	This outputs Channel B. This output also reflects the mixer's MIX SW, PAN, LEVEL, and A/B BAL settings.
MIXER (DRY)	This outputs the post-A/B mix signals before application of DELAY/REVERB.
MIXER	This outputs the post-A/B mix signals after application of DELAY/REVERB and TOTAL EQ.
MAIN LEVEL	
0–200	Adjusts the volume the output to the MAIN OUT.
SUB OUT	
This switches the signals output from the SUB OUT.	
CH A	This outputs Channel A. This output also reflects the mixer's MIX SW, PAN, LEVEL, and A/B BAL settings.
CH B	This outputs Channel B. This output also reflects the mixer's MIX SW, PAN, LEVEL, and A/B BAL settings.
MIXER (DRY)	This outputs the post-A/B mix signals before application of DELAY/REVERB.
MIXER	This outputs the post-A/B mix signals after application of DELAY/REVERB and TOTAL EQ.
SUB LEVEL	
0–200	Adjusts the volume the output to the SUB OUT.

Parameter/Range	Explanation
D OUT (Digital Output)	
This switches the signals output from the DIGITAL OUT.	
COSM GTR A	This outputs the sounds from COSM GTR A.
COSM GTR B	This outputs the sounds from COSM GTR B.
NORMAL PU	This outputs the sounds from the normal pickup.
CH A	This outputs Channel A. This output also reflects the mixer's MIX SW, PAN, LEVEL, and A/B BAL settings.
CH B	This outputs Channel B. This output also reflects the mixer's MIX SW, PAN, LEVEL, and A/B BAL settings.
MIXER (DRY)	This outputs the post-A/B mix signals before application of DELAY/REVERB.
MIXER	This outputs the post-A/B mix signals after application of DELAY/REVERB and TOTAL EQ.
MAIN OUT	This outputs the same signals as those from MAIN OUT.
SUB OUT	This outputs the same signals as those from SUB OUT.
D OUT LEVEL (Digital Output Level)	
0–200	Adjusts the volume the output to the DIGITAL OUT.

* The parameters enabled (MAIN OUT, MAIN LEVEL, SUB OUT, SUB LEVEL, D OUT, D OUT LEVEL) change according to the settings in "OUTPUT MODE" (p. 172) in the SYSTEM screen. When disabled, the value < > is given.

DELAY/REVERB

You can apply delay and reverb jointly to Channel A and Channel B.

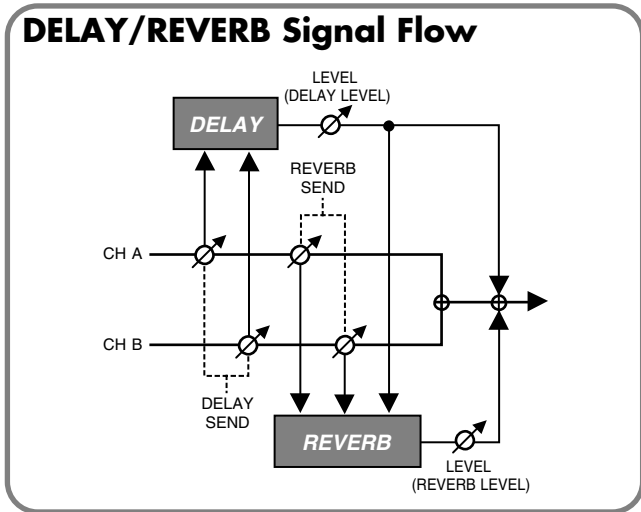

DELAY

Parameter/Range	Explanation
DELAY SW	
OFF, ON	Turns the DELAY effect on/off.
TIME	
1–1800 ms, BPM ♪ –BPM ○	This determines the delay time.
When set to BPM, the value of each parameter will be set according to the value of the BPM (p. 163) specified for each patch. This makes it easier to achieve effect sound settings that match the tempo of the song.	
<ul style="list-style-type: none"> * If, due to the tempo, the time is longer than the range of allowable settings, it is then synchronized to a period either 1/2 or 1/4 of that time. * After setting DELAY TIME to BPM (♪ – ○), if you tap [F2] (TAP), the BPM value will change to match the timing of your tapping. 	
FEED BACK	
0–100	Adjusts the amount of feedback.
Feedback is returning a delay signal to the input. A higher value will increase the number of the delay repeats.	
HIGH CUT (High Cut Filter)	
700 Hz–11.0 kHz, FLAT	This sets the frequency at which the high cut filter begins to take effect.
This allows you to get a mild effect sound by cutting the high-end component above the set frequency. When it is set to FLAT, the high cut filter is off or has no effect.	
LEVEL	
0–120	Adjusts the volume of the direct sound.

REVERB

Parameter/Range	Explanation
REVERB SW	
OFF, ON	Turns the REVERB effect on/off.
TYPE	
This selects the reverb type. Various different simulations of space are offered.	
AMB (AMBIENCE)	Simulates an ambience mic (off-mic, placed at a distance from the sound source) used in recording and other applications. Rather than emphasizing the reverberation, this reverb is used to produce a sense of openness and depth.
ROOM	Simulates the reverberation in a small room. Provides warm reverberations.
HALL1	Simulates the reverberation in a concert hall. Provides clear and spacious reverberations.
HALL2	Simulates the reverberation in a concert hall. Provides warm reverberations.
PLATE	Simulates plate reverberation (a reverb unit that uses the vibration of a metallic plate). Provides a metallic sound with a distinct upper range.
TIME	
0.1 s–10.0 s	Adjusts the length (time) of reverberation.
PRE DELAY	
0 ms–100 ms	Adjusts the time until the reverb sound appears.
LOW CUT (Low Cut Filter)	
FLAT, 55 Hz–800 Hz	This sets the frequency at which the low cut filter begins to take effect. This lets you cut the low-end component below the set frequency to create a clear, distinct low end, thereby bringing out the high end of the effect. When Flat is selected, the low cut filter will have no effect.
HIGH CUT (High Cut Filter)	
700 Hz–11 kHz, FLAT	This sets the frequency at which the high cut filter begins to take effect. This allows you to get a mild effect sound by cutting the high-end component above the set frequency. When Flat is selected, the high cut filter will have no effect.
DENS	
0–10	Adjusts the density of the reverb sound.
LEVEL	
0–100	Adjusts the volume of the reverb sound.

DYNAMIC

This function allows you use your picking dynamics to control the volume of the mix of the two channels. The volume and balance of the channels change according to the dynamics each time you pick the strings. You can set the point at which the volume changes in the settings screen as you check the dynamics level shown by the meter.

MEMO

The A/B BAL setting is disabled when DYNAMIC is switched on.

Parameter/Range	Explanation
DYNA SW	
OFF, ON	This setting switches DYNAMIC on and off.
TYPE	
This sets the DYNAMIC type. This setting determines the channel for which the volume is controlled with the picking dynamics.	
DYNA A	Channel A's volume level is controlled. The volume in Channel B is fixed.
DYNA B	Channel B's volume level is controlled. The volume in Channel A is fixed.
DYNA BAL (DYNA Balance)	The volume levels of both Channel A and Channel B (the balance) is controlled.
LOWER LEV (Lower Level) *1	
0-100	Adjusts the volume of the sounds played softly. You can adjust the A level when DYNA A is used and the B level when DYNA B is used.
LOWER BAL (Lower Balance) *2	
0:100-100:0	Adjusts the balance between Channel A and B when sounds are played softly.
LOWER RNG (Lower Range)	
0-99	This sets the point at which the strength of the picking begins to change from the soft sound's volume (or balance) to the louder sounds' volume (or balance). When the volume is below the set point, the volume (or balance) switches to that set in either LOWER LEV or LOWER BAL in accordance with the TYPE setting.
UPPER LEV (Upper Level) *1	
0-100	Adjusts the volume of the sounds played loudly. You can adjust the A level when DYNA A is used and the B level when DYNA B is used.
UPPER BAL (Upper Balance) *2	
0:100-100:0	Adjusts the balance between Channel A and B when sounds are played loudly.
UPPER RNG (Upper Range)	
1-100	This sets the point at which the strength of the picking begins to change from the loud sound's volume (or balance) to the softer sounds' volume (or balance). When the volume is above the set point, the volume (or balance) switches to that set in either LOWER LEV or LOWER BAL in accordance with the TYPE setting.

Parameter/Range	Explanation
RELEASE	
0-100	This adjust the rate of the response when the input level drops.

- *1 Setting available when TYPE is set to DYNA A or DYNA B.
- *2 Setting available when TYPE is set to DYNA BAL.

TIP

With DYNAMIC, when a new note is detected, the peak level at the instant the string is picked (i.e., the picking dynamics) is held momentarily, and control of the channel volume or balance is based on that value.

The picking dynamics controls the sound as described below.

- When the level is at or below the LOWER RNG setting, the picking controls the volume or balance of the softer sounds set in LOWER LEV (when TYPE is set to DYNA A or DYNA B) or LOWER BAL (when TYPE is set to DYNA BAL).
- When the level is at or above the UPPER RNG setting, the picking controls the volume or balance of the louder sounds set in UPPER LEV (when TYPE is set to DYNA A or DYNA B) or UPPER BAL (when TYPE is set to DYNA BAL).
- When the level is between these settings, the picking controls the volume or balance between the softer sounds and louder sounds described above (continuously changing the level according to the dynamics). Changes made to the above parameters are indicated in the graph in the settings screen.

When TYPE is set to DYNA A or DYNA B

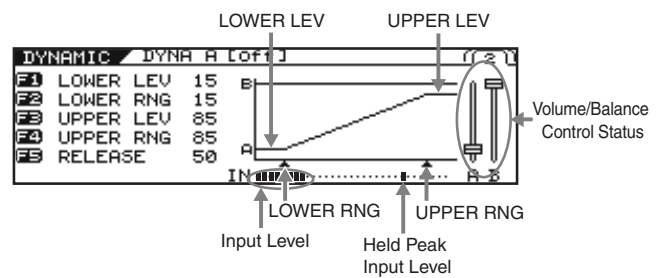

When TYPE is set to DYNA BAL

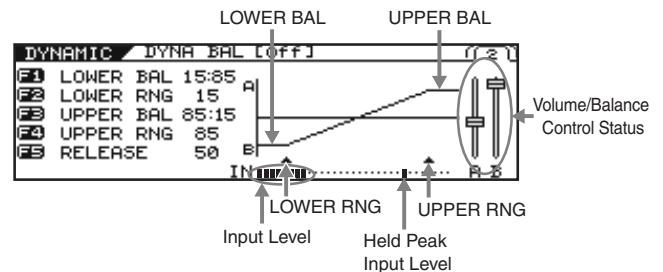

Changes made to the above parameters are indicated in the graph in the settings screen.

The input level and held peak input level are indicated beneath the graph display. Making these settings is easier by actually picking the strings as you watch the meter and adjust the LOWER RNG and UPPER RNG settings.

In addition, you can confirm the volume/balance control status with the fader displayed to the right of the graph.

MASTER

CONTROL ASSIGN

Adjust these settings if you would like to use a pedal connected to the VG-99, or an external MIDI device (control source) to control parameters as you play.

You can set two parameters as targets to each control source.

* Turn on the COSM guitar, COSM amp, and effect that contains the parameter you wish to control.

GK VOL (GK Volume)

Parameter/Range	Explanation
SW (Switch)	
OFF, ON	This setting switches GK VOL on and off.
TARGET PARAMETER	
This selects the parameter to be changed. Refer to "TARGET PARAMETER" (p. 157).	
MIN (Minimum)	
This sets the minimum value for the range in which the parameter can change. The value differs depending on the parameter assigned for TARGET PARAMETER.	
MAX (Maximum)	
This sets the maximum value for the range in which the parameter can change. The value differs depending on the parameter assigned for TARGET PARAMETER.	
RANGE LOW, RANGE HIGH	
Low: 0-126 High: 1-127	You can set the controllable range for target parameters within the GK Volume's operational range. Target parameters are controlled within the range set with RANGE LOW and RANGE HIGH. You should normally set RANGE LOW to 0 and RANGE HIGH to 127.

GK S1, S2 (DOWN/S1, UP/S2 Switch)

Parameter/Range	Explanation
SW (Switch)	
OFF, ON	This setting determines whether control using DOWN/S1 and UP/S2 is switched on or off.
TARGET PARAMETER	
This selects the parameter to be changed. Refer to "TARGET PARAMETER" (p. 157).	
MIN (Minimum)	
This sets the minimum value for the range in which the parameter can change. The value differs depending on the parameter assigned for TARGET PARAMETER.	
MAX (Maximum)	
This sets the maximum value for the range in which the parameter can change. The value differs depending on the parameter assigned for TARGET PARAMETER.	
MODE	
Specify how the value will change in response to an operation.	
* When the DOWN/S1, UP/S2 POS1 of the GK SETTING is set to REVRSE position, the function of DOWN/S1, UP/S2 will be reversed.	
* When KEY/BPM/AMPCTL:BPM TAP, FX-DELAY(HOLD)-REC, or FX-DELAY(HOLD)-STOP is set for the TARGET PARAMETER, control is available regardless of whether DOWN/S1 or UP/S2 is pressed. In this case, the MODE setting is disabled.	
S1: DEC S2: INC	S1 will decrease the value, and S2 will increase it.
S1: INC S2: DEC	S2 will decrease the value, and S1 will increase it.
S1: MIN S2: MAX	The value will be at MIN when S1 is pressed. The value will be at MAX when S2 is pressed.
S1: MAX S2: MIN	The value will be at MAX when S1 is pressed. The value will be at MIN when S2 is pressed.

PANEL CTL1/CTL2 (Control Button 1/2)

Parameter/Range	Explanation
SW (Switch)	
OFF, ON	This setting switches CONTROL button on and off.
TARGET PARAMETER	
This selects the parameter to be changed. Refer to "TARGET PARAMETER" (p. 157).	
MIN (Minimum)	
This sets the minimum value for the range in which the parameter can change. The value differs depending on the parameter assigned for TARGET PARAMETER.	
MAX (Maximum)	
This sets the maximum value for the range in which the parameter can change. The value differs depending on the parameter assigned for TARGET PARAMETER.	
* While you can set two different target parameters each to CTL1 and CTL2, the CTL1 and CTL2 buttons light when the value set in MAX for the first parameter set to either one is reached.	
SW MODE (Switch Mode)	
This sets the behavior of the value each time the switch is operated.	
MOMENT	The setting is normally OFF (minimum value), switching to ON (maximum value) while the CONTROL button is held down.
LATCH	The setting alternately switches to OFF (minimum value) and ON (maximum value) each time the CONTROL button is pressed.

D BEAM

PITCH

Parameter/Range	Explanation
PITCH TYPE	
This selects the effect applied when [PITCH] is pressed.	
T-ARM	This feature changes the pitch of the COSM guitar as a tremolo arm does. Use of a tremolo arm can be simulated by holding your guitar neck or hand over the D BEAM controller.
FREEZE	This continuously holds the sound of the COSM guitar. You can switch the FREEZE effect on and off by holding your guitar neck or hand over the D BEAM controller.

Parameter/Range	Explanation
T-ARM CH (Tremolo Arm Channel)	
This selects the channel to which the tremolo T-ARM is applied.	
A	T-ARM is applied only to Channel A.
B	T-ARM is applied only to Channel B.
A+B	T-ARM is applied to both Channel A and B.
TYPE	
This selects the T-ARM type.	
S-TYPE	This simulates the characteristics of a synchronized-type tremolo arm on the Fender Stratocaster.
B-TYPE	This simulates a Bigsby-type tremolo arm on the Gibson or the Rickenbacker.
F-TYPE	This simulates the characteristics of a Floyd Rose's locking-type tremolo arm.
TRANS	This simulates how a Trans-tremolo type arm changes the pitch of all the strings equally.
DOWN MIN (Down Minimum)	
-50+50 (S-TYPE, B-TYPE, F-TYPE)	This sets the pitch when T-ARM is first activated (the minimum value). Setting a negative value causes the pitch to rise, while positive values produce lowered pitches.
-24+24 (TRANS)	
DOWN MAX (Down Maximum)	
-50+50 (S-TYPE, B-TYPE, F-TYPE)	This sets the pitch when T-ARM is most fully applied (the maximum value). Setting a negative value causes the pitch to rise, while positive values produce lowered pitches.
-24+24 (TRANS)	

Parameter/Range	Explanation
FREEZE CH (Freeze Channel)	
This selects the channel to which the FREEZE effect is applied.	
A	FREEZE is applied only to Channel A.
B	FREEZE is applied only to Channel B.
A+B	FREEZE is applied to both Channel A and B.
ATTACK	
0-100	This sets the attack time for the FREEZE sound when FREEZE is switched on. Raising the value increases the attack time.
REL (Release)	
0-100	This sets the time for the FREEZE sound to be released when FREEZE is switched off. Raising the value increases the attack time.
LEVEL	
0-100	This sets the volume level of the freeze sound. The volume increases as the value is raised.
DIRECT	
0-100	This sets the volume level of the direct sound. The volume increases as the value is raised.

FILTER

This passes only portions of the sound's frequency ranges, giving the sound a unique tone. You can add different types of expression to the sound by changing the frequencies (pitches) that are passed.

Parameter/Range	Explanation
FILTER CH (Filter Channel)	
This selects the channel to which the filter is applied.	
A	The filter is applied only to Channel A.
B	The filter is applied only to Channel B.
A+B	The filter is applied to both Channel A and B.
TYPE	
This selects the filter type.	
LPF	This filter passes only the low frequencies.
BPF	This filter passes frequencies only in the specified range.
HPF	This filter passes only the high frequencies.
FREQ MIN (Frequency Minimum)	
0-100	This sets the frequency when the filter is first activated. Higher frequencies are set as the value is raised.
FREQ MAX (Frequency Maximum)	
0-100	This sets the frequency when the filter is most fully applied (the maximum value). Higher frequencies are set as the value is raised.
RESO (Resonance)	
0-100	Adjusts the amount of filter resonance (distinctiveness of the sound) used. Raising the value strengthens the characteristic coloring of the tone.

Parameter/Range	Explanation
LEVEL	
0-100	Adjusts the volume level. Raising the value increases the volume.

ASSIGNABLE

Parameter/Range	Explanation
SW (Switch)	
OFF, ON	This setting switches D BEAM ASSIGNABLE on and off.
TARGET PARAMETER	
This selects the parameter to be changed. Refer to "TARGET PARAMETER" (p. 157).	
MIN (Minimum)	
This sets the minimum value for the range in which the parameter can change. The value differs depending on the parameter assigned for TARGET PARAMETER.	
MAX (Maximum)	
This sets the minimum value for the range in which the parameter can change. The value differs depending on the parameter assigned for TARGET PARAMETER.	
RANGE LOW, RANGE HIGH	
Low: 0-126 High: 1-127	You can set the range for control of target parameters within the D BEAM controller's response range. Target parameters are controlled within the range set with RANGE LOW and RANGE HIGH. You should normally set RANGE LOW to 0 and RANGE HIGH to 127.

RIBBON

PITCH

Parameter/Range	Explanation
T-ARM CH (T-ARM Channel)	
This selects the channel to which the tremolo T-ARM is applied.	
A	T-ARM is applied only to Channel A.
B	T-ARM is applied only to Channel B.
A+B	T-ARM is applied to both Channel A and B.
TYPE	
This selects the T-ARM type.	
S-TYPE	This simulates the Tremolo arm on a Strat-type guitar
B-TYPE	This simulates a Bigsby-type tremolo arm.
F-TYPE	This simulates the characteristics of a Floyd Rose-type tremolo arm.
TRANS	This simulates how a Trans-tremolo type arm changes the pitch of all the strings equally.
DOWN MIN (Down Minimum)	
-50+50 (S-TYPE, B-TYPE, F-TYPE)	This sets the pitch when the RIBBON CONTROLLER is pressed at the end closest to the front. Setting a negative value raises the pitch, while setting a positive value lowers the pitch.
-24+24 (TRANS)	
DOWN MAX (Down Maximum)	
-50+50 (S-TYPE, B-TYPE, F-TYPE)	This sets the pitch when the RIBBON CONTROLLER is pressed at the end farthest from the front. Setting a negative value raises the pitch, while setting a positive value lowers the pitch.
-24+24 (TRANS)	

FILTER

This passes only portions of the sound's frequency ranges, giving the sound a unique tone. You can add different types of expression to the sound by changing the frequencies (itches) that are passed.

Parameter/Range	Explanation
FILTER CH (Filter Channel)	
This selects the channel to which the filter is applied.	
A	The filter is applied only to Channel A.
B	The filter is applied only to Channel B.
A+B	The filter is applied to both Channel A and B.
TYPE	
This selects the filter type.	
LPF	This filter passes only the low frequencies.
BPF	This filter passes frequencies only in the specified range.
HPF	This filter passes only the high frequencies.
FREQ MIN (Frequency Minimum)	
0-100	This sets the frequency when the RIBBON CONTROLLER is touched at the end closest to the front (the minimum value). Raising the value increases the set frequency.

Parameter/Range	Explanation
FREQ MAX (Frequency Maximum)	
0-100	This sets the frequency when the RIBBON CONTROLLER is touched at the end away from the front (the maximum value). Raising the value increases the set frequency.
RESO (Resonance)	
0-100	Adjusts the amount of filter resonance (distinctiveness of the sound) used. Raising the value strengthens the characteristic coloring of the tone.
LEVEL	
0-100	Adjusts the volume level. Raising the value increases the volume.

ASSIGNABLE

Parameter/Range	Explanation
SW (Switch)	
OFF, ON	This setting switches RIBBON ASSIGNABLE on and off.
TARGET PARAMETER	
This selects the parameter to be changed. Refer to "TARGET PARAMETER" (p. 157).	
MIN (Minimum)	
This sets the minimum value for the range in which the parameter can change. The value differs depending on the parameter assigned for TARGET PARAMETER.	
MAX (Maximum)	
This sets the maximum value for the range in which the parameter can change. The value differs depending on the parameter assigned for TARGET PARAMETER.	
RANGE LOW, RANGE HIGH	
Low: 0-126 High: 1-127	You can set the range for control of target parameters within the RIBBON CONTROLLER's response range. Target parameters are controlled within the range set with RANGE LOW and RANGE HIGH. You should normally set RANGE LOW to 0 and RANGE HIGH to 127.

EXP PEDAL (Expression Pedal)

Parameter/Range	Explanation
SW (Switch)	
OFF, ON	This setting determines whether control using an expression pedal connected to the EXP PEDAL jack is switched on or off.
TARGET PARAMETER	
This selects the parameter to be changed. Refer to “ TARGET PARAMETER ” (p. 157).	
MIN (Minimum)	
This sets the minimum value for the range in which the parameter can change. The value differs depending on the parameter assigned for TARGET PARAMETER.	
MAX (Maximum)	
This sets the minimum value for the range in which the parameter can change. The value differs depending on the parameter assigned for TARGET PARAMETER.	
RANGE LOW, RANGE HIGH	
Low: 0–126 High: 1–127	You can set the range for control of target parameters within an expression pedal’s response range. Target parameters are controlled within the range set with RANGE LOW and RANGE HIGH. You should normally set RANGE LOW to 0 and RANGE HIGH to 127.

CTL3, CTL4 (Control3, Control4)

Parameter/Range	Explanation
SW (Switch)	
OFF, ON	This setting determines whether control using a footswitch connected to the CTL3, CTL4 jack is switched on or off.
TARGET PARAMETER	
This selects the parameter to be changed. Refer to “ TARGET PARAMETER ” (p. 157).	
MIN (Minimum)	
This sets the minimum value for the range in which the parameter can change. The value differs depending on the parameter assigned for TARGET PARAMETER.	
MAX (Maximum)	
This sets the minimum value for the range in which the parameter can change. The value differs depending on the parameter assigned for TARGET PARAMETER.	
SW MODE (Switch Mode)	
This sets the behavior of the value each time the switch is operated.	
MOMENT	The setting is normally OFF (minimum value), switching to ON (maximum value) while the footswitch is held down.
LATCH	The setting alternately switches to OFF (minimum value) and ON (maximum value) each time the footswitch is pressed.

FC-300 CONTROL

The controllers (sources) controlling targets when a FC-300 is connected are shown below.

Source	Explanation
FC-300 EXP1 *1	FC-300 expression pedal1
FC-300 EXPSW1 *2	FC-300 expression pedal switch1
FC-300 EXP2 *1	FC-300 expression pedal2
FC-300 EXPSW2 *2	FC-300 expression pedal switch2
FC-300 CTL1 *2	FC-300 control pedal1
FC-300 CTL2 *2	FC-300 control pedal2
FC-300 E3/C3 *3	FC-300 external expression pedal3/external footswitch3
FC-300 CTL4 *2	FC-300 external footswitch4
FC-300 E4/C5 *3	FC-300 external expression pedal4/external footswitch5
FC-300 CTL6 *2	FC-300 external footswitch6
FC-300 E5/C7 *3	FC-300 external expression pedal5/external footswitch7
FC-300 CTL8 *2	FC-300 external footswitch8



- *1 The types of parameters that can be set are the same as those described in “**EXP PEDAL (Expression Pedal)**” (p. 154).
- *2 The types of parameters that can be set are the same as those described in “**CTL3, CTL4 (Control3, Control4)**” (p. 154).
- *3 When an expression pedal is connected, the types of parameters that can be set are the same as those described in “**EXP PEDAL (Expression Pedal)**” (p. 154); when a footswitch is connected, the types of parameters that can be set are the same as those described in “**CTL3, CTL4 (Control3, Control4)**” (p. 154).

ASSIGN 1-16

You can freely assign functions to the VG-99's and FC-300's controllers.

Parameter/Range	Explanation
SOURCE	
This selects the controller to which the function is assigned.	
GK VOL	GK-3 GK volume knob
GK S1	GK-3 DOWN/S1 switch
GK S2	GK-3 UP/S2 switch
CTL1	Control button1
CTL2	Control button2
EXP PEDAL	Expression pedal connected to the EXP PEDAL jack
D BEAM V	D BEAM vertical movements
D BEAM H	D BEAM horizontal movements
RIBBON ACT	RIBBON CONTROLLER touch
RIBBON POS	RIBBON CONTROLLER position
CTL3	Footswitch connected to the CTL3,4 jack (jack tip)
CTL4	Footswitch connected to the CTL3,4 jack (jack ring)
FC-300 EXP1	FC-300 expression pedal1
FC-300 EXPSW1	FC-300 expression pedal switch1
FC-300 EXP2	FC-300 expression pedal2
FC-300 EXPSW2	FC-300 expression pedal switch2
FC-300 CTL1	FC-300 control pedal1
FC-300 CTL2	FC-300 control pedal2
FC-300 E3/C3	FC-300 external expression pedal3/external footswitch3
FC-300 CTL4	FC-300 external footswitch4
FC-300 E4/C5	FC-300 external expression pedal4/external footswitch5
FC-300 CTL6	FC-300 external footswitch6
FC-300 E5/C7	FC-300 external expression pedal5/external footswitch7
FC-300 CTL8	FC-300 external footswitch8
INTRNL PEDAL	Internal pedal
WAVE PEDAL	Wave pedal
INPUT LEVEL	Input level
CC	Control change
SW (Switch)	
OFF, ON	This setting switches the VG-99's and FC-300's controllers on and off.
TARGET PARAMETER	
This selects the parameter to be changed. Refer to “ TARGET PARAMETER ” (p. 157).	
MIN (Minimum)	
This sets the minimum value for the range in which the parameter can change. The value differs depending on the parameter assigned for TARGET PARAMETER.	

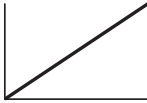
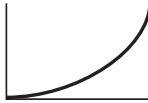
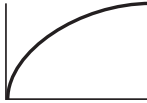
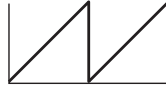
Parameter/Range	Explanation
MAX (Maximum)	
This sets the minimum value for the range in which the parameter can change. The value differs depending on the parameter assigned for TARGET PARAMETER.	
SW MODE (Switch Mode)	
This sets the behavior of the value each time the switch is operated.	
MOMENT	The setting is normally OFF (minimum value), switching to ON (maximum value) while the footswitch is held down.
LATCH	The setting alternately switches to OFF (minimum value) and ON (maximum value) each time the footswitch is pressed.
RANGE LOW, RANGE HIGH	
Low: 0-126 High: 1-127	You can set the controllable range for target parameters within the source's operational range. Target parameters are controlled within the range set with RANGE LOW and RANGE HIGH. You should normally set RANGE LOW to 0 and RANGE HIGH to 127.
TRIGGR (Trigger)	
This sets the trigger that activates the internal pedal. *1	
PATCH CHANGE	Functions when patches are switched.
GK VOL	Functions when the divided pickup's volume knob is adjusted.
GK S1, S2	Functions when the divided pickup's DOWN/S1 or UP/S2 switch position is changed.
CTL1-CTL4	Functions when the CTL 1, 2 buttons or foot switch connected to CTL 3,4 jack are operated.
EXP	Functions when the expression pedal connected to EXP PEDAL jack are operated.
D BEAM V, H	Functions when the vertical or horizontal position is detected by the D Beam controller.
RIBBON ACT, POS	Functions when the ribbon controller is operated by touch or when the position is detected.
FC-300 EXP1, EXP2	Functions when the FC-300's EXP PEDAL 1 or 2 is operated.
FC-300 CTL1, CTL2	Functions when the FC-300's CTL1 or CTL2 is operated.
FC-300 E3/C3, CTL4, E4/C5, CTL6, E5/C7, CTL8	Functions when a pedal connected to the FC-300's E3/C3, CTL4, E4/C5, CTL6, E5/C7, or CTL8 jacks is operated.
TIME	
0-100	Adjusts the amount of time for the internal pedal to shift from the fully released position (pedal toe raised) to the fully depressed position (pedal toe pressed down). *1

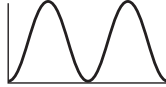
Parameter/Range	Explanation
CURVE	
This selects one of the three types that determines how the internal pedal should change. *1	
<div style="display: flex; justify-content: space-around; text-align: center;"> <div> <p>LINEAR</p>  </div> <div> <p>SLOW RISE</p>  </div> <div> <p>FAST RISE</p>  </div> </div>	
RATE	
0-100	This determines the time spend for one cycle of the wave pedal. *2
FORM	
This selects one of the three types that determines how the wave pedal should change. *2	
<div style="display: flex; justify-content: space-around; text-align: center;"> <div> <p>SAW</p>  </div> <div> <p>TRI</p>  </div> <div> <p>SIN</p>  </div> </div>	
INPUT SENS	
0-100	This adjusts the input sensitivity when INPUT LEVEL is selected for SOURCE. *3

- *1 The TRIGGR, TIME, and CURVE parameters are enabled when the SOURCE parameter is set to INT PEDAL.
- *2 The RATE and FORM parameters are enabled when the SOURCE parameter is set to WAVE PEDAL.
- *3 The INPUT SENS parameter is enabled when the SOURCE parameter is set to INPUT LEVEL.

DIRECT EDIT F1-F6

Parameter/Range	Explanation
This assigns functions to the function buttons operable in the Play screen and the [F1]-[F6] or F1-F6 knobs.	
TARGET PARAMETER	
This selects the parameter to be changed. Refer to "TARGET PARAMETER" (p. 157).	

TARGET PARAMETER

Parameter (F4)	Parameter (F5)	Parameter (F6)		
KEY/BPM/ AMPCTL	-	KEY		
		BPM		
		BPM TAP		
		FC AMP CTL1		
		FC AMP CTL2		
		V-LINK SW		
D BEAM	SELECT			
	PITCH TYPE			
	T-ARM	SW		
		CONTROL		
		T-ARM CH		
		TYPE		
	T-ARM (S/B/F)	DOWN MIN		
		DOWN MAX		
	T-ARM (TRANS)	DOWN MIN		
		DOWN MAX		
	FREEZE	SW		
		FREEZE CH		
	FREEZE (A) FREEZE (B)	ATTACK		
		REL		
		LEVEL		
		DIRECT		
	FILTER	SW		
		CONTROL		
		FILTER CH		
		TYPE		
		FREQ MIN		
		FREQ MAX		
		RESO		
		LEVEL		
		RIBBON	SELECT	
			T-ARM	SW
	CONTROL			
	T-ARM CH			
	TYPE			
	T-ARM (S/B/F)		DOWN MIN	
DOWN MAX				
T-ARM (TRANS)	DOWN MIN			
	DOWN MAX			
FILTER	SW			
	CONTROL			
	FILTER CH			
	TYPE			
	FREQ MIN			
	FREQ MAX			
	RESO			
	LEVEL			

Parameter (F4)	Parameter (F5)	Parameter (F6)
ALT TUNE	AB LINK	
	[A] TUNING/ [B] TUNING	TUNING SW TYPE
	[A] BEND/ [B] BEND	BEND SW BEND
	[A] 12STRING/ [B] 12STRING	12STRING SW
		SHIFT 1st-6th
		FINE 1st-6th
		LEVEL 1st-6th DELAY 1st-6th
	[A] DETUNE/ [B] DETUNE	DETUNE SW 1st-6th
	[A] HARMONIST/ [B] HARMONIST	HARMO SW HARMO
	[A] COSM GTR/ [B] COSM GTR	COMMON
E.GTR		E.GTR TYPE
		PU SEL
		VOL
		TOPE
E.GTR VARI		STRING
		VOL CURVE
		PHASE
E.GTR REAR PU		TYPE
		POS ANGLE
E.GTR FRONT PU		TYPE
		POS ANGLE
AC TYPE		
AC STEEL		BODY TYPE
		BODY
		TOPE LEVEL
AC NYLON		BODY
		ATTACK
		TOPE LEVEL
		AC SITAR
SENS		
BODY		
COLOR		
DECAY		
BUZZ		
ATTACK LEVEL		
TOPE		
LEVEL		
AC BANJO	ATTACK	
	RESO	
	TOPE	
	LEVEL	

Parameter (F4)	Parameter (F5)	Parameter (F6)	
[A] COSM GTR/ [B] COSM GTR	AC RESO	SUSTAIN	
		RESO	
		TONE	
		LEVEL	
	AC VARI	BODY TYPE	
		SIZE	
		RESO	
		ATTACK	
		BODY	
		LOW CUT	
		LEVEL	
		PU TYPE	
		PU TONE	
		PU LEVEL	
		BASS	BASS TYPE
			REAR VOL
	FRONT VOL		
	(MASTER) VOL		
		TONE	
	SYNTH TYPE	-	
	SYNTH GR-300	MODE	
		LEVEL	
		COMP	
		CUTOFF FREQ	
		RESO	
		ENV MOD SW	
		SENS	
		ATTACK	
		PITCH A	
		FINE A	
		PITCH SW	
		PITCH B	
		FINE B	
		DUET	
		SWEEP SW	
		SWEEP RISE	
		SWEEP FALL	
		VIBRATO SW	
		VIBRATO RATE	
		VIBRATO DEPTH	
	SYNTH BOWED	FILTER CUTOFF	
		FILTER RESO	
		TOUCH SENS	
		POWER BEND	
		POWER BEND Q	
	SUSTAIN		
	SYNTH DUAL	FILTER CUTOFF	
		FILTER RESO	
		TOUCH SENS	
		GLIDE SENS	
GLIDE TIME			
SUSTAIN			

Parameter (F4)	Parameter (F5)	Parameter (F6)
[A] COSM GTR/ [B] COSM GTR	SYNTH FILTBASS	FILTER CUTOFF
		FILTER RESO
		TOUCH SENS
		FILTER DECAY
		COLOR
	SYNTH PIPE	FILTER CUTOFF
		FILTER RESO
		TOUCH SENS
		POWER BEND
		POWER BEND Q
		SUSTAIN
	SYNTH SOLO	FILTER CUTOFF
		FILTER RESO
		TOUCH SENS
		COLOR
		SUSTAIN
	SYNTH PWM	FILTER CUTOFF
		FILTER RESO
		TOUCH SENS
		PWM DEPTH
		PWM RATE
		SUSTAIN
	SYNTH CRYSTAL	ATTACK LENGTH
		MOD TUNE
		MOD DEPTH
		ATTACK LEVEL
		BODY LEVEL
		SUSTAIN
	SYNTH ORGAN	FEET 16
		FEET 8
		FEET 4
		SUSTAIN
	SYNTH BRASS	FILTER CUTOFF
		FILTER RESO
		TOUCH SENS
		SUSTAIN
	SYNTH WAVE	WAVE SHAPE
		WAVE SENS
		WAVE ATTACK
		WAVE DECAY
WAVE LEVEL		
CUTOFF		
RESO		
FILTER TYPE		
FILTER ATTACK		
FILTER DECAY		
FILTER DEPTH		

Parameter (F4)	Parameter (F5)	Parameter (F6)	
[A] COSM GTR/ [B] COSM GTR	EQ	EQ SW	
		LOW GAIN	
		HIGH GAIN	
		LOW MID FREQ	
		LOW MID Q	
		LOW MID GAIN	
		HIGH MID FREQ	
		HIGH MID Q	
		HIGH MID GAIN	
		TOTAL GAIN	
		STRING PAN	1st-6th
	STRING LEVEL	1st-6th	
	MIX LEVEL	COSM GUITAR	
NORMAL PU			
NS	SW		
	THRSH		
	REL		
POLY FX	COMMON	POLY FX SW	
		TYPE	
		POLY FX CH	
	POLY COMP	COMP TYPE	
		SUSTAIN	
		ATTACK	
		THRSH	
		REL	
		TONE	
		LEVEL	
		COMP BAL	
	POLY DIST	MODE	
		DRIVE	
		HIGH CUT	
		POLY BAL	
		DRIVE BAL	
		LEVEL	
	POLY OCTAVE	-1OCT 1st-6th	
		-2OCT 1st-6th	
		DIRECT 1st-6th	
	POLY SLOW GEAR	RISE TIME	
		SENS	
	[A] FX/[B] FX	COMP	COMP SW
			TYPE
			SUSTAIN
			ATTACK
			THRSH
REL			
TONE			
LEVEL			

Parameter (F4)	Parameter (F5)	Parameter (F6)	
[A] FX/[B] FX	OD/DS	OD/DS SW	
		TYPE	
		DRIVE	
		BOTTOM	
		TONE	
		EFFECT LEVEL	
		DIRECT LEVEL	
		OD/DS (CUSTOM)	TYPE
		BOTTOM	
		TOP	
		LOW	
		HIGH	
	WAH	WAH SW	
		TYPE	
		PEDAL POS	
		LEVEL	
	WAH (CUSTOM)	TYPE	
		Q	
		RANGE LOW	
		RANGE HIGH	
		PRESENCE	
	EQ	EQ SW	
		LOW GAIN	
		HIGH GAIN	
		LOW MID FREQ	
		LOW MID Q	
		LOW MID GAIN	
		HIGH MID FREQ	
		HIGH MID Q	
		HIGH MID GAIN	
LOW CUT			
HIGH CUT			
TOTAL GAIN			
DELAY	DELAY SW		
	TYPE		
	DELAY TIME		
	TAP TIME		
	FEEDBACK		
	HIGH CUT		
	EFFECT LEVEL		
	DIRECT LEVEL		
DELAY (DELAY1)/ DELAY (DELAY2)	TIME		
	FEEDBACK		
	HIGH CUT		
	LEVEL		
DELAY (WARP)	WARP SW		
	RISE TIME		
	FB DEPTH		
	LEVEL DEPTH		
DELAY (MOD)	MOD RATE		
	MOD DEPTH		

Parameter (F4)	Parameter (F5)	Parameter (F6)
[A] FX/[B] FX	DELAY (HOLD)	REC
		STOP
	CHORUS	CHORUS SW
		CHORUS MODE
		RATE
		DEPTH
		PREDELAY
		LOW CUT
		HIGH CUT
		EFFECT LEVEL
		REVERB
	TYPE	
	REVERB TIME	
	PREDELAY	
	LOW CUT	
	HIGH CUT	
	DENS	
	EFFECT LEVEL	
	DIRECT LEVEL	
	MOD1/MOD2	MOD SW
		MOD TYPE
	MOD1 PHASER/ MOD2 PHASER	TYPE
		RATE
		DEPTH
		MANUAL
		RESO
		STEP RATE
		EFFECT LEVEL
	DIRECT LEVEL	
	MOD1 FLANGER/ MOD2 FLANGER	RATE
		DEPTH
		MANUAL
		RESO
		SEPARATION
		LOW CUT
		EFFECT LEVEL
		DIRECT LEVEL
	MOD1 TREMOLO/ MOD2 TREMOLO	WAVE SHAPE
		RATE
		DEPTH
	MOD1 PAN/MOD2 PAN	WAVE SHAPE
		RATE
DEPTH		
MOD1 T.WAH/ MOD2 T.WAH	MODE	
	POLARITY	
	SENS	
	FREQ	
	PEAK	
	DIRECT LEVEL	

Parameter (F4)	Parameter (F5)	Parameter (F6)
[A] FX/[B] FX	MOD1 A.WAH/ MOD2 A.WAH	MODE
		FREQ
		PEAK
		RATE
		DEPTH
		LEVEL
		DIRECT LEVEL
	MOD1 OCTAVE/ MOD2 OCTAVE	RANGE
		OCTAVE LEVEL
		DIRECT LEVEL
	MOD1 P.SHIFT/ MOD2 P.SHIFT	VOICE
		MODE1, 2
		PITCH1, 2
		FINE1, 2
		PREDELAY1, 2
		LEVEL1, 2
		FEEDBACK1
		DIRECT LEVEL
	MOD1 HARMONIST/ MOD2 HARMONIST	VOICE
		HARM1, 2
		PREDELAY1, 2
		LEVEL1, 2
	MOD1 PDL BEND/ MOD2 PDL BEND	FEEDBACK1
		DIRECT LEVEL
		PITCH MIN
		PITCH MAX
		PEDAL POS
MOD1 2X2CHORUS/ MOD2 2X2CHORUS	EFFECT LEVEL	
	DIRECT LEVEL	
	X-OVER FREQ	
	LOW RATE	
	LOW DEPTH	
	LOW PREDELAY	
	LOW LEVEL	
	HIGH RATE	
	HIGH DEPTH	
	HIGH PREDELAY	
HIGH LEVEL		
MOD1 ROTARY/ MOD2 ROTARY	SPEED	
	RATE SLOW	
	RATE FAST	
	RISE TIME	
	FALL TIME	
MOD1 UNI-V/ MOD2 UNI-V	DEPTH	
	LEVEL	
	RATE	
MOD1 VIBRATO/ MOD2 VIBRATO	DEPTH	
	TRIG	
	RISE TIME	

Parameter (F4)	Parameter (F5)	Parameter (F6)
[A] FX/[B] FX	MOD1 SLICER/ MOD2 SLICER	PATTERN
		RATE
		TRIG SENS
	MOD1 HUMANIZER/ MOD2 HUMANIZER	MODE
		VOWEL1, 2
		SENS
		RATE
		DEPTH
		MANUAL
		LEVEL
	MOD1 SLOW GEAR/ MOD2 SLOW GEAR	SENS
		RISE TIME
	MOD1 DEFRETTER/ MOD2 DEFRETTER	TONE
		SENS
		ATTACK
		DEPTH
		RESO
		EFFECT LEVEL
		DIRECT LEVEL
	MOD1 FEEDBACK/ MOD2 FEEDBACK	MODE
		RISE TIME
		RISE TIME+
		FB LEVEL
		FB LEVEL+
		VIB DEPTH
	MOD1 RING MOD/ MOD2 RING MOD	MODE
		FREQ
		EFFECT LEVEL
		DIRECT LEVEL
	MOD1 ANTI-FB/ MOD2 ANTI-FB	FREQ1, 2, 3
		DEPTH1, 2, 3
	MOD1 ADV COMP/ MOD2 ADV COMP	TYPE
		SUSTAIN
		ATTACK
		TONE
		LEVEL
	MOD1 LIMITER/ MOD2 LIMITER	TYPE
		ATTACK
		THRSH
		RATIO
LEVEL		

Parameter (F4)	Parameter (F5)	Parameter (F6)
[A] FX/[B] FX	MOD1 SUB EQ/ MOD2 SUB EQ	LOW GAIN
		HIGH GAIN
		LOW MID FREQ
		LOW MID Q
		LOW MID GAIN
		HIGH MID FREQ
		HIGH MID Q
		HIGH MID GAIN
		LOW CUT
		HIGH CUT
	TOTAL GAIN	
	MOD1 SUB DELAY/ MOD2 SUB DELAY	DELAY TIME
		FEEDBACK
	NS	EFFECT LEVEL
		NS SW
THRSH		
REL		
FV	DETECT	
	LEVEL	
	VOL CURVE	
[A] COSM AMP/ [B] COSM AMP	COMMON	COSM AMP SW
		PREAMP TYPE
	PREAMP	GAIN
		BASS
		MIDDLE
		TREBLE
		PRESENCE
		LEVEL
		BRIGHT
	GAIN SW	
	PREAMP (SOLO)	SW
		LEVEL
	SPEAKER	SP TYPE
		MIC TYPE
		MIC DIS
		MIC POS
		MIC LEVEL
		DIRECT LEVEL
	PREAMP (CUSTOM)	CUSTOM TYPE
		BOTTOM
EDGE		
BASS FREQ		
TREBLE FREQ		
LOW		
HIGH		
SPEAKER (CUSTOM)	SIZE	
	LOW	
	HIGH	
	NUMBER	
	CABINET	

Parameter (F4)	Parameter (F5)	Parameter (F6)
[A] COSM AMP/ [B] COSM AMP	BASS AMP	GAIN
		BASS
		MIDDLE
		TREBLE
		LEVEL
		BRIGHT
		MIDDLE FREQ
		RESPONSE
		ENHANCER
		BASS AMP SP
	MIC POS	
	MIC LEVEL	
	DIRECT LEVEL	
	DELAY/REVERB	DELAY
TIME		
FEEDBACK		
HIGH CUT		
LEVEL		
REVERB		REVERB SW
		TYPE
		TIME
		PREDELAY
		LEVEL
DYNAMIC		DYNA SW
		TYPE
		LOWER RNG
		UPPER RNG
		A LOWER LEV
		A UPPER LEV
		B LOWER LEV
		B UPPER LEV
		LOWER BAL
		UPPER BAL
		RELEASE
[A] MIXER/ [B] MIXER		MIX SW
		PAN
		LEVEL
		DELAY SEND
		REVERB SEND
	CH DELAY	

Parameter (F4)	Parameter (F5)	Parameter (F6)		
MIXER (A&B)	TOTAL EQ (A&B)	EQ SW		
		LOW GAIN		
		HIGH GAIN		
		LOW MID FREQ		
		LOW MID Q		
		LOW MID GAIN		
		HIGH MID FREQ		
		HIGH MID Q		
		HIGH MID GAIN		
		TOTAL GAIN		
	OUTPUT	MAIN OUT		
		MAIN LEVEL		
		SUB OUT		
		SUB LEVEL		
		D OUT		
		D OUT LEVEL		
		A/B BALANCE	-	-
		PATCH LEVEL	-	-

NAME/KEY/BPM



PATCH NAME

Parameter/Range	Explanation
PATCH NAME	
This sets the Patch name.	
INSERT	Insert a space at the cursor location.
DELETE	Delete a character. The characters that follow get shifted to the left.
SPACE	Input a space at the cursor location.
A0!	Switch between uppercase letters, numbers, and characters.
A<=>a	Switch between uppercase letters and lowercase letters.
CATEGORY	Sets the category for the current patch. Refer to “Separating Patches into Groups (CATEGORY)” (p. 90)

CATEGORY

Parameter/Range	Explanation
CATEGORY	
USER 1–10 ELECTRIC ACOUSTIC BASS SYNTH ROCK JAZZ ETHNIC DYNAMIC RIBBON	This selects the Category name. * You can set USER1–USER10 in SYSTEM (p. 176).

KEY

Parameter/Range	Explanation
KEY	
C (Am)–B (G#m)	This sets the key for the COSM guitar and FX HARMONIST.
The key setting corresponds to the key of the song (#, b) as follows.	
<p>Major C F B^b E^b A^b D^b</p>  <p>Minor Am Dm Gm Cm Fm B^bm</p> <p>Major G D A E B F[#]</p>  <p>Minor Em Bm F[#]m C[#]m G[#]m D[#]m</p>	

BPM

Parameter/Range	Explanation
BPM	
40–250	Adjust the BPM value for each patch.

Control with the Master BPM

You can tap input the BPM with [F1].

AMP CONTROL

Parameter/Range	Explanation
AMP CTL1, AMP CTL2	
OFF, ON	This setting switches the FC-300's AMP CTL 1 and AMP CTL 2 parameters on and off.

TX PC (Transmit Program Change)

Parameter/Range	Explanation
You can assign whatever Program Change numbers you want to patches. * This setting is enabled when the SYSTEM MIDI TX PC MAP is set to PROG (p. 171).	
BANK MSB	
OFF, 1–127	This sets the Bank Select (MSB) to be output.
BANK LSB	
OFF, 1–127	This sets the Bank Select (LSB) to be output.
PC (Program Change)	
1–128	This sets the Program Change to be output.

PATCH LEVEL

Parameter/Range	Explanation
PATCH LEVEL	
0–200	Adjusts the volume the patch. * This parameter is the same as “PATCH LEVEL” (p. 146) in MIXER.

GUITAR TO MIDI

Parameter/Range	Explanation
GTR TO MIDI	
OFF, ON	This switches the GUITAR TO MIDI function on and off. Setting this to OFF prevents output of all GUITAR TO MIDI-related MIDI messages.

PATCH

These parameters are set for each individual patch with the GUITAR TO MIDI function.

Parameter/Range	Explanation
MODE	
This sets the transmission mode for the MIDI messages.	
MONO	In this mode, one channel per string is used, thus using a total of six channels. Since each string uses a different MIDI channel, you can select a different tone for each string, using string bending or continuously varying the pitch on a specific string; however, this requires use of a multitimbral sound module.
POLY	In this mode, the messages for all six strings are transmitted over a single channel. While transmitting the MIDI messages for all of the strings over one channel does simplify the settings needed for the sound module and reduces the number of MIDI channels used, it does impose certain limitations; for example, permitting only one tone to be selected for all of the strings.
PLAY FEEL	
This selects the feeling produced in playing the guitar, allowing you to choose picking with fingers or a pick to provide more natural dynamic expression.	
FEEL1-4	FEEL1 is the mode that gives sounds the broadest variation in volume based on the picking dynamics. As the setting number is increased, it becomes easier to produce high volume sounds even with weaker picking. This allows you to play with consistent volume, whether you tap the strings or use rough picking. In general, use higher setting numbers for softer picking, fingerpicking or tapping.
NO DYNA	In this mode, sounds are played at a fixed volume regardless of the picking strength.
STRUM	This suppresses the output of sounds from weaker picking. This setting allows you to prevent undesired sounds produced when playing rhythm or due to incidental contact with strings from incorrect picking.

Parameter/Range	Explanation
CHROMATIC	
This sets the VG-99 so that if you play bends or slides, the unit will not send pitch bend message but instead will play the notes in half steps.	
OFF	Pitches are output continuously.
TYPE1	When the pitch changes, this setting applies the results of the pitch change information without stopping the note that is playing. This produces a unique effect, whereby there is no attack sound when the pitches change, similar to slurring on a clarinet or a saxophone.
TYPE2	When the pitch changes, the VG-99 re-triggers (replays) the sound at the changed pitch, producing pitch changes only at the semitone increments. As a result, the attack of the new note starts at the current volume of the string, not the original volume.
TYPE3	As with CHROMATIC TYPE 2, sounds are retriggered at the changed pitch, expressing the pitch changes only in semitones. However, instead of reflecting the attenuation of the string vibration, the retriggered sound is the same as that when the string was initially played.
HOLD TYPE	
This selects the way the Hold function works.	
HOLD1	Note On messages are held when the Hold function is switched on with the controller. If the Hold function remains on as you continue to play the strings, each successive Note On message is held, and when a Note message is already being played from the same string, the previous Note message is cancelled, and the next Note On message is held. This allows you to prevent any interruption in the sounds, even sounds from releasing the strings over the frets.
HOLD2	Note On messages are held when the Hold function is switched on with the controller. However, subsequent Note On messages are not output if you continue to play the instrument with the Hold effect left on.
HOLD3	Note On messages are held when the Hold function is switched on with the controller. If the Hold function remains on as you continue to play the strings, Note On messages for strings other than the one already being held can be output, but they are not held.

Parameter/Range	Explanation
CC (Control Change)	
You can output the actions of the controllers specified with SRC as Control Change messages. You can make two types of settings, 1 and 2.	
SRC (Source)	
GK VOL	GK-3 GK volume knob
GK S1	GK-3 DOWN/S1 switch
GK S2	GK-3 UP/S2 switch
CTL1	Control button1
CTL2	Control button2
EXP PEDAL	Expression pedal connected to the EXP PEDAL jack
CTL3	Footswitch connected to the CTL3,4 jack (jack tip)
CTL4	Footswitch connected to the CTL3,4 jack (jack ring)
D BEAM V	D BEAM vertical movements
D BEAM H	D BEAM horizontal movements
RIBBON ACT	RIBBON CONTROLLER touch
RIBBON POS	RIBBON CONTROLLER position
FC-300 EXP1	FC-300 expression pedal1
FC-300 EXPSW1	FC-300 expression pedal switch1
FC-300 EXP2	FC-300 expression pedal2
FC-300 EXPSW2	FC-300 expression pedal switch2
FC-300 CTL1	FC-300 control pedal1
FC-300 CTL2	FC-300 control pedal2
FC-300 E3/C3	FC-300 external expression pedal3/external footswitch3
FC-300 CTL4	FC-300 external footswitch4
FC-300 E4/C5	FC-300 external expression pedal4/external footswitch5
FC-300 CTL6	FC-300 external footswitch6
FC-300 E5/C7	FC-300 external expression pedal5/external footswitch7
FC-300 CTL8	FC-300 external footswitch8
CC (Control Change)	
OFF, #1-#31, #64-#95	This sets the Control Change number to be output. * When the MONO/POLY setting is set to POLY, messages are output only over the basic channel; when this is set to MONO, the messages are output over the six channels starting from the basic channel.
TX PC STRING 1-6	
This sets the Program Change messages for each string that are output when the VG-99's patches are switched.	
BANK MSB	
OFF, 1-127	This sets the Bank Select (MSB).
BANK LSB	
OFF, 1-127	This sets the Bank Select (LSB).

Parameter/Range	Explanation
PC (Program Change)	
OFF, 1-128	This sets the Program Number.

SYSTEM

These parameters are applied to the entire VG-99 in the GUITAR TO MIDI function.

Parameter/Range	Explanation
HOLD CTL (Hold Control)	
This setting determines the controller used for the HOLD function.	
GK S1, S2	GK-3 DOWN/S1, UP/S2 switch
CTL1, 2	Control button1, 2
CTL3	Footswitch connected to the CTL3,4 jack
FC-300 CTL1,2	FC-300 control pedal1, 2
FC-300 CTL3-8	FC-300 external footswitch3-8
BEND THIN	
OFF, ON	Setting this to ON thins out the Pitch Bend messages and reduces the volume of MIDI data.
BASIC CH (Basic Channel)	
1-11	This sets the MIDI transmit channel used for the GUITAR TO MIDI function.
PC MASK (Program Change Mask)	
OFF, ON	When set to ON, the Bank Select messages and Program Change messages used for the GUITAR TO MIDI function are not transmitted when patches are changed.

SYSTEM

LCD CONTRAST

Parameter/ Range	Explanation
CONTRAST	
1-50	Setting up the VG-99 in certain positions may make the display difficult to read. If this occurs, adjust the display contrast (legibility).

DIRECT PATCH

Parameter/ Range	Explanation
DIRECT PATCH	
DIR.PATCH 1-5	This sets the desired [DIRECT PATCH 1]-[DIRECT PATCH 5].

GK SETTING

Parameter/ Range	Explanation
GK CONNCT (GK Connect)	
AUTO	This automatically determines the GK connection and switches the internal settings. When the GK connection is in use, the GUITAR INPUT connection is disabled.
OFF	Use this setting if you normally use the connection for GUITAR INPUT.
ON	Use this setting if you are normally using a GK connection.
GK FUNC (GK Function)	
GK VOL (GK Volume)	
This selects the function assigned to GK VOL.	
cf. ➤	
For more on the functions assigned, refer to the GK VOL column in “Parameters That Can Be Assigned to Separate Controllers” (p. 168).	
GK S1, S2 (GK S1, S2 Switch)	
This selects the functions assigned to GK S1, S2.	
cf. ➤	
For more on the functions assigned, refer to the GK S1, S2 column in “Parameters That Can Be Assigned to Separate Controllers” (p. 168).	
SET MODE	
This setting allows you to select whether one GK SETTING is used globally for the entire VG-99 or if different GK SETTINGS are specified for each patch individually.	
SYSTEM	The GK SETTING set here is used globally for the entire VG-99. This is the default factory setting.
PATCH	GK SETTINGS are specified for each patch individually. Carry out the Write procedure after making changes to the settings in each patch. Use this setting when performing with multiple guitars, switching the instrument depending on the patch used.
SETTING1-10	
1-10	This selects the GK SETTING to be set.
NAME	
This sets the name for the GK SETTING (up to eight characters).	
INSERT	Insert a space at the cursor location.
DELETE	Delete a character. The characters that follow get shifted to the left.
SPACE	Input a space at the cursor location.
A0!	Switch between uppercase letters, numbers, and characters.
A<=>a	Switch between uppercase letters and lowercase letters.

Parameter/Range	Explanation
GK PU TYPE (GK Pickup Type)	
GK-3	Specifies the GK-3.
GK-2A	Specifies the GK-2A.
PIEZO	Specifies a piezo pickup.
GUITAR SCALE	
620–660mm, ST (648mm), LP (628mm)	This sets the scale length for your guitar.
GK PU PHASE (GK Pickup Phase)	
This sets the phase for the divided pickup and normal pickup. The sounds from the divided pickup and normal pickup are mixed so as to enable the proper settings. Set this to NORMAL, and if the low-frequency range is cut, set this to INVERS.	
NORMAL	The phase is left unchanged.
INVERS	The phase is inverted.
GK PU DIRECTION (GK Pickup Direction)	
This sets the direction for the divided pickup's installation.	
NORMAL	Positioned such that the cable exits near the 6th string.
REVRSE	Positioned such that the cable exits near the 1st string.
S1, S2 POS (S1, S2 Position)	
This exchanges the function for the GK-3's or GK-2A's DOWN/S1, UP/S2 switches.	
NORMAL	The switches are left unchanged.
REVRSE	The DOWN/S1 switch and UP/S2 switch are exchanged.
PICKUP↔BRIDGE 1st–6th	
10.0–30.0mm	This sets the distance of the gap between each Divided pickup and the bridge. The setting is disregarded when the GK PU TYPE is set to PIEZO.
SENS 1st–6th	
0–100	This sets the input sensitivity for each string.

CONTROL ASSIGN

Parameter/Range	Explanation
Controller	
You can freely assign functions to the VG-99's and FC-300's controllers.	
GK VOL	GK-3 GK volume knob
GK S1, S2	GK-3 DOWN/S1, UP/S2 switch
CTL1	Control button1
CTL2	Control button2
EXP PEDAL	Expression pedal connected to the EXP PEDAL jack
CTL3	Footswitch connected to the CTL3,4 jack (jack tip)
CTL4	Footswitch connected to the CTL3,4 jack (jack ring)
FC-300 EXP1	FC-300 expression pedal1
FC-300 EXP SW1	FC-300 expression pedal switch1
FC-300 EXP2	FC-300 expression pedal2
FC-300 EXP SW2	FC-300 expression pedal switch2
FC-300 CTL1	FC-300 control pedal1
FC-300 CTL2	FC-300 control pedal2
FC-300 E3/C3	FC-300 external expression pedal3/external footswitch3
FC-300 CTL4	FC-300 external footswitch4
FC-300 E4/C5	FC-300 external expression pedal4/external footswitch5
FC-300 CTL6	FC-300 external footswitch6
FC-300 E5/C7	FC-300 external expression pedal5/external footswitch7
FC-300 CTL8	FC-300 external footswitch8
ASSIGN HOLD	
This setting determines whether or not the values (positions) of the D BEAM (H) or RIBBON CONTROLLER or the FC-300's expression pedals or control pedals or other controllers are to be reflected in the sound as soon as a patch is called up.	
ON	When a patch is called up, the controller values (positions) are applied, producing a sound that reflects the controller settings.
OFF	When a patch is changed, the sound set in the patch is played, regardless of the controller values (positions).

Parameters That Can Be Assigned to Separate Controllers

CTL1-4, FC-300 EXP SW1/EXP SW2, FC-300 CTL1, 2, 4, 6, 8					
FC-300 EXP3/CTL3, EXP4/CTL5, EXP5/CTL7					
GK S1, S2					
GK VOL, EXP PEDAL, FC-300 EXP1/EXP2					
Parameter	Explanation				
Parameters for which ✓ is indicated can be assigned to the controllers shown here.					
OFF	No function is assigned.	✓	✓	✓	✓
ASSIGNABLE (PATCH)	Functions according to the Control Assign settings in each individual patch.	✓	✓	✓	✓
PATCH LEVEL 0-100	Provides control of the patch level.	✓		✓	
PATCH LEVEL 0-200		✓		✓	
AB BALANCE	Provides control of the balance of the volume in Channel A and Channel B.	✓		✓	
FOOT VOLUME [A&B]	Provides simultaneous control of the foot volume in Channel A and Channel B.	✓		✓	
FOOT VOLUME [A]	Provides control of the foot volume in Channel A or Channel B.	✓		✓	
FOOT VOLUME [B]		✓		✓	
WAH	Provides control of the pedal wah when the pedal wah is switched on.	✓		✓	
GUITAR VOLUME [A&B]	Provides simultaneous control of the COSM guitar volume in Channel A and Channel B.	✓		✓	
GUITAR VOLUME [A]	Provides control of the COSM guitar volume in Channel A or Channel B.	✓		✓	
GUITAR VOLUME [B]		✓		✓	
GUITAR TONE [A&B]	Provides simultaneous control of the COSM guitar tone in Channel A and Channel B.	✓		✓	
GUITAR TONE [A]	Provides control of the COSM guitar tone in Channel A or Channel B.	✓		✓	
GUITAR TONE [B]		✓		✓	
MIXER LEVEL [A&B]	Provides simultaneous control of the mixer volume level in Channel A and Channel B.	✓		✓	
MIXER LEVEL [A]	Provides control of the mixer volume level in Channel A or Channel B.	✓		✓	
MIXER LEVEL [B]		✓		✓	
PATCH SEL DEC/INC	When set to INC, patch numbers increase when patches are switched; setting this to DEC causes the VG-99 to switch to lower patch numbers when patches are switched.		✓		

CTL1-4, FC-300 EXP SW1/EXP SW2, FC-300 CTL1, 2, 4, 6, 8					
FC-300 EXP3/CTL3, EXP4/CTL5, EXP5/CTL7					
GK S1, S2					
GK VOL, EXP PEDAL, FC-300 EXP1/EXP2					
Parameter	Explanation				
PU SEL [A&B]	Allows you to switch the pickups in Channel A and Channel B simultaneously.		✓		
PU SEL [A]	Allows you to switch the pickups in Channel A or Channel B.		✓		
PU SEL [B]			✓		
S1:TUNER/ S2:BPM TAP	The TUNER screen is switched with S1. S2 can be used for tap input of the BPM parameter.		✓		
PATCH LEVEL DEC/INC	Provides control of the patch level.		✓		
AB BALANCE toA/toB	Provides control of the volume balance between Channel A and Channel B. The level from Channel A is increased with S1; the level from Channel B is increased with S2.		✓		
MIDI START/ STOP	Transmits Start and Stop for transmission of MIDI Realtime messages.		✓	✓	✓
MMC PLAY/ STOP	Transmits Play and Stop for transmission of MIDI Machine Control.		✓	✓	✓
FC-300 AMP CTL 1/2	Provides control of the FC-300's AMP CONTROL1 and AMP CONTROL2 jacks. This allows switching of the channels for guitar amps connected to these jacks.		✓		
PATCH SELECT INC	Switches to higher patch numbers when patches are switched.			✓	✓
PATCH SELECT DEC	Switches to lower patch numbers when patches are switched.			✓	✓
PU SEL toFRONT [A&B]	Switches the Channel A and Channel B pickups towards the front.			✓	✓
PU SEL toREAR [A&B]	Switches the Channel A and Channel B pickups towards the rear.			✓	✓
PU SEL toFRONT [A]	Switches the Channel A pickup towards the front.			✓	✓
PU SEL toREAR [A]	Switches the Channel A pickup towards the rear.			✓	✓
PU SEL toFRONT [B]	Switches the Channel B pickup towards the front.			✓	✓
PU SEL toREAR [B]	Switches the Channel B pickup towards the rear.			✓	✓
TUNER ON/OFF	Switches the TUNER screen.			✓	✓
BPM TAP	Allow tap input for the BPM parameter.			✓	✓
PATCH LEVEL INC	Increases the patch level.			✓	✓

CTL1-4, FC-300 EXP SW1/EXP SW2, FC-300 CTL1, 2, 4, 6, 8

FC-300 EXP3/CTL3, EXP4/CTL5, EXP5/CTL7

GK S1, S2

GK VOL, EXP PEDAL, FC-300 EXP1/EXP2

Parameter	Explanation				
PATCH LEVEL DEC	Decreases the patch level.			✓	✓
AB BALANCE toB	Increases the volume level in Channel B in the balance between Channel A and Channel B.			✓	✓
AB BALANCE toA	Increases the volume level in Channel A in the balance between Channel A and Channel B.			✓	✓
FC-300 AMP CTL 1	Switches to the channel assigned for the guitar amp connected the FC-300's AMP CONTROL1 jack.			✓	✓
FC-300 AMP CTL 2	Switches to the channel assigned for the guitar amp connected the FC-300's AMP CONTROL2 jack.	✓	✓	✓	

FC-300

Parameter/Range	Explanation
SYS EX MODE (System Exclusive Mode)	
This sets the FC-300's control method.	
ON	When connected to the VG-99, the FC-300 automatically changes to System Exclusive mode and operates in accordance with the settings made with the VG-99. This is the setting you should normally select. MEMO You can control the FC-300 even without matching the VG-99's and FC-300's Device IDs.
OFF	Select OFF when controlling the FC-300's with the FC-300 (manually).
BANK CHANGE	
This sets the timing with which tones switch when patches are changed with the FC-300.	
IMMEDIATE	The tone changes immediately when the FC-300's ▼ ▲ pedals are pressed.
WAIT NUM	Even after the FC-300's ▼ ▲ pedals are pressed, the tone does not change until the NUMBER is set.
QUICK TUNER	
This enables use of the FC-300's number pedals to switch the Tuner function on and off. The Quick Tuner function is enabled only when the FC-300's MODE is set to SYS EX.	
OFF	The QUICK TUNER function is not operational.
ON	The QUICK TUNER function is operational. The TUNER function is alternately switched on and off each time the currently selected number pedal is pressed.

MIDI

Parameter/Range	Explanation
MIDI CH (MIDI Channel)	
1-16ch	This sets the channel used for transmitting and receiving MIDI messages. When controlling another synthesizer sound module using the GUITAR TO MIDI function, also refer to "GUITAR TO MIDI" (p. 164).
OMNI MODE	
OFF, ON	When MIDI OMNI MODE is set to ON, messages are received on all MIDI channels, regardless of the MIDI channel settings.
DEVICE ID	
1-32	This sets the Device ID used for transmission and reception of Exclusive messages.
SYNC CLOCK	
This setting determines the basis used for synchronizing the timing for effect modulation rates and other time-based parameters.	
INTERNAL	Operations are synchronized to the VG-99's internal Clock.
AUTO (USB)	Operations are synchronized to the MIDI Clock received via USB. However, operations are automatically synchronized to the VG-99's internal Clock if the VG-99 is unable to receive the external Clock.
AUTO (MIDI)	Operations are synchronized to the MIDI Clock received via MIDI. However, operations are automatically synchronized to the VG-99's internal Clock if the VG-99 is unable to receive the external Clock.
AUTO (RRC2)	Operations are synchronized to the MIDI Clock received via the RRC2 connector. However, operations are automatically synchronized to the VG-99's internal Clock if the VG-99 is unable to receive the external Clock.
MIDI	
MIDI IN	
This sets the routing of signals arriving at the MIDI IN connector.	
OFF	Signals are not received at MIDI IN.
MAIN	Signals received at MIDI IN are transmitted to the VG-99's internal section.

Parameter/Range	Explanation
MIDI OUT	
This sets the routing of signals at the MIDI OUT connector.	
OFF	Signals are not output from MIDI OUT.
MAIN	Signals from the VG-99 are output.
USB	MIDI signals received via USB are output.
MIDI	The MIDI signals received at MIDI IN are output from MIDI OUT (thru). When other signals also are set to be output simultaneously from MIDI OUT, the signals are mixed and then output together (merge).
RRC2	The MIDI signals received at through RRC2 are output from MIDI OUT (thru). When other signals also are set to be output simultaneously from MIDI OUT, the signals are mixed and then output together (merge).
USB (MIDI)→	
This sets the routing of signals received via USB.	
OFF	Signals are not received via USB.
MAIN	Signals received via USB are transmitted to the VG-99's internal section.
USB (MIDI)←	
This sets the routing of signals output from the USB connector.	
OFF	Signals are not output from the USB connector.
MAIN	MIDI signals from the VG-99 are output.
MIDI	MIDI signals received at MIDI IN are output.
RRC2	MIDI signals received through RRC2 are output.
RRC2→	
This sets the routing of signals received via RRC.	
OFF	Signals are not received through RRC2.
MAIN	Signals received at the RRC2 connector are transmitted to the VG-99's internal section.
RRC2←	
This sets the routing of signals output from the RRC2 connector.	
OFF	Signals are not output from the USB connector.
MAIN	MIDI signals from the VG-99 are output.
USB	MIDI signals received via USB are output.
MIDI	MIDI signals received at MIDI IN are output from the RRC2 connector (thru). When other signals also are set to be output simultaneously from the RRC2 connector, the signals are mixed and then output together (merge).

Parameter/ Range	Explanation
PC (Program Change)	
PC OUT (Program Change Out)	
OFF, ON	This setting determines whether or not Program Change messages are output when the VG-99's patches are switched. Program Change messages are output when this is set to ON.
TX PC MAP (TX Program Change Map)	
This setting determines the sequence of Program Change messages output when the VG-99's patches are changed.	
FIX	Regardless of the patch settings, Program Change messages predetermined for each patch number are output.
PROG	The Program Change messages programmed in each patch are output.
RX PC MAP (RX Program Change Map)	
You can select whether to use a fixed or freely set correspondence between program numbers received and the patches switched to when the VG-99's patches are switched by Program Change messages transmitted by an external MIDI device.	
FIX	The VG-99 switches to the patches predetermined for the corresponding received Program Change messages, regardless of the Receive Program Change Map settings.
PROG	The VG-99's switches to the patches set in the Receive Program Change Map.
RX PC MAP (RX Program Change Map)	
You can edit the correspondence between the Program Change numbers received and the patches that are switched to.	
[F1] (BANK)	Selects the Bank number.
[F2] [F3] (SEL)/ F2, F3 knob	Selects the Program number.
[F5] (SELECT)/ F5 knob	Selects the patch. When the combination of the Bank number and Program number selected with F1, F2, and F3 is received, the VG-99 switches to the patch selected with F5.
CC (Control Change)	
This sets the Control Change numbers output when the VG-99's pedals and external pedals or the FC-300's pedals and external pedals are operated.	
[F2] [F3] (SEL)/ F2, F3 knob	Selects the controller.
[F5] (SET OFF)/ F5 knob	When the controller selected with F2 or F3 is operated, the Control Change message selected with F5 is transmitted.

Parameter/ Range	Explanation
BULK DUMP	
With the VG-99, you can use Exclusive messages to set another VG-99 to the same settings or to save effect sound settings to MIDI sequencers and other such devices.	
ALL	All transmittable data (SYSTEM, GK SETTING, GLOBAL, PATCH 001-200, FAVORITE SETTING)
SYSTEM	SYSTEM parameters.
GK SETTING	Settings content for GK SETTING
GLOBAL	GLOBAL function settings
PATCH	Settings for patch numbers 001-200
FAVORITE SETTING	Settings content in FAVORITE SETTINGS 01-10 for all effects

OUTPUT

Parameter/Range	Explanation
OUTPUT MODE	
SYSTEM	The values set in the SYSTEM parameters MAIN OUT, MAIN LEVEL, SUB OUT, SUB LEVEL, D OUT, and D OUT LEVEL are enabled.
PATCH	The values set in MAIN OUT, MAIN LEVEL, SUB OUT, SUB LEVEL, D OUT, D OUT LEVEL for each patch are enabled.
MAIN OUT	
This switches the signals output to MAIN OUT.	
CH A	This outputs Channel A. The mixer's MIX SW, PAN, LEVEL, and A/B BAL are also reflected here.
CH B	This outputs Channel B. The mixer's MIX SW, PAN, LEVEL, and A/B BAL are also reflected here.
MIXER (DRY)	This outputs the post-A/B mix signals before application of DELAY/REVERB.
MIXER	This outputs the post-A/B mix signals after application of DELAY/REVERB and TOTAL EQ.
MAIN LEVEL	
0-200	Adjusts the level to MAIN LEVEL.
SUB OUT	
This switches the signals output to SUB OUT.	
CH A	This outputs Channel A. The mixer's MIX SW, PAN, LEVEL, and A/B BAL are also reflected here.
CH B	This outputs Channel B. The mixer's MIX SW, PAN, LEVEL, and A/B BAL are also reflected here.
MIXER (DRY)	This outputs the post-A/B mix signals before application of DELAY/REVERB.
MIXER	This outputs the post-A/B mix signals after application of DELAY/REVERB and TOTAL EQ.
SUB LEVEL	
0-200	Adjusts the level to SUB OUT LEVEL.

Parameter/Range	Explanation
D OUT (Digital Out)	
This switches the signals output from DIGITAL OUT.	
COSM GTR A	This outputs the sounds from COSM GTR A.
COSM GTR B	This outputs the sounds from COSM GTR B.
NORMAL PU	This outputs the sounds from the normal pickup.
CH A	This outputs Channel A. This output also reflects the mixer's MIX SW, PAN, LEVEL, and A/B BAL settings.
CH B	This outputs Channel B. This output also reflects the mixer's MIX SW, PAN, LEVEL, and A/B BAL settings.
MIXER (DRY)	This outputs the post-A/B mix signals before application of DELAY/REVERB.
MIXER	This outputs the post-A/B mix signals after application of DELAY/REVERB and TOTAL EQ.
MAIN OUT	This outputs the same signals as those from MAIN OUT.
SUB OUT	This outputs the same signals as those from SUB OUT.
D OUT LEVEL (Digital Out Level)	
0-200	Adjusts the level to DIGITAL OUT.

* The parameters enabled (MAIN OUT, MAIN LEVEL, SUB OUT, SUB LEVEL, D OUT, D OUT LEVEL) change according to the OUTPUT MODE settings. When they are disabled, the value < > is given.

USB

Parameter/Range	Explanation
USB IN	
This sets the point at which digital audio signals received via USB (from your computer) are connected within the VG-99.	
* Unless this is set to OFF, make sure the software is not set to thru for audio signals.	
* If the USB IN parameter is set to COSM GTR A, COSM GTR B, or NORMAL PU, the setting automatically changes to MAIN & SUB the next time the VG-99 is powered up. If you plan to use COSM GTR A, COSM GTR B, or NORMAL PU, make the setting each time you turn on the power to the VG-99.	
OFF	The signals are not connected at any point.
COSM GTR A	The signals are connected at the point where the COSM GUITAR A is output. The audio output from the computer, instead of the COSM guitar sounds played by the connected guitar, is input to the effects. * POLY FX are not applied.
COSM GTR B	The signals are connected at the point where the COSM GUITAR B is output. The audio output from the computer, instead of the COSM guitar sounds played by the connected guitar, is input to the effects. * POLY FX are not applied.
NORMAL PU	The signals are connected at the normal pickup input. The audio output from the computer, instead of the normal sounds played by the connected guitar, is input to the effects.
MAIN OUT	The signals are connected at the point where MAIN OUT is output. The signals from the VG-99's MAIN OUT and the audio output from the computer are mixed and output.
SUB OUT	The signals are connected at the point where SUB OUT is output. The signals from the VG-99's SUB OUT and the audio output from the computer are mixed and output.
MAIN&SUB	The signals are connected at the point where both MAIN OUT and SUB OUT are output. Each of the signals from the VG-99's MAIN OUT and the audio output from the computer are mixed, SUB OUT and the audio output from the computer are mixed from the output.
IN LEVEL	
0-200	Adjusts the volume level of the digital audio received via USB (from the computer).

Parameter/Range	Explanation
USB OUT	
This sets the point internally within the VG-99 from which signals are output via USB (to the computer).	
COSM GTR A	The output from COSM GUITAR A is output.
COSM GTR B	The output from COSM GUITAR B is output.
NORMAL PU	The normal pickup input is output.
CH A	The output from Channel A is output.
CH B	The output from Channel B is output.
MIXER (DRY)	The signals that have been mixed with the mixer, but before application of DELAY / REVERB, are output.
MIXER	The signals that have been mixed with the mixer and have DELAY / REVERB applied are output.
MAIN OUT	The same signals as those from MAIN OUT are output.
SUB OUT	The same signals as those from SUB OUT are output.
OUT LEVEL	
0-200	Adjusts the volume level of the digital audio output via USB (to the computer).
DRIVER MODE	
This setting determines which operational mode is used, the mode using the special driver contained on the included CD-ROM (ADVANC) or the mode using the OS's (Windows/Mac OS) standard driver (STANDRD).	
STANDRD	This mode uses the OS's standard USB driver.
ADVANC	This mode uses the special driver contained on the included CD-ROM. The mode using this driver allows you to record, play back, and edit audio with high-quality sound and stable timing.
MON CMD (Monitor Command)	
This setting determines whether or not the command (the Direct Monitor command) controlling the Direct Monitor (described later) setting is enabled.	
DISABL	The Direct Monitor command is disabled, maintaining the Direct Monitor mode set by the VG-99.
ENABLE	The Direct Monitor command is enabled, allowing the Direct Monitor mode to be switched from an external device.
DIRECT MON (Direct Monitor)	
Switches the output of the VG-99 sound to the PHONES jack, MAIN OUT jacks, or SUB OUT jacks.	
OFF	Set this to Off if transmitting audio data internally through a computer (Thru).
ON	The VG-99 sound is output. Set this to On when using the VG-99 as a standalone device, without connecting to a computer (only USB IN input sound will be output if this is set to Off).
* This setting cannot be saved. It is set to ON when the power is turned on.	
* If you are using the special driver, you can control DIRECT MON On/Off from ASIO 2.0-compatible application.	

V-LINK

V-LINK PATCH





CLIP

Parameter/Range	Explanation
This sets the Program Change messages transmitted when patches are switched. You can set different Program Changes in Channel A and Channel B. The clips (video images) on the receiving device are switched by these Program Change messages.	
A ch/B ch PALETTE	
OFF, 1-32	This sets the Bank Select number (CC#0, #32).
A ch/B ch CLIP	
OFF, 1-32	This sets the Program Change numbers.

ASSIGN 1-2

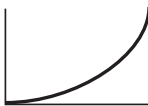
Parameter/Range	Explanation
These settings are necessary for controlling video using the guitar's performance data and messages from the VG-99's controllers. You can make up to two types of settings.	
SOURCE	
OFF	The V-LINK function is not assigned.
BEND	Pitch bend messages
VELO	Velocity messages
GK VOL	GK-3 GK volume knob
GK S1	GK-3 DOWN/S1 switch
GK S2	GK-3 UP/S2 switch
CTL1	Control button1
CTL2	Control button2
EXP PEDAL	Expression pedal connected to the EXP PEDAL jack
CTL3	Footswitch connected to the CTL3,4 jack (jack tip)
CTL4	Footswitch connected to the CTL3,4 jack (jack ring)
D BEAM V	D BEAM vertical movements
D BEAM H	D BEAM horizontal movements
RIBBON	RIBBON CONTROLLER
FC-300 EXP1	FC-300 expression pedal1
FC-300 EXPSW1	FC-300 expression pedal switch1
FC-300 EXP2	FC-300 expression pedal2
FC-300 EXPSW2	FC-300 expression pedal switch2
FC-300 CTL1	FC-300 control pedal1
FC-300 CTL2	FC-300 control pedal2
FC-300 E3/C3	FC-300 external expression pedal3/external footswitch3
FC-300 CTL4	FC-300 external footswitch4
FC-300 E4/C5	FC-300 external expression pedal4/external footswitch5

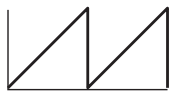
Parameter/Range	Explanation
FC-300 CTL6	FC-300 external footswitch6
FC-300 E5/C7	FC-300 external expression pedal5/external footswitch7
FC-300 CTL8	FC-300 external footswitch8
INTRNL PEDAL	Internal pedal
WAVE PEDAL	Wave pedal
TARGET	
Used in the motion dive .tokyo performance package.	
COLOR EQ-FG	Color foreground
COLOR EQ-BG	Color background
SCRATCH SW	Scratch switch
SPEED KNOB	Speed knob
TOTAL FADER	Total fader
CROSS FADER	Cross fader
BPM SYNC	BPM sync switch
CLIP LOOP	Clip loop switch
ASSIGN KNOB	Assignable knob
FADE TIME	Fade time switch
VISUAL KNOB	Visual plug-in control knob
AB SW	A/B switch
TAP SW	Tap switch
TOTAL SELECT	Total select
FX SELECT	Effect select
PLAY POS	Play position
LOOP START	Loop start position
LOOP END	Loop end position
LAYER MODE	Layer mode select
DV-7PR	
PLAY SPEED	Play speed
DISLV TIME	Dissolve time (time elapsed in switching video images)
T BAR	T bar
COLOR Cb	Color cb (Color difference signal)
COLOR Cr	Color cr (Color difference signal)
BRIGHTNESS	Brightness
VFX 1	Visual effects1
VFX 2	Visual effects2
VFX 3	Visual effects3
VFX 4	Visual effects4
OUTPUT FADE	Output fade
DUAL STREAM	Dual stream
MIN (Minimum) *1	
0-127	Sets the lower limit in the range the parameter changes.
MAX (Maximum) *1	
0-127	Sets the upper limit in the range the parameter changes.

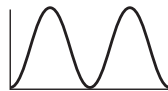
Parameter/Range	Explanation
TRIGGR *2	
Sets the point at which the virtual expression pedal's action begins.	
PATCH CHANGE	Functions when patches are switched.
GK VOL	Functions when the divided pickup's volume knob is adjusted.
GK S1, S2	Functions when the divided pickup's DOWN/S1 or UP/S2 switch position is changed.
CTL1-CTL4	Functions when the CTL 1, 2 buttons or foot switch connected to CTL 3,4 jack are operated.
EXP	Functions when the expression pedal connected to EXP PEDAL jack are operated.
D BEAM V, H	Functions when the vertical or horizontal position is detected by the D Beam controller.
RIBBON ACT, POS	Functions when the ribbon controller is operated by touch or when the position is detected.
FC-300 EXP1, EXP2	Functions when the FC-300's EXP PEDAL 1 or 2 is operated.
FC-300 CTL1, CTL2	Functions when the FC-300's CTL1 or CTL2 is operated.
FC-300 E3/C3, CTL4, E4/C5, CTL6, E5/C7, CTL8	Functions when a pedal connected to the FC-300's E3/C3, CTL4, E4/C5, CTL6, E5/C7, or CTL8 jacks is operated.
TIME *2	
0-100	Adjusts the amount of time for the virtual expression pedal to shift from the fully released position (pedal toe raised) to the fully depressed position (pedal toe pressed down).
CURVE *2	
This selects one of the three types that determines how the assumed expression pedal changes.	
<div style="display: flex; justify-content: space-around; align-items: flex-start;"> <div style="text-align: center;"> <p>LINEAR</p>  </div> <div style="text-align: center;"> <p>SLOW RISE</p>  </div> <div style="text-align: center;"> <p>FAST RISE</p>  </div> </div>	
RATE *3	
0-100	This determines the time spend for one cycle of the assumed expression pedal.
FORM *3	
This selects one of the three types that determines how the assumed expression pedal should change.	
<div style="display: flex; justify-content: space-around; align-items: flex-start;"> <div style="text-align: center;"> <p>SAW</p>  </div> <div style="text-align: center;"> <p>TRI</p>  </div> <div style="text-align: center;"> <p>SIN</p>  </div> </div>	

*1 You cannot set the MIN or MAX parameters when the TARGET parameter is set to one of the functions below. The MIN parameter is fixed at 0, and the MAX parameter is fixed at 127.

- SCRTCH SW
- BPM SYNC
- CLIP LOOP
- AB SW
- TAP SW
- DUAL STREAM

*2 The TRIGGR, TIME, and CURVE parameters are enabled when the SOURCE parameter is set to INT PEDAL.

*3 The RATE and FORM parameters are enabled when the SOURCE parameter is set to WAVE PEDAL.

MEMO

Although the target names indicated refer to EDIROL DV-7PR and motion dive .tokyo, it is Control Change messages that are actually transmitted.

For more on the correspondence between the target names and Control Change numbers, refer to p. 181.

MEMO

For more detailed information on the EDIROL DV-7PR and motion dive .tokyo performance package, refer to the Owner's Manuals for each product.

STRING CH (String Channel)

Parameter/Range	Explanation
1st-6th	
Selects the channel to be controlled with each string.	
OFF	No channel is controlled.
A CH	Channel A of the V-LINK compatible device is controlled.
B CH	Channel B of the V-LINK compatible device is controlled.
C CH	MIDI Note plug-in is controlled.

MEMO

Some V-LINK compatible equipments such as the EDIROL DV-7PR allow use only of A CH.

V-LINK SYSTEM

MIDI CH (MIDI Channel)

Parameter/Range	Explanation
This sets the MIDI receive channel for the V-LINK compatible device connected to the VG-99.	
MIDI A CH (MIDI A Channel)	
1-16ch	Sets the MIDI channel for Channel A of the V-LINK compatible device.
MIDI B CH (MIDI B Channel)	
1-16ch	Sets the MIDI channel for Channel B of the V-LINK compatible device.
MIDI C CH (MIDI B Channel)	
1-16ch	Specifies the MIDI channel that will control MIDI note plug-in.

MEMO

- The V-LINK screen's MIDI CH parameter is a system parameter.
- When a V-LINK compatible device is connected to the VG-99, set this parameter so that the V-LINK compatible device's MIDI channel and the MIDI channel used by the VG-99 are not the same.
- The MIDI channels set here are output as System Exclusive messages when the VG-99's power is turned on and when the V-LINK function is switched on.
- Some V-LINK compatible equipments such as the EDIROL DV-7PR allow use only of MIDI A CH.

GATEGORY NAME

Parameter/Range	Explanation
CATEGORY NAME	
This sets the Category name.	
INSERT	Insert a space at the cursor location.
DELETE	Delete a character. The characters that follow get shifted to the left.
SPACE	Input a space at the cursor location.
A0!	Switch between uppercase letters, numbers, and characters.
A<=>a	Switch between uppercase letters and lowercase letters.
CATGRY	Select the user category you want to name.

D BEAM CALIB (D BEAM Calibration)

Parameter/Range	Explanation
D BEAM DISAB (D BEAM Disable)	
You can disable the D BEAM controller for the entire device.	
OFF	The D BEAM is enabled.
ON	The D BEAM is disabled. * Pressing the D BEAM [PITCH], [FILTER], or [ASSIGNABLE] button to switch the D BEAM controller on will have no effect.

PATCH EXTENT

Parameter/Range	Explanation
PATCH EXTENT	
You can set upper and lower limits to define the range of patches that can be switched.	
FROM	Set the lower limits to define the range of patches.
TO	Set the upper limits to define the range of patches.

FACTORY RESET

Parameter/Range	Explanation
FACTORY RESET	
This restores the VG-99 to the settings it had when it was shipped from the factory.	
ALL	All data
SYSTEM	Content of the settings for the SYSTEM parameters, HARMONIST scales, AUTO RIFF phrases, preamps and speakers, overdrive/distortion and wah custom edit parameters
GK SETTING	Content of the settings for GK SETTING
GLOBAL	GLOBAL function settings
PATCH	Settings for patch numbers 001-200
FAVORITE SETTING	Content of the settings in FAVORITE SETTINGS 01-10 for all effects

GLOBAL

Parameter/Range	Explanation
MAIN OUTPUT SELECT	
This selects the type of device to be connected.	
JC-120	Set this when connecting a Roland JC-120 guitar amp.
SMALL AMP	Use this setting when connecting a compact guitar amp.
COMBO AMP	Set this when connecting to the guitar input for a combo-type guitar amp (combining amp and speakers in a single unit) other than a JC-120. * You may find that setting this to JC-120 may produce good results with your guitar amp.
STACK AMP	Use this setting when connecting to the guitar input for a stack-type guitar amp (in which the amp and speakers are separated)
JC-120 RETURN	Set this when connecting to the JC-120's RETURN.
COMBO RETURN	Set this when connecting to the RETURN on another combo-type amp.
STACK RETURN	Set this when connecting to the RETURN on a stack-type amp. Set STACK RETURN even when using a power amp for the guitar in combination with a speaker cabinet.
LINE/PHONES	Use this setting when using headphones or when recording with the VG-99 connected to a multitrack recorder. * Use the LINE/PHONES setting if you are using a speaker simulator.

EQ MAIN (Equalizer Main), EQ SUB (Equalizer Sub)

Parameter/Range	Explanation
MAIN EQ (Main Equalizer), SUB EQ (Sub Equalizer)	
A four-band equalizer with high and low ranges is provided. The sound processed by the effect can be boosted by frequency range before it is output. MEMO EQ (MAIN) is applied to the output from MAIN OUT; EQ (SUB) is applied to the output from SUB OUT.	
MAIN EQ SW (Main Equalizer Switch), SUB EQ SW (Sub Equalizer Switch)	
OFF, ON	Turns the EQ effect on/off.
TOTAL GAIN	
-12~+12dB	Adjusts the volume before the equalizer.
LOW GAIN	
-12~+12dB	Adjusts the low frequency range tone.

Parameter/Range	Explanation
HIGH GAIN	
-12~+12dB	Adjusts the high frequency range tone.
LOW MID FREQ (Low Middle Frequency)	
20Hz~10.0kHz	Specifies the center of the frequency range that will be adjusted by the LOW MID GAIN.
LOW MID Q (Low Middle Q)	
0.5~16	Adjusts the width of the area affected by the EQ centered at the LOW MID FREQ. Higher values will narrow the area.
LOW MID GAIN (Low Middle Gain)	
-12~+12dB	Adjusts the low-middle frequency range tone.
HIGH MID FREQ (High Middle Frequency)	
20Hz~10.0kHz	Specifies the center of the frequency range that will be adjusted by the HIGH MID GAIN.
HIGH MID Q (High Middle Q)	
0.5~16	Adjusts the width of the area affected by the EQ centered at the HIGH MID FREQ. Higher values will narrow the area.
HIGH MID GAIN (High Middle Gain)	
-12~+12dB	Adjusts the high-middle frequency range tone.

NS (Noise Suppressor)

Parameter/Range	Explanation
NS	
-20~20dB	This controls the global threshold level for the noise suppressor settings in each patch. This feature is effective when you connect a different guitar or for adjusting for changes in noise levels in the performance venue. It does not affect the settings in each individual patch. MEMO To use the settings contained in the individual patches, set this to 0 dB.

REVERB

Parameter/Range	Explanation
REVERB	
0~200%	This controls the global reverb level for the reverb settings in each patch. Adjusting this reverb level is effective for adjusting to the acoustics of the performance space. It does not affect the settings in each individual patch. MEMO To use the settings contained in the individual patches, set this to 100%.

SUB OUT LEVEL

Parameter/ Range	Explanation
SUB OUT LEVEL	
0–200%	This controls the global output level from the SUB OUT connectors. It does not affect the settings in each individual patch. MEMO To use line level (+4 dBu) as the output level, set this to 100%.

TUNER

MULTI MODE, SINGLE MODE

Parameter/ Range	Explanation
PITCH	
435–445Hz	This sets the reference pitch.
MUTE	
This setting selects whether or not the tuning sound is output from the connected device (such as an amp).	
OFF	The tuning sound is not output.
ON	The tuning sound is output.

Chapter 10 Appendices

MIDI Implementation Chart

V-Guitar System
Model VG-99

MIDI Implementation Chart (Main Section)

Date : May. 31, 2007
Version : 1.00

Function...		Transmitted	Recognized	Remarks
Basic Channel	Default Changed	1-16 1-16	1-16 1-16	Memorized
Mode	Default Messages Altered	x x *****	x x	
Note Number	True Voice	x *****	x *****	
Velocity	Note ON Note OFF	x x	x x	
After Touch	Key's Ch's	x x	x x	
Pitch Bend		o *1	x	
Control Change	0, 32 1 - 31 33 - 63 64 - 95	o *1 o *1 o o *1	o o x o	Bank Select
Program Change	True #	o *1 0 - 127	o 0 - 127	
System Exclusive		o	o	
Common	Song Position Song Select Tune Request	x x x	x x x	
System Realtime	Clock Commands	x o *2	o *1 x	
AUX Messages	Local ON/OFF All Notes OFF All Sound OFF Reset All Controller Active Sense System Reset	x x x x o x	x x x x o x	
Notes		*1 O X is selectable. *2 MIDI START/STOP can be set with SYSTEM - CONTROL ASSIGN.		

Mode 1: OMNI ON, POLY
Mode 3: OMNI OFF, POLY

Mode 2: OMNI ON, MONO
Mode 4: OMNI OFF, MONO

o: Yes
x: No

Chapter 10 Appendices

V-Guitar System

Date : May. 31, 2007

Model VG-99

MIDI Implementation Chart (GUITAR TO MIDI Section)

Version : 1.00

Function...		Transmitted	Recognized	Remarks
Basic Channel	Default	1-11	x	Memorized
	Changed	1-11	x	
Mode	Default	Mode 3, 4 (M=6)	Mode 3, 4 (M=6)	Memorized
	Messages Altered	x *****	x	
Note Number	True Voice	o	x	
		0-127	*****	
Velocity	Note ON	o	x	
	Note OFF	x *2	x	
After Touch	Key's Ch's	x	x	
		x	x	
Pitch Bend		o *3	x	
Control Change	0, 32	o *1	x	Bank Select
	1 - 31	o *1	x	
	33 - 63	x	x	
	64 - 95	o *1	x	Data Entry NRPN LSB, MSB RPN LSB, MSB
	6, 38	o	x	
	98, 99	x	x	
	100, 101	o	x	
Program Change	True #	o *1	x	
		0 - 127	*****	
System Exclusive		x	x	
Common	Song Position	x	x	
	Song Select	x	x	
	Tune Request	x	x	
System Realtime	Clock Commands	x	x	
		x	x	
AUX Messages	Local ON/OFF	x	x	
	All Notes OFF	x	x	
	All Sound OFF	x	x	
	Reset All Controller	x	x	
	Active Sense	o	x	
	System Reset	x	x	
Notes	*1 O X is selectable. *2 Note On is always transmitted with 9nH kkH 00H. *3 Can be set with the CHROMATIC parameter.			

Mode 1: OMNI ON, POLY
Mode 3: OMNI OFF, POLY

Mode 2: OMNI ON, MONO
Mode 4: OMNI OFF, MONO

o: Yes
x: No

V-LINK Correspondence Table

V-LINK Function	Transmitted MIDI Message	Transmitted Channel
These are used with models such as the DV-7PR or the motion dive .tokyo performance package.		
PALETTE 1–32 (Palette Change)	CC 0 (Bank Select MSB): 0–31 CC 32 (Bank Select LSB): 0	ch.A / ch.B
CLIP 1–32 (Clip Change)	Program Change: 0–31	ch.A / ch.B
These are used with the motion dive .tokyo performance package.		
COLOR EQ–FG	CC 1 (Modulation)	ch.A & ch.B
COLOR EQ–BG	CC 71 (Resonance)	ch.A & ch.B
SCRATCH SW	CC 3 (---)	ch.A & ch.B
SPEED KNOB	CC 8 (Balance)	ch.A & ch.B
TOTAL FADER	CC 10 (Panpot)	ch.A
CROSS FADER	CC 11 (Expression)	ch.A
BPM SYNC	CC 64 (Hold 1)	ch.A & ch.B
CLIP LOOP	CC 65 (Portamento)	ch.A & ch.B
ASSIGN KNOB	CC 72 (Release)	ch.A & ch.B
FADE TIME	CC 73 (Attack)	ch.A
VISUAL KNOB	CC 74 (Cutoff)	ch.A
AB SW	CC 81 (General Purpose 6)	ch.A
TAP SW	CC 83 (General Purpose 8)	ch.A
TOTAL SELECT	CC 85 (---)	ch.A
FX SELECT	CC 86 (---)	ch.A
PLAY POS	CC 91 (Reverb)	ch.A & ch.B
LOOP START	CC 92 (Tremolo)	ch.A & ch.B
LOOP END	CC 93 (Chorus)	ch.A & ch.B
LAYER MODE	CC 94 (Celeste)	ch.A
These are used with models such as the DV-7PR.		
PLAY SPEED	CC 8 (Balance)	ch.A
DISLV TIME	CC 73 (Attack)	ch.A
T BAR	CC 11 (Expression)	ch.A
COLOR Cb	CC 1 (Modulation)	ch.A
COLOR Cr	CC 71 (Resonance)	ch.A
BRIGHTNESS	CC 74 (Cutoff)	ch.A
VFX 1	CC 72 (Release)	ch.A
VFX 2	CC 91 (Reverb)	ch.A
VFX 3	CC 92 (Tremolo)	ch.A
VFX 4	CC 93 (Chorus)	ch.A
OUTPUT FADE	CC 10 (Panpot)	ch.A
DUAL STREAM	CC 64 (Hold 1)	ch.A

Signal Flow

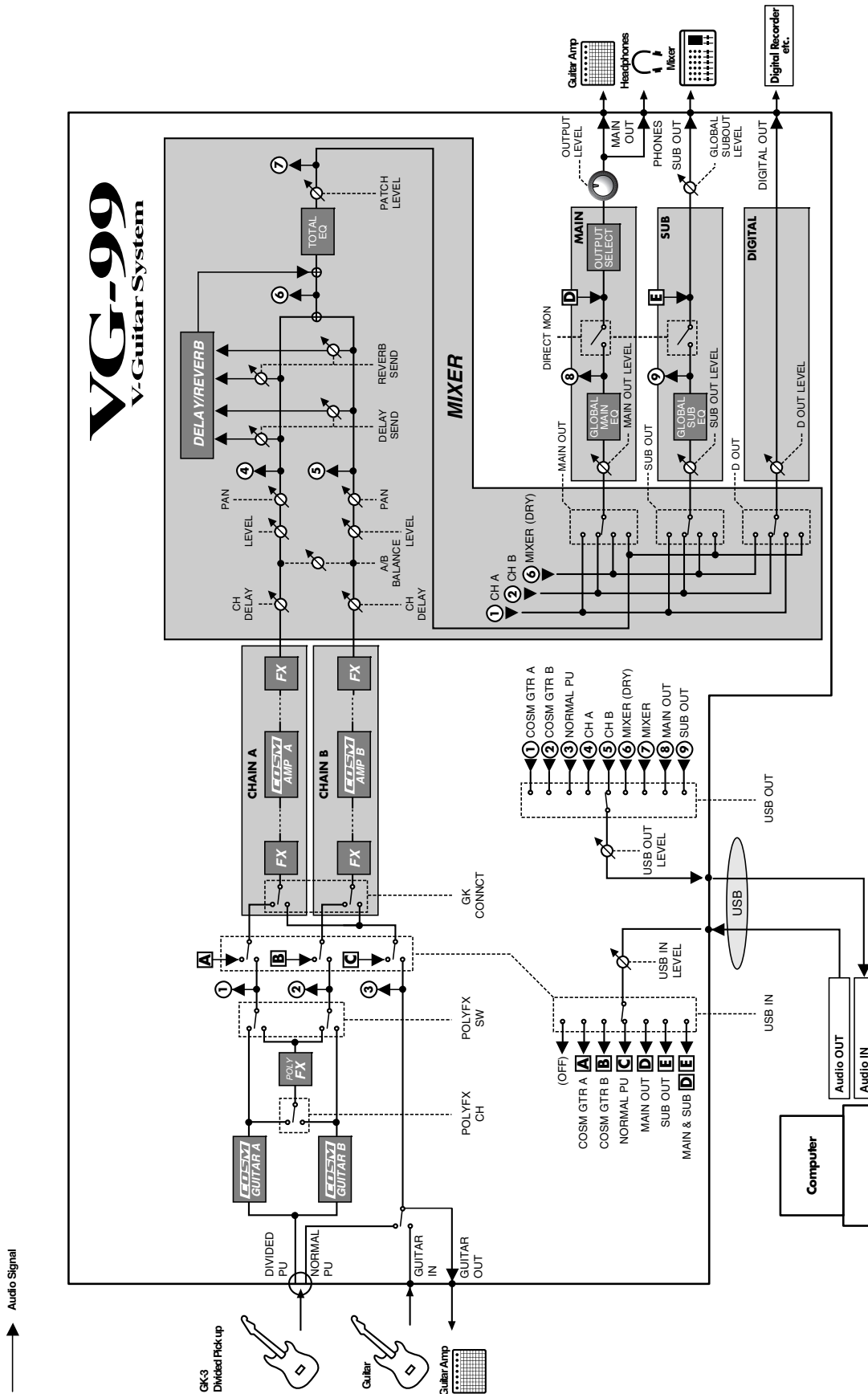

Specifications

VG-99: V-Guitar System

AD Conversion

24 bits + AF method

DA Conversion

24 bits

Sampling Frequency

44.1 kHz

Program Memories

400: 200 (User) + 200 (Preset)

Nominal Input Level

GUITAR INPUT: -10 dBu

Input Impedance

GUITAR INPUT: 2.2 M ohms

Nominal Output Level

MAIN OUT: -10 dBu

SUB OUT (XLR): +4 dBu

GUITAR OUT: -10 dBu

Output Impedance

MAIN OUT: 1 k ohm

SUB OUT (XLR): 600 ohms

Dynamic Range

100 dB or greater (IHF-A)

Controls

[Top Panel]

OUTPUT LEVEL knob

Function knobs x 6 (F1-F6)

BALANCE knob

PATCH LEVEL knob

V-LINK button

DIRECT PATCH buttons x 5 (1-5)

CONTROL buttons x 2 (1, 2)

COSM GUITAR MODELING TYPE buttons x 2 (A, B)

COSM GUITAR ALTERNATE TUNING button

POLY FX A/B buttons x 2 (A, B)

FX buttons x 2 (A, B)

COSM AMP buttons x 2 (A, B)

MIXER buttons x 2 (A, B)

DELAY/REVERB button

DYNAMIC button

CHAIN button

CONTROL ASSIGN button

NAME/KEY/BPM button

Function buttons x 6 (F1-F6)

EXIT button

WRITE button

PAGE buttons x 2 (Left, Right)

GUITAR TO MIDI button

SYSTEM button

GLOBAL button

TUNER button

CATEGORY button

PATCH/VALUE dial

Power switch

D BEAM

D Beam Controller

PITCH button

FILTER button

ASSIGNABLE button

RIBBON CONTROLLER

Ribbon Controller

PITCH button

FILTER button

ASSIGNABLE button

[Rear Panel]

Ground Lift switch (SUB OUT)

Display

240x64 dots graphic LCD (with backlit)

Connectors

[Top Panel]

GK IN connector (13-pin DIN type)

[Rear Panel]

GUITAR INPUT jack (1/4" phone type)

GUITAR OUTPUT jack (1/4" phone type)

SUB OUT jacks x 2 (L, R) (XLR type)

MAIN OUT jacks x 2 (L/MONO, R) (1/4" phone type)

PHONES jack (Stereo 1/4" phone type)

DIGITAL OUT jack (Coaxial type, conforms to IEC60958-3)

EXP PEDAL jack (1/4" TRS phone type)

CTL 3,4 jack (1/4" TRS phone type)

USB connector (B type)

RRC2 IN connector (RJ45 type)

MIDI connectors x 2 (IN, OUT) (5-pin DIN type)

DC IN jack

Power Supply

AC Adaptor (PSB-1U)

Current Draw

1.3 A

Dimensions

384.0 (W) x 218.0 (D) x 93.5 (H) mm

15-1/8 (W) x 8-5/8 (D) x 3-11/16 (H) inches

* EIA-5U rack mount type: optional rack mount adaptor RAD-99

Weight

2.1 kg / 4 lbs 11 oz (excluding AC Adaptor)

Accessories

Owner's Manual

GK cable (3 m)

USB cable

RRC2 cable

VG-99 Software CD-ROM

AC adaptor (PSB-1U)

Knob Bolt x 4

Roland Service (information sheet)

Options

Divided Pickup: GK-3

MIDI Foot Controller: FC-300

Footswitch: BOSS FS-5U/6

Expression Pedal: EV-5, BOSS FV-500L/500H

GK Cable: GKC-10/5/3

Unit Selector: US-20

GK Parallel Box: GKP-4

Rack Mount Adaptor: RAD-99

Pad Stand: PDS-10

Footswitch Cable: PCS-31

* $0\text{ dBu} = 0.775\text{ V rms}$

* *In the interest of product improvement, the specifications and/or appearance of this unit are subject to change without prior notice.*

VG-99 Software System Requirements

For Windows

Operating System

- Microsoft Windows XP
- Microsoft Windows Vista

CPU/Clock

- Pentium/Celeron, Intel-compatible processor 1 GHz or higher

RAM

- 512 MBytes or more

Free space required on hard disk

- 190 MBytes or more

Display resolution/Color depth

- 1024 x 768 or higher / 65,536 colors (16 bit High Color) or more

For Mac OS

Operating System

- Mac OS X 10.4.3 or later

CPU/Clock

- PowerPC G4, G5/1 GHz or higher
- Intel processor

RAM

- 512 MBytes or more

Free space required on hard disk

- 190 MBytes or more

Display resolution/Color depth

- 1024 x 768 or higher / 32,000 colors or more

NOTE

Although Roland has tested numerous configurations, and has determined that on average, a computer system similar to that described above will permit normal operation of the VG-99 Editor and VG-99 Librarian, Roland cannot guarantee that a given computer can be used satisfactorily with the VG-99 Editor and VG-99 Librarian based solely on the fact that it meets the above requirements. This is because there are too many other variables that may influence the processing environment, including differences in motherboard design and the particular combination of other devices involved.

Error Messages

If there has been a mistake in an operation or if the operation is not executed properly, an error message will appear in the display. Please follow the instructions indicated in the message to resolve the issue.

“DATA WRITE ERROR”

- Writing to the memory for storage of user data failed.
- The unit may be damaged. Consult the nearest Roland service center.

“MIDI BUFFER FULL”

“RRC2 BUFFER FULL”

“USB BUFFER FULL”

- The data cannot be processed correctly due to the high volume of MIDI messages.
- Reduce the volume of MIDI messages transmitted to the VG-99.

“MIDI OFFLINE”

“RRC2 OFFLINE”

“USB OFFLINE”

- Transmissions from the connected device have been interrupted. This message also appears when the power to the connected device has been turned off. It does not indicate damage.
- Check to make sure no cable is disconnected and that there are no shorts.

“OUT OF RANGE! SET AGAIN”

- The D Beam controller or ribbon controller cannot be calibrated.
- If using the D Beam controller, change the range or position and recalibrate to keep this message from appearing.
- If using the ribbon controller, confirm the calibration by carrying out the procedure once more.

If the message continues to appear even after the calibration is correctly performed, it may indicate damage or malfunction. Consult your Roland dealer or contact Roland Service.

“USB DEVICE ERROR”

- Initialization of the VG-99's internal USB device failed. USB cannot be used.
- The unit may be damaged. Consult the nearest Roland service center.

Troubleshooting

If the VG-99 is not producing sounds or if you think it is not operating properly, first check the following points. If checking these points fails to resolve the problem, consult your dealer or the nearest Roland service center.

MEMO

For more on the USB drivers and problems when using the drivers, refer to the following file contained on the VG-99 Software CD-ROM.

OS	Location
Windows XP	\Driver\XP\Readme_E.htm
Windows Vista	\Driver\Vista\Readme_E.htm
Mac OS X	/Driver/Readme_E.htm

Problems with Sounds

No sound/Low volume

- Is there a short in any connecting cable?**
→ Try replacing the connecting cable.
- Are the VG-99 and other devices connected properly?**
→ Check the connections with the other devices (p. 16).
- Is the power to the connected amp or mixer not turned on, or is the volume turned down?**
→ Check the settings for the connected device.
- Is the OUTPUT LEVEL knob turned down completely?**
→ Adjust the knob to an appropriate setting (p. 20).
- Is the tuner on?**
→ The direct sound is not output when the tuner is on if the volume setting during tuning is set to MUTE ON (p. 22).
- Is the [SYSTEM] - GK - GK CONNCT set properly?**
→ If a Divided pickup is connected: set [SYSTEM] - GK - GK CONNCT to ON (if AUTO does not function well).
→ If a Divided pickup is not connected: set [SYSTEM] - GK - GK CONNCT to OFF.
- Is [COSM GUITAR A] or [COSM GUITAR B] switched on?**
→ No sounds from the Divided pickup will be played if [COSM GUITAR] is switched off. Switch on the [COSM GUITAR].
- Is [A/B BALANCE] set correctly?**
→ Set [A/B BALANCE] for the channel in which sounds are being played.

- ❑ **Is each effect set correctly?**
 - Use the “Meter function” (p. 34) in [CHAIN] to confirm the output level of each effect. If the meter for any effect is not fluctuating, check the settings for that effect.
- ❑ **Are volume parameters such as GUITAR:VOLUME, FV:LEVEL, and PATCH LEVEL set to the assigned targets?**
 - Operate these in accordance with the sources.
- ❑ **Are the OUTPUT settings properly made?**
 - Check the output settings for [SYSTEM] - OUTPUT and [MIXER] - OUTPUT.
- ❑ **If there are no sounds through USB, are the [SYSTEM] - USB settings correct?**
 - Adjust the settings to the appropriate values (p. 73) (p. 173).
- ❑ **If there are no sounds through USB, is [SYSTEM] - GK SETTING correctly set?**
 - When GK CONNCT is set to OFF (or if the divided pickup is not connected), audio input via USB may not be output. Be sure to set the appropriate value (p. 166).
- ❑ **Is the [SYSTEM] - USB - DIRECT MON (p. 173) switched off?**
 - Set this to ON.

Low volume for device connected to INPUT

- ❑ **Could you be using an audio cable that incorporates a resistor?**
 - Use only connecting cables (such as one from the Roland PCS Series) that don't contain a resistor.

Oscillating sound audible

- ❑ **Are any gain values or volume-related parameter values in the effect settings set too high?**
 - Lower the values.
- ❑ **Is [SYSTEM] - USB - USB IN (p. 173) set to anything other than OFF?**
 - When set to anything other than OFF, the software settings may cause looping of the audio signals. If this occurs, you can use any of the following methods to avoid the problem.
 - Stop playback with the software, or set Soft Thru to OFF.
 - Switch off the software's audio input.
 - Change the [SYSTEM] - USB - USB IN setting to OFF.

No stereo effect produced

- ❑ **Do you have a monaural effect or COSM amp connected after the stereo effect (STRING PAN, CHORUS, etc.)?**
 - Passing the signal through a monaural effect or COSM amp cancels the stereo effect. Press [CHAIN] to confirm the effect connection sequence (p. 34).

Cannot change parameters with knobs or PATCH/VALUE dial

- ❑ **Are you using INTERNAL PEDAL (p. 155) with Control Assign?**
 - When INTERNAL PEDAL or WAVE PEDAL is used for the assign source, the effect parameters set as the assign targets change automatically. If you want to change parameters with the knobs or PATCH/VALUE dial, first switch off Control Assign and cancel the INTERNAL PEDAL setting.
- ❑ **Is the source in Control Assign set to INPUT LEVEL (p. 155)?**
 - When the assign source is set to INPUT LEVEL, the effect parameters set as the assign targets automatically change according to the input level from the guitar (the performance dynamics). If you want to change parameters with the knobs or PATCH/VALUE dial, first switch off Control Assign.

Other Problems

Unable to save SYSTEM/USB USB IN settings

- If the USB IN parameter is set to COSM GTR A, COSM GTR B, or NORMAL PU, then MAIN & SUB will be set the next time the VG-99 is powered up. If you plan to use COSM GTR A, COSM GTR B, or NORMAL PU, remake this setting each time you turn on the power to the VG-99 (p. 173).

Patches not switching

- Is some screen other than the Play screen shown in the display?**
 - With the VG-99, you cannot switch patches in any screen other than the Play screen. Press [EXIT] one or more times to return to the Play screen (p. 19).
- Is [SYSTEM] - MISC - PATCH EXTENT set correctly?**
 - The range of patches that can be selected is limited by the PATCH EXTENT setting. Be sure to set this correctly.

Unable to control parameters set with Assign as expected

- Are the effects switched off?**
 - Check to make sure the effects incorporating the parameters being controlled are on.
- Is the patch set to anything other than ASSIGNABLE (PATCH) in [SYSTEM] - CONTROL ASSIGN?**
 - Even with the patch's [CONTROL ASSIGN] setting made, the settings made in [SYSTEM] - CONTROL ASSIGN are given priority.
To enable the settings in the patch, set the controllers under [SYSTEM] - CONTROL ASSIGN to ASSIGNABLE (PATCH).
- Are the MIDI channels matched?**
 - When carrying out operations using MIDI, check to confirm that both devices are set to the same MIDI channel (p. 58).
- Are the controller numbers (CC#) matched?**
 - Check to confirm that the controller numbers you are using are the same (p. 62).

MIDI messages not being transmitted/received

- Could there be a short in the MIDI cable?**
 - Try replacing the MIDI cable.

- Are the VG-99 and the external MIDI device connected properly?**
 - Check the connection with the external MIDI device.
- Are the MIDI channels matched?**
 - Check to confirm that both devices are set to the same MIDI channel (p. 58).
- If you are transmitting from the VG-99, have the settings for transmission been made?**
 - Check the Program Change message transmission ON/OFF setting (p. 60) and the settings for the controller number to be transmitted (p. 62).

Index

Symbols

-1OCTAVE LEVEL	119
+1OCTAVE LEVEL	119

Numerics

12STR	117
12-STRING	26, 28, 116
1st–6th	117, 175
2x2 CHORUS	127, 132
335	103

A

A ch/B ch CLIP	174
A ch/B ch PALETTE	174
A/B	116
A/B BAL	146
A/B COPY	88
A/B EXCHANGE	88
AB LINK	26, 116
AC	102, 105
AC TYPE	101
Acoustic Guitar	105
ADV.COMP	127, 136
Alternate Tuning	26
ALTERNATE TUNING Button	12
AMP CONTROL	163
AMP CTL1	163
AMP CTL2	163
ANGLE	104
ANTI FB	127, 136
ASSIGN	82, 150
ASSIGN 1–16	155
ASSIGN 1–2	174
ASSIGN HOLD	50, 167
ASSIGNABLE	152–153
ATTACK	106–107, 111, 118, 120, 135–137, 152
ATTACK LENGTH	114
ATTACK LEVEL	106, 114
AUTO WAH	127, 129

B

BALANCE Knob	13
BANJO	106
BANK CHANGE	169
BANK LSB	163, 165
BANK MSB	163, 165
BASIC CH	165
BASS	102, 109, 141, 143–145
BASS AMP	141
BASS AMP MODERN	145
BASS AMP VINTAGE	144
BASS FREQ	143
Bass Guitar	109
BASS TYPE	101
BEND	26–27, 116–117
BEND THIN	165
BEND TUNING 1st–6th	117
BG LEAD	140–141

BODY	105–107
BODY LEVEL	114
BODY TYPE	105, 107
BOTTOM	121, 143
BOWED/PIPE	112
BPM	163
BRASS	114
BRIGHT	141, 143–144
BULK DUMP	171
Bulk Dump	62
Bulk Load	63
BUZZ	106

C

CABINET	142, 144
CALIBRATION	76, 78
CATEGORY	90, 163
CATEGORY Button	12
CATEGORY NAME	91
CC	69, 165, 171
CH DELAY	146
CHAIN	32
CHAIN Button	13
CHORUS	126
CHORUS MODE	126
CHORUS SW	126
CHROMATIC	164
CLA-ST	103
CLIP	174
COLOR	106, 113
COMBO	140–141
COMP	110, 120
COMP BAL	118
COMP SW	120
COMP TYPE	118
Compressor	120
Connection	16
connection point	34
CONTRAST	166
Contrast	51
CONTROL ASSIGN	82, 150, 167
CONTROL ASSIGN Button	13
CONTROL Buttons	13
Controller	167
Cord Hook	14
COSM	11
COSM AMP	30, 140
COSM AMP Buttons	12
COSM AMP SW	140
COSM Amps	25
COSM GTR SW	101
COSM GUITAR	101, 105, 108, 110, 115
COSM Guitars	25
CRUNCH	140–141
CRYSTL	114
CTL3	154
CTL3,4 Jack	14
CTL4	154

FILTER DEPTH 115
 FILTER RESO 112–114
 FILTER TYPE 115
 FINE 1st–6th 117
 FINE1 130
 FINE2 130
 FLANGER 128
 FLANGR 127
 Foot Volume 139
 FORM 156, 175
 FREEZE 79
 FREEZE CH 152
 FREQ 129, 136
 FREQ MAX 152–153
 FREQ MIN 152–153
 FREQ1–3 136
 Fretless Guitar 135
 FRONT VOL 109
 FUNCTION Buttons 12
 FUNCTION Knob 12
 FV 139
 FX 31, 120
 FX Buttons 12

G

GAIN 141, 143–145
 GAIN SW 141, 143
 Gap 44
 GATEWAY NAME 176
 GK CONNCT 45, 166
 GK FUNC 46, 166
 GK IN Connector 13
 GK NAME 42
 GK PU DIRECTION 167
 GK PU PHASE 167
 GK PU TYPE 167
 GK S1, S2 166
 GK SETTING 166
 GK Settings 21
 GK VOL 150, 166
 GLIDE SENS 112
 GLIDE TIME 112
 GLOBAL 177
 GLOBAL Button 13
 GLOBAL EQ 48
 GLOBAL NAME 47
 GLOBAL/OUTPUT SELECT 46
 GND LIFT Switch 14
 GR-300 110
 GTR TO MIDI 164
 GUITAR INPUT Jack 14
 GUITAR OUTPUT Jack 14
 GUITAR SCALE 167
 GUITAR TO MIDI 64, 164
 GUITAR TO MIDI Button 13
 Guitar's Scale 43

H

HARM1 131
 HARM2 131
 HARMO 117
 HARMONIST 127, 130
 Harmonist Scale 131
 HARMONY 26, 30, 116
 Harmony Scale 117
 HARMONY1 131
 HARMONY2 131
 HI-GAIN 140–141
 HIGH 121, 142–144
 HIGH CUT 123–124, 126, 137, 148
 High Cut 126
 HIGH DEPTH 132
 HIGH GAIN 104, 108–109, 115, 123, 137, 146, 177
 HIGH LEVEL 132
 HIGH MID FREQ 104, 108–109, 115, 123, 137, 146, 177
 HIGH MID GAIN 104, 108–109, 115, 123, 137, 146, 177
 HIGH MID Q 104, 108–109, 115, 123, 137, 146, 177
 HIGH PREDLY 132
 HIGH RATE 132
 HIGH-CUT 118
 HOLD CTL 165
 Hold Delay 125
 HOLD TYPE 69, 164
 HUMANIZER 127, 134

I

IN LEVEL 73, 173
 Internal Pedal 95
 Internal Pedal System 95

J

JB 109
 JC CLEAN 140–141

K

KEY 117, 130, 163
 Key 33

L

L4 103
 LCD 12, 51
 LCD CONTRAST 166
 LEVEL 105–107, 110, 118, 120,
 122, 129, 133–134, 136–137,
 139, 141, 143–146, 148, 152–153
 LEVEL 1st–6th 117
 LEVEL DEPTH 125
 LEVEL1 130–131
 LEVEL2 130–131
 LIMITR 127, 137
 LINE/PHONES 47
 LIPS 103
 LOW 121, 142–144
 LOW CUT 107, 123, 126, 128, 137, 148
 LOW DEPTH 132

LOW GAIN 104, 108–109, 115, 123, 137, 146, 177
 LOW LEVEL 132
 LOW MID FREQ . 104, 108–109, 115, 123, 137, 146, 177
 LOW MID GAIN . 104, 108–109, 115, 123, 137, 146, 177
 LOW MID Q 104, 108–109, 115, 123, 137, 146, 177
 LOW PREDLY 132
 LOW RATE 132
 LOWER BAL 149
 LOWER LEV 149
 LOWER RNG 149
 LP 103

M

MAIN EQ 177
 MAIN EQ SW 177
 MAIN LEVEL 147, 172
 MAIN OUT 147, 172
 MAIN OUT Jacks L/MONO, R 14
 MAIN OUTPUT SELECT 177
 MANUAL 127–128, 134
 MASTER 150
 MASTER VOL 109
 MAX 150–154, 156, 174
 METAL 141
 MIC DIS 142, 144
 MIC LEVEL 142, 144–145
 MIC POS 142, 144–145
 MIC TYPE 142, 144
 MIDDLE 141, 143–145
 MIDDLE FREQ 144–145
 MIDI 55, 170
 MIDI A CH 176
 MIDI B CH 176
 MIDI C CH 176
 MIDI CH 170, 176
 MIDI Device ID 59
 MIDI IN 170
 MIDI Omni Mode 59
 MIDI OUT 170
 MIDI OUT, IN Connector 14
 MIDI PC OUT 60
 MIN 150–154, 174
 Mix Balance 35
 MIX LEVEL 105, 108, 110, 115
 MIX SW 146
 MIXER 35, 146
 Mixer 25
 MIXER A 146
 MIXER B 146
 MIXER Buttons 12
 MOD 125
 MOD 1 TYPE 127
 MOD 2 TYPE 127
 MOD DEPTH 114, 125
 MOD RATE 125
 MOD TUNE 114
 MOD1 127
 MOD1 SW 127

MOD2 127
 MOD2 SW 127
 MODE 110, 118, 129, 134–136, 150, 164
 MODE1 130
 MODE2 130
 MODELING TYPE Buttons 12
 MODLNG TYPE 101
 MOD-ST 103
 MODULE COPY 89
 MODULE INITIALIZE 89
 MON CMD 74, 173
 MS STACK 140–141
 MULTI MODE 23, 178
 MUTE 178

N

NAME
 CATEGORY 91, 176
 FAVORITE 94
 GK 42, 166
 GLOBAL 47
 PATCH 37, 163
 NAME/KEY/BPM 163
 NAME/KEY/BPM Button 13
 Noise Suppressor 138
 Normal Pickup Phase 43
 Normal Pickup Sound 30, 34
 NORMAL PU 105, 108, 110, 115
 NOW SHUTDOWN.. 24
 NS 105, 108, 110, 138, 177
 NS SW 138
 NUMBER 142, 144
 NYLON 106

O

OCTAVE 127, 129
 OCTAVE LEVEL 129
 OD/DS 120
 OD/DS SW 120
 OMNI MODE 170
 ORGAN 114
 OUT LEVEL 73, 173
 OUTPUT 147, 172
 OUTPUT LEVEL Knob 13
 OUTPUT SELECT 47
 Output Select 20
 Output Signal and Level 37
 Overdrive/Distortion 40, 120

P

P90 103
 PAGE Button 13
 PAN 124, 127–128, 146
 PANEL CTL1/CTL2 151
 PATCH 164
 COPY 87
 EXCHANGE 87
 EXTENT 50, 176

- INITIALIZE 88
 LEVEL 146, 163
 NAME 37, 163
 Patch 23
 PATCH LEVEL Knob 13
 Patch Numbers 23
 Patch Volume Level 36
 PATCH/VALUE Dial 12, 24
 PATTERN 134
 PC 70, 163, 165, 171
 PC MASK 165
 PC OUT 171
 PEAK 129
 PEDAL BEND 127, 132
 PEDAL POS 122, 132
 Pedal Wah 41
 PHASE 104
 PHASER 127
 PHONES Jack 14
 PICKUP÷BRIDGE 1st–6th 167
 PITCH 151, 153, 178
 PITCH 1 130
 PITCH A 111
 PITCH A FINE 111
 PITCH B 111
 PITCH B FINE 111
 PITCH MAX 132
 PITCH MIN 132
 PITCH SHIFT 127, 130
 PITCH SHIFT1 130
 PITCH SHIFT2 130
 PITCH SW 111
 PITCH TYPE 151
 PITCH2 130
 PLAY FEEL 164
 Play Screen 19
 POLARITY 129
 POLY BAL 118
 POLY COMP 118
 Poly Compressor 118
 POLY DIST 118
 Poly Distortion 118
 Poly Effect 31, 118
 Poly Effects 25
 POLY FX 31, 118
 POLY FX Buttons 12
 POLY OCTAVE 119
 Poly Octave 119
 POLY SG 119
 Poly Slow Gear 119
 POLYFX CH 118
 POLYFX SW 118
 POS 103
 POWER BEND 112
 POWER BEND Q 112
 POWER Switch 13
 PRE DELAY 126, 148
 PRE DELAY1 130–131
 PRE DELAY2 130–131
 PREAMP TYPE 140
 PRESENCE 122, 141, 143
 Preset Patches 23
 PU 106
 PU LEVEL 107
 PU SEL 103
 PU TONE 107
 PU TYPE 107
 PWM 114
 PWM DEPTH 114
 PWM RATE 114
- Q**
- Q 122
 QUICK TUNER 53, 169
- R**
- Rack 99
 RANGE 129
 RANGE HIGH 122, 150, 152–154, 156
 RANGE LOW 122, 150, 152–154, 156
 RATE 111, 126–129, 133–134, 156, 175
 RATE FAST 133
 RATE SLOW 133
 RATIO 137
 REAR VOL 109
 Reference Pitch 22
 REL 105, 108, 110, 118, 120, 137–138, 152
 Related to the FC-300 52
 RELEASE 149
 RESO 106–107, 110, 115, 127–128, 135, 152–153
 RESPONSE 144
 REVERB 126, 148, 177
 REVERB A SEND 146
 REVERB B SEND 146
 REVERB SW 126, 148
 REVERB TIME 126
 R-FIER 140
 R-FIRE 141
 RIBBON 153
 RIBBON CONTROLLER 13
 Ribbon Controller 79
 RICK 103
 RING MOD 127, 136
 RISE 111
 RISE TIME 119, 125, 133, 135
 RISE TIME+ 135
 ROTARY 127, 133
 RRC2 IN Connector 14, 52
 RRC2" 170
 RRC2Æ 170
 RX PC MAP 61, 171
- S**
- S1, S2 POS 167
 Saving a Patch 38
 Security Slot 14

- SENS 106, 111, 119, 129, 134–135
- SENS 1st–6th 167
- Sensitivity for Each String 45
- SEPARATION 128
- SEQ 123
- SET MODE 46, 166
- SETTING1–10 166
- SHIFT 1st–6th 117
- Signal Flow 183
- SINGLE MODE 23, 178
- SITAR 106
- SIZE 107, 142, 144
- SLICER 127, 134
- SLOW GEAR 127, 135
- SOLO 113
- SOLO LEVEL 141, 143
- SOLO SW 141, 143
- SOURCE 174
- SP TYPE 142–145
- Speaker 40
- Specifications 184
- SPEED 133
- SRC 165
- Stand 98
- STEEL 105
- STEP RATE 127
- STRING 103
- STRING CH 175
- STRING LEVEL 1st–6th 104, 108–109, 115
- STRING PAN 1st–6th 104, 108–109, 115
- SUB DELAY 127, 138
- SUB EQ 127, 177
- SUB EQ SW 177
- SUB LEVEL 147, 172
- SUB OUT 147, 172
- SUB OUT Connectors L, R 14
- SUB OUT LEVEL 49, 178
- SUSTAIN 107, 112–114, 118, 120, 136
- SW 105, 108, 110–111, 116–117, 150–154
- SW MODE 151, 154, 156
- SWEEP 111
- SYNC CLOCK 59, 170
- SYNTH 102, 110
- SYNTH TYPE 101
- Synthesizer 110
- SYS EX MODE 169
- SYSTEM 42, 165–166
- SYSTEM Button 13
- SYSTEM CONTROL ASSIGN 49
- SYSTEM OUTPUT 51
- T**
- T.WAH 127, 129
- T-AMP 140–141
- TAP TIME 124
- TARGET 174
- TARGET PARAMETER 150–154, 156–157
- T-ARM 80
- T-ARM CH 151, 153
- TE 103
- Tempo 32
- THRSH 105, 108, 110, 118, 120, 137–138
- TIME 148, 156, 175
- TONE 103, 105–107, 109, 118, 120–121, 135–136
- TOP 121
- TOTAL EQ 36, 146
- TOTAL GAIN 104, 108–109, 115, 123, 137, 146, 177
- Total NS 48
- Total REVERB 49
- TOUCH SENS 112–114
- TOUCH WAH 129
- TREBLE 141, 143–145
- TREBLE FREQ 143
- TREML 127
- TREMOLO 128
- TRIG 133
- TRIG SENS 134
- TRIGGR 156, 175
- Troubleshooting 186
- TUNER 22, 178
- TUNER Button 13
- TUNING 26–27, 116
- TW 129
- TW CLEAN 140–141
- TX PC 163
- TX PC MAP 60, 171
- TX PC STRING 1–6 165
- TYPE 103, 116, 118, 120–122, 126–127, 136–137, 148–149, 151–153
- U**
- UNI-V 127, 133
- UPPER BAL 149
- UPPER LEV 149
- UPPER RNG 149
- USB 71, 173
- USB (MIDI)™ 170
- USB (MIDI)Æ 170
- USB Connector 14
- USB Driver 71
- USB IN 73, 173
- USB OUT 73, 173
- USER INTERVAL C–B 117
- User Patches 23
- User Scale 117, 131
- USER TUNING 29
- USER TUNING 1st–6th 117
- V**
- VARI 103, 107
- VG-99 Editor 72
- VG-99 Librarian 72
- VG-99 Software System Requirements 185
- VIB 127, 133
- VIB DEPTH 135
- VIB RATE 135

VIBRATO	111, 133
V-LINK	11, 96, 174
V-LINK Button	13
V-LINK PATCH	174
V-LINK SYSTEM	176
VOICE	130
VOICE1 INTERVAL C-B	131
VOICE2 INTERVAL C-B	131
VOL	103, 109
VOL CURVE	103, 139
Volume	20
Volume Balance	33
Volume-swell Effect	135
VOWEL1	134
VOWEL2	134
W	
WAH	122
WAH SW	122
WARP	125
WARP SW	125
WAVE	115
WAVE ATTACK	115
WAVE DECAY	115
WAVE LEVEL	115
Wave Pedal	95
WAVE SENS	115
WAVE SHAPE	115, 128
WRITE Button	13
WSY	123
X	
X-OVER FREQ	132



MEMO

有关产品中所含有害物质的说明

本资料就本公司产品中所含的特定有害物质及其安全性予以说明。
本资料适用于 2007 年 3 月 1 日以后本公司所制造的产品。

环保使用期限



此标志适用于在中国国内销售的电子信息产品，表示环保使用期限的年数。所谓环保使用期限是指在自制造日起的规定期限内，产品中所含的有害物质不致引起环境污染，不会对人身、财产造成严重的不良影响。
环保使用期限仅在遵照产品使用说明书，正确使用产品的条件下才有效。
不当的使用，将会导致有害物质泄漏的危险。

产品中有毒有害物质或元素的名称及含量

部件名称	有毒有害物质或元素					
	铅(Pb)	汞(Hg)	镉(Cd)	六价铬(Cr(VI))	多溴联苯(PBB)	多溴二苯醚(PBDE)
外壳(壳体)	×	○	○	○	○	○
电子部件(印刷电路板等)	×	○	×	○	○	○
附件(电源线、交流适配器等)	×	○	○	○	○	○

○：表示该有毒有害物质在该部件所有均质材料中的含量均在 SJ/T11363-2006 标准规定的限量要求以下。
×：表示该有毒有害物质至少在该部件的某一均质材料中的含量超出 SJ/T11363-2006 标准规定的限量要求。
因根据现有的技术水平，还没有什么物质能够代替它。

For EU Countries



UK This symbol indicates that in EU countries, this product must be collected separately from household waste, as defined in each region. Products bearing this symbol must not be discarded together with household waste.

DE Dieses Symbol bedeutet, dass dieses Produkt in EU-Ländern getrennt vom Hausmüll gesammelt werden muss gemäß den regionalen Bestimmungen. Mit diesem Symbol gekennzeichnete Produkte dürfen nicht zusammen mit dem Hausmüll entsorgt werden.

FR Ce symbole indique que dans les pays de l'Union européenne, ce produit doit être collecté séparément des ordures ménagères selon les directives en vigueur dans chacun de ces pays. Les produits portant ce symbole ne doivent pas être mis au rebut avec les ordures ménagères.

IT Questo simbolo indica che nei paesi della Comunità europea questo prodotto deve essere smaltito separatamente dai normali rifiuti domestici, secondo la legislazione in vigore in ciascun paese. I prodotti che riportano questo simbolo non devono essere smaltiti insieme ai rifiuti domestici. Ai sensi dell'art. 13 del D.Lgs. 25 luglio 2005 n. 151.

ES Este símbolo indica que en los países de la Unión Europea este producto debe recogerse aparte de los residuos domésticos, tal como está regulado en cada zona. Los productos con este símbolo no se deben depositar con los residuos domésticos.

PT Este símbolo indica que nos países da UE, a recolha deste produto deverá ser feita separadamente do lixo doméstico, de acordo com os regulamentos de cada região. Os produtos que apresentem este símbolo não deverão ser eliminados juntamente com o lixo doméstico.

NL Dit symbool geeft aan dat in landen van de EU dit product gescheiden van huishoudelijk afval moet worden aangeboden, zoals bepaald per gemeente of regio. Producten die van dit symbool zijn voorzien, mogen niet samen met huishoudelijk afval worden verwijderd.

DK Dette symbol angiver, at i EU-lande skal dette produkt opsamles adskilt fra husholdningsaffald, som defineret i hver enkelt region. Produkter med dette symbol må ikke smides ud sammen med husholdningsaffald.

NO Dette symbolet indikerer at produktet må behandles som spesialavfall i EU-land, iht. til retningslinjer for den enkelte regionen, og ikke kastes sammen med vanlig husholdningsavfall. Produkter som er merket med dette symbolet, må ikke kastes sammen med vanlig husholdningsavfall.

SE Symbolen anger att i EU-länder måste den här produkten kasseras separat från hushållsavfall, i enlighet med varje regions bestämmelser. Produkter med den här symbolen får inte kasseras tillsammans med hushållsavfall.

FI Tämä merkintä ilmaisee, että tuote on EU-maissa kerättävä erillään kotitalousjätteistä kunkin alueen voimassa olevien määräysten mukaisesti. Tällä merkinnällä varustettuja tuotteita ei saa hävittää kotitalousjätteiden mukana.

HU Ez a szimbólum azt jelenti, hogy az Európai Unióban ezt a terméket a háztartási hulladéktól elkülönítve, az adott régióban érvényes szabályozás szerint kell gyűjteni. Az ezzel a szimbómmal ellátott termékeket nem szabad a háztartási hulladék közé dobni.

PL Symbol oznacza, że zgodnie z regulacjami w odpowiednim regionie, w krajach UE produktu nie należy wyrzucać z odpadami domowymi. Produktów opatrzonych tym symbolem nie można utylizować razem z odpadami domowymi.

CZ Tento symbol udává, že v zemích EU musí být tento výrobek sbírán odděleně od domácího odpadu, jak je určeno pro každý region. Výrobky nesoucí tento symbol se nesmí vyhazovat spolu s domácím odpadem.

SK Tento symbol vyjadruje, že v krajinách EÚ sa musí zber tohto produktu vykonávať oddelene od domového odpadu, podľa nariadení platných v konkrétnej krajine. Produkty s týmto symbolom sa nesmú vyhazovať spolu s domovým odpadom.

EE See sümbol näitab, et EL-i maades tuleb see toode olemprügist eraldi koguda, nii nagu on igas piirkonnas määratletud. Selle sümboliga märgitud tooteid ei tohi ära visata koos olmeprügiga.

LT Šis simbolis rodo, kad ES šalyse šis produktas turi būti surenkamas atskirai nuo buitinių atliekų, kaip nustatyta kiekvienoje regione. Šiuo simboliu paženklinėti produktai neturi būti išmetami kartu su buitinių atliekomis.

LV Šis simbols norāda, ka ES valstīs šo produktu jāievāc atsevišķi no mājsaimniecības atkritumiem, kā noteikts katrā reģionā. Produktus ar šo simbolu nedrīkst izmest kopā ar mājsaimniecības atkritumiem.

SI Ta simbol označuje, da je treba proizvod v državah EU zbirati ločeno od gospodinskih odpadkov, tako kot je določeno v vsaki regiji. Proizvoda s tem znakom ni dovoljeno odlagati skupaj z gospodinskimi odpadki.

GR Το σύμβολο αυτό υποδηλώνει ότι στις χώρες της Ε.Ε. το συγκεκριμένο προϊόν πρέπει να συλλέγεται χωριστά από τα υπόλοιπα οικιακά απορρίμματα, σύμφωνα με όσα προβλέπονται σε κάθε περιοχή. Τα προϊόντα που φέρουν το συγκεκριμένο σύμβολο δεν πρέπει να απορρίπτονται μαζί με τα οικιακά απορρίμματα.

- * Microsoft and Windows are registered trademarks of Microsoft Corporation.
- * Windows Vista is a trademark of Microsoft Corporation.
- * Windows® is known officially as: “Microsoft® Windows® operating system.”
- * Apple and Macintosh are registered trademarks of Apple Inc.
- * Mac OS is a trademark of Apple Inc.
- * Pentium and Celeron are registered trademarks of Intel Corporation.
- * PowerPC is a registered trademark of International Business Machines Corporation.
- * All product names mentioned in this document are trademarks or registered trademarks of their respective owners.

For the U.K.

IMPORTANT: THE WIRES IN THIS MAINS LEAD ARE COLOURED IN ACCORDANCE WITH THE FOLLOWING CODE.

BLUE: NEUTRAL
BROWN: LIVE

As the colours of the wires in the mains lead of this apparatus may not correspond with the coloured markings identifying the terminals in your plug, proceed as follows:

The wire which is coloured BLUE must be connected to the terminal which is marked with the letter N or coloured BLACK.
The wire which is coloured BROWN must be connected to the terminal which is marked with the letter L or coloured RED.
Under no circumstances must either of the above wires be connected to the earth terminal of a three pin plug.

For EU Countries



This product complies with the requirements of European Directive 89/336/EEC.

For the USA

FEDERAL COMMUNICATIONS COMMISSION RADIO FREQUENCY INTERFERENCE STATEMENT

This equipment has been tested and found to comply with the limits for a Class B digital device, pursuant to Part 15 of the FCC Rules. These limits are designed to provide reasonable protection against harmful interference in a residential installation. This equipment generates, uses, and can radiate radio frequency energy and, if not installed and used in accordance with the instructions, may cause harmful interference to radio communications. However, there is no guarantee that interference will not occur in a particular installation. If this equipment does cause harmful interference to radio or television reception, which can be determined by turning the equipment off and on, the user is encouraged to try to correct the interference by one or more of the following measures:

- Reorient or relocate the receiving antenna.
- Increase the separation between the equipment and receiver.
- Connect the equipment into an outlet on a circuit different from that to which the receiver is connected.
- Consult the dealer or an experienced radio/TV technician for help.

This device complies with Part 15 of the FCC Rules. Operation is subject to the following two conditions:

- (1) this device may not cause harmful interference, and
- (2) this device must accept any interference received, including interference that may cause undesired operation.

Unauthorized changes or modification to this system can void the users authority to operate this equipment.
This equipment requires shielded interface cables in order to meet FCC class B Limit.

For Canada

NOTICE

This Class B digital apparatus meets all requirements of the Canadian Interference-Causing Equipment Regulations.

AVIS

Cet appareil numérique de la classe B respecte toutes les exigences du Règlement sur le matériel brouilleur du Canada.

For the USA

DECLARATION OF CONFORMITY Compliance Information Statement

Model Name : VG-99
Type of Equipment : Guitar Effector
Responsible Party : Roland Corporation U.S.
Address : 5100 S.Eastern Avenue, Los Angeles, CA 90040-2938
Telephone : (323) 890-3700

Information

When you need repair service, call your nearest Roland Service Center or authorized Roland distributor in your country as shown below.

AFRICA

EGYPT

Al Fanny Trading Office
9, EBN Hagar Al Askalany
Street,
ARD El Golf, Heliopolis,
Cairo 11341, EGYPT
TEL: 20-2-417-1828

REUNION

Maison FO - YAM Marcel
25 Rue Jules Hermann,
Chaudron - BP79 97 491
Ste Clotilde Cedex,
REUNION ISLAND
TEL: (0262) 218-429

SOUTH AFRICA

T.O.M.S. Sound & Music
(Pty)Ltd.
2 ASTRON ROAD DENVER
JOHANNESBURG ZA 2195,
SOUTH AFRICA
TEL: (011)417 3400

Paul Bothner(Pty)Ltd.
Royal Cape Park, Unit 24
Londonderry Road, Ottery 7800
Cape Town, SOUTH AFRICA
TEL: (021) 799 4900

ASIA

CHINA

Roland Shanghai Electronics
Co.,Ltd.
5F, No.1500 Pingliang Road
Shanghai 200090, CHINA
TEL: (021) 5580-0800

Roland Shanghai Electronics
Co.,Ltd.
(BEIJING OFFICE)
10F, No.18 3 Section Anhuaxili
Chaoyang District Beijing
100011 CHINA
TEL: (010) 6426-5050

HONG KONG

Tom Lee Music Co., Ltd.
Service Division
22-32 Pun Shan Street, Tsuen
Wan, New Territories,
HONG KONG
TEL: 2415 0911

Parsons Music Ltd.
8th Floor, Railway Plaza, 39
Chatham Road South, T.S.T,
Kowloon, HONG KONG
TEL: 2333 1863

INDIA

Rivera Digitec (India) Pvt. Ltd.
411, Nirman Kendra
Mahalaxmi Flats Compound
Off. Dr. Edwin Moses Road,
Mumbai-400011, INDIA
TEL: (022) 2493 9051

INDONESIA

PT Citra IntiRama
Jl. Cideng Timur No. 15J-15O
Jakarta Pusat
INDONESIA
TEL: (021) 6324170

KOREA

Cosmos Corporation
1461-9, Seocho-Dong,
Seocho Ku, Seoul, KOREA
TEL: (02) 3486-8855

MALAYSIA

Roland Asia Pacific Sdn. Bhd.
45-1, Block C2, Jalan PJU 1/39,
Dataran Prima, 47301 Petaling
Jaya, Selangor, MALAYSIA
TEL: (03) 7805-3263

VIET NAM

Suoi Nhap Company, Ltd
370 Cach Mang Thang Tam St.
Dist.3, Ho Chi Minh City,
VIET NAM
TEL: 9316540

PHILIPPINES

G.A. Yupangco & Co. Inc.
339 Gil J. Puyat Avenue
Makati, Metro Manila 1200,
PHILIPPINES
TEL: (02) 899 9801

SINGAPORE

SWEET LEE MUSIC
COMPANY PTE. LTD.
150 Sims Drive,
SINGAPORE 387381
TEL: 6846-3676

TAIWAN

ROLAND TAIWAN
ENTERPRISE CO., LTD.
Room 5, 9fl. No. 112 Chung
Shan N.Road Sec.2, Taipei,
TAIWAN, R.O.C.
TEL: (02) 2561 3339

THAILAND

Theera Music Co., Ltd.
330 Soi Vergn NakornKasem,
New Road, Sumpantawongse,
Bangkok 10100, THAILAND
TEL: (02) 224-8821

AUSTRALIA/ NEW ZEALAND

AUSTRALIA/ NEW ZEALAND

Roland Corporation
Australia Pty.,Ltd.
38 Campbell Avenue
Dee Why West. NSW 2099
AUSTRALIA

For Australia
Tel: (02) 9982 8266
For New Zealand
Tel: (09) 3098 715

CENTRAL/LATIN AMERICA

ARGENTINA

Instrumentos Musicales S.A.
Av.Santa Fe 2055
(1123) Buenos Aires
ARGENTINA
TEL: (011) 4508-2700

BARBADOS

A&B Music Supplies LTD
12 Webster Industrial Park
Wilkey, St.Michael, Barbados
TEL: (246)430-1100

BRAZIL

Roland Brasil Ltda.
Rua San Jose, 780 Sala B
Parque Industrial San Jose
Cotia - Sao Paulo - SP, BRAZIL
TEL: (011) 4615 5666

CHILE

Comercial Fancy II S.A.
Rut.: 96.919.420-1
Nataliel Cox #739, 4th Floor
Santiago - Centro, CHILE
TEL: (02) 688-9540

COLOMBIA

Centro Musical Ltda.
Cra 43 B No 25 A 41 Bododega 9
Medellin, Colombia
TEL: (574)3812529

COSTA RICA

JUAN BANSBACH Instrumentos
Musicales
Ave.1. Calle 11, Apartado
10237,
San Jose, COSTA RICA
TEL: 258-0211

CURACAO

Zeelandia Music Center Inc.
Orionweg 30
Curacao, Netherland Antilles
TEL:(305)5926866

DOMINICAN REPUBLIC

Instrumentos Fernando Giraldez
Calle Proyecto Central No.3
Ens.La Esperilla
Santo Domingo,
Dominican Republic
TEL:(809) 683 0305

ECUADOR

Mas Musica
Rumichaca 822 y Zaruma
Guayaquil - Ecuador
TEL:(593-4)2302364

EL SALVADOR

OMNI MUSIC
75 Avenida Norte y Final
Alameda Juan Pablo II,
Edificio No.4010 San Salvador,
EL SALVADOR
TEL: 262-0788

GUATEMALA

Casa Instrumental
Calzada Roosevelt 34-01,zona 11
Ciudad de Guatemala
Guatemala
TEL:(502) 599-2888

HONDURAS

Almacen Pajaro Azul S.A. de C.V.
BO.Paz Barahona
3 Ave.11 Calle S.O
San Pedro Sula, Honduras
TEL: (504) 553-2029

MARTINIQUE

Musique & Son
Z.I.Les Mangle
97232 Le Lamantin
Martinique F.W.I.
TEL: 596 596 426860

Gigamusik SARK
10 Rte De La Folie
97200 Fort De France
Martinique F.W.I.
TEL: 596 596 715222

MEXICO

Casa Veerkamp, s.a. de cv.
Av. Toluca No. 323, Col. Olivar
de los Padres 01780 Mexico
D.F. MEXICO
TEL: (55) 5668-6699

NICARAGUA

Bansbach Instrumentos
Musicales Nicaragua
Altamira D'Este Calle Principal
de la Farmacia 5ta.Avenida
1 Cuadra al Lago.#503
Managua, Nicaragua
TEL: (505)277-2557

PANAMA

SUPRO MUNDIAL, S.A.
Boulevard Andrews, Albrook,
Panama City, REP. DE
PANAMA
TEL: 315-0101

PARAGUAY

Distribuidora De
Instrumentos Musicales
J.E. Olear y ESQ. Manduvira
Asuncion PARAGUAY
TEL: (595) 21 492147

PERU

Audionet
Distribuciones Musicales SAC
Juan Fanning 530
Miraflores
Lima - Peru
TEL: (511) 4461388

TRINIDAD

AMR Ltd
Ground Floor
Maritime Plaza
Barataria Trinidad W.I.
TEL: (868) 638 6385

URUGUAY

Todo Musica S.A.
Francisco Acuna de Figueroa
1771
C.P.: 11.800
Montevideo, URUGUAY
TEL: (02) 924-2335

VENEZUELA

Instrumentos Musicales
Allegro,C.A.
Av.las industrias edf.Guitar
import
#7 zona Industrial de Turumo
Caracas, Venezuela
TEL: (212) 244-1122

EUROPE

AUSTRIA

Roland Elektronische
Musikinstrumente HmbH.
Austrian Office
Eduard-Bodem-Gasse 8,
A-6020 Innsbruck, AUSTRIA
TEL: (0512) 26 44 260

BELGIUM/FRANCE/ HOLLAND/ LUXEMBOURG

Roland Central Europe N.V.
Houtstraat 3, B-2260, Oevel
(Westerlo) BELGIUM
TEL: (014) 575811

CROATIA

ART-CENTAR
Degenova 3
HR - 10000 Zagreb
TEL: (1) 466 8493

CZECH REP.

CZECH REPUBLIC
DISTRIBUTOR s.r.o
Voctárova 247 /16
CZ - 180 00 PRAHA 8,
CZECH REP.
TEL: (2) 830 20270

DENMARK

Roland Scandinavia A/S
Nordhavnsvej 7, Postbox 880,
DK-2100 Copenhagen
DENMARK
TEL: 3916 6200

FINLAND

Roland Scandinavia As, Filial
Finland
Elannontie 5
FIN-01510 Vantaa, FINLAND
TEL: (0)9 68 24 020

GERMANY

Roland Elektronische
Musikinstrumente HmbH.
Oststrasse 96, 22844
Norderstedt, GERMANY
TEL: (040) 52 60090

GREECE/CYPRUS

STOLLAS S.A.
Music Sound Light
155, New National Road
Patras 26442, GREECE
TEL: 2610 435400

HUNGARY

Roland East Europe Ltd.
Warehouse Area 'DEPO' Pf.83
H-2046 Torokbalint,
HUNGARY
TEL: (23) 511011

IRELAND

Roland Ireland
G2 Calmount Park, Calmount
Avenue, Dublin 12
Republic of IRELAND
TEL: (01) 4294444

ITALY

Roland Italy S. p. a.
Viale delle Industrie 8,
20020 Arese, Milano, ITALY
TEL: (02) 937-78300

NORWAY

Roland Scandinavia Avd.
Kontor Norge
Lilleakerveien 2 Postboks 95
Lilleaker N-0216 Oslo
NORWAY
TEL: 2273 0074

POLAND

ROLAND POLSKA SP. Z O.O.
UL. Gibraltarska 4.
PL-03 664 Warszawa
POLAND
TEL: (022) 679 4419

PORTUGAL

Roland Iberia, S.L.
Portugal Office
Cais das Pedras, 8/9-1 Dto
4050-465, Porto, PORTUGAL
TEL: 22 608 00 60

ROMANIA

FBS LINES
Piata Libertatii 1,
535500 Gheorgheni,
ROMANIA
TEL: (266) 364 609

RUSSIA

MuTek
Dorozhnaya ul.3,korp.6
117 545 Moscow, RUSSIA
TEL: (095) 981-4967

SLOVAKIA

DAN Acoustic s.r.o.
Povazská 18.
SK - 940 01 Nové Zámky
TEL: (305) 6424 330

SPAIN

Roland Iberia, S.L.
Paseo Garcia Faria, 33-35
08005 Barcelona SPAIN
TEL: 93 493 91 00

SWEDEN

Roland Scandinavia A/S
SWEDISH SALES OFFICE
Danvik Center 28, 2 tr.
S-131 30 Nacka SWEDEN
TEL: (0)8 702 00 20

SWITZERLAND

Roland (Switzerland) AG
Landstrasse 5, Postfach,
CH-4452 Itingen,
SWITZERLAND
TEL: (061) 927-8383

UKRAINE

EURHYTHMICS Ltd.
P.O.Box: 37-a.
Nedecey Str. 30
UA - 89600 Mukachevo,
UKRAINE
TEL: (03131) 414-40

UNITED KINGDOM

Roland (U.K.) Ltd.
Atlantic Close, Swansea
Enterprise Park, SWANSEA
SA7 9FJ,
UNITED KINGDOM
TEL: (01792) 702701

MIDDLE EAST

BAHRAIN

Moon Stores
No.1231&1249 Rumaytha
Building Road 3931, Manama
339 BAHRAIN
TEL: 17 813 942

IRAN

MOCO INC.
No.41 Nike St., Dr.Shariyati Ave.,
Roberoye Cerahe Mirdamad
Teheran, IRAN
TEL: (021) 285-4169

ISRAEL

Halilit P. Greenspoon & Sons
Ltd.
8 Retzif Ha'alina Hashnia St.
Tel-Aviv-Yafo ISRAEL
TEL: (03) 6823666

JORDAN

MUSIC HOUSE CO. LTD.
FREDDY FOR MUSIC
P. O. Box 922846
Amman 11192 JORDAN
TEL: (06) 5692696

KUWAIT

EASA HUSAIN AL-YOUSIFI
& SONS CO.
Abdullah Salem Street,
Safat, KUWAIT
TEL: 243-6399

LEBANON

Chahine S.A.L.
George Zeidan St., Chahine
Bldg., Achrafieh, P.O.Box: 16-
5857
Beirut, LEBANON
TEL: (01) 20-1441

OMAN

TALENTZ CENTRE L.L.C.
Malatan House No.1
Al Noor Street, Ruwi
SULTANATE OF OMAN
TEL: 2478 3443

QATAR

Al Emadi Co. (Badie Studio &
Stores)
P.O. Box 62, Doha, QATAR
TEL: 4423-554

SAUDI ARABIA

aDawlah Universal
Electronics APL
Corniche Road, Aldossary
Bldg., 1st Floor, Alkhobar,
31952 SAUDI ARABIA

P.O.Box 2154, Alkhobar 31952
SAUDI ARABIA
TEL: (03) 898 2081

SYRIA

Technical Light & Sound
Center
Rawda, Abdul Qader Jazairi St.
Bldg. No. 21, P.O.BOX 13520,
Damascus, SYRIA
TEL: (011) 223-5384

TURKEY

ZUHAL DIS TICARET A.S.
Galip Dede Cad. No.37
Beyoglu - Istanbul / TURKEY
TEL: (0212) 249 85 10

U.A.E.

Zak Electronics & Musical
Instruments Co. L.L.C.
Zabeel Road, Al Sherooq Bldg.,
No. 14, Ground Floor, Dubai,
U.A.E.
TEL: (04) 3360715

NORTH AMERICA

CANADA

Roland Canada Ltd.
(Head Office)
5480 Parkwood Way
Richmond B. C., V6V 2M4
CANADA
TEL: (604) 270 6626

Roland Canada Ltd.

(Toronto Office)
170 Admiral Boulevard
Mississauga On L5T 2N6
CANADA
TEL: (905) 362 9707

U. S. A.

Roland Corporation U.S.
5100 S. Eastern Avenue
Los Angeles, CA 90040-2938,
U. S. A.
TEL: (323) 890 3700

As of May 1, 2007 (ROLAND)

Free Manuals Download Website

<http://myh66.com>

<http://usermanuals.us>

<http://www.somanuals.com>

<http://www.4manuals.cc>

<http://www.manual-lib.com>

<http://www.404manual.com>

<http://www.luxmanual.com>

<http://aubethermostatmanual.com>

Golf course search by state

<http://golfingnear.com>

Email search by domain

<http://emailbydomain.com>

Auto manuals search

<http://auto.somanuals.com>

TV manuals search

<http://tv.somanuals.com>