

CUBE-BOX

Owner's Manual
Bedienungsanleitung
Guide d'utilisation
Manuale dell'utente
Manual del usuario
Manual do proprietário
Gebruikershandleiding

English

Deutsch

Français

Italiano

Español



Português

Nederlands

Copyright © 2009 ROLAND CORPORATION

All rights reserved. No part of this publication may be reproduced in any form without the written permission of ROLAND CORPORATION.

WARNING: To reduce the risk of fire or electric shock, do not expose this apparatus to rain or moisture.

  
ATTENTION: RISQUE DE CHOC ELECTRIQUE NE PAS OUVRIR
CAUTION: TO REDUCE THE RISK OF ELECTRIC SHOCK, DO NOT REMOVE COVER (OR BACK). NO USER-SERVICEABLE PARTS INSIDE. REFER SERVICING TO QUALIFIED SERVICE PERSONNEL.



The lightning flash with arrowhead symbol, within an equilateral triangle, is intended to alert the user to the presence of uninsulated "dangerous voltage" within the product's enclosure that may be of sufficient magnitude to constitute a risk of electric shock to persons.



The exclamation point within an equilateral triangle is intended to alert the user to the presence of important operating and maintenance (servicing) instructions in the literature accompanying the product.

INSTRUCTIONS PERTAINING TO A RISK OF FIRE, ELECTRIC SHOCK, OR INJURY TO PERSONS.

IMPORTANT SAFETY INSTRUCTIONS SAVE THESE INSTRUCTIONS

WARNING - When using electric products, basic precautions should always be followed, including the following:

1. Read these instructions.
2. Keep these instructions.
3. Heed all warnings.
4. Follow all instructions.
5. Do not use this apparatus near water.
6. Clean only with a dry cloth.
7. Do not block any of the ventilation openings. Install in accordance with the manufacturers instructions.
8. Do not install near any heat sources such as radiators, heat registers, stoves, or other apparatus (including amplifiers) that produce heat.
9. Do not defeat the safety purpose of the polarized or grounding-type plug. A polarized plug has two blades with one wider than the other. A grounding type plug has two blades and a third grounding prong. The wide blade or the third prong are provided for your safety. If the provided plug does not fit into your outlet, consult an electrician for replacement of the obsolete outlet.
10. Protect the power cord from being walked on or pinched particularly at plugs, convenience receptacles, and the point where they exit from the apparatus.
11. Only use attachments/accessories specified by the manufacturer.
12. Unplug this apparatus during lightning storms or when unused for long periods of time.
13. Refer all servicing to qualified service personnel. Servicing is required when the apparatus has been damaged in any way, such as power-supply cord or plug is damaged, liquid has been spilled or objects have fallen into the apparatus, the apparatus has been exposed to rain or moisture, does not operate normally, or has been dropped.

For the U.K.

WARNING: THIS APPARATUS MUST BE EARTHED

IMPORTANT: THE WIRES IN THIS MAINS LEAD ARE COLOURED IN ACCORDANCE WITH THE FOLLOWING CODE.
GREEN-AND-YELLOW: EARTH, BLUE: NEUTRAL, BROWN: LIVE

As the colours of the wires in the mains lead of this apparatus may not correspond with the coloured markings identifying the terminals in your plug, proceed as follows:

The wire which is coloured GREEN-AND-YELLOW must be connected to the terminal in the plug which is marked by the letter E or by the safety earth symbol  or coloured GREEN or GREEN-AND-YELLOW.

The wire which is coloured BLUE must be connected to the terminal which is marked with the letter N or coloured BLACK.

The wire which is coloured BROWN must be connected to the terminal which is marked with the letter L or coloured RED.

CUBE-80X

Owner's Manual

English

Deutsch

Français

Italiano

Español

Portugués

Nederlands

Before using this unit, carefully read the sections entitled: "IMPORTANT SAFETY INSTRUCTIONS", "USING THE UNIT SAFELY" (p. 2) and "IMPORTANT NOTES" (p. 4). These sections provide important information concerning the proper operation of the unit. Additionally, in order to feel assured that you have gained a good grasp of every feature provided by your new unit, Owner's Manual should be read in its entirety. The manual should be saved and kept on hand as a convenient reference.

Control Panel

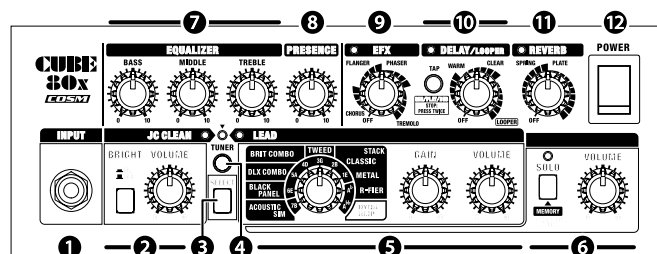

1	INPUT Jack.....	6
2	JC CLEAN Channel	6
3	SELECT Switch	6
4	TUNER Switch.....	6
5	LEAD Channel	7
6	SOLO Function.....	8
7	EQUALIZER	8
8	PRESENCE Knob	8
9	EFX (Effects) Knob.....	8
10	DELAY/LOOPER Knob	9
11	REVERB Knob	9
12	POWER Switch.....	10

Contents

Main Features.....	5
Rear Panel	11
Using the SOLO Function.....	16
Using the LOOPER	17
Using the Tuner Function	19
Sample Settings.....	20
Specifications	23
Block Diagram	23

Copyright © 2009 ROLAND CORPORATION

All rights reserved. No part of this publication may be reproduced in any form without the written permission of ROLAND CORPORATION.



USING THE UNIT SAFELY

INSTRUCTIONS FOR THE PREVENTION OF FIRE, ELECTRIC SHOCK, OR INJURY TO PERSONS

About ⚠ WARNING and ⚠ CAUTION Notices







⚠ WARNING	Used for instructions intended to alert the user to the risk of death or severe injury should the unit be used improperly.
⚠ CAUTION	Used for instructions intended to alert the user to the risk of injury or material damage should the unit be used improperly. * Material damage refers to damage or other adverse effects caused with respect to the home and all its furnishings, as well to domestic animals or pets.

About the Symbols







	The ⚠ symbol alerts the user to important instructions or warnings. The specific meaning of the symbol is determined by the design contained within the triangle. In the case of the symbol at left, it is used for general cautions, warnings, or alerts to danger.
	The ⚡ symbol alerts the user to items that must never be carried out (are forbidden). The specific thing that must not be done is indicated by the design contained within the circle. In the case of the symbol at left, it means that the unit must never be disassembled.
	The ⚡ symbol alerts the user to things that must be carried out. The specific thing that must be done is indicated by the design contained within the circle. In the case of the symbol at left, it means that the power-cord plug must be unplugged from the outlet.

ALWAYS OBSERVE THE FOLLOWING

⚠ WARNING

- Connect mains plug of this model to a mains socket outlet with a protective earthing connection. 
- Do not open or perform any internal modifications on the unit. 
- Do not attempt to repair the unit, or replace parts within it (except when this manual provides specific instructions directing you to do so). Refer all servicing to your retailer, the nearest Roland Service Center, or an authorized Roland distributor, as listed on the "Information" page. 
- Never install the unit in any of the following locations.
 - Subject to temperature extremes (e.g., direct sunlight in an enclosed vehicle, near a heating duct, on top of heat-generating equipment); or are 
 - Damp (e.g., baths, washrooms, on wet floors); or are 
 - Exposed to steam or smoke; or are
 - Subject to salt exposure; or are
 - Humid; or are
 - Exposed to rain; or are
 - Dusty or sandy; or are
 - Subject to high levels of vibration and shakiness.
- Make sure you always have the unit placed so it is level and sure to remain stable. Never place it on stands that could wobble, or on inclined surfaces. 

⚠ WARNING

- The unit should be connected to a power supply only of the type described in the operating instructions, or as marked on the rear side of unit. 
- Do not excessively twist or bend the power cord, nor place heavy objects on it. Doing so can damage the cord, producing severed elements and short circuits. Damaged cords are fire and shock hazards! 
- This unit, either alone or in combination with an amplifier and headphones or speakers, may be capable of producing sound levels that could cause permanent hearing loss. Do not operate for a long period of time at a high volume level, or at a level that is uncomfortable. If you experience any hearing loss or ringing in the ears, you should immediately stop using the unit, and consult an audiologist. 
- Do not allow any objects (e.g., flammable material, coins, pins); or liquids of any kind (water, soft drinks, etc.) to penetrate the unit. 

- In households with small children, an adult should provide supervision until the child is capable of following all the rules essential for the safe operation of the unit. 
- Protect the unit from strong impact. (Do not drop it!) 

⚠ WARNING

⚠ CAUTION

- Immediately turn the power off, remove the power cord from the outlet, and request servicing by your retailer, the nearest Roland Service Center, or an authorized Roland distributor, as listed on the "Information" page when:
 - The power-supply cord or the plug has been damaged; or
 - If smoke or unusual odor occurs
 - Objects have fallen into, or liquid has been spilled onto the unit; or
 - The unit has been exposed to rain (or otherwise has become wet); or
 - The unit does not appear to operate normally or exhibits a marked change in performance.



- The unit should be located so that its location or position does not interfere with its proper ventilation.



- A small amount of heat will radiate from the unit during normal operation. Do not use the unit in an area with less than the air space shown below.

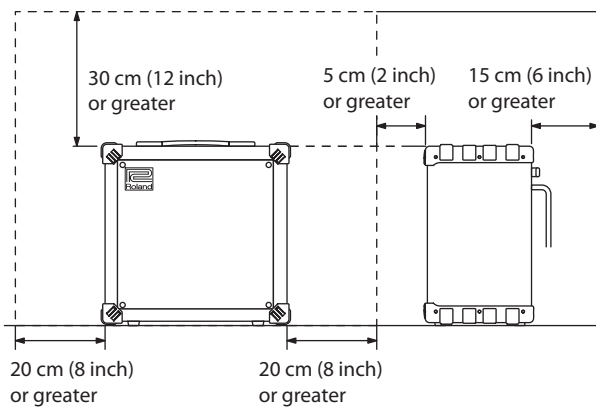

- Always grasp only the plug on the power-supply cord when plugging into, or unplugging from an outlet.



- At regular intervals, you should unplug the power plug and clean it by using a dry cloth to wipe all dust and other accumulations away from its prongs. Also, disconnect the power plug from the power outlet whenever the unit is to remain unused for an extended period of time. Any accumulation of dust between the power plug and the power outlet can result in poor insulation and lead to fire.



- Try to prevent cords and cables from becoming entangled. Also, all cords and cables should be placed so they are out of the reach of children.



- Never climb on top of, nor place heavy objects on the unit.



- Never handle the power cord or its plug with wet hands when plugging into, or unplugging from, an outlet.



- Do not force the unit's power-supply cord to share an outlet with an unreasonable number of other devices. Be especially careful when using extension cords—the total power used by all devices you have connected to the extension cord's outlet must never exceed the power rating (watts/amperes) for the extension cord. Excessive loads can cause the insulation on the cord to heat up and eventually melt through.



- Before moving the unit, disconnect the power plug from the outlet, and pull out all cords from external devices.



- Before cleaning the unit, turn off the power and unplug the power cord from the outlet.



- Before using the unit in a foreign country, consult with your retailer, the nearest Roland Service Center, or an authorized Roland distributor, as listed on the "Information" page.



- Whenever you suspect the possibility of lightning in your area, pull the plug on the power cord out of the outlet.



- Do not put anything that contains water (e.g., flower vases) on this unit. Also, avoid the use of insecticides, perfumes, alcohol, nail polish, spray cans, etc., near the unit. Swiftly wipe away any liquid that spills on the unit using a dry, soft cloth.



- Do not remove the speaker grille and speaker by any means. Speaker not user replaceable. Shock hazardous voltages and currents are present inside the enclosure.



IMPORTANT NOTES

Power Supply

- Do not connect this unit to same electrical outlet that is being used by an electrical appliance that is controlled by an inverter (such as a refrigerator, washing machine, microwave oven, or air conditioner), or that contains a motor. Depending on the way in which the electrical appliance is used, power supply noise may cause this unit to malfunction or may produce audible noise. If it is not practical to use a separate electrical outlet, connect a power supply noise filter between this unit and the electrical outlet.
- Before connecting this unit to other devices, turn off the power to all units. This will help prevent malfunctions and/or damage to speakers or other devices.
- Although the LEDs are switched off when the POWER switch is switched off, this does not mean that the unit has been completely disconnected from the source of power. If you need to turn off the power completely, first turn off the POWER switch, then unplug the power cord from the power outlet. For this reason, the outlet into which you choose to connect the power cord's plug should be one that is within easy reach and readily accessible.

Placement

- Using the unit near power amplifiers (or other equipment containing large power transformers) may induce hum. To alleviate the problem, change the orientation of this unit; or move it farther away from the source of interference.
- This device may interfere with radio and television reception. Do not use this device in the vicinity of such receivers.
- Noise may be produced if wireless communications devices, such as cell phones, are operated in the vicinity of this unit. Such noise could occur when receiving or initiating a call, or while conversing. Should you experience such problems, you should relocate such wireless devices so they are at a greater distance from this unit, or switch them off.
- Do not expose the unit to direct sunlight, place it near devices that radiate heat, leave it inside an enclosed vehicle, or otherwise subject it to temperature extremes. Also, do not allow lighting devices that normally are used while their light source is very close to the unit (such as a piano light), or powerful spotlights to shine upon the same area of the unit for extended periods of time. Excessive heat can deform or discolor the unit.
- When moved from one location to another where the temperature and/or humidity is very different, water droplets (condensation) may form inside the unit. Damage or malfunction may result if you attempt to use the unit in this condition. Therefore, before using the unit, you must allow it to stand for several hours, until the condensation has completely evaporated.
- Do not allow rubber, vinyl, or similar materials to remain on the unit for long periods of time. Such objects can discolor or otherwise harmfully affect the finish.
- Do not paste stickers, decals, or the like to this instrument. Peeling such matter off the instrument may damage the exterior finish.

- Depending on the material and temperature of the surface on which you place the unit, its rubber feet may discolor or mar the surface.
You can place a piece of felt or cloth under the rubber feet to prevent this from happening. If you do so, please make sure that the unit will not slip or move accidentally.

Maintenance

- For everyday cleaning wipe the unit with a soft, dry cloth or one that has been slightly dampened with water. To remove stubborn dirt, use a cloth impregnated with a mild, non-abrasive detergent. Afterwards, be sure to wipe the unit thoroughly with a soft, dry cloth.
- Never use benzine, thinners, alcohol or solvents of any kind, to avoid the possibility of discoloration and/or deformation.
- Please be aware that unit settings or the contents of the solo function stored in memory may be lost when the unit is sent for servicing. Important data should always be written down on paper. Roland assumes no liability with respect to recovery of any lost data.

Additional Precautions

- Please be aware that unit settings or the contents of the solo function stored in memory can be irretrievably lost as a result of a malfunction or the improper operation of the unit. To protect yourself against the risk of losing important data, we recommend that you periodically write down on paper any important data you have stored in the unit's memory.
- Roland Corporation assumes no liability with respect to recovery of any lost unit settings or contents of the solo function stored in memory.
- Use a reasonable amount of care when using the unit's buttons, sliders, or other controls; and when using its jacks and connectors. Rough handling can lead to malfunctions.
- When connecting / disconnecting all cables, grasp the connector itself—never pull on the cable. This way you will avoid causing shorts, or damage to the cable's internal elements.
- A small amount of heat will radiate from the unit during normal operation.
- To avoid disturbing your neighbors, try to keep the unit's volume at reasonable levels. You may prefer to use headphones, so you do not need to be concerned about those around you (especially when it is late at night).
- When you need to transport the unit, package it in the box (including padding) that it came in, if possible. Otherwise, you will need to use equivalent packaging materials.
- Some connection cables contain resistors. Do not use cables that incorporate resistors for connecting to this unit. The use of such cables can cause the sound level to be extremely low, or impossible to hear. For information on cable specifications, contact the manufacturer of the cable.
- Do not insert hands, fingers, etc, into the openings in the unit's rear panel. In particular, if the unit is to be used in households with small children, always provide adult supervision to ensure that children keep their hands and feet out of these openings.

Main Features

- **A high-performance guitar amp equipped with a 30-cm (12-inch) speaker and delivering 80 watts of output**

- **Switchable between two-channels: JC CLEAN and LEAD**

Switchable using a footswitch pedal (optional BOSS FS-6, FS-5U, or FS-5L).

- **Ten types of COSM amplifiers (p. 6, p. 7)**

A total of ten COSM amp types are built in, including a clean amp for the JC CLEAN channel and acoustic, crunch, high-gain, and the original Dyna Amp for the LEAD channel.

Dyna Amp lets you achieve unprecedented tonal change and new expressiveness by varying your picking dynamics.

COSM (Composite Object Sound Modeling) is proprietary Roland modeling technology, which analyzes the way in which sound is affected by elements such as electronic circuitry, structure, and materials, and combines these elements to reconstruct the desired sound.

- **SOLO function (p. 8, p. 16)**

This lets you save and call up panel settings for tones you create with the LEAD channel, including amp type, gain, equalizer, and effects. You can also manipulate these using a footswitch pedal (the optional BOSS FS-6, FS-5U, or FS-5L), letting you put them to use in live performances.

- **LOOPER function (p. 9, p. 17)**

This lets you record, play back, and overdub a phrase you play to create your own loop phrase, enabling you to enjoy playing along with the recorded loop phrase.

You can also manipulate this using a footswitch pedal (the optional BOSS FS-6, FS-5U, or FS-5L).

* *The maximum recording time is approximately 40 seconds.*

- **Tuner function (p. 6, p. 19)**

An easy-to-operate tuner is built in. This even supports flat tuning and seven-string guitars.

Chromatic tuning is possible, too.

- **Independently operable delay and reverb (p. 9)**

The unit is equipped with a DELAY knob and a REVERB knob. These let you control delay and reverb independently.

- **Delay time adjustable through TAP input**

You can also enter a short delay (30 to 90 ms) by giving the TAP switch a long press.

- **Spring reverb modeling**

Modeling technology replicates a spring reverb with realistic fidelity.

- **Four types of easy-to-operate effects (p. 8)**

Four types of effects — chorus, flanger, phaser, and tremolo — are built in, allowing easy operation with a single control.

- **RECORDING OUT jack (p. 15)**

The unit features a RECORDING OUT jack for connecting recording equipment. You can also use this as a headphone jack.

- **AUX IN jack (p. 15)**

You can use this to connect and play along with an MP3 or CD player.

Panel Descriptions

Control Panel

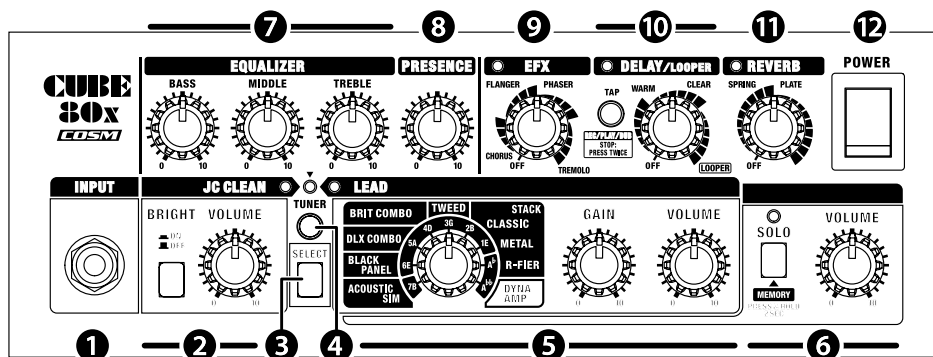

1 INPUT Jack

Connect your guitar here.

2 JC CLEAN Channel

This models the Roland JC-120.

This is a sound that readily extends up to the treble range. This amp is ideal for creating sounds in combination with a multi-effects device.

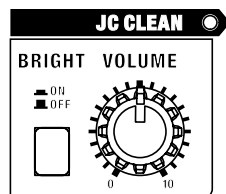

BRIGHT Switch

This makes the mid and high ranges more brilliant, for a crisper sound.

VOLUME Knob

This adjusts the volume level of the JC CLEAN channel. As an original function on this unit, this can produce a powerful crunch at volume levels near the maximum.

3 SELECT Switch

This switches between the JC CLEAN and LEAD channels. The indicator shows you which channel is selected.

You can also switch on the solo function by using this in combination with the SOLO switch. For more information, refer to "Using the SOLO Function" (p. 16).

Switching channels can also be accomplished using a footswitch pedal (optional BOSS FS-5U, FS-5L, or FS-6).

4 TUNER Switch

You use this when tuning the guitar.

Turning this on makes the switch light in red and enables tuning.

For information on how to use the tuner, refer to "Using the Tuner Function" (p. 19).

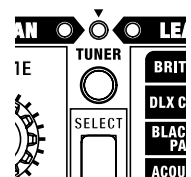

5 LEAD Channel

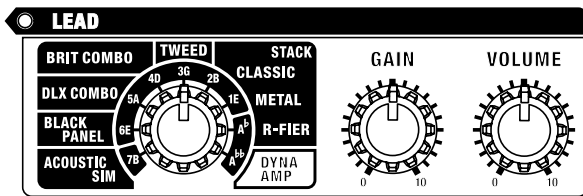

You can select from nine COSM amp types.

Type	Description
ACOUSTIC SIM	This is an original amp type that includes an acoustic simulator. It transforms the sounds from your electric guitar into a clear, refined acoustic-guitar sound. Using this type together with a single-coil pickup in the front position produces optimal sound quality. If you're using humbucker pickups, turn down the equalizer's BASS and MIDDLE controls slightly.
BLACK PANEL	This is modeled on the classic Fender Twin Reverb amplifier. It's used in a wide range of musical styles, from country to blues, jazz, and rock. It features rich lows and a bright high end.
DLX COMBO	This is modeled on the Fender Deluxe Reverb amplifier. This amp finds use in a full range of genres, including surf music, blues, country, jazz, soul, and hard rock. It features clear, clean tones and sparkling overdrive at high volumes.
BRIT COMBO	This is modeled on the Vox AC-30TB. This is the rock amplifier that created the Liverpool sound of the 1960s. It can produce a broad range of sounds, from clean to overdrive.
TWEED	This is modeled on the vintage Fender Tweed Bassman 4x10" Combo. It produces a clear mid to upper range with a fat low end, and its unique crunch tones with persistent distortion have earned it a loyal following among blues and rock guitarists.
CLASSIC STACK	This is modeled on the features of a Marshall JMP 1987. Used extensively in hard rock in the 1970s, this is truly the perfect amp for the "top rock" guitar sound.

Type	Description
METAL STACK	This is modeled on the Peavey EVH 5150. This is a high-gain amp, so you can get heavy distortion and sustain even at low volumes.
R-FIER STACK	This super high-gain amp is modeled on the Mesa/Boogie Rectifier. This is a super high-gain amp. It's capable of producing slash metal, grunge, and a wide range of other lead sounds.
DYNA AMP	This is an original amp type that lets you obtain unprecedented tonal changes according to your picking dynamics. Soft picking produces a transparent clean amp sound, whereas hard picking yields a deeply distorted high-gain amp sound. Once the sound is distorted, the tone then changes according to the force used in picking, greatly expanding your range of expression. * <i>Setting the GAIN knob at the optimal position provides maximum effectiveness. Start with the GAIN knob centered. Then adjust the GAIN knob so that soft picking yields a clean tone and hard picking produces heavy distortion.</i>

* *The product names mentioned in this document are trademarks or registered trademarks of their respective owners, and are not related to Roland Corporation. In this manual, these names are used because it is the most practical way of describing the sounds that are simulated using COSM technology.*

GAIN Knob

This adjusts the distortion level for the LEAD channel.

VOLUME Knob

This adjusts the volume level for the LEAD channel.

6 SOLO Function

This lets you save the panel settings for sounds you create with the LEAD channel (such as amp type, gain, equalizer, and various effects) and call them up later.

On this unit, this function is called "SOLO."

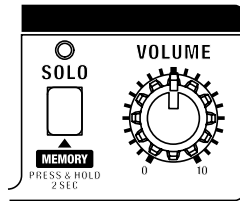

The SOLO function is handy in situations like these:

- When you're using the LEAD channel and you want to switch the amp type and effect at the same time
- When you're using the LEAD channel and you want to switch the equalizer settings and volume level at the same time
- * *Settings for the JC CLEAN channel can't be stored in memory.*

SOLO Switch

This saves panel settings and calls up it.

VOLUME (SOLO) Knob

This adjusts the volume level for the called-up settings.

- * *For information on how to use the SOLO function, refer to "Using the SOLO Function" (p. 16).*

7 EQUALIZER

Knob	Description
BASS Knob	This adjusts the sound level of the low-frequency range.
MIDDLE Knob	This adjusts the sound level of the middle-frequency range.
TREBLE Knob	This adjusts the sound level of the high-frequency range.

- * *When the LEAD channel Type switch is set to BLACK PANEL, DLX COMBO, or TWEED, setting BASS, MIDDLE and TREBLE all to 0 (zero) stops all sound.*

8 PRESENCE Knob

This gives the midrange and high end a more lustrous contour. This is effective when you want to make the sound more airy and open.

9 EFX (Effects) Knob

You can adjust the intensity of four types of effects—chorus, flanger, phaser, and tremolo—by adjusting the positioning of this knob.

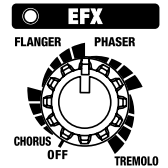

The indicator lights up when this is on, and goes out when it's off. You can also switch this on and off using an optional footswitch pedal.

- * *The scale indications for CHORUS, FLANGER, PHASER, and TREMOLO on the panel are just a general guide. Be sure to check the actual sound as you adjust the effect.*

Knob Position	Description
CHORUS	This adds a slightly detuned sound to the original sound, giving the sound greater breadth and fullness.
FLANGER	This creates a flanging effect that creates a sort of spinning sensation with the sound.
PHASER	This adds a phase-shifted signal to the original sound, giving the sound a swirling sensation.
TREMOLO	This effect produces cyclical changes in the volume level.

10 DELAY/LOOPER Knob

You can switch to either of two delay types or the LOOPER function by positioning this knob.

When the knob is at WARM or CLEAR, this functions as a delay, and you can adjust the volume level of the delay by adjusting the knob's position.

The indicator lights up when delay is on and goes out when it's off. You can also switch this on and off using an optional footswitch pedal.

When the knob is positioned at LOOPER, you can use it to adjust the volume level of playback using the LOOPER function.

This indicator lights up when the LOOPER function is on. The indicator flashes when a footswitch pedal is used to switch off (mute) LOOPER.

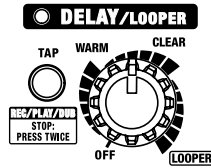

Knob Position	Function	Description
WARM	Delay	This is a feedback delay with a warm analog-delay feel. Turn the knob clockwise to increase the effect sound.
CLEAR		This is a delay with one to two repetitions. Turn the knob clockwise to increase the effect sound.
LOOPER	Looper	This enables the loop-play mode. You can vary the volume level for playback by adjusting the position of the knob. For more information, refer to "Using the LOOPER" (p. 17).

* The scale indications for WARM, CLEAR, and LOOPER are just a general guide. Be sure to check the actual sound as you adjust the effect.

* When the knob is positioned at LOOPER, no delay effect is applied. To use the LOOPER and delay simultaneously, refer to "Using the LOOPER Function and Delay at the Same Time" (p. 18).

TAP Switch

When the knob is positioned at WARM or CLEAR, you can use this to adjust the delay time.

When the knob is positioned at LOOPER, this switch controls recording, playback, and overdubbing.

Knob Position	Function	Operation
WARM, CLEAR	Adjusts the delay time	<p>Delay time of 90 ms or more Pressing the switch twice sets a delay time equal to the interval between presses. You can set a time of up to 2,000 ms when the knob is at WARM or up to 1,000 ms when the knob is at CLEAR.</p> <p>Delay time of 90 to 30 ms Holding down the TAP switch for one second or longer changes the delay time in a stepwise fashion from 30 to 90 ms, according to the number of seconds you hold the switch depressed (four stages: 30 ms, 50 ms, 70 ms, and 90 ms).</p>
LOOPER	Starts and stops Looper recording and playback	Refer to "Using the LOOPER Function and Delay at the Same Time" (p. 18).

11 REVERB Knob

You can switch between use of two types of reverb by changing the position of the knob. You can adjust the intensity of the effect by varying the knob position.

The indicator lights up when reverb is on and goes out when the effect is off. You can also switch reverb on and off using an optional footswitch pedal.

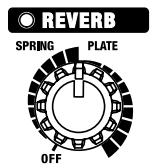

Knob Position	Description
SPRING	This is modeled on spring reverb. It produces the distinctive reverberations of a spring. Turning the knob clockwise makes the effect progressively more intense.
PLATE	This is a plate reverb. This reverb features high-end sustain. Turning the knob clockwise makes the effect progressively more intense.

12 POWER Switch

Turns the power on and off.

* *Once the connections have been completed (p. 11), turn on power to your various devices in the order specified. By turning on devices in the wrong order, you risk causing malfunction and/or damage to speakers and other devices.*

1. Make sure that all volume controls on this unit and connected devices are set to 0.

2. Turn on all the devices connected to this unit's INPUT jack and AUX IN jack.

3. Turn on this unit.

* *Always make sure to have the volume level turned down before switching on power. Even with the volume all the way down, you may still hear some sound when the power is switched on, but this is normal, and does not indicate a malfunction.*

* *This unit is equipped with a protection circuit. A brief interval (a few seconds) after power up is required before the unit will operate normally.*

4. Adjust the volume levels for the devices.

5. Before switching off the power, lower the volume on each of the devices in your system, and then turn off the devices in the reverse of the order followed when switching them on.

* *If you need to turn off the power completely, first turn off the POWER switch, then unplug the power cord from the power outlet. Refer to "Power Supply" (p. 4).*

Rear Panel

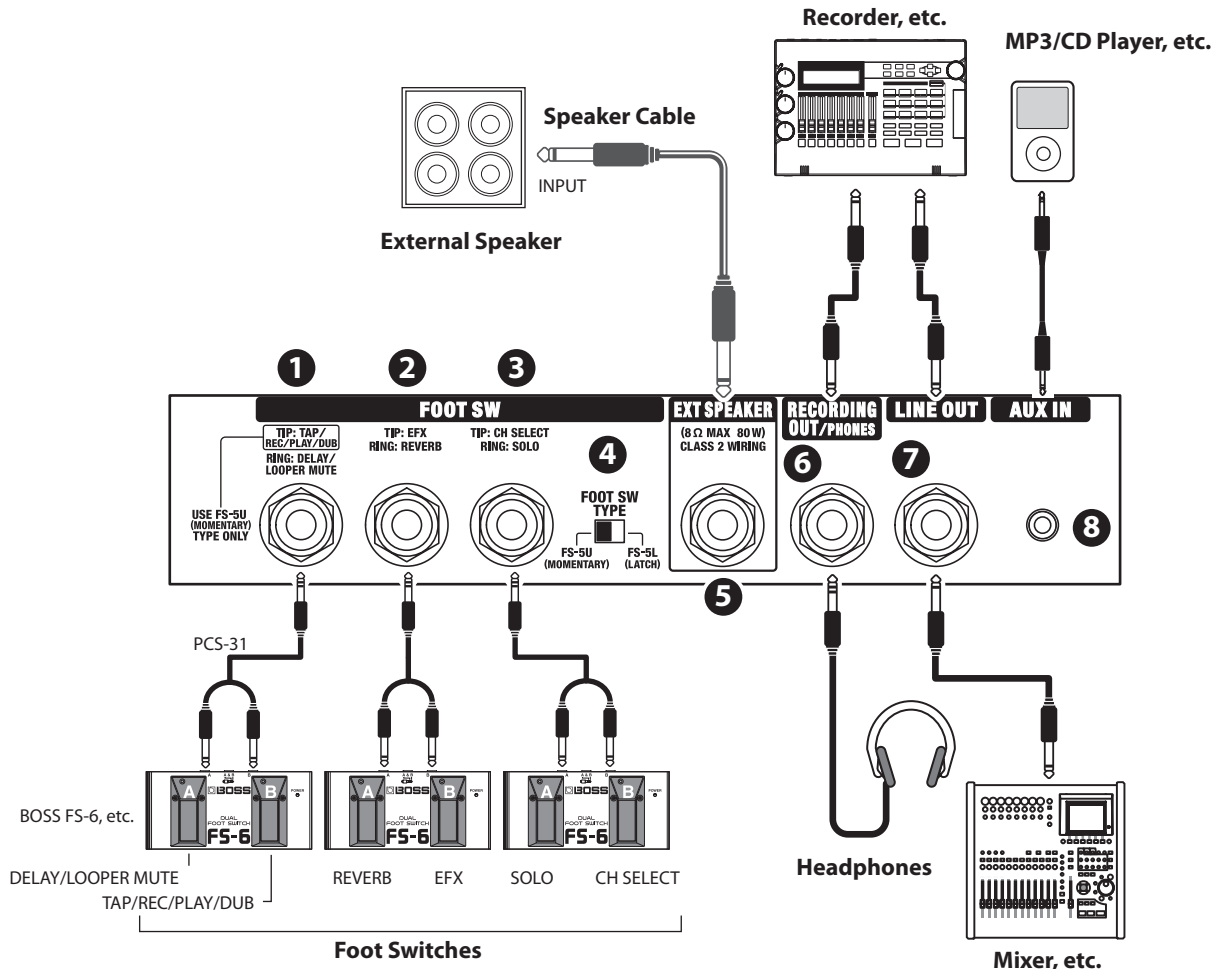

* To prevent malfunction and/or damage to speakers or other devices, always turn down the volume, and turn off the power on all devices before making any connections.

1 2 3 FOOT SW Jacks 4 FOOT SW TYPE Switch

Either momentary or latch type footswitch pedals can be used with this unit.

However, be sure to connect only a momentary-type footswitch such as the BOSS FS-5U to the TAP/REC/PLAY/DUB jack. A latch-type footswitch pedal may fail to operate correctly.

* The footswitch pedal is available separately.

* The BOSS FS-6 can operate as either a momentary or latch-type pedal switch.



Momentary type: This type remains on (or off) while depressed and switches off (or on) when released. BOSS FS-5U, etc.

Latch type: This type switches on or off each time it is depressed. BOSS FS-5L, etc.

* This unit is equipped with a TRS-type FOOT SW jack that accepts plugs of the configuration shown in the figure. To connect a footswitch pedal, use a TRS-compatible cable such as the optionally available PCS-31.



Connection and Settings When Using an FS-5L or Latch-type Footswitch Pedal

When you're using the FS-6 or FS-5L, you can determine whether the footswitch pedal is on or off by checking its indicator light.

	Jack 1	Jack 2	Jack 3
Function	<p>TIP: TAP/REC/PLAY/DUB For DELAY: Adjusts the delay time For LOOPER: LOOPER operation (p. 17)</p> <p>RING: DELAY/LOOPER MUTE For DELAY: Switches DELAY on and off For LOOPER: Mutes LOOPER</p>	<p>TIP: EFX Switches EFX on and off</p> <p>RING: REVERB Switches REVERB on and off</p>	<p>TIP: SELECT Switches between the JC CLEAN and LEAD channels</p> <p>RING: SOLO Calls up the SOLO function</p>
<p>When connecting the FS-5L</p> <div style="border: 1px solid black; padding: 5px; width: fit-content;"> <p>CUBE-80X Rear Panel</p> <p>→</p> <p>FOOT SW TYPE</p> <p>FS-5U (MOMENTARY) FS-5L (LATCH)</p> </div>	<p>Red (RING) White (TIP)</p> <p>PCS-31</p> <p>FS-5L FS-5L</p> <p>TAP/REC/PLAY/DUB</p> <p>DELAY/LOOPER MUTE</p> <p>Polarity switch</p>	<p>Red (RING) White (TIP)</p> <p>PCS-31</p> <p>FS-5L FS-5L</p> <p>REVERB SOLO</p> <p>EFX SELECT</p> <p>Polarity switch</p>	
<p>When connecting the FS-6</p> <div style="border: 1px solid black; padding: 5px; width: fit-content;"> <p>CUBE-80X Rear Panel</p> <p>→</p> <p>FOOT SW TYPE</p> <p>FS-5U (MOMENTARY) FS-5L (LATCH)</p> </div>	<p>Red (RING) White (TIP)</p> <p>PCS-31</p> <p>FS-6 FS-6</p> <p>DELAY/LOOPER MUTE TAP/REC/PLAY/DUB</p> <p>Set the switches as shown as bellow.</p> <div style="display: flex; justify-content: space-around;"> <div style="border: 1px solid black; padding: 5px;"> <p>B</p> <p>POLARITY ←</p> <p>MODE →</p> <p>FS-5U (MOMENTARY) FS-5L (LATCH)</p> </div> <div style="border: 1px solid black; padding: 5px;"> <p>A</p> <p>MODE →</p> <p>POLARITY ←</p> <p>FS-5U (MOMENTARY) FS-5L (LATCH)</p> </div> </div>	<p>Red (RING) White (TIP)</p> <p>PCS-31</p> <p>FS-6 FS-6</p> <p>REVERB SOLO</p> <p>EFX SELECT</p> <p>Set the switches as shown as bellow.</p> <div style="display: flex; justify-content: space-around;"> <div style="border: 1px solid black; padding: 5px;"> <p>B</p> <p>POLARITY ←</p> <p>MODE →</p> <p>FS-5U (MOMENTARY) FS-5L (LATCH)</p> </div> <div style="border: 1px solid black; padding: 5px;"> <p>A</p> <p>MODE →</p> <p>POLARITY ←</p> <p>FS-5U (MOMENTARY) FS-5L (LATCH)</p> </div> </div>	

Important Notes When Using a Latch-type Footswitch Pedal

Normally, the on/off state of the footswitch pedal takes precedence over the control panel for switching EFX, delay, or reverb on and off.

However, the on or off states stored in memory using the SOLO function take precedence when saved SOLO-function panel settings are called up. Such cases may result in conflicting indicator displays on the control panel and the footswitch pedal, but this is not a malfunction.

To make the indicator displays match up

Depress the footswitch pedal whose indicator display is different.

Make it match the indicator display on the control panel.

To make the on/off state of the footswitch pedal take priority at all times

On this unit, you can use either of the following settings to control operation when the panel settings for EFX, delay, and reverb are called up using the SOLO function.

- Make the on/off state of the footswitch pedal always take priority
- Make the on/off state saved using the SOLO function take priority (default)

1. How to make the on/off state of the footswitch pedal always take priority

Hold down the TAP and SELECT switches at the same time and switch on the power.

2. How to make the on/off state saved using the SOLO function take priority

Hold down the TAP and TUNER switches at the same time and switch on the power.

* The changed setting remains in memory after the power is switched off.

Connection and Settings When Using an FS-5U or Momentary-type Footswitch Pedal

	Jack 1	Jack 2	Jack 3
Function	<p>TIP: TAP/REC/PLAY/DUB For DELAY: Adjusts the delay time For LOOPER: LOOPER operation (p. 17)</p> <p>RING: DELAY/LOOPER MUTE For DELAY: Switches DELAY on and off For LOOPER: Mutes LOOPER</p>	<p>TIP: EFX Switches EFX on and off</p> <p>RING: REVERB Switches REVERB on and off</p>	<p>TIP: SELECT Switches between the JC CLEAN and LEAD channels</p> <p>RING: SOLO Calls up the SOLO function</p>
When connecting the FS-5U			
When connecting the FS-6			

5 EXT SPEAKER Jack

This is for connecting an external speaker.
When one is connected, sound is played both from the external speaker and from the unit's built-in speaker.

- * When connecting to an external speaker, make sure the speaker conforms to the following specifications.
Impedance: 8 ohms or less
Allowable power input: 80 watts or greater
- * No sound is output from this unit's speaker or any external speaker when the RECORDING OUT/PHONES jack is in use.
- * Only use speaker cable to connect the speaker. Do not use any shielded cable designed for use with guitars.

6 RECORDING OUT/PHONES Jack

This functions either as an output jack for recording or as a phones jack.

- * When a plug is connected to this jack, no sound is played from either the unit or any connected external speaker. This is handy at night or in other situations when you want to avoid high-volume sound from the speakers.

When using as an output jack for recording

Use a monaural 1/4" phone plug to connect a recorder or other recording device.
This features COSM speaker modeling, enabling production of impressive guitar sound.
Adjust the output level using the VOLUME knobs for the JC CLEAN and LEAD channels and the SOLO function.

When using as a headphones jack

Connect headphones.
This features COSM speaker modeling, enabling production of impressive guitar sound.
Adjust the headphones volume using the VOLUME knobs for the JC CLEAN and LEAD channels and the SOLO function.

7 LINE OUT Jack

This is for connecting a PA system, recorder, or other external equipment.
This features COSM speaker modeling, enabling production of impressive guitar-amp sound.

You use this when you want to use the unit in combination with an external PA system or when you want to line-record a performance while listening to the sound from the unit's built-in speaker.

Adjust the output level using the VOLUME knobs for the JC CLEAN and LEAD channels and the SOLO function.

- * The sound input to the AUX IN jack is NOT output.

8 AUX IN Jack

This lets you connect a CD player, digital audio player, electronic instrument, or other such device and play it at the same time as the guitar.

This unit is equipped with a stereo mini AUX IN jack. Use a cable (sold separately) that's appropriate for the device you're connecting.

- * When connection cables with resistors are used, the volume level of equipment connected to the AUX IN jack may be low. If this happens, use connection cables that do not contain resistors.
- * Use the connected device to adjust the volume level.
- * Output is monaural.

Power Cord

Connecting the Power Cord

1. Make sure that the POWER switch is off.

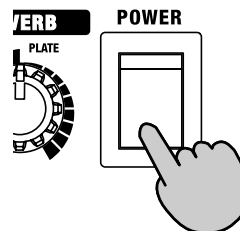

2. Connect the power cord to an AC outlet.

Using the SOLO Function

You can save and call up the panel settings (those enclosed by the line in the figure) for sounds you create with the LEAD channel. On this unit, this function is called "SOLO."

By default, "Loud Metal" (p. 20) sample settings are saved in the SOLO function.

- * The VOLUME setting for the LEAD channel is not saved.
- * The LOOPER settings and the recorded phrase are not saved.

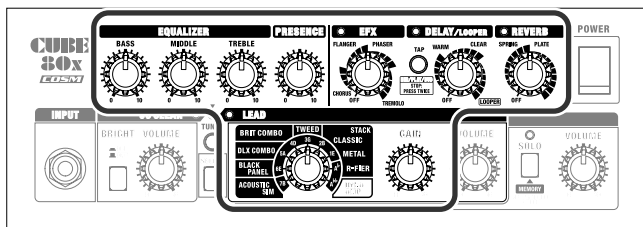

Saving the Panel Settings

1. Create a sound with the LEAD channel.

2. Set the SOLO volume at 0 (zero).

If the SOLO volume is set high, the sound may be unexpectedly loud when the panel settings are saved. Before saving, lower the volume to 0.

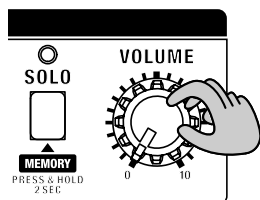

3. Press and hold the SOLO switch on the panel until the indicator starts to flash (approximately 2 seconds or longer).

When the panel settings are saved, the indicator changes to a steadily lighted state.

- * Never switch off the power while the indicator is flashing.

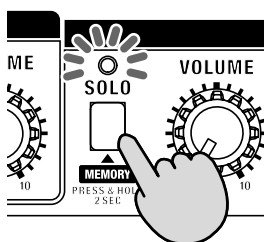

4. Adjust the volume for the SOLO function.

- * Saved panel settings remain in memory even after the power is turned off.

Calling Up Panel Settings

1. While at the JC CLEAN or LEAD channel, press the SOLO switch on the panel.

The SOLO indicator lights up and the panel settings stored in memory are called up.

- * When no panel settings have been saved, or when you're using the unit for the first time, the product's factory-default settings ("Loud Metal" (p. 20) sample settings) are called up.

Changing or Checking Saved Panel Settings

1. Press the SOLO switch on the panel to call up the saved settings.

2. Turn the panel knob for the item you want to change, and modify the setting.

- * The SOLO indicator goes out briefly when the position of the turned knob coincides with the position stored in memory.

3. Pressing the SOLO switch on the panel until the indicator starts to flash (approximately 2 seconds or longer) saves the changes to the settings.

- * Never switch off the power while the indicator is flashing.
- * Once the new settings have been saved, the previous settings in effect before the changes cannot be called up again.
- * To quit without saving the changes, press the SOLO switch or the SELECT switch.

Switching the SOLO Function and the LEAD and JC CLEAN Channels

You can switch channels using the SELECT switch and the SOLO switch.

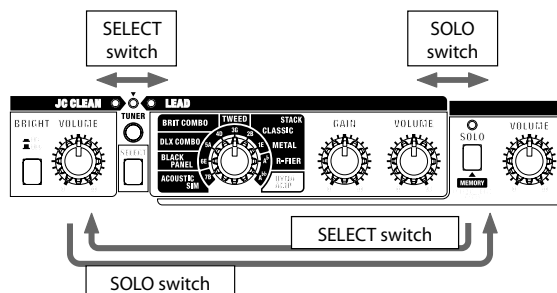

- * When a momentary-type footswitch pedal is connected, it also performs the same operation.

Returning to the Factory-default Settings

Hold down the TAP switch and the SOLO switch at the same time and switch on the power.

The SOLO indicator flashes and the settings saved with the SOLO function are returned to their factory defaults.

Using the LOOPER

This lets you record a phrase you play, and play it back any number of times. You can also use it to overdub a recorded phrase.

On this unit, this feature is called the "LOOPER."

You can also operate the LOOPER function using an optionally available footswitch pedal.

- * The recorded phrase is deleted when the unit is turned off.
- * Unauthorized recording, distribution, sale, lending, public performance, broadcasting, or the like, in whole or in part, of a work (musical composition, video, broadcast, public performance, or the like) whose copyright is held by a third party is prohibited by law.
- * Never use this unit for any purpose that may infringe on a copyright held by a third party. Roland assumes no responsibility for any infringement of third-party copyright arising through your use of this unit.

Recording a Phrase

1. Set the DELAY/LOOPER knob at LOOPER.

Set the knob at the maximum setting. With the knob at the maximum, the phrase will be played back at the same volume as when it was recorded.

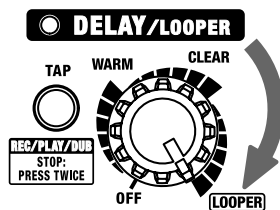

2. Press the TAP switch or depress the TAP/REC/PLAY/DUB footswitch.

When you press the TAP switch, it begins flashing in red and the unit enters recording standby.

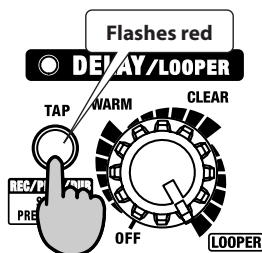

If instead you depress the TAP/REC/PLAY/DUB footswitch, the TAP switch lights in red, and recording starts immediately.

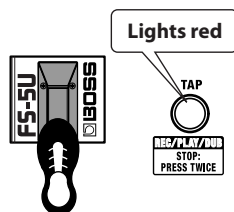

3. Start playing the guitar.

If the unit is in recording standby, the TAP switch lights up and recording starts.

4. To end recording, press the TAP switch or depress the TAP/REC/PLAY/DUB footswitch pedal.

The TAP switch lights in green and the recorded performance is played back.

5. Pressing either the TAP switch or the TAP/REC/PLAY/DUB footswitch twice in rapid succession stops playback.

The TAP switch flashes green.

- * You can also stop this by turning the DELAY/LOOPER knob to a position other than LOOPER.
- * The maximum recording time is approximately 40 seconds. When the maximum recording time is reached, recording automatically stops and playback starts.

Playing Back the Recorded Phrase

1. While the TAP switch is flashing green, press the TAP switch or depress the TAP/REC/PLAY/DUB footswitch pedal.

The TAP switch lights in green and loop playback starts from the beginning of the phrase.

2. Adjust the volume for the phrase.

You can adjust the volume level of phrase playback by adjusting the position of the DELAY/LOOPER knob.

3. Pressing the TAP switch twice in rapid succession stops playback.

The TAP switch flashes green.

Overdubbing the Phrase

- 1. Press the TAP switch or depress the TAP/REC/PLAY/DUB footswitch pedal to play back the phrase.**

The TAP switch lights in green and loop playback of the phrase starts.

- 2. Press the TAP switch or depress the TAP/REC/PLAY/DUB footswitch pedal a once time.**

The TAP switch lights in orange and overdubbing starts.

- 3. To end recording, press the TAP switch or depress the TAP/REC/PLAY/DUB footswitch pedal.**

The TAP switch lights in green and loop playback of the recorded performance starts.

- 4. Pressing the TAP switch twice in rapid succession stops playback.**

The TAP switch flashes green.

Muting the Phrase

* *Phrase muting can be carried out only when a footswitch pedal is connected. Muting cannot be accomplished via the panel.*

- 1. During phrase playback, depress the DELAY/LOOPER MUTE footswitch pedal.**

The playback sound is muted. The DELAY/LOOPER indicator flashes while muting is in effect.

- 2. To end muting, depress the DELAY/LOOPER MUTE footswitch pedal again.**

* *Recording, deleting and overdubbing can be accomplished even while muting is in effect.*

Deleting the Phrase

- 1. While phrase playback is stopped (and the TAP switch is flashing green), press and hold the TAP switch or the TAP/REC/PLAY/DUB footswitch pedal for approximately 2 seconds or longer.**

The TAP switch flashes red and the phrase is deleted.

* *Sound may be produced while the delete operation is in progress, but this doesn't indicate a malfunction. If you mute the unit before performing the deletion, the deletion can be carried out silently.*

* *The deleted phrase cannot be recovered.*

Using the LOOPER Function and Delay at the Same Time

Through use together with the SOLO function, you can also use the LOOPER function and delay at the same time.

Although delay normally cannot be used when the DELAY/LOOPER knob is set at the LOOPER position, you can use delay by using the SOLO function to save panel settings that call for delay to be applied, then activating SOLO while you're using the LOOPER function, thereby enabling the delay.

* *Switching the delay on or off or changing the delay time is not possible.*

Using the Tuner Function

This unit is equipped with a tuner function. In addition to manual tuning, you can also use it as a chromatic tuner.

* Use manual tuning when the strings are substantially out of tune (such as after changing strings).

Manual Tuning

1. Press the TUNER button.

The unit enters the Tuner mode and the TUNER switch lights up. Once in the Tuner mode, no sound is played from the speaker, the REC OUT/PHONES jack, or the LINE OUT jack.

* The sound input to the AUX IN jack is output.

2. Use the TYPE switch to select the string that you want to tune.

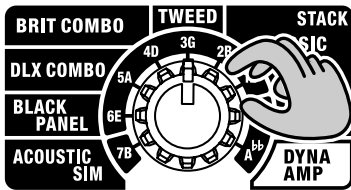

Knob Position	Description
7B	Open seventh string of a seven-string guitar with an additional low string (B)
6E	Open sixth string (E)
5A	Open fifth string (A)
4D	Open fourth string (D)
3G	Open third string (G)
2B	Open second string (B)
1E	Open first string (E)
Ab	Open fifth string (semitone down) (Ab)
A b	Open fifth string (whole tone down) (G)

* The reference pitch is A=440 Hz. This cannot be changed.

3. Play a single note on the open string that you want to tune.

Tune the string until the green indicator lights.

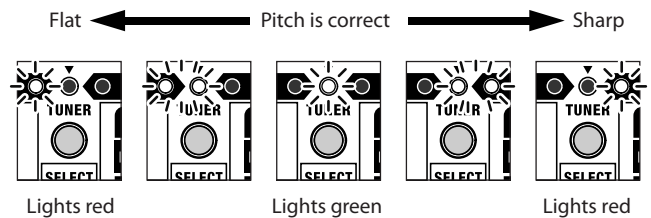

* The red indicator flashes if the pitch is substantially out of tune.

4. When you have finished tuning, press the TUNER button once again.

Chromatic Tuning

If you press the TUNER button for one full second or more, the TUNER button flashes and the unit becomes usable as a "chromatic tuner," which automatically determines the name of the note closest to the one played.

As with manual tuning, chromatic tuning allows you to play a single note on the string that you want to tune. Tune the string until the green indicator lights.

Sample Settings

* For information on how to set the delay time, refer to "DELAY/LOOPER Knob (p. 17)."

Loud Metal

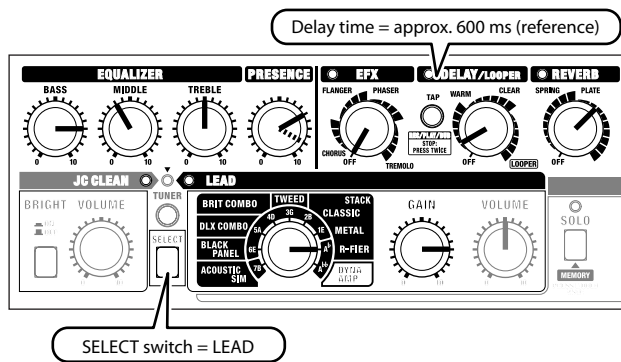

This sound produces heavy low-end reverberations when lower strings are played while muted, and airy sustain when chords are played.

Playing with a humbucking rear pickup produces even more extreme distortion. What's more, you can make the sound even heavier by using drop tuning or other such settings.

When you want to make the distortion edgier, boost the PRESENCE setting. Also, when you're using this as the lead sound, raising the midrange and applying a long delay produces a fat sound with sustain.

Space Clean

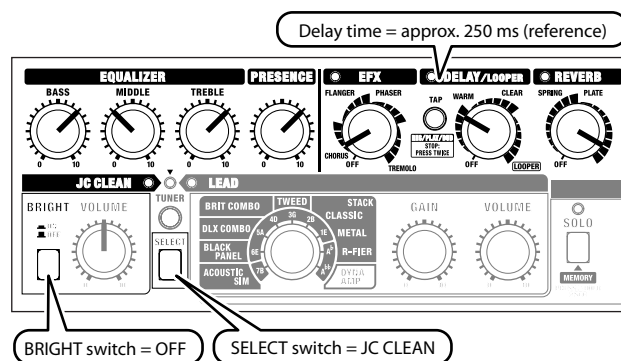

This is a transparent sound that uses spatial effects.

Use the JC CLEAN amp, which is modeled on the Roland JC-120, and add chorus, long delay, and reverb.

Using this setting with a guitar that has single-coil pickups makes for arpeggios and chord strumming with beautiful resonance. If you're using a guitar with humbucker pickups, turn the BRIGHT switch to ON to achieve a bright, open sound.

Setting the delay time to a value that makes the delay sound heard slightly ahead of the tempo of the phrase played produces a thicker sound.

Surf Line

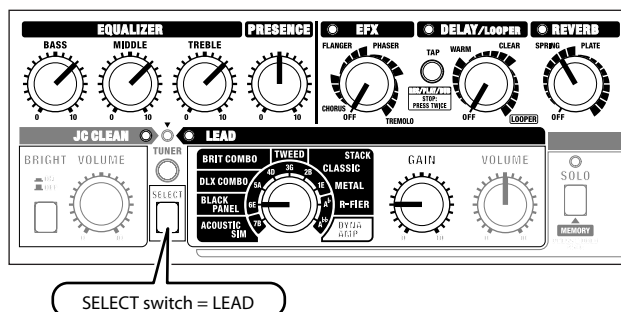

This sound is perfect for the surf music popular in the 1960s.

Using this setting with a guitar that has single-coil pickups makes for an edgy sound.

Applying deep spring reverb and using muting picking and chromatic runs (muted picking with glissandos) produces the classic surf sound.

Tube Crunch

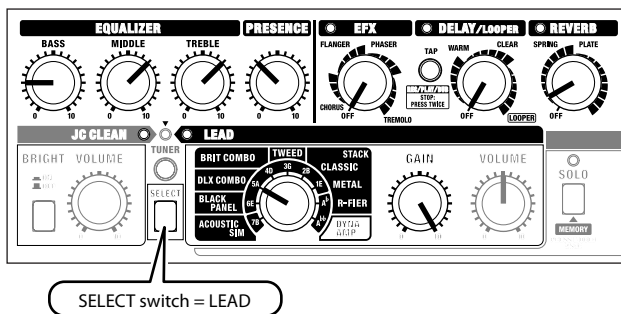

When the GAIN knob is at maximum, this produces a sound with the lustrous distortion obtained from a vacuum-tube amplifier with the volume turned all the way up. You can obtain a near-clean sound with little distortion and unchanged airy brightness simply by slightly turning down the volume on the guitar. By adjusting the volume knob on the guitar together with the GAIN knob setting, adjusting the GAIN knob so that the amount of distortion changes naturally depending on your picking dynamics with little change in volume, you can obtain sound with a broad range of expressiveness.

Swamp Crunch

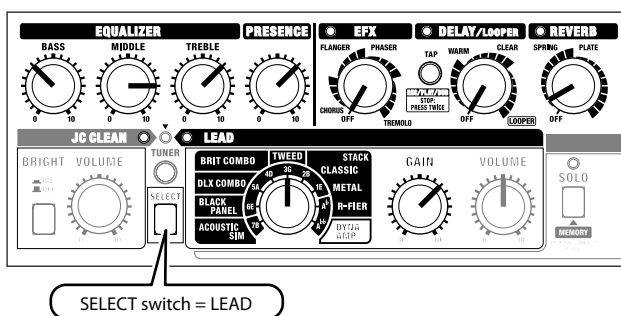

This is a blues sound found in vintage amps, with a tenacious midrange and low end and a bright, open high band. The boosted midrange and high end are distinguishing characteristics of the TWEED amp. By turning up the TREBLE knob or lowering the BASS knob slightly, you can adjust the attack sound of the picking. To create a fat, sweet sound, reducing the presence a little may be beneficial. Conversely, to produce a transparent and sharp crunch sound with little distortion, lower the midrange while boosting the presence slightly.

Hard Stack

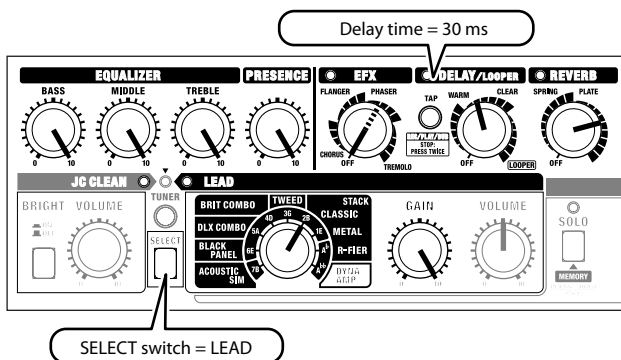

This is a 1970s-style hard-rock sound. Turning up the gain and the equalizer all the way produces a powerful rock sound in all riffs and solos. Applying a clean delay with a short delay time of 30 ms produces a fat sound characteristic of the sounds emitted by the surfaces of the cabinet. Adding just a touch of phaser can also make the sound even broader. Using effects devices like overdrive as well can produce distortion with even richer harmonics. You can also obtain a clear and airy crunch sound by turning down the GAIN and BASS knobs.

Tapping Lead

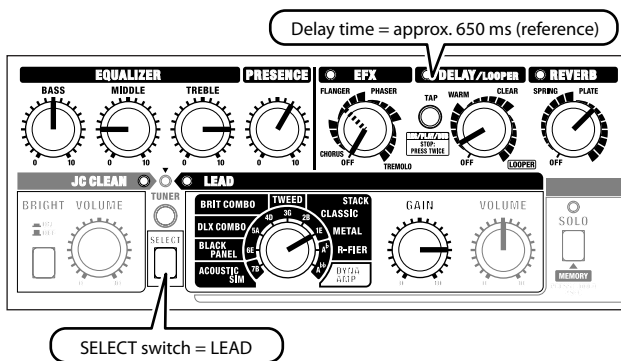

This is a high-gain lead sound with sustain. If you're using a guitar with single-coil pickups, boost the gain to produce sustain. Raise the high end and presence to produce fully developed picking harmonics. To produce smooth legato notes when using tapping, turn down the midrange. To make the sound even fuller, add just a light amount of delay and reverb. Set a long delay time to keep phrases from becoming muddy. Applying FLANGER produces a sound with smooth breadth, even when playing riffs.

English

Deutsch

Français

Italiano

Español

Portugués

Nederlands

Rockabilly Slap

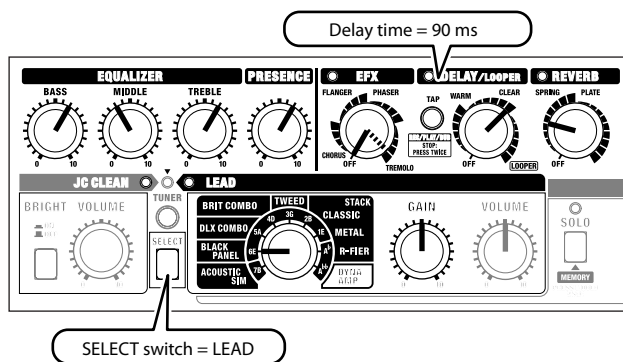

This is the slapback-echo sound used in rockabilly and country. The BLACK PANEL amp produces a clean sound that is bright and sweet, with a powerful midrange and high end supported by a thick bass.

By making the low and high ends more prominent while keeping them balanced, and also suppressing the midrange if the situation calls for it, you can bring out the dazzling resonance of the guitar even more beautifully.

The sound of a guitar that has single-coil pickups with heavy tremolo and reverb applied is also distinctive.

Mersey Beat

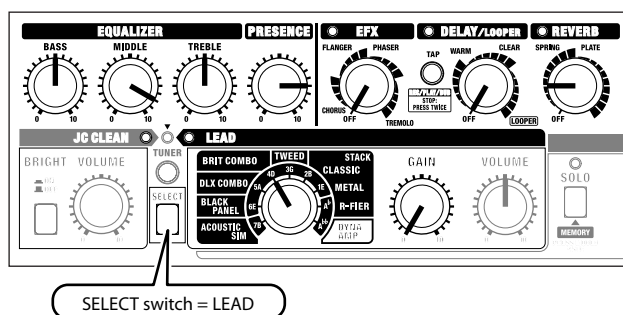

This is the famous Liverpool sound of years gone by.

This sound features a mild distortion that still lets all the notes in a chord come through clearly and distinctly.

Raise the midrange and presence on the BRIT COMBO amp to create a lively, energetic sound.

Adjust the GAIN knob so that the sound doesn't distort too much when you play chords.

Using a rear pickup provides a powerful sound with no muddiness, producing a beautiful resonance when mixing open strings with chords.

The sound may distort excessively if you're using a high-output guitar, such as one with humbucker pickups. If this happens, reduce the gain to obtain a better balance of guitar sound and distortion. In some cases you can also adjust the sound by cutting back the low end.

Dynamic Style

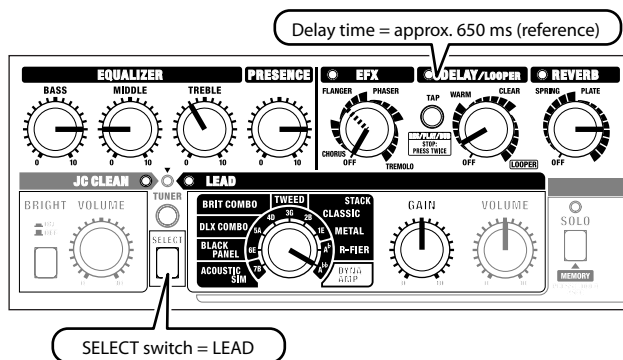

DYNA AMP is an original amp that uses relative picking intensity to create changes in distortion depth.

First, adjust the GAIN knob so that a clean tone is obtained with soft picking and heavy distortion is obtained when you pick hard.

Now mixing arpeggios played with a gentle touch along with firmly picked chords and solos results in a guitar sound with huge dynamics.

Now, to create a broader, more open sound, cut the midrange and raise the low end and presence.

Using this in combination with the EFX as well as delay and reverb creates a sound with an even greater feeling of scale.

Specifications

CUBE-80X: Guitar Amplifier

● Rated Power Output

80 W

● Nominal Input Level (@ 1 kHz)

INPUT (JC CLEAN channel): -10 dBu/1 M ohms

AUX IN: -10 dBu

● Speaker

30 cm (12 inches)

● Controls

POWER Switch, SELECT Switch, TUNER Switch

<JC CLEAN CH>

BRIGHT Switch, VOLUME Knob

<LEAD CH>

TYPE Switch (ACOUSTIC SIM, BLACK PANEL, DLX COMBO, BRIT COMBO, TWEED, CLASSIC STACK, METAL STACK, R-FIER STACK, DYNA AMP),
GAIN Knob, VOLUME Knob, SOLO Switch, VOLUME (SOLO) Knob

<EQUALIZER>

BASS Knob, MIDDLE Knob, TREBLE Knob

<PRESENCE>

PRESENCE Knob

<EFX>

EFX Knob (CHORUS, FLANGER, PHASER, TREMOLO)

<DELAY/LOOPER>

TAP/REC/PLAY/DUB Switch,
DELAY/LOOPER Knob (WARM, CLEAR, LOOPER)

<REVERB>

REVERB Knob (SPRING, PLATE)

FOOT SWITCH TYPE Switch (FS-5L, FS-5U)

● Indicators

JC CLEAN Channel, LEAD Channel, SOLO, TUNER, EFX, DELAY/LOOPER, TAP/REC/PLAY/DUB, REVERB

● Connectors

INPUT Jack (1/4" phone type),
AUX IN Jack (Stereo miniature phone type),
LINE OUT Jack (1/4" phone type),
RECORDING OUT/PHONES Jack (Stereo 1/4" phone type),
EXT SPEAKER (1/4" phone type),
FOOT SW Jack (CH SELECT, SOLO) (1/4" TRS phone type),
FOOT SW Jack (EFX, REVERB) (1/4" TRS phone type),
FOOT SW Jack (TAP/REC/PLAY/DUB, DELAY/LOOPER) (1/4" TRS phone type)

● Power Supply

AC 117 V, AC220 V, AC 230 V, AC 240 V (50/60 Hz)

● Power Consumption

75 W

● Dimensions

440 (W) X 275 (D) X 440 (H) mm
17-3/8 (W) x 10-7/8 (D) x 17-3/8 (H) inches

● Weight

16 kg / 35 lbs., 5 oz.

● Accessory

Owner's Manual

● Options

Foot Switch (BOSS FS-5L, FS-5U, FS-6)
Connection Cable (PCS-31)

* In the interest of product improvement, the specifications and/or appearance of this unit are subject to change without prior notice.

* 0 dBu = 0.775 Vrms

Block Diagram

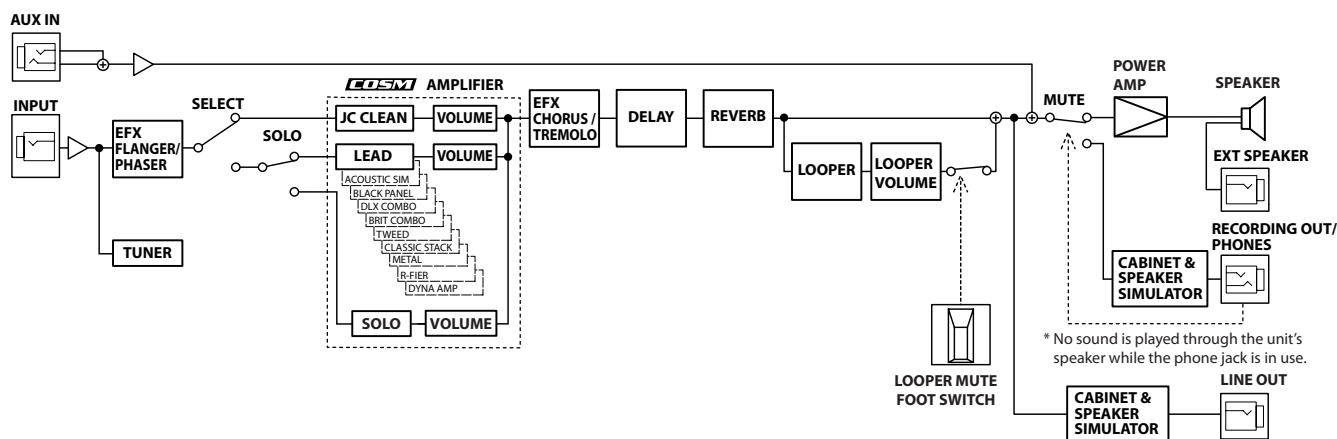

English
Deutsch
Français
Italiano
Español
Português
Nederlands



For EU Countries

This product complies with the requirements of EMCD 2004/108/EC and LVD 2006/95/EC.

For the USA

FEDERAL COMMUNICATIONS COMMISSION RADIO FREQUENCY INTERFERENCE STATEMENT

This equipment has been tested and found to comply with the limits for a Class B digital device, pursuant to Part 15 of the FCC Rules. These limits are designed to provide reasonable protection against harmful interference in a residential installation. This equipment generates, uses, and can radiate radio frequency energy and, if not installed and used in accordance with the instructions, may cause harmful interference to radio communications. However, there is no guarantee that interference will not occur in a particular installation. If this equipment does cause harmful interference to radio or television reception, which can be determined by turning the equipment off and on, the user is encouraged to try to correct the interference by one or more of the following measures:

- Reorient or relocate the receiving antenna.
- Increase the separation between the equipment and receiver.
- Connect the equipment into an outlet on a circuit different from that to which the receiver is connected.
- Consult the dealer or an experienced radio/TV technician for help.

This device complies with Part 15 of the FCC Rules. Operation is subject to the following two conditions:

- (1) this device may not cause harmful interference, and
- (2) this device must accept any interference received, including interference that may cause undesired operation.

Unauthorized changes or modification to this system can void the users authority to operate this equipment.
This equipment requires shielded interface cables in order to meet FCC class B Limit.

For Canada

NOTICE

This Class B digital apparatus meets all requirements of the Canadian Interference-Causing Equipment Regulations.

AVIS

Cet appareil numérique de la classe B respecte toutes les exigences du Règlement sur le matériel brouilleur du Canada.

For C.A. US (Proposition 65)

WARNING

This product contains chemicals known to cause cancer, birth defects and other reproductive harm, including lead.

For EU Countries



- UK** This symbol indicates that in EU countries, this product must be collected separately from household waste, as defined in each region. Products bearing this symbol must not be discarded together with household waste.
- DE** Dieses Symbol bedeutet, dass dieses Produkt in EU-Ländern getrennt vom Hausmüll gesammelt werden muss gemäß den regionalen Bestimmungen. Mit diesem Symbol gekennzeichnete Produkte dürfen nicht zusammen mit den Hausmüll entsorgt werden.
- FR** Ce symbole indique que dans les pays de l'Union européenne, ce produit doit être collecté séparément des ordures ménagères selon les directives en vigueur dans chacun de ces pays. Les produits portant ce symbole ne doivent pas être mis au rebut avec les ordures ménagères.
- IT** Questo simbolo indica che nei paesi della Comunità europea questo prodotto deve essere smaltito separatamente dai normali rifiuti domestici, secondo la legislazione in vigore in ciascun paese. I prodotti che riportano questo simbolo non devono essere smaltiti insieme ai rifiuti domestici. Ai sensi dell'art. 13 del D.Lgs. 25 luglio 2005 n. 151.
- ES** Este símbolo indica que en los países de la Unión Europea este producto debe recogerse aparte de los residuos domésticos, tal como está regulado en cada zona. Los productos con este símbolo no se deben depositar con los residuos domésticos.
- PT** Este símbolo indica que nos países da UE, a recolha deste produto deverá ser feita separadamente do lixo doméstico, de acordo com os regulamentos de cada região. Os produtos que apresentem este símbolo não deverão ser eliminados juntamente com o lixo doméstico.
- NL** Dit symbool geeft aan dat in landen van de EU dit product gescheiden van huishoudelijk afval moet worden aangeboden, zoals bepaald per gemeente of regio. Producten die van dit symbool zijn voorzien, mogen niet samen met huishoudelijk afval worden verwijderd.
- DK** Dette symbol angiver, at i EU-lande skal dette produkt opsamles adskilt fra husholdningsaffald, som defineret i hver enkelt region. Produkter med dette symbol må ikke smides ud sammen med husholdningsaffald.
- NO** Dette symbolet indikerer at produktet må behandles som spesialavfall i EU-land, iht. til retningslinjer for den enkelte regionen, og ikke kastes sammen med vanlig husholdningsavfall. Produkter som er merket med dette symbolet, må ikke kastes sammen med vanlig husholdningsavfall.

- SE** Symbolen anger att i EU-länder måste den här produkten kasseras separat från hushållsavfall, i enlighet med varje regions bestämmelser. Produkter med den här symbolen får inte kasseras tillsammans med hushållsavfall.
- FI** Tämä merkintä ilmaisee, että tuote on EU-maissa kerättävä erillään kotitalousjätteistä kunkin alueen voimassa olevien määräysten mukaisesti. Tällä merkinnällä varustettuja tuotteita ei saa hävittää kotitalousjätteiden mukana.
- HU** Ez a szimbólum azt jelenti, hogy az Európai Unióban ezt a terméket a háztartási hulladéktól elkülönítve, az adott régióban érvényes szabályozás szerint kell gyűjteni. Az ezzel a szimbólummal ellátott termékeket nem szabad a háztartási hulladék közé dobni.
- PL** Symbol oznacza, że zgodnie z regulacjami w odpowiednim regionie, w krajach UE produktu nie należy wyrzucać z odpadami domowymi. Produktów opatrzonych tym symbolem nie można utylizować razem z odpadami domowymi.
- CZ** Tento symbol udává, že v zemích EU musí být tento výrobek sbírán odděleně od domácího odpadu, jak je určeno pro každý region. Výrobky nesoucí tento symbol se nesmí vyhazovat spolu s domácím odpadem.
- SK** Tento symbol vyjadruje, že v krajinách EÚ sa musí zber tohto produktu vykonávať oddelene od domového odpadu, podľa nariadení platných v konkrétnej krajine. Produkty s týmto symbolom sa nesmú vyhazovať spolu s domovým odpadom.
- EE** See sümbol näitab, et EL-i maades tuleb see toode olemprigist eraldi koguda, nii nagu on igas piirkonnas määratletud. Selle sümboliga märgitud tooteid ei tohi ära visata koos olmeprügiga.
- LT** Šis simbolis rodo, kad ES šalyse šis produktas turi būti surenkamas atskirai nuo buitinių atliekų, kaip nustatyta kiekviename regione. Šiuo simboliu paženklinoti produktai neturi būti išmetami kartu su buitinių atliekomis.
- LV** Šis simbols norāda, ka ES valstīs šo produktu jāievāc atsevišķi no mājstaimniecības atkritumiem, kā noteikts katrā reģionā. Produktus ar šo simbolu nedrīkst izmest kopā ar mājstaimniecības atkritumiem.
- SI** Ta simbol označuje, da je treba proizvod v državah EU zbirati ločeno od gospodinjjskih odpadkov, tako kot je določeno v vsaki regiji. Proizvoda s tem znakom ni dovoljeno odlagati skupaj z gospodinjjskimi odpadki.
- GR** Το σύμβολο αυτό υποδηλώνει ότι στις χώρες της Ε.Ε. το συγκεκριμένο προϊόν πρέπει να συλλέγεται χωριστά από τα υπόλοιπα οικιακά απορρίμματα, σύμφωνα με όσα προβλέπονται σε κάθε περιοχή. Τα προϊόντα που φέρουν το συγκεκριμένο σύμβολο δεν πρέπει να απορρίπτονται μαζί με τα οικιακά απορρίμματα.

For China

有关产品中所含有害物质的说明

本资料就本公司产品中所含的特定有害物质及其安全性予以说明。
本资料适用于 2007 年 3 月 1 日以后本公司所制造的产品。

环保使用期限



此标志适用于在中国国内销售的电子信息产品，表示环保使用期限的年数。所谓环保使用期限是指在自制造日起的规定的期限内，产品中所含的有害物质不致引起环境污染，不会对人身、财产造成严重的不良影响。
环保使用期限仅在遵照产品使用说明书，正确使用产品的条件下才有效。
不当的使用，将会导致有害物质泄漏的危险。

产品中有毒有害物质或元素的名称及含量

部件名称	有毒有害物质或元素					
	铅(Pb)	汞(Hg)	镉(Cd)	六价铬(Cr(VI))	多溴联苯(PBB)	多溴二苯醚(PBDE)
外壳(壳体)	×	○	○	○	○	○
电子部件(印刷电路板等)	×	○	×	○	○	○
附件(电源线、交流适配器等)	×	○	○	○	○	○

○：表示该有毒有害物质在该部件所有均质材料中的含量均在 SJ/T11363-2006 标准规定的限量要求以下。
×：表示该有毒有害物质至少在该部件的某一均质材料中的含量超出 SJ/T11363-2006 标准规定的限量要求。
因根据现有的技术水平，还没有什么物质能够代替它。

Information

When you need repair service, call your nearest Roland Service Center or authorized Roland distributor in your country as shown below.

AFRICA

EGYPT

Al Fanny Trading Office
9, EBN Hagar Al Askalany Street,
ARD E1 Golf, Heliopolis,
Cairo 11341, EGYPT
TEL: (022)-418-5531

REUNION

Maison FO - YAM Marcel
25 Rue Jules Hermann,
Chaudron - BP79 97 491
Ste Clotilde Cedex,
REUNION ISLAND
TEL: (0262) 218-429

SOUTH AFRICA

T.O.M.S. Sound & Music (Pty)Ltd.
2 ASTRON ROAD DENVER
JOHANNESBURG ZA 2195,
SOUTH AFRICA
TEL: (011)417 3400

PAUL BOTNER(PTY)Ltd.

Royal Cape Park, Unit 24
Londonderry Road, Ottery 7800
Cape Town, SOUTH AFRICA
TEL: (021) 799 4900

ASIA

CHINA

Roland Shanghai Electronics Co.,Ltd.
5F.No.1500 Pingliang Road
Shanghai 200090, CHINA
TEL: (021) 5580-0800

Roland Shanghai Electronics Co.,Ltd.

(BEIJING OFFICE)
10F.No.18 3 Section Anhuaxili
Chaoyang District Beijing 100011
CHINA
TEL: (010) 6426-5050

HONG KONG

Tom Lee Music Co., Ltd. Service Division
22-32 Pun Shan Street, Tsuen Wan, New Territories,
HONG KONG
TEL: 2415 0911

Parsons Music Ltd.

8th Floor, Railway Plaza, 39
Chatham Road South, T.S.T,
Kowloon, HONG KONG
TEL: 2333 1863

INDIA

Rivera Digitec (India) Pvt. Ltd.
411, Nirman Kendra Mahalaxmi
Flats Compound Off. Dr. Edwin
Moses Road, Mumbai-400011,
INDIA
TEL: (022) 2493 9051

INDONESIA

PT Citra Inti Rama
Jl. Cideng Timur No. 15J-15O
Jakarta Pusat
INDONESIA
TEL: (021) 6324170

KOREA

Cosmos Corporation
1461-9, Seocho-Dong,
Seocho Ku, Seoul, KOREA
TEL: (02) 3486-8855

MALAYSIA

Roland Asia Pacific Sdn. Bhd.
45-1, Block C2, Jalan PJU 1/39,
Dataran Prima, 47301 Petaling
Jaya, Selangor, MALAYSIA
TEL: (03) 7805-3263

VIET NAM

Suoi Nhap Company, Ltd
370 Cach Mang Thang Tam St.
Dist.3, Ho Chi Minh City,
VIET NAM
TEL: 9316540

PHILIPPINES

G.A. Yupangco & Co. Inc.
339 Gil J. Puyat Avenue
Makati, Metro Manila 1200,
PHILIPPINES
TEL: (02) 899 9801

SINGAPORE

SWEET LEE MUSIC COMPANY PTE. LTD.
150 Sims Drive,
SINGAPORE 387381
TEL: 6846-3676

TAIWAN

ROLAND TAIWAN ENTERPRISE CO., LTD.
Room 5, 9fl. No. 112 Chung Shan
N.Road Sec.2, Taipei, TAIWAN,
R.O.C.
TEL: (02) 2561 3339

THAILAND

Theera Music Co., Ltd.
100-108 Soi Verng Nakornkasem,
New Road, Sumpantawongse,
Bangkok 10100 THAILAND
TEL: (02) 224-8821

AUSTRALIA/ NEW ZEALAND

**AUSTRALIA/
NEW ZEALAND
Roland Corporation
Australia Pty., Ltd.**
38 Campbell Avenue
Dee Why West. NSW 2099
AUSTRALIA

For Australia
Tel: (02) 9982 8266
For New Zealand
Tel: (09) 3098 715

CENTRAL/LATIN AMERICA

**ARGENTINA
Instrumentos Musicales S.A.**
Av.Santa Fe 2055
(1123) Buenos Aires
ARGENTINA
TEL: (011) 4508-2700

BARBADOS

A&B Music Supplies LTD
12 Webster Industrial Park
Wilkey, St.Michael, Barbados
TEL: (246)430-1100

BRAZIL

Roland Brasil Ltda.
Rua San Jose, 780 Sala B
Parque Industrial San Jose
Cotia - Sao Paulo - SP, BRAZIL
TEL: (011) 4615 5666

CHILE

Comercial Fancy II S.A.
Rut: 96.919.420-1
Nataníel Cox #739, 4th Floor
Santiago - Centro, CHILE
TEL: (02) 688-9540

COLOMBIA

Centro Musical Ltda.
Cra 43 B No 25 A 41 Bodegosa 9
Medellín, Colombia
TEL: (574)3812529

COSTA RICA

JUAN Bansbach Instrumentos Musicales
Ave.1. Calle 11, Apartado 10237,
San Jose, COSTA RICA
TEL: 258-0211

CURACAO

Zeelandia Music Center Inc.
Orionweg 30
Curacao, Netherland Antilles
TEL:(305)5926866

DOMINICAN REPUBLIC

Instrumentos Fernando Giraldez
Calle Proyecto Central No.3
Ens.La Esperilla
Santo Domingo,
Dominican Republic
TEL:(809) 683 0305

ECUADOR

Mas Musica
Rumichaca 822 y Zaruma
Guayaquil - Ecuador
TEL:(593-4)2302364

EL SALVADOR

OMNI MUSIC
75 Avenida Norte y Final
Alameda Juan Pablo II,
Edificio No.4010 San Salvador,
EL SALVADOR
TEL: 262-0788

GUATEMALA

Casa Instrumental
Calzada Roosevelt 34-01,zona 11
Ciudad de Guatemala
Guatemala
TEL:(502) 599-2888

HONDURAS

Almacen Pajaro Azul S.A. de C.V.
BO.Paz Barahona
3 Ave.11 Calle S.O
San Pedro Sula, Honduras
TEL: (504) 553-2029

MARTINIQUE

Musique & Son
Z.Les Mangle
97232 Le Lamantin
Martinique F.W.I.
TEL: 596 596 426860

Gigamusic SARL

10 Rte De La Folie
97200 Fort De France
Martinique F.W.I.
TEL: 596 596 715222

MEXICO

Casa Veerkamp, s.a. de c.v.
Av. Toluca No. 323, Col. Olivar de
los Padres 01780 Mexico D.F.
MEXICO
TEL: (55) 5668-6699

NICARAGUA

Bansbach Instrumentos Musicales Nicaragua
Altamira D'Este Calle Principal
de la Farmacia Sta.Avenida
1 Cuadra al Lago.#503
Managua, Nicaragua
TEL: (505)277-2557

PANAMA

SUPRO MUNDIAL, S.A.
Boulevard Andrews, Albrook,
Panama City, REP. DE PANAMA
TEL: 315-0101

PARAGUAY

Distribuidora De Instrumentos Musicales
J.E. Olear y ESQ. Manduvira
Asuncion PARAGUAY
TEL: (595) 21 492147

PERU

Audionet
Distribuciones Musicales SAC
Juan Fanning 530
Miraflores
Lima - Peru
TEL: (511) 4461388

TRINIDAD

AMR Ltd
Ground Floor
Maritime Plaza
Barataria Trinidad W.I.
TEL: (868) 638 6385

URUGUAY

Todo Musica S.A.
Francisco Acuna de Figueroa
1771
C.P.: 11.800
Montevideo, URUGUAY
TEL: (02) 924-2335

VENEZUELA

Instrumentos Musicales Allegro,C.A.
Av.las industrias edf.Guitar import
#7 zona Industrial de Turumo
Caracas, Venezuela
TEL: (212) 244-1122

EUROPE

AUSTRIA

Roland Elektronische Musikinstrumente HmbH.
Austrian Office
Eduard-Bodem-Gasse 8,
A-6020 Innsbruck, AUSTRIA
TEL: (0512) 26 44 260

BELGIUM/FRANCE/ HOLLAND/ LUXEMBOURG

Roland Central Europe N.V.
Houtstraat 3, B-2260, Oevel
(Westerlo) BELGIUM
TEL: (014) 575811

CROATIA

ART-CENTAR
Degenova 3.
HR - 10000 Zagreb
TEL: (1) 466 8493

CZECH REP.

CZECH REPUBLIC DISTRIBUTOR s.r.o.
Vocátárova 247/16
CZ - 180 00 PRAHA 8,
CZECH REP.
TEL: (2) 830 20270

DENMARK

Roland Scandinavia A/S
Nordhavnsvej 7, Postbox 880,
DK-2100 Copenhagen
DENMARK
TEL: 3916 6200

FINLAND

Roland Scandinavia As, Filial Finland
Elannontie 5
FIN-01510 Vantaa, FINLAND
TEL: (09) 68 24 020

GERMANY

Roland Elektronische Musikinstrumente HmbH.
Oststrasse 96, 22844 Norderstedt,
GERMANY
TEL: (040) 52 60090

GREECE/CYPRUS

STOLLAS S.A.
Music Sound Light
155, New National Road
Patras 26442, GREECE
TEL: 2610 435400

HUNGARY

Roland East Europe Ltd.
Warehouse Area "DEPO" Pf.83
H-2046 Torokbalint, HUNGARY
TEL: (23) 511011

IRELAND

Roland Ireland
G2 Calmount Park, Calmount
Avenue, Dublin 12
Republic of IRELAND
TEL: (01) 4294444

ITALY

Roland Italy S. p. a.
Viale delle Industrie 8,
20020 Arese, Milano, ITALY
TEL: (02) 937-78300

NORWAY

Roland Scandinavia Avd. Kontor Norge
Lilleakerveien 2 Postboks 95
Lilleaker N-0216 Oslo
NORWAY
TEL: 2273 0074

POLAND

ROLAND POLSKA SP. Z O.O.
UL. Gibraltarska 4.
PL-03 664 Warszawa
POLAND
TEL: (022) 679 4419

PORTUGAL

Roland Iberia, S.L.
Portugal Office
Cais das Pedras, 8/9-1 Dto
4050-465, Porto, PORTUGAL
TEL: 22 608 00 60

ROMANIA

FBS LINES
Piata Libertatii 1,
535500 Gheorgheni, ROMANIA
TEL: (266) 364 609

RUSSIA

MuTek
Dorozhnaya ul.3, korp.6
117 545 Moscow, RUSSIA
TEL: (095) 981-4967

SLOVAKIA

DAN Acoustic s.r.o.
Povazská 18.
SK - 940 01 Nové Zámky
TEL: (035) 6424 330

SPAIN

Roland Iberia, S.L.
Paseo García Faria, 33-35
08005 Barcelona SPAIN
TEL: 93 493 91 00

SWEDEN

Roland Scandinavia A/S
SWEDISH SALES OFFICE
Danvik Center 28, 2 tr.
S-131 30 Nacka SWEDEN
TEL: (08) 702 00 20

SWITZERLAND

Roland (Switzerland) AG
Landstrasse 5, Postfach,
CH-4452 Itingen, SWITZERLAND
TEL: (061) 927-8383

UKRAINE

EURHYTHMICS Ltd.
P.O.Box: 37-a.
Nedecy Str. 30
UA - 89600 Mukachevo, UKRAINE
TEL: (03131) 414-40

UNITED KINGDOM

Roland (U.K.) Ltd.
Atlantic Close, Swansea
Enterprise Park, SWANSEA
SA7 9FL,
UNITED KINGDOM
TEL: (01792) 702701

MIDDLE EAST

BAHRAIN

Moon Stores
No.1231&1249 Rumaytha
Building Road 3931, Manama 339
BAHRAIN
TEL: 17 813 942

IRAN

MOCO INC.
No.41 Nike St., Dr.Shariyati Ave.,
Roberoye Cerah Mirdamad
Tehran, IRAN
TEL: (021)-2285-4169

ISRAEL

Haliit P. Greenspoon & Sons Ltd.
8 Retzif Ha'alia Hashnia St.
Tel-Aviv-Yafo ISRAEL
TEL: (03) 6823666

JORDAN

MUSIC HOUSE CO. LTD. FREDDY FOR MUSIC
P.O. Box 922846
Amman 11192 JORDAN
TEL: (06) 5692696

KUWAIT

EASA HUSAIN AL-YOUSIFI & SONS CO.
Al-Yousifi Service Center
P.O.Box 126 (Safat) 13002 KUWAIT
TEL: 00 965 802929

LEBANON

Chahine S.A.L.
George Zeidan St., Chahine Bldg,
Achrafieh, P.O.Box: 16-5857
Beirut, LEBANON
TEL: (01) 20-1441

OMAN

TALENTZ CENTRE L.L.C.
Malatan House No.1
Al Noor Street, Ruwi
SULTANATE OF OMAN
TEL: 2478 3443

QATAR

Al Emadi Co. (Badie Studio & Stores)
P.O. Box 62, Doha, QATAR
TEL: 4423-554

SAUDI ARABIA

aDawlah Universal Electronics APL
Behind Pizza Inn
Prince Turkey Street
aDawlah Building,
PO BOX 2154,
Alkhobar 31952
SAUDI ARABIA
TEL: (03) 8643601

SYRIA

Technical Light & Sound Center
Rawda, Abdul Qader Zajairi St.
Bldg. No. 21, P.O.BOX 13520,
Damascus, SYRIA
TEL: (011) 223-5384

TURKEY

ZUHAL DIS TICARET A.S.
Galip Dede Cad. No.37
Beyoglu - Istanbul / TURKEY
TEL: (0212) 249 85 10

U.A.E.

Zak Electronics & Musical Instruments Co. L.L.C.
Zabeel Road, Al Sherook Bldg,
No. 14, Ground Floor, Dubai,
U.A.E.
TEL: (04) 3360715

NORTH AMERICA

CANADA

Roland Canada Ltd.
(Head Office)
5480 Parkwood Way Richmond B.C.
C., V6V 2M4 CANADA
TEL: (604) 270 6626

Roland Canada Ltd.

(Toronto Office)
170 Admiral Boulevard
Mississauga On L5T 2N6 CANADA
TEL: (905) 362 9707

U. S. A.

Roland Corporation U.S.
5100 S. Eastern Avenue
Los Angeles, CA 90040-2938,
U. S. A.
TEL: (323) 890 3700

MEMO

Roland Corporation



Free Manuals Download Website

<http://myh66.com>

<http://usermanuals.us>

<http://www.somanuals.com>

<http://www.4manuals.cc>

<http://www.manual-lib.com>

<http://www.404manual.com>

<http://www.luxmanual.com>

<http://aubethermostatmanual.com>

Golf course search by state

<http://golfingnear.com>

Email search by domain

<http://emailbydomain.com>

Auto manuals search

<http://auto.somanuals.com>

TV manuals search

<http://tv.somanuals.com>