

Instruction Manual

Thank you for purchasing the Roland GK-KIT-GT3, a divided pickup kit. The GK-KIT-GT3 is a specialized kit for internal installation of the guitar divided pickup.

To ensure proper installation – which is critical – and operation, please read this manual carefully.

IMPORTANT NOTES

In addition to the items listed under “USING THE UNIT SAFELY,” please read and observe the following:

- Using the unit near power amplifiers (or other equipment containing large power transformers) may induce hum.
- Noise may be produced if wireless communications devices, such as cell phones, are operated in the vicinity of this unit. Such noise could occur when receiving or initiating a call, or while conversing.
- Never use benzine, thinners, alcohol or solvents of any kind, to avoid the possibility of discoloration and/or deformation.
- When connecting / disconnecting all wirings, grasp the connector itself--never pull on the cable. This way you will avoid causing shorts, or damage to the cable's internal elements.
- To avoid the risk of damage to internal components that can be caused by static electricity, please carefully observe the following whenever you handle the board.
 - Before you touch the board, always first grasp a metal object (such as a water pipe), so you are sure that any static electricity you might have been carrying has been discharged.
 - When handling the board, grasp it only by its edges. Avoid touching any of the electronic components or connectors.
 - Before you connect any cables, make sure they do not carry a static electricity charge. Such charges can be transmitted, for example, if the other end of the cable has been in contact with a carpet (or other object) where there is a static electricity buildup.
 - Save the bag in which the board was originally shipped, and put the board back into it whenever you need to store or transport it.
- Do not touch any of the printed circuit pathways.
- Never use excessive force when installing a circuit board.
- When circuit board installation is complete, double-check your work.
- Install only the included circuit boards. Remove only the specified screws.
- In the interest of product improvement, the specifications and/or appearance of this unit are subject to change without prior notice.
- Roland assumes no liability concerning any damage to the guitar and GK-KIT-GT3 upon installing the GK-KIT-GT3. Please proceed with the installation using caution and care at your own risk.

- Be sure to use the special cable supplied by us to connect the GK-KIT-GT3 to the GK-compatible device for guitar. Use of any other cable may cause unnecessary problems.
- GK-KIT-GT3 cannot be used with guitars that have unusual or customized string setups, or guitars strung with nylon, rubber, or other non-metallic strings.

French language for Canadian Safety Standard

- Veuillez suivre attentivement les instructions suivantes quand vous manipulez la carte afin d'éviter tout risque d'endommagement des pièces internes par l'électricité statique.
 - Toujours toucher un objet métallique relié à la terre (comme un tuyau par exemple) avant de manipuler la carte pour vous décharger de l'électricité statique que vous auriez pu accumuler.
 - Lorsque vous manipulez la carte, la tenir par les côtés. Évitez de toucher aux composants ou aux connecteurs.
 - Avant de connecter tout câble, assurez-vous qu'il ne contient aucune charge d'électricité statique. De telles charges peuvent être transmises, par exemple, si l'autre extrémité du câble touche à un tapis (ou autre objet) où il y a accumulation d'électricité statique.
 - Conservez le sachet d'origine dans lequel était la carte lors de l'envoi et remettez la carte dedans si vous devez la ranger ou la transporter.
- Ne toucher aucun chemin d'accès des circuits imprimés.
- Ne jamais forcer lors de l'installation de la carte de circuits imprimés.
- Quand l'installation de la carte de circuits imprimés est terminée, revérifiez si tout est bien installé.
- Avant d'entreprendre l'installation de cette unité, retirer les piles de la guitare le cas échéant.
- Installer uniquement les carte de circuits imprimés ci-jointes. Enlevez seulement les vis indiquées.

Supplied parts contents

• Divided Pickup	1
• Preamp Board	1
• GK Connector Board.....	1
• Connector Plate	1
• Pan Head Screw (for installing the Divided Pickup) (M3x20)	2
• Spring (for installing the Divided Pickup)	2
• Pan Head Screw with Spring Washer (for installing the GK Connector) (M3x10)	2

Wirings

• For GK Connector-A (7 pins).....	1
• For GK Connector-B (8 pins).....	1

• For GK Volume (3 pins).....	1
• For Switches (8 pins).....	1
• For Guitar Signal (2 pins).....	1
• For Guitar Battery (2 pins).....	1
• GK Volume (50kΩ ±20% B Curve).....	1
• LED (with wiring).....	1
• DOWN/S1, UP/S2 Switch (Momentary, Normal Operation)	2
• GUITAR/MIX/GK Select Switch (DPDT, ON-OFF-ON)	1



Parts should be arranged separately

• Screw (for installing the Connector Plate).....	4
• Ground Wire	2 (See “Wiring Diagrams” (*1))







USING THE UNIT SAFELY

INSTRUCTIONS FOR THE PREVENTION OF FIRE, ELECTRIC SHOCK, OR INJURY TO PERSONS

About  WARNING and  CAUTION Notices

 WARNING	Used for instructions intended to alert the user to the risk of death or severe injury should the unit be used improperly.
 CAUTION	Used for instructions intended to alert the user to the risk of injury or material damage should the unit be used improperly. * Material damage refers to damage or other adverse effects caused with respect to the home and all its furnishings, as well to domestic animals or pets.

About the Symbols

	The  symbol alerts the user to important instructions or warnings. The specific meaning of the symbol is determined by the design contained within the triangle. In the case of the symbol at left, it is used for general cautions, warnings, or alerts to danger.
	The  symbol alerts the user to items that must never be carried out (are forbidden). The specific thing that must not be done is indicated by the design contained within the circle. In the case of the symbol at left, it means that the unit must never be disassembled.
	The  symbol alerts the user to things that must be done as indicated by the design contained within the circle. In the case of the symbol at left, it means that the power-cord plug must be unplugged from the outlet.

ALWAYS OBSERVE THE FOLLOWING

WARNING



• Before using this unit, make sure to read the instructions below, and the Instruction Manual. 

• Do not open or perform any internal modifications on the unit. 

• Do not attempt to repair the unit, or replace parts within it (except when this manual provides specific instructions directing you to do so). Refer all servicing to your retailer, the nearest Roland Service Center, or an authorized Roland distributor 

• Never use or store the unit in places that are:

- Subject to temperature extremes (e.g., direct sunlight in an enclosed vehicle, near a heating duct, on top of heat-generating equipment); or are
- Damp (e.g., baths, washrooms, on wet floors); or are
- Humid; or are
- Exposed to rain; or are
- Dusty; or are
- Subject to high levels of vibration.

• Do not allow any objects (e.g., flammable material, coins, pins); or liquids of any kind (water, soft drinks, etc.) to penetrate the unit. 

• Protect the unit from strong impact. (Do not drop it!) 

WARNING

• Immediately turn the power off, and request servicing by your retailer, the nearest Roland Service Center, or an authorized Roland distributor, when:

- If smoke or unusual odor occurs
- Objects have fallen into, or liquid has been spilled onto the unit; or
- The unit has been exposed to rain (or otherwise has become wet); or
- The unit does not appear to operate normally or exhibits a marked change in performance.



• In households with small children, an adult should provide supervision until the child is capable of following all the rules essential for the safe operation of the unit. 

• If the guitar includes a battery, remove the battery from the guitar before attempting installation of this unit. 

CAUTION

• Never climb on top of, nor place heavy objects on the unit. 

• Whenever you've removed any parts (screws, washers, springs, etc.) used in attaching components, be sure to keep them out of the reach of small children in order to prevent them from being swallowed accidentally. 



This product complies with the requirements of

European Directives 89/338/EEC and 89/269/EEC

For EU Countries

Copyright © 2004 ROLAND CORPORATION
All rights reserved. No part of this publication may be reproduced in any form without the written permission of ROLAND CORPORATION.

Search And Download

Attaching the Divided Pickup

Adjust R on the pickup in accordance with the guitar on which the pickup is being installed.

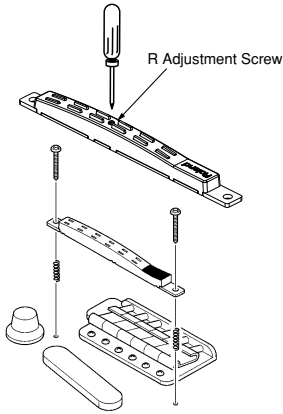

Use the included screws and springs to attach the pickup on the guitar.

1. The "Roland" logo and the cable should emerge from under sixth string.
2. Do not locate the Divided Pickup more than 20 mm from the bridge.

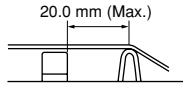

3. Position so each string passes over a pickup yoke.

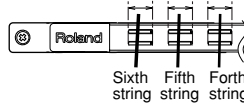

* Compatible with guitars having a string spacing of 9.6–11.8 mm.

4. Adjust the pickup height and R so that the clearance between each string and pickup yoke is 1.0 mm when the string is pressed at the highest fret.

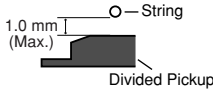

Dimensions Unit : mm

● GK Connector Board

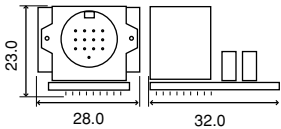

● Connector Plate

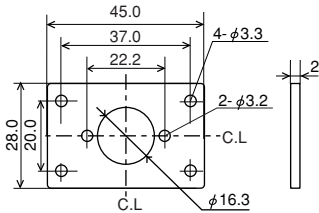

● Preamp Board

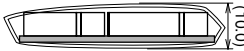
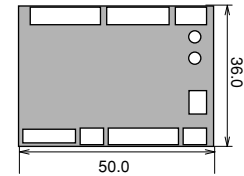

● Divided Pickup

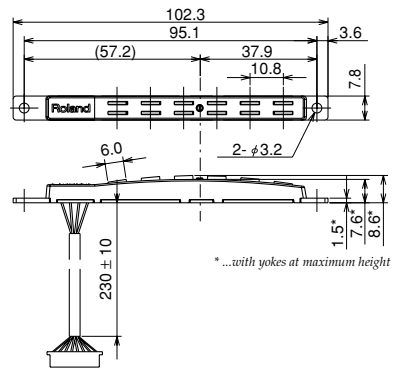

Wirings

- For Guitar Signal
- For Guitar Battery
- For GK Connector-A
- For GK Connector-B
- For GK Volume
- For Switches

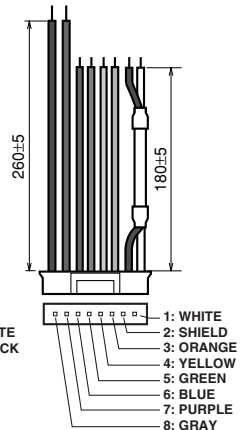
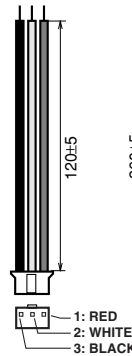
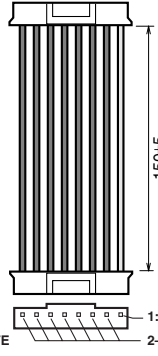
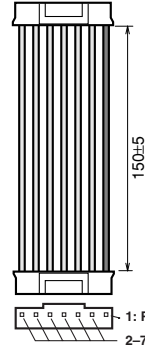
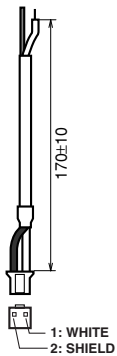

03782690 '04-10-1N

Wiring Diagram

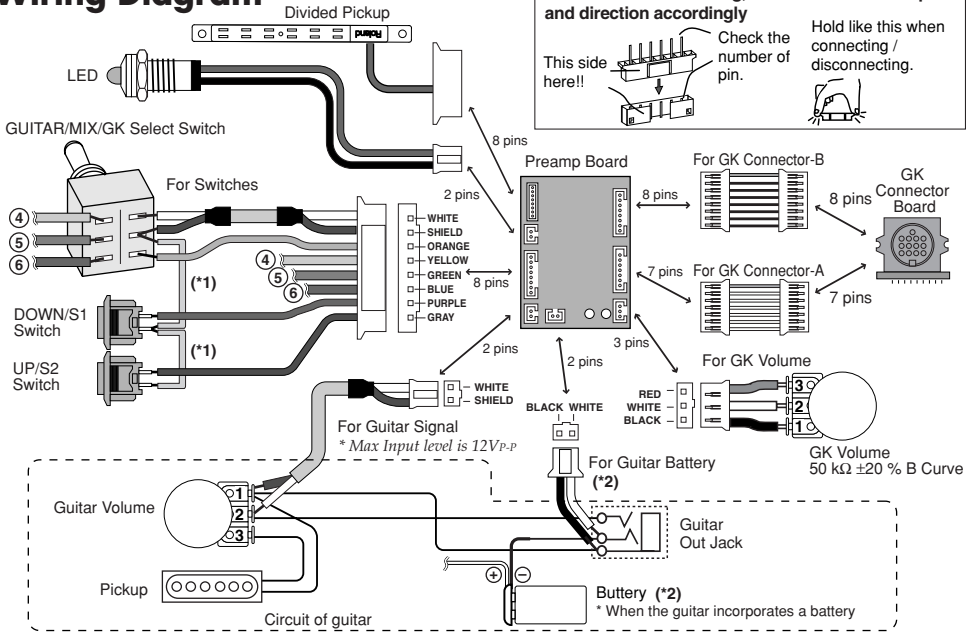

Dimensional Drawing of the Hole (If necessary, a hole for a rotation-stopper can be drilled.)

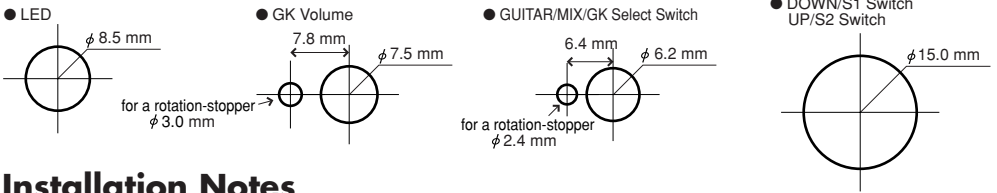

Installation Notes

GK Connector Board

1. Attach the connector to the connector plate with the supplied screws.
 2. Attach the plate to the guitar with the screws.
- * Mount GK Connector board so that small connection port should be placed top toward guitar surface.*

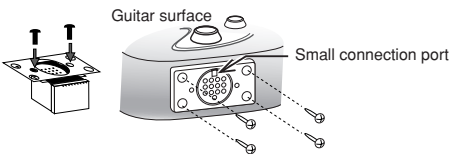

Wiring for GK Volume

1. Solder each signal wire of GK volume wiring with volume $50\text{ k}\Omega \pm 20\%$ B Curve.

Wiring for Guitar Signal

1. Solder uncovered wire (silver) to the earth (ground) of the guitar.
2. Solder the white wire to the guitar signals.

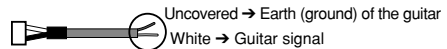

** Do not exceed 12Vp-p for input signal level.*

Wiring for Switches (Select Switch, DOWN/S1 Switch, UP/S2 Switch)

1. Ground wire for each wiring is common. Wire the ground wires as shown in "Wiring Diagram" (*1).
2. Using rebounding switch (SPDT (OFF)-ON-(OFF)) for DOWN/S1, UP/S2, mounting can be simpler.

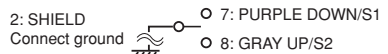

** Switch not included—must be acquired separately.*

Wiring for Guitar Battery

If the guitar has a battery for powering the pickup and preamp, install the wiring from the jack as shown in "Wiring Diagram" (*2). Even if a plug is not inserted in the jack, when power is applied to the GK connector, power from the battery is turned on.

- * This function is enabled only for the circuit being turned on/off with the battery's negative terminal.*
- * This wiring is not necessary for guitars without internal batteries.*
- * This wiring is for switching the battery on and off; it is not used for supplying power to the guitar.*
- * A current of 500 mA or less can be switched ON/OFF using this circuit. Please use due caution; if current consumption exceeds 500 mA, this circuit cannot be used.*

About Transcription for Each Controller

When you transcribe each controller into guitar itself or owner's manual, please transcribe as below:

GK Volume	...GK VOL	Select Switch	...GUITAR
DOWN/S1 Switch	...DOWN/S1		...MIX
UP/S2 Switch	...UP/S2		...GK

Free Manuals Download Website

<http://myh66.com>

<http://usermanuals.us>

<http://www.somanuals.com>

<http://www.4manuals.cc>

<http://www.manual-lib.com>

<http://www.404manual.com>

<http://www.luxmanual.com>

<http://aubethermostatmanual.com>

Golf course search by state

<http://golfingnear.com>

Email search by domain

<http://emailbydomain.com>

Auto manuals search

<http://auto.somanuals.com>

TV manuals search

<http://tv.somanuals.com>