

HP107 Roland Digital Piano

Owner's Manual

Thank you, and congratulations on your choice of the Roland Digital Piano HP107.

Main Features

Piano Sounds with Rich Resonance and Wide-ranging Expressiveness

The stereo sampling piano sound generator realistically reproduces even the sound of the hammers striking the strings, producing the tones of a high-quality concert grand piano. Maximum polyphony of 128 notes ensures that you can use the pedal freely without running out of notes.

This instrument is receptive to all the subtle nuances that a performer might use, and skillfully reproduces them—whether it be slight variations in touch or the resonance in the strings when the keys are released, or the type of resonance heard when the pedals are released (Piano Resonance). In addition, this instrument features a “Grand Sound” speaker system, and simulates the full, three-dimensional nature of a concert grand piano (Grand Space), which together help to deliver a sound with even greater clarity and power (Dynamic Emphasis).

Pursuing the Playing Feel of a Grand Piano

This instrument features a progressive hammer action keyboard, which duplicates the touch of a grand piano, with a heavier touch in the lower register, and a lighter touch in the upper register. In addition, on the HP107, even the distinctive “click” that you feel when pressing a key on a grand piano has been faithfully simulated (escapement mechanism).

The instrument features two kinds of key touch control; key response, which changes the keys' apparent weighting, and “hammer response function,” which reproduces the piano hammers' subtle movements. The pedal is designed for good-feeling response, and allows subtle performance nuances to be expressed.

Expressiveness Only a Digital Instrument Can Provide

The HP107 lets you add just the right sounds to the piano for an effect that is full and rich. You can layer different instrument sounds over the piano sound, layer sounds one octave higher, and use a pedal to control the volume.

Comfortable for Use with Headphones

Special effects applied to the sound when headphones are used make listening through headphones comfortable, not fatiguing. And in addition to an indicator on the Front panel that lights up when you connect a pair of headphones, the HP107 also provides a convenient hook where you can keep your headphones when they're not in use.

A Variety of Helpful Practice Features and Built-in Piano Songs



A metronome function and “two-track recorder,” the built-in songs for a collection of scores (60 songs included), and other features let you experience piano lessons in ways possible only with a digital piano.

Before using this unit, carefully read the sections entitled: “**USING THE UNIT SAFELY**” and “**IMPORTANT NOTES**” (p. 4; p. 6). These sections provide important information concerning the proper operation of the unit. Additionally, in order to feel assured that you have gained a good grasp of every feature provided by your new unit, Owner's manual should be read in its entirety. The manual should be saved and kept on hand as a convenient reference.

Copyright © 2004 ROLAND CORPORATION

All rights reserved. No part of this publication may be reproduced in any form without the written permission of ROLAND CORPORATION.

WARNING: To reduce the risk of fire or electric shock, do not expose this apparatus to rain or moisture.

 CAUTION RISK OF ELECTRIC SHOCK DO NOT OPEN	
ATTENTION: RISQUE DE CHOC ELECTRIQUE NE PAS OUVRIR	
CAUTION: TO REDUCE THE RISK OF ELECTRIC SHOCK, DO NOT REMOVE COVER (OR BACK). NO USER-SERVICEABLE PARTS INSIDE. REFER SERVICING TO QUALIFIED SERVICE PERSONNEL.	



The lightning flash with arrowhead symbol, within an equilateral triangle, is intended to alert the user to the presence of uninsulated "dangerous voltage" within the product's enclosure that may be of sufficient magnitude to constitute a risk of electric shock to persons.



The exclamation point within an equilateral triangle is intended to alert the user to the presence of important operating and maintenance (servicing) instructions in the literature accompanying the product.

INSTRUCTIONS PERTAINING TO A RISK OF FIRE, ELECTRIC SHOCK, OR INJURY TO PERSONS.

IMPORTANT SAFETY INSTRUCTIONS SAVE THESE INSTRUCTIONS

WARNING - When using electric products, basic precautions should always be followed, including the following:

1. Read these instructions.
2. Keep these instructions.
3. Heed all warnings.
4. Follow all instructions.
5. Do not use this apparatus near water.
6. Clean only with a dry cloth.
7. Do not block any of the ventilation openings. Install in accordance with the manufacturers instructions.
8. Do not install near any heat sources such as radiators, heat registers, stoves, or other apparatus (including amplifiers) that produce heat.
9. Do not defeat the safety purpose of the polarized or grounding-type plug. A polarized plug has two blades with one wider than the other. A grounding type plug has two blades and a third grounding prong. The wide blade or the third prong are provided for your safety. When the provided plug does not fit into your outlet, consult an electrician for replacement of the obsolete outlet.
10. Protect the power cord from being walked on or pinched particularly at plugs, convenience receptacles, and the point where they exit from the apparatus.
11. Only use attachments/accessories specified by the manufacturer.
12. Never use with a cart, stand, tripod, bracket, or table except as specified by the manufacturer, or sold with the apparatus. When a cart is used, use caution when moving the cart/apparatus combination to avoid injury from tip-over.
13. Unplug this apparatus during lightning storms or when unused for long periods of time.
14. Refer all servicing to qualified service personnel. Servicing is required when the apparatus has been damaged in any way, such as power-supply cord or plug is damaged, liquid has been spilled or objects have fallen into the apparatus, the apparatus has been exposed to rain or moisture, does not operate normally, or has been dropped.



For the U.K.

IMPORTANT: THE WIRES IN THIS MAINS LEAD ARE COLOURED IN ACCORDANCE WITH THE FOLLOWING CODE.

BLUE: NEUTRAL
BROWN: LIVE

As the colours of the wires in the mains lead of this apparatus may not correspond with the coloured markings identifying the terminals in your plug, proceed as follows:
The wire which is coloured BLUE must be connected to the terminal which is marked with the letter N or coloured BLACK.
The wire which is coloured BROWN must be connected to the terminal which is marked with the letter L or coloured RED.
Under no circumstances must either of the above wires be connected to the earth terminal of a three pin plug.

USING THE UNIT SAFELY

INSTRUCTIONS FOR THE PREVENTION OF FIRE, ELECTRIC SHOCK, OR INJURY TO PERSONS

About ⚠ WARNING and ⚠ CAUTION Notices

⚠ WARNING	Used for instructions intended to alert the user to the risk of death or severe injury should the unit be used improperly.
⚠ CAUTION	Used for instructions intended to alert the user to the risk of injury or material damage should the unit be used improperly. * Material damage refers to damage or other adverse effects caused with respect to the home and all its furnishings, as well to domestic animals or pets.

About the Symbols

	The ⚠ symbol alerts the user to important instructions or warnings. The specific meaning of the symbol is determined by the design contained within the triangle. In the case of the symbol at left, it is used for general cautions, warnings, or alerts to danger.
	The ⚡ symbol alerts the user to items that must never be carried out (are forbidden). The specific thing that must not be done is indicated by the design contained within the circle. In the case of the symbol at left, it means that the unit must never be disassembled.
	The ⏻ symbol alerts the user to things that must be carried out. The specific thing that must be done is indicated by the design contained within the circle. In the case of the symbol at left, it means that the power-cord plug must be unplugged from the outlet.

ALWAYS OBSERVE THE FOLLOWING

⚠ WARNING

- Before using this unit, make sure to read the instructions below, and the Owner's Manual.

- Do not open or perform any internal modifications on the unit.

- Do not attempt to repair the unit, or replace parts within it (except when this manual provides specific instructions directing you to do so). Refer all servicing to your retailer, the nearest Roland Service Center, or an authorized Roland distributor, as listed on the "Information" page.

- Never use or store the unit in places that are:
 - Subject to temperature extremes (e.g., direct sunlight in an enclosed vehicle, near a heating duct, on top of heat-generating equipment); or are
 - Damp (e.g., baths, washrooms, on wet floors); or are
 - Humid; or are
 - Exposed to rain; or are
 - Dusty; or are
 - Subject to high levels of vibration.

- This unit should be used only with a rack or stand that is recommended by Roland.

- Make sure you always have the unit placed so it is level and sure to remain stable. Never place it on stands that could wobble, or on inclined surfaces.

- The unit should be connected to a power supply only of the type described in the operating instructions, or as marked on the bottom of unit.

⚠ WARNING

- Use only the attached power-supply cord. Also, the supplied power cord must not be used with any other device.

- Do not excessively twist or bend the power cord, nor place heavy objects on it. Doing so can damage the cord, producing severed elements and short circuits. Damaged cords are fire and shock hazards!

- This unit, either alone or in combination with an amplifier and headphones or speakers, may be capable of producing sound levels that could cause permanent hearing loss. Do not operate for a long period of time at a high volume level, or at a level that is uncomfortable. If you experience any hearing loss or ringing in the ears, you should immediately stop using the unit, and consult an audiologist.

- Do not allow any objects (e.g., flammable material, coins, pins); or liquids of any kind (water, soft drinks, etc.) to penetrate the unit.

- Immediately turn the power off, remove the power cord from the outlet, and request servicing by your retailer, the nearest Roland Service Center, or an authorized Roland distributor, as listed on the "Information" page when:
 - The power-supply cord, or the plug has been damaged; or
 - If smoke or unusual odor occurs
 - Objects have fallen into, or liquid has been spilled onto the unit; or
 - The unit has been exposed to rain (or otherwise has become wet); or
 - The unit does not appear to operate normally or exhibits a marked change in performance.

⚠ WARNING

- In households with small children, an adult should provide supervision until the child is capable of following all the rules essential for the safe operation of the unit. 

- Protect the unit from strong impact. (Do not drop it!) 

- Do not force the unit's power-supply cord to share an outlet with an unreasonable number of other devices. Be especially careful when using extension cords—the total power used by all devices you have connected to the extension cord's outlet must never exceed the power rating (watts/amperes) for the extension cord. Excessive loads can cause the insulation on the cord to heat up and eventually melt through. 

- Before using the unit in a foreign country, consult with your retailer, the nearest Roland Service Center, or an authorized Roland distributor, as listed on the "Information" page. 

- DO NOT play a CD-ROM disc on a conventional audio CD player. The resulting sound may be of a level that could cause permanent hearing loss. Damage to speakers or other system components may result. 

- Do not put anything that contains water (e.g., flower vases) on this unit. Also, avoid the use of insecticides, perfumes, alcohol, nail polish, spray cans, etc., near the unit. Swiftly wipe away any liquid that spills on the unit using a dry, soft cloth. 

- Connect mains plug of this model to a mains socket outlet with a protective earthing connection. 

⚠ CAUTION

- The unit should be located so that its location or position does not interfere with its proper ventilation. 

- Always grasp only the plug on the power-supply cord when plugging into, or unplugging from, an outlet or this unit. 

- At regular intervals, you should unplug the power plug and clean it by using a dry cloth to wipe all dust and other accumulations away from its prongs. Also, disconnect the power plug from the power outlet whenever the unit is to remain unused for an extended period of time. Any accumulation of dust between the power plug and the power outlet can result in poor insulation and lead to fire. 

⚠ CAUTION

- Try to prevent cords and cables from becoming entangled. Also, all cords and cables should be placed so they are out of the reach of children. 

- Never climb on top of, nor place heavy objects on the unit. 

- Never handle the power cord or its plugs with wet hands when plugging into, or unplugging from, an outlet or this unit. 

- If you need to move the instrument, take note of the precautions listed below. At least two persons are required to safely lift and move the unit. It should be handled carefully, all the while keeping it level. Make sure to have a firm grip, to protect yourself from injury and the instrument from damage. 

 - Check to make sure the screws securing the unit to the stand have not become loose. Fasten them again securely whenever you notice any loosening.
 - Disconnect the power cord.
 - Disconnect all cords coming from external devices.
 - Raise the adjusters on the stand (p. 14).
 - Close the lid.
 - Fold down the music rest.

- Before cleaning the unit, turn off the power and unplug the power cord from the outlet (p. 12). 

- Whenever you suspect the possibility of lightning in your area, pull the plug on the power cord out of the outlet. 

- Be careful when opening/closing the lid so you do not get your fingers pinched (p. 13). Adult supervision is recommended whenever small children use the unit. 

- Should you remove the music rest's attachment screws, screws of stand, and wing nut, make sure to put them in a safe place out of children's reach, so there is no chance of them being swallowed accidentally. 

IMPORTANT NOTES

In addition to the items listed under “IMPORTANT SAFETY INSTRUCTIONS” and “USING THE UNIT SAFELY” on pages 3, 4 and 5, please read and observe the following:

Power Supply

- Do not connect this unit to same electrical outlet that is being used by an electrical appliance that is controlled by an inverter (such as a refrigerator, washing machine, microwave oven, or air conditioner), or that contains a motor. Depending on the way in which the electrical appliance is used, power supply noise may cause this unit to malfunction or may produce audible noise. If it is not practical to use a separate electrical outlet, connect a power supply noise filter between this unit and the electrical outlet.
- Before connecting this unit to other devices, turn off the power to all units. This will help prevent malfunctions and/or damage to speakers or other devices.
- Although the LCD and LEDs are switched off when the POWER switch is switched off, this does not mean that the unit has been completely disconnected from the source of power. If you need to turn off the power completely, first turn off the POWER switch, then unplug the power cord from the power outlet. For this reason, the outlet into which you choose to connect the power cord's plug should be one that is within easy reach and readily accessible.

Placement

- Using the unit near power amplifiers (or other equipment containing large power transformers) may induce hum. To alleviate the problem, change the orientation of this unit; or move it farther away from the source of interference.
- This device may interfere with radio and television reception. Do not use this device in the vicinity of such receivers.
- Noise may be produced if wireless communications devices, such as cell phones, are operated in the vicinity of this unit. Such noise could occur when receiving or initiating a call, or while conversing. Should you experience such problems, you should relocate such wireless devices so they are at a greater distance from this unit, or switch them off.
- Do not expose the unit to direct sunlight, place it near devices that radiate heat, leave it inside an enclosed vehicle, or otherwise subject it to temperature extremes. Also, do not allow lighting devices that normally are used while their light source is very close to the unit (such as a piano light), or powerful spotlights to shine upon the same area of the unit for extended periods of time. Excessive heat can deform or discolor the unit.
- When moved from one location to another where the temperature and/or humidity is very different, water droplets (condensation) may form inside the unit. Damage or malfunction may result if you attempt to use the unit in this condition. Therefore, before using the unit, you must allow it to stand for several hours, until the condensation has completely evaporated.

- Do not allow rubber, vinyl, or similar materials to remain on the unit for long periods of time. Such objects can discolor or otherwise harmfully affect the finish.
- Do not allow objects to remain on top of the keyboard. This can be the cause of malfunction, such as keys ceasing to produce sound.
- Do not paste stickers, decals, or the like to this instrument. Peeling such matter off the instrument may damage the exterior finish.

Maintenance

- To clean the unit, use a dry, soft cloth; or one that is slightly dampened. Try to wipe the entire surface using an equal amount of strength, moving the cloth along with the grain of the wood. Rubbing too hard in the same area can damage the finish.
- Never use benzine, thinners, alcohol or solvents of any kind, to avoid the possibility of discoloration and/or deformation.
- The pedals of this unit are made of brass. Brass eventually darkens as the result of the natural oxidization process. If the brass becomes tarnished, polish it using commercially available metal polisher.

Repairs and Data

- Please be aware that all data contained in the unit's memory may be lost when the unit is sent for repairs. Important data should always be backed up in another MIDI device (e.g., a sequencer), or written down on paper (when possible). During repairs, due care is taken to avoid the loss of data. However, in certain cases (such as when circuitry related to memory itself is out of order), we regret that it may not be possible to restore the data, and Roland assumes no liability concerning such loss of data.

Additional Precautions

- Please be aware that the contents of memory can be irretrievably lost as a result of a malfunction, or the improper operation of the unit. To protect yourself against the risk of losing important data, we recommend that you periodically save a backup copy of important data you have stored in the unit's memory in another MIDI device (e.g., a sequencer).
- Unfortunately, it may be impossible to restore the contents of data that was stored in the unit's memory and another MIDI device (e.g., a sequencer) once it has been lost. Roland Corporation assumes no liability concerning such loss of data.
- Use a reasonable amount of care when using the unit's buttons, sliders, or other controls; and when using its jacks and connectors. Rough handling can lead to malfunctions.

IMPORTANT NOTES

- When connecting / disconnecting all cables, grasp the connector itself—never pull on the cable. This way you will avoid causing shorts, or damage to the cable's internal elements.
- A small amount of heat will radiate from the unit during normal operation.
- To avoid disturbing your neighbors, try to keep the unit's volume at reasonable levels. You may prefer to use headphones, so you do not need to be concerned about those around you (especially when it is late at night).
- When you need to transport the unit, pack it in shock-absorbent material. Transporting the unit without doing so can cause it to become scratched or damaged, and could lead to malfunction.
- Do not apply undue force to the music rest while it is in use.
- Use a cable from Roland to make the connection. If using some other make of connection cable, please note the following precautions.
 - Some connection cables contain resistors. Do not use cables that incorporate resistors for connecting to this unit. The use of such cables can cause the sound level to be extremely low, or impossible to hear. For information on cable specifications, contact the manufacturer of the cable.
- Before opening or closing the keyboard lid, always make sure that no pets or other small animals are located on top of the instrument (in particular, they should be kept away from the keyboard and its lid). Otherwise, due to the structural design of this instrument, small pets or other animals could end up getting trapped inside it. If such a situation is encountered, you must immediately switch off the power and disconnect the power cord from the outlet. You should then consult with the retailer from whom the instrument was purchased, or contact the nearest Roland Service Center.

Handling CD-ROMs

- Avoid touching or scratching the shiny underside (encoded surface) of the disc. Damaged or dirty CD-ROM discs may not be read properly. Keep your discs clean using a commercially available CD cleaner.

Contents

USING THE UNIT SAFELY	3
IMPORTANT NOTES	5
Panel Descriptions	10
Front Panel	10
Rear Panel.....	11
Bottom Panel.....	11
Before You Start Playing	12
Connecting the Pedal Cord.....	12
Connecting the Speaker Cable	12
Connect the Power Cord.....	12
Setting Up the Music Rest.....	12
Folding down the music rest.....	12
Using the music holders.....	12
Removing the music rest.....	13
Opening/Closing the Lid	13
Connecting Headphones.....	13
Using the headphones hook.....	13
Turning the Power On and Off.....	14
Adjusting the Sound's Volume and Brilliance.....	14
About the Pedals	14
Chapter 1. Enjoying the Built-in Songs.....	15
Listening to Built-in Songs.....	15
Playing back all songs continuously (All Song Play)	15
Selecting a song and playing it	15
Listening to the Demo Songs.....	16
Playing Back the Tone Demo Songs.....	16
Listening to a Demo of the Functions	17
Chapter 2. Performance.....	18
Performing with a Variety of Sounds	18
Making Fine Adjustments to the Piano Sound (Piano Resonance).....	19
Playing Sounds When the Keys Are Released (Key Off)	19
Producing the Resonance of the Strings When the Keys Are Played (String Resonance).....	19
Having Resonance Played When You Press the Damper Pedal (Damper Resonance).....	20
Adjusting the Keyboard Touch (Key Touch)	21
Changing the Timing of Sounds According to the Force Used to Press the Keys (Hammer Response)	22
Adding a Sense of Depth to the Sound (Grand Space).....	23
Adding the Right Sense of Depth for Headphones (Grand Space)	24
Adding Liveliness to the Sound (Dynamic Emphasis).....	25
Applying Effects to the Sound	26
Adding reverberation to the sound (Reverb).....	26
Adding richness to the sound (Chorus).....	26
Changing the amount of effect applied	26
Transposing the Key of the Keyboard (Transpose).....	27
Layering Complementary Sounds with the Piano Tones (Acoustic Layering).....	28
Changing the Volume Balance When Performing with Acoustic Layering	28
Playing Two Sounds Together (Dual Performance)	29
Adjusting the volume balance in Dual performance (Dual Balance).....	29
Playing Different Tones with the Left and Right Hands (Split Performance)	30
Changing the keyboard's split point.....	31
Changing How the Center Pedals Work	31
Using Metronome	32
Sounding the metronome	32
Changing the metronome volume.....	33
Chapter 3. Playing Along with the Built-in Songs	34
Changing the Tempo	34
Adding a count-in to match the timing (Count-In).....	34
Playing Each Hand Separately.....	35
Chapter 4. Recording Your Performance.....	36
Notes regarding recording.....	36
Recording a New Song.....	37
Recording Along with a Song	38
Selecting and Recording the Track for Each Hand Separately..	39
Erasing Recorded Performances	40
Erasing a performance from the specified track.....	40
Erasing a song.....	40
Chapter 5. Changing Various Settings.....	41
Making Detailed Settings (Function).....	41
Tuning to other instruments' pitches (Master Tuning)	42
Changing the temperament.....	42
Setting the tuning curve (Stretch Tuning)	43
Changing the Pitch by Octaves (Octave Shift).....	43
Applying the damper pedal to the left-hand keyboard area	43
Changing How Grand Space is Applied (Grand Space Mode)	43
Disabling Everything Except Piano Play (Panel Lock)	44
Restoring the Settings to the Factory Condition (Factory Reset)	44
Remembering the Settings Even When the Power is Turned Off (Memory Backup).....	45
Saving Recorded Songs Even with the Power Turned Off (Song Backup)	45
Deleting backed up songs	45
Using the V-LINK function.....	46
Making the Settings for the USB Driver	46
Chapter 6. Connecting External Devices	47
Connecting to Audio Equipment.....	47
Connecting to the USB Connector	47
Connecting MIDI Devices.....	48

Contents

What's MIDI?	48
Making MIDI-related Settings.....	48
MIDI send channel settings	49
Switching Local Control on and off.....	49
Transmitting a performance you recorded	49
Appendices	50
Troubleshooting	50
Error Messages/Other Messages.....	51
Tone List	52
Built-in Song List.....	53
Easy Operation List.....	55
Parameters Stored in Memory Backup	56
MIDI Implementation Chart.....	57
Main Specifications	58
Index.....	59

MEMO

Panel Descriptions

Front Panel

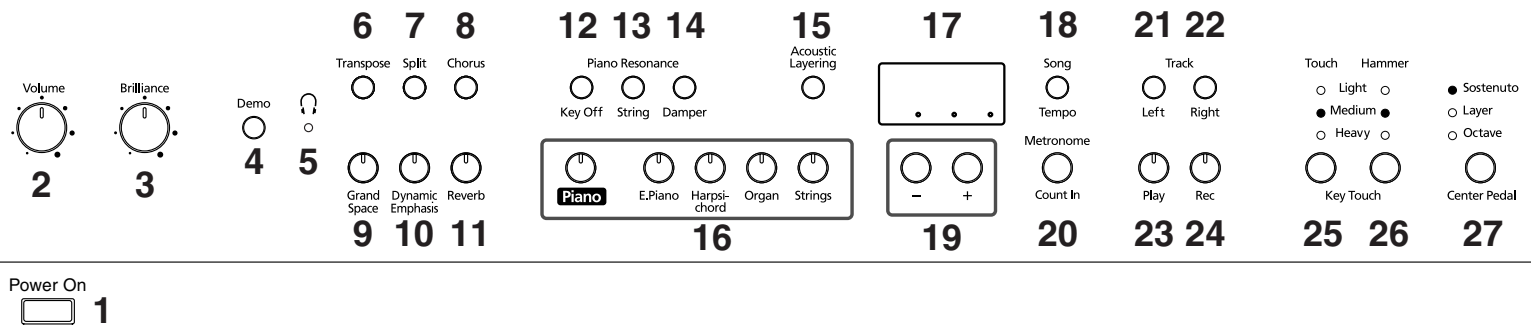

1 [Power On] switch

Turns the power on/off (p. 14).

2 [Volume] knob

Adjusts the overall volume level (p. 14).

3 [Brilliance] knob

Adjusts the tone brightness (p. 14).

4 [Demo] button

You can listen to a demo of the instrument's tones as well as a demo of the various functions (p. 16).

5 [Headphones] indicator

This indicator lights up when headphones are connected to the headphone jack (p. 13).

6 [Transpose] button

Transposes the pitch of the keyboard (p. 27).

7 [Split] button

Divides the keyboard into right-hand and left-hand areas, allowing you to play a different sound in each area (p. 30). You can also set a number of different functions when this button and the [Chorus] button are held down (p. 41–p. 46, p. 48–p. 49).

8 [Chorus] button

Adds richness to the sound (p. 26).

9 [Grand Space] button

Adds a sense of depth to the sound (p. 23, p. 24).

10 [Dynamic Emphasis] button

Creates brilliance and liveliness in the sound (p. 25).

11 [Reverb] button

Adds reverberation to the sound (p. 26).

Piano Resonance

12 [Key Off] button

Plays the sound produced when the keys are released (p. 19).

13 [String] button

Produces the resonance of the strings created when you play the keyboard (p. 19).

14 [Damper] button

Changes the resonance produced when the damper pedal is pressed (p. 20).

15 [Acoustic Layering] button

You can layer and play recommended tones that complement the piano's own sound (p. 28).

16 Tone buttons

They are used to choose the kinds of tones (tone groups) played by the keyboard (p. 18).

17 Display

The display indicates values for various settings, including the tone variation, song number, and tempo. Usually these will appear as in the figure above.

18 [Song/Tempo] Button

Used to select from the built-in songs (p. 15, p. 34).

Furthermore, you can press this button to alternately display the tempo and the currently selected song number (indicated by an "S." before it). The indicator is green when the tempo is indicated and red when the song number is displayed.

19 [-] [+] buttons

Allow you to select the value of various settings.

Pressing both the [-] and [+] buttons simultaneously returns the setting of a particular item or function to its original value.

20 [Metronome/Count In] Button

Turns the metronome on/off (p. 32). Also featured is the count-in sound, which can be played before the song starts, allowing you to begin playing with the song with perfect timing (p. 34).

Track

21 [Left] button

Plays back or records a performance separately for each hand (p. 35, p. 38–p. 40).

The left-hand performances of the built-in songs are assigned to this button. This button and the following [Right] button are collectively referred to as the "track buttons."

22 [Right] button

Plays back or records a performance separately for each hand (p. 35, p. 38–p. 40).

The right-hand performances of the built-in songs are assigned to this button.

23 [Play] button

Starts and stops playback of built-in songs and recorded performances (p. 15, p. 34).

Also starts/stops recording of a performance (p. 37–p. 39).

24 [Rec] button

Puts the HP107 in recording-standby mode (p. 36–p. 40).

Key Touch

25 [Touch] button

Modifies the playing feel of the keyboard (p. 21).

26 [Hammer] button

Adjusts how variations in your keyboard playing strength will modify the timing at which notes are sounded (p. 22).

27 [Center Pedal] button

Switches the center pedal function (p. 31).

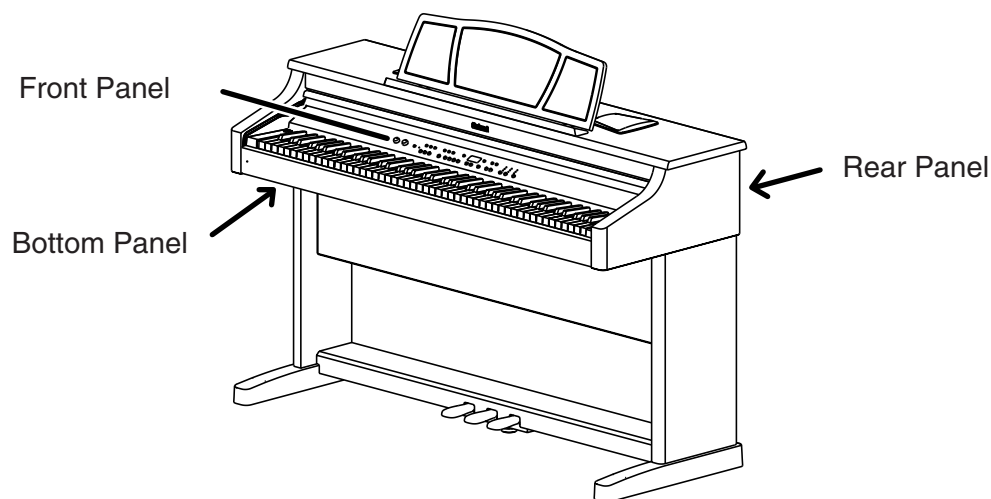

Rear Panel

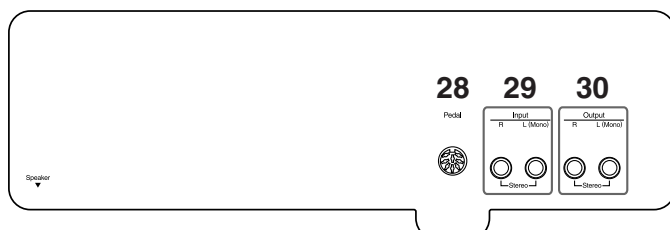

28 Pedal connector

Connect the pedal cable of the special stand to this connector (p. 12).

29 Input jacks

These jacks can be connected to another sound generating device or an audio device, so that the sound of that device will be output from the HP107's speakers (p. 47).

30 Output jacks

Allows you to output the piano's sound to sound reinforcement equipment to obtain a more powerful sound. These can also be connected to a tape recorder or other recording device to record a performance (p. 47).

Bottom Panel

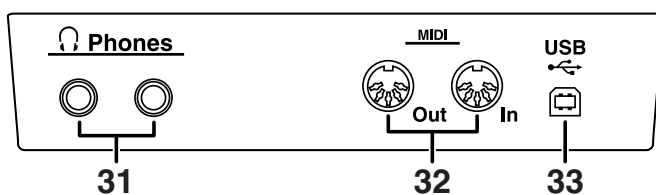

31 Phones jacks

A set of headphones can be connected here (p. 13).

32 MIDI Out/In connectors

Connect to external MIDI devices to exchange performance data (p. 48).

33 USB connector

You can connect a computer and exchange performance data between the instrument and the computer (p. 47).

Before You Start Playing

Connecting the Pedal Cord

Insert the pedal cord into the Pedal connector on the rear panel of the HP107.

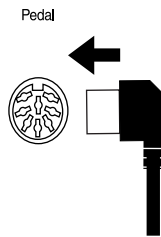

Connecting the Speaker Cable

As shown in the diagram, connect the speaker cable leading from the speaker box of the stand to the speaker connector located on the rear bottom of the HP107.

Push the speaker cable in until it clicks into position.

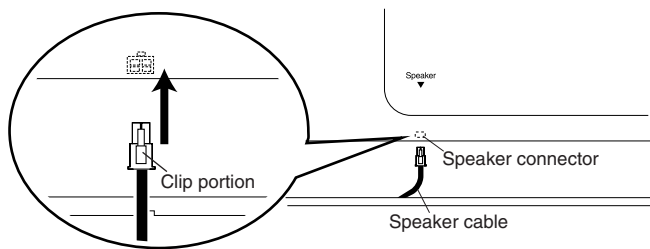

NOTE

Do not put anything that contains water (e.g., flower vases) on this unit. Also, avoid the use of insecticides, perfumes, alcohol, nail polish, spray cans, etc., near the unit.
The speakers of this piano are mounted beneath the upper surface, and face upwards. Malfunctions or accidents may occur if liquids contact any part of the speakers.

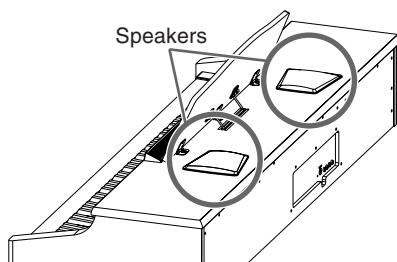

Connect the Power Cord

1. Insert the included power cord into the AC inlet on the bottom panel of the HP107.
2. Plug the power cord into a power outlet.

NOTE

Use only the attached power-supply cord.

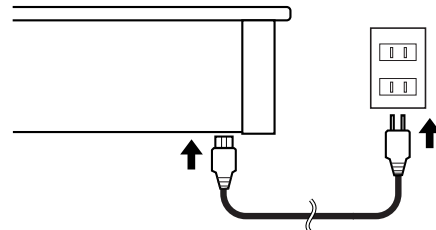

Setting Up the Music Rest

1. Grasping the music rest with both hands, lift it toward you until its in the upright position.
2. Use the support on the back of the music rest to keep the stand in place.

The angle of the music rest can be set to any of three positions.

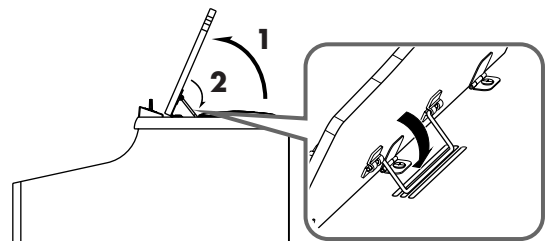

Folding down the music rest

Raise the support located on the back of the music rest, then gently fold down the music rest.

Using the music holders

You can use the holders to hold pages in place. When not using the holders, leave them folded down.

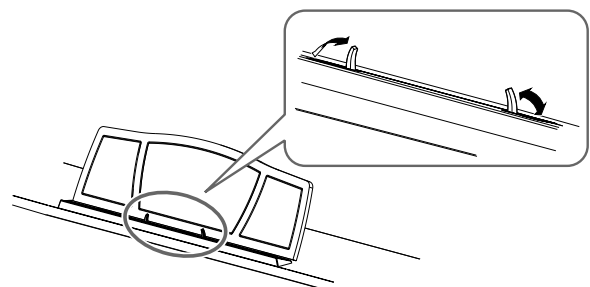

■ Removing the music rest

You can remove the music rest from the piano. This allows you to place a notebook computer on the piano.

Position the music rest so it's upright, then remove the three screws, as shown.

You can remove the screws using a coin.

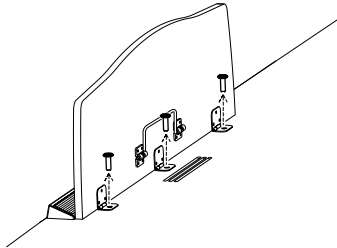

NOTE

Be careful not to lose the screws that you removed from the music rest, or put them where they might be swallowed by small children.

Opening/Closing the Lid

To open the lid, use both hands to lift it lightly, and slide it away from yourself.

To close the lid, pull it gently toward yourself, and lower it softly after it has been fully extended.

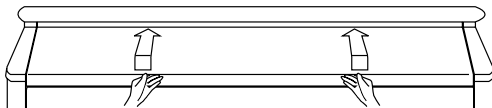

NOTE

When opening and closing the lid, be careful not to let your fingers get caught. If small children will be using the HP107, adult supervision should be provided.

NOTE

If you need to move the piano, make sure the lid is closed first to prevent accidents.

Connecting Headphones

The HP107 has two jacks for plugging in headphones. This allows two people to listen through headphones simultaneously, making it very useful for lessons and when performing piano pieces for four hands. Additionally, this allows you to play without having to worry about bothering others around you, even at night.

Plug the headphones into the Phones jacks located at the bottom left of the piano.

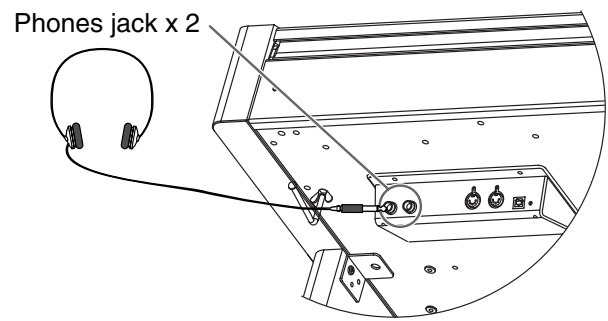

When headphones are connected, the [Headphones] indicator (p. 10) lights up, and sounds stop playing from the speakers of the HP107.

The headphone volume is adjusted by the [Volume] knob (p. 14) of the HP107.

NOTE

Use Stereo headphones.

Make sure to use only Roland headphones. Headphones from other manufacturers may be unable to provide sufficient volume.

Some notes on using headphones

- To prevent damage to the cord, handle the headphones only by the headset or the plug.
- Connecting the headphones when the volume of connected equipment is turned up may result in damage to the headphones. Lower the volume on the HP107 before plugging in the headphones.
- Listening at excessively high volume levels will not only damage the headphones, but may also cause hearing loss. Use the headphones at a moderate volume level.

■ Using the headphones hook

Whenever you are not using the headphones, you can hang them on the headphone hook at the lower left of the HP107.

Attaching the Headphone Hook

Press and twist the headphone hook included with the HP107 into the hole in the bottom of the HP107 (refer to the figure below). Turn the wing nut of headphone hook to secure the headphone hook.

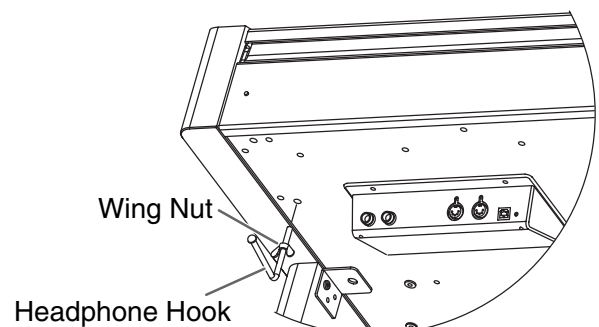

Before You Start Playing

Turning the Power On and Off

NOTE

Turn on power to your various devices in the order specified. By turning on devices in the wrong order, you risk causing malfunction and/or damage to speakers and other devices.

To turn the power on, turn the [Volume] knob all the way down, and then press the [Power On] switch.

The power will turn on, and the Power indicator at the left front of the HP107 will light.

After a few seconds, you will be able to play the keyboard to produce sound.

Use the [Volume] knob to adjust the volume.

- * This unit is equipped with a protection circuit. A brief interval (a few seconds) after power up is required before the unit will operate normally.

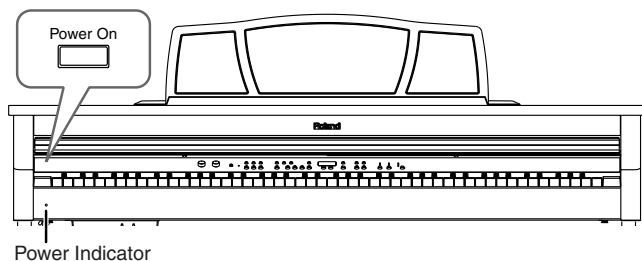

To turn the power off, turn the [Volume] knob all the way to the left, and press the [Power On] switch.

The Power indicator at the left front of the HP107 will go dark, and the power will be turned off.

- * If you need to turn off the power completely, first turn off the [POWER] switch, then unplug the power cord from the power outlet. Refer to "Power Supply" (p. 5).

Adjusting the Sound's Volume and Brilliance

Turn the [Volume] knob to adjust the overall volume.

Turn the [Brilliance] knob to adjust the brightness of the sound.

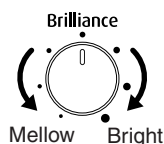
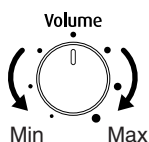

About the Pedals

The pedals have the following functions, and are used mainly for piano performance.

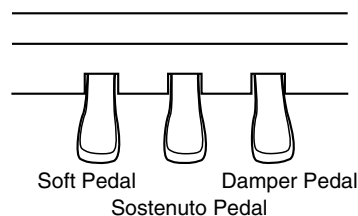

Damper pedal (right pedal)

While this pedal is pressed, notes will be sustained even after you take your fingers off the keys.

The length of sustain will change subtly depending on how deeply you press the pedal.

On an acoustic piano, holding down the damper pedal will allow the remaining strings to resonate in sympathy with the sounds that you played from the keyboard, adding a rich resonance.

The HP107 simulates this damper resonance.

MEMO

You can change the amount of resonance applied with the damper pedal (p. 20).

Sostenuto pedal (center pedal)

This pedal sustains only the sounds of the keys that were already played when you pressed the pedal.

MEMO

You can switch the function of the sostenuto pedal (p. 31).

Soft pedal (left pedal)

When you hold down this pedal and play the keyboard, the sound will have a softer tone.

The softness of the tone can be varied subtly by the depth to which you press the pedal.

About the adjuster

Be sure to use the adjusters underneath the pedals whenever the instrument is moved or when the pedals appear to be unstable.

- Rotate the adjuster to lower it so that it is in firm contact with the floor. If there is a gap between the pedals and the floor, the pedals may be damaged. In particular when placing the instrument on carpet, adjust this so that the pedals firmly contact the floor.

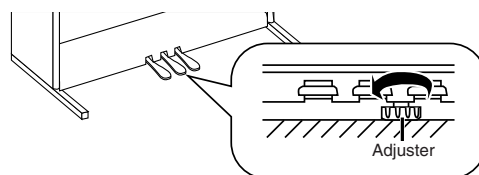

Chapter 1. Enjoying the Built-in Songs

Listening to Built-in Songs

The HP107 comes with 68 piano songs onboard.

■ Playing back all songs continuously (All Song Play)

The built-in songs can be played back consecutively.

MEMO

“Chapter 3. Playing Along with the Built-in Songs” (p. 34), “Tone List” (p. 52)

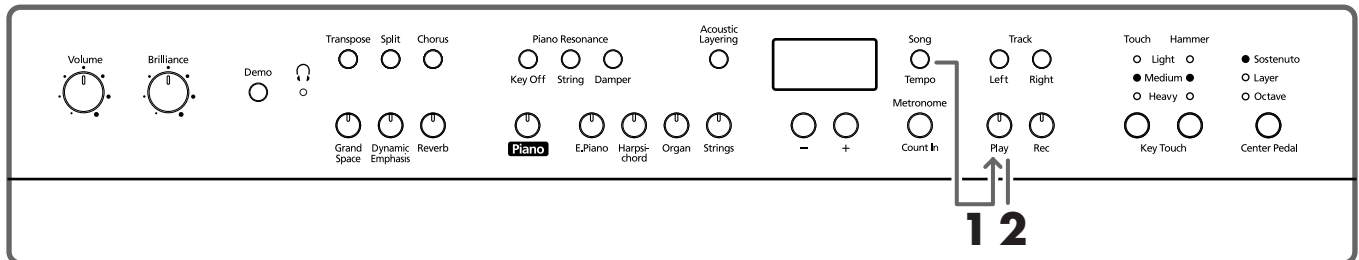

1 Hold down the [Song/Tempo] button, and press the [Play] button.

The [Song/Tempo] button's indicator will light, the [Play] button's indicator will blink, and the songs will play back successively, starting with the currently selected song.

The song number appears in the display for several seconds.



You can press the [-] or [+] button to select the song that you want to play back.

When all songs have been played, playback will return to the first song and resume.

Stopping the playback

2 Press the [Play] button.

Playback will stop.

■ Selecting a song and playing it

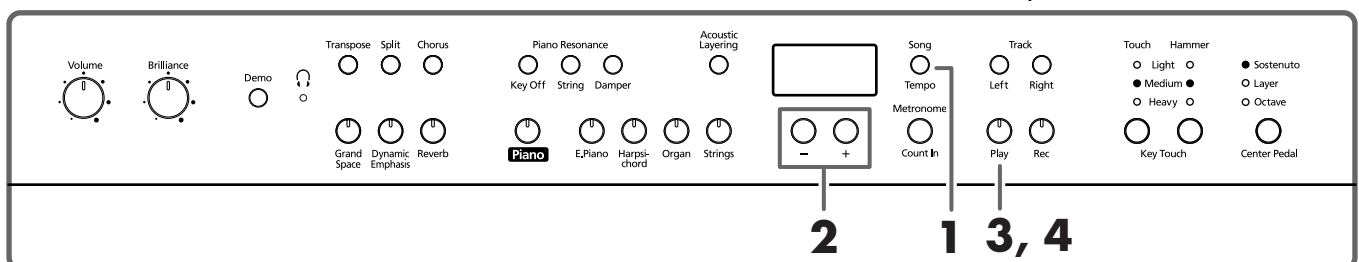

Choosing the song to play back

1 Press the [Song/Tempo] button, getting its indicator to light in red.

The song number appears in the display for several seconds.



MEMO

About the display for the built-in songs

USr (user) ... The location where you can record your performance. (For details on recording → p. 37)

S.1–S.68 ... Built-in songs

S. U ... Song saved with Song Backup (p. 45)

Chapter 1. Enjoying the Built-in Songs

2 Press the [-] or [+] button to select a song.

Holding down the button causes the numbers to change continuously.

Playing back

3 Press the [Play] button.

The button's indicator will light, and the selected song will play.

Stopping the playback

4 Press the [Play] button.

The button's indicator goes out, and playback stops.

The next time you press the [Play] button, the song that was stopped is played from the beginning.

MEMO

Select backed up songs with the following procedure.

- 1 Simultaneously press the [-] and [+] buttons so that "USr" appears in the display.



- 2 Press the [-] button so that "S. U" is displayed.



Listening to the Demo Songs

You can listen to various demo songs, including those demonstrating the piano and other tones, as well as the function applied to the piano tones.

■ Playing Back the Tone Demo Songs

1 Press the [Demo] button.

The button's indicator flashes, and playback of the tone demo songs starts.



When playback of the last song is finished, playback then returns to the first song.

When you press any of the tone buttons while the [Demo] button is flashing, the demo song corresponding to that tone button is played.

Button assigned tone demo	Demo content
[Piano]	Piano tone demo songs
[E. Piano]	E. Piano tone demo songs
[Harpichord]	Harpichord tone demo songs
[Organ]	Organ tone demo songs
[Strings]	Strings tone demo songs
[Acoustic Layering]	Demo songs using the Acoustic Layering function (p. 28)
[Split]	Demo songs using the Split function (p. 30)

Stopping the Tone Demo Songs

2 Press the [Demo] button.

The [Demo] button's indicator goes off, and the demo quits.

■ Listening to a Demo of the Functions

You can listen to the demo of the functions that can be applied to the piano tones.

1 Press the [Demo] button.

The button's indicator flashes, and playback of the tone demo songs starts.

2 Press any of the following buttons.

Button assigned function demo	Demo content	Page
[Grand Space]	Grand Space demo	p. 23
[Dynamic Emphasis]	Dynamic Emphasis demo	p. 25
Piano Resonance [Key Off]	Key off demo	p. 19
Piano Resonance [String]	String Resonance demo	p. 19
Piano Resonance [Damper]	Damper Resonance demo	p. 20
Key Touch [Hammer]	Hammer Response demo	p. 22

When a button is pressed, the demo assigned to the button is played.

Two versions of the demo will be played—one includes the function provided by the button you've pressed, the other doesn't.



About the Hammer Response Function Demo

The performance stops when the Hammer Response function demo is selected.

Hammer Response is alternately switched on and off each time you press the Key Touch [Hammer] button.

Try playing the keyboard and see how the Hammer Response function feels.

When Hammer Response is switched on, the sounds are expressed more slowly as you play the keys with greater force.



When you press the button pressed in Step 2, you can switch between demos both with the function switched on and off.



The Hammer Response function demo makes it easy to hear how the sound will be with the function both on and off.

Stopping the Demo of the Functions

3 Press the [Demo] button.

The [Demo] button's indicator goes off, and the demo quits.

Chapter 2. Performance

Performing with a Variety of Sounds

The HP107 contains 36 different built-in tones. The tones are organized into five tone groups, which are assigned to the Tone buttons.

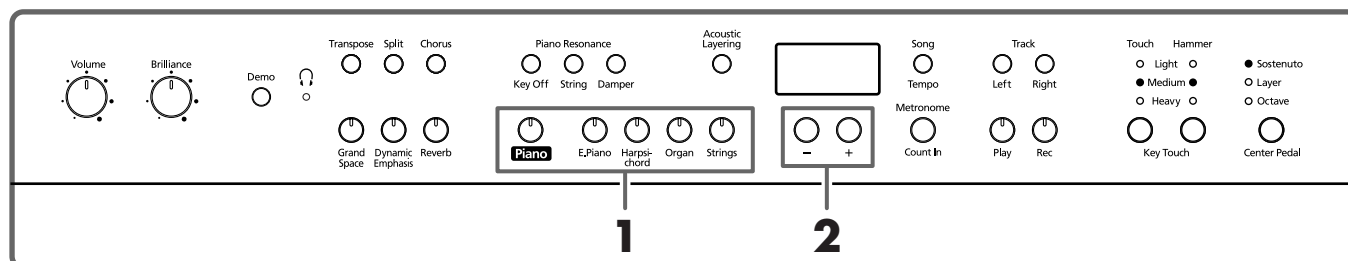

Selecting a tone group

1 Press any Tone button.

The indicator of the button you pressed will light.

When you play the keyboard, you will hear a sound in the selected tone group.

Selecting variation tones

2 Press the [-] or [+] button.

The song number appears in the display for several seconds.



The tone you've selected is heard when you finger the keyboard.



For more details, refer to "Tone List" (p. 52).

Making Fine Adjustments to the Piano Sound (Piano Resonance)

You can make fine adjustments to the sound of the piano as desired.

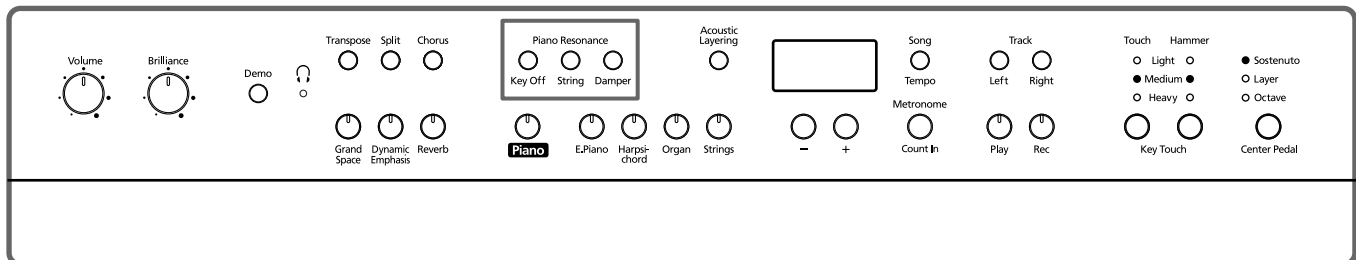

■ Playing Sounds When the Keys Are Released (Key Off)

You can play the “key off” sound (the subtle sound produced when the keys are released) obtained when playing an acoustic piano.

1 Press the Piano Resonance [Key Off] button, getting its indicator to light.

A distinctive sound results when you release the keys.

Press the Piano Resonance [Key Off] button once more, causing the button’s indicator to go off, and the effect is cancelled.

Adjusting the Volume of the Key Off Sound

2 Hold down the Piano Resonance [Key Off] button and press the [-] or [+] button.

You can set the volume of the sound heard when the keys are released to any of ten different levels.

The volume increases as the value is raised.

■ Producing the Resonance of the Strings When the Keys Are Played (String Resonance)

When you play the keys on an acoustic piano, the strings that are already playing resonate as well. The function that reproduces this effect is called “String Resonance.”

1 Press the Piano Resonance [String] button, getting its indicator to light.

The String Resonance function is switched on.

Press the Piano Resonance [String] button once more, causing the button’s indicator to go off, and the effect is cancelled.

Adjusting the Depth of the Resonance

2 Hold down the Piano Resonance [String] button and press the [-] or [+] button.

You can adjust the resonance depth (the volume of the resonance) to any of ten levels.

More resonance effect is applied as the value is increased.



You can save this setting in the HP107’s memory using the Memory Backup function (p. 45).



For more about the tones with which this setting is enabled, refer to the “Tone List” (p. 52).



This setting is enabled only with the piano tones. You cannot set this for other tones.



You can save this setting in the HP107’s memory using the Memory Backup function (p. 45).

■ Having Resonance Played When You Press the Damper Pedal (Damper Resonance)

You can change the volume of the damper pedal resonance.

On an acoustic piano, depressing the damper pedal makes the notes you play resonate with other strings, adding rich reverberations and fatness to the sound. The damper pedal on the HP107 recreates this resonance (damper resonance) when depressed.

1 Hold down the Piano Resonance [Damper] button, getting its indicator to light.

The Damper Resonance function is switched on.

Press the Piano Resonance [Damper] button once more, causing the button's indicator to go off, and the effect is cancelled.

Adjusting the Depth of the Resonance

2 Hold down the Piano Resonance [Damper] button, and press the [-] or [+] button.

You can select from ten levels of depth for the resonant sound (resonance level).

Larger values will produce a deeper effect.

NOTE

This setting is enabled only with the piano tones. You cannot set this for other tones.

MEMO

You can save this setting in the HP107's memory using the Memory Backup function (p. 45).

Adjusting the Keyboard Touch (Key Touch)

You can adjust the touch (playing feel) of the keyboard.

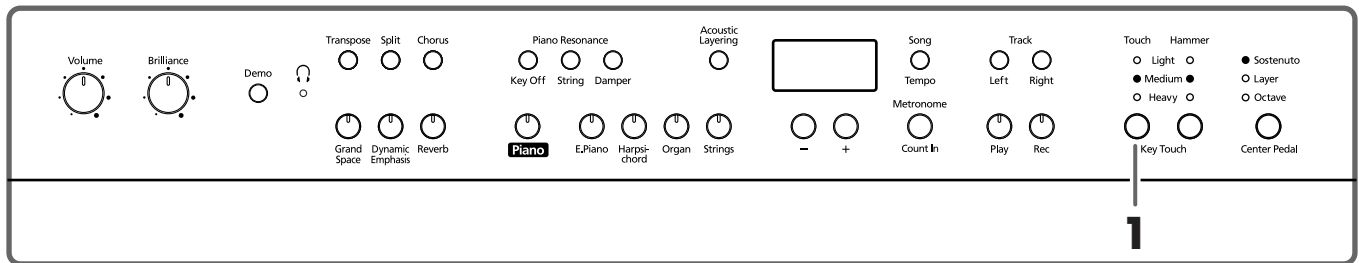

1 Press the Key Touch [Touch] button.

Each time you press the Key Touch [Touch] button, the indicator that is lit switches, and the touch changes.

Indicator	Settings	
"Light" Lit	Light	Fortissimo (ff) can be produced by playing less strongly than usual, making the keyboard feel lighter. This setting makes it easy to play, even for children.
"Medium" Lit	Medium	This allows you to play using the most natural touch. This is the closest to the touch of an acoustic piano.
"Heavy" Lit	Heavy	Fortissimo (ff) cannot be produced unless you play more strongly than usual, making the keyboard feel heavier. Dynamic fingering adds even more feeling to what you play.
All Indicators Off	Fixed	Sounds at a fixed volume, regardless of your keyboard playing strength.



You can save this setting in the HP107's memory using the Memory Backup function (p. 45).

■ Changing the Timing of Sounds According to the Force Used to Press the Keys (Hammer Response)

This adjusts how your playing strength will affect the timing at which the note sounds. This is called the “Hammer Response” function.

On an acoustic piano, pressing a key moves a hammer, which strikes a string to produce sound. If you press the key softly, the hammer will move slowly, meaning that it will take slightly longer (in comparison to a strongly-played note) from the moment you press the key until the sound is produced.

If the Hammer Response function is turned on, the time between the moment you press a key until the sound is heard will change depending on the strength with which you play. As you play more softly, this time will become longer.



You can save this setting in the HP107's memory using the Memory Backup function (p. 45).

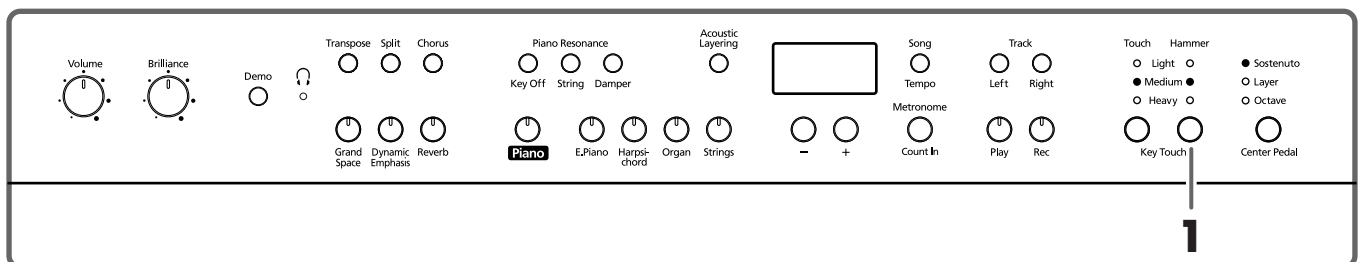

- 1 Press the Key Touch [Hammer] button to get the appropriate indicator to light.

Indicator	Setting
“Light” Lit	The response is faster when the keys are pressed gently.
“Medium” Lit	The regular timing is used when the keys are pressed gently.
“Heavy” Lit	The timing of the sounds is delayed when the keys are pressed gently.
All Indicators Off	The Hammer Response function is cancelled. The sound is played immediately, regardless of the force with which the keys are played (velocity).

Adding a Sense of Depth to the Sound (Grand Space)

The HP107 includes a “Grand Space” function that allows you to get sounds that have a sense of depth like you get by playing an acoustic piano. Using this function gives you the natural-sounding reverberation and breadth of sound that an acoustic piano provides.



You can save this setting in the HP107’s memory using the Memory Backup function (p. 45).

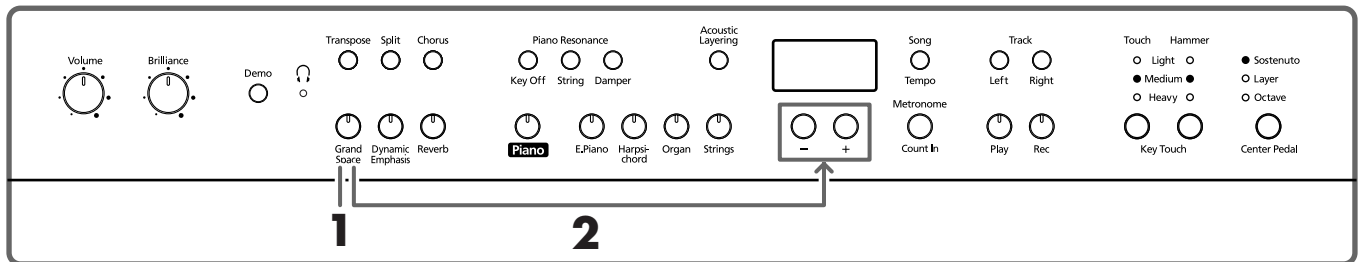

1 Press the [Grand Space] button, getting its indicator to light.

The Grand Space function is switched on, giving the sound a greater sense of depth. To cancel the Grand Space function, press the [Grand Space] button once more so its illumination is turned off.

Changing the Grand Space Settings

2 Hold down the [Grand Space] button, and press the [-] or [+] button.

You can adjust the sense of depth to any of four levels.

A greater sense of depth is produced as the value is increased.



When Grand Space Mode (p. 43) is set to “1” and a pair of headphones is connected, the sense of depth is optimized for headphones, and when no headphones are connected, the optimal depth for speakers is selected.

Adding the Right Sense of Depth for Headphones (Grand Space)

You can achieve the kind of sonic depth produced with a grand piano through headphones as well. Using this function provides you with the natural reverberation and breadth in the sound provided by an acoustic piano.



You can save this setting in the HP107's memory using the Memory Backup function (p. 45).

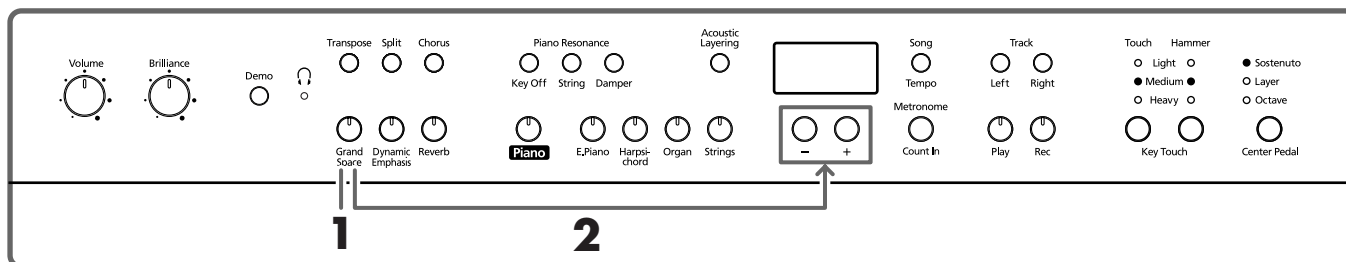

1 Press the [Grand Space] button, getting its indicator to light.

The Grand Space function is switched on, giving the sound a greater sense of depth. To cancel the Grand Space function, press the [Grand Space] button once more so its illumination is turned off.

Changing the Grand Space Settings

2 Hold down the [Grand Space] button, and press the [-] or [+] button.

You can adjust the sense of depth to any of four levels.

A greater sense of depth is produced as the value is increased.



When Grand Space Mode (p. 43) is set to "1" and a pair of headphones is connected, the sense of depth is optimized for headphones, and when no headphones are connected, the optimal depth for speakers is selected.



The [Headphones] indicator lights up when headphones are connected.

Adding Liveliness to the Sound (Dynamic Emphasis)

You can add liveliness to the sound to give it superb clarity and distinctness.



You can save this setting in the HP107's memory using the Memory Backup function (p. 45).

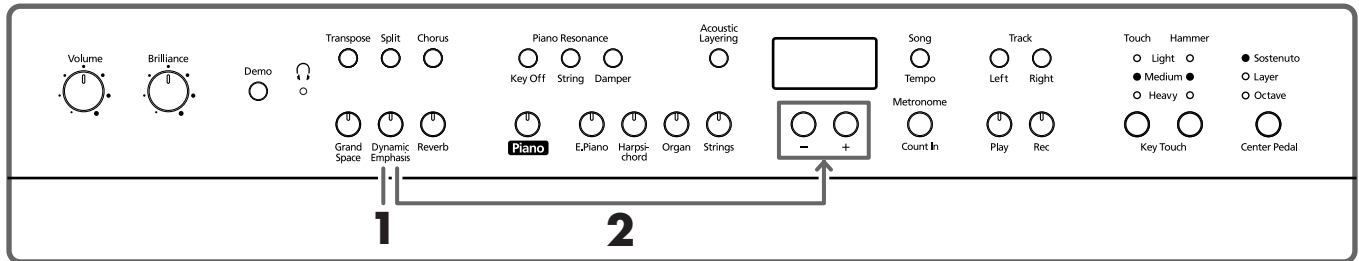

1 Press the [Dynamic Emphasis] button, getting its indicator to light.

The Dynamic Emphasis function is switched on, enlivening the sound.

To cancel the Dynamic Emphasis function, press the [Dynamic Emphasis] button once more so its illumination is turned off.

Changing the Dynamic Emphasis Settings

2 Hold down the [Dynamic Emphasis] button, and press the [-] or [+] button.

Indicator	Description
1	Creates a sound with boosted bass and treble.
2	Produces a sound with chords in the low registers that are clear and distinct.
3	Creates a sound with boosted bass.

Applying Effects to the Sound

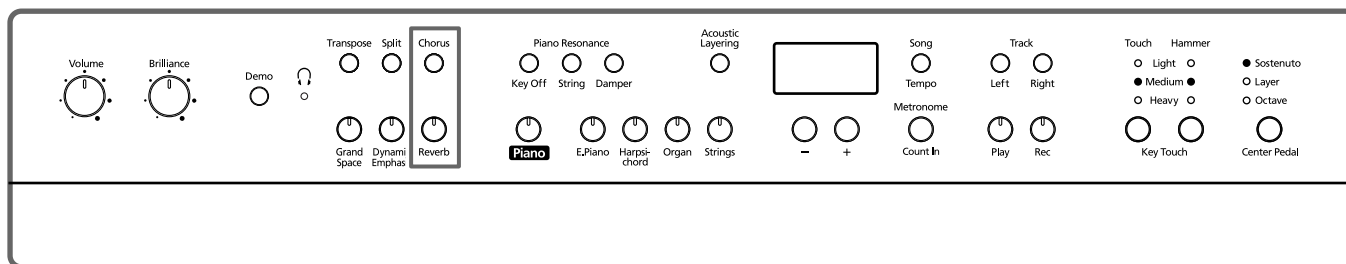

■ Adding reverberation to the sound (Reverb)

By applying the reverb effect you can produce a pleasant reverberation, making it sound as though you were performing in a concert hall.

1 Press the [Reverb] button.

The button's indicator will light, and a reverb effect will be applied to the sound.

To cancel the reverb effect, press the [Reverb] button, getting its indicator to go dark.

■ Adding richness to the sound (Chorus)

By adding the chorus effect, you can give the sound greater dimension, with more fatness and breadth.

1 Press the [Chorus] button.

The button's indicator will light, and a chorus effect will be applied to the sound.

To cancel the chorus effect, press the [Chorus] button, getting its indicator to go dark.

■ Changing the amount of effect applied

The amount (depth) of the reverb and chorus effects can be set to any of ten levels.

Changing the depth of the reverb effect

1 Hold down the [Reverb] button and press the [-] or [+] button.

The currently specified value will be displayed.

Higher values will produce a deeper effect.

Changing the depth of the chorus effect

1 Hold down the [Chorus] button and press the [-] or [+] button.

The currently specified value will be displayed.

Higher values will produce a deeper effect.

MEMO

You can save the reverb on/off setting as well as the setting for the amount of reverb applied in the HP107's memory using the Memory Backup function (p. 45).

MEMO

You can save separate chorus effect on/off settings to each tone individually. The original settings are restored when the power is turned off.

MEMO

With the factory settings, the reverb and chorus are set to "5."

NOTE

You cannot save separate reverb settings to each tone individually.

Transposing the Key of the Keyboard (Transpose)

By using the “Transpose function,” you can transpose your performance without changing the notes you play. For example, even if the song is in a difficult key with numerous sharps (#) or flats (♭), you can transpose it to a key that is easier for you to play.

When accompanying a vocalist, you can easily transpose the pitch to a range that is comfortable for the singer, while still playing the notes as written (i.e., with the same fingering positions).

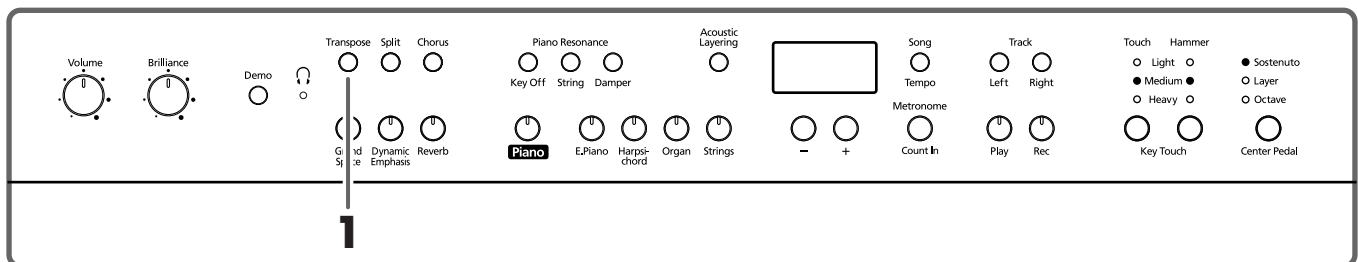

1 Continue to hold down the [Transpose] button, and press a note to indicate the tonic of the key to which you want to transpose.

The button's indicator will light, and the keyboard will be transposed.

You can also transpose by holding down the [Transpose] button and pressing the [-] or [+] button.

If you hold down the [Transpose] button and press the [-] and [+] buttons simultaneously, the setting will return to the original value (0).

This can be set in a range of -6–0–5 (semitone steps).

For example, if you want the E pitch to sound when you play the C key, hold down the [Transpose] button and press the E key.

Counting from C as a reference point, one moves up four keys, including the black keys, to reach E, thus “4” appears in the display.

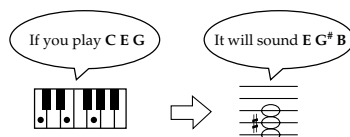

When the transpose value is set to “0,” the button's indicator will remain dark even if you press the [Transpose] button.

To cancel the transpose function, press the [Transpose] button, extinguishing its indicator.

When you press the [Transpose] button once again, getting its indicator to light, the keyboard will be transposed to the note you specified here.



When you hold down the [Transpose] button, the currently specified value will be displayed.



This setting returns to the original value (0) when you turn off the power.

Layering Complementary Sounds with the Piano Tones (Acoustic Layering)

With the HP107, you can easily select the perfect tones to complement the piano tone and play together with the piano tone. This feature is called the “Acoustic Layering function.”



You can change the pitch of the Layer tone in octave steps (p. 43).

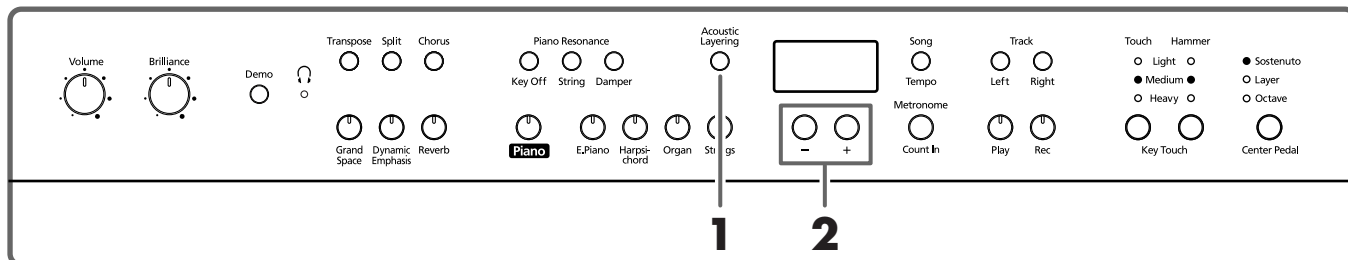

First have a piano tone selected (p. 18).

1 Press the [Acoustic Layering] button, getting its indicator to light.

When you play the keyboard, the piano tone and the tone complementing it are layered and played together.

Selecting the Tone to Be Layered with the Piano Tone

2 Use the [-] and [+] buttons to select the layered tone.

The song number appears in the display for several seconds.

The number for the tone layered with the piano tone (the layer tone) has “L.” appended to it.



When you play the keyboard, the piano tone and the tone you have selected are layered and played together.

Changing the Volume Balance When Performing with Acoustic Layering

You can adjust the balance in volume between the two selected tones when performing with Acoustic Layering.

1 Hold down the [Acoustic Layering] button and press the [-] or [+] button.

The volume balance changes.

To return to the original volume balance, press the [-] and [+] buttons simultaneously.



Volume of the Piano tone Volume of Layer Tone



When you want to layer sounds to tones other than the piano tone, press the tone button, then select the tone to be used as the basis.



When “Layer” is selected as the center pedal setting, the Acoustic Layering function is switched on automatically (p. 28). In this case, you can adjust the volume of the tone layered with the piano tone with the pedal.



When the volume balance is changed with Acoustic Layering in effect, the Dual Balance also changes to the same volume balance settings (p. 29).

Playing Two Sounds Together (Dual Performance)

Simultaneously playing two tones when one key is pressed is called “Dual performance.” You can select the tone you want to have layered by pressing the corresponding tone button.

1 Simultaneously press the two Tone buttons that you want to play together.

The indicator of the button you pressed will light.

When you play the keyboard, the tones of the two Tone buttons you selected will sound simultaneously.

To cancel Dual performance, press any Tone button.

To change the tone of the right button of the two selected tones

2 Press the [-] or [+] button.

Dual performance now features the tone of the left side’s tone button along with the newly selected tone.

To change the tone of the left button of the two selected tones

Cancel the Dual performance, and then re-select the tone. Press the two Tone buttons that you want to play together.

■ Adjusting the volume balance in Dual performance (Dual Balance)

You can change the volume balance between the two layered sounds in Dual performance.



You can change the pitch of the tone of the right button in octave steps (p. 43).

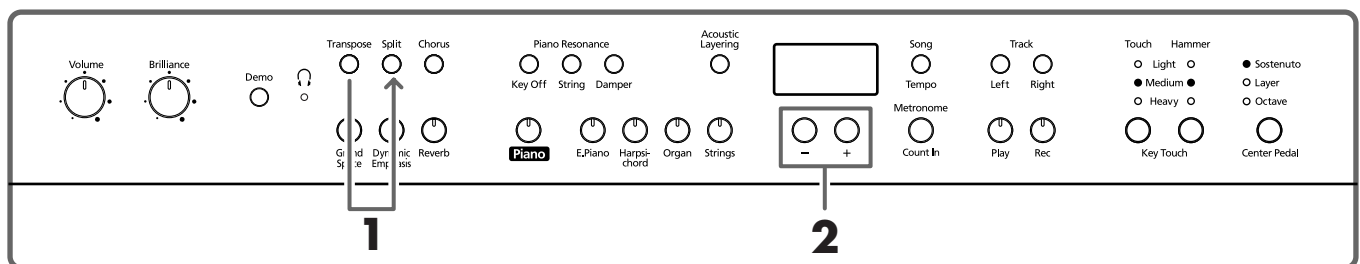

1 Hold down the [Transpose] button, and press the [Split] button.

The indicators of the buttons you pressed will blink.
The current volume balance appears in the display.

2 Press the [-] or [+] button to change the value.

The volume balance changes.

To return to the original volume balance, press the [-] and [+] buttons simultaneously.

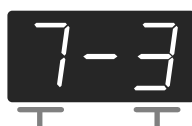

Volume of the left button tone Volume of the right button tone

Press any button other than the [-] [+] buttons, and the button’s indicator will return to the previous state.



You can save this setting in the HP107’s memory using the Memory Backup function (p. 45).



You can also change the volume balance by holding down the [Acoustic Layering] button and pressing the [+] or [-] button.

Playing Different Tones with the Left and Right Hands (Split Performance)

Dividing the keyboard into right-hand and left-hand areas, then playing different sounds in each is called “Split performance.” The boundary key is called the “split point.”

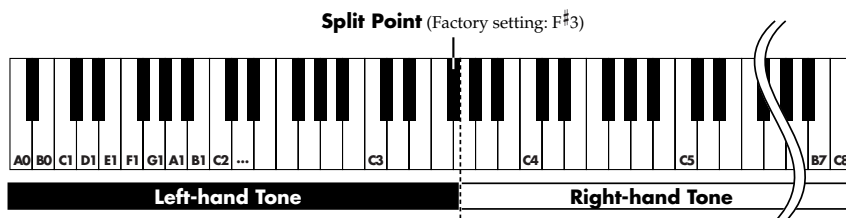

The split point key is included in the left-hand keyboard area.



When using Dual performance, press the [Split] button

The right hand will play the tone of the left button of Dual performance, and the left hand will play a suitable match for the right-hand tone.

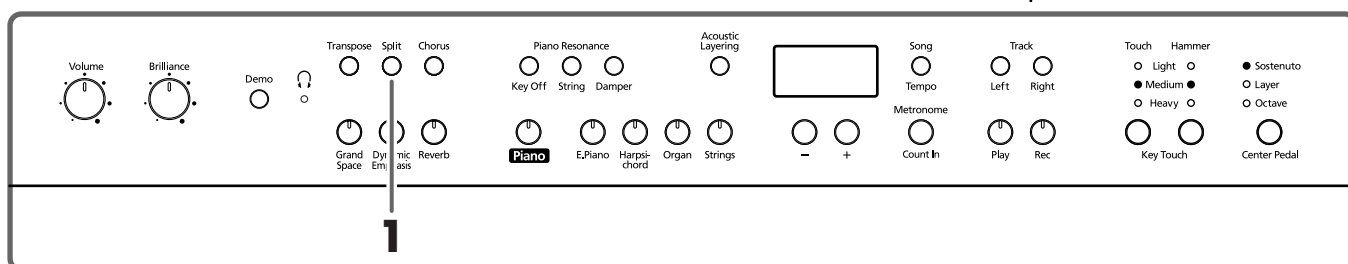

1 Press the [Split] button.

The button’s indicator will light.

The keyboard is divided into right-hand and left-hand areas.

The tone played on the right side is the tone in use before the [Split] button is pressed, while the bass tone is played on the left side when the power is turned on, with a different tone selected when the left-hand tone is changed.

To cancel Split performance, press the [Split] button, getting its indicator to go dark.

Changing tone played by the left hand

1 Press any Tone button.

2 Press the [-] or [+] button.

Each time you press the [-] or [+] button, the left-hand tone will change.

Changing tone played by the right hand

Cancel Split performance, and then re-select the tone.



You can change the pitch of the tones on the left side of the keyboard in octave steps (p. 43).



For more about the tones, refer to the “Tone List” (p. 52).



In Split performance, the damper pedal will be applied only to the right-hand area of the keyboard. If you want the damper pedal to be applied to the left-hand area, refer to “Applying the damper pedal to the left-hand keyboard area” (p. 43).

■ Changing the keyboard's split point

You can change the location where the keyboard is divided (the split point) within the range of B1 through B6.

1 While continuing to hold the [Split] button, press the key that you want to specify as the split point.

The key you pressed becomes the split point, and belongs to the left-hand section of the keyboard.

You can also change the setting by pressing the [-] or [+] button while continuing to hold down the [Split] button.

If you hold down the [Split] button and simultaneously press the [-] and [+] buttons, the setting will return to its original value (F#3).



Changing How the Center Pedals Work

With the factory setting, the center pedal functions as a sostenuto pedal (p. 14).

However, the center pedal setting can be changed to any of a variety of different functions.



This is set at the factory to "F#3."



The split point key is displayed as follows.

Display	C	C ⁻	d	E ₋
Letter name	C	C#	D	E ^b
Display	E	F	F ⁻	G
Letter name	E	F	F#	G
Display	A ₋	A	b ₋	b
Letter name	A ^b	A	B ^b	B



When you continue holding the [Split] button, the currently specified split point value will be displayed.

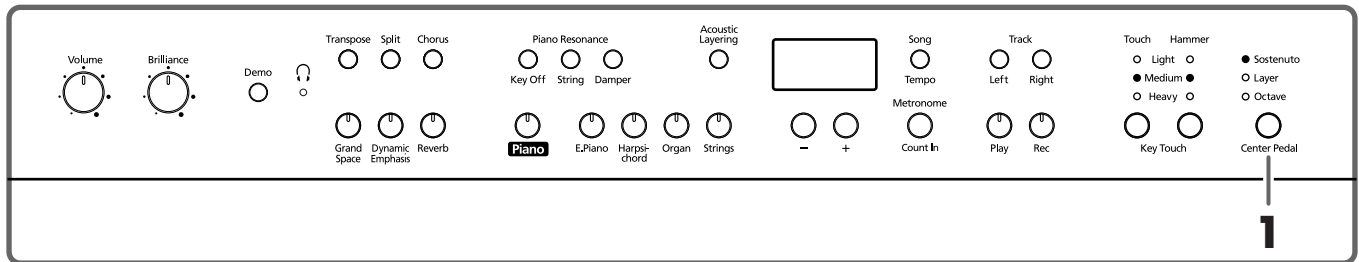

1 Press the [Center Pedal] button to get the appropriate indicator to light.

Lighted Indicator	Description
Sostenuto	Sets function to sostenuto pedal (p. 14).
Layer	When you play a key while pressing on the center pedal, a suitable tone to match the piano tone is selected, and the two tones are layered and played together. The volume of the layer tone is adjusted according to how much you press the pedal.
Octave	When you play a key while pressing on the center pedal, the note for the key being pressed and the note one octave above it are layered and played together. You can adjust the volume of the sound one octave above the layer tone by changing the pressure used on the pedal.



If Acoustic Layering (p. 26) and Dual function are switched off, the Acoustic Layering function is then switched on.

Using Metronome

■ Sounding the metronome

The HP107 features a built-in metronome. While a song plays back, the metronome will sound at the tempo and time signature (Beat) of that song.

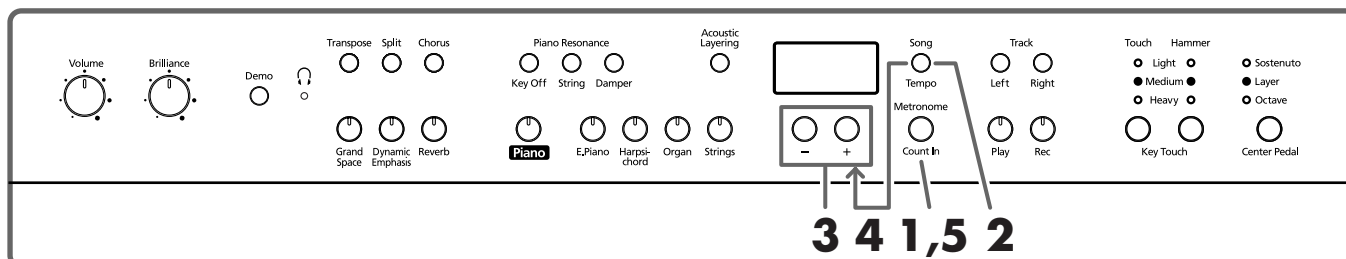

Sounding the metronome

2 Press the [Metronome/Count In] button.

The metronome will sound.

The button's indicator flashes in red and green in time with the beat selected at that time. The indicator lights in red on the downbeats, and in green on weak beats.

Changing the tempo

3 Press the [Song/Tempo] button; the button's indicator lights in green.

4 Press the [-] or [+] button to adjust the tempo.

Changing the beat of metronome

5 Hold down the [Song/Tempo] button, and press the [-] or [+] button.

The currently selected beat will be displayed.

If you hold down the [Song/Tempo] button and press the [-] or [+] button, the beat will change.

If you hold down the [Song/Tempo] button and press the [-] and [+] buttons simultaneously, the beat will go back to what it was before you changed it.



Display	beat	Display	beat	Display	beat
2.2	2/2	4.4	4/4	3.8	3/8
0.4	Only weak beats	5.4	5/4	6.8	6/8
2.4	2/4	6.4	6/4	9.8	9/8
3.4	3/4	7.4	7/4	12.8	12/8

Stopping the metronome

6 Once again press the [Metronome/Count In] button, getting its indicator to go dark.

The metronome will stop.

NOTE

It is not possible to change the beat during song playback or recording.

MEMO

Correspondence between beat and tempo display

Beat	Tempo Value
2/2	♩ = 5-250
x/4	♩ = 10-500
3/8	♩ = 20-999
6/8 9/8 12/8	♩ = 7-333

■ Changing the metronome volume

The volume of the metronome can be adjusted, with ten volume levels available.

- 1 While holding down the [Metronome/Count In] button, press the [-] or [+] button.

The currently specified volume will be displayed.

Continue to hold down the [Metronome/Count In] button, and press the [-] or [+] button to sound the metronome, and change the volume.



Splitting the Keyboard Into Two Sections for Four-Hand Performances (Twin Piano Mode)

You can divide the keyboard into two separate sections, allowing two people to perform in the same registers.

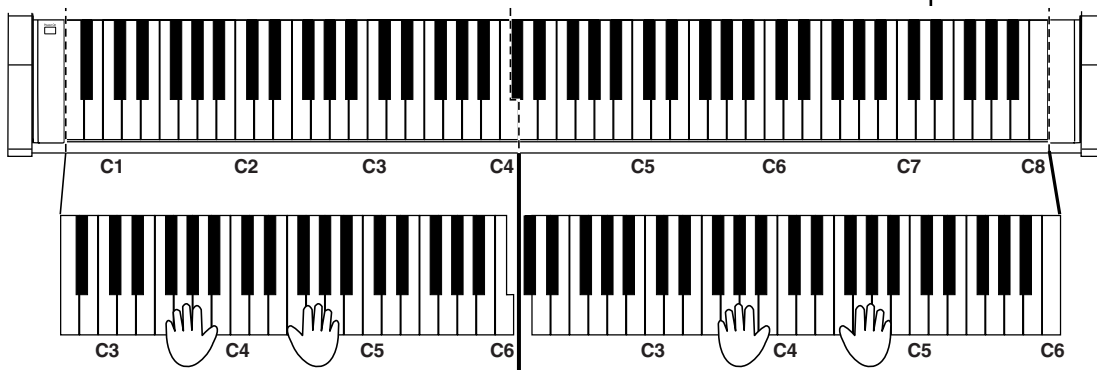

- 1 While holding down the [Split] button and press the [Piano] button.

The [Split] button's indicator will light, and Twin Piano Mode is switched on.

The following occur when Twin Piano Mode is switched on:

- The keyboard is divided into two separate sections, and the pitch changes.
- The right pedal now functions as the damper pedal for the right keyboard section, and the left pedal functions as the damper pedal for the left keyboard section.
- The center pedal now functions as the Sostenuto pedal for the right keyboard section.
- If recording is in progress or the instrument is in recording standby, recording is stopped or recording standby is cancelled. The [Rec] button is disabled while Twin Piano Mode is active.
- If the Split function happens to be on, it is switched off.
- The same tone and effects are used on both the left and right sides. If the piano is in Split Play before switching Twin Piano Mode on, then the tone selected for the right hand in Split Play is used.

* The damper resonance function is not operational in Twin Piano Mode.

- 2 To exit the function, while holding down the [Split] button and press the [Piano] button.



This is set to "4" when the instrument is turned on.



When the metronome volume is set to "0," the metronome sound does not play.

Chapter 3. Playing Along with the Built-in Songs

Here's how you can play along with the built-in songs.

You can slow down the playback tempo of the song, or play back each hand separately. Before you try playing the song, listen to it several times to get a general feel for the song.

For details on operation, refer to "Selecting a song and playing it" (p. 15).

Changing the Tempo

If the song has a rapid tempo, you can slow down the tempo so that you can practice it more easily. It is effective to gradually raise the tempo as you practice.



If you turn on the metronome while the song plays back, the metronome will sound at the beat and tempo of the song.



Some of the built-in songs have tempos that change during the song.

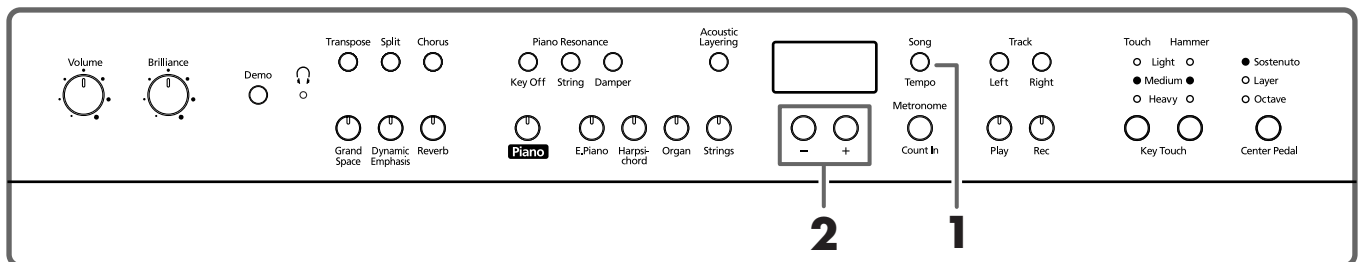

First select the song that you want to play back (p. 15).

1 Press the [Song/Tempo] button, getting its indicator to light in green.

The tempo appears in the display.

Each time you press the [Song/Tempo] button, the tempo and the currently selected song number (prefixed by "S.") will be displayed alternately.

While the tempo is displayed, the [Song/Tempo] button indicator will light in green. While the song number is displayed, it will light in red.

2 Press the [-] or [+] button to adjust the tempo.

The tempo can be adjusted in a range of ♩=10-500.

You can also change the tempo during playback.

Pressing the [+] button once increases the tempo by one unit. Holding down the button increases the tempo continuously.

Pressing the [-] button once decreases the tempo by one unit. Holding down the button makes the tempo change (slow down) continuously.

If you press the [-] and [+] buttons simultaneously, you will return to the basic tempo of the song (the tempo before you modified it).

■ Adding a count-in to match the timing (Count-In)

When you're playing along with a song, you can make sure that your playing is in time with the song by sounding a count before the song starts playing.

Sounding a "count sound" leading up to playback of a song is called "Count-In."

On the HP107, if you playback a song while the metronome is sounding, two measures of lead-in count will be heard at the beginning of the song.



Correspondence between beat and tempo display

Beat	Tempo Value
2/2	♩ = 5-250
x/4	♩ = 10-500
3/8	♩ = 20-999
6/8 9/8 12/8	♩ = 7-333



About the display for the built-in songs

USr (user) ... The location where you can record your performance. (For details on recording → p. 37)

S.1-S.68 ... Built-in songs

S. U ... Song saved with Song Backup (p. 45)



During the count-in, the count measure is indicated in the display as "-2" then "-1."



"Sounding the metronome" (p. 32)

Playing Each Hand Separately

The built-in songs allow you to select the performance part that will be played back. The left-hand performance of the built-in songs is assigned to the [Left] button, while the right-hand performance is assigned to the [Right] button. The place where each part of the performance is held is called a “track,” and the [Left] and [Right] buttons are called “track buttons.”

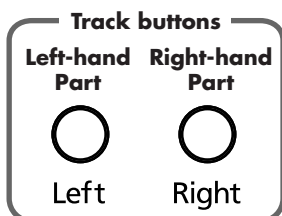

Here’s how to practice each hand separately along with the song.

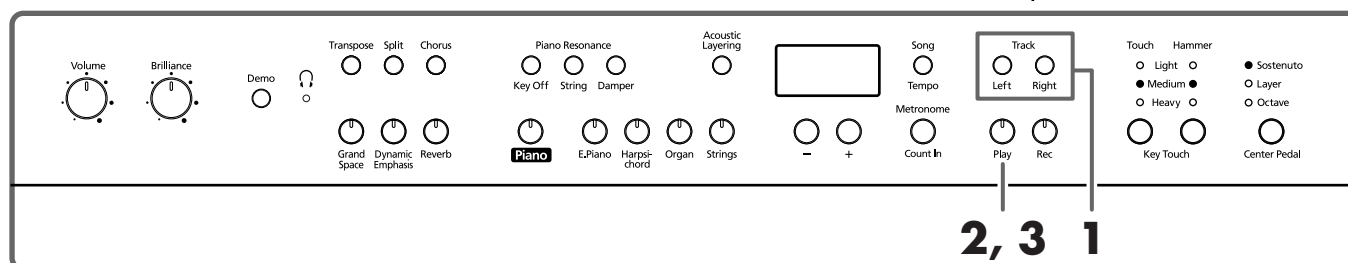

First select the song that you want to play back (p. 15).

Selecting the part that you yourself will play

- 1 Press the [Left] or [Right] button.

The indicator of the button you’ve pressed goes out, and the sound of the selected part will no longer be heard.

For example, if you want to practice the right hand, press button [Right] and get its indicator to go dark. When you play back the song, the right-hand performance will not sound.

Playing back a song

- 2 Press the [Play] button, getting its indicator to light.

The song will begin playing back. The part you selected in step 1 will not sound.

Practice your right-hand performance along with the left-hand playback.

Once again press the button you selected in step 1. The button’s indicator will light, and the sound will be heard once again.

Even while the song is playing, you can press the track buttons to mute or un-mute the sound.

Stopping the song

- 3 Press the [Play] button, getting its indicator to go dark.

The song will stop.

Chapter 4. Recording Your Performance

You can easily record your performances.

A recorded performance can be played back to hear your own playing, or to add additional parts.

The following types of recording can be done using the HP107.

- Recording just your own keyboard performance (→ “Recording a New Song” p. 37)
- Recording along with a built-in song (→ “Recording Along with a Song” p. 38)
- Recording each hand separately (→ “Selecting and Recording the Track for Each Hand Separately” p. 39)

■ Notes regarding recording

- Only one song can be recorded.
- The HP107 includes a “Song Backup function” (p. 45), which allows you to store the song recorded with the HP107 in the instrument itself. Recorded performance that have not been backed up with Song Backup is erased with the power is turned off. Be sure to use Song Backup for any performance you want to keep. You can either record it on an external audio device, or use an external MIDI device to save the performance data on a floppy disk. For details, refer to “Chapter 6. Connecting External Devices” (p. 47).

If you see the following...

If you attempt to select a song when another performance has already been recorded, the following appears in the display and the [Record] button’s indicator flashes.



If it is OK to erase the performance, press the [Rec] button.

If you do not want to erase the performance, press the [Play] button.

About the Recorded Tracks

A. Recording without specifying the track to be recorded

If there is no data recorded on the left and right track, the data is then recorded to the right track. If there is any data recorded to either the left or right track, the data is then recorded to the empty track.

B. Recording while using the Dual, Acoustic Layering, or Split functions

Function	Left Track	Right Track
Dual	Tone from right tone button	Tone from left tone button
Acoustic Layering	Layer tone	Original tone (piano tone)
Split	Left (keyboard) tone	Right (keyboard) tone

C. Recording while the “Layer” or “Octave” function is assigned to the center pedal

Function	Left Track	Right Track
Layer	Layer tone	Original tone (piano tone)
Octave	Layer tone (one octave higher)	Original tone

* When using method B or C above to layer a recording to a song, press both the [Left] and [Right] buttons before recording so that the buttons flash.

Recording a New Song

Record only the keyboard performance without playing along with a built-in song.

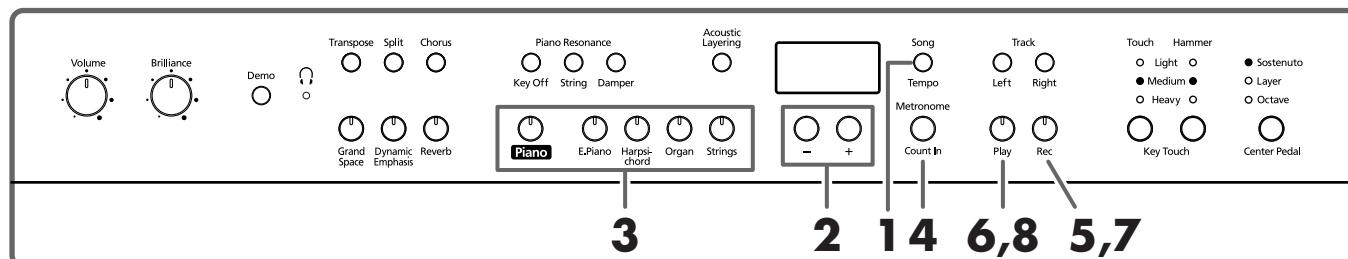

Recording settings (select "USr")

- 1 Press the [Song/Tempo] button, getting its indicator to light in red.

The song number appears in the display.

- 2 Press [-] and [+] buttons simultaneously, and "USr" appears in the display.

Specifying the tone and tempo for recording

- 3 Select the tone that you want to play (p. 18).

- 4 If necessary, turn on the metronome.

Sound the metronome while you set the tempo and beat of the song (p. 32).

- 5 Press the [Rec] button.

The [Rec] button's indicator will light, the [Play] button's indicator will blink, and you will be in recording-standby mode.

Start recording

- 6 Recording will start when you either press the [Play] button or play the keyboard.

Two measures of the count sound are played, and the recording begins.

Note that recording will also begin as soon as you play anything on the keyboard, even if you do not press the [Play] button. There is no count sound played when you start in this manner.

When recording begins, the [Play] button and [Rec] button indicators will light.

Go ahead and perform on the keyboard.

Stop recording

- 7 Press the [Play] or [Rec] button.

Recording will stop, and the indicators for the [Play] and [Rec] buttons will go dark.

Play back the recorded performance

- 8 Press the [Play] button.

You will hear the recorded performance.

Once again press the [Play] button, and playback will stop.

NOTE

If you layer a newly recorded performance without erasing the recorded song, the song tempo and beat will be stored with the settings that were recorded first.

MEMO

The HP107 includes a "Song Backup function" (p. 45), which allows you to store the song recorded with the HP107 in the instrument itself.

MEMO

About the "USr" display

When you stop recording, the

"USr" display will change to "USr."

The "." in the lower right of the display indicates that there is already a recorded performance.

MEMO

If you record without specifying the recording track, the performance will be recorded to the [Right] button. If you want to record the right and left hands separately on separate recording tracks, refer to "Selecting and Recording the Track for Each Hand Separately" (p. 39).

Chapter 4. Recording Your Performance

Recording Along with a Song

You can record a performance that you play along with an built-in song.

Using the [Left] or [Right] buttons, you can (for example) perform and record just the right-hand part of a song while listening to the left-hand playback of a built-in song.

MEMO

The HP107 includes a "Song Backup function" (p. 45), which allows you to store the song recorded with the HP107 in the instrument itself.

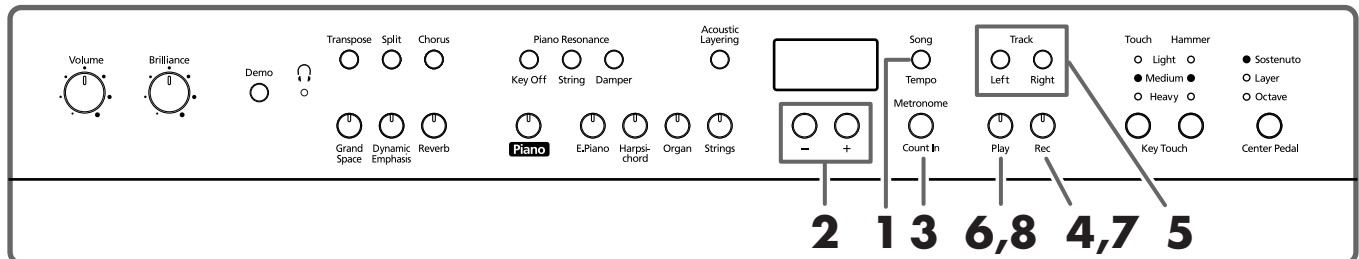

Selecting the song to record

- 1** Press the [Song/Tempo] button, getting its indicator to light in red.

The display will indicate the song number.

- 2** Use the [-] or [+] button to select the song that you want to play.

- 3** As necessary, set the metronome and tempo (p. 32).

- 4** Press the [Rec] button.

The [Rec] button's indicator will light.

Selecting the track to record

- 5** Press the [Left] or [Right] button.

When you want to record the left-hand performance, press the [Left] button; to record that of the right hand, press the [Right] button.

The indicators of the button you pressed and of the [Play] button will blink, and the HP107 enters recording-standby mode.

Starting to record

- 6** Press the [Play] button.

Recording begins after two measures of count sound.
Play along with the song.

Stop recording

- 7** Press the [Play] or [Rec] button.

Recording will stop, and the indicators for the [Play] and [Rec] buttons will go dark.
The recorded performance is stored in "USr (User)."

Play back the recorded performance

- 8** Press the [Play] button.

You will hear the recorded performance.
Once again press the [Play] button, and playback will stop.

MEMO

If "dEL" appears in the display, refer to p. 36.

Selecting and Recording the Track for Each Hand Separately

The recorder of the HP107 has two recording tracks, allowing you to record the right and left hands separately. Use the [Left] button or [Right] button to specify the recording track.

If you want to re-do the recording, you can re-record just a specific track.

MEMO

The HP107 includes a “Song Backup function” (p. 45), which allows you to store the song recorded with the HP107 in the instrument itself.

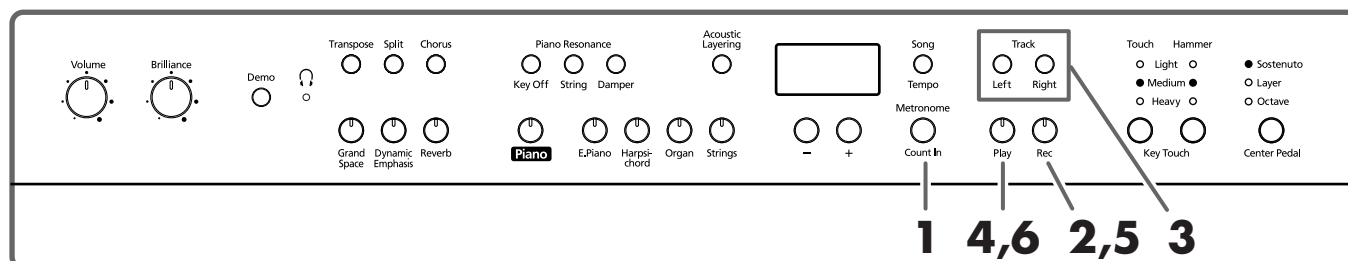

When recording a new song, first follow the instructions in Steps 1 and 2 of “Recording a New Song” (p. 37) to select “USr.” When layering recordings with built-in songs or songs that have been backed up, select the built-in or backed up song as described in Steps **1** and **2** of “Selecting a song and playing it” (p. 15).

1 As necessary, turn on the metronome (p. 32).

2 Press the [Rec] button.

The [Rec] button’s indicator will light, the [Play] button’s indicator will blink, and you will be in recording-standby mode.

The button indicators of tracks that are already recorded will light.

The track button for which you will next be recording will be blinking.

3 Press the [Left] or [Right] button to turn off the button for the track not to be recorded.

Start recording

4 Press the [Play] button.

Two measures of the count sound are played, and the recording begins. Go ahead and perform on the keyboard.

Note that recording will also begin as soon as you play anything on the keyboard, even if you do not press the [Play] button. There is no count sound played when you start in this manner.

Stop recording

5 Press the [Play] or [Rec] button.

Recording will stop, and the indicators for the [Play] and [Rec] buttons will go dark. Your performance has been recorded to the specified track button.

If you want to record on the other track, return to step 2 to record your performance again. You can record while you listen to the previously recorded performance.

Play back the recorded performance

6 Press the [Play] button.

You will hear the recorded performance.

Press the [Play] button once again, and playback will stop.

NOTE

If you go on to record additional material without erasing the recorded song, the song tempo, beat, and metronome settings of the original recording will be used for the new material as well.

MEMO

The track buttons allow you to record to either the [Left] or the [Right] button, one at a time.

Erasing Recorded Performances

You can erase a recorded performance.

■ Erasing a performance from the specified track

You can select a recorded track and erase it.

- 1** Hold down either the [Left] or [Right] button, and press the [Rec] button.

The indicator of the button you pressed will go dark, and the performance of the selected track will be erased.

■ Erasing a song

You can erase a song you've recorded.

- 1** Hold down the [Song/Tempo] button and press the [Rec] button.

The following display will appear, and the [Rec] button's indicator will blink.



If you decide not to erase the performance, press the [Play] or [Song/Tempo] button.

- 2** Once again press the [Rec] button.

The recorded performance is erased.

Chapter 5. Changing Various Settings

Making Detailed Settings (Function)

You can make performance-related settings such as tuning and temperament.

How to enter function mode

1. Hold down the [Split] button, and press the [Chorus] button.

The HP107 switches to the function mode.

The indicators for the [Split] and [Chorus] buttons and the button to which the function is assigned start flashing.

















Setting the various functions

2. Press the button to which the desired function is assigned.

The indicators for pressed button, [Split] button, and [Chorus] button flash.

The name of the function assigned to the button appears in the display for as long as the button is held down.

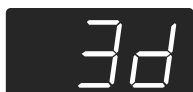
Button	Function	Page
[Piano]	Master Tuning 	p. 42
[E. Piano]	Temperament 	p. 42
[Harpsichord]	Stretch Tuning 	p. 43
[Organ]	Octave Shift 	p. 43
[Strings]	Applying the damper pedal to the left-hand keyboard area 	p. 43

Button	Function	Page
Piano Resonance [Key Off]	Local Control 	p. 49
Piano Resonance [Strings]	MIDI send channel 	p. 49
Piano Resonance [Damper]	USB Driver Setting 	p. 46
[Metronome/Count In]	Memory Backup 	p. 45
[Song/Tempo]	Song Backup 	p. 45
[Right]	V-LINK 	p. 46
[Left]	Transmitting a recorded performance 	p. 49
[Grand Space]	Grand Space Mode 	p. 43
Key Touch [Touch]	Factory Reset 	p. 44

For details on each function, refer to the explanations below.

3. Press the [-] or [+] button to change the value.

Pressing the [-] and [+] buttons simultaneously restores the factory values.

How to exit function mode

4. Press the [Split] or [Chorus] button.

The button's indicator will return to the previous state.

Chapter 5. Changing Various Settings

■ Tuning to other instruments' pitches (Master Tuning)

In situations such as when playing ensemble with other instruments, you can tune the HP107's standard pitch to the pitch of another instrument. The standard pitch generally refers to the pitch of the note that's played when you finger the middle A key. This tuning of all the instruments to a standard pitch is called "tuning."

If you press the **[Piano]** button in step 2 of "Making Detailed Settings (Function)" (p. 41), a display like the following will appear.



The last three digits are indicated in the display. "440.0 Hz" is indicated in the figure above.

Value 415.3 Hz–440.0 Hz–466.2 Hz

Factory setting 440.0 Hz

This setting remains in effect until you turn off the power.

→ You can save this setting in the HP107's memory using the Memory Backup function (p. 45).

■ Changing the temperament

You can play classical styles such as Baroque using historic temperaments (tuning methods).

Today, compositions are generally created with equal temperament in mind and are played using equal temperament. However in past ages of classical music, a variety of temperaments were used. Playing a composition with its original tuning lets you enjoy the sonorities of the chords that the composer originally intended.

If you press the **[E.Piano]** button in step 2 of "Making Detailed Settings (Function)" (p. 41), a display like the following will appear.

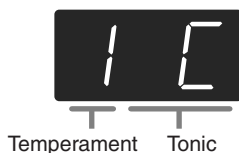

You can choose from among the eight temperaments described below.

Display	Temperament	Qualities
1	Equal	In this tuning, each octave is divided into twelve equal steps. Every interval produces about the same amount of slight dissonance.

Display	Temperament	Qualities
2	Just Major	This tuning eliminates ambiguities in the fifths and thirds. It is unsuited to playing melodies and cannot be transposed, but is capable of beautiful sonorities.
3	Just Minor	The Just tunings differ from major and minor keys. You can get the same effect with the minor scale as with the major scale.
4	Arabic	This tuning is suitable for the music of Arabia.
5	Kirnberger	This is an improvement of the Mean Tone and Just tunings that provides a high degree of freedom of modulation. Performances are possible in all keys (III).
6	Mean Tone	This scale makes some compromises in just intonation, enabling transposition to other keys.
7	Pythagorean	This tuning, devised by the philosopher Pythagoras, eliminates dissonance in fourths and fifths. Dissonance is produced by third-interval chords, but melodies are euphonious.
8	Werckmeister	This temperament combines the Mean Tone and Pythagorean tunings. Performances are possible in all keys (first technique, III).

Factory setting 1 C

Tonic

When playing with tuning other than equal temperament, you need to specify the tonic note for tuning the song to be performed (that is, the note that corresponds to C for a major key or to A for a minor key).

While hold down the **[E. Piano]** button, and press a note to specify the desired tonic key.

The tonic note you specify will be displayed as follows.

Display	C	C ⁻	d	E ₋	E	F	F ⁻	G	A ₋	A	b ₋	b
Letter name	C	C [#]	D	E ^b	E	F	F [#]	G	A ^b	A	B ^b	B

If you choose an equal temperament, there's no need to select a tonic note.

* If you record with a temperament other than equal temperament selected, and then want to play back that performance, use this setting to select the same temperament for playback as the temperament you used when recording.

* When performing in ensemble with other instruments, be aware that depending on the key, there may be some shifting of the pitch. Tune the HP107 to the fundamental pitch of the other instruments.

→ You can save this setting in the HP107's memory using the Memory Backup function (p. 45).

■ Setting the tuning curve (Stretch Tuning)

A piano is generally tuned to a pitch with a lower bass range and a higher treble range than equal temperament. This special tuning method for pianos is called “Stretch Tuning.”

If you press the **[Harpichord]** button in step 2 of “Making Detailed Settings (Function)” (p. 41), a display like the following will appear.



Indication	Description
OFF	This is the standard tuning curve. This is the right choice when using Dual performance (p. 29), or when playing in ensemble with other instruments.
On	This tuning curve expands the bass and treble ends somewhat. It is suitable for performances such as piano solos.

Factory setting On

- This effect works only with the piano tones.
- You can save this setting in the HP107's memory using the Memory Backup function (p. 45).

■ Changing the Pitch by Octaves (Octave Shift)

You can change the pitch of the left tone in Split Play (p. 30), the right tone in Dual Play (p. 29), and the Layer tone in Acoustic Layering Play (p. 28) in octave increments. This function is called “Octave Shift.”

If you press the **[Organ]** button in step 2 of “Making Detailed Settings (Function)” (p. 41), a display like the following will appear.



You can alter the pitch in a range from two octaves below (-2) to two octaves above (+2) the original pitch.

- * Certain Octave Shift settings may result in tones that exceed the recommended range, are difficult to hear well, or that have unnatural tonal qualities or pitches.

■ Applying the damper pedal to the left-hand keyboard area

When you are using Split performance (p. 30), you can apply the damper pedal effect to the sound played by the left-hand keyboard range.

If you press the **[String]** button in step 2 of “Making Detailed Settings (Function)” (p. 41), a display like the following will appear.



Indication	Description
On	The damper pedal effect will be applied to the sound of the left and right hand keyboard area.
OFF	The damper pedal effect will not be applied to the sound of the left-hand keyboard area.

Factory setting OFF

- You can save this setting in the HP107's memory using the Memory Backup function (p. 45).

■ Changing How Grand Space is Applied (Grand Space Mode)

If you press the **[Grand Space]** button in step 2 of “Making Detailed Settings (Function)” (p. 41), a display like the following will appear.



Indication	Description
1	When the headphones are connected, the depth effect is optimized for headphones, and when no headphones are connected, the optimal depth for speakers is applied.
2	The optimal depth for speakers is used, regardless of whether or not headphones are connected. Grand Space is also applied to the sound output from the Output connectors, making this convenient when you want to play through speakers connected to the Output connectors.
3	The optimal depth for headphones is used, regardless of whether or not headphones are connected.

- You can save this setting in the HP107's memory using the Memory Backup function (p. 45).

Chapter 5. Changing Various Settings

Disabling Everything Except Piano Play (Panel Lock)

The "Panel Lock" function locks the HP107 in a state where only piano performance can be used, and all buttons will be disabled. This prevents the settings from being inadvertently modified even if children press the buttons accidentally.

In the Panel Lock state, only the grand piano sound can be played.

1. Turn the volume to the minimum, and press the [Power On] switch to turn off the power.
2. Hold down the [Piano] button, and press the [Power On] switch to turn on the power.

Then, continue to hold down these two buttons for a few seconds.

The following display will appear.



All buttons are disabled.

Adjust the volume.

When you play the keyboard, the grand piano sound will be heard.

To defeat the Panel Lock function, turn the volume down to the minimum, and turn on the power once again.

Restoring the Settings to the Factory Condition (Factory Reset)

The settings stored in the HP107 can be returned to their factory settings.

→ Songs secured with the Song Backup procedure (p. 45) are not deleted when Factory Reset is executed.

1. Hold down the [Split] button, and press the [Chorus] button.

The HP107 switches to the set mode.

2. Press the Key Touch [Touch] button.

The following appears in the display.



3. Press the [Rec] button.

Factory Reset is executed.

When Factory Reset is finished, the following appears in the display. Turn off the power at this time.



* Do not turn off the power until "End" is displayed in the screen. Turning off the power before this is displayed may damage the HP107's internal memory, rendering the instrument unusable.

Remembering the Settings Even When the Power is Turned Off (Memory Backup)

Normally, the various settings revert to their default values when the power is turned off. However, you can specify that the settings will be remembered even when the power is turned off. This function is called "Memory Backup."

→ For more on the settings stored using Memory Backup, refer to "Parameters Stored in Memory Backup" (p. 56).

1. Hold down the [Split] button, and press the [Chorus] button.

The HP107 switches to the set mode.

2. Press the [Metronome/Count In] button.

The button's indicator flashes.

The following appears in the display.



3. Press the [Rec] button.

Memory backup is executed.

When Memory Backup is finished, the display and buttons return to their normal appearance.

Saving Recorded Songs Even with the Power Turned Off (Song Backup)

Normally, any songs you have recorded are deleted when you turn off the power to the HP107. However, if you wish, you can have such recorded songs be saved even while the power is turned off. This function is called "Song Backup."

* You cannot use the Song Backup function unless you have recorded song.

1. Hold down the [Split] button, and press the [Chorus] button.

The HP107 switches to the set mode.

2. Press the [Song/Tempo] button.

The button's indicator flashes.

The following appears in the display.



3. Press the [Rec] button.

Song backup is executed.

When Song Backup is finished, the display and buttons return to their normal appearance.



You can select and play songs that have been backed up in the same way as you do with the built-in songs (p. 15). Songs that have been backed up are indicated in the display as shown below.



Deleting backed up songs

You can delete backed up songs only when you have no songs recorded.

1. Hold down the [Split] button, and press the [Chorus] button.

2. Press the [Song/Tempo] button.

The following appears in the display.



To cancel the procedure, press the [Play] button.

3. Press the [Rec] button.

The backed up song is deleted.

The display and buttons return to their normal appearance.

Chapter 5. Changing Various Settings

Using the V-LINK function

Connecting the HP107 to a V-LINK compatible image device allows you to control the images with the HP107.

V-LINK

V-LINK (**V-LINK**) is functionality promoted by Roland that allows linked performance of music and visual material. By using V-LINK-compatible video equipment, visual effects can be easily linked to, and made part of the expressive elements of a performance.

How to Use the V-LINK

1. Hold down the [Split] button, and press the [Chorus] button.

The HP107 switches to the set mode.

2. Press the [Right] button.

The button's indicator flashes.

The following appears in the display.



Indication	Description
OFF	The V-LINK function is switched off.
On	The V-LINK function is switched on.

Factory setting OFF

3. Press the [-] and [+] buttons to switch the V-LINK function on and off.

You can control images using the twelve keys at the left end of the keyboard.

The following appears in the display, while V-LINK is switched on.



* While V-LINK is switched on, no sound is produced when you press any of the twelve keys at the left end of the keyboard.

How to exit function mode

4. Press the [Split] or [Chorus] button.

The button's indicator returns to its original state.

■ Making the Settings for the USB Driver

If you intend to connect to a computer using the USB connector, you need to make the following setting before you make the connection.

1. Hold down the [Split] button, and press the [Chorus] button.

The HP107 switches to the function mode.

2. Press the Piano Resonance [Damper] button.

The button's indicator flashes.

The following appears in the display.



3. Press the [-] and [+] buttons to set the driver.

Indication	Description
vdr (Vendor)	Select this when using the supplied driver with a USB connection.
GEn (Generic)	Select this when using a generic USB driver included with the OS with a USB connection.

How to exit function mode

4. Press the [Split] or [Chorus] button.

The button's indicator returns to its original state.

Chapter 6. Connecting External Devices

Connecting to Audio Equipment

You can connect audio devices to play the sound of the HP107 through the speakers of your audio system, or to record your performance on a tape recorder or other recording device.

When connecting, please use an audio cable with a standard phone plug (sold separately).

Connection examples

- * To prevent malfunction and/or damage to speakers or other devices, always turn down the volume, and turn off the power on all devices before making any connections.

Playing the sound of the HP107 through the speakers of an audio system/Recording the performance of the HP107 on a recording device

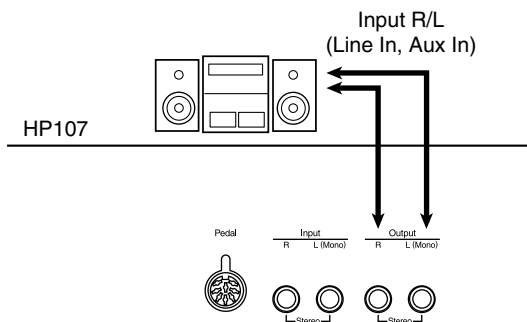

○ Use the following procedure when turning on the power.

1. Turn on the power of the HP107.
2. Turn on the power of the connected device.
3. Adjust the volume of each device.
→ You can adjust the volume of a connected sound module with the HP107.

When Recording HP107 Performances on a Recording Device

4. Start recording with the connected device.
5. Perform on the HP107.
6. When the performance ends, stop recording on the connected equipment.

Playing the sound of an audio device through the speakers of the HP107

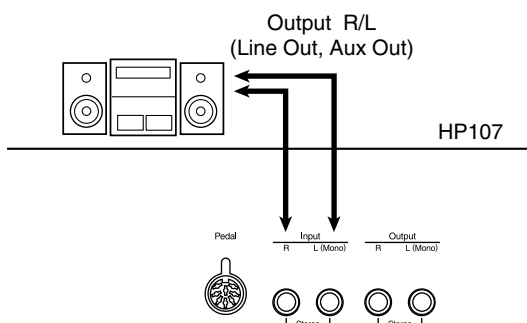

○ Use the following procedure when turning on the power.

1. Turn on the power of the connected device.
2. Turn on the power of the HP107.
3. Adjust the volume of each device.
* You cannot use the HP107 to adjust the volume of the connected sound generating device.

Turning off the power

1. Set the volume of the HP107 and of the connected devices to the minimum position.
2. Turn off the power to the HP107.
3. Turn off the connected equipment.

Connecting to the USB Connector

You can use a USB connector to connect the HP107 to your computer. For more details, refer to the separate "USB Installation Guide."

- * Connecting your computer to the HP107 for the first time requires installation of the "USB Driver" (on the included CD-ROM) to the computer. For more details, refer to the separate "USB Installation Guide."
- * Only MIDI data can be transmitted using USB.
- * To prevent malfunction and/or damage to speakers or other devices, always turn down the volume, and turn off the power on all devices before making any connections.
- * USB cables are not included. Consult your Roland dealer if you need to purchase.
- * Use a USB cable no longer than 3 meters.
- * Turn on the power to the HP107 before starting up MIDI applications on the computer. Do not turn the HP107 on or off while any MIDI application is running.
- * Do not connect or disconnect the USB cable while the HP107's power is on.
- * If not using USB, disconnect the USB cable from the HP107.
- * If during the transmission/reception of data, the computer switches to energy-saving mode or suspended mode, or if the HP107's power is switched on or off, the computer may freeze, or the HP107's operation may become unstable.

Chapter 6. Connecting External Devices

Connecting MIDI Devices

By connecting an external MIDI device and exchanging performance data, you can control the performances on one device from the other. For instance, you can output sound from the other instrument or switch tones on the other instrument.

■ What's MIDI?

MIDI stands for Musical Instrument Digital Interface, an international standard which allows performance information to be communicated among electronic musical instruments and computers.

The HP107 provides MIDI connectors, which allow performance data to be exchanged with external devices. When these connectors are used to connect the HP107 to external devices, an even wider range of possibilities becomes available.

* A separate publication titled "MIDI Implementation" is also available. It provides complete details concerning the way MIDI has been implemented on this unit. If you should require this publication (such as when you intend to carry out byte-level programming), please contact the nearest Roland Service Center or authorized Roland distributor.

Connection examples

* To prevent malfunction and/or damage to speakers or other devices, always turn down the volume, and turn off the power on all devices before making any connections.

Playing the HP107 from a MIDI sequencer/ Recording an HP107 performance on a MIDI sequencer

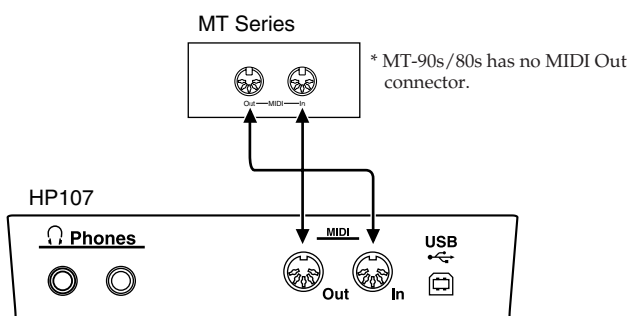

* Set Local Off if you have connected the HP107 to a MIDI sequencer. Refer to "Switching Local Control on and off" (p. 49). Also set your MIDI sequencer to MIDI Thru mode (so that messages received at MIDI IN will be re-transmitted without change from MIDI OUT). For details, refer to the owner's manual of your MIDI sequencer.

Perform on the HP107 to play a MIDI sound generator

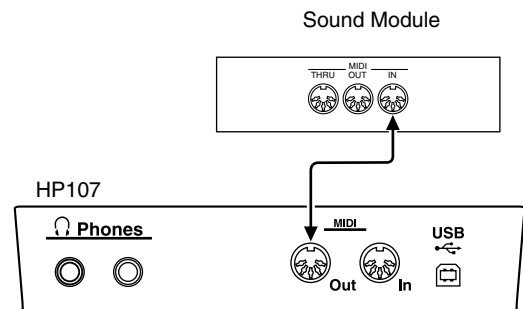

Making MIDI-related Settings

Here's how you can set the transmit channel and other MIDI-related settings.

How to enter function mode

1. Hold down the [Split] button, and press the [Chorus] button.

The HP107 switches to the set mode.

The indicators for the [Split] and [Chorus] buttons and the button to which the function is assigned start flashing.

Setting various functions

2. Press the button to which the desired function is assigned.

The indicators for pressed button, [Split] button, and [Chorus] button flash.

For details on the contents of each function, refer to the explanations that follow.

3. Press the [-] or [+] button to change the value.

If you press the [-] and [+] buttons simultaneously, the setting will return to the original value.

How to exit function mode

4. Press the [Split] or [Chorus] button.

The button's indicator will return to the previous state.

■ MIDI send channel settings

MIDI features sixteen MIDI channels, numbered 1–16. Simply connecting a cable is not enough for communication to take place. The connected devices must be set to use the same MIDI channels. Otherwise, no sound will be produced, and no sounds can be selected.

- * The HP107 receives all channels 1–16.
- * When using the HP107 in Dual mode (p. 29) or Split mode (p. 30), the left hand of the performance is transmitted on Channel 5 in Dual mode and in on Channel 3 in Split mode. These MIDI Transmit channel settings are fixed and cannot be changed. When connecting an external MIDI device while using Dual or Split modes, use channels other than 3 and 5 for the MIDI device.

If you press the **Piano Resonance [String]** button in step 2 of “Making MIDI-related settings,” a display like the following will appear.



Value	1–16
Factory setting	1

■ Switching Local Control on and off

When connecting a MIDI sequencer, set Local Control to “OFF.”

As illustrated, information describing what has been played on the keyboard is passed to the internal sound generator over two different routes, (1) and (2). As a result, you hear overlapping or intermittent sounds. To prevent this from happening, route (1) must be severed, by setting the unit to what is known as “Local Off.”

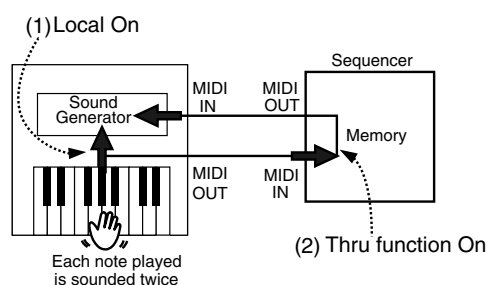

Local Control ON: The keyboard and the internal sound generator are in a linked state.

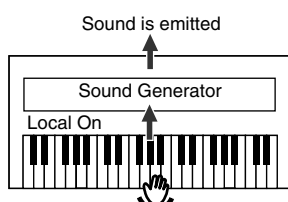

Local Control OFF: The keyboard and the internal sound generator are in an unlinked state. No sound will be produced by the keyboard when it is played.

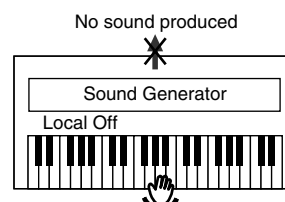

- * When a Roland MT series instrument is connected, it is not necessary to make the Local Off setting. MT units transmit Local Off messages when their power is switched on. If you turn on the power in the order of the HP107 → MT series, Local Off will be set automatically.

If you press the **Piano Resonance [Key Off]** button in step 2 of “Making MIDI-related settings,” a display like the following will appear.



Value	On, OFF
Factory setting	On

■ Transmitting a performance you recorded

If you want to transmit a performance recorded on the HP107 to an external MIDI device or computer, turn this setting “On.” If this is “OFF,” the data will not be transmitted.

If you press the **[Left]** button in step 2 of “Making MIDI-related settings,” a display like the following will appear.



Value	On, OFF
Factory setting	OFF

If you wish to save the performance recorded on the HP107, use the following procedure. In this situation, your external sequencer is set its MIDI Thru feature to be OFF. For details, refer to the owner’s manual of your MIDI sequencer.

- 1 Connect a MIDI sequencer such as the MT series (p. 48).
- 2 Record the performance on the HP107 (p. 36).
- 3 Set this setting to “On.”
- 4 Start recording with the connected MIDI sequencer.
- 5 Start playback of the recorded song on the HP107.
- 6 When playback ends, stop recording with the connected MIDI sequencer.
- 7 Use a connected MIDI sequencer to save the data on a floppy disk or other media.

Troubleshooting

If you think there's a problem, read this first.

Case	Cause/Remedy
The power doesn't come on	Is the power cord connected and plugged in correctly? (p. 12)
The button doesn't work	Is the panel locked? (p. 44) Turn the power off, then back on.
No sound is heard	Is the volume level of the HP107 turned all the way down? (p. 14)
	Are headphones plugged in? (p. 13) Has a plug remained connected to the Phones jack? When headphones are connected, the keyboard's speaker stops playing.
	Is Local Off selected? When Local Control is set to OFF, no sound is produced by playing the keyboard. Set Local Control to "ON" (p. 49).
No sound is heard (when a MIDI instrument is connected)	Is V-LINK switched on? While V-LINK is switched on, no sound is produced when you press any of the twelve keys at the left end of the keyboard.
	Have all devices been switched on?
	Are the MIDI cables connected correctly? Does the MIDI channel match the connected instrument? (p. 49)
Sounds are heard twice (doubled) when the keyboard is played	Is the HP107 in Dual performance? (p. 29)
	When the HP107 is connected to an external sequencer, set it to the Local OFF mode (p. 49). Alternatively, the sequencer could be set so its MIDI Thru feature is OFF.
Tone doesn't change	Is the panel locked? (p. 44) Turn the power off, then back on.
	Are the indicators for the [Split] and [Chorus] buttons flashing? Setting of functions is in progress. Press the [Split] or [Chorus] button to exit function mode (p. 41, p. 48).
Not all played notes are sounded	The maximum number of notes that the HP107 can play simultaneously is 128. Frequent use of the damper pedal when playing along with a song may result in performance data with too many notes, causing some notes to drop out.
The tuning or pitch of the keyboard or song is off	Have you set Transpose? (p. 27)
	Are the settings for the "Temperament" and "Stretch Tuning" correct? (p. 42)
	Is the setting for the "Master Tuning" correct? (p. 42)

Case	Cause/Remedy
Song doesn't play back/ Only the sound of a particular instrument in a song does not play	Are the indicator for the Track buttons ([Left] and [Right] buttons) extinguished? (p. 35) If the button indicator is out, the music on that track is not heard. Press the track button so the indicator is illuminated.
Can't record	Has the track buttons for recording been selected? (p. 36–p. 39)
Tempo of recorded song or metronome is off	If you select an built-in song in which the tempo changes during the song, and then record, the tempo will change in the same way for the performances. The tempo of the metronome will also change in the same way.
	If you record additional material without erasing the previously recorded song, the song will be recorded at the first-recorded tempo. Please erase the previously recorded song before you re-record (p. 40).
The recorded performance has disappeared	Recorded performance that have not been backed up with Song Backup is erased with the power is turned off. A performance cannot be restored once it's been deleted. The HP107 includes a "Song Backup function" (p. 45), which allows you to store song recorded with the HP107 in the instrument itself. Use the Song Backup function to save any performance you do not want deleted to the HP107.
Depressing a pedal has no effect, or the pedal effect doesn't stop	Is the pedal connected correctly? Make sure the pedal cable extending from the stand is securely connected to the pedal jack on the rear of the unit (p. 12).
The pedal rattles	Adjust the adjuster underneath the pedal so that the adjuster presses firmly against the floor surface (p. 14).
Reverberation still audible even with Reverb turned off	Since the H107's piano sounds accurately reproduce the depth and reverberation of the original acoustic piano, you may find that reverberation is audible when the Key Off function and Grand Space are enabled. If you want to eliminate the reverberation, turn off the Key Off function (p. 19) and Grand Space (p. 23–24).
In the upper range, the sound changes abruptly beyond a certain key	On an acoustic piano, notes in the upper one and a half octaves of the keyboard continue to sound until they decay naturally, regardless of the damper pedal. There is a difference in the timbre as well. Roland pianos faithfully simulate such characteristics of the acoustic piano. On the HP107, the range that is unaffected by the damper pedal will change depending on the Key Transpose setting.

Case	Cause/Remedy
A High-pitched whine is produced	<p>When listening through headphones: Some of the more flamboyant and effervescent piano tones feature an ample high-end component, which may make the sound appear to have metallic reverberation added. Since this reverberation becomes particularly audible when supplemented by heavy reverb, you may be able to diminish the problem by reducing the amount of reverb applied to the sound.</p> <p>When listening through speakers: Here, a different cause (such as resonance produced by the HP107) would be suspect. Consult your Roland dealer or nearest Roland Service Center.</p>

Case	Cause/Remedy
The bass range sounds odd, or there is a vibrating resonance	<p>When listening through speakers: Playing at loud volumes may cause instruments near the HP107 to resonate. Resonation can also occur with fluorescent light tubes, glass doors, and other objects. In particular, this problem occurs more easily when the bass component is increased, and when the sound is played at higher volumes. Use the following measures to suppress such resonance.</p> <ul style="list-style-type: none"> • Place speakers so they are 10–15 cm from walls and other surfaces. • Reduce the volume. • Move the speakers away from any resonating objects. <p>When listening through headphones: Here, a different cause would be suspect. Consult your Roland dealer or nearest Roland Service Center.</p>
The volume level of the instrument connected to Input jacks is too low	<p>Could you be using a connection cable that contains a resistor? Use a connection cable that does not contain a resistor.</p>

Error Messages/Other Messages

Display	Meaning
USr	User Song. Stores recorded performances (p. 37).
U.sr.	The “.r.” in the display indicates that there is performance material already recorded (p. 37).
S.1–68	Built-in song number (p. 15).
S. U	This is a song backed up with the Song Backup function (p. 45).
PU	This appears when a song with a pickup (a song that does not start on the first beat) is played back.
dEL	This appears when you attempt to delete a recorded song (p. 36, p. 40, p. 45).
E.32	The amount of performance information is too large, and further recording is not possible.
E.41	A problem such as a loose MIDI cable occurred. Make sure the MIDI cables are correctly hooked up.
—V—	V-LINK function is On (p. 46).

* Error messages are indicated by an “E.” before the number. Press any button, and you can cancel the error message.

Tone List

Piano

1	Grand Piano 1	*1	*2
2	Mellow Piano 1	*1	*2
3	Honky-tonk		*2
4	Mellow Piano 2	*1	*2
5	Grand Piano 2	*1	*2
6	Detuned Piano		*2
7	Rock Piano	*1	*2

E.Piano

1	Electric Piano 1
2	Electric Piano 2
3	Vibraphone
4	Morning Lite
5	Celesta
6	Electric Grand

Harpsichord

1	Harpsichord 1	*1
2	Nylon Guitar	
3	Harp	
4	Coupled Harpsichord	*1
5	Harpsichord 2	

Organ

1	Church Organ 1
2	Rotary Organ
3	Theater Organ
4	Accordion
5	Church Organ 2
6	Nason Flute 8'
7	Lower Organ

Strings

1	Strings 1
2	Jazz Scat
3	Orchestra
4	Choir
5	Strings 2
6	Voice Oohs
7	Glittery Pad
8	Acoustic Bass
9	Acoustic Bass + Cymbal
10	Fingered Bass
11	Vox Bass

Acoustic Layering Tones

1	Strings
2	Choir
3	Pad
4	Bell Pad

***1 Tones that can be used with the Key Off Resonance function**

***2 Tones that can be used with the String Resonance and Damper Resonance functions**

Built-in Song List

Song No.	Song Name	Composer	Copyright
S. 1	Scherzo No.2 (Except)	F. Chopin	© 2004 Roland Corporation
S. 2	La Fille aux Cheveux de Lin	C. Debussy	© 2004 Roland Corporation
S. 3	La Campanella	F. Liszt	© 2004 Roland Corporation
S. 4	Late Night Chopin	F. Chopin/ Arranged by John Maul	© 2002 Roland Corporation
S. 5	Fly Free	John Maul	© 1998 Roland Corporation
S. 6	L'éveil del l'amour	Masashi & Kazuko Hirashita	© 2000 Roland Corporation
S. 7	Sonate für Klavier No. 15	W. A. Mozart	© 1996 Roland Corporation
S. 8	Liebesträume III	F. Liszt	© 2001 Roland Corporation
S. 9	Étude, op.10-3	F. Chopin	© 2001 Roland Corporation
S. 10	Je te veux	E. Satie	© 1997 Roland Corporation
S. 11	Valse, op.64-1	F. Chopin	© 2001 Roland Corporation
S. 12	Golliwog's Cake walk	C. Debussy	© 1995 Roland Corporation
S. 13	Fantaisie-Impromptu	F. Chopin	© 2001 Roland Corporation
S. 14	1ère Arabesque	C. Debussy	© 1995 Roland Corporation
S. 15	An der schönen, blauen Donau	J. Strauss (II)	© 1996 Roland Corporation
S. 16	Auf Flügeln des Gesanges	F. Mendelsshon	© 1996 Roland Corporation
S. 17	Mazurka No.5	F. Chopin	© 1995 Roland Corporation
S. 18	1ère Gymnopédie	E. Satie	© 1997 Roland Corporation
S. 19	Étude, op.25-1	F. Chopin	© 1995 Roland Corporation
S. 20	Clair de Lune	C. Debussy	© 1998 Roland Corporation
S. 21	Étude, op.10-5	F. Chopin	© 2001 Roland Corporation
S. 22	Doctor Gradus ad Parnassum	C. Debussy	© 1995 Roland Corporation
S. 23	Grande Valse Brillante	F. Chopin	© 1995 Roland Corporation
S. 24	La prière d'une Vierge	T. Badarzewska	© 1996 Roland Corporation
S. 25	Course en Troïka	P. Tchaikovsky	© 1996 Roland Corporation
S. 26	To The Spring	E. Grieg	© 1996 Roland Corporation
S. 27	Valse, op.64-2	F. Chopin	© 1996 Roland Corporation
S. 28	Radetzky Marsch	J. Strauss (I)	© 1996 Roland Corporation
S. 29	Träumerei	R. Schumann	© 1996 Roland Corporation
S. 30	Moments Musicaux III	F. Schubert	© 1996 Roland Corporation
S. 31	Prélude, op.28-15	F. Chopin	© 1996 Roland Corporation
S. 32	The harmonious blacksmith	G. Handel	© 1996 Roland Corporation
S. 33	Ungarische Tänze V	J. Brähms	© 1996 Roland Corporation
S. 34	Türkischer Marsch (Beethoven)	L. v. Beethoven	© 1996 Roland Corporation
S. 35	Nocturne No.2	F. Chopin	© 1996 Roland Corporation
S. 36	Frühlingslied	F. Mendelsshon	© 1996 Roland Corporation
S. 37	Präludium	J. S. Bach	© 1996 Roland Corporation
S. 38	Jägerlied	F. Mendelsshon	© 1996 Roland Corporation
S. 39	Menuet Antique	M. Ravel	© 1996 Roland Corporation
S. 40	Für Elise	L. v. Beethoven	© 1996 Roland Corporation
S. 41	Türkischer Marsch (Mozart)	W. A. Mozart	© 1996 Roland Corporation
S. 42	Ständchen	F. Schubert	© 1996 Roland Corporation
S. 43	Humoreske	A. Dvořák	© 1996 Roland Corporation

Appendices

Song No.	Song Name	Composer	Copyright
S. 44	Blumenlied	G. Lange	© 1996 Roland Corporation
S. 45	Alpenglöckchen	T. Oesten	© 1996 Roland Corporation
S. 46	Menuett G dur (Beethoven)	L. v. Beethoven	© 1996 Roland Corporation
S. 47	Venezianisches Gondellied	F. Mendelsshon	© 1996 Roland Corporation
S. 48	Alpenabendröte	T. Oesten	© 1996 Roland Corporation
S. 49	Farewell to the Piano	L. v. Beethoven	© 1996 Roland Corporation
S. 50	Brautchor	R. Wagner	© 1996 Roland Corporation
S. 51	Battle of Waterloo	W. Anderson	© 1996 Roland Corporation
S. 52	Wiener Marsch	C. Czerny	© 1996 Roland Corporation
S. 53	Le Coucou	L. C. Daquin	© 1996 Roland Corporation
S. 54	Menuett G dur (Bach)	J. S. Bach	© 1992 Roland Corporation
S. 55	Spinnerlied	A. Ellmenreich	© 1996 Roland Corporation
S. 56	Gavotte	F. Gossec	© 1996 Roland Corporation
S. 57	Heidenröslein	G. Lange	© 1996 Roland Corporation
S. 58	Zigeuner Tanz	H. Lichner	© 1996 Roland Corporation
S. 59	La Cinquantaine	G. Marie	© 1996 Roland Corporation
S. 60	Csikos Post	H. Necke	© 1996 Roland Corporation
S. 61	Dolly's Dreaming Awakening	T. Oesten	© 1996 Roland Corporation
S. 62	La Violette	L. Streabbog	© 1996 Roland Corporation
S. 63	Fröhlicher Landmann	R. Schumann	© 1996 Roland Corporation
S. 64	Sonatine op.36-1 (Clementi)	M. Clementi	© 1996 Roland Corporation
S. 65	Sonatine op.20-1 (Kuhlau)	F. Kuhlau	© 1996 Roland Corporation
S. 66	Sonatine No.5 (Beethoven)	L. v. Beethoven	© 1996 Roland Corporation
S. 67	Hungarian Rag: Hungarian Dance No. 5 Ragtime Arrangement For Solo Piano	J. Brahms/ Arranged by John Maul	© 1996 Roland Corporation
S. 68	Paganini Boogie: Jazz Variation Based on "Caprice No. 24 in A Minor"	N. Paganini/ Arranged by John Maul	© 1998 Roland Corporation

* All rights reserved. Unauthorized use of this material for purposes other than private, personal enjoyment is a violation of applicable laws.

Profile

John Maul

John Maul is a musician, composer and arranger having graduated from the Royal Academy of Music in London. John's work encompasses studio recordings and live performances including work with top UK Jazz artists.

His writing credits include commercial music for BBC radio and television, as well as scoring jazz and classical works.

Having been a product specialist for Roland U.K., John is now actively involved in music software composing/programming for both Roland Japan and various music publishers. Quite recently his "Musical Picture Book," a volume of original piano music encompassing all standards of musical ability, which included the piano and orchestral accompaniment data in SMF format, was published and printed.

Easy Operation List

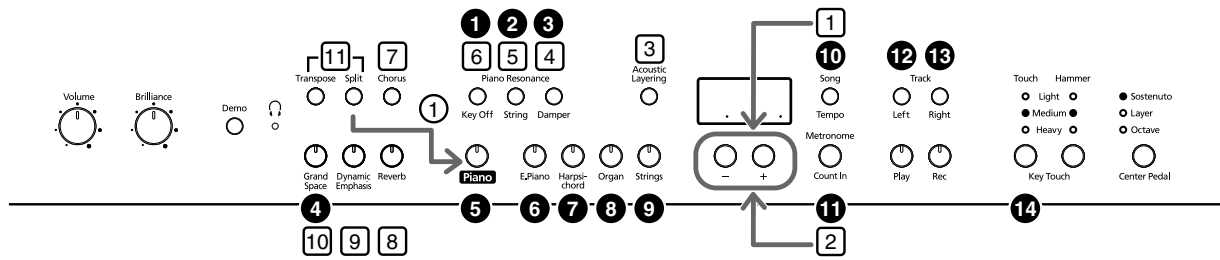

No.	You want to	Buttons	Page
Hold down the [Split] button and press the [Piano] button.			
①	Twin Piano	[Split] + [Piano]	p. 33
Press the [Split] and [Chorus] buttons simultaneously, and press the [●] button.			
①	Local Control	[Split] + [Chorus] → Piano Resonance [Key Off]	p. 49
②	MIDI send channel settings	[Split] + [Chorus] → Piano Resonance [String]	p. 49
③	USB Driver Setting	[Split] + [Chorus] → Piano Resonance [Damper]	p. 46
④	Grand Space Mode	[Split] + [Chorus] → [Grand Space]	p. 43
⑤	Master Tuning	[Split] + [Chorus] → [Piano]	p. 42
⑥	Selecting a temperament Specifying the keynote	[Split] + [Chorus] → [E. Piano] → [E. Piano] + key	p. 42
⑦	Stretch tuning	[Split] + [Chorus] → [Harpsichord]	p. 43
⑧	Octave Shift	[Split] + [Chorus] → [Organ]	p. 43
⑨	Applying the damper pedal to the left-hand keyboard area	[Split] + [Chorus] → [Strings]	p. 43
⑩	Song Backup	[Split] + [Chorus] → [Song/Tempo]	p. 45
⑪	Memory Backup	[Split] + [Chorus] → [Metronome/Count In]	p. 45
⑫	Transmitting a recorded performance	[Split] + [Chorus] → [Left]	p. 49
⑬	V-LINK	[Split] + [Chorus] → [Right]	p. 46
⑭	Factory Reset	[Split] + [Chorus] → Key Touch [Touch]	p. 44
Hold down the [□] button and press the [-] or [+] button.			
①	Beat of metronome	[Song/Tempo] + [-] [+]	p. 32
②	Metronome volume	[Metronome/Count In] + [-] [+]	p. 33
③	Layer Balance (Dual Balance)	[Acoustic Layering] + [-] [+]	p. 28
④	Damper pedal's resonance level	Piano Resonance [Damper] + [-] [+]	p. 20
⑤	String's resonance level	Piano Resonance [String] + [-] [+]	p. 19
⑥	Key Off volume	Piano Resonance [Key Off] + [-] [+]	p. 19
⑦	Depth of the Chorus effect	[Chorus] + [-] [+]	p. 26
⑧	Depth of the Reverb effect	[Reverb] + [-] [+]	p. 26
⑨	Dynamic Emphasis setting	[Dynamic Emphasis] + [-] [+]	p. 25
⑩	Grand Space setting	[Grand Space] + [-] [+]	p. 23, p. 24
Press the [□] button, and press the [-] or [+] button.			
⑪	Dual Balance (Layer Balance)	[Transpose] + [Split] → [-] [+]	p. 29
Hold down the [Split] or [Transpose] button and press the key.			
	Split Point	[Split] + key	p. 31
	Key Transpose	[Transpose] + key	p. 27

Parameters Stored in Memory Backup

Piano Tone-Related Settings in Effect When the Power is Turn On	Key Off Resonance (On/Off, Volume)	p. 19
	String Resonance (On/Off, Depth)	p. 19
	Damper Resonance (On/Off, Depth)	p. 20
	Key Touch	p. 21
	Hammer Response	p. 22
	Temperament (Temperament, Tonic)	p. 42
	Stretch Tuning	p. 43
	Grand Space (On/Off, Depth)	p. 23, p. 24
	Dynamic Emphasis (On/Off, Depth)	p. 25
	Master Tuning	p. 42
	Reverb (On/Off, Depth)	p. 26
	Other Settings	USB Driver Setting
Applying the damper pedal to the left-hand keyboard area		p. 43
Grand Space Mode		p. 43
Split Point		p. 31
Dual Balance, Layer Balance		p. 28, p. 29

DIGITAL PIANO
Model HP107

MIDI Implementation Chart

Date : Mar. 1, 2004
Version : 1.00

Function...	Transmitted	Recognized	Remarks
Basic Channel Default Changed	1 1-16	1-16 1-16	
Mode Default Messages Altered	Mode 3 x *****	Mode 3 x	
Note Number : True Voice	0-127 *****	0-127 0-127	
Velocity Note ON Note OFF	O O	O O	
After Touch Key's Ch's	x x	x x	
Pitch Bend	x	O	
Control Change	0, 32 1 5 6, 38 7 10 11 64 65 66 67 84 91 93 100, 101	O x x O O O O O O O O O O O O O O O O O	Bank Select Modulation Portamento time Data entry Volume Panpot Expression Hold 1 Portamento Sostenuto Soft Portamento control Effect 1 (Reverb) Effect 3 (Chorus) RPN LSB, MSB
Prog Change : True Number	0...100 *****	O (0-127) 0...100	
System Exclusive	O	O	
System Common : Song Pos : Song Sel : Tune	x x x	x x x	
System Real Time : Clock : Commands	x x	x x	
Aux Message : All sound off : Reset all controllers : Local Control : All Notes OFF : Active Sense : Reset	x x x x O x	O O O O O O O (123-127) x	
Notes			

Mode 1 : OMNI ON, POLY Mode 2 : OMNI ON, MONO O : Yes
Mode 3 : OMNI OFF, POLY Mode 4 : OMNI OFF, MONO X : No

Main Specifications

Keyboard	
Keyboard	88 keys (Progressive Hammer Action Keyboard with Escapement)
Touch Sensitivity	Touch: Light, Medium, Heavy, Fixed
	Hammer: Light, Medium, Heavy, Off
Keyboard Mode	Whole, Layer/Dual (volume balance adjustable), Split (split point adjustable)
Sound Generator	
Max. Polyphony	128 voices
Tones	5 groups 36 variations+ 4 tones for Layer
Temperament	8 types, selectable tonic
Stretched Tuning	2 types
Master Tuning	415.3 Hz–466.2 Hz (0.1 Hz Step)
Transpose	-6–+5 (in semitones)
Effects	Grand Space, Dynamic Emphasis, Piano Resonance (Key Off Resonance, String Resonance, Damper Resonance), Reverb (10 levels), Chorus (10 levels)
Metronome	
Beat	2/2, 0/4, 2/4, 3/4, 4/4, 5/4, 6/4, 7/4, 3/8, 6/8, 9/8, 12/8
Volume	10 levels
Recorder	
Tracks	2 tracks
Song	1 song (Rememberable)
Note Storage	Approx. 10,000 notes
Tempo	Quarter note = 10–500
Resolution	120 ticks per quarter note
Control	Play/Stop, Rec, Tempo, All Song Play, Track Select
Built-in Songs	68 songs + 14 Tone Demo songs
Others	
Rated Power Output	50 W x 2
Speakers	20 cm x 2 (Speaker Box), 10cm x 2
Display	Beat LED
	7 segments, 3 characters (LED) Headphones indicator
Control	Volume, Brilliance
Pedals	Damper (half-pedal recognition), Soft (half-pedal recognition), Sostenuto (function assignable)
Other Functions	Panel Lock, Song backup, Memory backup, Factory Reset
Connectors	USB connector (MIDI), Output jacks (L/Mono, R), Input jacks (L/Mono, R), Headphone jack x 2 (Stereo), MIDI connectors (In, Out)
Power supply	AC 117 V / AC 230 V / AC 240 V
Power Consumption	110 W
Dimensions (including piano stand)	1,421 (W) x 526 (D) x 894 (H) mm / 56 (W) x 20-3/4 (D) x 35-1/4 (H) inches
	1,421 (W) x 526 (D) x 1,098 (H) mm / 56 (W) x 20-3/4 (D) x 43-1/4 (H) inches (including music rest)
Weights (including Piano Stand)	79 kg / 175 lbs
Accessories	Owner's manual, Roland 60 Classical Piano Masterpieces, USB Installation Guide, CD-ROM (Roland Digital Piano USB Driver), Power Cord, Headphone Hook

* In the interest of product improvement, the specifications and/or appearance of this unit are subject to change without prior notice.

Index

A	
AC inlet	12
Acoustic Layering	28
Adjuster	14
All Song Play	15
Audio Equipment	47
B	
Beat	32
[Brilliance] knob	14
Built-in Song	15
C	
Chorus	26
Depth	26
Count-In	34
D	
Damper pedal	14, 43
Damper Resonance	14, 20
Demo	
Demo of the Functions	17
Tone Demo	16
Dual Balance	29
Dual Performance	29
Dynamic Emphasis	25
E	
Effects	26
Amount of effect applied	26
Erase	40
F	
Factory Reset	44
Function	41
MIDI-related Settings	48
G	
Grand Space	23–24
H	
Hammer Response	22
Headphone Hook	13
Headphones	13
K	
Key Off	19
Key Touch	21
L	
Layer	31
Layer Balance	28
Lid	13
Local Control	49
M	
Master Tuning	42
Memory Backup	45
Metronome	32
Volume	33
MIDI	48
MIDI channel	49
MIDI Devices	48
Music Holder	12
O	
Octave	31
Octave Shift	43
P	
Panel Lock	44
Pedal	14
Pedal Cable	12
Pedal connector	12
Phones jack	13
Piano Resonance	19
Play	
All Songs Continuously	15
Along with the built-in songs	34
Each Hand	35
Selecting a song	15
Power	14
Power Cord	12
Power indicator	14
[Power On] switch	14
R	
Record	36
Along with a Song	38
Each Hand	39
Erasing Performances	40
New Song	37
Reverb	26
Depth	26
S	
Soft pedal	14
Song Backup	45
Sostenuto Pedal	
Function	31
Sostenuto pedal	14
Speaker Cable	12
Split Performance	30
Split Point	31
Standard pitch	42
Stretch Tuning	43
String Resonance	19
T	
Temperament	42
Tempo	32, 34
Tone	18
Tone button	18
Tone Group	18
Track button	35, 39
Transpose	27
[Transpose] button	27
Tuning Curve	43

Index

U

USB Connector	47
USB Driver	46

V

Variation tone	18
V-LINK	46
Volume	14
Metronome	33
[Volume] knob	14

MEMO

For EU Countries



This product complies with the requirements of European Directives EMC 89/336/EEC and LVD 73/23/EEC.

For the USA

FEDERAL COMMUNICATIONS COMMISSION RADIO FREQUENCY INTERFERENCE STATEMENT

This equipment has been tested and found to comply with the limits for a Class B digital device, pursuant to Part 15 of the FCC Rules. These limits are designed to provide reasonable protection against harmful interference in a residential installation. This equipment generates, uses, and can radiate radio frequency energy and, if not installed and used in accordance with the instructions, may cause harmful interference to radio communications. However, there is no guarantee that interference will not occur in a particular installation. If this equipment does cause harmful interference to radio or television reception, which can be determined by turning the equipment off and on, the user is encouraged to try to correct the interference by one or more of the following measures:

- Reorient or relocate the receiving antenna.
- Increase the separation between the equipment and receiver.
- Connect the equipment into an outlet on a circuit different from that to which the receiver is connected.
- Consult the dealer or an experienced radio/TV technician for help.

This device complies with Part 15 of the FCC Rules. Operation is subject to the following two conditions:

- (1) This device may not cause harmful interference, and
- (2) This device must accept any interference received, including interference that may cause undesired operation.

Unauthorized changes or modification to this system can void the users authority to operate this equipment.
This equipment requires shielded interface cables in order to meet FCC class B Limit.

For Canada

NOTICE

This Class B digital apparatus meets all requirements of the Canadian Interference-Causing Equipment Regulations.

AVIS

Cet appareil numérique de la classe B respecte toutes les exigences du Règlement sur le matériel brouilleur du Canada.

This owner's manual is printed on recycled paper.



Free Manuals Download Website

<http://myh66.com>

<http://usermanuals.us>

<http://www.somanuals.com>

<http://www.4manuals.cc>

<http://www.manual-lib.com>

<http://www.404manual.com>

<http://www.luxmanual.com>

<http://aubethermostatmanual.com>

Golf course search by state

<http://golfingnear.com>

Email search by domain

<http://emailbydomain.com>

Auto manuals search

<http://auto.somanuals.com>

TV manuals search

<http://tv.somanuals.com>