

KR105

DIGITAL
INTELLIGENT PIANO



Owner's Manual

Before using this unit, carefully read the sections entitled: "Important safety instructions" (p. 2), "Using the unit safely" (p. 3), and "Important notes" (p. 5). These sections provide important information concerning the proper operation of the unit. Additionally, in order to feel assured that you have gained a good grasp of every feature provided by your new unit, Owner's Manual should be read in its entirety. The manual should be saved and kept on hand as a convenient reference

Copyright © 2005 ROLAND CORPORATION

All rights reserved. No part of this publication may be reproduced in any form without the written permission of ROLAND CORPORATION.

WARNING: To reduce the risk of fire or electric shock, do not expose this apparatus to rain or moisture.

  
ATTENTION: RISQUE DE CHOC ELECTRIQUE NE PAS OUVRIR
CAUTION: TO REDUCE THE RISK OF ELECTRIC SHOCK, DO NOT REMOVE COVER (OR BACK). NO USER-SERVICEABLE PARTS INSIDE. REFER SERVICING TO QUALIFIED SERVICE PERSONNEL.



The lightning flash with arrowhead symbol, within an equilateral triangle, is intended to alert the user to the presence of uninsulated "dangerous voltage" within the product's enclosure that may be of sufficient magnitude to constitute a risk of electric shock to persons.



The exclamation point within an equilateral triangle is intended to alert the user to the presence of important operating and maintenance (servicing) instructions in the literature accompanying the product.

INSTRUCTIONS PERTAINING TO A RISK OF FIRE, ELECTRIC SHOCK, OR INJURY TO PERSONS.

IMPORTANT SAFETY INSTRUCTIONS SAVE THESE INSTRUCTIONS

WARNING – When using electric products, basic precautions should always be followed, including the following:

1. Read these instructions.
2. Keep these instructions.
3. Heed all warnings.
4. Follow all instructions.
5. Do not use this apparatus near water.
6. Clean only with a dry cloth.
7. Do not block any of the ventilation openings. Install in accordance with the manufacturers instructions.
8. Do not install near any heat sources such as radiators, heat registers, stoves, or other apparatus (including amplifiers) that produce heat.
9. Do not defeat the safety purpose of the polarized or grounding-type plug. A polarized plug has two blades with one wider than the other. A grounding type plug has two blades and a third grounding prong. The wide blade or the third prong are provided for your safety. If the provided plug does not fit into your outlet, consult an electrician for replacement of the obsolete outlet.
10. Protect the power cord from being walked on or pinched particularly at plugs, convenience receptacles, and the point where they exit from the apparatus.
11. Only use attachments/accessories specified by the manufacturer.
12. Use only with the cart, stand, tripod, bracket, or table specified by the manufacturer, or sold with the apparatus. When a cart is used, use caution when moving the cart/apparatus combination to avoid injury from tip-over.
13. Unplug this apparatus during lightning storms or when unused for long periods of time.
14. Refer all servicing to qualified service personnel. Servicing is required when the apparatus has been damaged in any way, such as power-supply cord or plug is damaged, liquid has been spilled or objects have fallen into the apparatus, the apparatus has been exposed to rain or moisture, does not operate normally, or has been dropped.



For the U.K.

IMPORTANT: THE WIRES IN THIS MAINS LEAD ARE COLOURED IN ACCORDANCE WITH THE FOLLOWING CODE.

BLUE: NEUTRAL
BROWN: LIVE

As the colours of the wires in the mains lead of this apparatus may not correspond with the coloured markings identifying the terminals in your plug, proceed as follows:

The wire which is coloured BLUE must be connected to the terminal which is marked with the letter N or coloured BLACK.

The wire which is coloured BROWN must be connected to the terminal which is marked with the letter L or coloured RED.

Under no circumstances must either of the above wires be connected to the earth terminal of a three pin plug.



USING THE UNIT SAFELY

INSTRUCTIONS FOR THE PREVENTION OF FIRE, ELECTRIC SHOCK, OR INJURY TO PERSONS

About ⚠ WARNING and ⚠ CAUTION Notices









⚠ WARNING	Used for instructions intended to alert the user to the risk of death or severe injury should the unit be used improperly.
⚠ CAUTION	Used for instructions intended to alert the user to the risk of injury or material damage should the unit be used improperly. * Material damage refers to damage or other adverse effects caused with respect to the home and all its furnishings, as well to domestic animals or pets.

About the Symbols





	The ⚠ symbol alerts the user to important instructions or warnings. The specific meaning of the symbol is determined by the design contained within the triangle. In the case of the symbol at left, it is used for general cautions, warnings, or alerts to danger.
	The ⚡ symbol alerts the user to items that must never be carried out (are forbidden). The specific thing that must not be done is indicated by the design contained within the circle. In the case of the symbol at left, it means that the unit must never be disassembled.
	The ● symbol alerts the user to things that must be carried out. The specific thing that must be done is indicated by the design contained within the circle. In the case of the symbol at left, it means that the power-cord plug must be unplugged from the outlet.

ALWAYS OBSERVE THE FOLLOWING







⚠ WARNING

- Before using this unit, make sure to read the instructions below, and the Owner's Manual. 
- Do not open or perform any internal modifications on the unit. 
- Do not attempt to repair the unit, or replace parts within it (except when this manual provides specific instructions directing you to do so). Refer all servicing to your retailer, the nearest Roland Service Center, or an authorized Roland distributor, as listed on the "Information" page. 
- Never use or store the unit in places that are:
 - Subject to temperature extremes (e.g., direct sunlight in an enclosed vehicle, near a heating duct, on top of heat-generating equipment); or are 
 - Damp (e.g., baths, washrooms, on wet floors); or are 
 - Humid; or are
 - Exposed to rain; or are
 - Dusty; or are
 - Subject to high levels of vibration.
- Make sure you always have the unit placed so it is level and sure to remain stable. Never place it on stands that could wobble, or on inclined surfaces. 
- The unit should be connected to a power supply only of the type described in the operating instructions, or as marked on the rear of unit. 
- Use only the attached power-supply cord. Also, the supplied power cord must not be used with any other device. 





⚠ WARNING





- Do not excessively twist or bend the power cord, nor place heavy objects on it. Doing so can damage the cord, producing severed elements and short circuits. Damaged cords are fire and shock hazards! 
- This unit, either alone or in combination with an amplifier and headphones or speakers, may be capable of producing sound levels that could cause permanent hearing loss. Do not operate for a long period of time at a high volume level, or at a level that is uncomfortable. If you experience any hearing loss or ringing in the ears, you should immediately stop using the unit, and consult an audiologist. 
- Do not allow any objects (e.g., flammable material, coins, pins); or liquids of any kind (water, soft drinks, etc.) to penetrate the unit. 

- Immediately turn the power off, remove the power cord from the outlet, and request servicing by your retailer, the nearest Roland Service Center, or an authorized Roland distributor, as listed on the "Information" page when:
 - The power-supply cord, or the plug has been damaged; or
 - If smoke or unusual odor occurs
 - Objects have fallen into, or liquid has been spilled onto the unit; or
 - The unit has been exposed to rain (or otherwise has become wet); or
 - The unit does not appear to operate normally or exhibits a marked change in performance.

⚠ WARNING



- In households with small children, an adult should provide supervision until the child is capable of following all the rules essential for the safe operation of the unit. 
- Protect the unit from strong impact. (Do not drop it!) 
- Do not force the unit's power-supply cord to share an outlet with an unreasonable number of other devices. Be especially careful when using extension cords—the total power used by all devices you have connected to the extension cord's outlet must never exceed the power rating (watts/amperes) for the extension cord. Excessive loads can cause the insulation on the cord to heat up and eventually melt through. 
- Before using the unit in a foreign country, consult with your retailer, the nearest Roland Service Center, or an authorized Roland distributor, as listed on the "Information" page. 
- DO NOT play a CD-ROM disc on a conventional audio CD player. The resulting sound may be of a level that could cause permanent hearing loss. Damage to speakers or other system components may result. 
- Do not put anything that contains water (e.g., flower vases) on this unit. Also, avoid the use of insecticides, perfumes, alcohol, nail polish, spray cans, etc., near the unit. Swiftly wipe away any liquid that spills on the unit using a dry, soft cloth. 

⚠ CAUTION

- The unit should be located so that its location or position does not interfere with its proper ventilation. 
- Always grasp only the plug on the power-supply cord when plugging into, or unplugging from, an outlet or this unit. 
- At regular intervals, you should unplug the power plug and clean it by using a dry cloth to wipe all dust and other accumulations away from its prongs. Also, disconnect the power plug from the power outlet whenever the unit is to remain unused for an extended period of time. Any accumulation of dust between the power plug and the power outlet can result in poor insulation and lead to fire. 
- Try to prevent cords and cables from becoming entangled. Also, all cords and cables should be placed so they are out of the reach of children. 

- Never climb on top of, nor place heavy objects on the unit. 
- Never handle the power cord or its plugs with wet hands when plugging into, or unplugging from, an outlet or this unit. 
- If you need to move the instrument, take note of the precautions listed below. At least two persons are required to safely lift and move the unit. It should be handled carefully, all the while keeping it level. Make sure to have a firm grip, to protect yourself from injury and the instrument from damage. 
- Check to make sure the screw securing the unit to the stand have not become loose. Fasten them again securely whenever you notice any loosening.
- Disconnect the power cord.
- Disconnect all cords coming from external devices.
- Raise the adjusters on the stand (p. 17).
- Close the lid.
- Fold down the music rest.
- Before cleaning the unit, turn off the power and unplug the power cord from the outlet (p. 16). 
- Whenever you suspect the possibility of lightning in your area, pull the plug on the power cord out of the outlet. 

⚠ CAUTION

- Be careful when opening/closing the lid so you do not get your fingers pinched (p. 16). Adult supervision is recommended whenever small children use the unit. 
- Always keep the following parts including with the KR105 and small components that may be removed out of the reach of small children to avoid accidental ingestion of these parts. 
Removable parts
 - Screws fastening the stand
 - Screws fastening music rest
 - the thumbscrew fastening the headphone hook

Important notes

In addition to the items listed under “Important safety instructions” (p. 2) and “Using the unit safely” (p. 3), please read and observe the following:

Power Supply

- Do not connect this unit to same electrical outlet that is being used by an electrical appliance that is controlled by an inverter (such as a refrigerator, washing machine, microwave oven, or air conditioner), or that contains a motor. Depending on the way in which the electrical appliance is used, power supply noise may cause this unit to malfunction or may produce audible noise. If it is not practical to use a separate electrical outlet, connect a power supply noise filter between this unit and the electrical outlet.
- Before connecting this unit to other devices, turn off the power to all units. This will help prevent malfunctions and/or damage to speakers or other devices.
- Although the LCD and LEDs are switched off when the POWER switch is switched off, this does not mean that the unit has been completely disconnected from the source of power. If you need to turn off the power completely, first turn off the POWER switch, then unplug the power cord from the power outlet. For this reason, the outlet into which you choose to connect the power cord’s plug should be one that is within easy reach and readily accessible.

Placement

- Using the unit near power amplifiers (or other equipment containing large power transformers) may induce hum. To alleviate the problem, change the orientation of this unit; or move it farther away from the source of interference.
- This device may interfere with radio and television reception. Do not use this device in the vicinity of such receivers.
- Noise may be produced if wireless communications devices, such as cell phones, are operated in the vicinity of this unit. Such noise could occur when receiving or initiating a call, or while conversing. Should you experience such problems, you should relocate such wireless devices so they are at a greater distance from this unit, or switch them off.
- Do not expose the unit to direct sunlight, place it near devices that radiate heat, leave it inside an enclosed vehicle, or otherwise subject it to temperature extremes. Also, do not allow lighting devices that normally are used while their light source is very close to the unit (such as a piano light), or powerful spotlights to shine upon the same area of the unit for extended periods of time. Excessive heat can deform or discolor the unit.
- When moved from one location to another where the temperature and/or humidity is very different, water droplets (condensation) may form inside the unit. Damage or malfunction may result if you attempt to use the unit in this condition. Therefore, before using the unit, you must allow it to stand for several hours, until the condensation has completely evaporated.
- Do not allow rubber, vinyl, or similar materials to remain on the unit for long periods of time. Such objects can discolor or otherwise harmfully affect the finish.
- Do not allow objects to remain on top of the keyboard. This can be the cause of malfunction, such as keys ceasing to produce sound.
- Do not paste stickers, decals, or the like to this instrument. Peeling such matter off the instrument may damage the exterior finish.

Maintenance

- To clean the unit, use a dry, soft cloth; or one that is slightly dampened. Try to wipe the entire surface using an equal amount of strength, moving the cloth along with the grain of the wood. Rubbing too hard in the same area can damage the finish.
- Never use benzine, thinners, alcohol or solvents of any kind, to avoid the possibility of discoloration and/or deformation.
- The pedals of this unit are made of brass. Brass eventually darkens as the result of the natural oxidation process. If the brass becomes tarnished, polish it using commercially available metal polisher.

Repairs and Data

- Please be aware that all data contained in the unit’s memory may be lost when the unit is sent for repairs. Important data should always be backed up on floppy disk, or written down on paper (when possible). During repairs, due care is taken to avoid the loss of data. However, in certain cases (such as when circuitry related to memory itself is out of order), we regret that it may not be possible to restore the data, and Roland assumes no liability concerning such loss of data.

Additional Precautions

- Please be aware that the contents of memory can be irretrievably lost as a result of a malfunction, or the improper operation of the unit. To protect yourself against the risk of losing important data, we recommend that you periodically save a backup copy of important data you have stored in the unit’s memory.
- Unfortunately, it may be impossible to restore the contents of data that was stored once it has been lost. Roland Corporation assumes no liability concerning such loss of data.
- Use a reasonable amount of care when using the unit’s buttons, sliders, or other controls; and when using its jacks and connectors. Rough handling can lead to malfunctions.
- Never strike or apply strong pressure to the display.
- When connecting / disconnecting all cables, grasp the connector itself—never pull on the cable. This way you will avoid causing shorts, or damage to the cable’s internal elements.
- A small amount of heat will radiate from the unit during normal operation.
- To avoid disturbing your neighbors, try to keep the unit’s volume at reasonable levels. You may prefer to use headphones, so you do not need to be concerned about those around you (especially when it is late at night).
- When you need to transport the unit, pack it in shock-absorbent material. Transporting the unit without doing so can cause it to become scratched or damaged, and could lead to malfunction.
- Do not apply undue force to the music rest while it is in use.
- Use only the specified expression pedal (EV-7/5; sold separately). By connecting any other expression pedals, you risk causing malfunction and/or damage to the unit.

- Use a cable from Roland to make the connection. If using some other make of connection cable, please note the following precautions.
 - Some connection cables contain resistors. Do not use cables that incorporate resistors for connecting to this unit. The use of such cables can cause the sound level to be extremely low, or impossible to hear. For information on cable specifications, contact the manufacturer of the cable.
- Before opening or closing the keyboard lid, always make sure that no pets or other small animals are located on top of the instrument (in particular, they should be kept away from the keyboard and its lid). Otherwise, due to the structural design of this instrument, small pets or other animals could end up getting trapped inside it. If such a situation is encountered, you must immediately switch off the power and disconnect the power cord from the outlet. You should then consult with the retailer from whom the instrument was purchased, or contact the nearest Roland Service Center.

Handling Floppy Disks (Using the Floppy Disk Drive)

- Floppy disks contain a plastic disk with a thin coating of magnetic storage medium. Microscopic precision is required to enable storage of large amounts of data on such a small surface area. To preserve their integrity, please observe the following when handling floppy disks:
 - Never touch the magnetic medium inside the disk.
 - Do not use or store floppy disks in dirty or dusty areas.
 - Do not subject floppy disks to temperature extremes (e.g., direct sunlight in an enclosed vehicle). Recommended temperature range: 10 to 50°C (50 to 122°F).
 - Do not expose floppy disks to strong magnetic fields, such as those generated by loudspeakers.
- Floppy disks have a “write protect” tab which can protect the disk from accidental erasure. It is recommended that the tab be kept in the PROTECT position, and moved to the WRITE position only when you wish to write new data onto the disk.

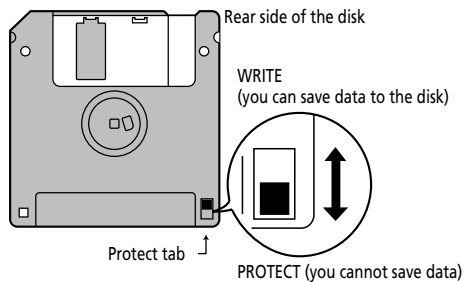

- The identification label should be firmly affixed to the disk. Should the label come loose while the disk is in the drive, it may be difficult to remove the disk.
- Store all disks in a safe place to avoid damaging them, and to protect them from dust, dirt, and other hazards. By using a dirty or dust-ridden disk, you risk damaging the disk, as well as causing the disk drive to malfunction.
- Disks containing performance data for this unit should always be locked (have their write protect tab slid to the “Protect” position) before you insert them into the drive on some other unit (except the PR-300, or a product in the HP-G, HPi, MT, KR, or Atelier families), or into a computer’s drive. Otherwise (if the write protect tab remains in the “Write” position), when you perform any disk operations using the other device’s disk drive (such as checking the contents of the disk, or loading data), you risk rendering the disk unreadable by this unit’s disk drive.

Handling CD-ROMs

- Avoid touching or scratching the shiny underside (encoded surface) of the disc. Damaged or dirty CD-ROM discs may not be read properly. Keep your discs clean using a commercially available CD cleaner.

- * GS (GS) is a registered trademark of Roland Corporation.
- * XG lite (XGlite) is a registered trademark of Yamaha Corporation.
- * Apple and Macintosh are registered trademarks of Apple Computer, Inc.
- * All product names mentioned in this document are trademarks or registered trademarks of their respective owners.

Introduction

Thank you, and congratulations on your choice of the Roland KR105 Intelligent Piano.

Apart from allowing you to achieve authentic piano performances, the KR105 also features easy-to-use automatic accompaniment and numerous other useful functions. In order to enjoy reliable performance of your new instrument for many years to come, please take the time to read through this manual in its entirety.

Main Features

○ **Piano Sounds with Rich Resonance and Wide-Ranging Expressiveness**

The stereo sampling piano sound generator realistically reproduces even the sound of the hammers striking the strings, producing the tones of a high-quality concert grand piano. Maximum polyphony of 64 notes ensures that you can use the pedal freely without running out of notes.

○ **Pursuing the Playing Feel of a Grand Piano**

The KR105 has a progressive hammer action keyboard, which duplicates the touch of a grand piano, with a heavier touch in the lower register, and a lighter touch in the upper register. The pedal is designed for good-feeling response, and allows subtle performance nuances to be expressed. In addition to the ability of adjusting the key weight, a "Hammer Response" function, which reproduces the subtle action of the hammers, is also incorporated, so there are two key-touch controls that come into play when determining the precise character of the keyboard. Additionally, the instrument's pedals are firm and responsive, lending your performances fuller and more detailed expressiveness.

○ **Accomplish Tasks Easily with the Main Buttons**

Almost all of the KR105's common functions, including playing back songs, displaying notations, running the automatic accompaniment, selecting tones, and so on can be accomplished using the Main buttons to the left of the screen.

○ **Easy-To-Use "Music Assistant" Automatic Accompaniment Feature**

You can select from an amazing ± 350 settings to get automatic accompaniment that perfectly matches the song you are playing.

Each song's Music Assistant settings are shown in a manner that is easy to grasp, so playing along with the changes in the accompaniment is a snap.

For easy enjoyment of Music Assistant, the KR105 also includes songs that you can perform while reading the chord charts.

○ **Touch screen**

The KR105 features a touch screen with rich graphics to make viewing easier. Operations can be carried out easily, just by touching the screen.

How To Use This Manual

The KR105 Owner's Manual consists of three volumes, **Quick Start**, **Owner's Manual**, and the **USB Install Guide**.

Please start out by reading "Before You Start Playing" (p. 15) in the **Owner's Manual** (this volume).

This explains how to connect the KR105's power cord and how to turn on the instrument's power.

After turning on the KR105's power, please continue by reading **Quick Start**.

By trying out the various procedures while reading the **Quick Start**, you can easily learn how to play the KR105 and make use of its major functions (especially procedures that involve use of the "main buttons").

The **Owner's Manual** describes procedures, from basic operation to procedures for special applications (for example, using the KR105 as an accompanist and creating songs), that will help you master the KR105's many performance functions.

When connecting a computer to the USB port, be sure to read the **USB Install Guide**. This describes the procedure for installing the driver needed to connect via USB.

* *For more on system requirements, refer to the "USB Installation Guide."*

■ Conventions Used in This Manual

This manual uses the following conventions in the interest of simpler, more concise instructions.

- Button names are enclosed in square brackets "[]", as in One Touch Program [Piano] button.
- On screen text is enclosed in angled brackets "< >", as in <Exit>.
- The act of lightly contacting the Touch Screen with your finger is called "touching."
- An asterisk (*) or a **NOTE** at the beginning of a paragraph indicates a note or precaution. These should not be ignored.
- (p. **) refers to pages within the manual.

Contents

Using the unit safely	3	Selecting Music Styles (Music Style Buttons)	39
Important notes	5	Playing Only Music Style Rhythm Patterns	42
Introduction.....	7	Adjusting the Accompaniment Tempo	42
Main Features	7	Starting and Stopping the Accompaniment	43
How To Use This Manual.....	8	Modifying an Accompaniment	46
Panel Descriptions	12	Adding Harmony to the Right-Hand Part (Melody Intelligence).....	49
Rear Panel	14	Playing Sounds in the Left Hand (Lower Tone)	50
Bottom Panel.....	14	Playing the Piano with Accompaniment Added (Piano Style Arranger).....	51
Before You Start Playing	15	Adjusting the Volume Balance for Each Part (Balance)..	52
Connect the Pedal Cable	15	3. Song Playback.....	54
Connect the Power Cord.....	15	Playing a Song.....	54
Setting Up the Music Rest.....	15	Registering the Songs You Like (Favorites).....	59
Using the Music Holders	15	4. Practice Functions	61
Opening/Closing the Lid	16	Displaying Scores	61
Turning the Power On and Off	16	Adjusting the Tempo	66
About the Pedals	16	Match the Tempo Before You Begin Playing (Count In)	68
Adjusting the Sound's Volume and Brilliance	17	Muting Some Parts Before Playing (Track Buttons).....	69
Connecting Headphones	17	Setting Markers for Repeated Practice (Marker)	70
Using the Headphone Hook.....	18	Transposing Keyboard Sounds and Songs Played Back (Transpose)	73
Connecting a Microphone	18	5. Recording and Saving the Performance	75
About the Touch Screen.....	18	Recording a New Song (New Song)	76
Adjusting the Contrast of the Screen.....	18	Recording With Accompaniment	78
Main Screens.....	19	Recording Along with a Song.....	80
Piano Screen.....	19	Recording While Selecting the Track Buttons (Redoing Recordings).....	81
Basic Screen	19	Erasing Recorded Performances	82
Using the Main Icons	19	Changing How Recording Stops.....	82
The Scroll Bar and The Page Icon	19	Recording Songs Starting with Pickups.....	84
1. Performance	20	Using Floppy Disks	85
Playing the KR105 Like a Piano (One-Touch Piano).....	20	Saving Songs	87
Performing with a Variety of Tones (Tone Buttons)	21	Deleting Saved Songs.....	90
Performing with Multiple Sounds Layered Together (Layer)	25	Copying Songs on Disks to Favorites.....	91
Playing Different Tones with the Left and Right Hands (Split)	26	6. User Program Registration.....	93
Adding Reverberation to the Sound (Reverb)	28	Saving Performance Settings (User Program)	93
Applying Effects to the Sound (Effects)	30	Calling Up Saved User Programs.....	94
Using the Metronome	32	Changing the Way User Programs Are Called Up	94
2. Automatic Accompaniment.....	35	Saving the User Program Sets	94
Music Styles and Automatic Accompaniment.....	35	Loading Saved User Program Sets	95
Performing Using Automatic Accompaniment (One-Touch Arranger)	36	Deleting Saved User Program Sets.....	96

Contents

Copying Sets of User Programs on Disks to the User Memory	96
Copying Sets of User Programs Stored in the User Memory to Disks	97
Using the Pedal to Switch User Programs	97
Selecting the Pedal Used for Switching Settings (Pedal Shift)	97
Sequential Loading of User Program Sets (Load Next)	97
Simultaneously Switching User Program and Transmitting PC Numbers	98

7. Creating and Editing Songs 99

Multitrack Recording with 16 Parts (16-Track Sequencer) 99	
The 16-Track Sequencer Screen	99
Modifying the Settings of Each Part	100
Getting the Most Suitable Part Tones for the Musical Genre (Tone Set)	101
Recording a Performance	101
Changing the Recording Method (Rec Mode)	102
Recording While Erasing the Previous Recording (Replace Recording)	103
Layering a Recording Over Previously Recorded Sounds (Mix Recording)	103
Repeated Recording at the Same Location (Loop Recording)	104
Re-Recording Part of Your Performance (Punch-in Recording)	105
Composing an Accompaniment By Entering Chords (Chord Sequencer)	106
Inputting Chords without Playing the Keyboard	107
Editing Songs	107
Basic Operation of the Editing Functions	107
Undoing Edits (Undo)	108
Copying Measures (Copy)	108
Correcting Timing Discrepancies (Quantize)	109
Deleting Measures (Delete)	110
Inserting Blank Measures (Insert)	110
Transposing Individual Parts (Transpose)	111
Making Measures Blank (Erase)	111
Exchanging Parts (Part Exchange)	112
Correcting Notes One by One (Note Edit)	112
Modifying the Tone Changes in a Song (PC Edit)	113
Changing the Beat in the Middle of a Song (Beat Map) ..	113
Changing the Tempo of Recorded Songs	114
Changing the Tempo Within the Song	114
Adjusting the Tempo While Listening to a Song	114
Adjusting the Tempo at a Particular Measure	115

8. Creating Music Styles 116

Creating Original Styles (User Styles)	116
Creating New Styles by Combining Internal Music Styles (Style Composer)	116
Creating a Style from a Song You Composed Yourself (Style Converter)	118
Saving a User Style	121
Deleting Saved User Styles	122
Copying Styles on Disks to the User Memory	123
Copying Styles Saved in the User Memory to Disks ...	123

9. Various Settings 124

Changing the Settings for One-Touch Arranger	124
Procedure	124
Adjusting the Keyboard Touch (Key Touch)	124
Changing the Keyboard's Split Point (Split Point)	125
Changing Music Styles Without Changing the Tone or Tempo (One Touch Setting)	125
Assigning Functions to Pedals and Performance Pads (Pedal Setting/User Functions)	126
Changing the Bend Range (Pedal Setting)	128
Changing How Chords Are Played and Specified (Arranger Config)	128
Changing the Tuning (Tuning)	129
Placing a Marker in the Middle of a Measure	131
Changing the Settings for the Count	131
Changing the Settings for One-Touch Piano	132
Procedure	132
Lid: Adjusting the piano tone	132
Adjusting Resonance (Resonance)	132
Changing the Tuning (Tuning)	133
Changing How Rapidly Sounds Are Expressed According to the Force Used to Play the Keys (Hammer Response)	134
Adjusting the Resonant Sounds (String Resonance)	134
Adjusting the Keyboard Touch (Key Touch)	135
Other Settings	135
Changing Standard Pitch (Master Tune)	136
Changing the Language (Language)	136
Changing the Screen Message When the Power Is Turned On (Opening Message)	136
Turning Off the Beat Indicator (Beat Indicator)	137
Selecting Images To Be Shown on the KR105 (User Image Display)	137
Remembering the Settings Even When the Power is Turned Off (Memory Backup)	138
Restoring the Factory Settings (Factory Reset)	138
Calibrating the Touch Screen (Touch Screen)	139
Formatting the User Memory	139
Automatically Starting the Quick Tour	140
Disabling Functions Other Than Piano Performance (Panel Lock)	140

Detailed Song Playback Settings 141
 Changing the Tone Settings When Playing Back Songs
 (Play Mode)..... 141
 Viewing Song Information (Information) 141
 Hiding the Lyrics (Lyrics)..... 141
 Changing the Parts Assigned to the Track Buttons During
 SMF Playback (Track Assign)..... 142

10. Connecting External Devices..... 143

Connecting Video Equipment (V-LINK)..... 143
 Using the V-LINK function 143
 Connecting MIDI Devices..... 143
 Connectors 143
 Making the Connections 144
 Synchronizing with Connected MIDI Devices 144
 Performing in Ensemble with MIDI Instruments (MIDI
 Ensemble)..... 145
 MIDI Settings..... 146
 Selecting the Transmit Channel (Tx Channel) 146
 Disconnecting the Internal Sound Generator and
 Keyboard (Local Control) 146
 Sending Tone Change Messages (Program Change/
 Bank Select MSB/Bank Select LSB) 147
 Sending Recorded Performance Data to a MIDI Device
 (Composer MIDI Out)..... 147
 Connecting to Audio Equipment 148
 Connectors 148
 Making the Connections 148
 Connecting a Computer..... 149
 Connect to the MIDI Connectors 149
 Connect to the USB Connector..... 150
 Troubleshooting 151

Appendices 151

Error Messages 155
 Tone List..... 156
 Drum Set List..... 158
 SFX Set List 162
 Effects List..... 163
 Chord List 164
 Internal Song List..... 166
 Parameters Stored to Internal Memory 167
 Music Files That the KR105 Can Use 168
 About the KR105's Sound Generator 168
 Main Specifications..... 170

Index 171

Panel Descriptions

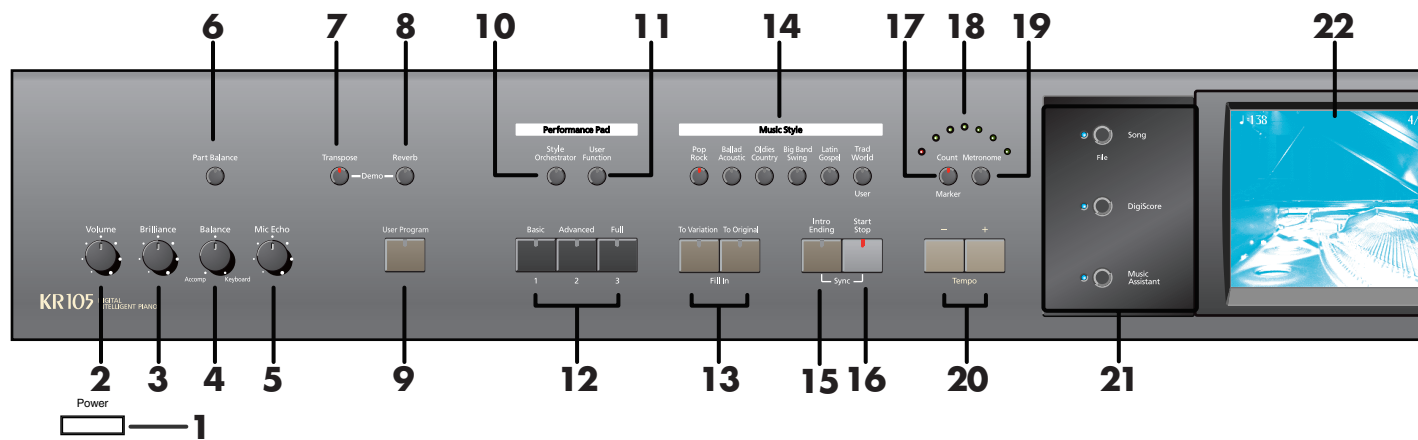

1. [Power] switch

Pressed to switch the power on and off (p. 16).

2. [Volume] knob

Adjusts the overall volume (p. 17).

3. [Brilliance] knob

Adjusts the brightness of the sound (p. 17).

4. [Balance] knob

Changes the volume balance for sounds played with the keyboard and for songs and accompaniments (p. 52).

5. [Mic Echo] knob

Allows you to set the level of the echo effect that can be added to your singing (p. 30).

6. [Part Balance] button

This adjusts the relative volume levels of each of the performance parts (p. 52).

7. [Transpose] button

Transposes the pitch of the keyboard or the song being played (p. 73).

8. [Reverb] button

Adds reverberation to the sound (p. 28).

9. [User Program] button

Stores the selected functions and states of the buttons (p. 93).

Performance Pad

10. [Style Orchestrator] button

This is used to change the arrangement type for automatic accompaniment with the Performance Pads (p. 46).

11. [User Function] button

This is used to assign a variety of functions to the Performance Pads (p. 126).

12. [Basic/1], [Advanced/2], [Full/3] buttons

The operation of these buttons depends on the status and setting of buttons each is changed depending on the buttons numbered [10] and [11].

13. Fill In buttons ([To Variation], [To Original])

Inserts a fill-in in an automatic accompaniment and changes the accompaniment pattern (p. 46).

14. Music Style buttons

Select a Music Style for automatic accompaniment (p. 39).

Pressing the [User] button selects a User Style that you've made yourself or a Music Style on a floppy disk (p. 41).

15. [Intro/Ending] button

Play an intro or ending during automatic accompaniment (p. 43).

16. [Start/Stop] button

Starts and stops automatic accompaniment (p. 43).

17. [Count/Marker] button

You can change the count settings (p. 45, p. 68).

These allow you to add and move markers in the notation as well as repeat playback of song segments simply and easily (p. 70).

18. Beat Indicator

This lights up in correspondence with the beat of the selected song or accompaniment.

19. [Metronome] button

Activates the built-in metronome (p. 32).

20. Tempo [-] [+] buttons

Adjusts the tempo.

Press the [-] and [+] buttons at the same time to return to the original tempo.

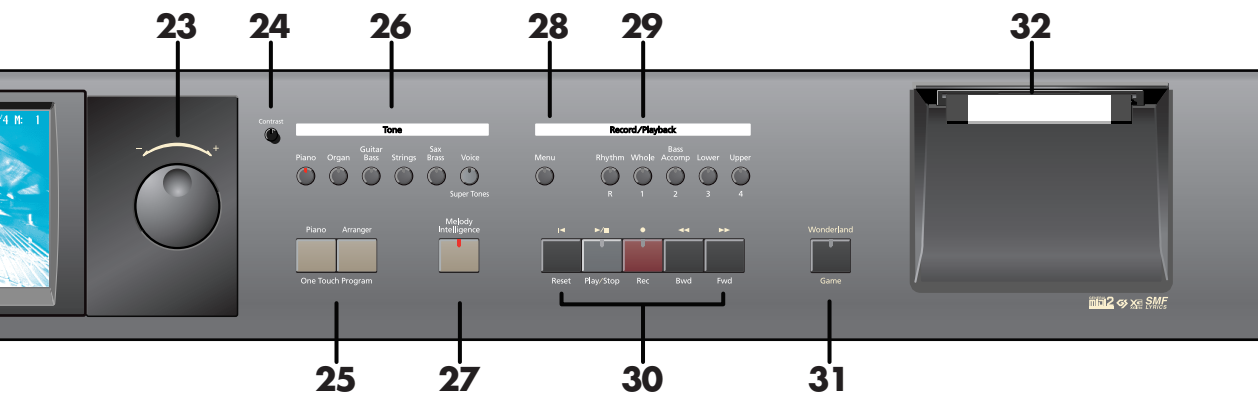

21. Main Buttons

→ See the Quick Start

[Song/File] button

Use this button to select internal songs or songs from floppy disk (p. 54).

[DigiScore] button

Displays notations (p. 61).

[Music Assistant] button (p. 140)

22. Touch Screen

This lets you perform a variety of operations just by touching the screen (p. 18).

23. Dial

Use this to change on-screen values.

24. Contrast knob

Adjusts the contrast of the screen (p. 18).

25. One Touch Program

[Piano] button

Makes the optimal settings for a piano performance (p. 20).

[Arranger] button

Makes the optimal settings for playing with automatic accompaniment (p. 36).

26. [Tone] buttons

Select the Tones that will be played from the keyboard (p. 21).

27. [Melody Intelligence] button

Adds harmony to the sounds played with the keyboard (p. 49).

Record/Playback

28. [Menu] button

You can select functions for playing back, recording or editing a song (p. 82, 99, 141).

29. Track buttons

Used to play back or record each track of a song (p. 69, 81).

30. Transport buttons

[|◀ (Reset)] button

Resets the song playback-start location to the beginning of the song.

[▶/■ (Play/Stop)] button

Starts and stops playback or recording a song.

[● (Rec)] button

When pressed, this button places the instrument in recording standby (p. 76, 99).

[◀◀ (Bwd)] button

Rewinds the song.

[▶▶ (Fwd)] button

Fast-forwards the song.

31. [Wonderland/Game] button

Here you can learn about instruments while having fun.

→ See the Quick Start

32. Disk drive

This is where you insert floppy disks with Standard MIDI Files or Music Styles you may already own. The drive accepts 2DD (720k) and 2HD (1.44MB) floppy disks.

Panel Descriptions

Rear Panel

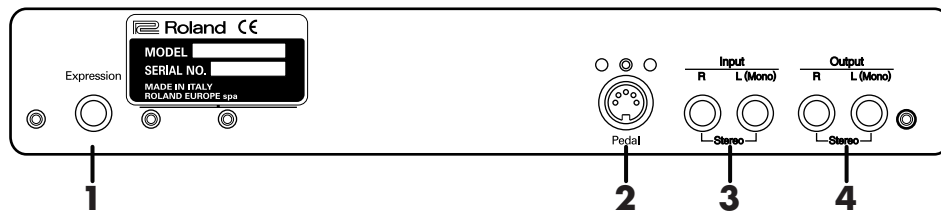

1. Expression pedal jack

You can connect an expression pedal to the KR105 to control the volume.

2. Pedal connector

Connect the pedal cable of the stand to this connector (p. 15).

3. Input jacks

These jacks can be connected to another sound generating device or an audio device, so that the sound of that device will be output from the KR105's speakers (p. 148).

4. Output jacks

These jacks can be connected to your audio system to enjoy more powerful sound. They can also be connected to a tape recorder or similar device in order to record your performance on a cassette tape (p. 148).

Bottom Panel

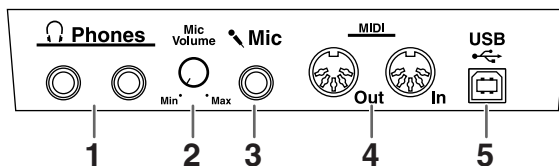

1. Phones jacks

A set of headphones can be connected here (p. 17).

2. Mic Volume knob

Adjusts the volume level for the microphone (p. 18).

3. Mic In jack

Used for connecting microphones (p. 18).

4. MIDI Out/In connectors

These can be connected to an external MIDI device to exchange performance data (p. 143).

5. USB connector

You can connect a computer and exchange performance data between the instrument and the computer (p. 150).

Before You Start Playing

Connect the Pedal Cable

Insert the pedal cable into the Pedal connector on the rear panel of the KR105.

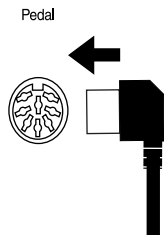

Connect the Power Cord

Insert the included power cord into the AC inlet on the bottom panel of the KR105, and then plug it into an electrical outlet.

NOTE

Be sure to use the supplied power cord.

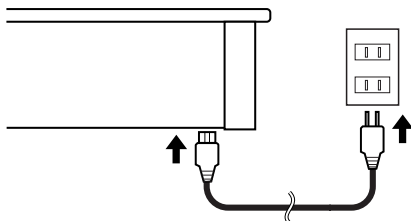

Setting Up the Music Rest

Set up the music rest as shown in the figure below.

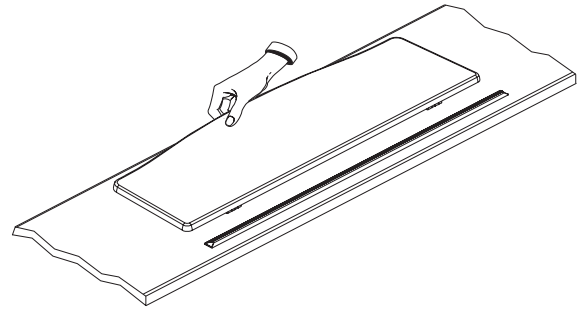

Fold the three supporting feet at the back of the rest and check whether the stand is held in place.

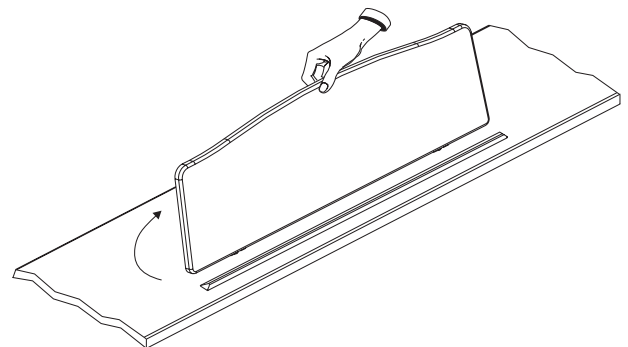

Before moving the KR105, be sure to lower the music stand as a safety precaution.

■ Using the Music Holders

You can use the holders to hold pages in place. When not using the holders, leave them folded down.

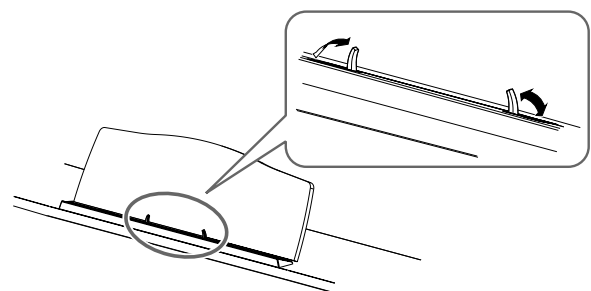

Before You Start Playing

Opening/Closing the Lid

To open the lid, use both hands to lift it lightly, and slide it away from yourself.

To close the lid, pull it gently toward yourself, and lower it softly after it has been fully extended.

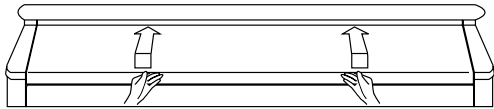

NOTE

When opening and closing the lid, be careful not to let your fingers get caught. If small children will be using the KR105, adult supervision should be provided.

NOTE

If you need to move the piano, make sure the lid is closed first to prevent accidents.

Turning the Power On and Off

NOTE

Turn on power to your various devices in the order specified. By turning on devices in the wrong order, you risk causing malfunction and/or damage to speakers and other devices.

To turn the power on, turn the [Volume] knob all the way down, and then press the [Power] switch.

The power will turn on, and the Power indicator at the left front of the KR105 will light.

After a few seconds, you will be able to play the keyboard to produce sound.

Use the [Volume] knob to adjust the volume.

NOTE

This unit is equipped with a protection circuit. A brief interval (a few seconds) after power up is required before the unit will operate normally.

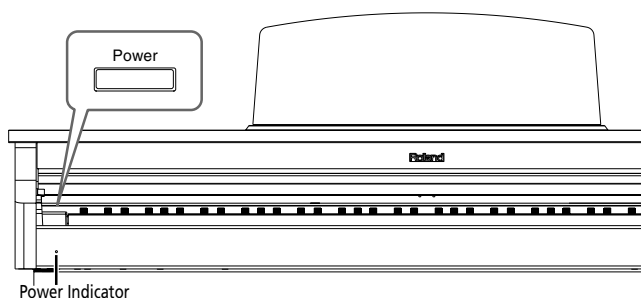

To turn the power off, turn the [Volume] knob all the way to the left, and press the [Power] switch.

The Power indicator at the left front of the KR105 will go

dark, and the power will be turned off.

- If you need to turn off the power completely, first turn off the POWER switch, then unplug the power cord from the power outlet. Refer to **Power Supply** (p. 5).

About the Pedals

The pedals have the following functions, and are used mainly for piano performance.

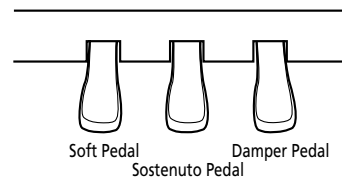

Damper pedal (right pedal)

While this pedal is pressed, notes will be sustained even after you take your fingers off the keys.

On an acoustic piano, holding down the damper pedal will allow the remaining strings to resonate in sympathy with the sounds that you played from the keyboard, adding a rich resonance.

The KR105 simulates this damper resonance.

MEMO

You can change the amount of resonance applied with the damper pedal.

Sostenuto pedal (center pedal)

This pedal sustains only the sounds of the keys that were already played when you pressed the pedal.

Soft pedal (left pedal)

When you hold down this pedal and play the keyboard, the sound will have a softer tone.

The softness of the sound changes subtly depending on the extent to which the pedal is depressed.

About the Adjuster

When you move the KR105 or if you feel that the pedals are unstable, adjust the adjuster located below the pedals as follows.

- Rotate the adjuster to lower it so that it is in firm contact with the floor. If there is a gap between the pedals and the floor, the pedals may be damaged. In particular when placing the instrument on carpet, adjust this so that the pedals firmly contact the floor.

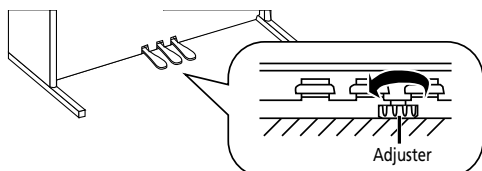

Adjusting the Sound's Volume and Brilliance

Turn the [Volume] knob to adjust the overall volume.

Turn the [Brilliance] knob to adjust the brightness of the sound.

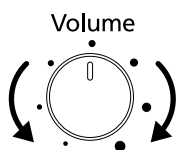

Connecting Headphones

The KR105 has two jacks for plugging in headphones. This allows two people to listen through headphones simultaneously, making it very useful for lessons and when performing piano pieces for four hands. Additionally, this allows you to play without having to worry about bothering others around you, even at night.

Plug the headphones into the Phones jack located at the bottom left of the piano.

Connecting headphones will automatically mute the sound from the internal speakers.

The headphone volume is adjusted by the [Volume] knob of the KR105.

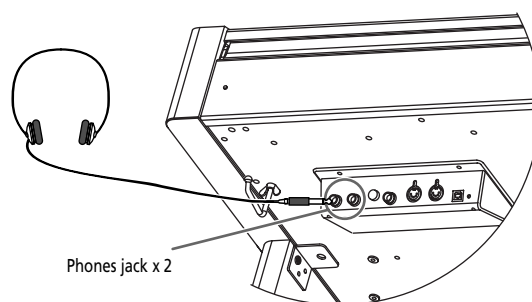

NOTE

Use Stereo headphones.

Some Notes on Using Headphones

- To prevent damage to the cord, handle the headphones only by the headset or the plug.
- Connecting the headphones when the volume of connected equipment is turned up may result in damage to the headphones. Lower the volume on the KR105 before plugging in the headphones.
- Listening at excessively high volume levels will not only damage the headphones, but may also cause hearing loss. Use the headphones at a moderate volume level.

Before You Start Playing

■ Using the Headphone Hook

Whenever you are not using the headphones, you can hang them on the headphone hook at the lower left of the KR105.

Attaching the Headphone Hook

Press and twist the headphone hook included with the KR105 into the hole in the bottom of the KR105 (refer to the figure below). Turn the headphone hook thumbscrew to secure the headphone hook.

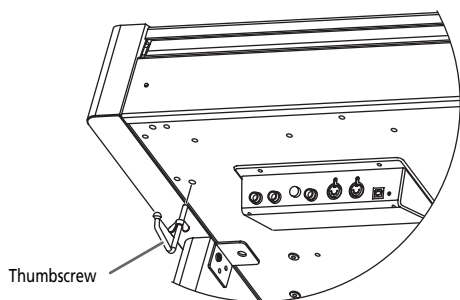

Connecting a Microphone

You can connect a microphone into the Mic In jack, and enjoy karaoke with the KR105.

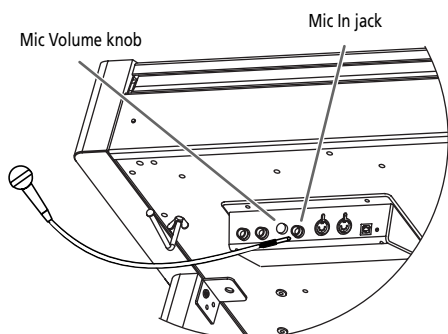

1. Connect a microphone (sold separately) to the Mic In jack on the lower-left area of the instrument.
2. Rotate the [Mic Volume] knob on left side of the Mic In jack to adjust the volume level for the microphone.

Some Notes on Using a Microphone

- Be careful of high volume levels when using microphone late at night or early in the morning.
- When connecting a microphone to the KR105, be sure to lower the volume. If the volume control is too high when the microphone is plugged in, noise may be produced by the speakers.
- Howling could be produced depending on the location of microphones relative to speakers. This can be remedied by:
 1. Changing the orientation of the microphone(s).
 2. Relocating microphone(s) at a greater distance from speakers.
 3. Lowering volume levels.

About the Touch Screen

The KR105 makes use of a touch screen.

This lets you carry out a wide variety of actions just by touching the screen lightly.

NOTE

The touch screen is operated by touching it lightly with your finger. Pressing hard, or using a hard object can damage the touch screen. Be careful not to press too hard, and be sure to use only your fingers to operate the touch screen.

NOTE

The positioning of the touch screen may become displaced due to changes in the surrounding environment and over time. If this happens, follow the steps in Refer to **Calibrating the Touch Screen (Touch Screen)** (p. 139). to correct the pointer position.

NOTE

Do not place items on the touch screen.

■ Adjusting the Contrast of the Screen

To adjust the contrast of the screen, turn the Contrast knob located at the right side of the screen.

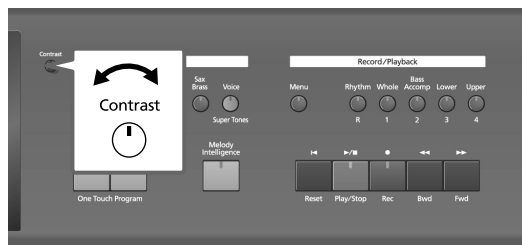

Main Screens

■ Piano Screen

Immediately after the power is turned on, the Piano screen like the one below is displayed. For details, refer to p. 20.

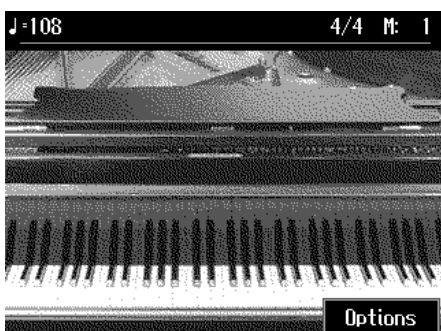

■ Basic Screen

The following screen is called Basic screen.

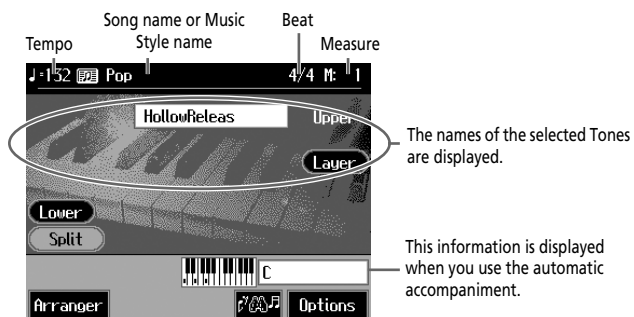

You can usually display this screen by pressing the <Exit> field several times.

Follow either of the procedures described below to display it.

- Press the One Touch Program [Arranger] button.
The Basic screen appears and the settings are made for automatic accompaniment.
- Press the One Touch Program [Piano] button, one of the Tone buttons, then the <Exit> field.

■ Using the Main Icons

You can many other screens besides the Basic screen to do things. The on-screen graphics that appear three dimensional work like buttons. These are called "Icons."

The main icons you can use on these screens are as follows.

	Some screens consist on two or more pages. You can display the next page or the previous page of the screen by touching these icons.
	When you select an internal song or music files that includes lyrics data, this icon appears in the Piano screen or Basic screen. Touch this to display the lyrics.

NOTE

The explanations in this manual include illustrations that depict what should typically be shown by the display. Note, however, that your unit may incorporate a newer, enhanced version of the system (e.g., includes newer sounds), so what you actually see in the display may not always match what appears in the manual.

■ The Scroll Bar and The Page Icon

The Song and Tone selection screens feature a scroll bar at the right of the screen list, with page icons at the top and bottom of the scroll bar.



Touch the scroll bar and drag up and down to scroll through the list.

Touch the page icons to change pages.

1. Performance

Playing the KR105 Like a Piano (One-Touch Piano)

You can create the optimal settings for a piano performance with the press of a single button.



1. Press the One Touch Program [Piano] button.

A Piano screen like the one shown below will appear.

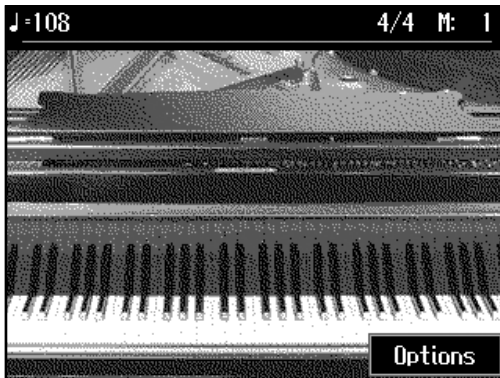

When you press the One Touch Program [Piano] button, the KR105 will switch to the following settings, regardless of the current panel settings.

- If the keyboard has been split into upper and lower sections (p. 26), the keyboard returns to a single section.
- The pedals return to their usual functions (p. 16).
- The Grand Piano sound is automatically selected.
- The effect is automatically set to “Damper Resonance” (p. 30).

MEMO

Since this instrument faithfully reproduces real acoustic piano action and response, keys played in the top one-and-one-half-octave range continue to resonate, regardless of the damper pedal action, and the tone in this range is audibly different. The Key Transpose setting (p. 73) can also be used to change the range that is unaffected by the damper pedal.

MEMO

When you select an internal song or music file that includes the lyrics data, **LYRIC** appears in the Piano screen or Basic screen. Touch this to display the lyrics.

Performing with a Variety of Tones (Tone Buttons)

The KR105 comes with a many built-in instrument sounds and effects. This lets you enjoy perform in a wide range of musical styles.

The built-in sounds are called "Tones." The sounds are organized into six tone groups, which are assigned to the Tone buttons.



For more about the names of Tones, take a look at the "Tone List" (p. 156).



1. Press any one of the Tone buttons to select a tone group.

You'll see that button's indicator light up.

The screen displays the tone names included in the tone group you've selected.



This screen is called the "Tone selection screen."

Tones indicated by **EX** is called "EX voices." These voices are especially recommended.

What "Key Off Sound" does is recreate the tonal changes produced when the fingers are released from the keys.

Tones indicated by "GS" are GS tones.

Touch and drag up and down in the scroll bar to scroll through the screen and display other tones.

Touch the page icons  <  > to change pages.

You can touch <Audition> for a demonstration of a particular tone.

You can touch <Effects> to add effect sounds to a variety of tones (p. 30).

You can touch <Search> to find tones according to the search criteria you specify (p. 24).

2. Touch a tone name to select the tone.

You'll hear the tone you've selected when you play the keyboard.

You can use the dial to scroll through the screen as you switch the Tones to be played.

3. Touch <Exit>.

This returns you to the Basic screen or the previous screen.

■ Playing Percussion Instruments or Sound Effects

You can use the keyboard to play percussion sounds or effects like sirens and animal sounds.



1. Press the [Voice/Super Tones] button and watch the indicator light up.



2. Touch <Super Tones> in the display.

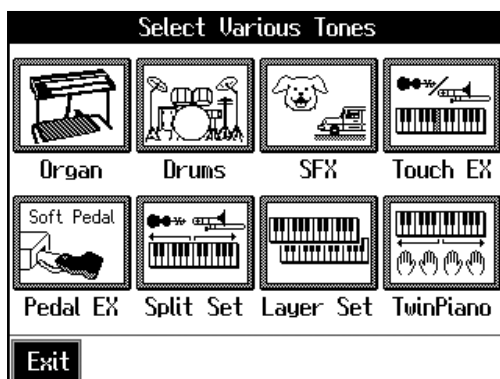

3. Touch <Drums> or <SFX> to display the “Drums” or the “SOUND EFFECT” screen.

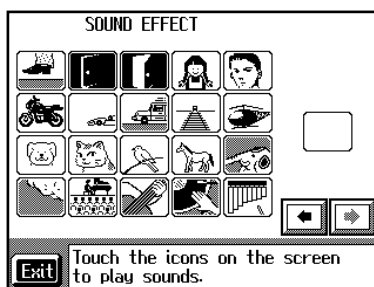
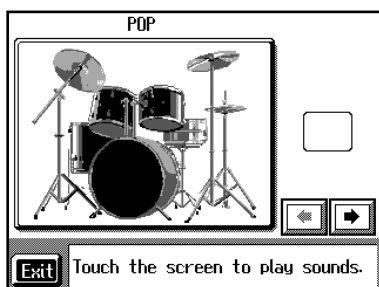

Each note of the keyboard will play a different sound. You can also play sounds by touching the screen.

You can select other drum tones by pressing the < ◀ > or < ▶ > buttons.

4. Touch <Exit> several times.

This returns you to the Basic screen or the previous screen.

MEMO

The combination of sounds assigned to the keyboard varies according to the drum set. Take a look at the “Drum Set List” (p. 158) and “SFX Set List” (p. 162).

■ Using Keywords to Search for Tones (Tone Search)

You can search for tones that match the conditions you set for instrument or musical style. You can also search the tones using the first character of the tone name.

1. Press any Tone button.

The tone selection screen appears.

2. Touch <Search>.

The following "Tone Search" screen appears.

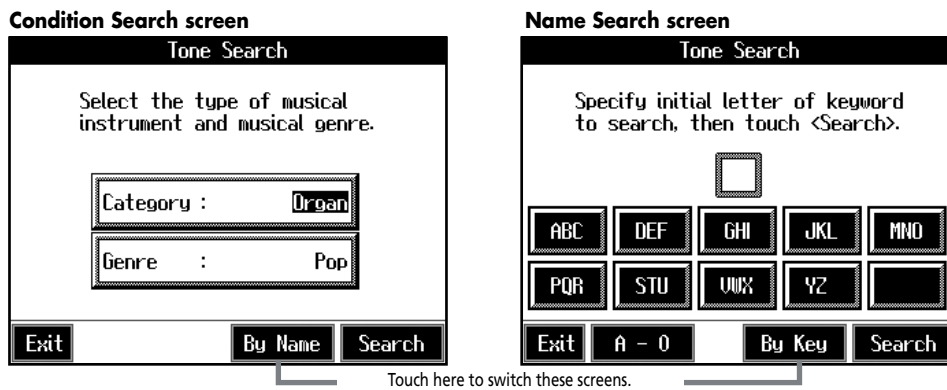

Searching by Conditions

3. Touch <Category> or <Genre>, then use the dial to select the search conditions.

4. Touch <Search>.

The search results appear in the display.

Touch the tone name to select the tone.

Touch button to return to the tone search screen.

Searching by Tone Name

3 Touch <By Name>.

Touch <By Key> to go to the condition search screen.

4. Decide which character is to be used for the search.

The selected character appears in the middle of the screen.

Enter the character you're searching for. For example, touching <ABC> in succession cycles you through the available choices in that character group ("A" → "B" → "C" ...).

Touching <A-0> selects the type of character. Each time you touch <A-0>, the character switches between alphabets and numerals.

5. Touch <Search>.

The search results appear in the display.

Touch the tone name to select the Tone.

Touch <Exit> several times to return to the Basic screen or the previous screen.



In condition search, tones satisfying all of the selected search criteria are sought.

Performing with Multiple Sounds Layered Together (Layer)

Two tones sounding together when you press a single key is referred to as a “layer performance.”

For instance, it’s possible to play the Tones for both Piano and Strings simultaneously.

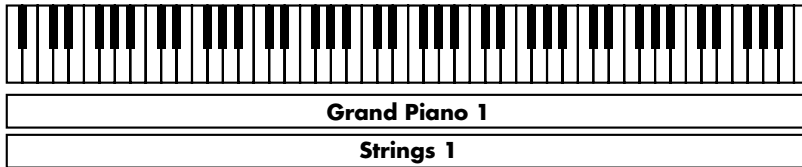

1. Touch <Layer 1>.



The tone that was sounding before you switched to layer performance, plus the tone indicated in the lower part of the display, are now played together.

Here, the tone appearing in the upper part of the display is called the “Upper tone,” and the tone appearing in the lower part of the display is called the “Layer tone.”

Changing the Tones

2. Touch the name of the tone to be changed.

Touch here to highlight the tone name.

3. Press a Tone button to select the new tone (p. 21).

4. When you have selected the tone, touch <Exit>.

The display returns to the Basic screen.

Cancelling the Layer

5. Touch <Layer>.

The <Layer> icons is dimmed, and the Layer performance is cancelled.

Now when you play the keys, only the tone indicated on the screen is sounded.



When you select an internal song or music file that includes the lyrics data, **Lyric** appears in the Basic screen. Touch this to display the lyrics.



When you touch Octave <-><+> on the tone selection screen, the pitch of the keyboard’s sound is changed in octave units. To learn more, see “Shifting the Keyboard Pitch in Octave Steps (Octave Shift)” (p. 27).



You can change the balance of the right-hand and Layer Tone volume. For instructions, see “Adjusting the Volume Balance for Each Performance Part (Part Balance)” (p. 52).

Playing Different Tones with the Left and Right Hands (Split)

Dividing the keyboard into right-hand and left-hand areas, then playing different sounds in each section is called “split performance.” The boundary key is called the “split point.”

The split point key is included in the left-hand keyboard area. Each time power to the keyboard is turned on, the split point is reset to “F#3.”

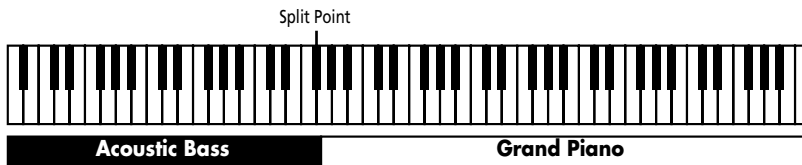

1. At the Basic screen, touch <Split>.



The tone sounding prior to the split performance is played in the right-hand section of the keyboard, and the tone indicated at the left of the screen is played in the left-hand section of the keyboard.

Here, the tone appearing at the right part of the display is called the “Upper tone,” and the tone appearing at the left part of the display is called the “Lower tone.”

Changing the Tones

2. Touch the name of the tone to be changed.
3. Press a Tone button to select the tone (p. 21).
4. When you have selected the tone, touch <Exit>.

The display returns to the Basic screen.

Cancelling the Split

5. Touch <Split>.

The <Split> icon is dimmed, and the Split performance is cancelled.

When you play the keys, only the tone indicated on the screen is sounded.



You can change the split point; refer to “Changing the Keyboard’s Split Point (Split Point)” (p. 125).



When you select an internal song or music file that includes the lyrics data, **LYRIC** appears in the Basic screen. Touch this to display the lyrics.



When you touch Octave <-> <+> in the tone selection screen, the pitch of the keyboard’s sound is changed in octave units. To learn more, see “Shifting the Keyboard Pitch in Octave Steps (Octave Shift)” (p. 27).



You can change the volume balance between the upper and lower parts of the keyboard; refer to “Adjusting the Volume Balance for Each Performance Part (Part Balance)” (p. 52).

Using Layer and Split Performance Simultaneously

Turning on either Layer Performance or Split Performance allows you to divide the keyboard into an upper and a lower part and play with two Tones layered in the upper part.



MEMO

When the keyboard has been divided into Upper and Lower sections, the damper pedal only affects the Upper section. If you want to sustain the notes of the Lower section, see "Assigning Functions to Pedals and Performance Pads (Pedal Setting/User Functions)" (p. 126).

■ Shifting the Keyboard Pitch in Octave Steps (Octave Shift)

When using Layer performance (p. 25) or Split performance (p. 26), you can change the pitch of the keyboard's sound in octave units. This function is called "Octave Shift."

For example, when using a Layer performance, you can change the pitch of either. You can make the pitch of the keyboard's Lower part match the pitch of the Upper part during split performance.

- 1. On the Basic screen, touch <Layer> or <Split>.**
The KR105 switches to Layer performance or Split performance.
- 2. To apply Octave Shift, touch the name of the tone you've selected.**
- 3. Press the Tone button to display the Tone selection screen.**



- 4. Touch Octave <-> or <+> in the lower part of the screen to adjust the pitch of the sound.**

Each time you touch <+>, the pitch is raised one octave.

Each time you touch <->, the pitch is lowered one octave.

The sound can be changed from two octaves lower than the original sound (-2) to two octaves above the original (+2).

Touch <Exit> to return to the Basic screen or the previous screen.

Adding Reverberation to the Sound (Reverb)

Apply a reverb effect to the notes you play with the KR105.
 Reverb makes it sound as if you are playing in a concert hall.

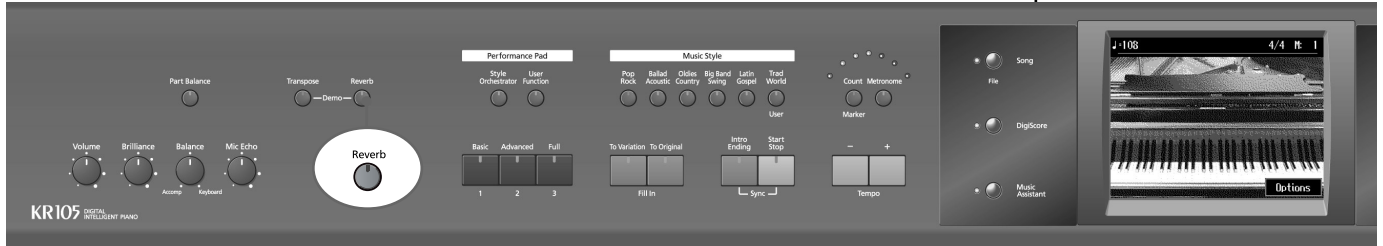

1. Press the [Reverb] button and watch the its indicator light up.
 A "Reverb" screen like the one shown below appears.

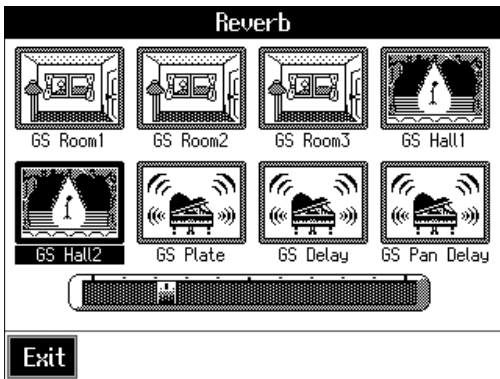

2. Touch an icon to select the performance space.

Display	Explanation
GS Room 1	Reproduces an indoor-type reverb. Provides a clear, expansive reverberation.
GS Room 2	
GS Room 3	
GS Hall 1	Reproduces the reverberation found in a hall. Gives reverberation with a greater sense of depth than GS Room.
GS Hall 2	
GS Plate	Reproduces a plate echo (reverberation created using the vibrations of a metal plate).
GS Delay	A delayed sound that is added to the original, similar to the reflected sounds of mountain echoes.
GS Pan Delay	The reflected sounds are panned (shifted) laterally.

3. Touch the slider beneath the icons to adjust the effect selected.

Touch and slide the knob on the screen to the right for a deeper reverb, and to the left for less.
 You can also move the slider with the dial.
 When you touch <Exit>, the reverb effect is activated, and you return to the previous screen.



No effect is applied when the slider is moved all the way to the left. In this case, the button's indicator won't light up when you press the [Reverb] button.

Cancelling the Effect

- 4.** Press the [Reverb] button, and watch the indicator light go out.

The reverb effect is eliminated.

Applying Effects to the Sound (Effects)

You can apply a wide range of different effects to the notes you play on the keyboard.

1. First, press a Tone button to select a Tone (p. 21).

The Tone selection screen appears.



2. Then, touch <Effects>.

The "Effects" screen appears.

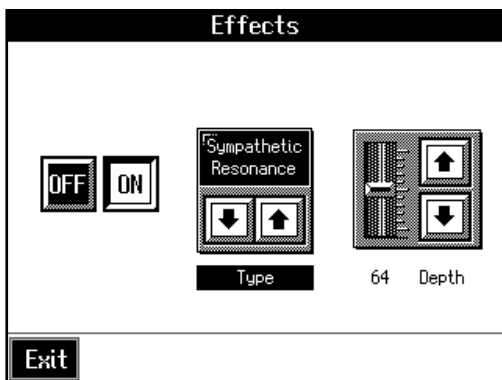





Applying Effects to the Sound

3. Touch <ON>.

The effect selected with <Type> will be applied.

Selecting the Type of Effect

4. Touch <Type>   > to select the type of effect.
5. Touch <Depth>   to adjust the amount of effect applied.

The amount increases as the value is raised.
You can also move the slider with the dial.

MEMO

For more on the effect types, refer to the "Effects List" (p. 163).

NOTE

You may find effects not being applied to certain parts when different effects are applied to the Upper tone, Layer tone, and Lower tone. In such instances, you can select which effect is to have priority.

Canceling the Effect

6. On the "Effects" screen, touch <OFF> to switch off the effect.
7. Touch <Exit> to return to the Tone selection screen.

About the Effect Settings

When the effects is set to ON, the appropriate effect is applied for the currently selected sound. You can also apply different effect types to each tone (except GS tones and tones with the "♪" logo). Although turning off the power returns effects to their initial settings, carrying out Memory Backup (p. 138) allows you to save and store the settings even after the power is turned off.

■ Enjoying Karaoke Performances with Music Files

1. Connect a microphone.
2. Adjust the volume level.
3. Select a song.

For instructions on how to select songs, refer to "Playing a Song" (p. 54).

4. Adjust the tempo as required with the Tempo [-] [+] buttons.
5. If necessary, change the key of the song (Transpose: p. 73).

When you press the [▶/■ (Play/Stop)] button, the accompaniment starts playing.
Sing along with the accompaniment.

When you play back a Music File with lyrics, the lyrics appear on screen.

6. Press the [▶/■ (Play/Stop)] button to stop the accompaniment.

MEMO

All [Voice] button tones with a "GS" or "♪" logo appearing after the tone name have the same effect applied to them. If the effect for one of the tones with the "GS" or "♪" logo is changed, then the effects for the other tones with the "GS" or "♪" logo are also changed automatically.

MEMO

Commercial music files designed for "karaoke" sing-along are also available. Consult your KR105 dealer when purchasing music files. Refer to "Music Files That the KR105 Can Use" (p. 168).

MEMO

You can stop lyrics from being displayed. Refer to "Hiding the Lyrics (Lyrics)" (p. 141).

Using the Metronome

The KR105 features a built-in metronome. During playback of the song and accompaniment, the metronome plays at that tempo and beat.



During playback of a song, or when performing with automatic accompaniment, the sound of the metronome keeps time with the beat of the song or accompaniment.

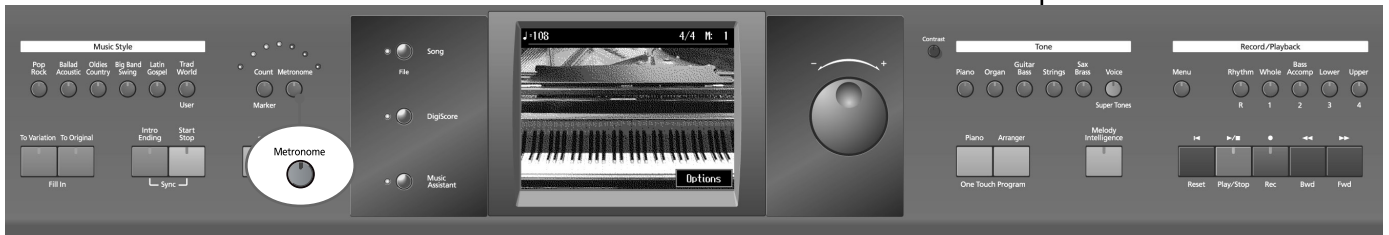

■ Using the Metronome

1. Press the [Metronome] button and watch the indicator light up.

You will hear the metronome.

The following “Metronome screen” appears.

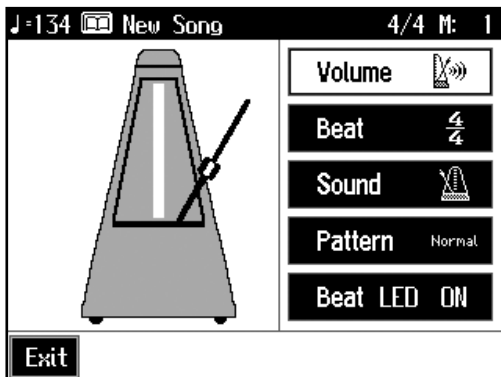

You can touch <Exit> to have the metronome continue to play while you return to the previous screen.

Stopping the Metronome

2. Press the [Metronome] button once more, and the indicator light goes out.

■ Changing the Metronome Settings

○ Adjusting the Tempo

You can adjust the tempo of the metronome. The tempo of the metronome changes automatically if you use an automatic accompaniment or play back a song.

1. Press the Tempo [-] or [+] buttons to adjust a tempo.

You can adjust the metronome tempo over a range of ♩= 10–500.

Pressing the Tempo [-] and [+] buttons simultaneously returns the selected song accompaniment to the basic tempo.

○ Changing the Beat of the Metronome

1. On the Metronome screen, touch <Beat>.

2. Select the beat with the dial.



When $\frac{0}{4}$ is selected, only the upbeat will sound.

○ Changing the Volume

The volume of the metronome can be adjusted to ten different levels.

1. On the Metronome screen, touch <Volume>.

2. Set the volume with the dial.

Choosing  sets the volume to the lowest level, and choosing  sets it to the highest level.

Choose  to silence the metronome sound.





○ Changing the Type of Sound



You can change the sound the metronome makes.

The “Normal sound” (see below) is selected when the KR105 is powered up.

1. On the Metronome screen, touch <Sound>.

2. Select the sound with the dial.







Displayed	Explanation	Displayed	Explanation
	Normal sound		Electronic sound
いちに	“1, 2, 3” in Japanese	One, two,	“1, 2, 3” in English
	Dog and cat sounds		Wood block

Displayed	Explanation	Displayed	Explanation
	Triangle and castanet		Hand clap

○ Changing How the Metronome Beat (Pattern) Sounds

You can set the metronome to play at even smaller intervals.

1. On the Metronome screen, touch <Pattern>.
2. Select the pattern with the dial.

Displayed	Explanation	Displayed	Explanation
Normal	Usual sound		Dotted half-note intervals
	Half-note intervals		Dotted quarter-note intervals
	Quarter-note intervals		Dotted eighth-note intervals
	Eighth-note intervals		Sixteenth-note intervals
+Doubl	Single back beat added	+Tripl	Triplet rhythm added
+Shufl	Shuffle rhythm added		

○ Turning Off the Beat Light (Beat Indicator)

The beat light flashes in time with the metronome, accompaniment Styles, and song tempos, but you can set it so that it stays off at all times.

1. Touch <Beat LED> in the Metronome screen.
2. Select OFF (Beat Indicator off) with the dial.

2. Automatic Accompaniment

Music Styles and Automatic Accompaniment

What is automatic accompaniment?

Automatic accompaniment is a function that provides you with accompaniment in a variety of musical genres, just by specifying chords in the left hand. Automatic accompaniment lets you play with an orchestra, even when performing alone! Press the One Touch Program [Arranger] to recall optimum settings for this function.

What Are Music Styles?

Accompaniment patterns in various musical genres are called "Music Styles."

There are many different kinds of music around the world, and each has its own unique features. What gives jazz or classical music their unmistakable sounds are a unique combination of elements like instrumentation, melody, and phrasing, which interact to create the musical character.

Elements of Music Styles

A Music Style consists of a set of six patterns called "divisions."

Division	Explanation
Intro	Played at the start of a song.
Original	The basic accompaniment pattern.
Variation	This is a variation on the Original accompaniment pattern.
Fill In To Original	This is a one-measure phrase inserted at a point where the mood changes and the accompaniment returns to the original.
Fill In To Variation	This is a one-measure phrase inserted at a point where the mood changes and the accompaniment moves ahead to the variation.
Ending	The conclusion of a song.

In addition, Music Styles may contain some or all of the following partsfff:

"Rhythm," "Bass," "Accompaniment 1," "Accompaniment 2," "Accompaniment 3," "Accompaniment 4," "Accompaniment 5," and "Accompaniment 6."



For instructions on playing the automatic accompaniment, refer to "Selecting Music Styles (Music Style Buttons)" (p. 39).

Performing Using Automatic Accompaniment (One-Touch Arranger)

Here's how to create the settings for Automatic Accompaniment.



1. Press the One Touch Program [Arranger] button.

The Basic screen like the one shown below appears.



Observe the settings:

- The keyboard is split into left- and right-hand parts, with accompaniment chords specified for the left-hand side of the keyboard.
- A tone appropriate for the selected Music Style is chosen.
- The tempo and beat for the selected Music Style is set.

2. Play a chord on the Lower-part of keyboard.

The accompaniment begins, starting from the intro.

Play chords with the left hand, and the melody with the right.

When you change chords in the left hand, the accompaniment also changes.

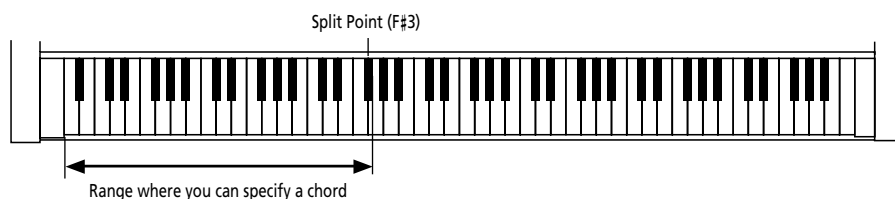

3. Press the [Intro/Ending] button.

After the ending plays, the accompaniment stops.



< > appears in the Piano screen or Basic screen when headphones are connected..



Normally, when you change a Music Style, the tempo and tone change to selections that go well with the selected Music Style. If you do not want to change the tempo and tone, refer to "Changing Music Styles Without Changing the Tone or Tempo (One Touch Setting)" (p. 125).



For instructions on selecting Music Styles, refer to "Selecting Music Styles (Music Style Buttons)" (p. 39).



For instructions on starting and stopping the accompaniment, refer to "Starting and Stopping the Accompaniment" (p. 43).



You can change the range in which chords are played. Please refer to "Changing the Keyboard's Split Point (Split Point)" (p. 125).

■ About Chords

A chord is produced when several notes are played simultaneously. Chords are indicated by the pitch of the fundamental note of the chord (the root) and the chord type, which is determined by the other notes of the chord.

For example, the C m chord is expressed in terms of the root note "C" and the chord type "m" (minor). C m is made up of the three notes "C," "E♭" and "G."

"C m" is indicated as the chord name on the Basic screen.

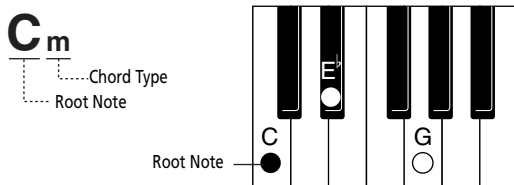

All chord roots are indicated as a letter, sometimes with # or ♭ added, and correspond to the notes shown below.

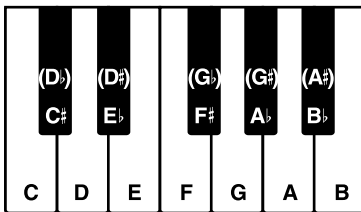

■ Playing Chords with Simple Fingering (Chord Intelligence)

"Chord Intelligence" is a feature that chooses the accompaniment chords the moment you play a key.

To play a "C" chord, for example, you normally have to play the three keys C, E, and G. But with Chord Intelligence, you only have to press the C key to start a "C" chord accompaniment.

• Intelligence 1

Major



Minor



Seventh

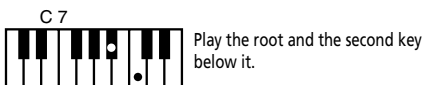

Minor Seventh

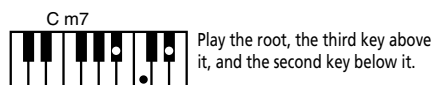

Major Seventh



Diminished



Normally, settings used for the Chord Intelligence function are selected, but there may be settings that are not used. You can also change the rules governing how chords are played. For more information, see "Changing How Chords Are Played and Specified (Arranger Config)" (p. 128).



For more information about chord fingering, refer to the "Chord List" (p. 164).

■ Viewing Chord Fingerings (Chord Finder)

Whenever you are not sure how a certain chord is fingered, you can display the notes of the chord on the screen.

1. On the Basic screen, touch <[Chord Finder Icon]>.

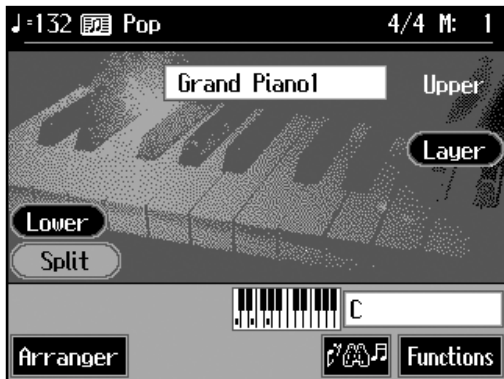

2. Touch the root of the chord you want to learn about.

The chord fingering appears on screen.

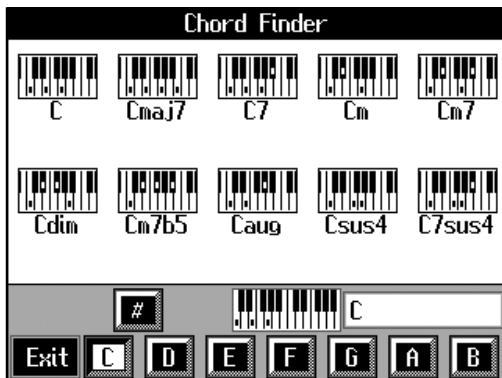

For example, if you wanted to see the fingering for a C# chord, you would touch <C>, then touch <#>.

Touch <Exit> to go back to the Basic screen.

Selecting Music Styles (Music Style Buttons)

You can select a variety of different Music Styles by pressing the Music Style buttons. Four different preset styles are assigned to the Music Style.

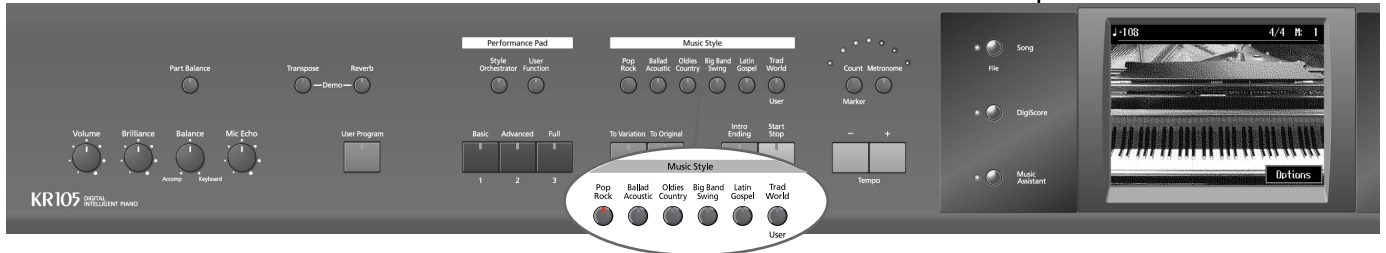

1. Press the One Touch Program [Arranger] button.
2. Press one of the Music Style buttons to select the Music Style group.

Watch the indicator button light up.

Five of the Music Styles included in that group are displayed on the screen.



This screen is called the "Style Selection screen."

Touch and drag up and down in the scroll bar to scroll through the screen and display other styles.

Touch the page icons <▲> <▼> to change pages.

You can touch <Search> to find Styles that match the selected criteria (p. 40).

3. Touch a Music Style name to select the Music Style.
You can use the dial to automatically switch pages and select Styles.
4. Touch Preset <A>, , <C>, or <D> in the lower part of the screen.
When the Music Style is selected, Preset A is selected.
When any of the Presets from <A> through <D> are selected, the Music Style tempo, Upper Tone, Style Orchestrator settings (p. 48) and other settings change.
5. Touch <Exit>.

The display returns to the Basic screen.

When you play a chord in the left-hand part of the keyboard, the selected Music Style is automatic.



For more on the Music Style names, refer to the separate "Music Style List".

■ Using Keywords to Search for Music Styles (Style Search)

You can search for Music Styles that match the tempo of the song, musical genre, or other criteria you set.

You can also search Music Styles using the first character of the Style names.

1. Press one of the Music Style buttons.

2. Touch <Search>.

The following "Style Search screen" appears.

Condition Search screen



Name Search screen



Touch here to switch these screens.

○ Searching by Conditions

3. Touch the parameter you want to set, then use the dial to select the search conditions.

4. Touch <Search>.

The search results appear in the display.

Touch a Music Style name to select a Music Style.

Touch <Exit> to return to the Style Search screen.

○ Searching by Music Style Name

3. Touch <By Name>.

Touch <By Key> to return to the Condition Search screen.

4. Decide which character you'll use for the search.

The selected character appears in the middle of the screen.

Enter the character you are searching for. For example, touching <ABC> in succession cycles you through the available choices in that character group ("A"→"B"→"C"...).

Touch <A-0> to toggle between alphabets and numerals.

5. Touch <Search>.

The search results appear on the display.

Touch a Music Style name to select a Music Style.

Touch <Exit> several times to return to the Basic screen or the previous screen.



Only the KR105's internal Music Styles are searchable.



In a condition search, the KR105 looks for Music Styles satisfying all of the selected search criteria.

■ Selecting Music Styles on Disks

You can play other User Styles saved to floppy disks or User memory (p. 121).



1. Insert the floppy disk into the disk drive (p. 85).
2. Press the Music Style [User] button.



When you select "User" or "Disk" using the arrows next to the "Media" field, the screen for selecting user memory or disk Styles appears.

When you touch <Preset>, the screen for selecting "Trad/Kids" Music Styles appears.

3. Select "Disk" using the "Media" arrow fields.
The Music Styles saved on the disk are displayed.
When you select "Media-User", the Music Styles stored in User memory are displayed.
4. Select a Music Style, and touch the Music Style name.
5. Press the One Touch Program [Arranger] button.

You can now perform in the selected Music Style.

Music Styles selected from floppy disks are stored until the power is turned off. Even after ejecting the floppy disk, by pressing the Music Style [User] button, you can perform using the most recently selected Music Style.



If you're using the disk drive for the first time, be sure to read "Important notes" (p. 5).



You can save multiple user Styles to user memory. Take a look at "Saving a User Style" (p. 121).

Playing Only Music Style Rhythm Patterns

You can also play only the rhythm patterns of Music Styles.



1. Select a Music Style (p. 39).
2. Press the One Touch Program [Piano] button.

The performance is set so that only the rhythm patterns are played.

3. Press the [Intro/Ending] button.

The Rhythm part of accompaniment begins, starting from the Intro.

Just as with regular Automatic Accompaniment, you can add intros and endings by pressing the [Intro/Ending] button, and make changes to the rhythm patterns with the Fill In button (p. 46).

NOTE

Some Music Styles do not include rhythm patterns. When you select these Style patterns, no rhythm patterns are played, even when you play on the left side of the keyboard.

Adjusting the Accompaniment Tempo



When the Basic screen is displayed, you can use the Tempo [-] [+] buttons or the dial to change the tempo.

The tempo is indicated on the upper left of the screen.



Pressing the Tempo [-] [+] buttons simultaneously returns the selected Music Style or song to the basic tempo.

You can change the tempo of Automatic Accompaniment even while the accompaniment is playing.

Starting and Stopping the Accompaniment

Pressing the One Touch Program [Arranger] button activates Sync Start for the accompaniment (which starts the accompaniment simultaneously when you play on the lower section of the keyboard), and automatically sets an appropriate intro for the accompaniment. You can also change the way the accompaniment starts and stops.



■ Having the Accompaniment Start Simultaneously When You Play the Keyboard (Sync)

1. Press the [Intro/Ending] button and [Start/Stop] button simultaneously, causing the indicators of both buttons to flash.

The Sync Start settings go into effect.

2. Play a chord on the lower-part of keyboard.

As you play the keys, the intro and accompaniment begins simultaneously.

○ Changing the intro

When set for Sync Start (the indicators of both the [Intro/Ending] button and [Start/Stop] button are flashing), you can use the following procedure to change the intro, or prevent the intro from playing.

Starting without an intro

Press the [Intro/Ending] button and watch the indicator go out.

Now when you play a chord with the keyboard, the accompaniment starts without the intro.

To start with a short intro added

On the Basic screen, touch <Arranger> to select the following page:

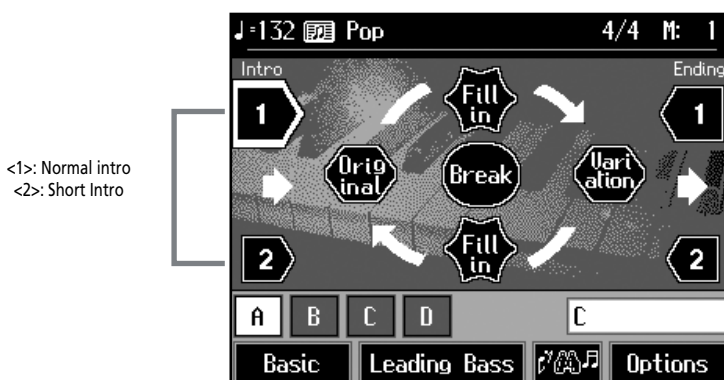

Sync Start is set immediately after the One Touch Program [Arranger] button is pressed.

Select the Intro/Ending Type <2>.

Now when you specify a chord with the keyboard, a short intro is played, and the accompaniment starts.

○ Starting at the press of a button

1. Press the [Intro/Ending] button and [Start/Stop] button simultaneously, and the indicators lights go out.

The Sync Start function is cancelled.

2. Play a chord on the lower part of keyboard.

Choose the chord to be played when the accompaniment begins playing.

3. Press the [Intro/Ending] button or the [Start/Stop] button.

When you press the [Intro/Ending] button, the intro plays, and the accompaniment starts. When you press the [Start/Stop] button, the accompaniment starts without the intro.

Chord Tones and Bass Tones

When you play the keys in the left-hand side of the keyboard while the [Start/Stop] button's indicator is not lit, chords play. This note is called the "Chord Tone," and the root of the chord being played at the same time is called the "Bass Tone."



You can change the sound of the chord tone and bass tone. Take a look at "Changing How Chords Are Played and Specified (Arranger Config)" (p. 128).

■ Stopping Automatic Accompaniment

○ Stopping with an Added Ending

1. Press the [Intro/Ending] button.

An ending plays and the Automatic Accompaniment stops.

To stop with a short Ending

On the Basic screen, touch <Arranger> to select the following page:

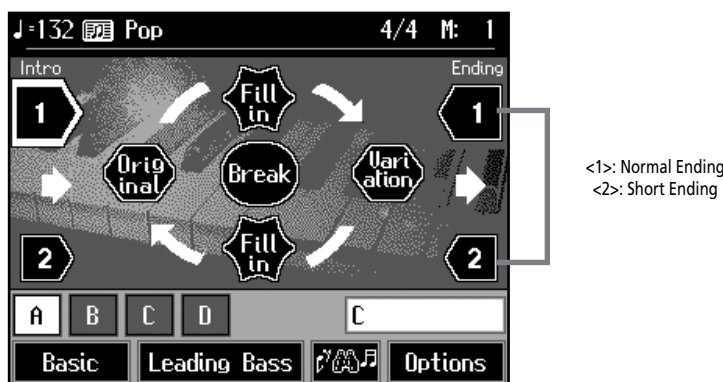

Select the Intro/Ending Type <2>.

Now a short Ending is played, and the accompaniment stops.

○ Stopping at the Same Time the Button is Pressed

1. Press the [Start/Stop] button.

The Automatic Accompaniment stops as soon as you press the button.

■ Having a Count Sound Play at the End of the Intro (Countdown)

If an intro plays before your performance, you can have a count-in sound played to the end of the intro, helping you hear when to start playing.

Ex: 4/4

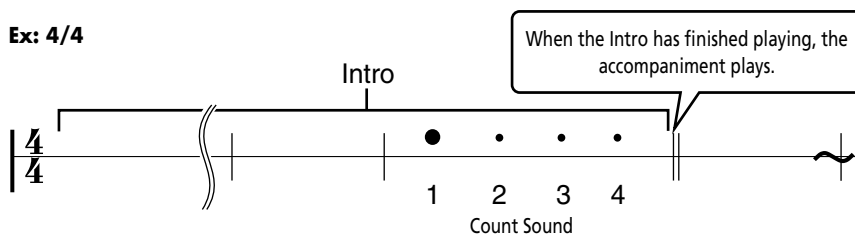

1. Press the [Count/Marker] button and watch the indicator light up.

The following "Countdown settings screen" appears.

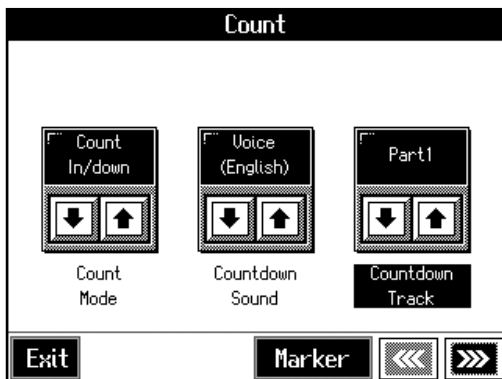

2. Touch <Count Mode> to set this to "Count Down" or "Count In/Down."

When you press the One Touch Program [Arranger] button, the performance starts, and the countdown sound plays at the end of the intro.

○ Cancelling the Countdown

3. Press the [Count/Marker] button and the indicator light goes out.



For more about settings on the Countdown screen, refer to "Changing the Settings for the Count" (p. 131).

Modifying an Accompaniment

When you use Automatic Accompaniment, you can easily add Fill Ins to the accompaniment patterns, change arrangements, and make other changes.

■ Changing the Accompaniment Pattern (Fill In Buttons)

There are two accompaniment patterns: the Original, and a Variation. In addition, a fill-in (or short phrase) is added at the points where the accompaniment patterns change, which adds more interest to the song. It can be effective to use the simpler original pattern for the first half of the song, and the variation pattern for the second half.

What's a "Fill In"?

A short improvisational phrase inserted at the bar line is called a "Fill In." The KR105 automatically plays the appropriate phrase for the selected Music Style.



You can add variation to the Automatic Accompaniment by assigning different functions to the Performance Pads and pedals. For more information, see "Assigning Functions to Pedals and Performance Pads (Pedal Setting/User Functions)" (p. 126).



Press the Fill In [To Variation] button and watch the indicator flash.

The instrument is set so that the variation performance pattern is played.

Press the Fill In [To Original] button and watch the indicator flash.

The instrument is set so that the original performance pattern is played.

Pressing these buttons during a performance inserts a one-bar fill-in at the appropriate place and time.

Adding a Fill-in without Changing the Accompaniment Pattern

You can play only the fill-in, without changing the accompaniment pattern.

Press the lit [To Original] or [To Variation] Fill In button during the performance.

■ Changing Accompaniment Patterns in the Screen

You can change accompaniment patterns in intros, fill-ins, endings, and so on by touching the screen. This lets you enjoy even more advanced performances.

1. Press the One Touch [Arranger] button.

The Arranger basic screen is displayed.

2. Touch <Arranger>.

The following screen appears.

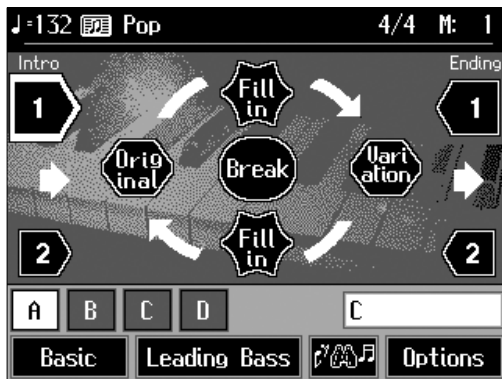

Touch the screen to change the accompaniment pattern.

Leading Bass

The Leading Bass function allows you to change the way the Arranger reads the chords you play. If <Leading Bass> is off, the Acc Bass part plays the root of the chords that feed the Arranger, while the chords of the ACCOMP 1~6 parts are voiced in such a way as to avoid semitone intervals (for complex chords) that wouldn't sound very nice.

Leading Bass function gives you more artistic license because *you* specify the notes played by the Acc Bass part. Switch on <Leading Bass> for songs that rely on bass rather than on chord patterns (for example C – C/B – C/B \flat , etc.).

■ Changing the Instrumental Makeup of Music Styles (Style Orchestrator)

You can change the arrangement of an accompaniment. This function is called “Style Orchestrator.” Each Music Style has four different accompaniment arrangements.



1. Press the [Style Orchestrator] button and watch the indicator light up.
The instrument is set to allow you to change the arrangement with the Performance Pads.
2. Press Performance Pad [1]–[3] to change the arrangement for the accompaniment.
Watch the indicator of the button you pressed light up.

Button	Explanation
1 (Basic)	This is the simplest arrangement.
2 (Advanced)	This is a more involved arrangement.
3 (Full)	This is the most elaborate arrangement.



When you press the [User Function] buttons, the [Style Orchestrator] button's indicator goes out, and the function of the Performance Pads changes. For details refer to p. 66 and p. 126.



When simple Music Styles are selected, there may be no change in the arrangement even when you use the Style Orchestrator function.

Adding Harmony to the Right-Hand Part (Melody Intelligence)

You can add harmony to the notes you play on the keyboard.

While an Automatic Accompaniment is playing, the matching harmony is automatically added to the notes you are playing with the right hand. This function is called "Melody Intelligence."



1. Press the [Melody Intelligence] button and watch the indicator light up.

When you play something on the right-hand section of the keyboard, harmony is added.

The following "Melody Intelligence screen" appears.

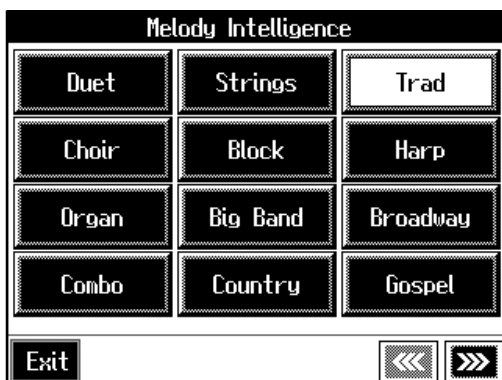

2. Select and touch a harmony type.

Then when you play a melody on the keyboard, a harmony style is automatically added.

When you touch <Exit>, you're returned to the previous screen, while the Melody Intelligence function remains selected.

3. Press the [Melody Intelligence] button once more and the indicator light goes out.

The Melody Intelligence function is cancelled.



With some harmonies, Tones may change automatically. Also, when you play several keys at the same time, in some cases harmony may be added to one note.

Playing Sounds in the Left Hand (Lower Tone)

Normally, when using Automatic Accompaniment in a performance, sounds are not produced by playing the left-hand part of the keyboard. When you touch the <Lower> icon, you can have Tones from the left side of the keyboard play simultaneously with the Automatic Accompaniment.

1. Press the One Touch Program [Arranger] button.

This sets the Automatic Accompaniment.

2. On the Basic screen, touch <Lower>.

Now when you play a chord in the left-hand keyboard area, the notes you play will sound, and the accompaniment chord changes.



Stopping the Sound in the Left-hand

3. Touch <Lower>.

The <Lower> icon returns to the original color.

The lower Tones stop playing.

Playing the Piano with Accompaniment Added (Piano Style Arranger)

Usually with Automatic Accompaniment, you play chords on the left-hand side of the keyboard and the melody on the right-hand side. Chords can also be recognized over the entire keyboard, allowing you to perform using Automatic Accompaniment without splitting the keyboard. This function is called "Piano Style Arranger."

This makes it possible to add an accompaniment automatically as you play a song by playing chords in the ordinary way, without giving any thought to the location of a keyboard split.

1. Press the One Touch Program [Arranger] button.
2. Touch <Split> to turn the Split function off.



3. Select a Music Style (p. 39).
4. Play the keyboard.

The accompaniment starts when you play a chord anywhere on the keyboard.

Adjusting the Volume Balance for Each Part (Balance)

You can adjust the volume balance between the accompaniment and the keyboard, and the volume balance for each of the parts in a Music Style.

■ Changing the Volume Balance between the Accompaniment and the Keyboard (Balance Knob)

You can change the volume balance between a song and accompaniment and the notes you play on the keyboard.

1. Adjust the volume balance with the Balance knob.

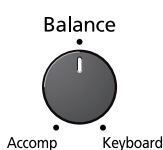

NOTE

When this knob is turned completely to the Accompaniment side, no sounds from the keyboard are audible, even when the keys are pressed. You can usually leave the knob at the center position.

■ Adjusting the Volume Balance for Each Performance Part (Part Balance)

You can adjust the volume of each performance part in a Music Style, and the balance between parts when playing multiple Tones on the keyboard.



1. Press the [Part Balance] button and watch the indicator light up.

The following "Part Balance screen" appears.

Touch <Accomp> or <Keyboard> to switch the two screens.

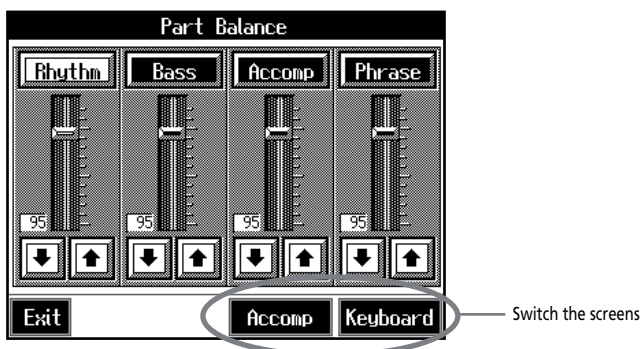

The volume balance between each of the performance parts in the Music Style is indicated.

Display	Performance part
Rhythm	Music Style Rhythm Part
Bass	Bass, Bass Tone (p. 44)
Accomp	Accompaniment 1, Accompaniment 2, Accompaniment 3, Chord Tone (p. 44)
Phrase	Short phrases sounded when the Performance Pads are pressed.

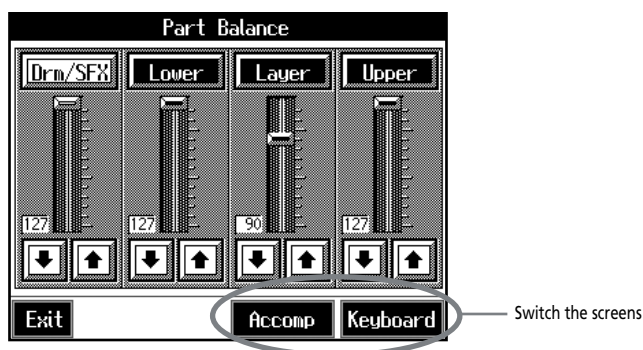

This shows the volume balance between each of the keyboard's Tones when layer performance (p. 25) or split performance (p. 26) are used, or the volume balance when using the keyboard to play percussion instruments or sound effects (p. 22).

Displayed	Tone Part
Drums	Percussion instruments or sound effects played with the keys
Lower	Left-hand Tone
Layer	Layer Tone
Upper	Right-hand Tone

2. Touch each slider to adjust the volume balance.

You can also make these adjustments by touching the adjustment sliders and then using the dial.

Touch <Exit> to go back to the previous screen.

3. Song Playback

Playing a Song

Now, let's try practicing while playing back internal songs, commercial music files, and songs on floppy disk.

You can use rewind or fast-forward to go to any desired measure, and play back from that point.



Selecting the Song

1. Press the [Song/File] button.

The following "Song Selection screen" appears.



Touch and drag up and down in the scroll bar to scroll through the screen and display other songs.

Touch the page icons to change pages.

Finger : The fingering is included in the notation.

Chord : The chords are indicated in the notation.

Lyric : You can display song lyrics.

When you touch , songs selected from all of the internal songs are played in random order.

When you touch , all of the songs in the genre you have selected are played in order, starting from the selected song. When the last song is finished, playback resumes from the first song in the genre.

: The selected song is played back. This changes to while the song is played back; playback stops when you touch .

By touching <File>, you can view information about the song (p. 141) and save songs (p. 87).

: The song genre changes.

MEMO

If there is recorded song data, the "Delete song" screen appears.

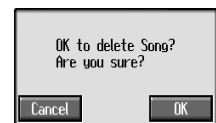

If it's okay to delete the song, touch <OK>. If you do not want to delete the song, touch <Cancel>, and register the song to the Favorites (p. 59).

2. Touch the name of the song to be played back.

You use and the dial to select songs.

Playing back

3. Press the [▶/■ (Play/Stop)] button.

The button indicator lights up, and playback of the song begins.

Stopping the Song

4. Press the [▶/■ (Play/Stop)] button once again.

The button indicator light goes out, and the song stops.

When the song is finished, playback stops automatically.

Press the [◀ (Reset)] button to return to the beginning of the song.

Record/Playback Buttons

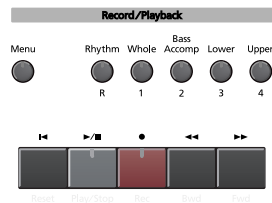

Track buttons (Rhythm, Whole, Bass/Accomp, Lower, Upper):

Each performance part of the song being played back is assigned to a track button. Use these buttons to select the performance parts that are muted or played. For more detailed information, refer to p. 69.

[◀ (Reset)] button: Returns to the beginning of the song.

[▶/■ (Play/Stop)] button:

Plays back the song, or if the song is currently being played, it stops the song.

[● (Rec)] button: Records the performance. For more detailed information, refer to p. 75.

[◀◀ (Bwd)] button: Moves back the playback position of the song one measure each time the button is pressed. When held down, the song “rewinds” continuously.

[▶▶ (Fwd)] button: Advances the playback position of the song one measure each time the button is pressed. When held down, the song is forwarded continuously.

Holding down the [▶/■ (Play/Stop)] button and pressing the [▶▶ (Fwd)] button moves you to the end of the song.

NOTE

When you start playback of songs, the measure number on the Basic screen appears in reverse video. The performance data is being loaded while the indication is highlighted; please wait a few moments for this to be completed.

NOTE

When using markers to specify a section to be repeated (p. 72), you can rewind and fast forward only within the range between Marker A and Marker B.

When Selecting Songs in Folders

1. Touch the folder name.
2. Touch  at the bottom left of the screen.

After a moment, a list of songs in the folder is displayed.

You can also select the folder using the dial or the [◀◀ (Bwd)] or [▶▶ (Fwd)] button on the remote; the folder can then be opened by pressing the [▶/■ (PLAY)] button.

3. Touch a song from the list that appears to select the song you want to play back.

* *Depending on the number of songs contained in a folder, this may take some time.*

NOTE

If a folder contains 500 or more files and/or folders, some of the files and folders may not be displayed.

■ Using Keywords to Search for Songs (Song Search)

You can search for songs that match the conditions you set regarding the song tempo or genre.

You can also search the songs using the first character of the song name.



Only the KR105's internal songs are searchable.

1. Press the [Song/File] button.



2. Touch .

The following screen appears.

Condition Search screen



Name Search screen



Touch here to switch these screens.

○ Searching by Conditions

3. Touch the parameter you want to set, then use the dial to select the search conditions.

With <Data>, songs are searched according to data included in the internal songs.

You can use four different criteria in searches: "Chords," "Lyrics," "Finger" (fingering numbers), and "Any." By selecting a song containing any of this data, then displaying it in the KR105's notation, you can display information about the selected data.

4. Touch <Search>.

The search results appear in the display.

Touch the song name to select the song.

Touch <Exit> to return to the Song Selection screen.

○ Searching by Song Name

3. Touch <By Name>.

Touch <By Key> to return to the Condition Search screen.

4. Decide which character you will use for the search.

The selected character appears in the middle of the screen.

Enter the character you are searching for. For example, touching <ABC> in succession cycles you through the available choices in that character group ("A"→"B"→"C"...).

Touch <A-0> to toggle between alphabets and numerals.

5. Touch <Search>.

The search results appear in the display.

Touch the song name to select the song.

Touch <Exit> several times to return to the previous screen.

Registering the Songs You Like (Favorites)

You can register songs you are currently practicing or enjoy playing to “Favorites,” allowing you to select these songs easily.

Selecting the Song

1. Press the [Song/File] button.

The Song Selection screen appears (p. 54).



2. Touch the song name to select the song to be registered.

Registering to Favorites

3. Touch <Favorites>.

A screen like the one shown below appears.

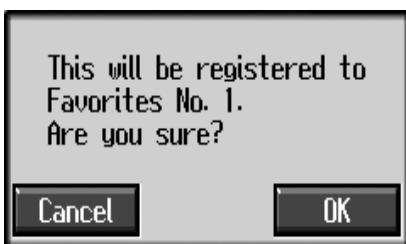

4. Touch <OK>.

The selected song is registered to Favorites.

Now you can select the registered song by selecting Favorites for the genre in the Song Selection screen.

■ Removing Songs From Favorites

This deletes registered songs for Favorites.

1. In the Song Selection screen, select Favorites for the genre.



2. Touch the name of the song to be deleted.
3. Touch .

A screen like the one shown below appears.



4. Touch <OK>.

The song is deleted from the Favorites family.

4. Practice Functions

With the KR105, you can enjoy practice using a variety of functions.

Displaying Scores

The KR105 can display scores not only for the internal songs, but for music files and performances recorded with the KR105. This is very convenient for performing while reading the music and for checking songs that have been recorded. When you play back a music file with lyrics, the lyrics appear on screen.

Selecting the song

When playing back songs on floppy disks, first insert the floppy disk in the disk drive.

1. Press the [Song/File] button to select a song.

For details refer to "Playing a Song" (p. 54).

2. Press the [DigiScore] button.

The "Score screen" appears.

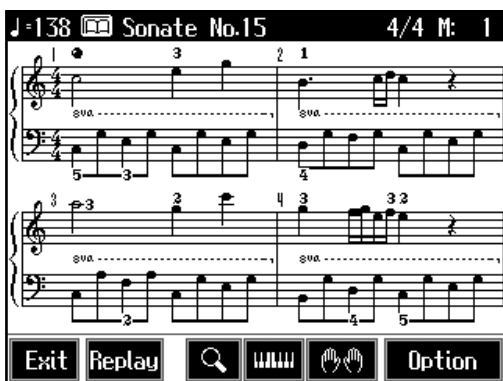

In some internal songs, the fingering is displayed. The fingering numbers shown in the screen indicate one possible fingering.

Icon	Description
	Displays an enlarged score. You can also display the note names.
	The score and keyboard are displayed on the KR105. This allows you to check the keys that are pressed for the sounds played back.
	Selects the part for which the score is displayed. * You can specify the track or part to be displayed with <Option> (p. 64).
<Option>	Makes detailed settings for the score display (p. 64).
<Replay>	The left pedal functions as the "Replay." When you press the pedal during the playback of the song, playback stops, and when you release the pedal, playback resumes starting at the beginning of that measure. When the pedal is pressed in rapid succession, playback is returned the same number of measures as the number of times the pedal is pressed. In situations such as when you want to hear a difficult phrase repeated a number of times, you can press the pedal to go to an earlier point in the song.



Chord names can be displayed in some of the internal songs and recorded performances using the KR105's Chord Sequencer (p. 106).

3. Press the [▶/■ (Play/Stop)] button.

Playback of the song begins, and the score advances along with the progression of the performance.

Notes Regarding the Score Display

- When playback of a song begins,  appears in the Score screen. While this symbol is displayed, performance data is being loaded from floppy disk or internal memory. It may take thirty seconds to a minute or more to read the data. Please wait.
- The displayed scores are based on music files. Priority is placed on the readability of the displayed music, not on the accurate rendition of difficult, high-level performances. Thus, there may be discrepancies seen when compared with commercially available printed music. The display is not intended for viewing advanced songs requiring precisely detailed scores, or complex songs.
- On the score display screen, lyrics and notes may extend beyond the range displayed on the screen and may not be visible.
- Playback may start over from the beginning if you display the score or change the displayed part during playback of the song.

NOTE

No notes are shown in the score if the selected part contains no data. To change the part being displayed, refer to "Making Detailed Settings for the Score Display" (p. 64).

■ Touching Notes to Confirm the Sounds

(Touch the Notes)

In the Score screen, you can have notes played by touching the notes on the screen.

When you touch <  > to show the keyboard on the screen, the touched note is indicated by the corresponding note on the keyboard. This allows you to confirm notes by sight, sound, and touch.

In addition, when you trace part of the score with your finger, the traced segment is played back. This allows you to easily play back phrases you like.

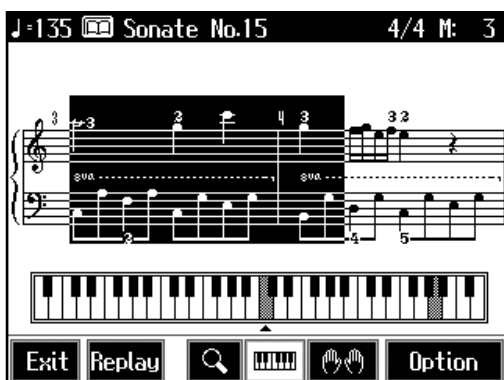

■ Making Detailed Settings for the Score Display

You can change the part appearing on the score display and change the manner in which the score is displayed.

1. Press the [DigiScore] button to display the Score screen.
2. Touch <Option>.

A screen like the one shown below appears.

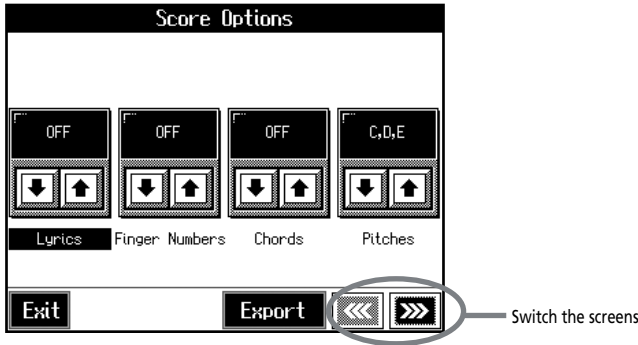

3. Touch   for the parameter being set to select the value.

Touch <Exit> to return to the Score screen.

Item	Setting	
Lyrics Sets whether or not the lyrics appear in the music.	ON	The lyrics are displayed.
	OFF	Not displayed.
Finger Numbers Whether or not the fingering appears in the music.	ON	The fingering is displayed.
	OFF	Not displayed.
Chords Whether or not chord names appear in the music.	ON	The chord names are displayed.
	OFF	Not displayed.
Pitches Sets whether or not the note names appear in the music when the score is expanded.	OFF	Not displayed.
	C, D, E	The pitch names (C, D, E) are displayed.
	Do, Re, Mi (Fixed)	The pitch names (fixed Do) are displayed.
	Do, Re, Mi (Movable)	The syllable names (movable Do) are displayed.
Clef L Determines whether a treble or bass clef is shown in the score for the left-hand part.	Auto	Display is switched automatically.
	G Clef	G (treble) clef is displayed in the score.
	F Clef	F (bass) clef is displayed in the score.
Clef R Determines whether treble or bass clef is shown in the score for the right-hand part.	Auto	Display is switched automatically.
	G Clef	G (treble) clef is displayed in the score.
	F Clef	F (bass) clef is displayed in the score.
Key Score is displayed in the specified key.	Auto	Key is switched automatically.
	b x 5–0– # x 6	Score is displayed in the specified key.



In some internal songs, the fingering is displayed. The fingering numbers shown in the screen indicate one possible fingering.



Chord names can be displayed in some of the internal songs and recorded performances using the KR105's Chord Sequencer (p. 106).

Item	Setting
User Part Selects the part to display when "User" is selected as the part to be displayed.	User Track, Parts 1–16
Lower Part Selects the part to display when "Lower" is selected as the part to be displayed.	Lower Track, Parts 1–16
Upper Part Selects the part to display when "Upper" is selected as the part to be displayed.	Upper Track, Part 1–16

■ Saving Scores as Image Data

You can take scores that are displayed on the KR105 and save them to floppy disks. You can also use saved image data to your computer.

- 1. Insert the floppy disk onto which you want to save the image data in the KR105's disk drive.**

Use a floppy disk formatted on the KR105. For more on formatting disks, refer to p. 85.

- 2. Press the [Song/File] button to select a song.**

- 3. Press the [DigiScore] button.**

The Score screen appears.

- 4. Touch <Option>.**

- 5. Touch <Export>.**

A screen like the one shown below appears.

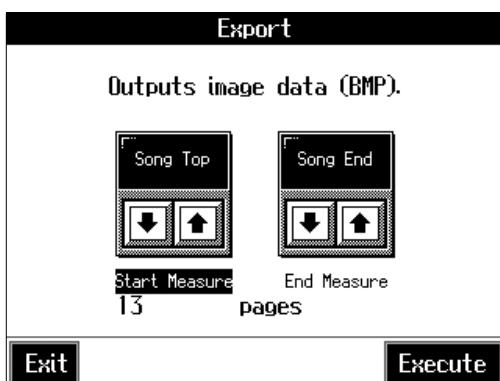

- 6. Touch   for each parameter to set the range of the image data.**

- 7. Touch <Execute>.**

The score is saved to the floppy disk as image data in BMP (bitmap) format.

NOTE

Other than for your own personal enjoyment, use of the scores that are output without the permission of the copyright holder is prohibited by law.

Adjusting the Tempo

This changes the song and Music Style tempos.

If songs seem difficult to play at their original speed, you may find it helpful to first practice with the tempo slowed down. Then, after becoming more familiar with the song, you can practice it at a gradually faster tempo.

Changing the tempo has no effect on the pitch of the notes. And you can change the tempo even when the song is in progress.



Adjusting the Tempo with the Tempo [-] [+] Buttons

Pressing the [+] button once increases the tempo by one unit. Holding down the button makes the tempo increase continuously.

Pressing the [-] button once decreases the tempo by one unit. Holding down the button makes the tempo decrease continuously.

Pressing the [-] [+] buttons simultaneously returns the selected Music Style or song to the basic tempo.

■ Setting the Tempo by Pressing the Button in Time (Tap Tempo)



You can also set the tempo by pressing the Performance Pad. This feature is called "Tap Tempo." By using the Tap Tempo function, you can quickly set the tempo you are thinking of, without specifying the tempo in numerical terms.

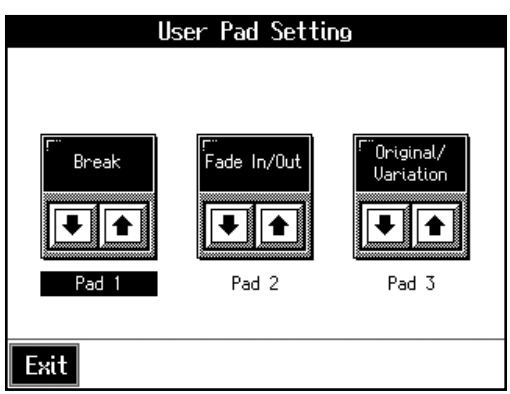

Assigning Functions to the Performance Pads

1. Press the [User Function] button and watch the indicator light up.



2. Touch   for the Performance Pad to which the function is assigned, then select "Tap Tempo."

3. Touch <Exit>; the tempo is indicated in the upper left of the screen.

Specifying the Tempo

4. Press the Pad to which "Tap Tempo" is assigned at least twice.

The tempo is set to the song you used when tapping the button.

■ Playing Back at a Fixed Tempo (Tempo Mute)

If a song has tempo changes, it helps to practice the song first at a steady tempo. Overriding tempo changes is called "Tempo Muting."

1. Hold down the [▶/■ (Play/Stop)] button and press one of the Tempo [-] [+] buttons.

When tempo muting is in effect, the tempo display appears in reverse video.



When you play back the song, it will play at a constant tempo.

Cancel the Tempo Mute Setting

1. Hold down the [▶/■ (Play/Stop)] button and press one of the Tempo [-] [+] buttons.

Tempo muting is canceled.

Tempo Mute will also be cancelled when you select a different song.

MEMO

You can also assign the Tap Tempo function to the pedal, and use the pedal to specify the tempo. For details, refer to "Assigning Functions to Pedals and Performance Pads (Pedal Setting/User Functions)" (p. 126).

Match the Tempo Before You Begin Playing (Count In)

When you're playing along with a song, you can listen to the tempo before you start playing by adding a count-in.

This audible count before the song playback is called a "Count-In."

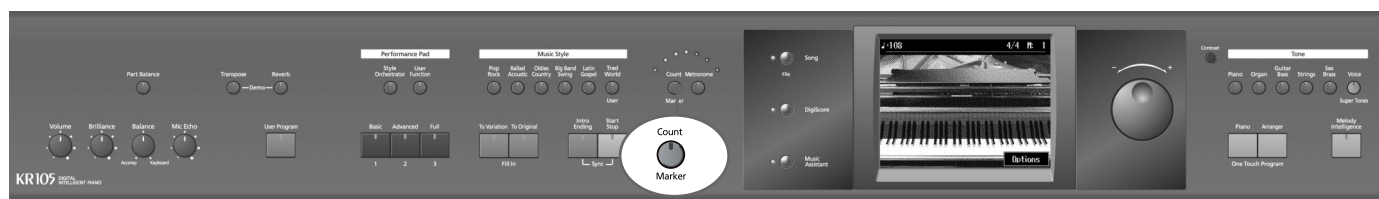

1. Press the [Count/Marker] button and watch the indicator light up.

The following "Count settings screen" appears.

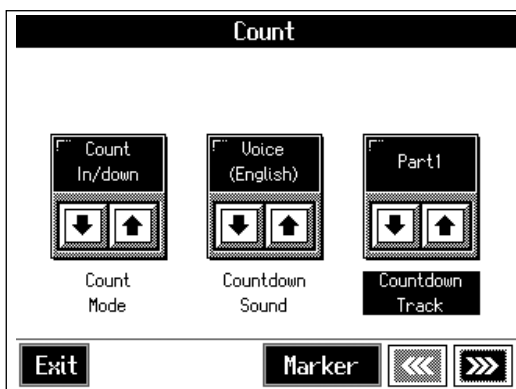

2. Touch <Count Mode> [down arrow] [up arrow] to set this to "Count In" or "Count In/Down."

With this setting, two measures count down before the song playback starts.

Canceling the Count In

1. Press the [Count/Marker] button so its indicator is turned off.

By touching <Exit> instead of the [Count/Mark] button, you can close the Count settings screen without cancelling the count.

MEMO

You can have a count sound be played before the song starts playing back by holding down the [Reset] button while you press the [Play/stop] button. The status of the Count settings won't be affected by your use of this procedure.

MEMO

For more about other settings on the Count settings screen, refer to "Changing the Settings for the Count" (p. 131).

Muting Some Parts Before Playing (Track Buttons)

With commercially available music files for piano lessons, the part for each hand can be played back independently. This makes it easy to practice hands separately. For example, you can follow along with your right hand while you listen to that same right-hand part be played, or you can practice the left-hand part while the right-hand part plays.

A music file for piano lessons may be assigned to the five Track buttons as shown below.

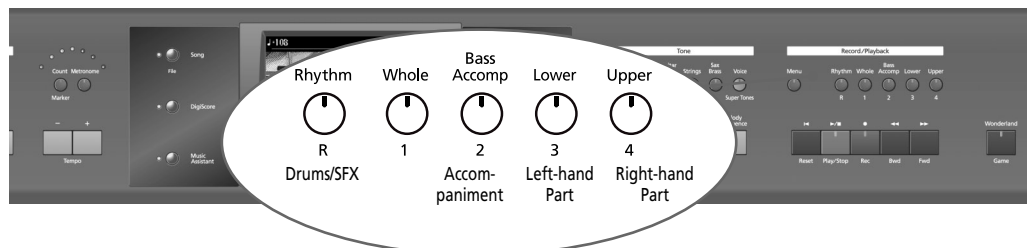

By using these Track buttons, you can eliminate the sound of specific parts. This is referred to as “muting.”

By recording your own performances to the Track Buttons in this fashion, you can mute parts the same way. For details, refer to “Recording While Selecting the Track Buttons (Redoing Recordings)” (p. 81).

1. Select the song that you wish to play back (p. 54).

Selecting the Part that You’ll be Playing

2. Press any one of the Track buttons to make the button’s indicator light go dark.

The sound for the selected part no longer plays.

For example, when practicing the right hand, press the [4/Upper] button.

When you play back the song, the right-hand performance will not sound. Practice your right-hand performance along with the left-hand playback.

Playing Back a Song

3. Press the [▶/■ (Play/Stop)] button.

The song will begin playing back.

The part you selected in step 2 will not sound.

Once again press the button you selected in step 2. The button’s indicator will light up, and the part will be heard once again.

Even while the song is playing, you can press the track buttons to mute or un-mute the sound.

Stopping the Song

4. Press the [▶/■ (Play/Stop)] button.

The song will stop.



For more on music files, refer to “Music Files That the KR105 Can Use” (p. 168).



If a single Track button includes more than one instrument and you want to mute just one of those instruments, take a look at “Modifying the Settings of Each Part” (p. 100).



When a single Part is not played, it is called “Minus One.” Using Minus One, you can mute out a particular instrument and play the part yourself.



When playing back SMF files for Roland Piano Digital series instruments, and the [3/Lower] button and [4/Upper] button do not correctly control the lower/ upper performances, please change the “Track Assign” settings. Please refer to “Changing the Parts Assigned to the Track Buttons During SMF Playback (Track Assign)” (p. 142).



You can adjust the balance between the keyboard and song volume levels. Check out “Adjusting the Volume Balance for Each Performance Part (Part Balance)” (p. 52).

Setting Markers for Repeated Practice (Marker)

By setting markers at points in a song that you want to practice repeatedly, you can then easily go to and repeat play back of the selected measures.

■ Placing a Marker within a Song

You can place two separate markers (Marker A and Marker B) in one song. These markers are placed at the beginning of a measure to make the beginning and end of a section of music. Placing markers is a handy way to start playback at the same place as many times as you like. You can add markers or move to a marker even while playback is in progress.

Access the Marker Screen

First, select the song in which you'll set the markers (p. 54).

1. Press the [Count/Marker] button.
2. Touch <Marker>.

The Marker screen appears.

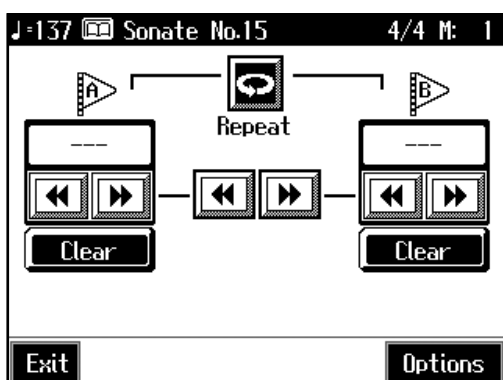

Placing Markers

3. Go to the measure where you want to set a marker using the [◀◀ (Bwd)] and [▶▶ (Fwd)] buttons.
4. Touch <- -> for Marker A.
Marker A is placed at the beginning of the measure you selected.
"- - -" on the screen will change to the number of the measure where you placed the marker.
5. In the same way, touch the Marker B <- -> to set Marker B.

It is not possible to assign marker B to the same location or a measure before marker A.



Markers can also be assigned in units of beats rather than measures. Refer to "Placing a Marker in the Middle of a Measure" (p. 131).

■ Playback from a Marker Location

1. At the marker screen, touch the measure number of the marker you want to go to.

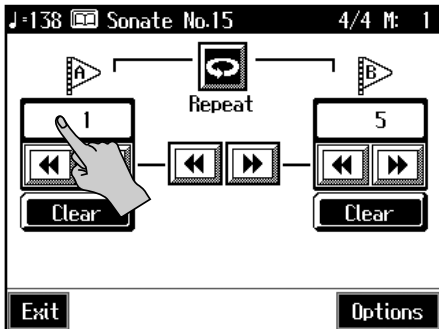

Playback will start from wherever Marker A or Marker B are set.

With the song playing back, playback will continue if you touch Marker A or Marker B on the Marker screen.

■ Erasing a Marker

1. Touch <Clear> for the marker you want to erase.

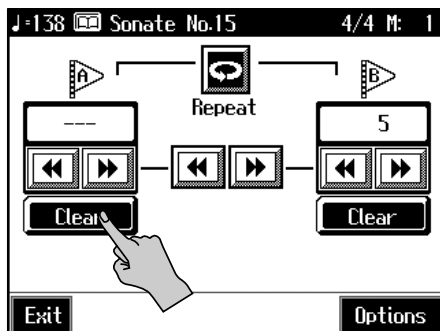



The marker disappears and the on-screen display changes to <--->.

■ Moving a Marker

You can move a marker that has been placed in a song. You can also move the section of music defined by Markers A and B forward or back, without changing the number of measures of marked.

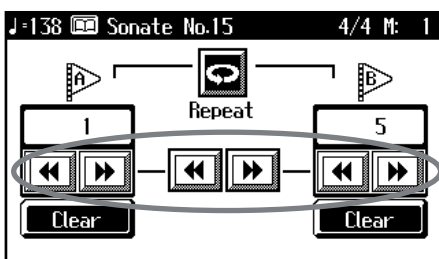
1. On the Marker screen, touch  or  for the marker to be moved.



When you touch , the marker is moved to a previous part of the song.

When you touch , the marker is moved to a later part of the song.

Moving Markers A and B without Changing the Interval Between Them

1. On the Marker screen, touch  or  in the middle of the screen.

For example, if you have Marker A set at the beginning of the fifth measure, and

Marker B set at the beginning of the ninth measure, when you touch , Marker A is moved to the beginning of the first measure, and Marker B is moved to the beginning of the fifth measure.

Touch  to shift Marker A to the beginning of the ninth measure and Marker B to the beginning of the thirteenth measure.

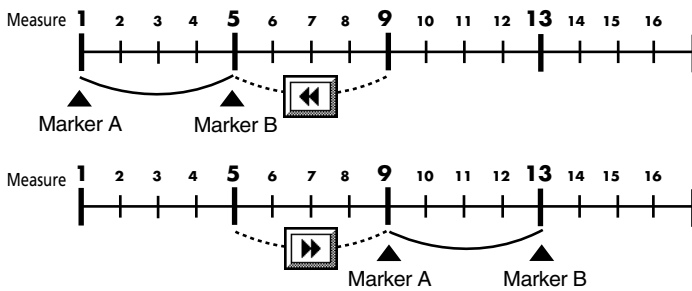

■ Playing Back the Same Passage Over and Over

You can play back a particular passage over and over. This is convenient when you want to focus on a passage.

1. First, set Marker A and Marker B to define the measures you want to repeat.

For instance, suppose you want to play back the passage from the fifth through eighth measures over and over. You should place Marker A at the beginning of the fifth bar and Marker B at the beginning of the ninth bar.

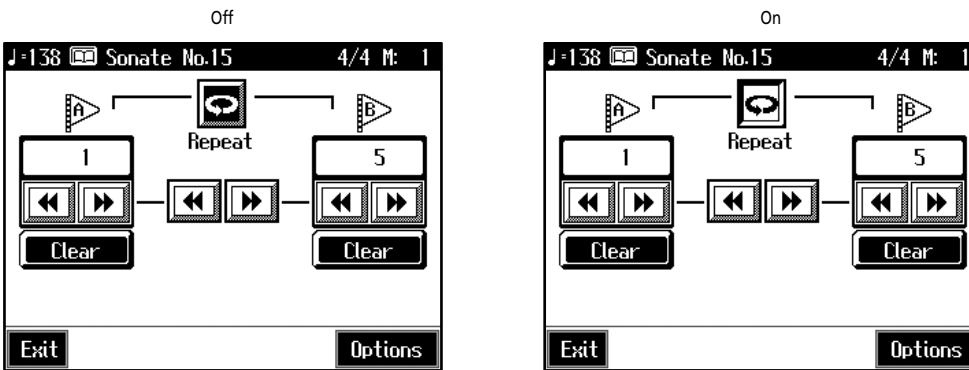

2. Touch <Repeat> in the Marker screen.

The setting is made for repeated playback of the passage from marker A to marker B. When you play the song, the marked section of music plays back repeatedly.

Cancelling Repeat Playback

3. Touch <Repeat> in the Marker screen, and the icon returns to the original color.

Repeat playback is cancelled.



When <Repeat> is On

- If neither Marker A nor Marker B is set, the song is played back from the beginning to the end.
- If you only place marker A, playback repeats from marker A to the end of the song.
- If you only place marker B, playback repeats from the beginning of the song to marker B.

Transposing Keyboard Sounds and Songs Played Back (Transpose)

By using the “Transpose function,” you can transpose your performance without changing the notes you play. For example, even if the song is in a difficult key with many sharps (#) or flats (b), you can transpose it to a key that is easier for you to read and play.

You can also use this function to play back a song in a different key.

When accompanying a vocalist, you can easily transpose the pitch to a range that is comfortable for the singer, while still playing the notes as written (i.e., with the same fingering positions).





First make sure you have selected the song to be transposed (p. 54).

1. Press the [Transpose] button.

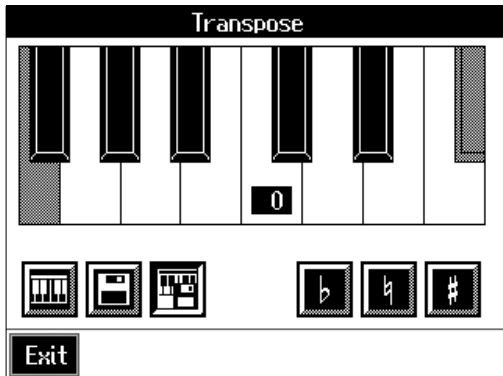

A “Transpose screen” like the one below appears.



2. Touch the Transpose icon.

Icon	Target	Settings Value
	Keyboard sound	-6~0~5
	Song to be played back	-24~0~24
	Keyboard sounds, songs being played back	-6~0~5

3. Touch the screen keyboard or , to select the transposition value.

Each time you press  or , it transposes the key by a semitone.

When you touch , a value of "0" is set.

You can also use the dial to change the transposition value.

When you transpose a song or the keyboard, the [Transpose] button's indicator lights up. As you play the keyboard or play back the song, the notes are transposed.

When you touch <Exit>, the transposition remains in effect, and you're returned to the previous screen.

Cancelling Transposition

4. Press the [Transpose] button and the indicator light goes out.

Transposition is cancelled.

The next time you press the [Transpose] button, illuminating the indicator, the music is transposed by the value set here.



The transposition value reverts to "0" when you turn off the power or select another song.

Example: Playing a song in E major while playing the keys for C major

In this example, C is the root note in the key of C major. E, the root of E major, is the

third in C major. It is up four keys, including the black keys, so touch , then enter "4" for the setting.

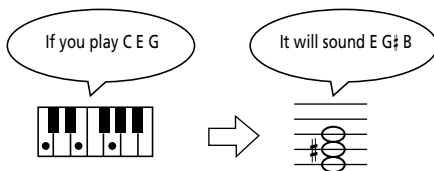

5. Recording and Saving the Performance

You can easily record performances using the five track buttons.

A recorded performance can be played back to listen to your own playing, or to add additional parts.

You can use the KR105 to make the following kinds of recordings.

- Recording just your own keyboard performance → “Recording a New Song (New Song)” (p. 76)
- Recording performances using Automatic Accompaniment → “Recording With Accompaniment” (p. 78)
- Recording along with the internal songs → “Recording Along with a Song” (p. 80)
- Re-recording → “Recording While Selecting the Track Buttons (Redoing Recordings)” (p. 81)

○ If the Following Screen Appears

If you’ve recorded a song or changed a song’s settings (see p. 100), the following message appears on the screen when you try to choose another song.



If it’s okay to delete the song, touch <OK>.

If you do not want to delete the song, touch <Cancel>, and either save the song (p. 87) or register the song to the Favorites (p. 59).

NOTE

Recorded performances are discarded when another song is selected, or when the power is turned off. Be sure to save important performances. Take a look at “Saving Songs” (p. 87).

Recording a New Song (New Song)

This records keyboard performances without the use of the internal songs or Automatic Accompaniment.



Settings for Recording Performances

1. Press One Touch Program [Piano] button.

This sets the KR105 for performance without the use of Automatic Accompaniment.

2. Decide on the tone of the performance (p. 21).

Use the Tone buttons and the touch screen to select the tone. When you have finished choosing the settings, touch <Exit> to display the Basic screen.

Recording Settings

3. Press the [● (Rec)] button.

You press the [● (Rec)] button and the following messages will appear, when a song has already been recorded.



Touch <New Song>.

This switches the KR105 to the settings required for recording a new song.

The KR105 is put in recording standby.

To cancel recording, press the [● (Rec)] button once more.

4. Decide on the tempo and beat.

If necessary, press the [Metronome] button to play the metronome.

When you have finished making the settings, touch <Exit> to display the Basic screen.

MEMO

If you select <New Song> when a song has already been recorded, the "OK to delete song?" prompt appears in the screen. For more detailed information, refer to "If the Following Screen Appears" (p. 75).

Start Recording

5. Press the [▶/■ (Play/Stop)] button.

A two-bar count-in plays, then recording starts.

Even without pressing the [▶/■ (Play/Stop)] button, recording starts when you play the keyboard. There is no count-in played when you start by playing rather than pushing the [▶/■ (Play/Stop)] button.

When recording starts, the [▶/■ (Play/Stop)] and [● (Rec)] buttons' indicators light up.

Stop Recording

6. Press the [▶/■ (Play/Stop)] button.

Recording stops.

The performance is recorded to the [1/Whole] button.

Listening to the Recorded Performance

7. Press the [◀ (Reset)] button, then press the [▶/■ (Play/Stop)] button.

The recorded performance is played back.

When you press the [▶/■ (Play/Stop)] button, playback stops.

NOTE

Any performance that has been recorded is deleted when the power to the KR105 is turned off. If you do not want a performance deleted, then save it to Favorites. Refer to "Saving Songs" (p. 87).

Track buttons assignments for recorded performances

When you record only a keyboard performance, the performance will be assigned to the track buttons as follows.

- **Normal performance (playing a single Tone from the entire keyboard)**
The performance is recorded to the [1/Whole] button.
- **Layer performance**
The performance is recorded to the [2/Bass/Accomp] button.
- **Split performance**
The lower part of the keyboard is recorded to the [3/Lower] button, and the upper part of the keyboard is recorded to the [4/Upper] button.
- **Layer performance and Split performance**
The performance played in the left side of the keyboard is recorded to the [3/Lower] button, the performance in the right side to the [4/Upper] button, and the Layer performance to the [2/Bass/Accomp] button.
- **Drum set or sound effect performance**
Recorded on the [R/Rhythm] button.

Recording With Accompaniment

Try recording a performance along with the Automatic Accompaniment.

Settings for Recording Performances

1. Press the One Touch Program [Arranger] button.

This chooses the setting for Automatic Accompaniment.

2. Decide on the Music Style.

When you have finished choosing the settings, touche <Exit> to display the Basic screen.

Recording Settings

3. Press the [● (Rec)] button.

You press the [● (Rec)] button and the following messages will appear, when a song has already been recorded.



Touch <New Song>.

This switches the KR105 to the settings required for recording a new song.

The KR105 is put in recording standby.

To cancel recording, press the [● (Rec)] button once more.

4. Decide on the tempo.

Start Recording

5. Play a chord on the lower part of the keyboard.

An Automatic Accompaniment intro starts, and recording starts at the same time.

Stop Recording

6. Press the [Intro/Ending] button.

An ending plays, then the Automatic Accompaniment, and recording stop at the same time.

Listening to the Recorded Performance

7. Press the [⏪ (Reset)] button, then press the [▶/■ (Play/Stop)] button.

The recorded performance plays back.

When you press the [▶/■ (Play/Stop)] button, playback stops.



If you select <New Song> when a song has already been recorded, the "OK to delete song?" prompt appears in the screen. For more detailed information, refer to "If the Following Screen Appears" (p. 75).



You can change how recording is stopped when recording a performance with Automatic Accompaniment. To learn how, see "Changing How Recording Stops" (p. 82).

Track buttons assignments for recorded performances

Performances that have been recorded using Automatic Accompaniment are assigned to the track buttons as shown below.

Track button	Performance Recorded
[R/Rhythm]	The rhythm part of an Automatic Accompaniment is recorded here. In addition, drum sets and effect sounds that are selected with the keys in a performance are recorded to this track.
[1/Whole]	When using Piano Style accompaniment (p. 51), the performance played on the keyboard is recorded here.
[2/ Bass Accomp]	The Automatic Accompaniment bass part and accompaniment part are recorded here.
[3/Lower]	When the KR105 is set so that sounds from performances on the left-hand side of the keyboard are played while the Automatic Accompaniment sounds (p. 50), your own performance on the left-hand side of the keyboard is recorded here.
[4/Upper]	Your own performance on the right-hand side of the keyboard is recorded here.



Music Styles are composed of eight parts. For details, refer to "Music Styles and Automatic Accompaniment" (p. 35).

Recording Along with a Song

Try recording along with internal songs and songs on floppy disk.
Here, record your right-hand performance along with the song accompaniment.

Settings for Recording Performances

Select a song before you begin recording.
When you have selected the song, press the [DigiScore] button to display the notation.
For more on how to select songs, refer to p. 54; for instructions on displaying the notation, refer to p. 61.

1. Decide on the tone and tempo of the performance.

After choosing the settings, touch <Exit> to display the Basic screen.

Recording Settings

2. Press the [● (Rec)] button.

A screen like the one shown below appears.



3. Touch <Add On>.

With this setting, you can record while listening to the selected song.

Selecting the Track to Record

4. Press the track button for the track that you want to record (i.e., the track that you want to play yourself).

The indicator of the button you pressed will blink, and the KR105 enters recording-standby mode.

Since in this example we will record the upper part performance, press the [4/Upper] button to make the button's indicator light blink.

To cancel recording, press the [● (Rec)] button once more.

Start Recording

5. Press the [▶/■ (Play/Stop)] button.

A two-bar count-in plays, then recording starts.

Even without pressing the [▶/■ (Play/Stop)] button, recording starts when you play the keyboard. There is no count-in played when you start by playing the keyboard instead of pushing the [▶/■ (Play/Stop)] button.

When recording starts, the [▶/■ (Play/Stop)] and [● (Rec)] buttons' indicators light.

Stop Recording

6. Press the [▶/■ (Play/Stop)] button.

Recording stops.



The song tempo is stored within the song you selected.



Only drum sets or SFX set are recorded to the [R/Rhythm] button.

Listening to the Recorded Performance

7. Press the [⏪ (Reset)] button, then press the [▶/■ (Play/Stop)] button.

The recorded performance is played back.

When you press the [▶/■ (Play/Stop)] button, recording stops.

Recording While Selecting the Track Buttons (Redoing Recordings)

When you want to re-record, specify the Track button for the performance you want to re-record, and then record again.

When you select a previously recorded Track button and re-record, everything from the point at which you begin recording up to the point where you stop recording will be replaced by the newly re-recorded performance.

1. Use the [⏪ (Bwd)] and [⏩ (Fwd)] buttons to go to the measure where you want to begin recording.

2. Press the [● (Rec)] button.

A screen like the one shown below appears.



3. Touch <Add on>.
4. Press the Track button for the track you want to re-record.

The indicator for the selected Track button starts blinking.

The [▶/■ (Play/Stop)] button's indicator flashes, and the KR105 is put in recording standby.

To cancel recording, press the [● (Rec)] button once more.

5. Press the [▶/■ (Play/Stop)] button to begin recording.

Rerecording the Accompaniment Part of Automatic Accompaniment

When rerecording an Automatic Accompaniment performance, set Sync Start (p. 43), then specify a chord or press the [Start/Stop] button.

6. Press the [▶/■ (Play/Stop)] button to stop recording.

If you also want to rerecord the ending of the Automatic Accompaniment, press the [Intro/Ending] button.



When you want to record over again after deleting all of the previous recording, refer to "Erasing Recorded Performances" (p. 82).



The song tempo is stored within the song you selected. If you want to change the tempo of the recorded song, refer to "Changing the Tempo of Recorded Songs" (p. 114) and "Changing the Tempo Within the Song" (p. 114).

Erasing Recorded Performances

You can use the following method to delete a recorded performance.

1. Hold down the [Song/File] button and press the [● (Rec)] button.

A screen like the one shown below appears.



2. Touch <OK>.

This deletes the recorded song.

When you touch <Cancel>, the previous screen appears and the recorded song is not erased.

Erasing the Performance on Specific Tracks

You can select and erase performances on specific tracks.

1. Hold down the Track button for the track containing the performance you want to erase, then press the [● (Rec)] button.

The Track button's light goes dark, and the recorded music is erased.

Changing How Recording Stops

When recording an Automatic Accompaniment performance, you can change the accompaniment and the way recording mode stops.

1. Press the [Menu] button and watch the indicator light up.

The Menu screen appears.

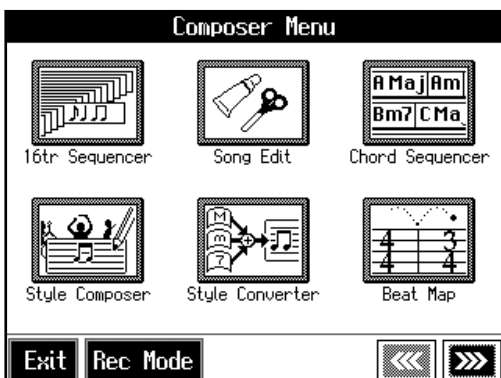

2. Touch <Rec Mode>.

A screen like the one shown below appears.

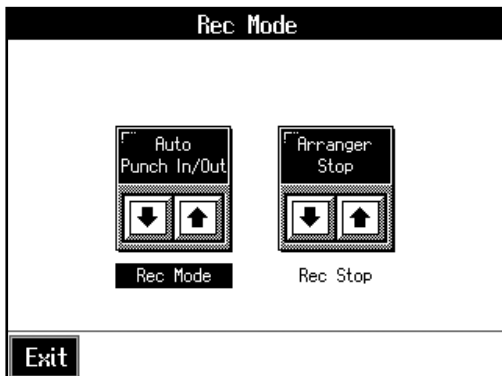

3. Touch <Rec Stop> to switch between "Arranger Stop" and "Composer Stop."

Display	Explanation
Arranger Stop	Recording stops at the same time the Automatic Accompaniment stops.
Composer Stop	Recording does not stop, even when the Automatic Accompaniment stops. When you press the [▶ / ■ (Play/Stop)] button, recording stops.

Recording Songs Starting with Pickups

You can record songs that start with pickup beats (songs that start on a beat other than the measure's first beat).

Count Sound

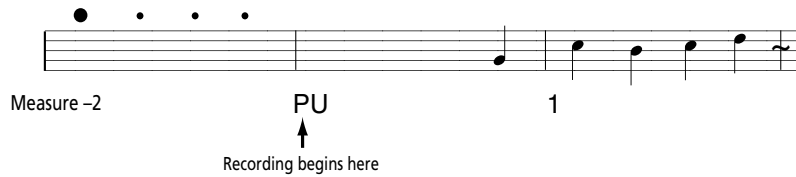

Carry out Steps 1–4 on p. 76 to prepare for recording.

If the [● (Rec)] button's indicator is not lit, press the [● (Rec)] button so the indicator is lit.

The KR105 is put in recording standby.

1. Press the [◀◀ (Bwd)] button once.

The measure number in the upper right of the Basic screen changes to "PU," and the KR105 is set to record a song starting with a pickup.



Start recording. After a one-measure count, recording begins.

Using Floppy Disks

You can use the KR105's disk drive to save songs to floppy disks and listen to commercial music files.

■ Inserting and Ejecting a Floppy Disk

Inserting a floppy disk

1. With the front of the floppy disk facing up, insert the disk in the disk drive slot until there is an audible click.

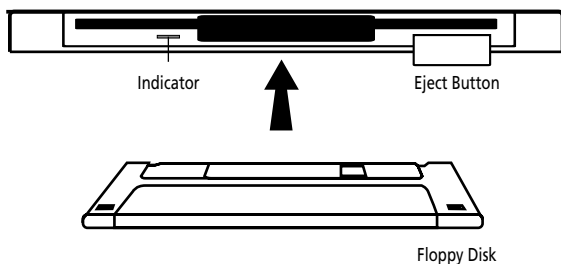

Removing a floppy disk

2. Press the Eject button.

The end of the floppy disk comes out of the slot. Grasp the edge of the floppy disk and gently pull it out.

■ Formatting Floppy Disks (Format)

A newly purchased floppy disk, or a floppy disk that has been used by another device cannot be used as is. Such floppy disks must be "formatted" (initialized) for use with the KR105.

If a floppy disk is in a format that doesn't match the format of this unit, you won't be able to use that floppy disk.

MEMO

If you're using the disk drive for the first time, be sure to read the important notes on p. 6.

NOTE

Never remove the disk while it is being read or written.

Doing so will scratch the magnetic surface of the disk, making it unusable. (The disk drive indicator will light brightly while data is being read or written. Normally, it will be lit dimly or will be dark.)

NOTE

When a floppy disk is initialized, all of the data saved on the disk is erased.

If you're formatting a used floppy disk for reuse, be sure to check first to make sure the disk doesn't contain any data you don't want to lose.



First make sure that the protect tab of the floppy disk is in the "Write (write enable)" position.

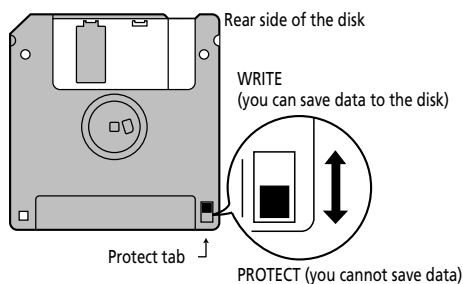

1. Insert the floppy disk into the disk drive.
2. Press the [Song/File] button.
3. Touch <File>.

A "Song File Menu" screen like the one below appears.

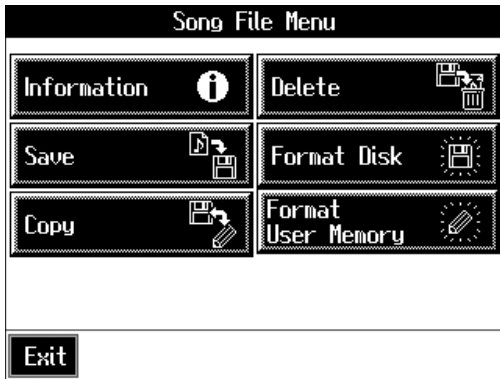

4. Touch <Format Disk>.

The following screen appears.



5. Touch <OK>.

Initialization of the disk begins.

Touch <Cancel> to go back to the previous screen.

When initialization is completed, you're returned to the previous screen.

NOTE

Don't try to take the floppy disk out of the disk drive until the formatting process is finished.

NOTE

If "Error" appears on screen, take a look at "Error Messages" (p. 155).

Saving Songs

A recorded performance is discarded when you switch off the power or choose another song. Storing recorded performances and other data to floppy disks or the Favorites is called "saving." Be sure to save important songs to floppy disks or Favorites.

What are "Favorites?"

You can register songs you are currently practicing or particularly like to "Favorites," allowing you to select these songs easily (p. 59).

On the KR105, when you register a song on a floppy disk to Favorites, you can then play back the song without inserting the floppy disk in the disk drive.

If a recorded performance is saved to Favorites, the performance won't be erased when the power is turned off.

Preparations for Saving Data

When saving to floppy disks, first check to make sure that the floppy disk's protect tab is set to the "Write" position (p. 85), then insert the floppy disk in the disk drive.

1. Press the [Song/File] button.
2. Touch <File>.
3. Touch <Save>.

The following "Save Song" screen appears.

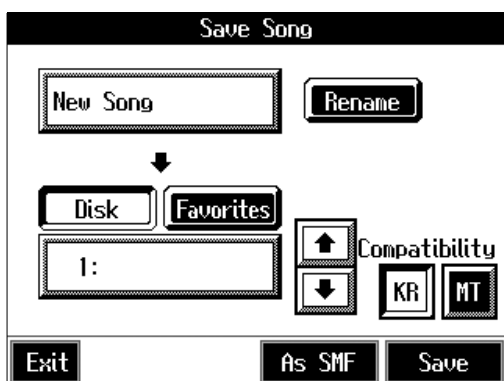

MEMO

When using a new floppy disk, first initialize (format) the disk on the KR105. Take a look at "Formatting Floppy Disks (Format)" (p. 85).

NOTE

Some commercially available music files cannot be saved because they are copy protected.

MEMO

If not handled with care, a floppy disk can be damaged, or the data on it become corrupted, making playback impossible. We recommend saving your songs on two different floppy disks.

MEMO

When you want to clear all of the content saved to the "Favorites" and restore the settings to the original factory condition on the KR105, refer to "Formatting the User Memory" (p. 139).

Determining the name of the song to be saved

4. Touch <Rename>.

The following "Rename screen" appears.

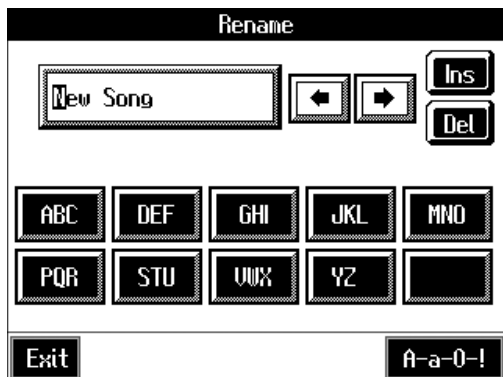

When you touch  , the cursor moves.

When you touch the icon for the letter or character to be input, the character appears at the cursor location. For example touching <ABC> in succession cycles you through the available choices in that character group ("A" → "B" → "C" ...).

Each touch of <A-a-0-!> cycles the type of characters through "English (upper case)," "English (lower case)," "numerals," "symbols," then back to "English (upper case)." When you touch , the character at the cursor position is deleted.

When you touch <Ins>, a space is inserted at the cursor position.

5. When you have finished with the name, touch <Exit>.

Determining the Save Destination

6. Touch <Disk> or <Favorites>.

Touch <Disk> if you are saving to a floppy disk; touch <Favorites> if you are saving to Favorites.

7. Touch to select the save-destination song number.

If a song name is displayed with a number a song is already saved to that number. If you select a number with a previously saved song and then proceed to save a new song, the previously saved song will be erased. If you do not want to lose a saved song, select a number with no song name indicated in the save-destination column.

Selecting the tone compatibility format (when saving to disks)

8. Touch <KR> or <MT>.

Some Tones are unique to the KR105. Data that is recorded using these tones may not play back correctly on other Roland Digital Pianos or Music Players. When you want to save data so that it can be played back on another devices, save the data with "MT" set as the Tone compatibility format.

Display	Explanation
KR	The song is saved as data capable of reproducing performances with richness of expression using the KR105's special Tones.
MT	Data is saved in a form that can also be played on the Roland Digital Pianos or Music Players other than the KR105. You can listen to songs saved in this format on the Roland HP-G/R series and KR series keyboards as well as on Roland MT series devices.

<Note>

When data saved with "MT" as the Tone compatibility format is played back on this instrument, some of the nuances that were part of the performance at the time the data was recorded may be altered.

Even with data saved with "MT" as the Tone compatibility format, an exact reproduction of the original performance may be unobtainable when using GS devices other than Roland Pianos and Music Players.

Save

9. Touch <Save> or <As SMF> to start saving.

The resulting file format will be different depending on whether <Save> or <As SMF> is chosen, as described below.

Display	Explanation
Save	Saves the song in KR105 format. You can listen to songs saved in this format on the Roland HP-G/R series and KR series keyboards as well as on Roland MT series devices. This format is called "i-format".
Save As SMF	Saves the song as an SMF (Standard MIDI Files). Songs saved in this SMF format can be listened to on many instruments that can play SMF music files (p. 168). A song recorded using commercial music files can't be saved in "Save As SMF" format for reasons of copyright protection.

The time required for saving ranges from several seconds to half a minute or more. Don't take the floppy disk out of the disk drive until the saving process is finished. Touch <Exit> to return to the Song File screen.

NOTE

You can only save songs in one format on a single floppy disk.

NOTE

Never turn off the power while the saving operation is in progress. Doing so will damage the KR105's internal memory, making it unusable.

MEMO

It's a good idea to get into the habit of moving the write-protect tab on the floppy disk to the "Protect" position when you've finished saving your data. Keeping the tab at "Protect" prevents operations that could erase your songs by mistake.

NOTE

Depending on the playback instrument, some notes may drop out or sound different.

Deleting Saved Songs

This deletes songs that have been saved on floppy disks, or to Favorites. To delete a song on a floppy disk, first insert the floppy disk in the disk drive.

1. Press the [Song/File] button.

2. Touch <File>.

The "Song File screen" appears.



3. Touch <Delete>.

A "Delete Song screen" appears.



4. Touch <Disk> or <Favorites>.

Touch <Disk> if you are deleting a song from a floppy disk; touch <Favorites> if you are deleting a song from Favorites.

5. Touch   to select the song to be deleted.

6. Touch <Delete>.

A screen like the one shown below appears.



7. Touch <OK>.

The selected song is deleted.

Do not eject the floppy disk from the disk drive until the operation is finished.

Touching <Cancel> cancels the operation.

Touch <Exit> to return to the Song File screen.

NOTE

Never turn off the power while the operation is in progress. Doing so will damage the KR105's internal memory, making it unusable.

Copying Songs on Disks to Favorites

You can take songs saved on floppy disks and copy them to Favorites.

You can also copy songs in Favorites to floppy disks.

1. Insert the disk with the song to be copied in the disk drive.
2. Press the [Song/File] button.
3. Touch <File>.
4. Touch <Copy>.

The following "Copy Song screen" appears.

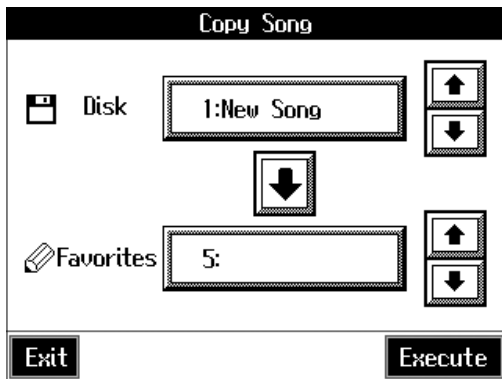



Specifying the Copy Source

5. Touch the <Disk>   to select the song you want to copy.

When "Copy All" is selected, all of the songs on the disk are copied to Favorites.

Specifying the Copy Destination

6. Touch <Favorites>   to select the copy destination for the song.

If a song name is displayed with a number, a song is already saved to that number.

If you select a number with previously saved song data and proceed to copy to that location, the previously saved song will be erased. If you don't want to erase a previously saved song, choose a number with no song name appears in the destination column.

7. Touch <Execute>.

Do not eject the floppy disk from the disk drive until the copy is finished.

The song from the disk is copied to Favorites.

NOTE

Never turn off the power while the operation is in progress. Doing so will damage the KR105's internal memory, making it unusable.

■ Copying Songs Saved in Favorites to Disks

Songs that've been saved to Favorites can be copied onto floppy disks.

In this case, in the "Copy Song screen" in Step 4 above, touch the large arrow icon in the center to point the arrow upwards. This sets the KR105 to copy the song in Favorites to the floppy disk.

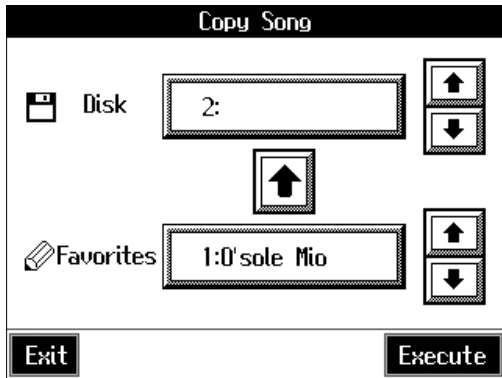

The rest of the procedure is identical to that used for copying songs from floppy disks to Favorites.

MEMO

Some song data cannot copy because they are copy protected.

6. User Program Registration

Saving Performance Settings (User Program)

Any collection of settings, including those describing the current status of your data selections or settings Automatic Accompaniment, can be saved to the [User Program] button. You can then call up the stored settings by pressing the [User Program] button. Saving your preferred combinations of Music Styles and Tones, as well as other frequently used settings, makes it more convenient.

You can register up to 36 User Programs to the KR105.

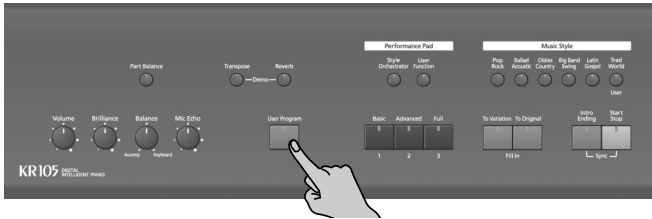

→ For more on what can be registered to a User Program, refer to "Parameters Stored in the User Program" (p. 167).

1. Set the Music Style, Tone, and other data until the settings are the way you want them.
2. Press the [User Program] button.

A "User Program screen" like the one shown below appears.



3. Touch <Write>.

A "Write User Program screen" like the following appears.

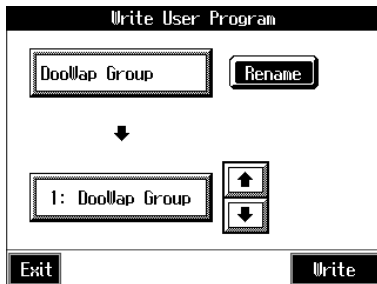

Determining the name of the User Programs

4. Touch <Rename>.

A "Rename screen" like the following appears.

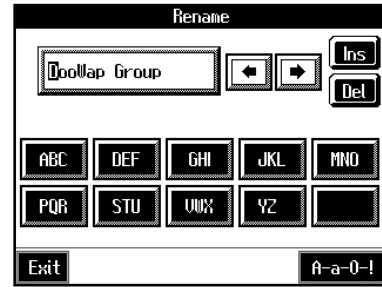

When you touch  , the cursor moves.

When you touch the icon for the character to be input, the character appears of the cursor position.

For example, touching the <ABC> icon in succession cycles you through the available choices in that character group (A→B→C→A...).

Each touch of <A-a-0-!> cycles the type of characters through "English (upper case)," "English (lower case)," "numerals," "symbols," then back to "English (upper case)."



When you touch , the character at the cursor position is deleted.

When you touch <Ins>, a space is inserted at the cursor position.

5. When you have finished with the name, touch <Exit>.

You're returned to the Write User Program screen.

Determining the Write Destination

6. Touch   to select the write-destination number.

7. Touch <Write>.

The current performance settings are saved to the [User Program] button.

→ Never turn off the power while the display indicates <Writing...>. Doing so will damage the KR105's internal memory, making it unusable.P

→ You can restore the content registered to the [User Program] button to the original factory settings. Refer to "Restoring the Factory Settings (Factory Reset)" (p. 138).

Calling Up Saved User Programs

You can easily call up settings saved to the [User Program] button.

1. Press the [User Program] button.

The "User Program screen" appears. Touch the scroll bar and drag up or down to scroll through the screen and display other name of User Programs.

Touch the page icons < [Up Arrow] > < [Down Arrow] > to change pages.

2. Touch the name of the User Program you want to call up.

When you touch the name of the User Program, the buttons or other performance settings instantly change to the previously saved settings.

Changing the Way User Programs Are Called Up

When calling up User Programs, you can prevent the settings for Automatic Accompaniment from switching by not touching the touch screen for a few moments.

- 1. Press the [User Program] button.**
- 2. Press the [Option] button.**

A settings screen like the following appears.

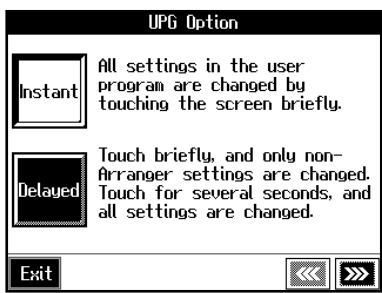

3. Touch <Instant> or <Delayed> to select the setting.

Display	Explanation
Instant	Immediately after a User Program name is touched, the Automatic Accompaniment settings also switch.
Delayed	The Automatic Accompaniment settings switch after you touch and read the User Program name for a few moments.

Touch <Exit> to return to the User Program screen.

Saving the User Program Sets

You can take the 36 User Programs saved to the [User Program] button and save them as a set to a floppy disk, or to user memory.

When saving to a floppy disk, first insert a floppy disk in the disk drive.

→For more on working with the disk drive, refer to "Using Floppy Disks" (p. 85).

- 1. Press the [User Program] button.**
- 2. Touch <File>.**
- 3. Touch <Save>.**

A "Save User Program screen" like the following appears.

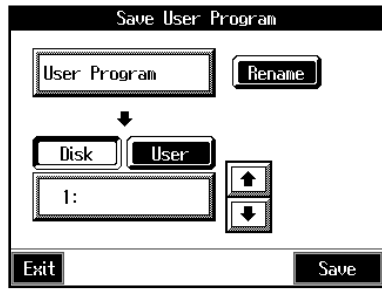

Giving a name to a set of User Programs

4. Touch <Rename>.

The Rename screen appears.

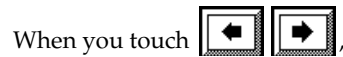

When you touch the icon for the character to be input, the character appears at the cursor position. For example touching the <ABC> icon in succession cycles you through the available choices in that character group (A→B→C→A...).

Each touch of <A-a-0!> cycles the type of characters through "English (upper case)," "English (lower case)," "numerals," "symbols," then back to "English (upper case)."

When you touch , the character at the cursor position is deleted.

When you touch <Ins>, a space is inserted at the cursor position.

5. When you have finished with the name, touch <Exit>.

Determining the save destination

6. Touch <Disk> or <User>.

Touch <Disk> if you are saving to a floppy disk; touch <User> if you are saving to user memory.

7. Touch to select the save-destination User Program number.

If a User Program set name is displayed, a User Program set saved to that saved to that number is already.

If you select a number with previously saved User Program set data, then save a new set of data to that same number, the older User Program set will be deleted. If you don't want to lose any previously saved User Programs, select a number in the save-destination column that does not yet have a name.

Save

8. Touch <Save> to begin the save.

Touch <Exit> to return to the User Program File screen.

* *Never turn off the power or eject the floppy disk from the disk drive while the operation is in progress. Doing so will damage the KR105's internal memory, making it unusable.*

→ *When clearing the set of saved User Programs, refer to "Deleting Saved User Program Sets" (p. 96).*

■ Loading Saved User Program Sets

User Programs that have been saved on floppy disks or in user memory can be called up, on an individual set basis, to the [User Program] button.

* *Note that calling up these User Programs results in the deletion of all User Programs currently recorded to the [User Program] button.*

When loading a set of User Programs from a floppy disk, first insert the floppy disk in the disk drive.

→ *For more on working with the disk drive, refer to "Using Floppy Disks" (p. 85).*

1. Press the [User Program] button.

2. Touch <File>.

3. Touch <Load>.

A "Load User Program screen" like the following appears.

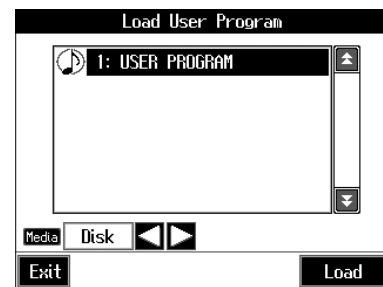

Specifying the set of User Programs to be loaded

4. Use the "Media" arrows to select "Disk" or "User".

Select "Disk" if you are loading User Programs from a floppy disk. Select "User" if you are loading User Programs from the user memory.

5. Touch the name of User Program to load.

6. Touch <Load>.

The confirmation message appears.

7. Touch <OK>.

The selected User Programs are loaded to the [User Program] button.

* *Never turn off the power or eject the floppy disk from the disk drive while the operation is in progress. Doing so will damage the KR105's internal memory, making it unusable.*

Deleting Saved User Program Sets

You can delete individual User Program sets saved to floppy disks or in user memory.

When deleting a set of User Programs on a floppy disk, first insert the floppy disk in the disk drive.

→For more on the use of the disk drive, refer to "Using Floppy Disks" (p. 85).

1. Press the [User Program] button.
2. Touch <File>.
3. Touch <Delete>.

A "Delete User Program screen" like the following appears.

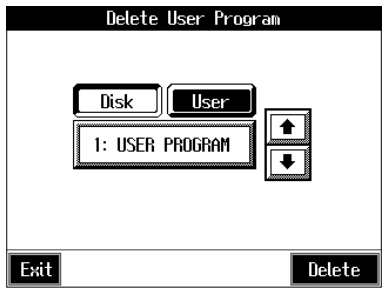

4. Touch <Disk> or <User>.
- Touch <Disk> if you are deleting User Programs from a floppy disk; touch <User> if you are deleting User Programs from the user memory.

5. Touch to select the set of User Programs to be deleted.
6. Touch <Delete>.

A screen like the one shown below appears.



7. Touch <OK>.
- The selected User Programs are deleted.
Touching <Cancel> cancels deleting the file.

* Never turn off the power or eject the floppy disk from the disk drive while the operation is in progress. Doing so will damage the KR105's internal memory, making it unusable.

Copying Sets of User Programs on Disks to the User Memory

You can copy sets of User Programs saved on floppy disks and to user memory.

You can also copy sets of User Programs saved in user memory and to floppy disks.

1. Insert the disk with the settings to be copied in the disk drive.
2. Touch the [User Program] button.
3. Touch <File>.
4. Touch <Copy>.

A "Copy User Programs screen" like the following appears.

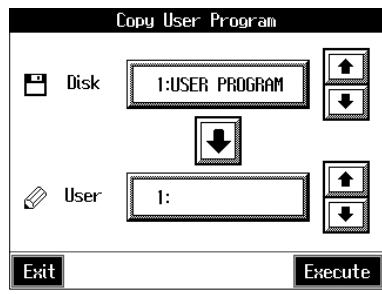

Specifying the copy source

5. Touch <Disk> to select the set of User Programs you want to copy.

When "All" is selected, all of the sets of User Programs on the disk are copied to user memory.

Specifying the copy destination

6. Touch <User> to select the copy destination for the set of User Programs.

If a User Program name is displayed, already a User Program saved to that number is already.

If you select a number with User Programs data, and then copy data to that number, the previously saved User Programs are deleted. If you do not want to delete the saved User Programs, select a number in the save-destination column for which no name is displayed.

7. Touch <Execute>.
- The set of User Programs on the disk is saved to user memory.

* Never turn off the power or eject the floppy disk from the disk drive while the operation is in progress. Doing so will damage the KR105's internal memory, making it unusable.

■ Coping Sets of User Programs Stored in the User Memory to Disks

You can take User Program sets saved in user memory and copy them to floppy disks.

In this case, in the Copy User Programs screen in Step 4 above, touch the large arrow icon in the center to get the arrow to point up. This sets the KR105 to copy the User Program set in the user memory to the floppy disk.

The rest of the procedure is identical to that used for copying sets of User Program set from disks to user memory.

Using the Pedal to Switch User Programs

You can assign the function of the sequential switching of User Programs to the pedal. That way, each time you depress the pedal, the KR105 switches to the next User Program.

Great for use in concerts and similar situations, this allows you to prepare and save your User Programs in the sequence they are to be used, and then call up User Programs in the appropriate order while you perform, simply by depressing the pedal.

1. Press the [User Program] button.
2. Touch <Pedal> in the lower part of the screen.
A "PEDAL screen" like the following appears.

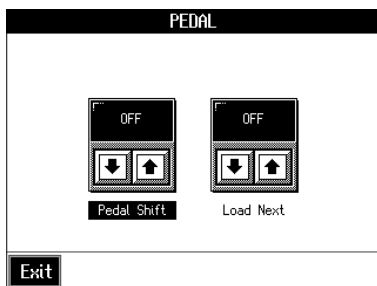

■ Selecting the Pedal Used for Switching Settings (Pedal Shift)

3. Touch <Pedal Shift> to select the setting.

Display	Explanation
OFF	You can use a function assigned to the pedal.
Left Pedal	The left pedal is dedicated to switching User Programs. The function assigned to the left pedal cannot be used.
Center Pedal	The center pedal is dedicated to switching User Programs. The function assigned to the center pedal cannot be used.

Touch <Exit> to return to the User Program screen.

■ Sequential Loading of User Program Sets (Load Next)

When using the pedal to switch your User Programs, you can also call up User Programs sequentially. This feature is called the "Load Next" function.

3. Touch <Load Next> to select the setting.

Display	Explanation
OFF	Switches Load Next off. The pedal does not allow you to select User Programs.
ON	Switches Load Next on. The next press of the pedal after the 36th User Program has been called up does nothing.

Touch <Exit> to return to the User Program screen.

Simultaneously Switching User Program and Transmitting PC Numbers

You can have PC (Program Change) numbers be transmitted to an external MIDI device when you switch the User Program on the KR105.

You can register PC number settings to each of the User Programs, just as you can with button settings and other settings preferences.

Calling Up the Performance Settings to Be Set

1. Press the [User Program] button, then touch the name of the performance setting you want to set.

Setting the Transmission of program changes

2. Touch <Option>.
3. Touch <◀◀> <▶▶> to switch the page to display the following screen.

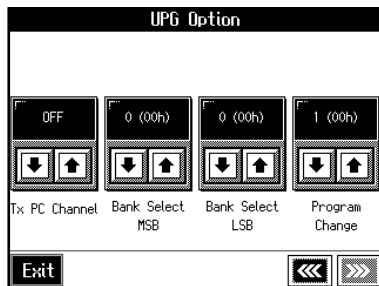

4. Touch [↑] [↓] for the parameter and make the settings.

Display	Description
Tx PC Channel	This prevents the PC number from being transmitted (Off), or sets the transmission channel (Channel 1–16).
Bank Select LSB	Sets the Bank Select LSB.
Bank Select MSB	Sets the Bank Select MSB.
Program Change	Sets the Program Change messages (Program Numbers).

5. Touch <Exit>.

The User Program screen returns to the display.

Touch <Write> to save the setting to the User Program. For more detailed information, refer to “Saving Performance Settings (User Program)” (p. 93).

7. Creating and Editing Songs

Multitrack Recording with 16 Parts (16-Track Sequencer)

Multitrack recording allows you to listen to previously recorded material while continuing to add performances of other parts.

The KR105 is capable of multitrack recording of up to sixteen parts. Since each part's performance is recorded using one tone, you can layer performances, using up to sixteen tones for the data in one song. The function used to layer these sixteen parts, one at a time, is called the "16-Track Sequencer."

16-Track Sequencer

You can record performances for up to 16 parts, overlaying them part by part, to create a single song.

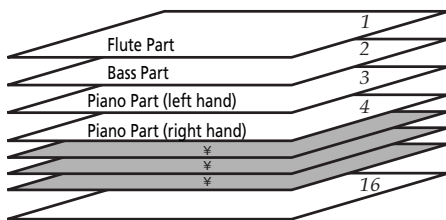

16-Track Sequencer and Track Buttons

In addition to the "16-Track Sequencer" function, the "Track Buttons" (p. 69) are another of the unit's playing/recording functions.

These five "Track buttons" are used for organizing the 16-Track Sequencer's sixteen parts. This allows you to use the 16-Track Sequencer to add more sounds to performances recorded with the Track buttons, and make even more detailed edits of the songs.

You can easily play back the original song data with the 16-Track Sequencer, mute parts by pressing the Track buttons, and more.

The Track buttons correspond to 16-track sequencer parts as shown below.

Track button	Part
[R/Rhythm]	D (10), S (11)
[1/Whole]	1
[2/Bass Accomp]	2, 5-9, 12-16
[3/Lower]	3
[4/Upper]	4

Since the 16-Track Sequencer records one tone to one part, you cannot use Layer performance (p. 25), Split performance (p. 26), or other such functions to record two or more tones simultaneously. Also, you can't record the performance with Automatic Accompaniment.

When you want to record with Automatic Accompaniment, then you should use the Track buttons for recording. (Refer to "Recording With Accompaniment" (p. 78))

Commercially Available Music Files

Commercially available song file recorded in Roland's SMF format is also composed of sixteen parts.

By loading the song file from the floppy disk and using the 16-Track Sequencer, you can then also edit the song file.

→ Although with commercially available Roland SMF music data, Part 11 is included in the [2/Bass Accomp] track button, other tracks match to the corresponding Track buttons.

* With some commercially available music files, you cannot edit the data.

■ The 16-Track Sequencer Screen

When recording with 16-track Sequencer, display the 16-track Sequencer screen.

1. Press the [Menu] button.

The Menu screen appears.

2. Touch <16trk Sequencer>.

A "16-track Sequencer screen" like the one shown below appears.

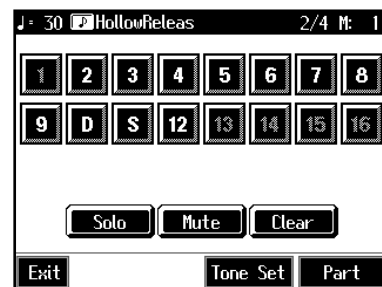

Icon	Description
<1> <16>	Touch to select the part to be recorded, or the part whose settings are to be changed. The Part you choose appears is highlighted.
2	This Part to be played back
-	The Part not to be played back (Muted Part)
2	Parts that do not have performance data recorded to them.
Solo	Only the selected Part is played back.
Mute	This allows you to prevent the sound for the selected part from playing.
Clear	The performance data for the selected part is deleted.
Part	This displays the Part Settings screen, in which you can make detailed settings for each part. For details refer to p. 100.

Icon	Description
Tone Set	The Tone Set screen appears. For details refer to p. 101.

■ Modifying the Settings of Each Part

You can change the Tones and volume, as well as mute the playback, for each individual part in songs recorded with the 16-track Sequencer and the internal songs.

→ Because commercially available Roland SMF music files are also made up of 16 Parts, you can change the settings for the individual Parts and play them back in the same way.

First, select the song for which the settings are to be made (p. 54).

1. Display the 16-track Sequencer screen (p. 99).
2. Touch the screen to choose the Part for which you want to make settings.

Change the settings for the selected Part.

Display	Function
Solo	Only the selected Part is played back.
Mute	Toggles playback of the selected Part to on or off.
Clear	The performance data for the selected part is deleted.

* When you touch <Clear>, a message asking you to confirm the deletion appears. To erase the recorded sound, touch <OK>. If you don't want to erase the recorded sound, touch <Cancel>. Once a performance has been erased, it can't be restored.

3. Touch <Part> to make more detailed settings for the selected part.

A screen like the one shown below appears.

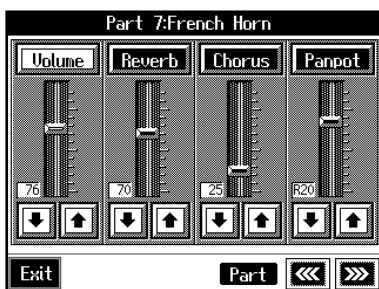

You can change the Tone for the selected Part by pressing a Tone button while this screen is displayed. When selecting Part 10 or 11, you can touch <Drum Set> to select the drum set or effect sound. The Part name and tone name are displayed at the top of the screen.

4. Touch for the corresponding item to change the setting.

You can also change the values by touching each parameter slider and then using the dial.

Display	Description
Volume	Changes the volume level.
Reverb	Changes the amount of reverb effect applied to the sound.
Chorus	Changes the amount of chorus applied.
Panpot	Shifts the direction from which the sound is heard between left and right. Touch to shift the sound to the right, or touch to shift it to the left.

What's Panpot?

Panpot is the control that determines the placement of the sound in the stereo sound field between left and right speakers. By altering the Panpot setting, you can change the perceived location of the sound between the left and right speakers.

When you press the [▶/■ (Play/Stop)] button, you hear what the song sounds like as you change the settings. When you press the [▶/■ (Play/Stop)] button, playback of the song stops.

5. Touch to make settings for other parts.
The Part name appears at the upper part of the screen. Change the settings for other parts as needed.
6. Hold down the [● (Rec)] button and press the [◀ (Reset)] button.

This operation set the changes in the settings.

The song can then be saved to a floppy disk or to user memory.

If you do not want to delete a song after changing the settings for the individual parts, save the song to a floppy disk or to user memory (p. 87).

* You cannot save the settings that determine whether sounds for each individual part are played or not (solo and mute).

If the following message appears

If you try to display another screen after you've changed the song's settings for each Part, a message like the one below may appear.



Touch <OK> to change the song's settings.

Touch <Cancel> to discard the changes you're made.

Getting the Most Suitable Part Tones for the Musical Genre (Tone Set)

"Tone Set" is a function that automatically assigns the most suitable tones for the selected musical style.

When you're creating a song, you can assign Tone sets, then change the Tones to suit the ideas you have for your song.

1. Display the 16-track Sequencer screen (p. 99).
2. Touch <Tone Set> in the lower part of the screen.

A screen like the one shown below appears.

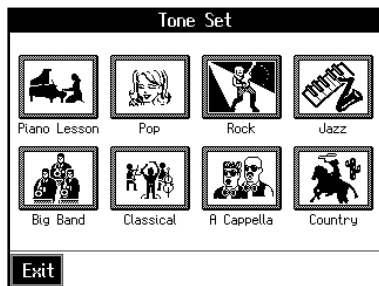

3. Touch the screen to select a musical genre.
4. Touch <Exit>.

The 16-track sequencer screen appears.

Tones for each part are assigned automatically.

* In some genres, some parts may have no tone assigned.

Recording a Performance

Step 1 Prepare for Recording

Selecting the Song to Record

1. Hold down the [Song/File] button and press the [● (Rec)] button.

The following screen is displayed if there is any previously recorded performance or any song with changed settings.



Touch <OK> to delete the song.

If you want to overwrite while recording, select a song.

Determining the Song's Beat and Tempo

2. Press the [Metronome] button to select the beat (p. 32).

→ You can't change a song's beat once it's been recorded. If you want to compose a song whose beat changes partway through the song, take a look at "Changing the Beat in the Middle of a Song (Beat Map)" (p. 113).

3. Press the Tempo [-] and [+] buttons to set the basic tempo of the song.

If you do not need the metronome sound, press the [Metronome] button once more.

→ When using song data that has already been recorded, the recording is made using the source song's basic tempo. To change the basic tempo of a song, please refer to "Changing the Tempo of Recorded Songs" (p. 114).

○ Step 2 Start Recording

If necessary, choose a recording method.

For more on how to record, refer to p. 102.

If you record for the first time, there's no need to select the recording method.

Selecting the Part to Record

1. Display the 16-track Sequencer screen (p. 99).
2. Touch the number for the Part you want to record.

Selecting the Sound to Play

3. Use the Tone buttons to choose a Tone to play.

After selecting a Tone, press the [Exit] button to call up the "16-Track Sequencer screen."

You can only record drum sounds or effect sounds on Part D (10) or Part S (11). You can select drum sets or effect sounds by selecting Part D (10) or Part S (11) and touching <Drum Set>.

Recording the Performance

4. Press the [⏪ (Reset)] button.

Recording will start at the beginning of the song.

If you want to record from a point other than the beginning, use the [⏮ (Bwd)] and [⏭ (Fwd)] buttons to select another measure to begin.

5. Press the [● (Rec)] button and watch the indicator is light up.

The KR is put in recording standby.

6. Press the [▶/■ (Play/Stop)] button.

A two-bar count-in sounds, then recording starts.

* You cannot use the performance pads when recording with the 16-track sequencer.

7. Press the [▶/■ (Play/Stop)] button.

Recording stops.

When one part is recorded, continue by selecting and recording another part. Continue layering parts to finish recording the song.

→ You only need to follow the procedure described in "Step 1 Prepare for Recording" when you're recording the first Part. For the second Part and after, you can skip step 1 and proceed from "Step 2 Start Recording."

* Any performance that has been recorded is deleted when the power to the KR105 is turned off. It is a good idea to save song data to a floppy disk or user memory. For more information, refer to "Saving Songs" (p. 87).

Changing the Recording Method (Rec Mode)

You can use any of the four methods below to record with the KR105.

Although you will normally be using "Replace Recording," where previously recorded material is erased when new sounds are recorded, you'll find that you can record songs easily by using this method in combination with other recording methods.

Replace Recording (p. 103)

This is the normal method for recording. New material is recorded as previously recorded material is erased.

Mix Recording (p. 103)

New notes are recorded on top of notes previously recorded. This convenient feature makes it easy for you to record melodies over prerecorded accompaniment.

Loop Recording (p. 104)

Specified measures are recorded repeatedly, while new notes are combined with existing music. A convenient feature for creating rhythm parts. Loop Recording allows you to record over and over within a selected segment, adding a different percussion sound with each pass.

Punch-in Recording (p. 105)

You can re-record only a specified passage as you listen to a recorded performance.

→ Immediately after the power is turned on, Replace Recording is selected.

Changing the Recording Method

1. Press the [Menu] button.

The Menu screen appears.

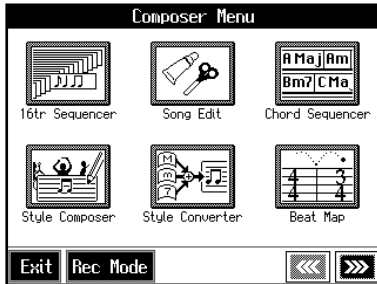

2. Touch <Rec Mode>.

A "Rec Mode screen" like the following appears.

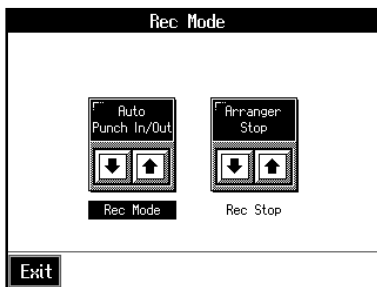

3. Touch <Rec Mode>   to select the recording mode.

Display	Recording Method
Replace	Replace Recording
Mix	Mix Recording
Loop	Loop Recording
Auto Punch-In/Out	Punch-in recording of the interval between set markers
Manual Punch-In/Out	Punch-in recording starting from the point at which the pedal, the Performance Pad or the [● (Rec)] button is pressed For more about Punch In Recording, refer to p. 105.
Tempo	You can add tempo changes to a recorded composition. See p. 114.

4. Touch <Exit>.

Returns to the Menu screen.

Recording While Erasing the Previous Recording (Replace Recording)

The recording process where previous material is erased as new material is recorded is called "replace recording." This setting is in effect when you turn on the power.

1. In the "Rec Mode screen" (p. 103), select <Replace>.

Touch <Exit> to return to the Menu screen.

The KR105 is set to the replace recording mode.

Record the performance using the procedures described in Chapter 4 (p. 75), "Multitrack Recording with 16 Parts (16-Track Sequencer)" (p. 99).

Layering a Recording Over Previously Recorded Sounds (Mix Recording)

You can record a performance layered over a previously recorded performance. This method is called "Mix Recording."

1. In the "Rec Mode screen" (p. 103), select <Mix>.

Touch <Exit> to return to the Menu screen.

Record the performance using the procedures described in "Recording While Selecting the Track Buttons (Redoing Recordings)" (p. 81), "Multitrack Recording with 16 Parts (16-Track Sequencer)" (p. 99), or other methods.

* After you have finished with mix recording, return to the usual replace recording mode.

■ Repeated Recording at the Same Location (Loop Recording)

You can record a specified passage over and over, layering sounds with each pass. This method is called “Loop Recording.” This is handy when recording a Rhythm Part.

For example, use this method to make a Loop Recording of a four-measure segment. First record the bass drum, the snare drum next, then the hi-hat and so on, layering a different instrument onto the same four measures. After you have finished recording the four-measure rhythm pattern, you can then use the procedure in “Copying Measures (Copy)” (p. 108) to create as many copies of the four measures as you need to complete your Rhythm part.

1. Place A and B markers at the beginning and end of the passage you want to record.

Take a look at “Setting Markers for Repeated Practice (Marker)” (p. 70).

If you haven’t recorded anything yet, then use “Blank Recording” to create the necessary number of measures before placing the markers.

What is Blank Recording?

Blank Recording is recording a number of silent measures with no content.

1. Set the basic tempo and beat of the song.
2. Hold down the [● (Rec)] button and press the [▶/■ (Play/Stop)] button.

The indicators for the [● (Rec)] and [▶/■ (Play/Stop)] buttons both light up, and recording starts.

3. Without performing anything, record only the required number of measures, then press the [▶/■ (Play/Stop)] button.

The indicators for the [● (Rec)] and [▶/■ (Play/Stop)] buttons both go out, and recording stops.

2. In the Rec Mode screen (p. 103), select <Loop>.

Touch <Exit> to return to the menu screen.

The recording method changes to loop recording.

3. Press the [● (Rec)] button.

4. Press the Track button for the track to be recorded.

The KR105 is put in recording standby.

5. Press the [▶/■ (Play/Stop)] button to begin recording.

Recording starts from Marker A.

When the song reaches Marker B, it then returns to Marker A, where recording continues.

Each time the recording is looped, the newest sounds are layered over previously recorded sounds.

6. When you press the [▶/■ (Play/Stop)] button, recording stops.

* After you have finished with loop recording, return to the usual replace recording mode (p. 103).

Loop Recording Shortcut

You can also use the method described below to set Loop Recording.

1. Place A and B markers at the beginning and end of the passage you want to record.

Take a look at “Setting Markers for Repeated Practice (Marker)” (p. 70).

If you haven’t recorded anything yet, then perform “Blank Recording” for the necessary number of measures before placing the markers.

2. Touch the <Repeat> icon in the Marker screen (p. 70).

This sets the loop recording mode.

Start a recording.

* After you have finished with loop recording, touch the <Repeat> icon in the “Marker screen” once more to return to the usual replace recording mode.

■ Re-Recording Part of Your Performance (Punch-in Recording)

You can re-record part of a passage as you listen to a recorded performance. This recording method is called "Punch-in Recording." This convenient function lets you record over a specified points in a part as you listen to a prerecorded performance in another section.

User Punch-In Recording by the following two methods:

Recording the Region Defined by Markers A and B (Auto Punch-In/Out)

Before you start recording, place markers A and B to define the passage you want to re-record. Make the setting for punch-in recording, and re-record just the passage between markers A and B.

Recording From the Point at Which the Pedal or Buttons Are Pressed (Manual Punch-In/Out)

You can play back a performance and depress the pedal at the desired place to start re-recording. Depressing the pedal a second time cancels recording and returns you to playback.

When you use the Performance Pads or [● (Rec)] button, recording begins when you press the Pad or button upon reaching a specified point in the song.

When you press the Pad or [● (Rec)] button once more, the KR105 exits recording mode and returns to normal playback.

○ Recording a Passage Specified by Markers

1. Before you start re-recording, place markers A and B to define the passage.

Following the procedures described in "Setting Markers for Repeated Practice (Marker)" (p. 70), use Markers A and B to specify the passage.

2. In the Rec Mode screen (p. 103), select <Auto Punch-In/Out>.

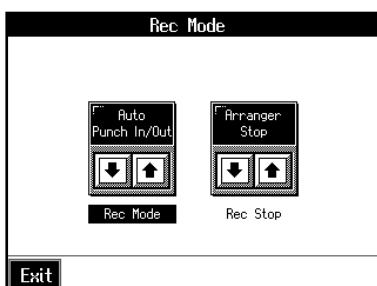

This changes the recording mode to "Punch-In Recording."

Touch <Exit> to return to the Menu screen.

3. Begin recording.

Begin recording using the procedures described in "Recording While Selecting the Track Buttons (Redoing Recordings)" (p. 81) or "Multitrack Recording with 16 Parts (16-Track Sequencer)" (p. 99).

Up until the specified passage, the previously recorded performance plays back.

When you reach the specified passage, sounds are erased as recording starts; begin playing now.

When you reach the end of the specified passage, recording stops, and the KR105 returns to playback of the previously recorded performance.

4. When you press the [▶/■ (Play/Stop)] button, the song stops.

○ Starting Recording from the Measure Specified by Buttons and Pedals

If using the Performance Pads or pedals, you must first change the function of the pedals and Pads. Follow the procedures in "Assigning Functions to Pedals and Performance Pads (Pedal Setting/User Functions)" (p. 126), and assign <Auto Punch-In/Out> to the buttons or pedal.

1. In the Rec Mode screen (p. 103), select <Manual Punch-In/Out>.

This changes the recording mode to "Punch-In Recording."

Touch <Exit> to return to the Menu screen.

2. Begin recording.

Begin recording using the procedures described in "Recording While Selecting the Track Buttons (Redoing Recordings)" (p. 81) or "Multitrack Recording with 16 Parts (16-Track Sequencer)" (p. 99).

The previously recorded performance will be played back.

Recording begins when you press the pedal, the Performance Pad, or the [● (Rec)] button; start re-recording at this time.

Recording stops when you press the pedal, the Performance Pad, or the [● (Rec)] button again, and the previously recorded performance is played back.

3. When you press the [▶/■ (Play/Stop)] button, the performance stops.

* When you're finished with Punch-In Recording, return to the ordinary Replace Recording mode. Take a look at "Changing the Recording Method" (p. 103).

Composing an Accompaniment By Entering Chords (Chord Sequencer)

You can enter a chord progression and choose the places where the accompaniment pattern will change to create an accompaniment for a song. This feature is called "Chord Sequencer."

Thanks to the chord sequencer, you can create an accompaniment ahead of time and play along with your right hand.

1. Press the [Menu] button and watch the indicator light up.

The Menu screen appears.

2. Touch <Chord Sequencer>.

The screen like the one shown below is called "Chord Sequencer screen."

This is the "cursor." The cursor shows where the chord change or other information is input.

This is the end of the song. When continuing to add input, insert measures by touching <Ins>.

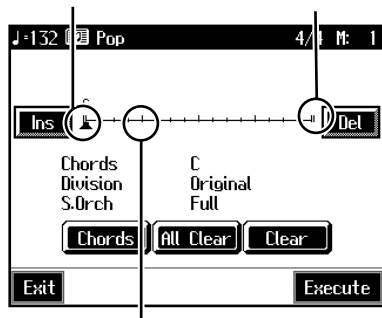

This indicates the position where the accompaniment pattern (Division) or the Style Orchestrator changes.

Display	Description
Ins	One measure is inserted before the measure where the cursor is positioned.
Del	The measure in which the cursor is positioned is deleted.
Chords	Allows input of chords without playing the keyboard. Refer to "Inputting Chords without Playing the Keyboard" (p. 107).
All Clear	Deletes all of the data that's been input.
Clear	Deletes the data at the cursor position.
Execute	Records the input chord progression. Touch this icon when you have finished inputting all of the chords.

3. Press a Music Style button or the touch screen to select a Music Style (p. 39).

4. Touch <Exit>.

You are returned to the Chord Sequencer screen.

5. Enter the chord progression and the accompaniment pattern.

Refer to "Inputting Chords with the Chord Sequencer."

6. When you have finished inputting all the data, touch <Execute>.

The accompaniment you've composed is registered at "0: New Song."

When storage of the data is complete, return to the Menu screen.

Now, press the [▶/■] (Play/Stop) button, and try playing the melody along with the accompaniment you created.

* *Songs you've created are discarded as soon as you turn off the power. If you do not want to delete the song, save it to a floppy disk or to user memory. Refer to "Saving Songs" (p. 87).*

Inputting Chords with the Chord Sequencer

Change the accompaniment arrangements

Move the cursor

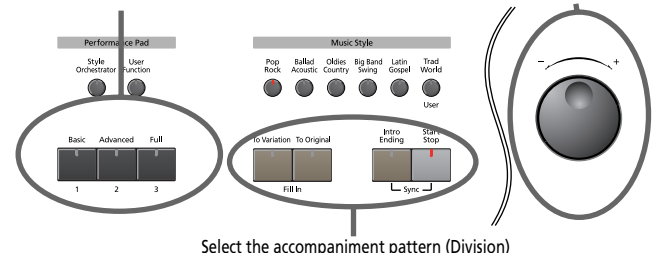

Select the accompaniment pattern (Division)

1. Use the dial to move the cursor to the input position.

Use the [◀◀] (Bwd) and [▶▶] (Fwd) buttons to move the cursor one measure at a time.

2. Enter the chord progression and the changes in the accompaniment pattern and arrangement.

Just as when performing with Automatic Accompaniment, press the keys to specify a chord, and press a button to select the accompaniment pattern (p. 46). You can change the Style Orchestrator with the Performance Pads (p. 48).

3. Touch <Ins> once to insert one measure before the measure where the cursor is currently positioned.

If you touch , the measure where the cursor is currently positioned is deleted, while the measures that follow are moved forward.

To remove what you have input, move the cursor to the position with input you want to delete, then touch <Clear>. This deletes the entered setting.

→ *You can only insert an intro at the beginning of a song. When*

you add an intro, the number of bars corresponding to the length of the intro is inserted automatically.

Functions That Can Be Assigned to the Pedals and the Performance Pads

→ For instructions on assigning functions, refer to “Assigning Functions to Pedals and Performance Pads (Pedal Setting/ User Functions)” (p. 126).

- Inputting a short Intro and Ending
Assign “Intro 2/Ending 2” to a pedal or pad.
- Inputting a “Variation” or “Original” without a Fill-In
Assign “Original/Variation” to a pedal or pad.
- Using the keyboard to input slash chords (such as Fm/C)
Assign “Leading Bass” to a pedal or pad.
- Inputting a break somewhere within the song
Assign “Break” to a pedal or pad.

Check the accompaniment you inserted

Here’s how to play back as much of the accompaniment as you have input.

1. Press the [◀ (Reset)] button to return to the beginning of the song.
2. When you press the [▶/■ (Play/Stop)] button, the performance is played back.
3. Playback stops when you press the [▶/■ (Play/Stop)] button once more.



Inputting Chords without Playing the Keyboard

You can use <Chords> at the bottom right of the Chord Sequencer screen to specify chords on the screen.

1. At the Chord Sequencer screen, touch <Chords>.

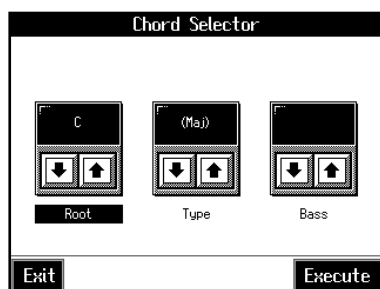
A screen like the one shown below appears.



2. Touch   in each to specify the chords.
3. Touch <Execute> to enter the chord.

You are returned to the Chord Sequencer screen.

Editing Songs

There are many ways you can edit performances recorded using the KR105 Track button or 16-track sequencer.

Basic Operation of the Editing Functions

- * While songs are being loaded, the measure number in the upper right of the screen is highlighted (text and background are inverted). Start editing the song only after the measure number is no longer highlighted.

Selecting the editing function

1. Press the [Menu] button and watch the indicator light up.
The Menu screen appears.
2. Touch <Song Edit>.
A “Song Edit screen” like the following appears.



3. Touch an editing function to select that function.

For more detailed information, refer to the corresponding page for each function.

Function	Description	Page
Undo	Undoes editing operations that have been performed.	p. 108
Copy	Copies measures.	p. 108
Quantize	Evens out sounds in recorded performances.	p. 109
Delete	Deletes measures.	p. 110
Insert	Inserts a blank measure.	p. 110
Trans- pose	Transposes parts individually.	p. 111
Erase	Erases data in measures, creating blank measures.	p. 111
Part Exchange	Exchanges the sounds in parts.	p. 112
Note Edit	Allows corrections to be made note by note.	p. 112
PC Edit	Allows editing of the Tones changes that occur during a song.	p. 113

→“PC” stands for “Program Change,” which is a command that tells an instrument to change the sound it’s using. With songs that rely on the use of a variety of sounds, a “PC” needs to be located at every point within the song where the Tone is to be changed

* Some edits can’t be undone, not even by choosing “Undo.” We recommend saving songs to floppy disks or to user memory before editing. For more on how to save songs, refer to “Saving Songs” (p. 87).

Editing

4. Touch the item to be edited.

The value for the item being edited is highlighted.

5. Set the value with the dial.

To cancel the operation once it is underway, touch KR105.

6. When you’re done making all the settings, touch

<Execute>.

When you are finished editing the setting, return to the “Song Edit screen.”

Touch <Exit> to return to the Menu screen.

■ Undoing Edits (Undo)

You can cancel an editing operation that you’ve just carried out. This is handy when you want to undo an edit and restore data to the way it was before.

* There are some edits that can’t be restored.

At Step 3 of “Selecting the editing function” (p. 107), select <Undo>.

Editing functions that can be undone appear on screen.

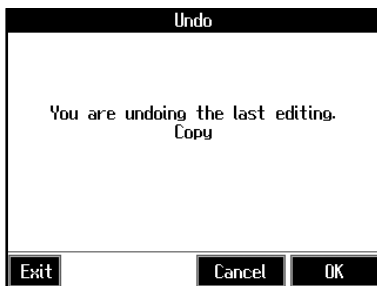

If you touch <Cancel>, the undo is cancelled, and you’re returned to the Song Edit screen.

If you touch <OK>, the confirmation message appears on screen. Touch <OK> to undone the most recent edit.

■ Copying Measures (Copy)

You can copy a portion of a performance to a different bar in the same Part or to a measure in another Part. This is handy when you’re composing a song that repeats a similar phrase.

Ex. To copy measures 5-7 to measure 8.

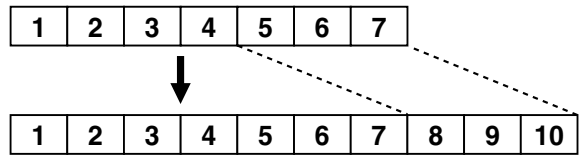

At Step 3 of “Selecting the editing function” (p. 107), select <Copy>.

A screen like the one shown below appears.

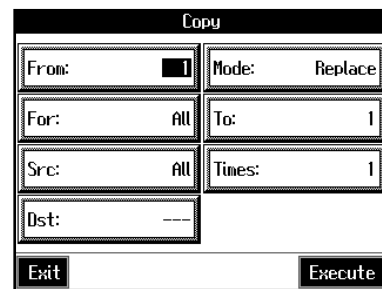

Item	Content
From	Measure number of the first measure of the segment to be copied
For	Number of measures to be copied
Src	Copy-source Track button or part number Choosing “All” copies all Parts. “—” appears in the <Dst> column. If you choose a Track button, you can only copy to the selected Track button. You cannot copy to the other Track buttons.
To	Copy-destination measure number When “End” is selected, the data is copied to the end of the song.
Times	Number of times the data is to be copied
Dst	Copy-destination part number

Item	Content
Mode	Data can be copied in the following three ways:
	<p>Replace If there is a performance recorded at the copy destination, this previous recording is erased, and the copied data is written in its place.</p>
	<p>Mix If there is a performance recorded at the copy destination, the copied data is layered over the previous recording. If the Tones used for the copy source and copy destination are different, the copy-destination Tone is used.</p>
	<p>Insert If there is a performance recorded at the copy destination, the copied portion is inserted without erasing the previous recording. The song is lengthened by the number of inserted measures.</p>

Item	Content
From	Measure number of the first measure of the segment to be quantized
For	Number of measures to be quantized
Tr/Pt	Track button or part number to be quantized Choosing "All" quantizes the same passage in all Parts.
Resolution	Quantization timing Select one of the following values 1/2 (half note), 1/4 (quarter note), 1/6 (quarter-note triplet), 1/8 (eighth note), 1/12 (eighth-note triplet), 1/16 (sixteenth note), 1/24 (sixteenth-note triplet), 1/32 (thirty-second note)

When finished with the Quantize settings, return to the Song Edit screen.

■ Correcting Timing Discrepancies (Quantize)

You can correct for timing discrepancies in a recorded performance by automatically aligning the music with the timing you specify. This is called "Quantizing."

As an example, let's say that the timing of some quarter-notes in a performance is a little off. In this case, you can quantize the performance with quarter-note timing, thus making the timing accurate.

Example: Quarter-note resolution



Example: Sixteenth-note resolution

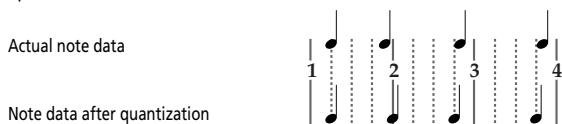

At Step 3 of "Selecting the editing function" (p. 107), select <Quantize>.

A screen like the one shown below appears.

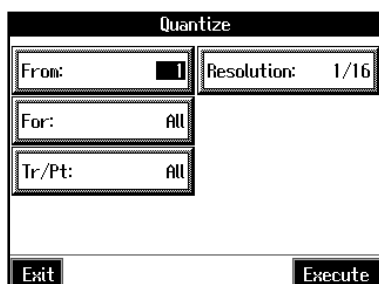

■ Deleting Measures (Delete)

You can delete a part of a performance measure by measure. When a portion of a performance is deleted, the rest of the performance is shifted up to fill the gap. Erasing measures in a specified passage is called “deleting.”

Ex. To delete measures (bars) 5-8

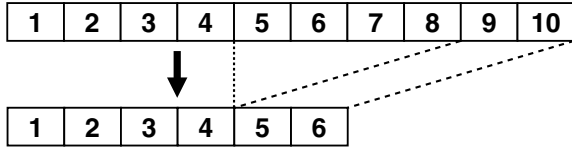

At Step 3 of “Selecting the editing function” (p. 107), select <Delete>.

A screen like the one shown below appears.

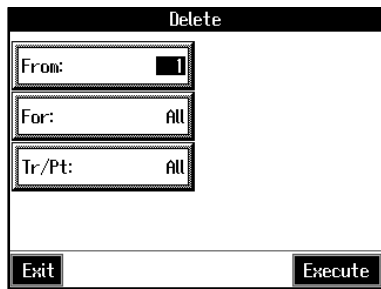

Item	Content
From	Measure number of the first measure of the segment to be deleted
For	Number of measures to be deleted
Tr/Pt	Track button or part number to be deleted When “All” is selected, the same portion of all parts is deleted.

■ Inserting Blank Measures (Insert)

You can add a blank measure at a location you specify. This addition of a blank measure is called “insertion.”

Ex. To insert measures (bars) 5-7

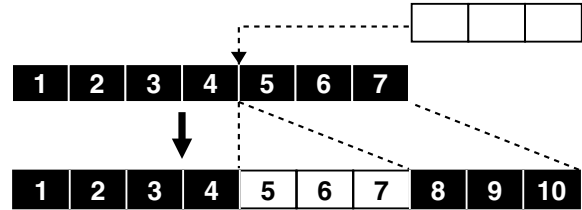

At Step 3 of “Selecting the editing function” (p. 107), select <Insert>.

A screen like the one shown below appears.

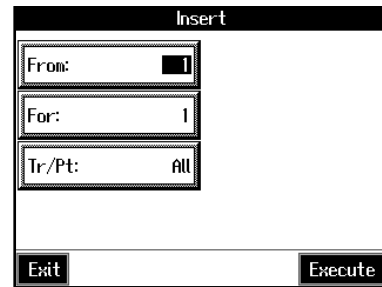

Item	Content
From	Measure number of the first measure of the segment to be inserted
For	Number of measures to be inserted
Tr/Pt	Track button or part number where data will be inserted When “All” is selected, blank measures are inserted at the same place in all parts.

■ Transposing Individual Parts (Transpose)

You can transpose specified parts and tracks individually. At Step 3 of "Selecting the editing function" (p. 107), select <Transpose>.

A screen like the one shown below appears.

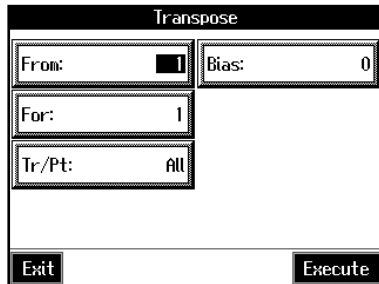

Item	Content
From	Measure number of the first measure of the segment to be transposed
For	Number of measures to be transposed
Tr/Pt	Track button or part number to be transposed When "All" is selected, the same portion of all parts is transposed.
Bias	The range of transposition You can select the range to transpose the data, from -24 (two octaves down) to +24 (two octaves up), adjustable in semitones.

* You cannot transpose performances of the drum sets and sound effect sets (such as the Rhythm Track).

■ Making Measures Blank (Erase)

You can delete the performance data in a specified block of measures, turning them into blank measures without reducing the length of the song. This process is called "erasing."

Ex. To erase measures (bars) 5-8

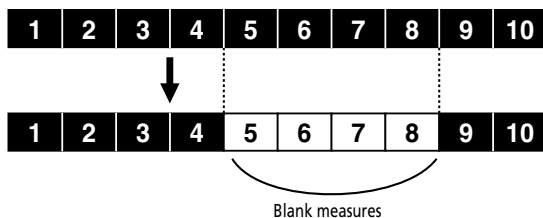

Follow the steps in "Selecting the editing function" (p. 107) to choose <Erase>.

A screen like the one shown below appears.

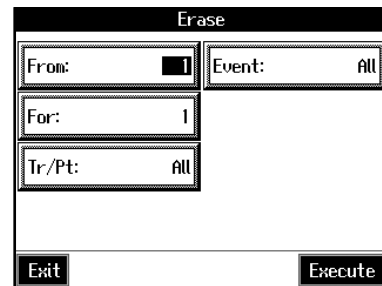

Item	Content
From	Measure number of the first measure of the segment to be erased
For	Number of measures to be erased
Tr/Pt	Track button or part number to be erased When "All" is selected, the same portion of all parts is erased.
Event	Select from the following types of performance data to erase:
	All All performance data, including notes, tempos, Tones switches, volume changes, etc., are erased.
	Tempo Tempo data is erased. Erasing the tempo data for all measures results in a single, constant tempo.
	Prog.Change Erases the data for switching Tones (p. 108).
	Note Erases only notes.
	Except Notes Erases all of the performance data except for the notes.
	Expression Erases Expression (volume change) information.

■ Exchanging Parts (Part Exchange)

You can exchange the notes recorded for a particular part with the notes recorded for another part. This process of exchanging parts is called “part exchange.”

At Step 3 of “Selecting the editing function” (p. 107), select <Part Exchange>.

A screen like the one shown below appears.

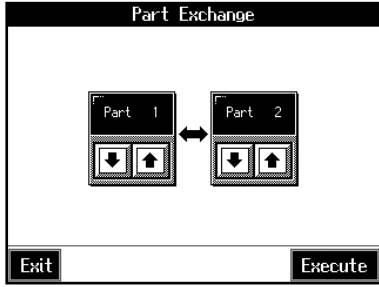

Touch each   to choose Parts you want to exchange.

■ Correcting Notes One by One (Note Edit)

You can make corrections in a recorded performance one note at a time. This process of making changes in individual notes is called “note editing.”

You can make these corrections by using note editing:



- Deleting misplayed notes
- Changing the scale of a single note
- Changing the force used in playing a single key (velocity)

At Step 3 of “Selecting the editing function” (p. 107), select <Note Edit>.

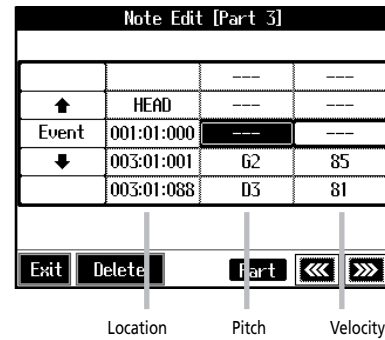
A screen like the one shown below appears.



The note-location display uses “Measure: Beat: Tick” as the format. A tick is a unit of time that’s shorter than a beat.

Touch   to select the part with the note to be corrected. The Part number appears at the top of the screen.

Use the [<<< (Bwd)] button and the [>>> (Fwd)] button or use <↑> <↓> in the upper part of the screen to find the note to be corrected.

When you’ve found the note you want to correct, touch “Pitch” or “Velocity” for the note.

Use the dial to correct the pitch or velocity. If you want to delete the note, touch <Delete>.

When you’re done making all the settings, touch <Exit>.

Return to the Song Edit screen.

■ Modifying the Tone Changes in a Song (PC Edit)

In some songs, the instrument sound changes during the course of the song (that is, the Tone changes in the middle of a Part). In such songs, an instruction to switch the Tone is inserted at the place where you want the sound to change. This instruction is called a "Program Change" (PC), and actions such as deleting program changes, or changing the selected Tone by them are called "PC editing."

* *It is not possible to insert a program change into a measure or beat that does not contain a program change.*

At Step 3 of "Selecting the editing function" (p. 107), select <PC Edit>.

A screen like the one shown below appears.

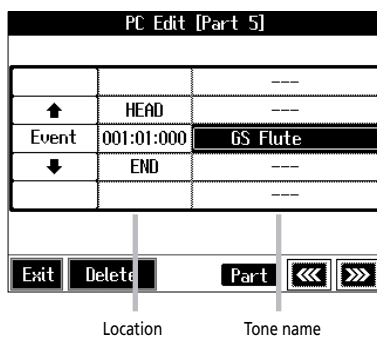

The PC-location display uses "Measure: Beat: Tick" as the format. A tick is a unit of time that's shorter than a beat.

Touch to select the part with the program change to be edited.

The Part number appears at the top of the screen.

Use the [(Bwd)] button and the [(Fwd)] button or use <↑> <↓> in the upper part of the screen to find the program change to be edited.

When you've found the Program Change you want to modify, touch "Tone Name" on the screen.

Press a Tone button to select a Tone group, then select a Tone with the dial. When selecting Part 10 or 11, select the drum set or effect sound.

If you want to delete the Program Change, touch <Delete>.

When you're done making all the settings, touch <Exit>.

Changing the Beat in the Middle of a Song (Beat Map)

You can create songs that have beat changes during the course of the song.

* *You can't change a song's beat once it's been recorded. Before recording the performance, determine the beat to be used.*

1. Press the [Menu] button.

The Menu screen appears.

2. Touch <Beat Map>.

A screen like the one shown below appears.

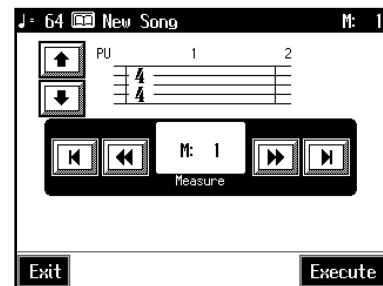

3. Use <◀◀>>▶▶> in the screen or the [(Bwd)] and [(Fwd)] buttons to move to the measure whose beat you want to change.

The measure number appears in the top-right area of the screen.

Touch <◀> to move to the beginning of the song.

Touch <▶> to move to the end of the song.

4. Touch in each to set the beat.

5. Touch <Execute>.

The beat change starts with the measure you selected. Repeat Steps 3-5 to make beat settings in other measures as needed.

Recording the performance

6. Touch <Exit> twice.

The screen displayed before you pressed the [Menu] button appears.

7. Press the [(Reset)] button to return the measure number to "1."

8. Start a recording.

Record the performance using the procedures described in "Recording and Saving the Performance" (p. 75). Specify the measure, then change the beat.

Changing the Tempo of Recorded Songs

You can change the basic tempo of a composition. The basic tempo was initially set when the song was recorded.

1. Press the Tempo [-] and [+] buttons to choose a tempo.
2. Hold down the [● (Rec)] button and press the [◀ (Reset)] button.

The song's basic tempo changes.

The change in basic tempo is discarded when you turn off the power or choose a different song. Save important song data to floppy disks or to user memory (p. 87).

* If the song you're working on has tempo changes, press the [◀ (Reset)] button to go back to the beginning of the song before you carry out this operation.

Changing the Tempo Within the Song

You can add tempo changes to a recorded composition.

The KR105 stores song tempo information and performance data separately. Therefore, when making changes to the tempo in a song, you must record the changes in the tempo information independently of the performance data.

This recording of the tempo is called "Tempo Recording."

■ Adjusting the Tempo While Listening to a Song

You can add ritardando and other such gradual tempo changes.

Setting the Rec Mode to "Tempo"

1. Press the [Menu] button.

The Menu screen appears.

2. Touch <Rec Mode>.

A screen like the one shown below appears.

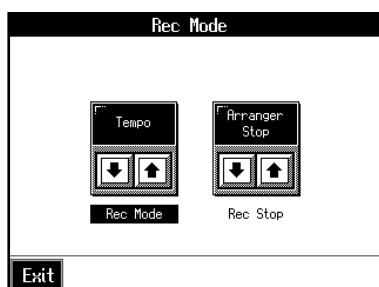

3. Touch the <Rec Mode>   to select <Tempo>.

This makes the setting for tempo recording.

Touch <Exit> a number of times to switch to the screen where the measure number is indicated in the upper right of the screen.

When the KR105 goes into Tempo Recording, the tempo indication is highlighted in white.

Recording the Tempo

4. Use the [◀◀ (Bwd)] and [▶▶ (Fwd)] buttons to move slightly before the measure where you want to change the tempo.
5. Press the [● (Rec)] button and watch the indicator is flashing.
6. When you press the [▶/■ (Play/Stop)] button, recording begins.
7. When you get to the place where you want to change the tempo, use the Tempo [-] and [+] buttons or the dial to vary the tempo as desired.
8. When you press the [▶/■ (Play/Stop)] button, recording stops.

The song's tempo changes.

* You cannot record performances while in Tempo Recording mode. When you're finished tempo recording, go back to the ordinary Replace Recording. Take a look at "Changing the Recording Method (Rec Mode)" (p. 102).

■ Adjusting the Tempo at a Particular Measure

You can create a tempo change at the beginning of a selected measure. This is handy when you want to make a sudden change in tempo.

First, carry out Steps 1–3 of “Changing the Tempo Within the Song” (p. 114) to make the “Tempo Recording” settings.

1. Use the [◀◀ (Bwd)] and [▶▶ (Fwd)] buttons to move to the measure where you want to change the tempo.

The measure number appears in the top-right area of the Basic screen.

2. Press the [● (Rec)] button and watch the indicator is flashing.

The KR105 is put in recording standby.

3. Use the TEMPO [-][+] buttons or the dial to change the tempo.

4. Press the [▶/■ (Play/Stop)] button.

The song’s tempo changes starts with the measure you selected.

→ While tempo recording is being used to write tempo, the tempo display in the screen will be highlighted.

5. When you press the [▶/■ (Play/Stop)] button, the change in tempo stops.

* You cannot record performances while in Tempo Recording mode. When you’re finished tempo recording, go back to the ordinary Replace Recording. Take a look at “Changing the Recording Method (Rec Mode)” (p. 102).

→ If you want to restore the previous tempo, delete the tempo data at the place where the tempo was recorded. For an explanation of how to delete the information of tempo settings, refer to “Making Measures Blank (Erase)” (p. 111).

Tempo Recording Shortcut

Hold down the [● (Rec)] button and press one of the Tempo [-] [+] buttons to switch to the Tempo Recording settings. Record tempo information. In this case, tempo recording is canceled when recording ends.

8. Creating Music Styles

Creating Original Styles (User Styles)

Although the KR105 features a variety of internal Music Styles, you can also create your own. These original Styles are called "User Styles."

You can use either of the two methods described below to create a User Style.

Style Composer

With this method, you combine internal Music Styles to create new Styles. You can create a new Style by selecting from among the Rhythm, Bass, Accompaniment 1, Accompaniment 2, and Accompaniment 3 parts in different styles.

Style Converter (p. 118)

Create a new Style by extracting the portions you need from songs composed with the 16-track sequencer.

When you're composing a song, there's no need to specify all the chords. You can specify just some of the chords, and the KR105 automatically chooses the other chords and arranges the Style.

Style Converter features an "Auto mode" that allows you to easily create Styles from songs with a single chord, and a "Manual mode," in which you create Styles from songs with three kinds of chords—major, minor, and seventh chords.

■ Creating New Styles by Combining Internal Music Styles (Style Composer)

You can create a new style by selecting from among the Rhythm, Bass, Accompaniment 1, Accompaniment 2, and Accompaniment 3 parts in different Styles. This function is called the "Style Composer."

* You can only combine the KR105's built-in Styles.

Displaying the Style Composer Screen

1. Press the [Menu] button.

The Menu screen appears.

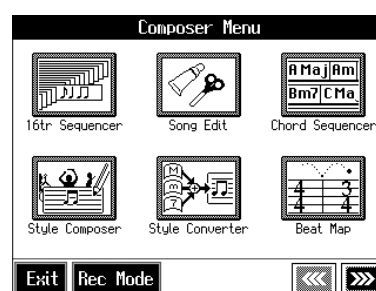

2. Touch <Style Composer>.

* If a User Style has already been recorded, a message like the one shown below appears.



Touch <Cancel> to return to the Menu screen. Save User Styles to floppy disks, or to user memory (p. 121).

When you touch <OK>, the previously recorded User Style is deleted, and a new User Style is created.

A "Style Composer screen" like the one shown below appears.

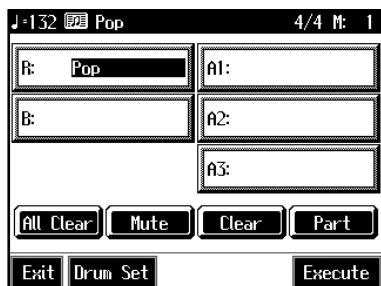

Display	Part
R	Rhythm
B	Bass
A1	Accompaniment 1
A2	Accompaniment 2
A3	Accompaniment 3

Icon	Function
All Clear	Deletes all of the settings.
Mute	You can mute the sound of particular Parts in specific Divisions. For more information, take a look at "Muting Parts for a particular division" (p. 117).
Clear	Deletes the Styles in selected parts.
Part	The Part Settings screen is displayed, allowing you to make detailed settings to each part. For more information, take a look at "Editing the volume and effect settings for each Part" (p. 118).
Execute	Records the created Style to the Music Style [User] button. Touch this when you have finished creating the Style.

Selecting the Styles assigned to each part

3. Touch the part to be set.

The Part you touched appears in reverse video.

4. Press an Music Style button, then select a Style with the touch screen or the dial.

When you have decided on a Style, touch <Exit> to display the Style Composer screen.

5. Repeat steps 3 and 4 to determine the Styles for each Part.

Deciding on a Style

6. Touch <Execute>.

You have created a new Style.

The User Style is recorded to the Music Style [User] button. Try playing with the new Style.

- * If you turn off the power or record a new User Style, any User Style you've previously recorded is lost. If you do not want to delete the Style, save it to a floppy disk or to user memory. Take a look at "Saving a User Style" (p. 121).

○ Muting Parts for a particular division

You can mute the sound of particular Parts in specific Divisions.

For example, have all of the parts play in the "Variation" accompaniment pattern, while muting "Accompaniment 2" and "Accompaniment 3" in the "Original" accompaniment pattern. With this arrangement, when the accompaniment pattern changes from the original to the variation, it creates a more elaborate effect in the accompaniment.

- For more on Divisions, refer to the "Style Arrangements" (p. 118).

1. Touch the screen to choose the Part you want to mute out.

2. Press the Fill In [To Variation] or [To Original] button to switch to the division that you want to mute.

3. Touch <Mute> on the screen.

The Part you chose is only muted out in the Division you selected.

If you want to hear the muted-out Part, touch <Mute> again.

- * To mute out a Division that changes after a few seconds (intro, ending, or fill-in), touch <Mute> immediately after switching to the Division.

○ **Editing the volume and effect settings for each Part**

Displaying the Part settings screen

1. At the Style Composer screen, touch <Part>. A screen like the one shown below appears.

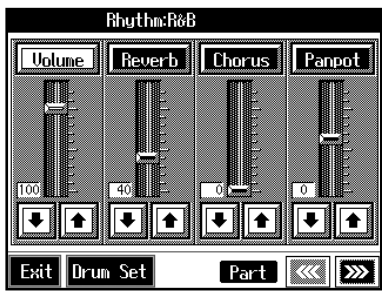

Modifying the settings of each part

2. Touch the to select the part with the settings to be changed. The part name and Tone name are indicated in the upper part of the screen.
3. Touch for each parameter to change the value. You can also change the values by touching each parameter name and then using the dial.

Display	Explanation
Volume	Adjusts the volume.
Reverb	Adjusts the amount of reverb effect applied to the sound.
Chorus	Adjusts the amount of chorus effect applied to the sound.
Panpot	Changes the left-right direction from which the sound appears to come. When you touch , the sound moves to the right; touch to move the sound to the left.

Finishing the settings

4. Touch <Exit>. The Style Composer screen appears.

■ **Creating a Style from a Song You Composed Yourself (Style Converter)**

You can take a song you've composed yourself and extract the portions you need to create your own original Style. When you're composing a song, there's no need to specify all the chords. You can specify some of the chords, and the KR105 automatically chooses the other chords and arranges the style. This function is called the "Style Converter."

Style Converter features an "Auto mode" that allows you to easily create Styles from songs with a single chord, and a "Manual mode," in which you create Styles from songs with three kinds of chords—major, minor, and seventh chords.

When creating a song in order to create an music style, it's good practice to consider the arrangement of the music style.

Style Arrangements

A Music Style is made up of five performance parts: "Rhythm," "Bass," "Accompaniment 1," "Accompaniment 2" and "Accompaniment 3."

A song progresses in predictable a sequence, such as intro, melody A, melody B, bridge and ending.

With the KR105, such changes in songs are allocated to the following six performance states. We call these six parts of a song "Divisions."

Division	Performance division
Intro	The intro is played at the start of a song.
Ending	This is played at the end of a song.
Original	This is a basic accompaniment pattern.
Variation	This is a developmental accompaniment pattern. It is a variation on an Original.
Fill-In To Variation	This is a one-measure phrase inserted at a juncture where the mood changes. It is used to make a song more lively.
Fill-In To Original	This is a one-measure phrase inserted at a juncture where the mood changes. It is used to make a song more sedate.

You can make a song more lively or more restrained by increasing or reducing played parts by Divisions. You can also modify a song by changing the Tone of the parts in the Divisions.

○ Creating Styles in Auto Mode

Points to note when creating songs

- Use one of the major, minor, or seventh chords to create the song.
- It is convenient to record the sounds shown below for the Parts of the 16-track sequencer.

Rhythm	Bass	Accomp 1	Accomp 2	Accomp 3
D (10)	2	7	8	9

→ When using parts other than Part 2, 7, 8, 9, and D, refer to “Changing an Extracted Part” (p. 120).

Creating songs

1. Use the 16-track sequencer to record the song.

Record the song after referring to “Multitrack Recording with 16 Parts (16-Track Sequencer)” (p. 99) and other related sections.

When using music data, first select a song (p. 54).

Displaying the Style Converter screen

2. Press the [Menu] button.

The Menu screen appears.

3. Touch <Style Converter>.

- * If no song for use in creating a new Style is selected, the message “Please select a song” appears. Use the [Song/File] button to select a song (p. 54), then start the procedure again.
- * If a User Style has already been recorded, a message like the one shown below appears.



Touch <Cancel> to return to the Menu screen. Please save the User Style on a floppy disk or in the internal memory (p. 121). When you touch <OK>, the previously recorded User Style is deleted, and a new User Style is created.

A “Style Converter screen” like the one shown appears.

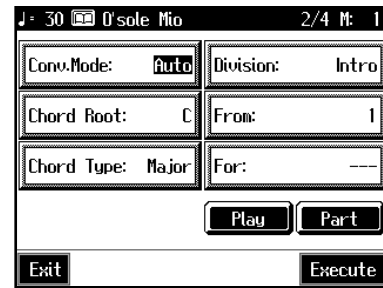

Parameter Name	Settings Content
Conv.Mode	Switches the mode (Auto/Manual)
Chord Root	Chord root for the segment to be extracted
Chord Type	Chord type for the segment to be extracted (major/minor/seventh)
Division	Division
From	Measure number of the first measure of the segment to be extracted
For	Number of measures extracted

Making the settings

4. Touch <Conv. Mode>, then use the dial to switch the mode to “Auto.”

This makes the setting for the Auto mode.

5. Touch <Chord Root> and <Chord Type>, then use the dial to input the chord root and type for the segment to be extracted.

6. Touch <Division>, then use the dial to select the Division.

Display	Performance division
Intro	Intro
Original	Original accompaniment pattern
Fill To Vari	From the fill-in to the variation
Variation	Variation accompaniment pattern
Fill To Ori	From the fill-in to the original
Ending	Ending

- * Only one measure can be extracted when “Fill To Vari” or “Fill To Ori” is selected for the Division. The number of measures may also be limited in other Divisions.

7. Touch <From> and <For>, then use the dial to select the measures to be extracted.

Touching <Play> at the bottom of the screen, you can listen to performance of the portion which you chose.

8. Repeat Steps 5–7 to create Styles for all of the Divisions.

* If no setting is made for a Division, it uses a simple drum pattern.

Deciding on a Style

9. When you're done making all the Division settings, touch <Execute>.

The User Style is recorded to the [User] button.

* If you turn off the power or record a new User Style, any User Style you've previously recorded is lost. If you do not want to delete the Style, save it to a floppy disk or to user memory. Take a look at "Saving a User Style" (p. 121).

* The following data is saved to the User Style. If a song includes data other than this, the results you get might not be what was intended.

- Keyboard performance data
- Amount of Reverb effect applied
- Amount of Chorus effect applied

○ Creating a Style in Manual Mode

When you create a Music Style in the Manual mode, you can clearly point up the differences in accompaniment for each individual chord.

Points to note when creating songs

- Record your performance with the three chord types of diminished seventh, major, and minor.
- It is convenient to record the sounds shown below for the Parts of the 16-track sequencer.

Chords	Rhythm	Bass	Accomp 1	Accomp 2	Accomp 3
Major	D (10)	3	4	5	6
Seventh	-	2	7	8	9
Minor	-	12	13	14	15

→The chords all share the same Rhythm Part.

→If you want to use the performance of other part, check out "Changing an Extracted Part" (p. 120)

Creating songs

1. Use the 16-track sequencer to record the song.

Record the song after referring to "Multitrack Recording with 16 Parts (16-Track Sequencer)" (p. 99) and other related sections.

When using music data, first select a song (p. 54).

Displaying the Style Converter screen

2. Press the [Menu] button.

3. Touch <Style Converter>.

The "Style Converter screen" appears.

4. Touch <Conv. Mode>, then use the dial to switch the mode to "Manual."

This makes the setting for the Manual mode.

After that, the steps are the same as for "Creating Styles in Auto Mode" (p. 119).

When you touch <Play> in the lower part of the screen, you can listen to the performance of the part selected with <Options>.

○ Changing an Extracted Part

You can extract and change part of a song created with 16-track sequencer.

1. At the Style Converter screen, touch <Part>.

A screen like the one shown below appears.

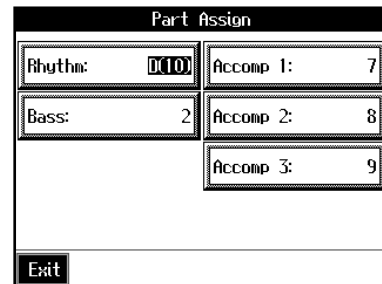

2. Touch the performance Part with settings you want to change.

3. Use the dial to specify which 16-track Sequencer performance part you want to extract.

→In the Manual mode, the type of chords appear at the bottom of the screen. Set the Parts for all chords.

4. Touch <Exit> to return to the Style Converter screen.

Saving a User Style

You can save the User Styles you create to floppy disks. With the KR105, you can save Styles to the user memory. When saved to the user memory, User Styles are not deleted when the power is turned off. You can also select Styles saved to the user memory by pressing the Music Style [User] button.

You can save up to 99 User Styles in user memory.

What is the User Memory?

The user memory is the area within the instrument where User Styles created with the KR105, sets of User Programs, and other such data are stored.

You can also copy User Styles and sets of User Programs saved on floppy disks.

Data saved to the user memory is not deleted, even when the KR105's power is turned off.

→ When you want to clear all of the content saved to the user memory and restore the settings to the factory settings on the KR105, refer to "Formatting the User Memory" (p. 139).

Preparations for saving data

When saving to a floppy disk, first insert a floppy disk in the disk drive.

1. Press the Music Style [User] button.

A "User Style screen" like the following appears.



If the User Style screen is not displayed, touch <User/ Disk> in the lower part of the screen.

2. Touch <File>.
3. Touch <Save>.

A "Save Style screen" like the following appears.

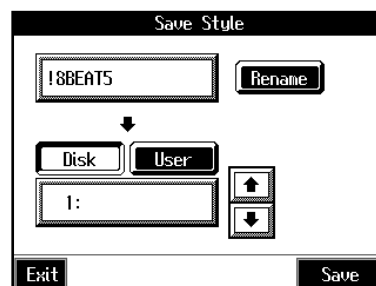

Determining the name of the Style to be saved

4. Touch <Rename>.

A "Rename screen" like the following appears.

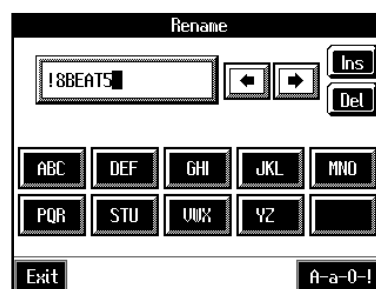

When you touch  , the cursor moves.

When you touch the icon for the character to be input, the character appears at the cursor position.

For example, touching the <ABC> icon in succession cycles you through the available choices in that character group (A→B→C→A...).

Each touch of <A-a-0-!> cycles the type of characters through "English (upper case)," "English (lower case)," "numerals," "symbols," then back to "English (upper case)."

When you touch , the character at the cursor position is deleted.

When you touch <Ins>, a space is inserted at the cursor position.

5. When you have finished with the name, touch <Exit>.

Determining the save destination

6. Touch <Disk> or <User>.

Touch <Disk> if you are saving to a floppy disk; touch <User> if you are saving to user memory.

- 7.** Touch   to select the save-destination number.

If a Style name is displayed, a style is already saved to that number.

If you select a number with a previously saved User Style and then save to that number, the previously saved User Style is deleted. If you do not want to delete the User Style being saved, select a number in the save-destination column that does not yet have a name.

- 8.** Touch <Save>.

The saving process starts.

* *Never turn off the power while the operation is in progress. Doing so will damage the KR105's internal memory, making it unusable.*

■ Deleting Saved User Styles

This deletes User Styles that have been saved to floppy disks or in user memory.

When deleting a User Style on a floppy disk, first insert the floppy disk in the disk drive.

- 1.** Press the Music Style [User] button.

A "User Style screen" appears.

If the User Style screen is not displayed, touch <User/Disk> in the lower part of the screen.

- 2.** Touch <File>.

- 3.** Touch <Delete>.

A "Delete Style screen" like the following appears.

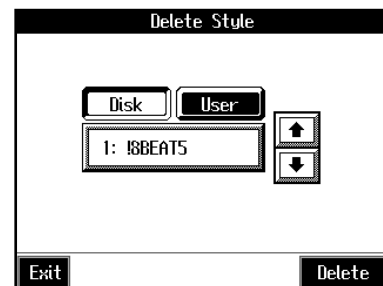

- 4.** Touch <Disk> or <User>.

Touch <User> if you are deleting a file from user memory; touch <Disk> if you are deleting a file from a floppy disk.

- 5.** Touch  or  to select the Style to be deleted.

- 6.** Touch <Delete>.

A screen like the one shown below appears.



- 7.** Touch <OK>.

The selected Style is deleted.

If you touch <Cancel>, the Style won't be deleted.

* *Never turn off the power while the operation is in progress. Doing so will damage the KR105's internal memory, making it unusable.*

Copying Styles on Disks to the User Memory

You can take User Styles saved on floppy disks and copy them to user memory.

You can also take User Styles saved in user memory and copy them to floppy disks.

1. Insert the disk with the Style to be copied in the disk drive.
2. Press the [User] button.

A "User Style screen" like the following appears.





If the User Style screen is not displayed, touch <User/Disk> in the lower part of the screen.

3. Touch <File>.
4. Touch <Copy>.

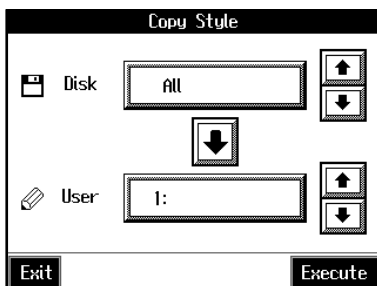
A "Copy Style screen" like the following appears.



Specifying the copy source

5. Touch <Disk>   to select the Style you want to copy.

When "All" is selected, all of the Styles on the disk are copied to user memory.

Specifying the Copy Destination

6. Touch <User>   to select the copy destination for the Style.

If a Style name is displayed, a style is already saved to that number.

If you select a number with a previously saved Style and then copy to that number, the previously saved Style is deleted. If you do not want to lose the Style being saved, select a number in the save-destination column that does not yet have a name.

7. Touch <Execute>.

Do not eject the floppy disk from the disk drive before the copy is finished.

The Style on the disk is copied to user memory.

* *Never turn off the power while the operation is in progress. Doing so will damage the KR105's internal memory, making it unusable.*

Copying Styles Saved in the User Memory to Disks

You can take Styles saved in user memory and copy them to floppy disks.

In this case, touch the large arrow icon in the center of the "Copy Style screen" in Step 4 above so that the arrow points upwards. This will copy user memory Styles to the floppy disk.

The rest of the procedure is identical to that used for copying Styles from disks to user memory.

9. Various Settings

Changing the Settings for One-Touch Arranger

■ Procedure

1. Press the One Touch Program [Arranger] button to display the Basic screen.



2. Touch <Options>.

A screen like the one shown below appears.

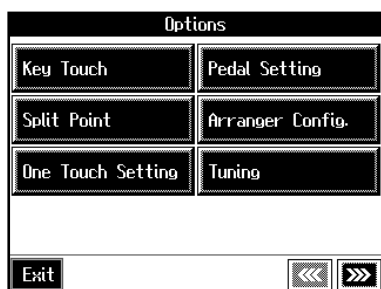

Parameter Name	Explanation
Key Touch	Refer to "Adjusting the Keyboard Touch (Key Touch)" (p. 124).
Split Point	Sets the key at which the keyboard is divided (the split point) (p. 125).
One Touch Setting	Selects the setting to be specified when the One Touch Program [Arranger] button is pressed (p. 125).
Pedal Setting	Assigns a variety of functions to the left and center pedals and the performance pads.
Arranger Config.	Sets the way the Automatic Accompaniment plays sounds (p. 128).
Tuning	You can play classical styles such as Baroque using historic temperaments (tuning methods).



You set the tuning and make a variety of other settings for the KR105 starting with the second page of the settings screen.

3. Touch the name of the parameter to be set.

Refer to the corresponding page for each function.

4. Touch <Exit> to return to the Basic screen.

■ Adjusting the Keyboard Touch (Key Touch)

You can vary the touch of the keyboard when you play the keys.

At Step 3 in "Procedure", touch <Key Touch>.

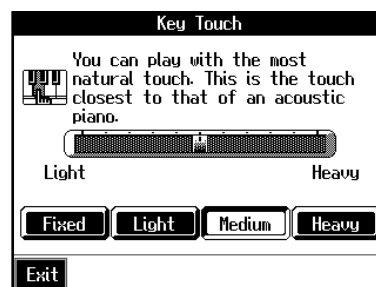

Display	Explanation
Fixed	Notes sound at an unchanging volume level, regardless of how lightly or forcefully you play the keyboard.
Light	This sets the keyboard to a light touch. You can achieve fortissimo (ff) play with a less forceful touch than usual, so the keyboard feels lighter. This setting makes it easier for children, whose hands have less strength.
Medium	This sets the keyboard to the standard touch. You can play with the most natural touch. This setting is closest to the response of an acoustic piano.
Heavy	This sets the keyboard to a heavy touch. You have to play the keyboard more forcefully than usual in order to play fortissimo (ff), so the keyboard touch feels heavier. This setting allows you to add more expression when playing dynamically.

Touch any of the icons <Fixed>, <Light>, <Medium>, or <Heavy>, to set the key touch for the keyboard.

To make fine adjustments, touch the slider in the screen.

Move the slider to the right to add resistance, and to the left to make the key touch lighter.

■ Changing the Keyboard's Split Point (Split Point)

This sets the point (the split point) where the keyboard is divided when specifying chords in the left hand while using the Automatic Accompaniment and when playing split performances (p. 26).

The setting is at "F#3" when the KR105 is powered up.

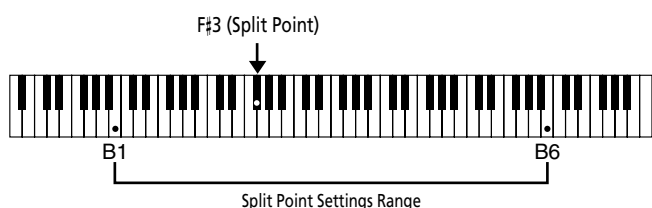

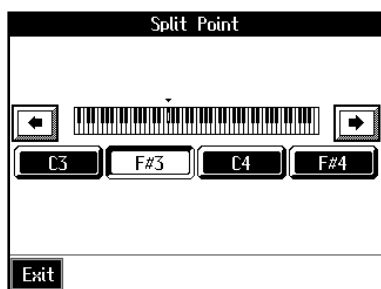

The key you chose for the split point belongs to the left-hand section of the keyboard.

At Step 3 in "Procedure" (p. 124), touch <Split Point>.



Touch either <C3>, <F#3>, <C4>, or <F#4> in the lower part of the screen.

The key you chose becomes the split point.

To set another key as the split point, touch   in the screen, then specify the key.

You can set the split point within a range of B1 to B6.

■ Changing Music Styles Without Changing the Tone or Tempo (One Touch Setting)

Normally, when you select a Music Style, the Tone and tempo settings suitable for that Music Style are selected automatically. However, you can also set it so the tempo and Tone settings don't change when you change Music Styles.

At Step 3 "Procedure" (p. 124), touch <One Touch Setting>.

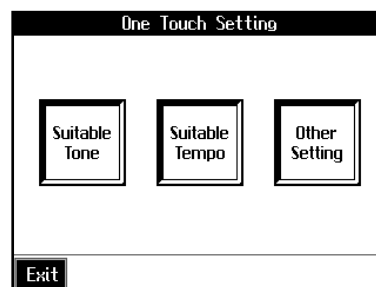

Display	Explanation
Suitable Tone	The suitable tone for a Music Style is selected automatically.
Suitable Tempo	The suitable tempo for a Music Style is selected automatically.
Other Setting	Other settings (Style Orchestrator, Part Balance, etc.) are changed automatically.

Touch each icon to switch individual settings on and off.

All items are set to ON when you turn on the power.

Parameters switched to OFF do not change, even when the Music Style is changed.

■ Assigning Functions to Pedals and Performance Pads (Pedal Setting/User Functions)

You can assign a variety of functions to the left and center pedals and the performance pads. You can call up the assigned functions just by pressing the corresponding pedal or pad.

NOTE

Use only the specified expression pedal (EV-7/5; sold separately). By connecting any other expression pedals, you risk causing malfunction and/or damage to the unit.

○ Assigning Functions to Pedals

At Step 3 of "Procedure" (p. 132), touch <Pedal Setting>.

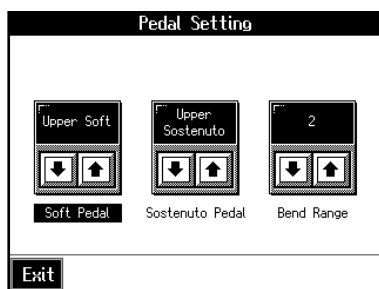

Touch <▲><▼> to assign functions to each of the pedals.

MEMO

Pressing the One Touch Program [Piano] button restores the piano performance functions to the pedals (p. 16).

○ Assigning Functions to Performance Pads

1. Press the [User Function] button and watch the indicator light up.

A screen like the one shown below appears.

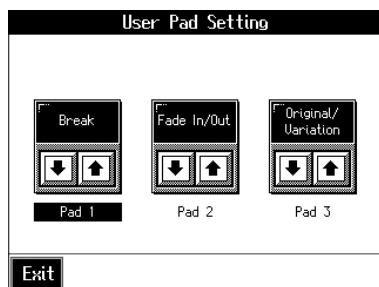

2. Touch <▲><▼> to assign functions to each of the Performance Pads.

MEMO

If you set the pedal as a dedicated switch for selecting User Programs, the function assigned to the pedal cannot be used. Refer to "Using the Pedal to Switch User Programs" (p. 97).

○ Functions that Can be Assigned (Pedals, Performance Pads)

Function	Explanation
Leading Bass	Toggles the Leading Bass function* on or off. The function stays on as long as the pedal to which this is assigned is pressed. When assigned to a Performance Pad, this is alternately switched on and off each time the pad is pressed.
No Chord	Only the Rhythm part is played. After No Chord is switched on, specifying a chord by playing the actual keys cancels the function, and all of the accompaniment parts are played.
Break	During the performance of Automatic Accompaniment, the accompaniment stops for one measure only.
Fill In to Variation	Performs the same function as the Fill In [To Variation] button (p. 46).
Fill In to Original	Performs the same function as the Fill In [To Original] button (p. 46).
Fill In	A fill-in is inserted, but the accompaniment pattern after that doesn't change.
Half Fill In to Variation	This plays a fill-in half a measure long, then switches to the Variation accompaniment pattern.
Half Fill In to Original	This plays a fill-in half a measure long, then switches to the Original accompaniment pattern.
Original/Variation	This changes the accompaniment pattern without inserting a fill-in.
Arranger Reset	When this function is used during Automatic Accompaniment, the accompaniment returns to the beginning of the Division (p. 35).
Intro 1/Ending 1	Performs the same function as the [Intro/Ending] button (p. 43). Intro 1 and Ending 1 are played.
Intro 2/Ending 2	Performs the same function as the [Intro/Ending] button (p. 43). Intro 2 and Ending 2 are played.
Arranger Start/Stop	Performs the same function as the [Start/Stop] button (p. 43).
Orchestra Up	This changes the accompaniment to a more elaborate arrangement (p. 48).
Orchestra Down	Changes the accompaniment to a simpler arrangement (p. 48).
Melody Intelligence	Turns the Melody Intelligence function on and off (p. 49).

Function	Explanation
Fade In/Out	This starts Automatic Accompaniment with a fade-in (where the volume gets progressively louder), ends it with a fade-out (where the volume gets progressively softer), then stops.
Rotary Slow/Fast	This switches the speed of the rotary effect* when you perform with an organ tone.
Glide	While the pedal or Performance Pad is held down, the pitch of the sound drops temporarily, returning to the original pitch when the pedal or Pad is released. This can be effective for simulating the performance of instruments like a Hawaiian guitar.
Composer Play/Stop	Performs the same function as the [▶ / ■ (Play/Stop)] button (p. 54).
Page Fwd	Press the pedal or the Pad turns the notation appearing on the KR105 display to the next page while the performance of a song is stopped.
Page Bwd	Press the pedal or the Pad turns the notation appearing on the KR105 display to the preceding page while the performance of a song is stopped.
Punch In/Out	During Punch-in Recording, this starts and stops recording (p. 105).
Tap Tempo	You can set the tempo according to the interval at which the pedal or pad is pressed (p. 67).

*** What is the leading bass function?**

The function that sounds the lowest note of a fingered chord as the bass tone is called "Leading Bass." When this function is turned on, the Bass Tone changes when chord inversions are used. Usually the tonic of the chord you play sounds as the bass tone.

*** What is the rotary effect?**

This adds a sort of spinning effect to the organ sound, similar to the sound when a rotary speaker is used.

Changing the speed increases or decreases the speed of this spinning effect.

○ **Functions that Can be Assigned (Pedals Only)**

Function	Explanation
Replay	Pressing the pedal during playback of a song stops the playback. When the pedal is released, playback resumes from the beginning of the measure that was playing when the pedal was pressed. When the pedal is pressed in rapid succession, the playback will resume backs up the same number of measures as the number of times the pedal is pressed.
Upper Sostenuto	The pedal functions as a sostenuto pedal (p. 16).
Upper Soft	The pedal functions as a soft pedal (p. 16).
Lower Damper	Applies a damper pedal effect to the sounds in the left-hand side of the keyboard during a split performance.
Bend Up	This raises the pitch of notes you play on the keyboard.
Bend Down	This lowers the pitch of notes you play on the keyboard.
Pedal EX1	When the pedal is pressed during a layer performance, the Tone volume changes between two levels, depending on how firmly the pedal is pressed. Pressing the pedal with "Pedal EX1" selected increases the Layer Tone volume. The Layer Tone is played at a fixed volume, regardless of how forcefully the keys are played.
Pedal EX2	Pressing the pedal with "Pedal EX2" selected increases the Layer Tone volume. The Layer Tone is played at a fixed volume, regardless of how forcefully the keys are played.
Pedal EX3	Pressing the pedal with "Pedal EX3" selected increases the Layer Tone volume, while the volume of the left-hand Tone is decreased. The Layer Tone is played at a fixed volume, regardless of how forcefully the keys are played.
Pedal EX4	Pressing the pedal with "Pedal EX4" selected increases the Layer Tone volume, while the volume of the right-hand Tone is decreased.

NOTE

The effect may not be applied correctly when you press a pedal if "Pedal EX1-4" is assigned to more than one pedal.

MEMO

Using the "Bend Up" or "Bend Down" function during a split performance (p. 25) changes the pitch of sounds in the right-hand side of the keyboard. Additionally, the range in which the pitch can change when the Bender effect is used is called the "bend range"; refer to "Changing the Bend Range (Pedal Setting)".

■ Changing the Bend Range (Pedal Setting)

The effect of smoothly raising or lowering the pitch of a played note is called the “bender effect.”

With the KR105, you can assign the bender function to a pedal, then apply the bender effect by depressing and releasing the pedal.

You can also make a setting that determines how much the pitch of the note changes when you apply the bender. The maximum range of change in pitch is called the “bend range.”

At Step 3 “Procedure” (p. 124), touch <Pedal Setting>.

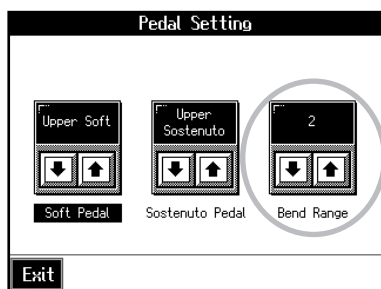

Touch <Bend Range>   to adjust the bend range setting.

You can set this to any value within a range of 1 to 12 (in half-tone steps, up to one octave).

■ Changing How Chords Are Played and Specified (Arranger Config)

This changes the settings determining how Music Styles are played, and how the keys are pressed to specify chords.

What are the Chord Tone and Bass Tone?

When the Automatic Accompaniment is stopped, and Sync Start (p. 43) is turned off, chords are produced when you play in the left-hand side of the keyboard. This is called the “chord tone,” and the root of the chord that is played at the same time is called the “bass tone.”

At Step 3 “Procedure” (p. 124), touch <Arranger Config>.

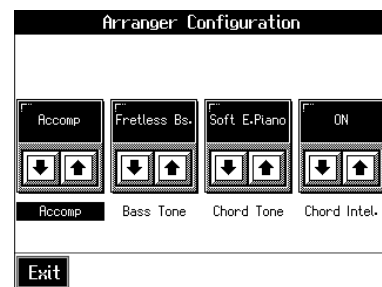

Touch <▲><▼> of each item to make settings.

Parameter Name	Value	Explanation
Accomp	Accomp	All Music Style parts are played.
	Chord&Bs	Only chord Tones, and bass Tones are played.
Bass Tone	OFF, Acoustic Bs., A. Bass+Cymb1, Fingered Bs., Picked Bass., Fretless Bs., Slap Bass1, Organ Bass, Synth Bass 101, Thum Voice	Selects the bass Tone. When set to “OFF,” no tone is played.
Chord Tone	OFF, E.Piano 1, E. Piano 2, Soft E. Piano, Hard E. Piano, Slow Strings, Strings, Choir, Doos Voice	Selects the chord Tone. When set to “OFF,” no tone is played.

Parameter Name	Value	Explanation
Chord Intel.	ON, OFF	The function that allows the KR105 to recognize accompaniment chords when you press only one or two keys during automatic accompaniment is called the "Chord Intelligence function". When set to "OFF", play all of the notes to specify chords.

What is Chord Intelligence?

"Chord Intelligence" (p. 37) is the name of the function that recognizes the chords being specified for an accompaniment when only one or two keys of the chords have been pressed, which can be used while automatic accompaniment is active.

How to play chords in the Chord Intelligence mode:

¥ Intelligence 1

Major



Major



Major Seventh



Minor

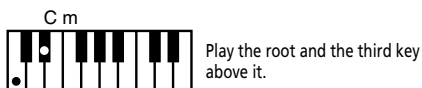

Minor Seventh

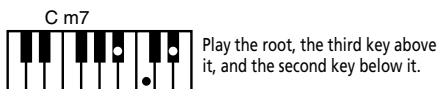

Diminished

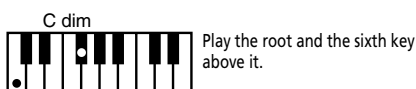

¥ Intelligence 2

Major



Seventh

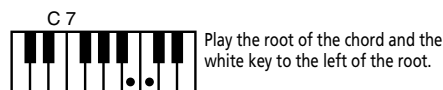

Minor



Minor Seventh

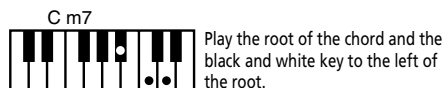

■ Changing the Tuning (Tuning)

○ Choosing the Tuning

You can play classical styles such as Baroque using historic temperaments (tuning methods).

Most modern songs are composed for and played in equal temperament, the most common tuning in use today. But at one time, there were a wide variety of other tuning systems in existence. By playing in the temperament that was in use when a composition was created, you can experience the sonorities of chords originally intended for that song.

At Step 3 in "Procedure" (p. 132), touch <Tuning>.

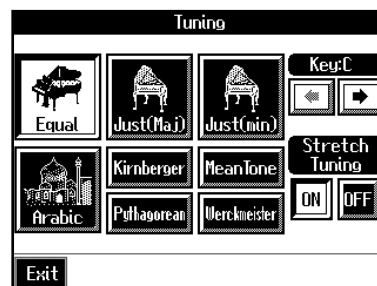



You can choose from among the eight tunings described below.

Tuning system	Characteristics
Equal	This temperament divides the octave into 12 equal parts. All intervals will be slightly out of tune by the same amount. This setting is in effect when you turn on the power.
Just (Maj)	This temperament makes the 5th and 3rd intervals pure. It is unsuited to playing melodies and cannot be transposed, but is capable of beautiful sonorities.
Just (min)	Just intonation differs between major and minor keys. The same results as major can be obtained in a minor key.
Arabic	This tuning is suitable for the music of Arabia.
Kirnberger	This temperament is a modification of meantone temperament and just intonation, allowing more freedom of modulation. Performances are possible in all keys (III).
Pythagorean	This temperament is based on the theories of the Greek philosopher Pythagoras, and has pure fourths and fifths. Chords containing a third will sound impure, but melodies will sound good.
Meantone	This temperament is a partial compromise of just intonation in order to allow modulation.
Werkmeister	This temperament is a combination of meantone and Pythagorean temperaments. It allows you to play in all keys. (First method, number three.)

Touch any one of the icons to choose the tuning system.

When playing in a temperament other than equal temperament, you must specify the tonic (the note corresponding to C for a major key, or to A for a minor key) of the key in which you will play.

Touch <Key>   to select the tonic.

If you have selected equal temperament, it is not necessary to select the tonic.

○ Setting the Tuning Curve (Stretch Tuning)

Pianos are generally tuned so that the low range is flatter and the high range is sharper than equal tempered pitches. This method of tuning is unique to the piano, and is known as “stretched tuning.”

A graph that shows the changes in pitch of actual tuning compared with the changes in equal temperament pitch is called a tuning curve. Changing the tuning curve produces

subtle variations in the reverberations of the chords you play.

Touch the Stretch Tuning <ON> or <OFF> icon to select the tuning curve.

When set to “ON,” the tuning curve features extended low and high ranges (Stretch Tuning). It is suitable for piano solos. This setting is selected when the power is turned on.

When set to “OFF,” the standard tuning curve is used. It is suitable when playing in an ensemble with other instruments.

Placing a Marker in the Middle of a Measure

A marker is normally placed at the start of the selected measure, but you can also set it so that a marker is placed at a position partway through a measure.



For detailed information about Marker, refer to “Setting Markers for Repeated Practice (Marker)” (p. 70).

1. Press the [Count/Marker] button.

The Count screen appears.

2. Touch <Marker>.

The Marker screen appears.

3. Touch <Option>.

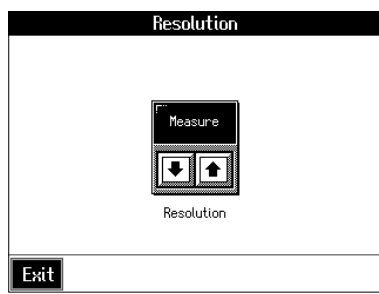

4. Touch <Resolution> to choose the marker setting.

Indication	Explanation
Measure	This lets you place a marker at the beginning of the measure.
Beat	This lets you place a marker at the beginning of the beat.

5. Touch <Exit> to go back to the Marker screen.

Changing the Settings for the Count



For detailed information about count, refer to “Match the Tempo Before You Begin Playing (Count In)” (p. 68) and “Having a Count Sound Play at the End of the Intro (Countdown)” (p. 45).

1. Press the [Count/Marker] button.

The Count screen (p. 68) appears.

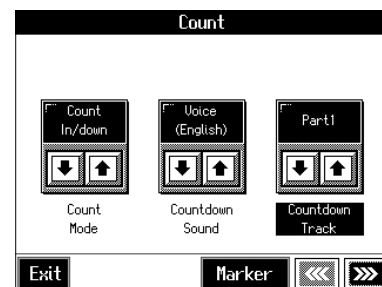

2. Touch <▲><▼> of each item to make settings.

3. Touch <Exit> to return to the main screen.

Parameter Name	Value
Count Mode Specify what type of count will be added.	Count In (add a count before the performance), Countdown (add a count only before you begin playing), Count In/down (add both a count-in and a countdown)
Countdown Sound Specify the countdown sound.	Voice (Japanese), Voice (English)
Countdown Track Specify the track or part that will determine the beginning of the performance when added a countdown.	Lower & Upper Tracks Lower Track Upper Track Part 1~16
Count-In Sound Specify the count-in sound.	Stick, Click, Electronic, Voice (Japanese), Voice (English), Wood Block, Triangle Castanets, Handclap Animal
Measures Specify the length (number of measures) of the count-in.	1, 2

Parameter Name	Value
Repeat When "Repeat" is turned ON on the Marker screen (p. 72) this specified whether the count-in will sound each time the range between the markers is repeated, or only the first time.	First, Every

Changing the Settings for One-Touch Piano

■ Procedure

1. Switch to the Basic screen, or press the One Touch Program [Piano] button.

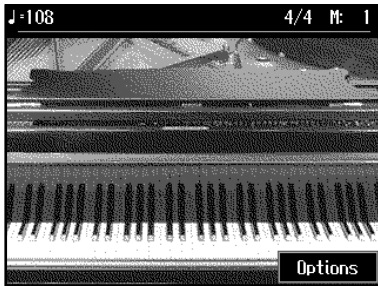

2. Touch <Options>.
A "Functions screen" like the following appears.

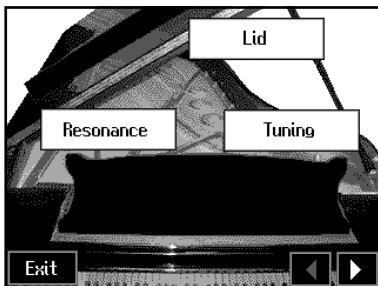

3. Use <<>> to select the page that contains the parameter you need.
4. Touch the field of the parameter you want to set.

■ Lid: Adjusting the piano tone

With the KR105, you can simulate changes in tone of a grand piano that come about when the piano's lid is opened or closed.

1. After performing steps (1)~(3) above, touch <Lid> to jump to the following page:

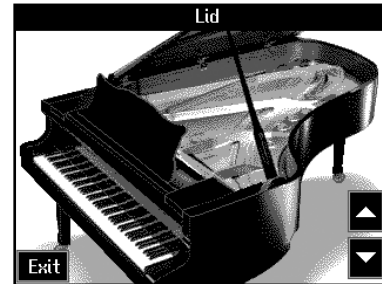

2. Use <▲> and <▼> to adjust the amount of the "opening" of the piano lid.

Each time you press the <▲> button, the lid of the piano shown on the screen will open more, creating a brighter tone.

Each time you press the <▼> button, the lid of the piano shown on the screen will close more, creating a mellower tone.

3. Touch <Exit> to return to the previous page.

■ Adjusting Resonance (Resonance)

You can adjust the resonance (Sympathetic Resonance) that becomes audible when the damper pedal is depressed.

MEMO

This setting is enabled only with the piano tones. You cannot set this for other tones.

1. After performing steps (1)~(3) on p. 132, touch <Resonance> to jump to the following page:

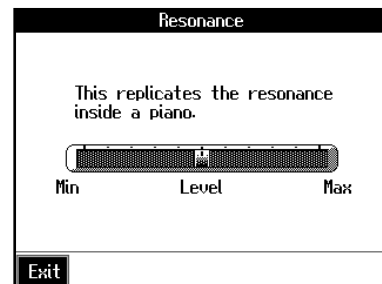

2. Use the on-screen slider icon or the dial to set the desired resonance level.
3. Touch <Exit> to return to the previous page.

■ Changing the Tuning (Tuning)

1. After performing steps (1)~(3) on p. 132, touch <Tuning> to jump to the following page:

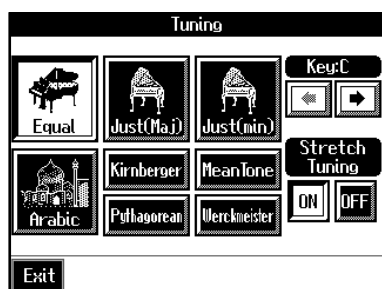

2. Press the fields of the desired tuning (see below).
3. Touch <Exit> to return to the previous page.

○ Choosing the Tuning

You can play classical styles such as Baroque using historic temperaments (tuning methods).

Most modern songs are composed for and played in equal temperament, the most common tuning in use today. But at one time, there were a wide variety of other tuning systems in existence. By playing in the temperament that was in use when a composition was created, you can experience the sonorities of chords originally intended for that song.

You can choose from among the eight tunings described below.

Tuning system	Characteristics
Equal	This temperament divides the octave into 12 equal parts. All intervals will be slightly out of tune by the same amount. This setting is in effect when you turn on the power.
Just (Maj)	This temperament makes the 5th and 3rd intervals pure. It is unsuited to playing melodies and cannot be transposed, but is capable of beautiful sonorities.
Just (min)	Just intonation differs between major and minor keys. The same results as major can be obtained in a minor key.
Arabic	This tuning is suitable for the music of Arabia.
Kirnberger	This temperament is a modification of meantone temperament and just intonation, allowing more freedom of modulation. Performances are possible in all keys (III).

Tuning system	Characteristics
Pythagorean	This temperament is based on the theories of the Greek philosopher Pythagoras, and has pure fourths and fifths. Chords containing a third will sound impure, but melodies will sound good.
Meantone	This temperament is a partial compromise of just intonation in order to allow modulation.
Werkmeister	This temperament is a combination of meantone and Pythagorean temperaments. It allows you to play in all keys. (First method, number three.)

When playing in a temperament other than equal temperament, you must specify the tonic (the note corresponding to C for a major key, or to A for a minor key) of the key in which you will play.

Touch <Key > to select the tonic.

If you have selected equal temperament, it is not necessary to select the tonic.

○ Setting the Tuning Curve (Stretch Tuning)

Pianos are generally tuned so that the low range is flatter and the high range is sharper than equal tempered pitches. This method of tuning is unique to the piano, and is known as “stretched tuning.”

A graph that shows the changes in pitch of actual tuning compared with the changes in equal temperament pitch is called a tuning curve. Changing the tuning curve produces subtle variations in the reverberations of the chords you play.

Touch the Stretch Tuning <ON> or <OFF> field to select the tuning curve.

When set to “ON,” the tuning curve features extended low and high ranges (Stretch Tuning). It is suitable for piano solos. This setting is selected when the power is turned on.

When set to “OFF,” the standard tuning curve is used. It is suitable when playing in an ensemble with other instruments.

■ Changing How Rapidly Sounds Are Expressed According to the Force Used to Play the Keys (Hammer Response)

You can adjust the timing with which sounds are produced according to the force used to play the keys. This function is called "Hammer Resonance."

When a key is pressed on an acoustic piano, it causes a hammer to move and strike the strings, producing sound. The hammers move more slowly when the keys are played gently, meaning that sounds are produced just slightly later than when you play the keyboard with greater force.

When the Hammer Response function is on, the interval between the time a key is pressed and the time sound is produced varies according to the force used to play the key. The more gently the key is pressed, the more delayed the timing of the sound.

1. Switch to the Basic screen, or press the One Touch Program [Piano] button.

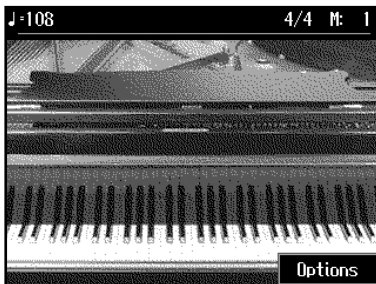

2. Touch <Options>.
3. Use <<>> to select the following page:

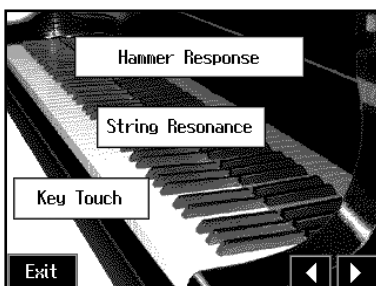

4. Touch <Hammer Response>.

5. Touch <ON> to turn the Hammer Response function on.

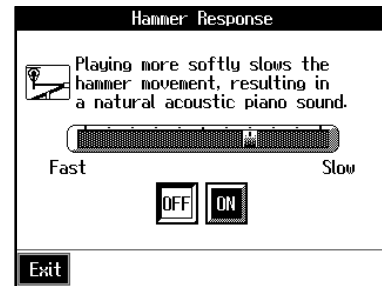

Touch <OFF> to cancel the effect.

6. Touch the screen slider to adjust the time it takes for a key to sound after it is pressed.

The more the slider is moved to "Slow," the more delayed the sound is when the keys are played softly. Conversely, sounds are produced more quickly when the keys are played with greater force.

■ Adjusting the Resonant Sounds (String Resonance)

When the keys are pressed on an acoustic piano, the strings for keys that are already pressed also vibrate sympathetically. The function used to reproduce this resonance is called "String Resonance."

1. After performing steps (1)~(3) on p. 132, touch <String Resonance> to jump to the following page:

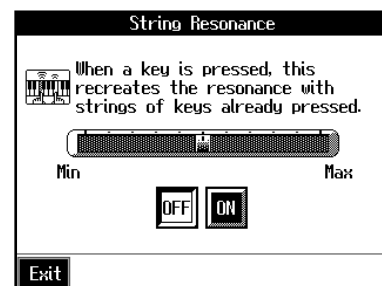

Touch <ON> to turn the String Resonance function on. Touch the screen slider to adjust the amount of effect applied.

Moving the slider to "Max" increases the amount of resonance effect applied. Moving the slider to "Min" reduces the amount of effect applied.

Touch <OFF> to cancel the effect.

■ Adjusting the Keyboard Touch (Key Touch)

You can vary the touch of the keyboard when you play the keys.

1. After performing steps (1)~(3) on p. 132, touch <Key Touch> to jump to the following page:



Display	Explanation
Fixed	Notes sound at a constant volume level, regardless of how lightly or forcefully you play the keyboard.
Light	This sets the keyboard to a light touch. You can achieve fortissimo (ff) play with a less forceful touch than usual, so the keyboard feels lighter. This setting makes it easier for children, whose hands have less strength.
Medium	This sets the keyboard to the standard touch. You can play with the most natural touch. This setting is closest to the response of an acoustic piano.
Heavy	This sets the keyboard to a heavy touch. You have to play the keyboard more forcefully than usual in order to play fortissimo (ff), so the keyboard touch feels heavier. This setting allows you to add more expression when playing dynamically.

Touch any of the icons <Fixed>, <Light>, <Medium>, or <Heavy>, to set the key touch for the keyboard.

To make fine adjustments, touch the slider in the screen.

Move the slider to the right to add resistance, and to the left to make the key touch lighter.

Other Settings

The following settings are shared by One-Touch [Piano] and One-Touch [Arranger]. Some of them can be found on pages 3 and 4 for [Piano] as well as on pages 2 and 3 for [Arranger]. Others can only be selected one one page, even though they apply to both [Piano] and [Arranger].

Parameter	Explanation
Master Tune	Sets the KR105's standard pitch (p. 136).
Language	Selects the language used in the display (p. 136).
Opening Message	Sets the message that appears when the power is turned on (p. 136).
MIDI Ensemble	Refer to p. 145.
User Image Display	Selects the image data and display used (p. 137).
MIDI Setting	Refer to p. 146.
Program Change	Refer to p. 146.
Beat Indicator	Allows you to specify whether or not you want to use the beat indicator (p. 137).
MIDI Sync	Refer to p. 144.
Memory Backup	Stores edited settings and other data to the KR105 (p. 138).
Factory Reset	Restores the content stored with Memory Backup to the original factory settings (p. 138).
Touch Screen	Allows for calibration of the touch screen (p. 139).

■ Changing Standard Pitch (Master Tune)

“Standard pitch” generally refers to the pitch that is heard when you play middle A. When performing in an ensemble with other instruments, adjust the standard pitch so that the instruments of the ensemble match. Tuning all the instruments to a standard pitch is called “master tuning.”

At Step 3 in “Procedure” (p. 132), touch <Master Tune>. A screen like the one shown below appears.



Touch <▲><▼> to change the pitch.

Standard pitch can be set to any value from 415.3–466.2 Hz.

■ Changing the Language (Language)

Four choices are available for the language used in displaying information on the screen.

At Step 3 in “Procedure” (p. 132), touch <Language>. A screen like the one shown below appears.

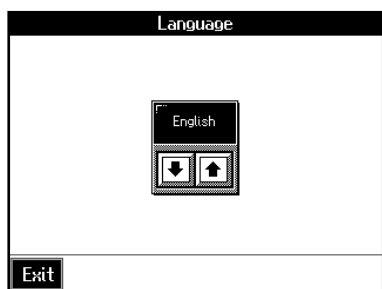

Touch <▲><▼> to select the language.

Available settings

English, German, French, Spanish

NOTE

German, Spanish, and French are displayed for some functions. Other screens will be displayed in English.

■ Changing the Screen Message When the Power Is Turned On (Opening Message)

You can modify this screen to show your favorite phrase when the power is turned on.

At Step 3 in “Procedure” (p. 132), touch <Opening Message>. A screen like the one shown below appears.

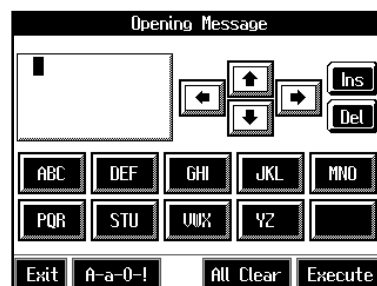

Use     to move the cursor.

When you touch the character icon, the character is input where at the position.

When you touch the icon for the character to be input, the character appears at the cursor position. For example, touching the <ABC> icon in succession cycles you through the available choices in that character group (A→B→C→A...).

Each touch of <A-a-0-!> cycles the type of characters through “English (upper case),” “English (lower case),” “numerals,” “symbols,” then back to “English (upper case).”

When you touch , the character at the cursor position is deleted.

When you touch <Ins>, a space is inserted at the cursor position.

When you have finished inputting the characters, touch <Execute>.

NOTE

Never turn off the power while the display indicates <Executing...>. Doing so will damage the KR105’s internal memory, making it unusable.

MEMO



If you touch <All Clear> at the bottom of the screen and then touch <Execute>, the display reverts to the screen that normally appears when you turn on the power to the instrument.

■ Turning Off the Beat Indicator (Beat Indicator)

The beat indicator normally flashes in time with the metronome, Music Style, or song tempo. However, if you wish, it can be set to remain off at all times.

At step 3 in "Procedure" (p. 132), touch <Beat Indicator>. A screen like the one shown below appears.



Touch   to turn the setting ON, or OFF (so the beat indicator remains off).

■ Selecting Images To Be Shown on the KR105 (User Image Display)

You can have image data from computers and other devices shown on the onboard display.

At Step 3 in "Procedure" (p. 132), touch <User Image Display>.

A screen like the one shown below appears.



Selecting the images to be displayed

First, take a floppy disk to which the image data stored in the KR105 has been saved, and insert the disk in the disk drive.

1. Touch <File>.

A screen like the one shown below appears.



2. Touch the name of the stored image data.

When you touch <Preview>, you can then show the selected image data on the display selected in Step 1.

3. Touch <Save>.

The selected image data is stored.

4. Touch <Exit> to return to the previous screen.

To clear the stored image data, touch <Erase>.

- **Image data that KR105 can display**

Size	320 x 240 pixels
Color	1 bit (2 colors)
Format	BMP format * <i>The KR105 cannot deal with compressed image data.</i>
Name	1–8 characters in length (lowercase is ok). A filename extension of ".BMP" (uppercase characters) must be added after the name. The following characters can be used to name an image. A B C D E F G H I J K L M N O P Q R S T U V W X Y Z a b c d e f g h i j k l m n o p q r s t u v w x y z 0 1 2 3 4 5 6 7 8 9 # \$ % & ' () - @ ~ { } ^ _ ! * <i>If you use a character that cannot be used in a name, it will be replaced by another character when displayed.</i>

■ Remembering the Settings Even When the Power is Turned Off (Memory Backup)

Normally, the various settings revert to their default values when the power is turned off. However, you can specify that the settings will be remembered even when the power is turned off. This function is called "Memory Backup."



For more on the settings stored using Memory Backup, refer to "Parameters Stored in Memory Backup" (p. 167).

At step 3 in "Procedure" (p. 132), touch <Memory Backup>. A screen like the one shown below appears.

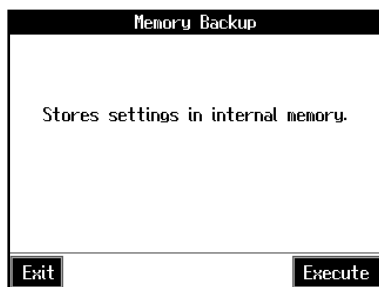

Touch <Execute>.

The confirmation message appears on screen.

Touch <OK> to store the setting.

When the setting has been stored in memory, the previous screen will reappear.

NOTE

Never turn off the power while the display indicates <Executing...>. Doing so will damage the KR105's internal memory, making it unusable.

■ Restoring the Factory Settings (Factory Reset)

You can return the content stored with "Memory Backup" (p. 138) and the User Programs (p. 93) to their original factory settings. This operation is referred to as "Factory Reset."

NOTE

When you perform a Factory Reset, all settings that have been stored in memory up to then are erased and reset to their factory defaults.



This operation does not return the touch screen calibration settings to the original factory condition. To return the touch screen calibration settings to the original factory settings, refer to "Returning the Touch Screen Calibration Settings to the Original Factory Settings" (p. 139)



When you want to restore the content registered to the KR105's User memory to the factory condition, refer to "Formatting the User Memory" (p. 139).

At step 3 in "Procedure" (p. 132), touch "Factory Reset."

A screen like the one shown below appears.



Touch <Execute>.

The confirmation message appears on screen.

Touch <OK> to restore the original factory settings.

When the setting is changed, the previous screen returns.

When you touch <Cancel>, the settings are left untouched, and you're returned to the previous screen.

NOTE

Never turn off the power while the display indicates <Executing...>. Doing so will damage the KR105's internal memory, making it unusable.

■ Calibrating the Touch Screen (Touch Screen)

If you've been using the touch screen for some time, the pointer may be shifted, making the KR105 react incorrectly. You should correct this displacement when necessary by performing calibration (repositioning).

At step 3 in "Procedure" (p. 132), touch "Touch Screen."

A screen like the one shown below appears.

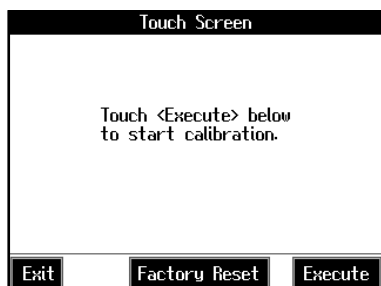

Touch <Execute>.

Touch the points indicated.

NOTE

Do this carefully, because touching a location that's different from the one indicated for the pointer may make the displacement even worse. Be sure to touch the pointer accurately.

When the calibration is finished, touch <Write> to store the settings.

NOTE

If you don't write them to memory, the calibration settings will be discarded as soon as the power is switched off.

Returning the Touch Screen Calibration Settings to the Original Factory Settings

If you touch <Factory Reset> in the above screen, the touch screen calibration settings revert to the original factory settings.

Formatting the User Memory

The KR105 features an internal storage area where you can save recorded performances and User Styles. This space is called the "User Memory."

The following content is stored to the user memory.

- Content registered to the "Favorites" (p. 59)
- Sets of saved User Programs (p. 94)
- User Styles saved on user memory (p. 121)
- Image files set with the "User Image settings" (p. 137)

To delete all of the content held in the user memory and restore the original factory settings, carry out the following procedure.

1. Press the [Song/File] button.
2. Touch <File>.
3. Touch <Format User Memory>.

A screen like the one shown below appears.



4. Touch <OK>.

All of the content in the user memory is deleted. If you touch <Cancel>, the deletion is cancelled, and you're returned to the previous screen.

NOTE

Never turn off the power while the display indicates <Executing...>. Doing so will damage the KR105's internal memory, making it unusable.

MEMO

Carrying out this operation does not initialize any settings other than the user memory settings. To restore settings other than those for the user memory to the original factory settings, carry out Factory Reset (p. 138).

Automatically Starting the Quick Tour

You can set the instrument so that the Quick Tour starts automatically with no operation required.

1. Simultaneously press the [Transpose] and [Reverb] buttons.

The Quick Tour screen appears.

2. Touch <Option>.



3. Touch <ON> or <OFF>.

When set to "ON," the Quick Tour starts when you turn on the power. The demo stops as soon as you carry out any kind of operation. If no operation is performed for 5–10 minutes after that, the automatic demo starts again.

When set to "OFF," the Quick Tour does not start unless you touch the Quick Tour screen icon.

4. Touch <Exit> to return to the Quick Tour screen.

* For more information about Quick Tour, refer to the Quick Start.

Disabling Functions Other Than Piano Performance (Panel Lock)

The "Panel Lock" function locks the KR105 in a state where only piano performance can be used, and all buttons will be disabled. This prevents the settings from being inadvertently modified even if children press the buttons accidentally.

* In the Panel Lock state, only the grand piano sound can be played.

1. Turn down the volume all the way.
2. Press the [Power] switch to turn off the power.
3. While holding down the [Wonderland/Game] button, press the [Power] switch and turn on the power.

Then, continue to hold down the button for a few seconds.

All buttons except for piano play are disabled.

Adjust the volume. When you play the keyboard, the grand piano sound will be heard.

To undo the Panel Lock function, turn the volume down to the minimum, and turn on the power once again.

Detailed Song Playback Settings

■ Changing the Tone Settings When Playing Back Songs (Play Mode)

With the normal setting, GS tones (sounds that are compatible with other GS instruments) will normally be used to play back song data. By changing this setting, you can play back song using KR-specific tones for certain portions of the data.



For detailed information about GS, refer to "About the KR105's Sound Generator" (p. 168).

1. Press the [Menu] button.

The Menu screen appears.

Touch   to switch the screens.

2. Touch <Play Mode>.

A screen like the one shown below appears.

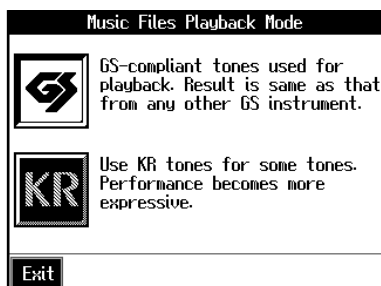

3. Touch the icon to choose the setting.

Icon	Explanation
GS	Playback uses GS-compatible tones for performances that sound like other GS instruments.
KR	Playback uses KR105 tones for greater expressiveness. However, differences may appear when playing back using devices other than the KR105.

4. Touch <Exit> to go back to the Menu screen.

5. After changing this setting, try selecting the song once again.

For more detailed information about selecting a song, refer to "Playing a Song" (p. 54).

■ Viewing Song Information (Information)

You can view file names and other information concerning songs.

1. Press the [Song/File] button.

2. Touch <File>.

3. Touch <Information>.

A song information is displayed.

■ Hiding the Lyrics (Lyrics)

Some commercially available music files for use in karaoke, as well as some of the internal songs include lyrics data. When you play such music files, the lyrics automatically appear in the screen. If you do not want lyrics to appear automatically, set this to "OFF."

1. Press the [Menu] button.

The Menu screen appears.

Touch   to switch the screens.

2. Touch <Lyrics>.

A screen like the one shown below appears.

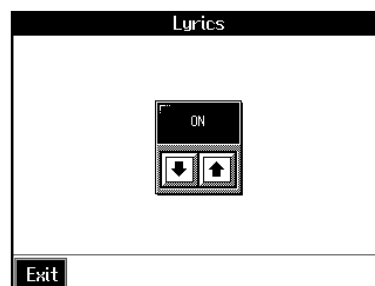

3. Touch to select the setting.

Display	Explanation
ON	Lyrics are displayed automatically (when performance data containing lyrics is played back).
OFF	Lyrics are not displayed, even if the song data being played back contains lyrics data.

4. Touch <Exit> to return to the Menu screen.



Even when this is set to "OFF," you can still have the lyrics be displayed by touching <  > when it appears in the Piano or Basic screen (p. 19).

MEMO

The screen may be switched when you press the button while the Lyrics screen is displayed. To have the lyrics displayed again, touch < Lyrics > on the Piano or Basic screen, or stop playback of the song, then press the [▶ / ■ (Play/Stop)] button.

■ Changing the Parts Assigned to the Track Buttons During SMF Playback (Track Assign)

Normally, when playing back Roland Piano Digital-compatible SMFs (p. 168), the lower part is assigned to the [3/Lower] button, and the upper part is assigned to the [4/Upper] button. However, assignment of the upper and lower parts may differ with some SMF data.

If you cannot get the upper and lower parts to work well set on "Auto," then change the setting to "2/1 Part" or "3/4 Part."

MEMO

This setting is effective with SMF format song data.
This is not effective with the internal songs.

1. Press the [Menu] button.

The Menu screen appears.

Touch   to switch the screens.

2. Touch <Track Assign>.

A screen like the one shown below appears.

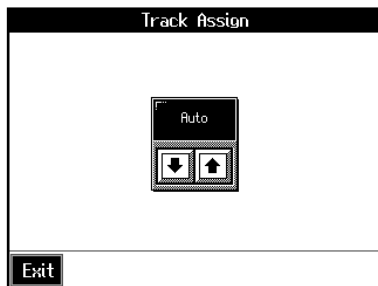

3. Touch to select the setting.

Display	Explanation
Auto	The part assigned to each track will be determined automatically, depending on the song data.
2/1 Part	Part 1 will be assigned to the upper part track, part 2 to the lower part track, and part 3 to the user track.
3/4 Part	Part 4 will be assigned to the upper part track, part 3 to the lower part track, and part 1 to the user track.

4. Touch <Exit> to return to the Menu screen.

After changing this setting, try selecting the song once again.

For more detailed information about selecting a song, refer to "Playing a Song" (p. 54).

10. Connecting External Devices

You can connect the KR105 to external devices such as audio equipment, MIDI instruments and computer.

Connecting Video Equipment (V-LINK)

Connecting the KR105 to a V-LINK compatible image device allows you to control the images with the KR105.

V-LINK (**V-LINK**) is functionality promoted by Roland that allows linked performance of music and visual material. By using V-LINK-compatible video equipment, visual effects can be easily linked to, and made part of the expressive elements of a performance.

NOTE

To prevent malfunction and/or damage to speakers or other devices, always turn down the volume, and turn off the power on all devices before making any connections.

○ Connection Examples:

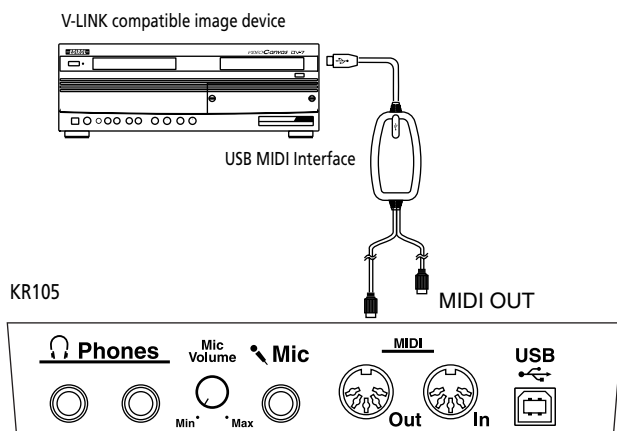

■ Using the V-LINK function

1. Press the One Touch Program [Piano] button.
2. Press the [Option] button.
3. Touch <V-LINK>.
4. Touch <ON>.

Switches to Image Control mode.

You can control images using the twelve keys at the left end of the keyboard.

When V-LINK is on, "V-LINK" is indicated in the Basic screen and other screens.

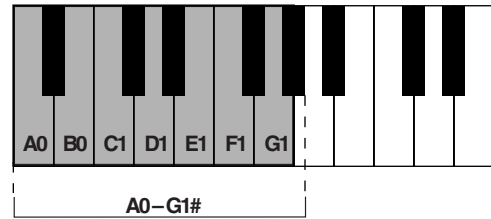

While V-LINK is switched on, no sound is produced when you press any of the twelve keys at the left end of the keyboard.

5. Touch <OFF> to cancel the V-LINK function.

Connecting MIDI Devices

By connecting an external MIDI device and exchanging performance data, you can control one device from the other. For instance, you can output sound from the other instrument or switch Tones on the other instrument.

What's MIDI?

MIDI, short for "Musical Instrument Digital Interface," was developed as a universal standard for the exchange of performance data between electronic instruments and computers.

The KR105 is equipped with MIDI connectors to let it exchange performance data with external devices. These connectors can be used to connect the KR105 to an external device for even greater versatility.

* A separate publication titled "MIDI Implementation" is also available. It provides complete details concerning the way MIDI has been implemented on this unit. If you should require this publication (such as when you intend to carry out byte-level programming), please contact the nearest Roland Service Center or authorized Roland distributor.

■ Connectors

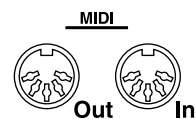

MIDI Out Connector

Connect this to the MIDI In connector on an external MIDI device using a MIDI cable (sold separately).

Performance data when you play the keyboard or depress a pedal is sent from this connector to the external MIDI connector.

MIDI In Connector

Connect this to the MIDI Out connector on an external MIDI device using a MIDI cable (sold separately).

This receives MIDI messages that are sent from external MIDI devices. The KR105 receiving MIDI messages can output sounds, exchange tones and perform other operations.

* External MIDI devices can't be used for remotely changing the Tones played by the KR105's keyboard.

■ Making the Connections

* To prevent malfunction and/or damage to speakers or other devices, always turn down the volume, and turn off the power on all devices before making any connections.

1. Turn the volume all the way down on the KR105 and on the device you're about to connect.
2. Switch off the power to the KR105 and the device you're about to connect.
3. Use a MIDI cable (sold separately) to connect the MIDI connectors to each other.

Please refer to the connection examples below.

4. Switch on the power to the KR105 and the connected device.
5. Adjust the volume level on the KR105 and the connected device.
6. You should also set the MIDI settings as needed.

For details on the MIDI-related settings, refer to p. 146–p. 147.

○ Connection Examples:

Setup with a MIDI Sequencer

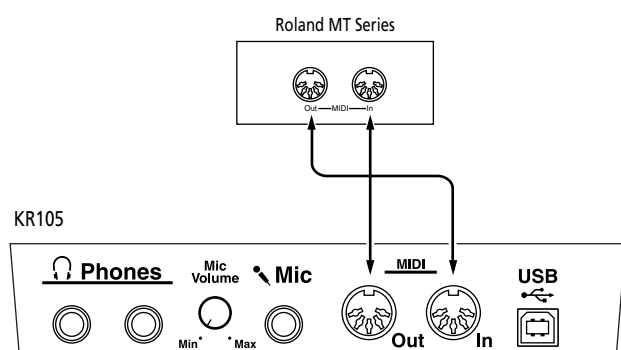

* When the KR105 is connected to a MIDI sequencer, set it to Local OFF. Refer to "Disconnecting the Internal Sound Generator and Keyboard (Local Control)" (p. 146).

Connecting with a MIDI Sound Module

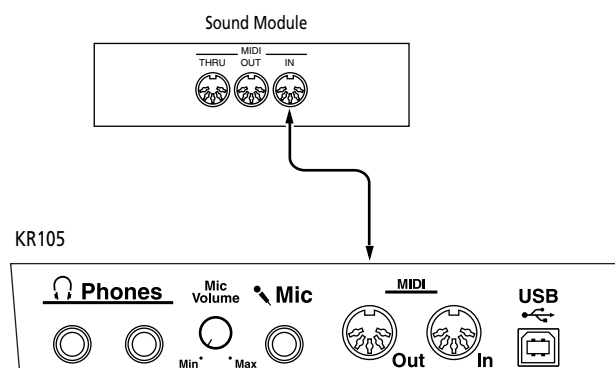

Synchronizing with Connected MIDI Devices

You can have connected MIDI devices played by the tempo produced by the KR105; you can also have the tempo produced by connected MIDI devices play the KR105. This setting is called the "MIDI Sync."

Having connected MIDI devices work at the same tempo, and start and stop at the same timing is called "synchronization."

1. Switch to the Basic screen, or press the One Touch Program [Piano] button.
2. Touch <Options>.
3. Touch <MIDI Sync>.

The following screen is appeared.

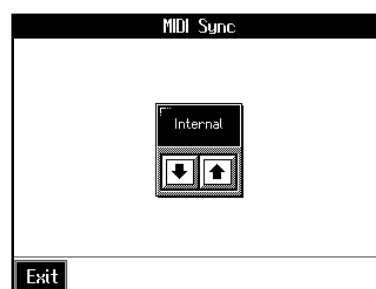

4. Touch <▲><▼> to make the setting.

Displayed	Meaning
Auto	The KR105's tempo as well as the starting and stopping of playback and recording is controlled by the MIDI device connected to the KR105's MIDI In connector. When there is no MIDI device connected, then these operations can be performed by the KR105.
Int	Adjustment of the KR105's tempo and starting and stopping of playback and recording is performed by the KR105.

Displayed	Meaning
Ext	The KR105's tempo as well as the starting and stopping of playback and recording is controlled by the MIDI device connected to the pro's MIDI In connector. When there is no MIDI device connected, then tempo changing operation can not be controlled by the pro
Remote	Playback and recording of songs is controlled by the connected MIDI device.

* Unless the above is set to either "Int" or "Auto," the KR105's buttons cannot be used to adjust the KR105's tempo. Ordinarily, you should set this to "Int."

Touch <Exit> to go back to the Function screen.

Performing in Ensemble with MIDI Instruments (MIDI Ensemble)

You can connect an electronic percussion device or other MIDI instrument to the KR105's MIDI In connector for ensemble playing. Making the MIDI settings for the instrument connected to the MIDI In connector is easy. The sounds from the connected MIDI instrument are played from the KR105's speaker.

1. Press the One Touch Program [Piano] button.
2. Touch <Option>.
3. Use <▲> and <▼> to select the third page:

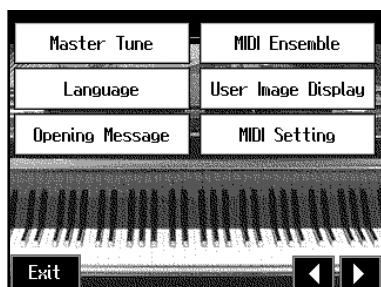

4. Touch <MIDI Ensemble>.

A screen like the following appears.

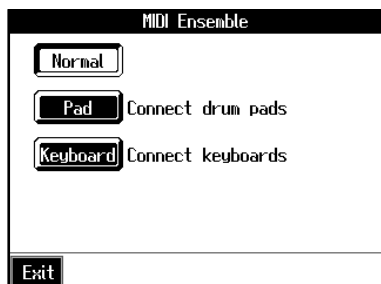

5. Select the method for using the MIDI In connector.

Displayed	Meaning
Normal	Normal setting. Make changes in Tone and other settings from the connected device.
Pad	Select this when you have percussion pads connected to the KR105's MIDI In connector. You do not need to make any MIDI settings on the KR105. Select pad Tones and make other settings from the connected pads (for further details, refer to the Owner's Manual provided with the pads).
Keyboard	Select this when you have a keyboard connected to the KR105's MIDI In connector. You can select tones for the connected keyboard from the KR105. No MIDI settings need be made on the KR105.

6. When "Keyboard" is selected in Step 4 above, use

<▲><▼> to select the Tone.

The connected keyboard plays using the selected Tone.

MIDI Settings

You can make MIDI settings like those described below.

<MIDI Setting>

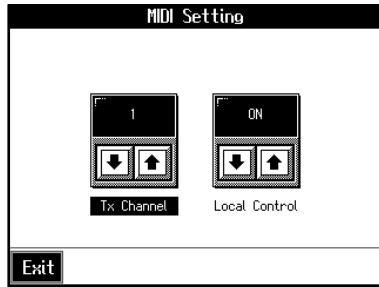

Display	Explanation
Tx Channel	Chooses the MIDI send channel (p. 146).
Local Control	Switches Local Control on or off (p. 146).

<Program Change>

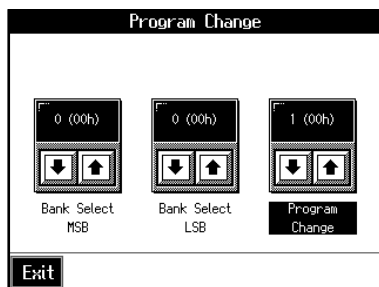

Display	Explanation
Bank Select MSB	Sends Bank Select MSB messages (p. 147).
Bank Select LSB	Sends Bank Select LSB messages (p. 147).
Program Change	Sends Program Change messages (Program Numbers) (p. 147).

○ Making the Settings

1. Press the One Touch Program [Piano] button.
2. Press the [Option] button.
3. Touch <MIDI Setting> or <Program Change>.
4. Touch <▲><▼> to make the setting for each item.

Touch <Exit> to return to the Functions screen.

■ Selecting the Transmit Channel (Tx Channel)

MIDI organizes things into “channels,” which are numbered from 1 through 16. Simply connecting a cable is not enough for communication to take place. The connected devices must be set to use the same MIDI channels. Otherwise, no sound will be produced, and no sounds can be selected.

Select the transmit channel (1–16) of the KR105.

The channel setting is at “1” when the KR105 is powered up. If the keyboard has been split into upper and lower sections, messages from the left-hand section are fixed at “3.”

The KR105 receives messages on all channels from 1 through 16.

■ Disconnecting the Internal Sound Generator and Keyboard (Local Control)

When connecting a MIDI sequencer, set Local Control to “OFF.” The setting is at “Local Control ON” when the KR105 is powered up.

As illustrated, information describing what has been played on the keyboard is passed to the sound module over two different routes, (1) and (2). As a result, you hear overlapping or intermittent sounds. To prevent this from happening, route (1) must be disabled, by setting the unit to what is known as “Local Off.”

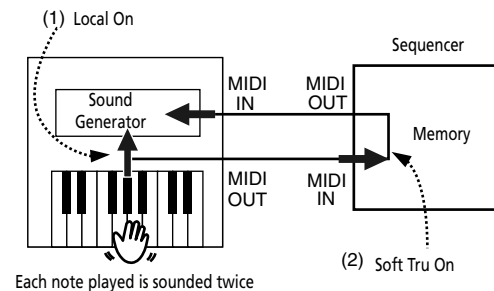

Local On: The keyboard and internal sound generator are connected.

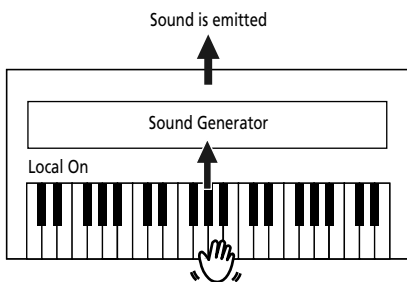

Local Off: The keyboard and internal sound generator are separated. No sound will be produced by the keyboard when it is played.

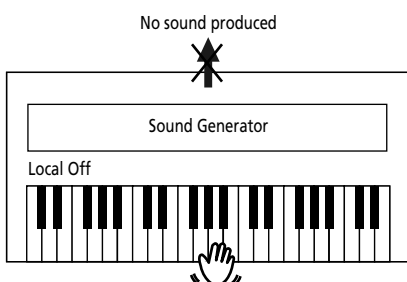

→ When connecting a unit in the Roland MT series, you don't need to switch off Local Control. MT units transmit Local Off messages when their power is switched on. First turn on the power to the KR105, then after a few moments, play a note on the KR105; when you turn on the power to the MT Series device, Local Off is automatically enabled for the KR105.

■ Sending Tone Change Messages (Program Change/Bank Select MSB/Bank Select LSB)

A Program Change is a message that means “change to the Tone of the specified number.” The device that receives this changes to the Tone of the corresponding number.

When you choose a Program Change message (Program Number), the Program Number will be transmitted to the MIDI device connected to the KR105. The MIDI device that receives the Program Number changes the tone to the corresponding Program Number.

Normally, the Tone is selected from the 128 Tones available. Some MIDI devices, however, have more than 128 Tones. With such devices, the Tone is selected through a combination of Program Change messages and Bank Select messages. There are two parts of a Bank Select message: the MSB (Controller 0, with a value of 0–127) and the LSB (Controller 32, with a value of 0–127).

- * Some MIDI instruments can't handle Bank Select messages. Others can handle Bank Selects, but do not recognize the LSB part.

Sending Recorded Performance Data to a MIDI Device (Composer MIDI Out)

When Composer Out is active, you can send performance data recorded with the KR105 to a connected MIDI device or computer.

When you turn on the power, this is set to “OFF” (data is not sent).

1. Press the [Menu] button.
2. Touch <Composer MIDI Out>.

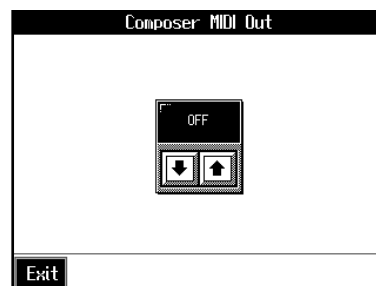

3. Touch <▲><▼> to set ON or OFF.
4. Touch <Exit> to return to the Menu screen.

Connecting to Audio Equipment

When you connect the KR105 to audio equipment, you can play the sounds from the KR105 through the speakers on the audio equipment or record your performances on a tape recorder or other recording device.

When connecting, please use audio cables (sold separately) with standard phone plugs.

Connectors

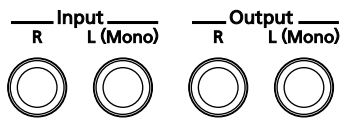

Output Jacks

You can connect audio equipment using audio cables (sold separately) and play the sounds from the KR105 through the speakers on the connected equipment, or record your performances on a tape recorder or other recording device.

If the input of the connected device is monaural, you must use the L (Mono) jack.

Input Jacks

You can connect another sound source, such as audio equipment or an electronic instrument, using audio cables (sold separately). Play the sounds from the connected device through the speakers on the KR105.

If the input of the connected device is monaural, you must use the L (Mono) jack.

* You cannot use the KR105 to adjust the volume of the connected sound generating device.

* When connection cables with resistors are used, the volume level of equipment connected to the inputs jacks may be low. If this happens, use connection cables that do not contain resistors, such as those from the Roland PCS series.

Making the Connections

* To prevent malfunction and/or damage to speakers or other devices, always turn down the volume, and turn off the power on all devices before making any connections.

Playing Sounds from the KR105 Through the Speakers on Audio Equipment or Recording Your Performances on a Recording Device

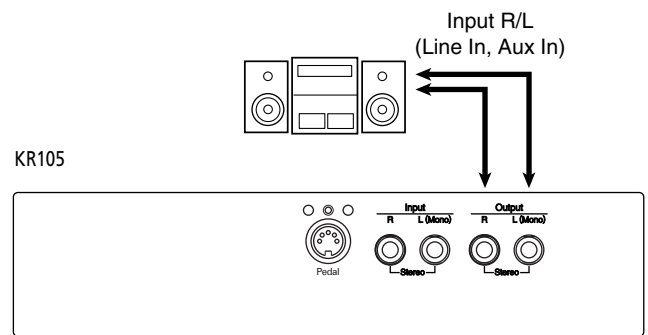

1. Turn the volume all the way down on the KR105 and on the device you're about to connect.
2. Turn off the power to the KR105 and other connected equipment.
3. Use audio cables (sold separately) to make the connection.
4. Switch on the KR105.
5. Switch on the connected device.
6. Adjust the volume level on the KR105 and the connected device.

Recording KR105 Performances on a Recording Device

7. Start recording with the connected device.
8. Play the keyboard.
9. When the performance ends, stop recording on the connected equipment.

Playing Audio Equipment Sounds Through the Speakers on the KR105

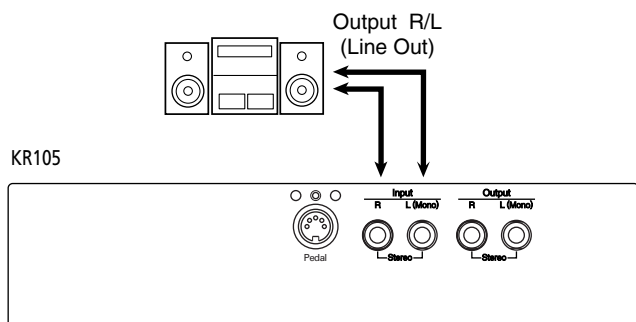

1. Turn the volume all the way down on the KR105 and on the device you're about to connect.
2. Turn off the power to the KR105 and other connected equipment.
3. Use audio cables (sold separately) to make the connection.
4. Turn on the connected equipment.
5. Turn on the KR105.
6. Adjust the volume level on the KR105 and the connected device.

After use, turn off the power using the following procedure.

1. Turn the volume all the way down on the KR105 and on the device you're about to connect.
2. Turn off the KR105.
3. Turn off the connected equipment.

Connecting a Computer

■ Connect to the MIDI Connectors

You can use a USB MIDI interface cable (sold separately) to connect the KR105 to your computer.

If the KR105 is connected to a computer in which sequencer software such as Roland's "Visual MT" is installed, a song you've recorded on the KR105 can be saved on your computer.

Connection Examples

- * To prevent malfunction and/or damage to speakers or other devices, always turn down the volume, and turn off the power on all devices before making any connections.
- * In order to make connections to your computer, you must install "MIDI driver" software on your computer. For details, refer to the owner's manual for your MIDI interface.

Use a USB MIDI interface cable to connect the USB connector of your computer to the MIDI connectors of the KR105.

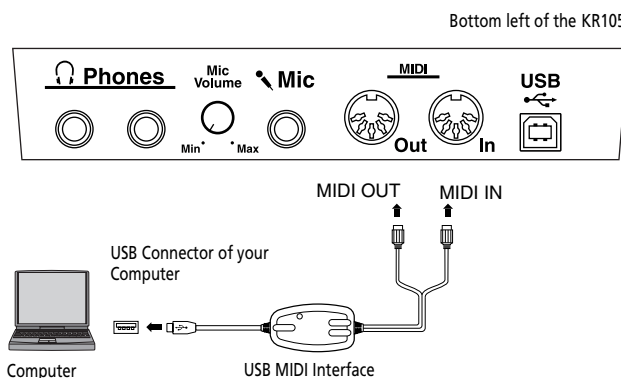

■ Connect to the USB Connector

You can connect your computer with a USB cable to the USB connector, located on the left underside of the KR105, and exchange MIDI data between the instrument and the computer. You can use the KR105 to play SMF data created with the computer and exchange performance data in the same manner as with MIDI devices connected to the MIDI connectors.

Connecting your computer to the KR105 for the first time requires installation of the "USB Driver" (on the included CD-ROM) to the computer.

The correct driver and the installation procedure will depend on your system and on the other programs you are using. Be sure to read the Readme file on the CD-ROM before installation.

Windows XP/2000

→ \W2kXP\Readme_E.htm

Windows Me/98/98SE

→ \W98Me\Readme_E.htm

Mac OS X

→ \Driver (Mac OS X)\Readme_e.htm

- * Only MIDI data can be transmitted using USB.
- * To prevent malfunction and/or damage to speakers or other devices, always turn down the volume, and turn off the power on all devices before making any connections.
- * USB cables are not included. Consult your Roland dealer if you need to purchase.
- * Turn on the power to the KR105 before starting up MIDI applications on the computer. Do not turn the KR105 on or off while any MIDI application is running.
- * If not using USB, disconnect the USB cable from the KR105.
- * If during the transmission/reception of data, the computer switches to energy-saving mode or suspended mode, or if the KR105's power is switched on or off, the computer may freeze, or the KR105's operation may become unstable.
- * Do not connect or disconnect the USB cable or turn off the power during the transmission/reception of data.

For more on system requirements, refer to the "USB Installation Guide."

Connection examples

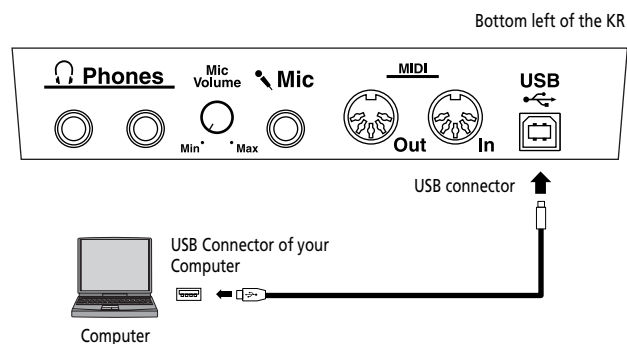

1. Turn off the power to the KR105 and the computer.
2. Start up the computer.
3. Connect the KR105 and the computer with a USB cable.
4. Turn on the power to the KR105.

→ Refer to the owner's manual that came with your computer

Troubleshooting

If you think there's a problem, read this first.

Case	Cause/Remedy
The power doesn't come on	Is the power cord connected and plugged in correctly? (p. 15)
The button doesn't work	Is the panel locked? (p. 140) Turn the power off, then back on.
Nothing appears on screen	The KR105 uses a liquid-crystal screen, so text may not be displayed when the ambient temperature is below freezing.
Vertical lines appear in the screen	These occur due to the nature of a liquid crystal display, and do not indicate a malfunction. They can be minimized by adjusting the brightness of the screen (p. 18).
The touch screen doesn't respond correctly	The positioning of the touch screen may become displaced if some time has passed since it was last used. Take a look at "Calibrating the Touch Screen (Touch Screen)" (p. 139) to correct the positioning.
Depressing a pedal has no effect, or the pedal effect doesn't stop	Is the pedal connected correctly? Make sure the pedal cord extending from the stand is securely connected to the pedal connector on the rear of the unit (p. 15).
	Has a different function been assigned to the pedal? See "Assigning Functions to Pedals and Performance Pads (Pedal Setting/User Functions)" (p. 126).
	Normal pedal operation is automatically enabled when the One Touch Program [Piano] button is pressed (p. 16).
The volume level of the instrument connected to Input jacks is too low	Could you be using a connection cable that contains a resistor? Use a connection cable that does not contain a resistor.
Low hum coming from external device	Do you have different external devices plugged into different power outlets? When connecting external devices, always draw power from the same outlet.
Mic volume changes	Adjusting the panel's [Volume] knob may cause the mic volume to change.

Case	Cause/Remedy
No sound is heard	
No sound is heard	Is the volume level of the KR105 (p. 17) or connected device turned all the way down?
	Are headphones plugged in? (p. 17) Has a plug remained connected to the Phones jack? When headphones or plugs are connected, the keyboard's speaker stops playing.
	Has the Balance knob been moved all the way to the right or left? Has the volume been set to "0" using the Part Balance? (p. 52)
	Has the footage been adjusted so that all frequency components aren't sounded? (p. 15 in the Quick Start)
No sound is heard	Is the speaker cable connected and plugged in correctly?
	No sound from the left side is V-LINK switched on? (p. 143) When V-LINK is switched on, the twelve keys at the left end of the keyboard are used to control images, and no sounds are played with these keys.
No sound is heard (when a MIDI instrument is connected)	Have all devices been switched on?
	Are the MIDI cables connected correctly? (p. 144)
	Does the MIDI channel match the connected instrument? (p. 146)
No sound is heard when the keyboard is played	Has Local Control been set to "Off"? When Local Control is set to Off, no sound is produced by playing the keyboard. Set Local Control to On (p. 146).
Not all played notes are sounded	The maximum number of notes can play simultaneously is 64. Frequent use of the damper pedal during automatic accompaniment or when playing along with a song may result in performance data with too many notes, causing some notes to drop out.

The sound is strange

Sounds are heard twice (doubled) when the keyboard is played	Is the KR105 in Layer play? (p. 25)
	When the KR105 is connected to an external sequencer, set it to the Local OFF mode (p. 146). Alternatively, the sequencer could be set so its Soft Thru feature is OFF.

Appendices

Case	Cause/Remedy
The tuning or pitch of the keyboard or song is off	Have you set transpose? (p. 73)
	Are the settings for the “Temperament” and “Stretch Tuning” correct? (p. 133)
	Is the setting for the “Master Tune” correct? (p. 136)
Effects cannot be applied to Tones	It’s not possible to apply more than one effect at the same time, so when a performance has been recorded on multiple tracks or when playing along with a song as it’s played back, the desired effect may not be applied.
A note doesn’t stop playing	Have the Chord Tone and Bass Tone been changed? (p. 128) Some Chord Tone and Bass Tone notes may be sounded continuously.
The Tone has changed	During automatic accompaniment, changing the Music Style automatically changes the Tones and tempo of the upper part of the keyboard to match the new Music Style. If you want to change only the Music Style without also altering the tempo and Tone, check out “Changing Music Styles Without Changing the Tone or Tempo (One Touch Setting)” (p. 125).
	When a performance made along with a Music Files tune has been recorded, recording the performance to button [1/Whole] may make the Tones for buttons [3/Lower] and [4/Upper] change as well.
Reverberation still audible even with Reverb turned off	Since the KR105’s piano sounds faithfully reproduce the sense of spaciousness and reverberation of an actual acoustic piano’s sound, a certain amount of reverberation is still perceptible, even with the reverb effect deactivated.
In the upper range, the sound changes abruptly beyond a certain key	On an acoustic piano, notes in the upper one and a half octaves of the keyboard continue to sound until they decay naturally, regardless of the damper pedal. There is a difference in the timbre as well. Roland pianos faithfully simulate such characteristics of the acoustic piano. The range that is unaffected by the damper pedal will change depending on the Key Transpose setting.

Case	Cause/Remedy
A High-pitched whine is produced	<p>When listening through headphones: Some of the more flamboyant and effervescent piano tones feature an ample high-end component, which may make the sound appear to have metallic reverberation added. Since this reverberation becomes particularly audible when supplemented by heavy reverb, you may be able to diminish the problem by reducing the amount of reverb applied to the sound.</p> <p>When listening through speakers: Here, a different cause (such as resonance produced by the KR105) would be suspect. Consult your Roland dealer or nearest Roland Service Center.</p>
	<p>When listening through speakers: Playing at loud volumes may cause instruments near the KR105 to resonate. Resonation can also occur with fluorescent light tubes, glass doors, and other objects. In particular, this problem occurs more easily when the bass component is increased, and when the sound is played at higher volumes. Use the following measures to suppress such resonance.</p> <ul style="list-style-type: none"> • Place speakers so they are 10–15 cm from walls and other surfaces. • Reduce the volume. • Move the speakers away from any resonating objects. <p>When listening through headphones: Here, a different cause (such as resonance produced by the KR105) would be suspect. Consult your Roland dealer or nearest Roland Service Center.</p>
The automatic accompaniment doesn’t play correctly	
Can’t select a tone or Music Style	Touch <Exit> several times to return to the Basic screen (p. 19), and then select a tone or Music Style.
Automatic accompaniment is not heard	Has the Balance knob been moved all the way to the right? (p. 52)
	<p>Have you pressed the One Touch Program [Arranger] button? If the One Touch Program [Arranger] button has not been pressed, only the rhythm pattern is played (p. 42).</p> <p>Is the 16-track Sequencer screen displayed? (p. 99)</p>
Chord Intelligence can’t be used	Has Chord Intelligence been set to manual? (p. 128)
	Is the setting for “Piano Style Arranger” active? (p. 51)

Case	Cause/Remedy
Accompaniment tempo becomes unstable	In certain cases, such as when playing Music Styles on floppy disks, the accompaniment may lag when excessive amounts of performance data are used.

Song doesn't play back correctly

Song doesn't play back	Does the screen indicate message, like "OK to delete song?" (p. 75) The internal songs cannot be played back while recorded performance data remains in the KR105's memory. Try playing back the song after deleting the performance data.
Only the sound of a particular instrument in a song does not play	Is the light for the Track button extinguished? (p. 69) If the button light is out, the music on that track is not heard. Press the track button so the light is illuminated.
	Have song settings been changed for each Part on the 16-Track sequencer screen (p. 100)?
Pressing the [⏮ (Reset)] button doesn't return to the beginning of the song	Some music files may contain settings that stop play at a point partway through the song. Press the [⏮ (Reset)] button several times more to return to the beginning of the tune.
	Has a Marker placed in the song? (p. 70)
The [▶▶ (Fwd)] and [◀◀ (Bwd)] buttons don't work	The fast-forward and reverse buttons are ignored while music files is being read in. Wait until processing finishes.
	If you attempt to play back performance data that contains more data than the entire capacity of the KR105's memory, you may find that operations other than playback (such as rewind or fast forward) become unavailable.
There is a slight delay before playback of a song starts	There are two types of SMF music files: format 0 and format 1. If the song uses SMF format 1 data, there will be a slight delay until playback starts. Refer to the booklet that came with the music files you're using to determine the format type.

Case	Cause/Remedy
Lyrics are not indicated properly in the display	With some music files, the lyrics cannot be displayed correctly.
	If you press a button while the lyrics are being shown in the display, the lyrics will disappear. To recall them, touch <lyrics> in the Piano or Basic screen, or press the [▶/■ (Play/Stop)] button.
	In the notation screen, some lyrics or notes could extend beyond the edges of the screen, and not be displayed.
Notation is not indicated properly in the display	If you select a part that does not contain performance data, notes will not be displayed in the notation. Change the part that is displayed (p. 64).
	The notation screen feature is particularly unsuitable for the display of difficult, complex musical works that demand accurate notation. Refer to "Notes Regarding the Score Display" (p. 62).
	In the notation screen, some lyrics or notes could extend beyond the edges of the screen, and not be displayed.
Song becomes unstable	In certain cases, such as when playing songs on floppy disk, the song may lag when excessive amounts of performance data are used.
Unable to play back internal songs	Have you pressed the remote control's [MUTE] button, muting the sound?

Can't record

Can't record	Has one of the track buttons for recording been selected? (p. 81)
	Has the setting for "Punch-in Recording" (p. 105) or "Tempo Recording" (p. 114) been made? Select the replace recording method (p. 103).
	It is not possible to record while the notation is being generated. Once the unit has finished generating the notation (i.e., when the measure number in the screen is no longer highlighted), try the operation once again.

Appendices

Case	Cause/Remedy
Tempo of recorded song or metronome is off	If you select an internal song in which the tempo changes during the song, and then record, the tempo will change in the same way for the performances that are recorded on the other tracks. The tempo of the metronome will also change in the same way.
	If you record additional material without erasing the previously recorded song, the song will be recorded at the first-recorded tempo. Please erase the previously recorded song before you re-record (p. 82).
The recorded performance has disappeared	Any performance that has been recorded is deleted when the power to the KR105 is turned off or a song is selected. A performance cannot be restored once it's been deleted.

Error Messages

Indication	Meaning
<p>Error 00: Due to copyright protection, the file cannot be saved as an SMF. Also, the file cannot be saved on another disk.</p>	<p>To protect the copyright, this music file cannot be saved as an SMF. Also, the music file cannot be saved. If you want to save it, please save on the same floppy disk.</p>
<p>Error 01: This file cannot be saved. The file is read-only.</p>	<p>You can only read the music file. It can not be saved on a floppy disk or in a user memory.</p>
<p>Error 02: The protect tab on the floppy disk is set to the Protect position.</p>	<p>The protect tab on the floppy disk is set to the Protect position (p. 6). Change it to the Write position. Repeat the procedure.</p>
<p>Error 03: This is a master disk. It cannot be formatted, nor can data be stored on it.</p>	<p>This floppy disk cannot store the format or save any data. Insert a different disk and repeat the procedure.</p>
<p>Error 04: File cannot be saved on this disk. SMFs and i-format files cannot both be stored on the same disk.</p>	<p>The data cannot be saved onto this floppy disk because the format is different. Use the floppy disk in the same format.</p>
<p>Error 05: Cannot overwrite destination. Select different destination, or save on another floppy disk.</p>	<p>A new song cannot be written on this song. Select a different song number or use a different floppy disk, and repeat the procedure.</p>
<p>Error 10: No floppy disk. Insert the disk correctly.</p>	<p>No floppy disk is connected to the disk drive. Insert the disk correctly, and repeat the procedure.</p>
<p>Error 11: There is insufficient space available on the disk, or in user memory.</p>	<p>There is not sufficient space left on the floppy disk or User memory for the data to be saved. Insert a different floppy disk or delete files on user memory, and repeat the procedure.</p>
<p>Error 12: This disk cannot be recognized. Disk has not been formatted, or is of an incompatible format.</p>	<p>The floppy disk inserted into the disk drive can't be read. Be sure you're using Roland SMF Music Files or other music files compatible with Roland digital pianos. Also, if you want to save your work on floppy disk, you need to format the floppy disk first (p. 85).</p>
<p>Error 13: Disk removed from drive while being accessed. Never eject a disk while reading/writing is in progress.</p>	<p>The floppy disk was removed from the disk drive while reading or writing was in progress. Insert the floppy disk and repeat the procedure.</p>
<p>Error 14: Part of the data on the disk or in the user memory was found to be corrupted. Insert different disk, or format user memory.</p>	<p>This floppy disk or user memory is damaged and cannot be used. Insert a different disk and repeat the procedure or format the user memory (p. 139).</p>
<p>Error 15: This file cannot be read. The file uses an incompatible file format.</p>	<p>This song or music style cannot be read. Please use a Roland SMF Music Files or Roland Digital Piano compatible music files (p. 168). Also, you can only use User Programs that have been saved with the KR105 (p. 94).</p>
<p>Error 16: The performance is canceled. First, stop playback. Then start it again from the beginning.</p>	<p>The KR105 cannot read the floppy disk or user memory quickly enough. Press the [▶/■ (Play/Stop)] button, then press the [◀ (Reset)] button and [▶/■ (Play/Stop)] button to play the song.</p>
<p>Error 17: This file cannot be displayed on the selected display screen.</p>	<p>The selected image data cannot be displayed. If it cannot be made to appear either on the KR105's display or the external display, you will need to prepare image data that can be used with the KR105 (p. 137).</p>
<p>Error 30: The instrument's internal memory is full.</p>	<p>The internal memory capacity of the KR105 is full. Save the song data on a floppy disk (p. 87) and delete the song or the User style data stored on the KR105 memory.</p>
<p>Error 40: Processing of the MIDI data was not performed in time.</p>	<p>The KR105 cannot deal with the excessive MIDI data sent from the external MIDI device. Reduce the amount of MIDI data sent to the KR105.</p>
<p>Error 41: A MIDI cable or computer cable has been disconnected. Connect it properly.</p>	<p>A MIDI cable or computer cable has been disconnected. Connect it properly and securely.</p>
<p>Error 42: The data could not be processed quickly enough. Try recording at a slower tempo.</p>	<p>An excessive amount of performance data has been sent to KR105 in one time and therefore could not be recorded. Change the tempo more slowly to record the performance again.</p>
<p>Error 43: Either this instrument's Computer Switch is set inappropriately, or your computer is not set properly. Set them correctly, then switch the instrument on again.</p>	<p>The Computer switch is set to a wrong position or the computer is set wrongly. Switch off the KR105 then set the Computer switch to the correct position and set the computer correctly. After that, switch on the KR105 again.</p>
<p>Error 51: There is something wrong with the system. Contact a Roland Service Center.</p>	<p>There may be a problem with the system. Repeat the procedure from the beginning. If it is not solved after you have tried several times, contact the Roland service center.</p>

Tone List

[Piano]

Grand Piano1
PianoStrings
Piano Choir
Pro Stage
Harpsichord
Vintage EP
Vibraphone
Harpsi.Doubl
Marimba
Steel Drums
Honky-tonk 2
Stage E.Piano
Ballad Piano
Tremolo EP
Jazzy Vib+Gt
Wurly
Rock Piano
Clav.
Honky-Tonk
Bright Piano
Harpsi.Singl
UprightPiano
Grand Piano2
Bell Piano
Piano Oohs
E. Grand
MIDI Piano1
E.Piano 1
FM+SA EP
St.FM EP
Hard FM EP
Soft Marimba
MIDI EP1
MIDI EP 2
Hard EP
Harpsi.o
Coupled Hps.
Vibra Bells
Celesta
Glockenspiel
Soft E.Piano
60's E.Piano
E.Piano 2
E.Piano 3
Xylophone
Music Box
Balafon
Detuned EP 1
Detuned EP 2
Hard E.Piano
Hard Clav.
Soft Clav.
Reso Clav.
Phase Clav.
Pop Vibe.
Pop Celesta
Tubular-bell
Santur
Kalimba
Air Grand
Piano 1
Piano 2
Piano 3

[Organ]

Jazz Organ
Full Organ 1
Lower Organ
Theater Org.
Nason flt 8'
Bandneon
Organ Flute
Jazz Organ2
Full Organ 2
Full Organ 3
Lower Organ2
Church Organ
Rock Organ1
Harmonica
Pop Organ
Accordion
Trem.Flute
Jazz Organ3
Jazz Organ4
Full Organ 4
Rotary Org.S
Rotary Org.F
Rock Organ2
Pipe Org. Bs
Organ Bass
Metalic Org.
VS Organ
Organ 1
Organ 2
Digi Church

[Guitar / Bass]

Steel Guitar
Nylon Guitar
Jazz Guitar
Nylon+Steel
12str Guitar
Nylon Gt.o
Hawaiian Gt.
Banjo
JC E.Guitar
Muted Gt.
Acoustic Bs.
A.Bass+Cymb
DistortionGt
Steel Vox
Rock Rhythm
Rock Rhythm2
Overdrive Gt
Power Guitar
Power Gt.2
Muted Dis.Gt
Fingered Bs.
Picked Bs.
Fretless Bs.
Slap Bass
Muted Gt.2
Mellow Gt.
5th Dist.
Feedback Gt2
Synth Bass 1
Synth Bass 2
SynthBass101
Jungle Bass
Modular Bass
WireStr Bass
ResoSH Bass
SH101 Bass

Mute PickBs.
Mr.Smooth
Open Hard
Dazed Guitar
Acid Guitar
Ukulele
Koto
Shamisen

[Strings]

Strings
Slow Strings
Choir Str
Harp Strings
Trem. Str
Violin
Cello
Warm Strings
DecayStrings
Orchestra
Oct Strings
St. Harp
Velo Strings
Legato Str
PizzicatoStr
SlowStrings2
Bell Strings
OrchestraHit
Warm JP Str
Slow Violin
Contrabass
Timpani
Syn.Strings1
Syn.Strings2
Strings 2
OB Strings
Euro Hit
6th Hit
Bass Hit

[Sax / Brass]

EX Tenor Sax
Soprano Sax
Flute
Trumpet
MutedTrumpet
AltoSax + Tp
Oboe
Clarinet
TromboneSoft
Soft Brass
Baritone Sax
Tuba
Romantic Tp
Power Brass
St. Brass ff
English Horn
BrassSection
Blow Sax
Brite Brass
Brass ff
EX Trumpet
Grow Sax
Alto Sax
Tenor Sax
GS Bari Sax
Flugel Horn
Fr.Horn Solo

Synth Brass3
Trombone2
Piccolo
Pan Flute
GS Pan Flute
Blow Pipe
Bottle Blow
Bassoon
Recorder
French Horn
Synth Brass1
Synth Brass2
Oct SynBrass
Shakuhachi
Brass 1
Brass 2
Ocarina

[Voice]

Jazz Scat
Dreamy Choir
Boys Choir
Holy Voices
HollowReleas
Rich Choir
Dat Accent
Bop Accent
Thum Voice
Pop Voice
Org Bells
Humming
Doos Voice
Choir Oohs
Choir Aahs
Warm SqrPad
New Age Pad
LM PureLead
LM Square
Natural Lead
2600 SubOsc
SquareWave2
Fantasia
Crystal
Harpvox
CC Solo
Brightness
Syn.Square
JP8 Square
FM Lead
FM Lead 2
Mg Lead
Dual Sqr&Saw
P5 Saw Lead
Rhythmic Saw
Waspy Synth
JP8 Pulse
Cheese Saw
SynVox
Clear Bells
Soft Crystal
Digi Bells
Nylon Harp
Nylon+EP
Fantasia 2
Soft Pad
P5 Poly
Reso Saw
RAVE Vox
Fat & Perky

Heaven II
JP8 Sqr Pad
Sweep Pad 2
Big Panner
Ai-yai-a
Echo Pan 2
Falling Down
Poly King
Warm Pad
RandomEnding
Piano 1
Piano 1w
Piano 1d
Piano 2
Piano 2w
Piano 3
Piano 3w
GS Honkytonk
Honky-tonk 2
GS E.Piano1
GS E.Piano2
60's E.Piano
E.Piano 1v
E.Piano 2v
Detuned EP 1
Detuned EP 2
GS Harpsi
Coupled Hps.
Harpsi.w
Harpsi.o
Soft Clav.
Celesta
Glockenspiel
Music Box
Vibraphone
Vibe.w
GS Marimba
Marimba
Xylophone
Tubular-bell
Church Bell
Carillon
Santur
Organ 1
Organ 2
Pop Organ
Detuned Or.1
Detuned Or.2
Church Org.1
Church Org.2
Church Org.3
Full Organ 4
Jazz Organ
Rock Organ 2
Reed Organ
Accordion Fr
Accordion It
GS Harmonica
Bandoneon
GS Nylon Gt.
Nylon Guitar
Nylon Gt.o
Ukulele
Steel-str.Gt
12-str.Gt
Mandolin
Jazz Guitar
Hawaiian
Clean Gt.
Chorus Gt.
Muted Gt.

Funk Gt.	Square	Door	Pizzicato*	Agogo*
Funk Gt.2	Sine Wave	Scratch	Harp*	Steel Drums*
Overdrive Gt	Saw Wave	Windchime	Timpani*	Woodblock*
DistortionGt	Saw	Helicopter	Strings*	Taiko*
Feedback Gt.	Doctor Solo	Car-Engine	SlowStrings*	Melo.Tom 1*
Gt.Harmonics	Syn.Calliope	Car-Stop	Syn.Str 1*	Synth Drum*
Gt.Feedback	Chiffer Lead	Car-Pass	Syn.Str 2*	ReverseCym.*
GS Ac.Bass	Charang	Car-Crash	Choir Aahs*	Fret Noise*
GS Fing.Bass	Solo Vox	Siren	Pop Voice*	BreathNoise*
Picked Bs	5th Saw Wave	Train	SynVox*	Seashore*
Fretless Bs.	Bass & Lead	Jetplane	Orche.Hit*	Bird*
Slap Bass	Fantasia	Starship	Trumpet*	Telephone 1*
Slap Bass 2	Warm Pad	Burst Noise	Trombone*	Helicopter*
SynthBass101	Polysynth	Applause	Tuba*	Applause*
Synth Bass 1	Space Voice	Laughing	M.Trumpet*	Gun Shot*
Synth Bass 2	Bowed Glass	Screaming	FrenchHorns*	
Synth Bass 3	Metal Pad	Punch	Brass 1*	
Synth Bass 4	Halo Pad	Heart Beat	SynthBrass1*	
Rubber Bass	Sweep Pad	Footsteps	SynthBrass2*	
Violin	Ice Rain	Gun Shot	A.Brass 1*	
Slow Violin	Soundtrack	Machine Gun	Soprano Sax*	
Viola	Crystal	Lasergun	Alto Sax*	
Cello	Syn Mallet	Explosion	Tenor Sax*	
Contrabass	Atmosphere	Piano 1*	BaritoneSax*	
Trem. Str	Brightness	Piano 2*	Oboe*	
PizzicatoStr	Goblin	Piano 3*	EnglishHorn*	
GS Harp	Echo Drops	Honky-tonk*	Bassoon*	
Timpani	Echo Bell	E.Piano 1*	Clarinet*	
GS Strings	Echo Pan	E.Piano 2*	Piccolo*	
Orchestra	Star Theme	Harpichord*	Flute*	
GS Sl.Str	Sitar	Clav.*	Recorder*	
Syn.Strings1	Sitar 2	Celesta*	Pan Flute*	
Syn.Strings2	Banjo	Glocken*	Bottle Blow*	
Syn.Strings3	Shamisen	Music Box*	Shakuhachi*	
Choir Aahs	Koto	Vibraphone	Whistle*	
Choir	Taisho Koto	Marimba*	Ocarina*	
Pop Voice	Kalimba	Xylophone*	Square Wave*	
SynVox	Bagpipe	Tubularbell*	Saw Wave*	
OrchestraHit	Fiddle	Santur*	Doctor Solo*	
GS Trumpet	Shanai	Organ 1*	SynCalliope*	
Trombone	Tinkle Bell	Organ 2*	ChifferLead*	
Trombone 2	Agogo	Pop Organ 1*	Charang*	
Tuba	Steel Drums	Rock Organ2*	Solo Vox*	
MutedTrumpet	Woodblock	ChurchOrg.1*	5th SawWave*	
French Horn	Castanets	Reed Organ*	Bass & Lead*	
Fr.Horn 2	Taiko	AccordionFr*	Fantasia*	
Brass 1	Concert BD	Harmonica*	Warm Pad*	
Brass 2	Melo. Tom 1	Bandoneon*	Polysynth*	
Synth Brass1	Melo. Tom 2	Nylon-strGt*	Space Voice*	
Synth Brass2	Synth Drum	Steel-strGt*	Bowed Glass*	
Synth Brass3	808 Tom	Jazz Guitar*	Metal Pad*	
Synth Brass4	Elec Perc.	Clean Gt.*	Halo Pad*	
AnalogBrass1	Reverse Cym.	Muted Gt.*	Sweep Pad*	
AnalogBrass2	Gt.FretNoise	Funk Gt.*	Ice Rain*	
GS Sop.Sax	Gt.Cut Noise	OverdriveGt*	Soundtrack*	
Alto Sax	String Slap	Dist.Guitar*	Crystal*	
Tenor Sax	Breath Noise	Gt.Harmo*	Syn Mallet*	
GS Bari Sax	Fl.Key Click	Acoustic Bs*	Atmosphere*	
GS Oboe	Seashore	Fingered Bs*	Brightness*	
English Horn	Rain	Picked Bs.*	Goblin*	
Bassoon	Thunder	Fretless Bs*	Echo Drops*	
Clarinet	Wind	Slap Bass 1*	Star Theme*	
Piccolo	Stream	Slap Bass 2*	Sitar*	
GS Flute	Bubble	SynthBass 1*	Banjo*	
Recorder	Bird	SynthBass 2*	Shamisen*	
GS Pan Flute	Dog	Rubber Bass*	Koto*	
Bottle Blow	Horse-Gallop	Violin*	Kalimba*	
Shakuhachi	Bird 2	Viola*	Bagpipe*	
Whistle	Telephone 1	Cello*	Fiddle*	
Ocarina	Telephone 2	Contrabass*	Shanai*	
Square Wave	DoorCreaking	Tremolo Str*	Tinkle Bell*	

* Tone with a “*” symbol appended to their name may not play back satisfactorily on other GS sound generating devices.

Drum Set List

* -----: No sound.

* [EXC]: will not sound simultaneously with other percussion instruments of the same number.

	POP Set	ROCK Set	JAZZ BRUSH Set
21	R&B Snare	R&B Snare	R&B Snare
22	Rock Snare	Pop Snare m	Pop Snare m
23	Rock Snare	Pop Snare m	Pop Snare m
24	Pop Snare m	Pop Snare m	Pop Snare m
25	Pop Snare Ghost	Pop Snare Ghost	Pop Snare Ghost
26	Pop Snare m	Pop Snare m	Pop Snare m
27	Finger Snap	Finger Snap	Finger Snap
28	707 Claps	707 Claps	707 Claps
29	Hand Clap [EXC7]	Hand Clap [EXC7]	Hand Clap [EXC7]
30	Hand Clap2 [EXC7]	Hand Clap2 [EXC7]	Hand Clap2 [EXC7]
31	Hand Clap	Hand Clap	Hand Clap
32	Pop Pedal HH [EXC1]	Pop Pedal HH [EXC1]	Pop Pedal HH [EXC1]
33	Gospel Hand Clap	Gospel Hand Clap	Gospel Hand Clap
34	Snare Roll	Snare Roll	Snare Roll
35	Pop Kick	Rock Kick	Pop Kick
C2 36	Pop Kick	Rock Kick	Pop Kick
37	Pop Side Stick	Rock Side Stick	Jazz Snare Swing
38	Pop Sanre s	Rock Sanre s	Jazz Sanre
39	Pop Snare Ghost	Rock Snare Ghost	Pop Snare Swing
40	Pop Snare s	Rock Snare s	Jazz Sanre
41	Pop Low Tom f	Rock Low Tom f	Jazz Low Tom f
42	Pop CHH 1 [EXC1]	Rock CHH 1 [EXC1]	Pop CHH 1 [EXC1]
43	Pop Low Tom	Rock Low Tom	Jazz Low Tom
44	Pop CHH 2 [EXC1]	Rock CHH 2 [EXC1]	Pop CHH 2 [EXC1]
45	Pop Mid Tom f	Rock Mid Tom f	Jazz Mid Tom f
46	Pop OHH [EXC1]	Rock OHH [EXC1]	Pop OHH [EXC1]
47	Pop Mid Tom	Rock Mid Tom	Jazz Mid Tom
C3 48	Pop High Tom f	Rock High Tom f	Jazz High Tom f
49	Pop Crash Cymbal 1	Rock Crash Cymbal	Jazz Crash Cymbal 1
50	Pop High Tom	Rock High Tom	Jazz High Tom
51	Pop Ride Cymbal 1	Rock Ride Cymbal 1	Jazz Ride Cymbal 1
52	Pop Chinees Cymbal	Pop Chinees Cymbal	Jazz Chinees Cymbal
53	Pop Ride Bell	Pop Ride Bell	Jazz Ride Cymbal 2
54	Tambourine 2	Tambourine 2	Tambourine 2
55	Splash Cymbal	Splash Cymbal	Splash Cymbal
56	Cha Cha Cowbell	Cha Cha Cowbell	Cha Cha Cowbell
57	Pop Crash Cymbal 2	Chinees Cymbal	Jazz Crash Cymbal 2
58	Vibra-slap 2	Vibra-slap 2	Vibra-slap 2
59	Pop Ride Cymbal 2	Pop Ride Cymbal 3	Pop Ride Cymbal 2
C4 60	High Bongo 2	High Bongo 2	High Bongo 2
61	Low Bongo 2	Low Bongo 2	Low Bongo 2
62	Mute Conga	Mute Conga	Mute Conga
63	High Conga 2	High Conga 2	High Conga 2
64	Low Conga 2	Low Conga 2	Low Conga 2
65	High Timbale 2	High Timbale 2	High Timbale 2
66	Low Timbale 2	Low Timbale 2	Low Timbale 2
67	High Agogo	High Agogo	High Agogo
68	Low Agogo	Low Agogo	Low Agogo
69	Shaker 3	Shaker 3	Shaker 3
70	Shaker 4	Shaker 4	Shaker 4
71	Short Hi Whistle [EXC2]	Short Hi Whistle [EXC2]	Short Hi Whistle [EXC2]
C5 72	Long Low Whistle [EXC2]	Long Low Whistle [EXC2]	Long Low Whistle [EXC2]
73	Short Guiro [EXC3]	Short Guiro [EXC3]	Short Guiro [EXC3]
74	Long Guiro [EXC3]	Long Guiro [EXC3]	Long Guiro [EXC3]
75	Claves	Claves	Claves
76	High Wood Block	High Wood Block	High Wood Block
77	Low Wood Block	Low Wood Block	Low Wood Block
78	Mute Cuica [EXC4]	Mute Cuica [EXC4]	Mute Cuica [EXC4]
79	Open Cuica [EXC4]	Open Cuica [EXC4]	Open Cuica [EXC4]
80	Mute Triangle [EXC5]	Mute Triangle [EXC5]	Mute Triangle [EXC5]
81	Open Triangle [EXC5]	Open Triangle [EXC5]	Open Triangle [EXC5]
82	Shaker	Shaker	Shaker
83	Jingle Bell	Jingle Bell	Jingle Bell
C6 84	Bell Tree	Bell Tree	Bell Tree
85	Castanets	Castanets	Castanets
86	Mute Surdo [EXC6]	Mute Surdo [EXC6]	Mute Surdo [EXC6]
87	Open Surdo [EXC6]	Open Surdo [EXC6]	Open Surdo [EXC6]
88	Cana	Cana	Cana
89	Falamento Hi-Timbale	Falamento Hi-Timbale	Falamento Hi-Timbale
90	Falamento Lo-Timbale	Falamento Lo-Timbale	Falamento Lo-Timbale
91	Falamento Tmbl Flam	Falamento Tmbl Flam	Falamento Tmbl Flam
92	Shekere 1	Shekere 1	Shekere 1
93	Shekere 2	Shekere 2	Shekere 2
94	Low Bongo Mute	Low Bongo Mute	Low Bongo Mute
95	High Bongo Mute	High Bongo Mute	High Bongo Mute
C7 96	-----	-----	-----
97	-----	-----	-----
98	-----	-----	-----
99	-----	-----	-----
100	Falamento HC	Falamento HC	Falamento HC
101	Falamento HC	Falamento HC	Falamento HC
102	Bongo Cowbell	Bongo Cowbell	Bongo Cowbell
103	-----	-----	-----
104	Bongo Cowbell	Bongo Cowbell	Bongo Cowbell
105	-----	-----	-----

* -----: No sound.

* [EXC]: will not sound simultaneously with other percussion instruments of the same number.

	STANDARD Set	ROOM Set	POWER Set	ELECTORONIC Set
21	-----	-----	-----	-----
22	-----	-----	-----	-----
23	-----	-----	-----	-----
24	Bar Chime	Bar Chime	Bar Chime	Bar Chime
25	Snare Roll	Snare Roll	Snare Roll	Snare Roll
26	Finger Snap	Finger Snap	Finger Snap	Finger Snap
27	High Q	High Q	High Q	High Q
28	Slap	Slap	Slap	Slap
29	Scratch Push [EXC7]	Scratch Push [EXC7]	Scratch Push [EXC7]	Scratch Push [EXC7]
30	Scratch Pull [EXC7]	Scratch Pull [EXC7]	Scratch Pull [EXC7]	Scratch Pull [EXC7]
31	Sticks	Sticks	Sticks	Sticks
32	Square Click	Square Click	Square Click	Square Click
33	Metronome Click	Metronome Click	Metronome Click	Metronome Click
34	Metronome Bell	Metronome Bell	Metronome Bell	Metronome Bell
35	Std Kick 2'	Kick1	Std Kick 2	Std Kick 2
C2 36	Kick 1	Room Kick	MONDO Kick	Elec BD
37	Side Stick	Side Stick	Side Stick	Side Stick
38	Std Snr 1	Room Snr 1	Gated SD	Elec SD
39	Hand Clap	Hand Clap	Hand Clap	Hand Clap
40	Std Snr 2	Std Snr 1	Snare Drum 2	Gated SD
41	Low Tom 2	Room Low Tom 2'	Room Low Tom 2	Elec Low Tom 2
42	Closed Hi-hat 1' [EXC1]	Closed Hi-hat 1' [EXC1]	Closed Hi-hat 1 [EXC1]	Closed Hi-hat 1 [EXC1]
43	Low Tom 1	Room Low Tom 1'	Room Low Tom 1	Elec Low Tom 1
44	Pedal Hi-hat 1' [EXC1]	Pedal Hi-hat 1' [EXC1]	Pedal Hi-hat 1 [EXC1]	Pedal Hi-hat 1 [EXC1]
45	Mid Tom 2	Room Mid Tom 2'	Room Mid Tom 2	Elec Mid Tom 2
46	Open Hi-hat 1' [EXC1]	Open Hi-hat 1' [EXC1]	Open Hi-hat 1 [EXC1]	Open Hi-hat 1 [EXC1]
47	Mid Tom 1	Room Mid Tom 1'	Room Mid Tom 1	Elec Mid Tom 1
C3 48	High Tom 2	Room Hi Tom 2'	Room Hi Tom 2	Elec Hi Tom 2
49	Crash Cymbal 1	Crash Cymbal 1	Crash Cymbal 1	Crash Cymbal 1
50	High Tom 1	Room Hi Tom 1'	Room Hi Tom 1	Elec Hi Tom 1
51	Ride Cymbal 1	Ride Cymbal 1	Ride Cymbal 1	Ride Cymbal 1
52	Chinese Cymbal	Chinese Cymbal	Chinese Cymbal	Reverse Cymbal
53	Ride Bell	Ride Bell	Ride Bell	Ride Bell
54	Tambourine	Tambourine	Tambourine	Tambourine
55	Splash Cymbal	Splash Cymbal	Splash Cymbal	Splash Cymbal
56	Cowbell	Cowbell	Cowbell	Cowbell
57	Crash Cymbal 2	Crash Cymbal 2	Crash Cymbal 2	Crash Cymbal 2
58	Vibra-slap	Vibra-slap	Vibra-slap	Vibra-slap
59	Ride Cymbal 2	Ride Cymbal 2	Ride Cymbal 2	Ride Cymbal 2
C4 60	High Bongo	High Bongo	High Bongo	High Bongo
61	Low Bongo	Low Bongo	Low Bongo	Low Bongo
62	Mute High Conga	Mute High Conga	Mute High Conga	Mute High Conga
63	Open High Conga	Open High Conga	Open High Conga	Open High Conga
64	Low Conga	Low Conga	Low Conga	Low Conga
65	High Timbale	High Timbale	High Timbale	High Timbale
66	Low Timbale	Low Timbale	Low Timbale	Low Timbale
67	High Agogo	High Agogo	High Agogo	High Agogo
68	Low Agogo	Low Agogo	Low Agogo	Low Agogo
69	Cabasa	Cabasa	Cabasa	Cabasa
70	Maracas	Maracas	Maracas	Maracas
71	Short Hi Whistle [EXC2]	Short Hi Whistle [EXC2]	Short Hi Whistle [EXC2]	Short Hi Whistle [EXC2]
C5 72	Long Low Whistle [EXC2]	Long Low Whistle [EXC2]	Long Low Whistle [EXC2]	Long Low Whistle [EXC2]
73	Short Guiro [EXC3]	Short Guiro [EXC3]	Short Guiro [EXC3]	Short Guiro [EXC3]
74	Long Guiro [EXC3]	Long Guiro [EXC3]	Long Guiro [EXC3]	Long Guiro [EXC3]
75	Claves	Claves	Claves	Claves
76	High Wood Block	High Wood Block	High Wood Block	High Wood Block
77	Low Wood Block	Low Wood Block	Low Wood Block	Low Wood Block
78	Mute Cuica [EXC4]	Mute Cuica [EXC4]	Mute Cuica [EXC4]	Mute Cuica [EXC4]
79	Open Cuica [EXC4]	Open Cuica [EXC4]	Open Cuica [EXC4]	Open Cuica [EXC4]
80	Mute Triangle [EXC5]	Mute Triangle [EXC5]	Mute Triangle [EXC5]	Mute Triangle [EXC5]
81	Open Triangle [EXC5]	Open Triangle [EXC5]	Open Triangle [EXC5]	Open Triangle [EXC5]
82	Shaker	Shaker	Shaker	Shaker
83	Jingle Bell	Jingle Bell	Jingle Bell	Jingle Bell
C6 84	Bell Tree	Bell Tree	Bell Tree	Bell Tree
85	Castanets	Castanets	Castanets	Castanets
86	Mute Surdo [EXC6]	Mute Surdo [EXC6]	Mute Surdo [EXC6]	Mute Surdo [EXC6]
87	Open Surdo [EXC6]	Open Surdo [EXC6]	Open Surdo [EXC6]	Open Surdo [EXC6]
88	-----	-----	-----	-----

* -----: No sound.

* [EXC]: will not sound simultaneously with other percussion instruments of the same number.

	TR-808 Set	DANCE Set	JAZZ GS STANDARD Set	BRUSH Set
21	-----	-----	-----	-----
22	-----	-----	-----	-----
23	-----	-----	-----	-----
24	Bar Chime	Bar Chime	Bar Chime	Bar Chime
25	Snare Roll	Snare Roll	Snare Roll	Snare Roll
26	Finger Snap	Finger Snap	Finger Snap	Finger Snap
27	High Q	High Q	High Q	High Q
28	Slap	Slap	Slap	Slap
29	Scratch Push [EXC7]	Scratch Push [EXC7]	Scratch Push [EXC7]	Scratch Push [EXC7]
30	Scratch Pull [EXC7]	Scratch Pull [EXC7]	Scratch Pull [EXC7]	Scratch Pull [EXC7]
31	Sticks	Dance Snr 1	Sticks	Sticks
32	Square Click	Square Click	Square Click	Square Click
33	Metronome Click	Metronome Click	Metronome Click	Metronome Click
34	Metronome Bell	Metronome Bell	Metronome Bell	Metronome Bell
35	Std Kick 2	Kick 1	Std Kick 2	Kick 2
C2 36	808 Bass Drum 1	808 Bass Drum 2	Std Kick 1	Kick 1
37	808 Rim Shot	808 Rim Shot	Side Stick	Side Stick
38	808 Snare Drum	TR-909 Snr	Snare Drum 1	Brush Tap
39	Hand Clap	Hand Clap	Hand Clap	Brush Slap
40	Snare Drum 2	Dance Snr 2	Snare Drum 2	Brush Swirl
41	808 Low Tom 2	808 Low Tom 2	Low Tom 2	Brush Low Tom 2
42	808 CHH [EXC1]	808 CHH [EXC1]	Closed Hi-hat 1 [EXC1]	Closed Hi-hat 2 [EXC1]
43	808 Low Tom 1	808 Low Tom 1	Low Tom 1	Brush Low Tom 1
44	808 CHH [EXC1]	808 CHH [EXC1]	Pedal Hi-hat 1 [EXC1]	Pedal Hi-hat 2 [EXC1]
45	808 Mid Tom 2	808 Mid Tom 2	Mid Tom 2	Brush Mid Tom 2
46	808 OHH [EXC1]	808 OHH [EXC1]	Open Hi-hat 1 [EXC1]	Open Hi-hat 2 [EXC1]
47	808 Mid Tom 1	808 Mid Tom 1	Mid Tom 1	Brush Mid Tom 1
C3 48	808 Hi Tom 2	808 Hi Tom 2	High Tom 2	Brush Hi Tom 2
49	808 Cymbal	808 Cymbal	Crash Cymbal 1	Crash Cymbal 1
50	808 Hi Tom 1	808 Hi Tom 1	High Tom 1	Brush Hi Tom 1
51	Ride Cymbal 1	Ride Cymbal 1	Ride Cymbal 1	Ride Cymbal 1
52	Chinese Cymbal	Chinese Cymbal	Chinese Cymbal	Chinese Cymbal
53	Ride Bell	Ride Bell	Ride Bell	Ride Bell
54	Tambourine	Tambourine	Tambourine	Tambourine
55	Splash Cymbal	Splash Cymbal	Splash Cymbal	Splash Cymbal
56	808 Cowbell	808 Cowbell	Cowbell	Cowbell
57	Crash Cymbal 2	Crash Cymbal 2	Crash Cymbal 2	Crash Cymbal 2
58	Vibra-slap	Vibra-slap	Vibra-slap	Vibra-slap
59	Ride Cymbal 2	Ride Cymbal 2	Ride Cymbal 2	Ride Cymbal 2
C4 60	High Bongo	High Bongo	High Bongo	High Bongo
61	Low Bongo	Low Bongo	Low Bongo	Low Bongo
62	808 High Conga	808 High Conga	Mute High Conga	Mute High Conga
63	808 Mid Conga	808 Mid Conga	Open High Conga	Open High Conga
64	808 Low Conga	808 Low Conga	Low Conga	Low Conga
65	High Timbale	High Timbale	High Timbale	High Timbale
66	Low Timbale	Low Timbale	Low Timbale	Low Timbale
67	High Agogo	High Agogo	High Agogo	High Agogo
68	Low Agogo	Low Agogo	Low Agogo	Low Agogo
69	Cabasa	Cabasa	Cabasa	Cabasa
70	808 Maracas	808 Maracas	Maracas	Maracas
71	Short Hi Whistle [EXC2]	Short Hi Whistle [EXC2]	Short Hi Whistle [EXC2]	Short Hi Whistle [EXC2]
C5 72	Long Low Whistle [EXC2]	Long Low Whistle [EXC2]	Long Low Whistle [EXC2]	Long Low Whistle [EXC2]
73	Short Guiro [EXC3]	Short Guiro [EXC3]	Short Guiro [EXC3]	Short Guiro [EXC3]
74	Long Guiro [EXC3]	Long Guiro [EXC3]	Long Guiro [EXC3]	Long Guiro [EXC3]
75	808 Claves	808 Claves	Claves	Claves
76	High Wood Block	High Wood Block	High Wood Block	High Wood Block
77	Low Wood Block	Low Wood Block	Low Wood Block	Low Wood Block
78	Mute Cuica [EXC4]	Mute Cuica [EXC4]	Mute Cuica [EXC4]	Mute Cuica [EXC4]
79	Open Cuica [EXC4]	Open Cuica [EXC4]	Open Cuica [EXC4]	Open Cuica [EXC4]
80	Mute Triangle [EXC5]	Mute Triangle [EXC5]	Mute Triangle [EXC5]	Mute Triangle [EXC5]
81	Open Triangle [EXC5]	Open Triangle [EXC5]	Open Triangle [EXC5]	Open Triangle [EXC5]
82	Shaker	Shaker	Shaker	Shaker
83	Jingle Bell	Jingle Bell	Jingle Bell	Jingle Bell
C6 84	Bell Tree	Bell Tree	Bell Tree	Bell Tree
85	Castanets	Castanets	Castanets	Castanets
86	Mute Surdo [EXC6]	Mute Surdo [EXC6]	Mute Surdo [EXC6]	Mute Surdo [EXC6]
87	Open Surdo [EXC6]	Open Surdo [EXC6]	Open Surdo [EXC6]	Open Surdo [EXC6]
88	-----	-----	-----	-----

* -----: No sound.

* [EXC]: will not sound simultaneously with other percussion instruments of the same number.

	ORCHESTRA Set	GS ROOM Set	GS BRUSH Set
21	-----	-----	-----
22	-----	-----	-----
23	-----	-----	-----
24	Bar Chime	Bar Chime	Bar Chime
25	Snare Roll	Snare Roll	Snare Roll
26	Finger Snap	Finger Snap	Finger Snap
27	Close Hi-hat [EXC1]	High Q	High Q
28	Pedal Hi-hat [EXC1]	Slap	Slap
29	Open Hi-hat [EXC1]	Scratch Push [EXC7]	Scratch Push [EXC7]
30	Ride Cymbal	Scratch Pull [EXC7]	Scratch Pull [EXC7]
31	Sticks	Sticks	Sticks
32	Square Click	Square Click	Square Click
33	Metronome Click	Metronome Click	Metronome Click
34	Metronome Bell	Metronome Bell	Metronome Bell
35	Concert BD 2	Std Kick 2	Std Kick 2
C2 36	Concert BD 1	Std Kick 1	Std Kick 1
37	Side Stick	Side Stick	Side Stick
38	Concert SD	Snare Drum 1	Brush Tap
39	Castanets	Hand Clap	Brush Slap
40	Concert SD	Snare Drum 2	Brush Swirl
41	Timpani F	Room Low Tom 2	Low Tom 2
42	Timpani F#	Closed Hi-hat 1 [EXC1]	Closed Hi-hat 1 [EXC1]
43	Timpani G	Room Low Tom 1	Low Tom 1
44	Timpani G#	Pedal Hi-hat 1 [EXC1]	Pedal Hi-hat 1 [EXC1]
45	Timpani A	Room Mid Tom 2	Mid Tom 2
46	Timpani A#	Open Hi-hat 1 [EXC1]	Open Hi-hat 1 [EXC1]
47	Timpani B	Room Mid Tom 1	Mid Tom 1
C3 48	Timpani c	Room Hi Tom 2	High Tom 2
49	Timpani c#	Crash Cymbal 1	Crash Cymbal 1
50	Timpani d	Room Hi Tom 1	High Tom 1
51	Timpani d#	Ride Cymbal 1	Ride Cymbal 1
52	Timpani e	Chinese Cymbal	Chinese Cymbal
53	Timpani f	Ride Bell	Ride Bell
54	Tambourine	Tambourine	Tambourine
55	Splash Cymbal	Splash Cymbal	Splash Cymbal
56	Cowbell	Cowbell	Cowbell
57	Concert Cymbal 2	Crash Cymbal 2	Crash Cymbal 2
58	Vibra-slap	Vibra-slap	Vibra-slap
59	Concert Cymbal 1	Ride Cymbal 2	Ride Cymbal 2
C4 60	High Bongo	High Bongo	High Bongo
61	Low Bongo	Low Bongo	Low Bongo
62	Mute High Conga	Mute High Conga	Mute High Conga
63	Open High Conga	Open High Conga	Open High Conga
64	Low Conga	Low Conga	Low Conga
65	High Timbale	High Timbale	High Timbale
66	Low Timbale	Low Timbale	Low Timbale
67	High Agogo	High Agogo	High Agogo
68	Low Agogo	Low Agogo	Low Agogo
69	Cabasa	Cabasa	Cabasa
70	Maracas	Maracas	Maracas
71	Short Hi Whistle [EXC2]	Short Hi Whistle [EXC2]	Short Hi Whistle [EXC2]
C5 72	Long Low Whistle [EXC2]	Long Low Whistle [EXC2]	Long Low Whistle [EXC2]
73	Short Guiro [EXC3]	Short Guiro [EXC3]	Short Guiro [EXC3]
74	Long Guiro [EXC3]	Long Guiro [EXC3]	Long Guiro [EXC3]
75	Claves	Claves	Claves
76	High Wood Block	High Wood Block	High Wood Block
77	Low Wood Block	Low Wood Block	Low Wood Block
78	Mute Cuica [EXC4]	Mute Cuica [EXC4]	Mute Cuica [EXC4]
79	Open Cuica [EXC4]	Open Cuica [EXC4]	Open Cuica [EXC4]
80	Mute Triangle [EXC5]	Mute Triangle [EXC5]	Mute Triangle [EXC5]
81	Open Triangle [EXC5]	Open Triangle [EXC5]	Open Triangle [EXC5]
82	Shaker	Shaker	Shaker
83	Jingle Bell	Jingle Bell	Jingle Bell
C6 84	Bell Tree	Bell Tree	Bell Tree
85	Castanets	Castanets	Castanets
86	Mute Surdo [EXC6]	Mute Surdo [EXC6]	Mute Surdo [EXC6]
87	Open Surdo [EXC6]	Open Surdo [EXC6]	Open Surdo [EXC6]
88	Applause	-----	-----

SFX Set List

* -----: No sound.

* [EXC]: will not sound simultaneously with other percussion instruments of the same number.

SFX Set 1	
21	-----
22	-----
23	-----
24	-----
25	-----
26	-----
27	-----
28	-----
29	-----
30	-----
31	-----
32	-----
33	-----
34	-----
35	-----
C2 36	-----
37	-----
38	-----
39	High Q
40	Slap
41	Scratch Push [EXC7]
42	Scratch Pull [EXC7]
43	Sticks
44	Square Click
45	Metronome Click
46	Metronome Bell
47	Guitar sliding Finger
C3 48	Guitar cutting noise (up)
49	Guitar cutting noise (down)
50	String slap of double bass
51	Fl.Key Click
52	Laughing
53	Screaming
54	Punch
55	Heart Beat
56	Footsteps1
57	Footsteps2
58	Applause
59	Door Creaking
C4 60	Door
61	Scratch
62	Wind Chimes
63	Car-Engine
64	Car-Stop
65	Car-Pass
66	Car-Crash
67	Siren
68	Train
69	Jetplane
70	Helicopter
71	Starship
C5 72	Gun Shot
73	Machine Gun
74	Lasergun
75	Explosion
76	Dog
77	Horse-Gallop
78	Birds
79	Rain
80	Thunder
81	Wind
82	Seashore
83	Stream
C6 84	Bubble
85	Cat
86	Bird
87	BabyLaughing
88	Boeeseen
89	Glass & Glam
90	Ice Ring
91	Crack Bottle
92	Pour Bottle
93	Car Horn
94	R.Crossing
95	SL 1
C7 96	SL 2
97	Seal
98	Fancy Animal
99	-----
100	-----
101	-----
102	Small Club
103	-----
104	-----
105	-----

Effects List

Display	Description
GS Chorus 1	Applies a light chorus effect with slow undulations
GS Chorus 2	Applies a light chorus effect with quick undulations
GS Chorus 3	Applies a deep chorus effect with slow undulations
GS Chorus 4	Applies a deep chorus effect with quick undulations
GS Feedback Chorus	A soft sound with a flanger effect
GS Flanger	An effect that sounds like a jet plane's ascent/descent
GS Short Delay	A short echo effect
GS Short Delay (Feedback)	A short echo with many repetitions
Stereo Chorus	A stereo chorus.
Hexa Chorus	A multilayer chorus.
Tremolo Chorus	A chorus with a tremolo effect.
Space D	A clear chorus.
Rotary	Adds a rotary-speaker effect.
Stereo Delay	Delays the sound with a stereo effect.
Modulation Delay	Adds a wavering effect to the delayed sound.
Triple Tap Delay	A three-way delay.
Quadruple Tap Delay	A four-way delay.
Phaser	Adds undulations to the sound.
Stereo Flanger	Adds metallic reverberations.
Step Flanger	A flanger that varies the pitch in a stepwise fashion.
Enhancer	Adds modulation to the sound.
Overdrive	Applies soft distortion to the sound.
Distortion	Applies hard distortion to the sound.
Auto Wah	Changes the tone in a cyclical manner.
Compressor	Suppresses fluctuations in volume.
Gate Reverb	Cuts off the reverberations before they fade away completely.
2V Pitch Shifter	Adds two pitch-shifted sounds to the original sound (two-voice pitch shifter).
FB Pitch Shifter	The pitch will change in steps (feedback pitch shifter).
Enhancer -> Chorus	Applies both enhancer and chorus effects.
Enhancer -> Flanger	Applies both enhancer and flanger effects.
Enhancer -> Delay	Applies both enhancer and delay effects.
Chorus -> Delay	Applies both chorus and delay effects.
Flanger -> Delay	Applies both flanger and delay effects.

Display	Description
Overdrive -> Chorus	Applies both overdrive and chorus effects.
Overdrive -> Flanger	Applies both overdrive and flanger effects.
Overdrive -> Delay	Applies both overdrive and delay effects.
Distortion -> Chorus	Applies both distortion and chorus effects.
Distortion -> Flanger	Applies both distortion and flanger effects.
Distortion -> Delay	Applies both distortion and delay effects.
Sympathetic Resonance	Applies a resonance effect when the damper pedal is depressed.

Chord List

* ● symbol : Indicates the constituent note of chords.

* ★ symbol : Chord shown with an “★” can be played by pressing just the key marked with the “★” (p. 37).

C	C#	D	E \flat	E	F
Cmaj7	C#maj7	Dmaj7	E \flat maj7	Emaj7	Fmaj7
C7	C#7	D7	E \flat 7	E7	F7
Cm	C#m	Dm	E \flat m	Em	Fm
Cm7	C#m7	Dm7	E \flat m7	Em7	Fm7
Cdim	C#dim	Ddim	E \flat dim	Edim	Fdim
Cm7 (b5)	C#m7 (b5)	Dm7 (b5)	E \flat m7 (b5)	Em7 (b5)	Fm7 (b5)
Caug	C#aug	Daug	E \flat aug	Eaug	Faug
Csus4	C#sus4	Dsus4	E \flat sus4	Esus4	Fsus4
C7sus4	C#7sus4	D7sus4	E \flat 7sus4	E7sus4	F7sus4
C6	C#6	D6	E \flat 6	E6	F6
Cm6	C#m6	Dm6	E \flat m6	Em6	Fm6

* ● symbol : Indicates the constituent note of chords.

* ★ symbol : Chord shown with an “★” can be played by pressing just the key marked with the “★” (p. 37).

F#	G	A \flat	A	B \flat	B
F#maj7	Gmaj7	A \flat maj7	A \flat maj7	B \flat maj7	Bmaj7
F#7	G7	A \flat 7	A7	B \flat 7	B7
F#m	Gm	A \flat m	Am	B \flat m	Bm
F#m7	Gm7	A \flat m7	Am7	B \flat m7	Bm7
F#dim	Gdim	A \flat dim	Adim	B \flat dim	Bdim
F#m7 (b5)	Gm7 (b5)	A \flat m7 (b5)	Am7 (b5)	B \flat m7 (b5)	Bm7 (b5)
F#aug	Gaug	A \flat aug	Aaug	B \flat aug	Baug
F#sus4	Gsus4	A \flat sus4	Asus4	B \flat sus4	Bsus4
F#7sus4	G7sus4	A \flat 7sus4	A7sus4	B \flat 7sus4	B7sus4
F#6	G6	A \flat 6	A6	B \flat 6	B6
F#m6	Gm6	A \flat m6	Am6	B \flat m6	Bm6

Internal Song List

[Masterpieces]

Sonate No.15
Liebestraume 3
Etude, op.10-3
Je te veux
Valse, op.64-1
Golliwog'sCakewalk
FantaisieImpromptu
Arabesque 1
Blauen Donau
Auf Flugeln des Gesanges
Mazurka No.5
Gymnopedie 1
Etude, op.25-1
Clair de Lune
Etude, op.10-5
Dr.GradusAdParnassum
Grande Valse Brillante
La priere d'une Vierge
Course en Troika
To The Spring
Valse, op.64-2
Radetzky Marsch
Traumerei
Moments Musicaux 3
Prelude, op.28-15
Harmonious Blacksmith
Ungarische Tanze 5
Turkischer Marsch(Beethoven)
Nocturne No.2
Fruehlingslied
Praludium
Jagerlied
Menuet Antique
Fur Elise
Turkischer Marsch(Mozart)
Standchen
Humoreske
Blumenlied
Alpenglockchen
Menuett G dur(Beethoven)
Venezianisches Gondellied
Alpenabendrote
Farewell to the Piano
Brautchor
Battle of Waterloo
Wiener Marsch
Le Coucou
Menuett G dur(Bach)
Spinnerlied
Gavotte
Heidenroslein
Zigeuner Tanz
La Cinquantaine
Csikos Post
Dolly's Dreaming Awakening
La Violette
Frohlicher Landmann
Sonatine op.36-1(Clementi)
Sonatine op.20-1(Kuhlau)
Sonatine No.5(Beethoven)

[Practice]

Beyer 15
Beyer 21
Beyer 25
Beyer 29
Beyer 34
Beyer 38
Beyer 42
Beyer 46
Beyer 51
Beyer 55
Beyer 60
Beyer 64
Beyer 67
Beyer 73
Beyer 78
Beyer 81
Beyer 90
Beyer 93
Beyer 98
Beyer 103
Czerny 100- 1
Czerny 100-10
Czerny 100-20
Czerny 100-30
Czerny 100-38
Czerny 100-43
Czerny 100-60
Czerny 100-75
Czerny 100-86
Czerny 100-96
Openness
Arabesque
Pastoral
A Small Gathering
Innocence
Progress
The Clear Stream
Gracefulness
The Hunt
Tender Flower
The Young Shepherdess
Farewell
Consolation
Austrian Dance
Ballad
Sighing
The Chatterbox
Restlessness
Ave Maria
Tarantella
Angelic Harmony
Gondola Song
The Return
The Swallow
The Knight Errant
Invention 1
Invention 2
Invention 3
Invention 4
Invention 5
Invention 6
Invention 7
Invention 8
Invention 9
Invention 10
Invention 11
Invention 12
Invention 13
Invention 14
Invention 15

[Folks]

Annie Laurie
Londonderry Air
Amazing Grace
Ave Maria
Entertainer
Greensleeves
Hallelujah!
Little Brown Jug
Marchin' In
Stagecoach

[Kids]

Old MacDonald Had A Farm
Twinkle Twinkle, Little Star
MaryHadALittleLamb
London Bridge
Jingle Bells
Silent Night, Holy Night
Joy To The World
Grandfather'sClock
Puppy's March
Frog Song
Little Fox
Lightly Row
The Cuckoo

[Jazzy]

Preludelight
Blue Sky Rag
Secret Agent
Late Night Chopin
Fly Free
Sun Daze
Keepers Tale
Count On The Blues
One Down And Easy
A Prelude To ...
Bach's A Boppin'
Kismet's Salsa
From Matthew's Passion
Roll Over Ludwig

[Easy Classical]

Canon (Pachelbel)
Ombra maifu
O'sole Mio
Les patineurs, Valse
Brindisi
Die Lorelei
Traumerei
Liebestraume 3
Prelude, op.28-15
Grande Valse Brillante
Mondschein
FantaisieImpromptu
Valse, op.64-1
Air sul G
Gymnopedie 1
Ungarische Tanze 5
Turkischer Marsch(Mozart)
Nocturne No.2

* All rights reserved. Unauthorized use of this material for purposes other than private, personal enjoyment is a violation of applicable laws.

Parameters Stored to Internal Memory

Parameters Stored in the User Program

→ “Saving Performance Settings (User Program)” (p. 93)

Parameters that switch immediately after the User Program name is touched when <Option> on the User Program screen is set to “Delayed”	
Organ	Rotary effect (Slow/Fast), Footage (Upper, Lower), Percussion
Selected Right-hand Tone, Layer Tone, Left-hand Tone	Tone, Octave Shift, Effect (Type, Depth, On/Off)
Bass Tone, Chord Tone	
Part Balance	Keyboard Parts
Melody Intelligent	On/Off, Type
Keyboard Mode	Split On/Off, Layer On/Off, Lower On/Off, Keyboard Transpose, Split Point
Pedal Settings	Functions assigning to the left pedal and center pedal
Performance Pad Settings	Style Orchestrator, User Function Style Orchestrator values assigning the Pads
Keyboard settings (One-Touch Piano/ One-Touch Arranger/Others)	
Reverb	On/Off, Type, Depth
Bend Range	
MIDI Settings for User Program	PC Number, Bank Select LSB, Bank Select MSB, Program Change
Parameters that switch after the User Program name is touched for a few moments when <Option> on the User Program screen is set to “Delayed”	
Music Style	
Tempo	
Part Balance	Accompaniment Part
Arranger Settings	Accompaniment On/Off, Chord Intelligence On/Off, Leading Bass On/Off, Original/Variation, Sync Start On/Off, <Accomp> setting for Arranger Configuration, Style Orchestrator, Division

Parameters Stored in Memory Backup

→ “Remembering the Settings Even When the Power is Turned Off (Memory Backup)” (p. 138)

Tone Parameters	Octave Shift Effects: On/Off, Type, Depth
System Parameters	One-Touch Piano Settings: Lid, Tuning (Tuning, Key, Stretch Tunings), Resonance, Key Touch, String Resonance, Hammer Response (On/Off, Depth)
	Metronome: Sound
	Count-In: Measures, Sound
	Countdown: Sound
	Language
	Opening Message
	Touch Screen
	Track Assign
	Reverb: On/Off, Type, Depth

Music Files That the KR105 Can Use

What Are Music Files?

Music Files contain information describing the details of a musical performance, such as “the C3 key on a keyboard was pressed for this amount of time, using this amount of force.” By inserting the floppy disk into the disk drive on the KR105, the performance information is sent from the floppy disk to the piano, and played faithfully by the piano. This is different than a CD, since the music file does not contain a recording of the sound itself. This makes it possible to erase certain parts, or to change instruments, tempos and keys freely, allowing you to use it in many different ways.

Regarding Copyright

Use of the song data supplied with the Data Disk attached to this product for any purpose other than private, personal enjoyment without the permission of the copyright holder is prohibited by law. Additionally, this data must not be copied, nor used in a secondary copyrighted work without the permission of the copyright holder.

■ The KR105 allows you to use the following music files

- Floppy disks saved on a Roland MT Series, or Roland Piano Digital HP-G/R and KR Series instrument
 - Roland Digital Piano Compatible Music Files
Roland’s original music file is made specifically for practicing the piano. Some follow an instructional curriculum, allowing for a complete range of lessons, such as “practicing each hand separately” or “listening to only the accompaniment.”
 - SMF Music Files (720KB/1.44MB format)
SMFs (Standard MIDI Files) use a standard format for music file that was formulated so that files containing music file could be widely compatible, regardless of the manufacturer of the listening device. An enormous variety of music is available, whether it be for listening, for practicing musical instruments, for Karaoke, etc.
- * If you wish to purchase SMF Music Files, please consult the retailer where you purchased your KR105.

SMF with Lyrics

“SMF with Lyrics” refers to SMF (Standard MIDI File) that contains the lyrics. When Music Files carrying the “SMF with Lyrics” logo are played back on a compatible device (one bearing the same logo), the lyrics will appear in its display.

■ About the KR105’s Sound Generator

The KR105 comes equipped with GM 2/GS sound generators.

General MIDI

The General MIDI is a set of recommendations which seeks to provide a way to go beyond the limitations of proprietary designs, and standardize the MIDI capabilities of sound generating devices. Sound generating devices and music files that meets the General MIDI standard bears the General MIDI logo. Music files bearing the General MIDI logo can be played back using any General MIDI sound generating unit to produce essentially the same musical performance.

General MIDI 2

The upwardly compatible General MIDI 2 recommendations pick up where the original General MIDI left off, offering enhanced expressive capabilities, and even greater compatibility. Issues that were not covered by the original General MIDI recommendations, such as how sounds are to be edited, and how effects should be handled, have now been precisely defined. Moreover, the available sounds have been expanded. General MIDI 2 compliant sound generators are capable of reliably playing back music files that carry either the General MIDI or General MIDI 2 logo.

In some cases, the conventional form of General MIDI, which does not include the new enhancements, is referred to as “General MIDI 1” as a way of distinguishing it from General MIDI 2.

GS Format

The GS Format is Roland’s set of specifications for standardizing the performance of sound generating devices. In addition to including support for everything defined by the General MIDI, the highly compatible GS Format additionally offers an expanded number of sounds, provides for the editing of sounds, and spells out many details for a wide range of extra features, including effects such as reverb and chorus. Designed with the future in mind, the GS Format can readily include new sounds and support new hardware features when they arrive. Since it is upwardly compatible with the General MIDI, Roland’s GS Format is capable of reliably playing back GM Scores equally as well as it performs GS music files (music files that have been created with the GS Format in mind). This product supports both the General MIDI 2 and the GS Format, and can be used to play back music data carrying either of these logos.

XG lite

XG is a tone generator format of YAMAHA Corporation, that defines the ways in which voices are expanded or edited and the structure and type of effects, in addition to the General MIDI 1 specification. XGlite is a simplified version of XG tone generation format. You can play back any XG music files using an XGlite tone generator. However, keep in mind that some music files may play back differently compared to the original files, due to the reduced set of control parameters and effects.

MIDI Implementation Chart

Function...	Transmitted	Recognized	Remarks
Basic Channel Default Changed	1 1—16	1—16 1—16	
Mode Default Messages Altered	Mode 3 x *****	Mode 3 Mode 3, 4 (M=1)	* 2
Note Number : True Voice	15—113 *****	0—127 0—127	
Velocity Note ON Note OFF	O x 8n v=64	O x	
After Touch Key s Ch s	x x	O *1 O *1	
Pitch Bend	O	O	
Control Change	0, 32 O 1 O *1 5 O *1 6, 38 O *1 7 O *1 10 O *1 11 O *1 64 O 65 O *1 66 O 67 O 84 O *1 91 O 93 O 98, 99 O *1 100, 101 O *1	O *1 O *1 O *1 O *1 O *1 O *1 O *1 O *1 O *1 O *1 O *1 O *1 O (Reverb) *1 O (Chorus) *1 O *1 O *1 O *1	Bank select Modulation Portamento time Data entry Volume Panpot Expression Hold 1 Portamento Sostenuto Soft Portamento control Effect1 depth Effect3 depth NRPN LSB, MSB RPN LSB, MSB
Prog Change : True #	0—127 *****	O 0—127	Program number 1—128
System Exclusive	O	O	
System Common : Song Pos : Song Sel : Tune	x x x	x x x	
System Real Time : Clock : Commands	O x	x x	
Aux Message : All sound off : Reset all controllers : Local Control : All Notes OFF : Active Sense : Reset	x x x x O x	O (120, 126, 127) O O O (123—125) O x	
Notes	* 1 O x is selectable by SysEx. * 2 Recognized as M=1 even if M≠1.		

Mode 1 : OMNI ON, POLY Mode 2 : OMNI ON, MONO
Mode 3 : OMNI OFF, POLY Mode 4 : OMNI OFF, MONO

O : Yes
X : No

Main Specifications

<Keyboard>	
Keyboard	88 keys (Progressive hammer action keyboard with escapement)
Touch Sensitivity	100 levels
Keyboard Mode	Whole Split (adjustable split point) Layer Arranger Piano Style Arranger Manual Drums / SFX

<Sound Generator>	
Conforms to GM2 / GS / XG Lite	
Max. Polyphony	64 voices
Tones (Tone Search by terms and by letters)	6 groups, 630 variations (including 4 tone wheel organs, 15drum sets, 1 SFX set)
Temperament	8 types, selectable tonic
Stretched Tuning	2 types
Master Tuning	415.3 Hz-466.2 Hz (adjustable in increments of 0.1 Hz)
Transpose	Key Transpose (-6+5 in units of semitone) Playback Transpose (-24+24 in units of semitone)
Effects	Reverb (8 types) Chorus Sympathetic Resonance, Rotary and 32 other types

<Arranger>	
Music Styles (Style Search by terms and by letters)	6 groups, 230 styles x 3 types (Style Orchestrator)
Music Assistant (Search by terms and by letters)	Over 330 sets x 6 presets Visual Music Assistant
Programmable Music Styles	Style Converter Style Composer
Melody Intelligence	24 types

<User Programs>	
Internal	36
Floppy disk	Max. 99 sets

<Metronome>	
Tempo	Quarter note = 10-500
Beat	2/2, 0/4, 2/4, 3/4, 4/4, 5/4, 6/4, 7/4, 3/8, 6/8, 9/8, 12/8
Volume	10 levels
Metronome Pattern	11 patterns
Metronome Sound	8 types

<Composer>	
Tracks	5 tracks / 16 tracks
Song	1 song
Note Storage	Approx. 30,000 notes
Resolution	120 ticks per quarter note
Recording Method	Realtime (Replace, Mix, Auto Punch In, Manual Punch In, Loop, Tempo) Step (Chord Sequencer) Beat Map

Edit	Copy Delete Erase Part Exchange PC Edit	Quantize Insert Transpose Note Edit
Other Functions	Touch the Notes Replay Super Tones Piano Designer Visual Lesson Wonderland/Game Demo Audition Panel Lock User Image Display BMP Export V-LINK	

<Internal Memory>	
Internal Songs (Song Search by terms and by letters)	Over 170 songs
User Memory	Max. 200 songs on Favorites Max. 99 User Styles Max. 99 User Program Sets

<Others>	
Rated Power Output	40W x 2
Speakers	20 cm x2, 6 cm x2
Display	Bouncing Beat Indicator Graphical LCD 320 x 240 dot (backlit)
Notation	Grand staff / G Clef staff / F Clef staff, with note name /lyrics/ chords / fingering
Language	English / German / French / Spanish
Lyrics	Yes (built-in, external display, MIDI output)
One Touch Program	One Touch Piano One Touch Arranger
Pedals	Damper Pedal (half-pedal recognition) Soft Pedal (half-pedal recognition, functions assignable) Sostenuto Pedal (functions assignable)
Vocal Effects	Echo
Connectors	Output jacks (L/Mono, R) Input jacks (L/Mono, R) Mic Input jack Headphones jack (Stereo) x 2 MIDI In connector x 2 MIDI Out connector USB connector Expression Pedal jack
Power Supply	AC 110/117V, AC 230/240V
Dimensions (including the piano stand)	1421 (W) x 550 (D) x 901 (H) mm Including the music rest 1421 (W) x 550 (D) x 1106 (H) mm
Weights (including the piano stand)	80kg
Accessories	Quick Start Owner's Manual USB Installation Guide CD-ROM (Roland Digital Piano USB Driver) Power cord

* In the interest of product improvement, the specifications and/or appearance of this unit are subject to change without prior notice.

Index

Numerics

16-Track Sequencer 99

A

A.Bass 47

AC inlet 15

Accompaniment

Start and Stop 43

Sync Start 43

Adjuster 17

Arranger basic screen 47

Arranger Config 128

As SMF 89

Audio Equipment 148

Auto Punch-In/Out 105

Automatic Accompaniment 35

B

Balance 52

Balance Knob 52

Bank Select LSB 147

Bank Select MSB 147

Basic Screen 19

Basic tempo 114

Bass

Leading 47

Bass Tone 44, 128

Beat

Indicator 137

LED 137

Metronome 33

Beat Map 113

Bend Range 128

Blank Recording 104

[Brilliance] knob 17

[Bwd] button 55

C

Calibration 139

Chord Finder 38

Chord Intelligence 37

Chord List 164

Chord Sequencer 106

Chord Tone 44, 128

Chord Type 37

Chords 37, 64

Clef L 64

Clef R 64

Compatibility 89

Composer MIDI Out 147

Computer 149

Connecting

Audio Equipment 148

Computer 149

MIDI device 143

Video Equipment 143

Contrast 18

Contrast knob 18

Converter 118

Copy (Song Edit) 108

Copying

Songs 91

User Program 96

User Styles 123

Count In 68

Countdown 45

D

Damper pedal 16

Delete (Song Edit) 110

Deleting

A song 90

User Style 122

DigiScore 61

Disk Drive 85

Divisions 35

Drum Set List 158

Drums 23

E

Editing 107

Effects 30

Effects List 163

Eject button 85

Ending 35, 44

Erase (Song Edit) 111

Erasing

Performance on specific tracks 82

Recorded performance 82

Error Messages 155

Export 65

F

Factory Reset 138

Factory Setting

Touch Screen 139

User Memory 139

Favorites 59, 87

Registering 59

Removing 60

Fill In 46

To Original 35

To Variation 35

Finder

Index

Song 57
Finger Numbers 64
Floppy Disk 85
Format 85
[Fwd] button 55

G
General MIDI 168
General MIDI 2 168
GS 168
GS Format 168

H
Hammer Response 134
Harmony 49
Headphones 17

I
Icon 19
i-format 89
ILeading Bass 47
Insert (Song Edit) 110
Internal Song List 166
Intro 35, 43
[Intro/Ending] button 43
Intro/Ending Type 44

K
Karaoke 31
Key 64
Key Touch 124, 135

L
Language 136
Layer 25
Layer tone 25
Leading bass 127
Lid 16
Local Control 146
Loop Recording 104
Lower Tone 50
Lyrics 19, 64, 141

M
Manual Punch-In/Out 105
Marker 70, 131
 Erasing 71
 Moving 71
 Placing 70
 Repeat 72
Master Tuning 136
Melody Intelligence 49
Memory Backup 138

Metronome 32
 Beat 33
 Pattern 34
 Sound 33
 Volume 33
Mic In jack 18
[Mic Volume] knob 18
Microphone 18
MIDI 143
MIDI Connector 143
MIDI Devices 143
MIDI Ensemble 145
MIDI Settings 146
MIDI Sync 144
Minus One 69
Mix Recording 103
Multitrack Recording 99
Music Holder 15
Music Style 35
 On Disk 41
 Rhythm Pattern 42
Music Style Buttons 39
Mute 69, 100

N
New Song 76
Note Edit (Song Edit) 112

O
Octave Shift 27
One Touch Program
 Arranger 36, 124
 Piano 20, 132
One Touch Setting 125
Opening Message 136
Orchestrator 48
Original 35, 46
Output Jacks 148

P
Pad 126
Panel Lock 140
Part Balance 52
[Part Balance] button 52
Part Exchange (Song Edit) 112
PC Edit (Song Edit) 113
Pedal 16
Pedal Cable 15
Pedal connector 15
Pedal Settings 126
Percussion 22
Performance Pad 48, 126

- Phones jack 17
- Piano 20
- Piano Screen 19
- Pickup 84
- Pitches 64
- Play Mode 141
- Play/Stop 55
- Playing 54
 - All of the internal songs 54
 - At a fixed tempo (Tempo Mute) 67
 - In random 54
 - Repeat 72
- Power Cord 15
- Power On and Off 16
- [Power] switch 16
- Preset 39
- Program Change 147
- Protect tab 85
- PU (Pickup) 84
- Punch-in Recording 105

- Q**
- Quantize (Song Edit) 109
- Quick Tour
 - Automatically starting 140

- R**
- Rec Mode 83, 102
- Record/Playback Buttons 55
- Recording 75
 - 16-Track Sequencer 101
 - A new song 76
 - Along with a Song 80
 - Redoing recordings 81
 - Track buttons 81
 - With Accompaniment 78
- Repeat 72
- Replace Recording 103
- Replay 61
- Reset 55
- Resonance 132
- Restoring the Factory Settings 138
- Reverb 28
- Revolving Bass 47
- Root note 37
- Rotary effect 127

- S**
- Saving 87
 - Compatibility 89
 - User Style 121
- Score 61
- Saving as image data 65
- Settings 64
- Screens
 - 16-track Sequencer screen 99
 - Basic screen 19, 36
 - Chord Sequencer screen 106
 - Copy Song screen 91
 - Copy Style screen 123
 - Copy User Programs screen 96
 - Count settings screen 68
 - Countdown settings screen 45
 - Delete Song screen 90
 - Delete Style screen 122
 - Delete User Program screen 96
 - Effects screen 30
 - Functions screen 132
 - Load User Program screen 95
 - Marker screen 70
 - Melody Intelligence screen 49
 - Metronome screen 32
 - MIDI Setting Screen 146
 - Part Balance screen 52
 - PEDAL screen 97
 - Piano screen 19~20
 - Program Change Screen 146
 - Rec Mode screen 103
 - Rename screen 88, 93, 121
 - Reverb screen 28
 - Save Song screen 87
 - Save Style screen 121
 - Save User Program screen 94
 - Score screen 61
 - Song Edit screen 107
 - Song File screen 86
 - Song Selection screen 54
 - Style Composer screen 117
 - Style Converter screen 119
 - Style Search screen 40
 - Style Selection screen 39
 - Tone search screen 24
 - Tone selection screen 21
 - Transpose screen 73
 - User Program screen 93
 - Write User Program screen 93
- Search
 - Music Style 40
 - Tone 24
- SFX Set List 162
- SMF 168
 - Music files 168

Index

Soft pedal 16
Solo 100
Song Search 57
Song/File 54
Sostenuto pedal 16
Sound Effects 22
Sound Generator 168
Specifications 170
Split 51
Split Point 125
Start/Stop 43
Stretch Tuning 130, 133
String Resonance 134
Style
 Composer 116
 Converter 118
 Orchestrator 48
Style Search 40
Sync 43

T

Tap Tempo 66
Temperament 124, 129, 133
Tempo 33, 42, 66
 [-] [+] 66
 Mute 67
 Recording 114
Tone Buttons 21
Tone List 156
Tone Search 24
Tone Set 101
Touch Screen 18, 139
Touch the Notes 63
Track Assign 142
Track Buttons 69, 77, 79
Transpose 73
 Song Edit 111
Troubleshooting 151
Tuning 129, 133
Tuning Curve 130, 133
Tx Channel 146

U

Undo (Song Edit) 108
Upper tone 25
User Functions 126
User Image Display 137
User Memory 121
 Formatting 139
User Program 93
 Calling up 94

 Copying 96
 Deleting 96
 Loading 95
 Registering 93
 Saving 94
 Transmitting PC Numbers 98
User Style 41, 116
 Copying 123
 Deleting 122
 Saving 121

V

Variation 35, 46
V-LINK 143
Volume 17
 Metronome 33
 Microphone 18
 Overall 17

X

XG lite 168



602.00.0081

RES 464-05 Printed in Italy 06-05 KR105 – OM/E

Free Manuals Download Website

<http://myh66.com>

<http://usermanuals.us>

<http://www.somanuals.com>

<http://www.4manuals.cc>

<http://www.manual-lib.com>

<http://www.404manual.com>

<http://www.luxmanual.com>

<http://aubethermostatmanual.com>

Golf course search by state

<http://golfingnear.com>

Email search by domain

<http://emailbydomain.com>

Auto manuals search

<http://auto.somanuals.com>

TV manuals search

<http://tv.somanuals.com>