

**MIDI KEYBOARD
CONTROLLER****PCR-30****PCR-50****PCR-80****Owner's Manual
Bedienungsanleitung
Mode d'emploi
Manuale d'uso
Manual del usuario**



Thank you for purchasing the PCR-30/50/80 USB MIDI controller.

Before using this unit, carefully read the sections entitled: "USING THE UNIT SAFELY" and "IMPORTANT NOTES" (pp. 2-4). These sections provide important information concerning the proper operation of the unit. Additionally, in order to feel assured that you have gained a good grasp of every feature provided by your new unit, Owner's manual should be read in its entirety. The manual should be saved and kept on hand as a convenient reference.







USING THE UNIT SAFELY

INSTRUCTIONS FOR THE PREVENTION OF FIRE, ELECTRIC SHOCK, OR INJURY TO PERSONS

About  WARNING and  CAUTION Notices







 WARNING	Used for instructions intended to alert the user to the risk of death or severe injury should the unit be used improperly.
 CAUTION	Used for instructions intended to alert the user to the risk of injury or material damage should the unit be used improperly. * Material damage refers to damage or other adverse effects caused with respect to the home and all its furnishings, as well to domestic animals or pets.

About the Symbols





	The  symbol alerts the user to important instructions or warnings. The specific meaning of the symbol is determined by the design contained within the triangle. In the case of the symbol at left, it is used for general cautions, warnings, or alerts to danger.
	The  symbol alerts the user to items that must never be carried out (are forbidden). The specific thing that must not be done is indicated by the design contained within the circle. In the case of the symbol at left, it means that the unit must never be disassembled.
	The  symbol alerts the user to things that must be carried out. The specific thing that must be done is indicated by the design contained within the circle. In the case of the symbol at left, it means that the power-cord plug must be unplugged from the outlet.

ALWAYS OBSERVE THE FOLLOWING





WARNING

- Before using this unit, make sure to read the instructions below, and the Owner's Manual. 
- Do not open (or modify in any way) the unit or its AC adaptor. 
- Do not attempt to repair the unit, or replace parts within it (except when this manual provides specific instructions directing you to do so). Refer all servicing to your retailer, the nearest EDIROL/Roland Service Center, or an authorized EDIROL/Roland distributor, as listed on the "Information" page. 
- Never use or store the unit in places that are:
 - Subject to temperature extremes (e.g., direct sunlight in an enclosed vehicle, near a heating duct, on top of heat-generating equipment); or are 
 - Damp (e.g., baths, washrooms, on wet floors); or are 
 - Humid; or are
 - Exposed to rain; or are
 - Dusty; or are
 - Subject to high levels of vibration.
- Make sure you always have the unit placed so it is level and sure to remain stable. Never place it on stands that could wobble, or on inclined surfaces. 









WARNING

- Be sure to use only the AC adaptor supplied with the unit. Also, make sure the line voltage at the installation matches the input voltage specified on the AC adaptor's body. Other AC adaptors may use a different polarity, or be designed for a different voltage, so their use could result in damage, malfunction, or electric shock. 
- Do not excessively twist or bend the power cord, nor place heavy objects on it. Doing so can damage the cord, producing severed elements and short circuits. Damaged cords are fire and shock hazards! 
- Do not allow any objects (e.g., flammable material, coins, pins); or liquids of any kind (water, soft drinks, etc.) to penetrate the unit. 
- Immediately turn the power off, remove the AC adaptor from the outlet, and request servicing by your retailer, the nearest EDIROL/Roland Service Center, or an authorized EDIROL/Roland distributor, as listed on the "Information" page when:
 - The AC adaptor or the power-supply cord has been damaged; or
 - If smoke or unusual odor occurs
 - Objects have fallen into, or liquid has been spilled onto the unit; or
 - The unit has been exposed to rain (or otherwise has become wet); or
 - The unit does not appear to operate normally or exhibits a marked change in performance.

⚠ WARNING

- In households with small children, an adult should provide supervision until the child is capable of following all the rules essential for the safe operation of the unit. 
- Protect the unit from strong impact. (Do not drop it!) 
- Do not force the unit's power-supply cord to share an outlet with an unreasonable number of other devices. Be especially careful when using extension cords—the total power used by all devices you have connected to the extension cord's outlet must never exceed the power rating (watts/amperes) for the extension cord. Excessive loads can cause the insulation on the cord to heat up and eventually melt through. 
- Before using the unit in a foreign country, consult with your retailer, the nearest Roland Service Center, or an authorized Roland distributor, as listed on the "Information" page. 
- DO NOT play a CD-ROM disc on a conventional audio CD player. The resulting sound may be of a level that could cause permanent hearing loss. Damage to speakers or other system components may result. 

⚠ CAUTION

- The unit and the AC adaptor should be located so their location or position does not interfere with their proper ventilation. 
- Always grasp only the output plug or the body of the AC adaptor when plugging into, or unplugging from, this unit or an outlet. 
- At regular intervals, you should unplug the AC adaptor and clean it by using a dry cloth to wipe all dust and other accumulations away from its prongs. Also, disconnect the power plug from the power outlet whenever the unit is to remain unused for an extended period of time. Any accumulation of dust between the power plug and the power outlet can result in poor insulation and lead to fire. 
- Try to prevent cords and cables from becoming entangled. Also, all cords and cables should be placed so they are out of the reach of children. 
- Never climb on top of, nor place heavy objects on the unit. 
- Never handle the AC adaptor body, or its output plugs, with wet hands when plugging into, or unplugging from, an outlet or this unit. 
- Before moving the unit, disconnect the AC adaptor and all cords coming from external devices. 
- Before cleaning the unit, turn off the power and unplug the AC adaptor from the outlet. 
- Whenever you suspect the possibility of lightning in your area, disconnect the AC adaptor from the outlet. 

IMPORTANT NOTES

In addition to the items listed under “USING THE UNIT SAFELY” on page 2 -3, please read and observe the following:

Power Supply

- Do not use this unit on the same power circuit with any device that will generate line noise (such as an electric motor or variable lighting system).
- The AC adaptor will begin to generate heat after long hours of consecutive use. This is normal, and is not a cause for concern.
- Before connecting this unit to other devices, turn off the power to all units. This will help prevent malfunctions and/or damage to speakers or other devices.

Placement

- This device may interfere with radio and television reception. Do not use this device in the vicinity of such receivers.
- Noise may be produced if wireless communications devices, such as cell phones, are operated in the vicinity of this unit. Such noise could occur when receiving or initiating a call, or while conversing. Should you experience such problems, you should relocate such wireless devices so they are at a greater distance from this unit, or switch them off.
- Do not expose the unit to direct sunlight, place it near devices that radiate heat, leave it inside an enclosed vehicle, or otherwise subject it to temperature extremes. Excessive heat can deform or discolor the unit.
- When moved from one location to another where the temperature and/or humidity is very different, water droplets (condensation) may form inside the unit. Damage or malfunction may result if you attempt to use the unit in this condition. Therefore, before using the unit, you must allow it to stand for several hours, until the condensation has completely evaporated.
- Do not allow objects to remain on top of the keyboard. This can be the cause of malfunction, such as keys ceasing to produce sound.

Handling CD-ROMs

- Avoid touching or scratching the shiny underside (encoded surface) of the disc. Damaged or dirty CD-ROM discs may not be read properly. Keep your discs clean using a commercially available CD cleaner.

Maintenance

- For everyday cleaning wipe the unit with a soft, dry cloth or one that has been slightly dampened with water. To remove stubborn dirt, use a cloth impregnated with a mild, non-abrasive detergent. Afterwards, be sure to wipe the unit thoroughly with a soft, dry cloth.
- Never use benzine, thinners, alcohol or solvents of any kind, to avoid the possibility of discoloration and/or deformation.

Additional Precautions

- Please be aware that the contents of memory can be irretrievably lost as a result of a malfunction, or the improper operation of the unit. To protect yourself against the risk of losing important data, we recommend that you periodically save a backup copy of important data you have stored in the unit's memory in another MIDI device (e.g., a sequencer).
- Unfortunately, it may be impossible to restore the contents of data that was stored in another MIDI device (e.g., a sequencer) once it has been lost. Roland Corporation assumes no liability concerning such loss of data.
- Use a reasonable amount of care when using the unit's buttons, sliders, or other controls; and when using its jacks and connectors. Rough handling can lead to malfunctions.
- When connecting / disconnecting all cables, grasp the connector itself—never pull on the cable. This way you will avoid causing shorts, or damage to the cable's internal elements.
- To avoid disturbing your neighbors, try to keep the unit's volume at reasonable levels (especially when it is late at night).
- When you need to transport the unit, package it in the box (including padding) that it came in, if possible. Otherwise, you will need to use equivalent packaging materials.
- Use only the specified expression pedal (EV-5; sold separately). By connecting any other expression pedals, you risk causing malfunction and/or damage to the unit.

Contents

Contents of the package.....9

Names of things and what they do10

Setup 13

English

Installing & Setting Up the Driver (Windows)14

Driver Installation..... 14

Windows XP users..... 14

Windows 2000 users..... 18

Windows Me/98 users..... 21

Settings 23

MIDI input and output destinations..... 23

Installing & Setting Up the Driver (Macintosh)25

Mac OS 9/8 users..... 25

Installing the driver 25

Setting the driver..... 26

FreeMIDI settings..... 29

Mac OS X Users 31

Installing the driver 31

Setting the driver..... 32

Deutsch

Installieren und Einrichten des Treibers (Windows).....33

Treiberinstallation..... 33

Windows XP-Anwender 33

Windows 2000-Anwender 38

Windows Me/98-Anwender 42

Einstellungen 44

Installieren und Einrichten des Treibers (Macintosh).....46

Mac OS 9/8-Benutzer 46

Mac OS X-Benutzer..... 52

Français

Installation et configuration du pilote (Windows)	55
Installation du pilote.....	55
Windows XP	55
Windows 2000	59
Windows Me/98	62
Paramètres.....	64
Installation et configuration du pilote (Macintosh)	66
Utilisateurs Mac OS 9/8.....	66
Utilisateurs Mac OS X.....	71

Italiano

Installazione e configurazione del driver (Windows)	74
Installazione del driver	74
Utenti Windows XP	74
Utenti Windows 2000	78
Utenti Windows Me/98	81
Impostazioni	83
Installazione e configurazione del driver (Macintosh)	85
Utenti Mac OS 9/8	85
Utenti Mac OS X.....	91

Español

Instalación y configuración del controlador (Windows).....	94
Instalación del controlador	94
Usuarios de Windows XP	94
Usuarios de Windows 2000	98
Usuarios de Windows Me/98	101
Configuración.....	103
Instalación y configuración del controlador (Macintosh).....	105
Usuarios de Mac OS 9/8	105
Usuarios de Mac OS X.....	110

Operation	113
Connection and MIDI data flow	114
When using MIDI connections.....	114
When using a USB connection	115
Basic operation.....	116
How to switch modes.....	116
PLAY mode.....	117
Controllers you can operate	117
MIDI Channel mode (MIDI CH).....	118
Program Change mode (PROGRAM CHANGE).....	119
Bank mode (BANK)	120
Memory mode (MEMORY)	121
Snapshot mode (SNAPSHOT)	122
Panic mode (PANIC)	123
Edit mode (EDIT).....	125
Controller settings.....	126
NOTE ASSIGN	127
AFTERTOUCH ASSIGN.....	129
CONTROL CHANGE ASSIGN	132
PROGRAM CHANGE ASSIGN	135
RPN/NRPN ASSIGN.....	138
SYS EX. ASSIGN	140
TEMPO ASSIGN	146
NO ASSIGN.....	146
ASSIGN COPY	147
SAVE.....	148
OMNI.....	149
PROTECT	150
BULK.....	151
Receive mode.....	151
Transmit mode	153
SYSTEM.....	154
Setting method A	155
Setting method B.....	155
Setting method C.....	155
Setting method D	156
Setting method E.....	156
Setting method F	156

Appendices	157
Convenient functions.....	158
Setting the input mode.....	158
Specifying the button mode	158
Specifying the port.....	159
Sys Ex. ASSIGN items	160
Specifying the checksum.....	160
Specifying the location of the data	161
Inputting channel/block data	162
V-LINK mode	163
Memory sets	164
GM2 set (MEMORY: 0).....	164
MCR-8 MODE 3(SONAR 2) SET	165
MCR-8 MODE 4(Cubase 5/SX) SET	166
H-COMPATIBLE (ProTools LE, Digital Performer) SET (MEMORY: 9).....	167
GS SET	167
XG SET.....	169
Troubleshooting	170
Problems related to the USB driver.....	170
Deleting the driver	173
MIDI implementation	174
Main specifications	179
INDEX	180

- * Microsoft and Windows are registered trademarks of Microsoft Corporation.
- * Windows® is known officially as: “Microsoft® Windows® operating system”.
- * Screen shots in this documents are reprinted with permission from Microsoft Corporation.
- * Apple and Macintosh are registered trademark of Apple Computer, Inc.
- * MacOS is a trademark of Apple Computer, Inc.
- * All product names mentioned in this document are trademarks or registered trademarks of their respective owners.
- * OMS is a registered trademark of Opcode Systems, Inc.
- * FreeMIDI is a trademark of Mark of the Unicorn, Inc.

Contents of the package

The PCR-30/50/80 includes the following items. When you open the package, first make sure that all items are included. If any are missing, contact the dealer where you purchased the PCR-30/50/80.

●MIDI Keyboard Controller

PCR-30/50/80



**This figure is the PCR-30.*

●AC adaptor

This is the only AC adaptor you should use with the PCR-30/50/80. Do not use any AC adaptor other than the supplied one, since doing so may cause malfunction.

●USB cable

Use this to connect the USB connector of your computer with the USB connector of the PCR-30/50/80. For details on connections and driver installation, refer to **Setup** (p. 13).

** Please use only the included USB cable. If you require a replacement due to loss or damage, please contact a "EDIROL/Roland Service Center" listed in the "Information" section at the end of this manual.*

●CD-ROM

This contains drivers and editors for use with the PCR-30/50/80.

●Template sheets (two sheets)

One of these templates lists the messages that are assigned to the knobs and sliders (controllers) by GM2 memory (memory no. 0). A blank sheet is also included for you to make a note of your own controller settings.

●Owner's Manual

This is the manual you are reading. Please keep it on hand for reference.

Names of things and what they do

Panel

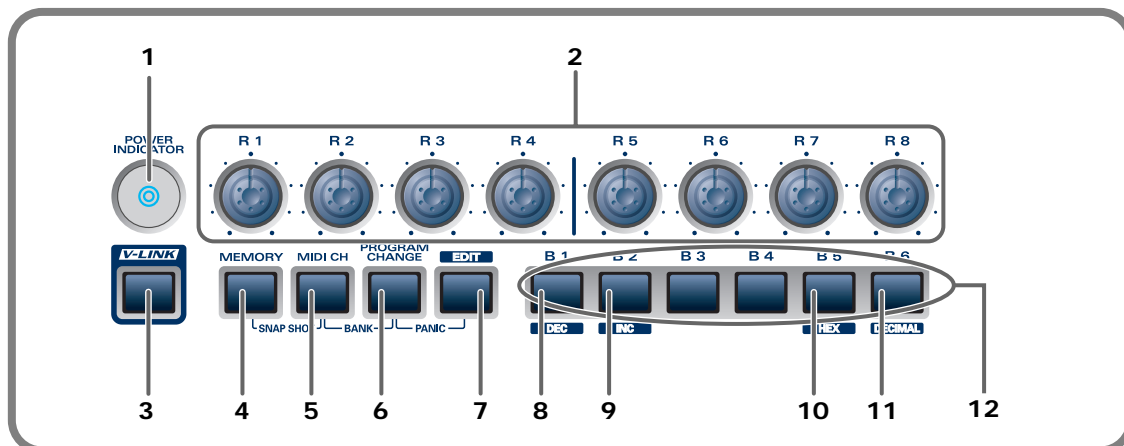

- 1. Power Indicator**
Lights when the power is on.
- 2. Controllers [R1]–[R8]**
You can assign MIDI messages to these controllers.
- 3. V-LINK Button**
Press the V-LINK button to enter V-LINK mode (p. 163). When V-LINK mode is on, the V-LINK button will light.
V-LINK
V-LINK (**V-LINK**) is a function that lets you play music and images. By using this with a V-LINK compatible video device, you can enjoy various video effects that are linked to your performance.
- 4. MEMORY Button**
Accesses memories that are stored within the PCR-30/50/80.
- 5. MIDI CH Button**
Specifies the transmission channel (“current channel”) for the keyboard and bender.
- 6. PROGRAM CHANGE Button**
Transmits program change messages on the current channel.
- 7. EDIT Button**
Used to assign MIDI messages to the controllers.
- 8. DEC Button**
Decreases the value of a setting by one (except in PLAY mode (p. 116)).
- 9. INC Button**
Increases the value of a setting by one (except in PLAY mode (p. 116)).
- 10. HEX Button**
When not in PLAY mode, sets the input mode to hexadecimal (HEX input mode).

11. DECIMAL Button

When not in PLAY mode, sets the input mode to decimal (DECIMAL input mode).

12. Controllers [B1]–[B6]

You can assign MIDI messages to these controllers.

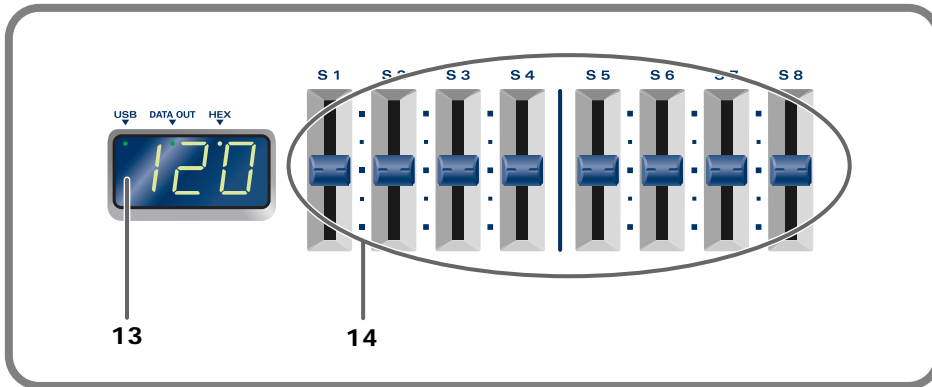

13. Display

Indicates the current status and various other information.

USB	Lights if the PCR-30/50/80 is connected to your computer via USB.
DATA OUT	This will blink when MIDI messages are transmitted via USB or MIDI OUT.
HEX	Lights when the value shown in the display is hexadecimal.

14. Controllers [S1]–[S8]

You can assign MIDI messages to these controllers.

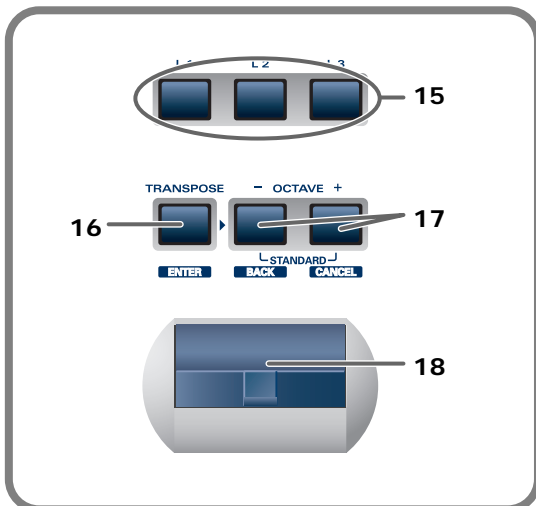

15. Controllers [L1]–[L3]

You can assign MIDI messages to these controllers.

16. TRANSPOSE/ENTER Button

Use [TRANSPOSE] + [OCTAVE +/-] to transpose the pitch of the keyboard in semitone steps. Also, in any mode except PLAY mode, it functions as the [ENTER] button, which you need to press to confirm the settings you've made.

17. OCTAVE +/-

Press [OCTAVE +/-] to shift the pitch of the keyboard up or down in steps of an octave. When not in PLAY mode, use these buttons to return to the previous setting item (the [BACK] button) or to cancel the setting and return to PLAY mode (the [CANCEL] button).

18. BENDER Lever

This lever can be used to modify the pitch or apply vibrato.

Rear Panel

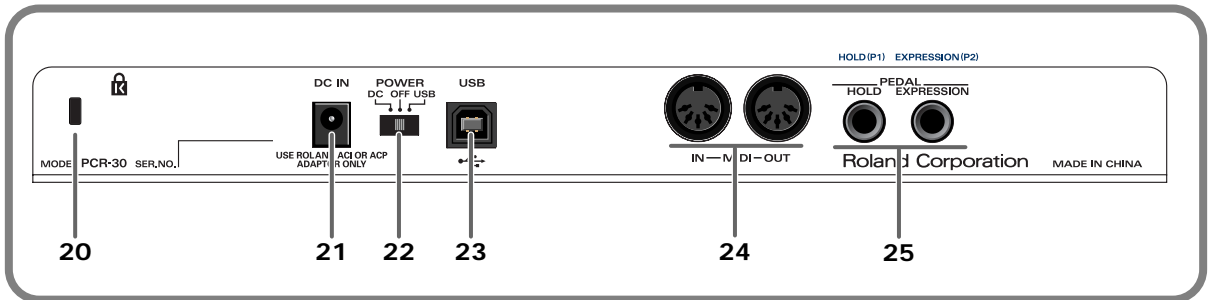

20. Security Slot () [PCR-30/50]

A commercially available security lock can be attached here.

<http://www.kensington.com/>

21. AC adaptor jack

Connect the include AC adaptor to this jack. Insert the plug firmly so it won't get unplugged accidentally.

22. Power switch

DC	Power on using the AC adaptor
OFF	Power is off
USB *1	Power on using a USB cable (when not using the AC adaptor)

*1 Bus power (USB)

BUS power can be used when the PCR-30/50/80 is connected to your computer via a USB cable. In this case, the power will be supplied from your computer via the USB cable. To use the PCR-30/50/80 with bus power, set the power switch to **USB**.

** For some computers, the PCR-30/50/80 may not operate if bus power is used. In this case, use the included AC adaptor.*

23. USB connector

Use this when connecting the PCR-30/50/80 to your computer via a USB cable.

24. MIDI IN/OUT connectors

These can be connected to the MIDI connectors of other MIDI devices to transmit and receive MIDI messages.

25. Controller [P1] and [P2]

You can connect the appropriate type of pedals to these jacks and use them as controllers.

HOLD	Connect a pedal switch to this jack and use it as a Hold pedal.
EXPRESSION	Connect an expression pedal to this jack and use it to control tone or volume in real time.

You can also assign MIDI messages to these controllers as desired.

Setup

This section explains how to install the drivers needed for connecting the PCR-30/50/80 to a computer, and make the necessary settings.

English

- Installing & Setting Up the Driver (Windows) (p. 14)**
- Installing & Setting Up the Driver (Macintosh) (p. 25)**

Deutsch

- Installieren und Einrichten des Treibers (Windows) (p. 33)**
- Installieren und Einrichten des Treibers (Macintosh) (p. 46)**

Français

- Installation et configuration du pilote (Windows) (p. 55)**
- Installation et configuration du pilote (Macintosh) (p. 66)**

Italiano

- Installazione e configurazione del driver (Windows) (p. 74)**
- Installazione e configurazione del driver (Macintosh) (p. 85)**

Español

- Instalación y configuración del controlador (Windows) (p. 94)**
- Instalación y configuración del controlador (Macintosh) (p. 105)**

What is a driver?

A “driver” is software that transfers data between the PCR-30/50/80 and application software running on your computer, when your computer and the PCR-30/50/80 are connected by a USB cable. The driver sends data from your application to the PCR-30/50/80, and from the PCR-30/50/80 to your application.

Installing & Setting Up the Driver (Windows)

Driver Installation

The installation procedure will differ depending on your system.

Please proceed to one of the following sections, depending on the system you use.

- Windows XP users (p. 14)
- Windows 2000 users (p. 18)
- Windows Me/98 users (p. 21)

■ Windows XP users

1

With the PCR-30/50/80 disconnected, start up Windows.

Disconnect all USB cables except for a USB keyboard and USB mouse (if used).

2

Open the **System Properties** dialog box.

1. Click the Windows **Start** menu, and from the menu, select **Control Panel**.
2. In “Pick a category”, click “**Performance and Maintenance**”.
3. In “or pick a Control Panel icon”, click the **System** icon.

3

Click the **Hardware** tab, and then click [**Driver Signing**].

Open the **Driver Signing Options** dialog box.

4

Make sure that “**What action do you want Windows to take?**” is set to “**Ignore**”.

If it is set to “**Ignore**”, simply click [**OK**].

If it is not set to “**Ignore**”, make a note of the current setting (“**Warn**” or “**Block**”). Then change the setting to “**Ignore**” and click [**OK**].

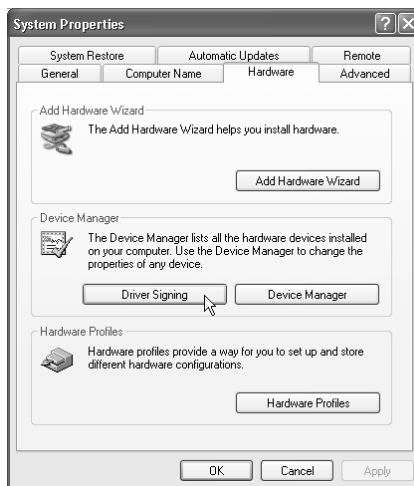

NOTE

If you are using Windows XP Professional, you must log on using a user name with an administrative account type (e.g., Administrator). For details on user accounts, please consult the system administrator of your computer.

MEMO

Depending on how your system is set up, the **System** icon may be displayed directly in the **Control Panel** (the Classic display). In this case, double-click the **System** icon.

MEMO

If you changed “**What action do you want Windows to take?**” in **step 4**, you must restore the previous setting after you have installed the driver.

5 Click **[OK]** to close the **System Properties** dialog box.

6 Exit all currently running software (applications).
Also close any open windows. If you are using virus checking or similar software, be sure to exit it as well.

7 Prepare the CD-ROM.
Insert the CD-ROM into the CD-ROM drive of your computer.

8 Click the Windows **start** button. From the menu that appears, select **“Run...”**.
Open the **“Run...”** dialog box.

9 In the dialog box that appears, input the following into the **“Open”** field, and click **[OK]**.

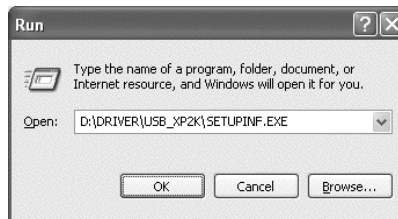

D:\Driver\USB_XP2K\SETUPINF.EXE

* The drive name **“D:”** may be different for your system. Specify the drive name of your CD-ROM drive.

10 The **SetupInf** dialog box will appear.

You are now ready to install the driver.

11 Use the **USB cable** to connect the **PCR-30/50/80** to your **computer**.

1. With the power switch turned **OFF**, connect the **AC adaptor** to the **PCR-30/50/80**.
2. Connect the **AC adaptor** to an electrical outlet.
3. Use the **USB cable** to connect the **PCR-30/50/80** to your **computer**.

12 Set the PCR-30/50/80's **power switch** to the **ON** position.

Near the task bar, your computer will indicate **“Found New Hardware”**. Please wait.

MEMO

Once the connections have been completed, turn on power to your various devices in the order specified. By turning on devices in the wrong order, you risk causing malfunction and/or damage to speakers and other devices.

MEMO

This unit is equipped with a protection circuit. A brief interval (a few seconds) after power up is required before the unit will operate normally.

13 The **Found New Hardware Wizard** will appear.

Make sure that the screen indicates “**EDIROL PCR**”, select “**Install from a list or specific location (Advanced)**”, and click **[Next]**.

14 The screen will indicate “**Please choose your search and installation options**”.

Select “**Don’t search. I will choose the driver to install**”, and click **[Next]**.

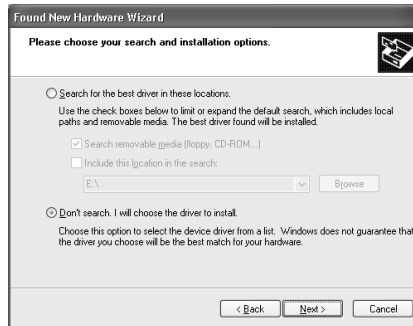

15 Make sure that the “**Model**” field indicates “**EDIROL PCR**”, and click **[Next]**. Driver installation will begin.

If the “**What action do you want Windows to take?**” setting was not set to “**Ignore**”, a “**Hardware Installation**” dialog box will appear.

If “**What action do you want Windows to take?**” is set to “**Warn**”

1. Click **[Continue Anyway]**.
2. Continue the installation.

If “**What action do you want Windows to take?**” is set to “**Block**”

1. Click **[OK]**.
2. When the “**Found New Hardware Wizard**” appears, click **[Finish]**.
3. Perform the installation as described in the “**Troubleshooting**” section on **Device Manager** shows “**?**”, “**!**”, or “**USB Composite Device**” (p. 172).

16 The **Insert Disk** dialog box will appear.

Click **[OK]**.

17 The **Files Needed** dialog box will appear.

Input the following into the “**Copy files from**” field, and click **[OK]**.

D:\Driver\USB_XP2K

* The drive name “**D:**” may be different for your system. Specify the drive name of your CD-ROM drive.



The **Insert Disk** dialog may not appear. In that case, proceed to **step 17**.

18 The **Found New Hardware Wizard** will appear.

Make sure that the display indicates “**EDIROL PCR**”, and click **[Finish]**.
Wait until “**Found New Hardware**” appears near the taskbar.

19 When driver installation has been completed, the **System Setting Change** dialog box will appear.

Click **[Yes]**. Windows will restart automatically.

If you changed “What action do you want Windows to take?”

If you changed the **What action do you want Windows to take?** setting, restore the original setting after Windows restarts.

1. If you are using **Windows XP Professional**, log on to Windows using the user name of an **administrative account** (e.g., Administrator).
2. Click the Windows **start** menu, and from the menu, select **Control Panel**.
3. In “**Pick a category**”, click “**Performance and Maintenance**”.
4. In “**or pick a Control Panel icon**”, click the **System** icon. The System Properties dialog box will appear.

* *Depending on how your system is set up, the **System** icon may be displayed directly in the **Control Panel** (the Classic display). In this case, double-click the System icon.*

5. Click the **Hardware** tab, and then click **[Driver Signing]**. The **Driver Signing Options** dialog box will appear.
6. Return the **What action do you want Windows to take?** setting to the original setting (either “Warn” or “Block”), and click **[OK]**.
7. Click **[OK]**. The **System properties** dialog box will close.

Next, you need to make the driver settings.

(→ **MIDI input and output destinations** (p. 23))

■ Windows 2000 users

- 1 With the PCR-30/50/80 disconnected, start up Windows.
Disconnect all USB cables except for a USB keyboard and USB mouse (if used).
- 2 Log on to Windows as a **user with administrative privileges** (such as Administrator).
- 3 Open the **System Properties** dialog box.
Click the Windows **Start** button, and from the menu that appears, select **Settings | Control Panel**. In **Control Panel**, double-click the **System** icon.
- 4 Click the **Hardware** tab, and then click **[Driver Signing]**.
Open the **Driver Signing Options** dialog box.
- 5 Make sure that **“File signature verification”** is set to **“Ignore”**.
If it is set to **“Ignore”**, simply click **[OK]**.
If it is not set to **“Ignore”**, make a note of the current setting (**“Warn”** or **“Block”**). Then change the setting to **“Ignore”** and click **[OK]**.
- 6 Close the **System Properties** dialog box.
Click **[OK]**.
- 7 Exit all currently running software (applications).
Also close any open windows. If you are using virus checking or similar software, be sure to exit it as well.
- 8 Prepare the CD-ROM.
Insert the CD-ROM into the CD-ROM drive of your computer.

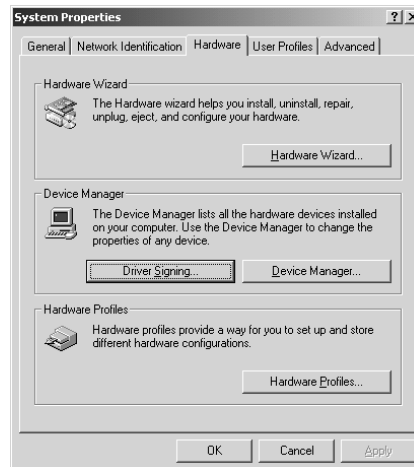

MEMO

If you changed the **“File signature verification”** setting in **step 5**, you must restore the previous setting after you have installed the driver.

9

Click the Windows **Start** button. From the menu that appears, select **“Run...”**.

Open the **“Run...”** dialog box.

10

In the dialog box that appears, input the following into the **“Open”** field, and click **[OK]**.

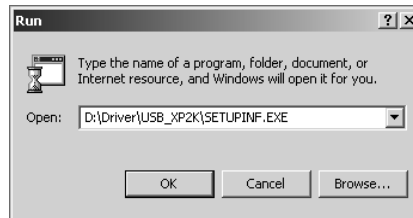

D:\Driver\USB_XP2K\SETUPINF.EXE

* The drive name **“D:”** may be different for your system. Specify the drive name of your CD-ROM drive.

11

The **SetupInf** dialog box will appear.

You are now ready to install the driver.

12

Use the **USB cable** to connect the **PCR-30/50/80** to your **computer**.

1. With the power switch turned **OFF**, connect the **AC adaptor** to the **PCR-30/50/80**.
2. Connect the **AC adaptor** to an electrical outlet.
3. Use the **USB cable** to connect the **PCR-30/50/80** to your **computer**.

13

Set the PCR-30/50/80's **power switch** to the **ON** position.

If the **“File signature verification”** setting was not set to **“Ignore”**, a **“Digital Signature Not Found”** dialog box will appear.

If “File signature verification” is set to “Warn”

1. Click **[Yes]**.
2. Continue the installation.

If “File signature verification” is set to “Block”

1. Click **[OK]**.
2. When the **“Found New Hardware Wizard”** appears, click **[Finish]**.
3. Perform the installation as described in the **“Troubleshooting”** section on **Device Manager** shows **“?”, “!”, or “USB Composite Device”** (p. 172).

MEMO

Once the connections have been completed, turn on power to your various devices in the order specified. By turning on devices in the wrong order, you risk causing malfunction and/or damage to speakers and other devices.

MEMO

This unit is equipped with a protection circuit. A brief interval (a few seconds) after power up is required before the unit will operate normally.

14 The **Insert Disk** dialog box will appear.
Click **[OK]**.

15 The **Files Needed** dialog box will appear.
Input the following into the “**Copy files from**” field, and click **[OK]**.
D:\Drivers\USB_XP2K

* The drive name “**D:**” may be different for your system. Specify the drive name of your CD-ROM drive.

16 The “**Found New Hardware Wizard**” may be displayed.
Verify that “**EDIROL PCR**” is displayed, and click **[Finish]**.

17 The **System Settings Change** dialog box may appear.
Click **[Yes]**. Windows will restart automatically.

NOTE

If the **Insert Disk** dialog box does not appear, please read **The “Insert Disk” dialog box does not appear** (p. 171).

If you changed “File signature verification”

If you changed the “File signature verification” setting, restore the original setting after Windows restarts.

1. After Windows restarts, log in to Windows as a user with **administrative privileges**, (such as Administrator).
2. In the Windows desktop, right-click the **My Computer** icon, and from the menu that appears, select **Properties**. The **System Properties** dialog box will appear.
3. Click the **Hardware** tab, and then click **[Driver signature]**. The **Driver Signing Options** dialog box will appear.
4. Return the “**File signature verification**” setting to the original setting (either “**Warn**” or “**Block**”), and click **[OK]**.
5. Click **[OK]**. The **System properties** dialog box will close.

Next, you need to make the driver settings.
(→ **MIDI input and output destinations** (p. 23))

■ Windows Me/98 users

- 1 With the PCR-30/50/80 disconnected, start up Windows.
Disconnect all USB cables except for a USB keyboard and USB mouse (if used).
- 2 Exit all currently running software (applications).
Also close any open windows. If you are using virus checking or similar software, be sure to exit it as well.
- 3 Prepare the CD-ROM.
Insert the CD-ROM into the CD-ROM drive of your computer.
- 4 Click the Windows **Start** button. From the menu that appears, select “**Run...**”.
Open the “**Run...**” dialog box.

- 5 In the dialog box that appears, input the following into the “**Open**” field, and click [OK].

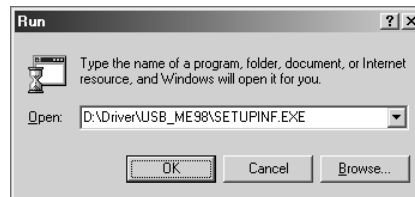

D:\Driver\USB_ME98\SETUPINF.EXE

- * The drive name “**D:**” may be different for your system. Specify the drive name of your CD-ROM drive.

- 6 The **SetupInf** dialog box will appear.
You are now ready to install the driver.
- 7 Use the **USB cable** to connect the **PCR-30/50/80** to your **computer**.
 1. With the power switch turned **OFF**, connect the **AC adaptor** to the **PCR-30/50/80**.
 2. Connect the **AC adaptor** to an electrical outlet.
 3. Use the **USB cable** to connect the **PCR-30/50/80** to your **computer**.
- 8 Set the PCR-30/50/80’s **power switch** to the **ON** position.

NOTE

Once the connections have been completed, turn on power to your various devices in the order specified. By turning on devices in the wrong order, you risk causing malfunction and/or damage to speakers and other devices.

MEMO

This unit is equipped with a protection circuit. A brief interval (a few seconds) after power up is required before the unit will operate normally.

9

The driver will be installed automatically.

10

In the dialog box, click **[OK]**.

** If a message recommends that you restart Windows, restart Windows as directed.*

Next, you need to make the driver settings.

(→ **MIDI input and output destinations** (p. 23))

Settings

■ MIDI input and output destinations

Windows XP/2000/Me users

1

Open **Control Panel**.

Click the Windows **Start** button, and from the menu that appears, select **Settings | Control Panel**.

Windows XP

Click the Windows **start** button, and from the menu that appears, select **Control Panel**.

2

Open the **Sounds and Audio Devices Properties** dialog box (or in Windows 2000/Me, **Sounds and Multimedia Properties**).

Windows XP

In “**Pick a category**”, click “**Sound, Speech, and Audio Devices**”.
Next, in “**or pick a Control Panel icon**”, click the **sounds and Audio Devices** icon.

Windows 2000/Me

In **Control Panel**, double-click the **Sounds and Multimedia** icon to open the “**Sounds and Multimedia Properties**” dialog box.

3

Click the **Audio** tab.

4

For **MIDI music playback**, click the ▼ located at the right of [**Default device**] (or in Windows 2000/Me, [**Preferred device**]), and select the MIDI device from the list that appears.

If you want to use Media Player to play a sound module connected to the PCR's MIDI OUT connector, select **EDIROL PCR MIDI OUT**.

5

Close the **Sounds and Audio Devices Properties** dialog box.
Click **OK** to complete the settings.

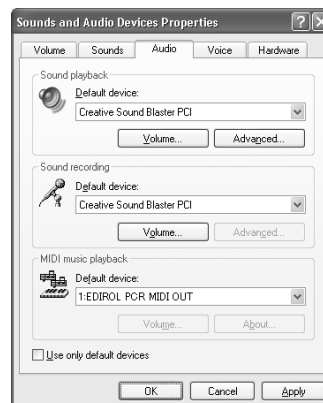

MEMO

Depending on how your system is set up, the **Sounds and Audio Devices** icon may be displayed directly in the **Control Panel** (the Classic display). In this case, double-click the **Sounds and Audio Devices** icon.

MEMO

Select the appropriate MIDI device for your system. You do not necessarily have to select **EDIROL PCR MIDI OUT**.

MEMO

For details on port, refer to “**About the ports when using a USB connection**” (p. 159).

- 6 Make MIDI device settings on your sequencer software. For details on the **MIDI OUT/IN device** to select, refer to **About the ports when using a USB connection** (p. 159).

This completes driver settings.

Windows 98 users

- 1 Open **Control Panel**.
Click the Windows **Start** button, and from the menu that appears, select **Settings | Control Panel**.
- 2 Open the **Multimedia Properties** dialog box.
In **Control Panel**, double-click the **Multimedia** icon to open the “**Multimedia Properties**” dialog box.

- 3 Click the **MIDI** tab.

- 4 Set “**MIDI output**”.
Select [**Single instrument**], and select the MIDI device from the list that appears.

If you want to use Media Player to play a sound module connected to the PCR’s MIDI OUT connector, select **EDIROL PCR MIDI OUT**.

- 5 Close the **Multimedia Properties** dialog box.
Click **OK** to complete the settings.

- 6 Make MIDI device settings on your sequencer software. For details on the **MIDI OUT/IN device** to select, refer to “**About the ports when using a USB connection**” (p. 159).

This completes driver settings.

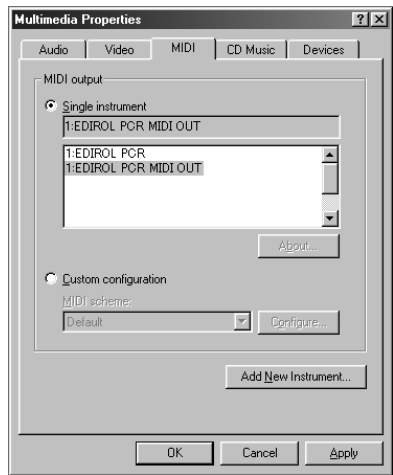

MEMO

For details on MIDI device settings, refer to the owner’s manual for the software you are using.

MEMO

Select the appropriate MIDI device for your system. You do not necessarily have to select **EDIROL PCR MIDI OUT**.

MEMO

For details on port, refer to “**About the ports when using a USB connection**” (p. 159).

MEMO

For details on MIDI device settings, refer to the owner’s manual for the software you are using.

Installing & Setting Up the Driver (Macintosh)

The installation procedure will differ depending on your system.

Please proceed to one of the following sections, depending on the system you use.

- Mac OS 9/8 users (p. 25)
- Mac OS X users (p. 31)

Mac OS 9/8 users

■ Installing the driver

Use either OMS or FreeMIDI as the MIDI driver.

The included **PCR driver** is an add-on module for using the PCR-30/50/80 with OMS or FreeMIDI.

- * *Either **OMS** or **FreeMIDI** must be installed in your Macintosh, as appropriate for the sequencer software you are using.*
- * *Disconnect the PCR-30/50/80 from the Macintosh before you perform the installation.*

MEMO

OMS can be found in the **OMS 2.3.8 E** folder within the **OMS** folder of the CD-ROM. If you would like to know more about **OMS**, refer to **OMS_2.0E_Mac.pdf** which can be found in the same folder.

If a PCR-30/50/80 is already connected to your Macintosh when you install the driver, a message like the following will appear when the Macintosh is started up. Perform the steps described below as appropriate for the message that is displayed.

If the screen indicates:

“Driver required for USB device ‘unknown device’ is not available. Search for driver on the Internet?” → click [**Cancel**].

If the screen indicates:

“Software required for using device ‘unknown device’ cannot be found. Please refer to the manual included with the device, and install the necessary software”.
→ click [**OK**].

Use the following procedure to install the PCR-30/50/80 driver.

1

Exit all currently running software (applications).

If you are using a virus checker or similar software, be sure to exit this as well.

2

Prepare the CD-ROM.

Insert the CD-ROM into the CD-ROM drive.

3 Double-click the **PCR Driver-E Installer** icon (found in the **Driver E (Mac OS 9, 8)** folder of the CD-ROM) to start up the installer.

4 Verify the **Install Location**, and click **[Install]**.

5 If a message like the following is displayed, click **[Continue]**.

The other currently running applications will exit, and installation will continue.



6 A dialog box will indicate **Installation completed**. Click **[Restart]** to restart your Macintosh.

■ Setting the driver

OMS settings

1 Use the **USB cable** to connect the **PCR-30/50/80** to your **computer**.

1. With the power switch turned **OFF**, connect the **AC adaptor** to the **PCR-30/50/80**.
2. Connect the **AC adaptor** to an electrical outlet.
3. Use the **USB cable** to connect the **PCR-30/50/80** to your **computer**.

2 Set the PCR-30/50/80's **power switch** to the **ON** position.

3 From the CD-ROM, drag the **Driver E (Mac OS 9, 8) - OMS Setting** folder to the hard disk of your Macintosh to copy it.



4 In the **Opcode-OMS Application** folder where you installed OMS, double-click **OMS Setup** to start it up.



MEMO

Once the connections have been completed, turn on power to your various devices in the order specified. By turning on devices in the wrong order, you risk causing malfunction and/or damage to speakers and other devices.

MEMO

This unit is equipped with a protection circuit. A brief interval (a few seconds) after power up is required before the unit will operate normally.

5

If a dialog box like the one shown here appears, click **[Turn It Off]**. A confirmation dialog box will then appear, so click **[OK]**.

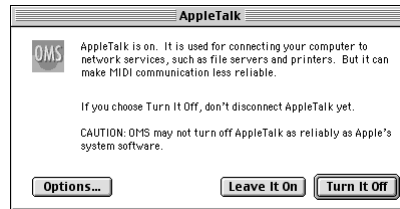

MEMO

We recommend that you turn off **AppleTalk**, by selecting **Chooser** from the Apple menu.

6

The **Create a New Studio Setup** dialog box will appear. Click **[Cancel]**. If you accidentally clicked **[OK]**, click **[Cancel]** in the next screen.



7

Choose **"Open"** from the **File** menu.

From the **Setting** folder that you copied in **step 3**, select the **PCR** file, and click **[Open]**. A screen like the one shown here will appear.

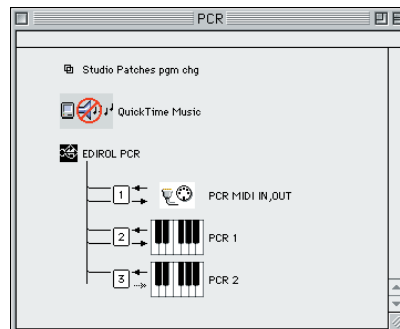

8

From the **Edit** menu, select **OMS MIDI Setup**.

In the **OMS MIDI Setup** dialog box that appears, check **Run MIDI in background**, and click **[OK]**.

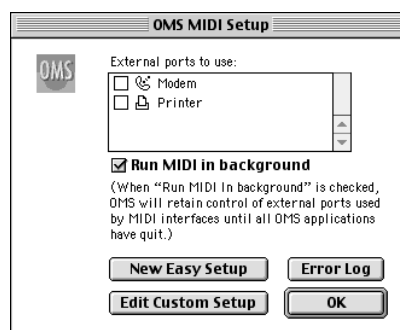

9

From the **File** menu, choose **Make Current**.

If you are unable to select **Make Current**, it has already been applied, and you may continue to the next step.

A diamond mark (◊) indicate in the settings are enabled.

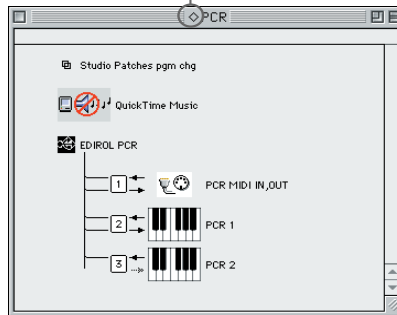

10

Verify that MIDI transmission and reception can be performed correctly. From the **Studio** menu, choose **Test Studio**.

11

Try playing the keyboard of the PCR-30/50/80. If the arrow beside number 2 or 3 in the diagram at right blinks, the settings have been made correctly.

When you move the mouse cursor near the MIDI connector icon, the cursor will change to a ♪ shape. If a MIDI sound module is connected to the PCR-30/50/80's MIDI OUT connector, click the MIDI connector icon shown in the diagram at the right. If you hear sound, the settings have been made correctly.

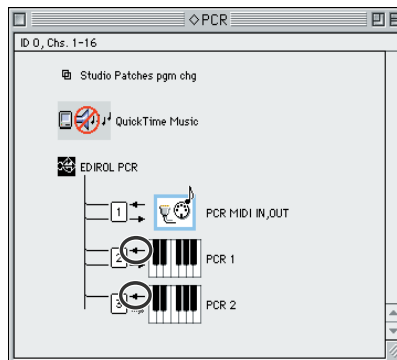

MEMO

For details on port, refer to “**About the ports when using a USB connection**” (p. 159).

MEMO

For details on connecting a MIDI sound module, refer to the owner's manual for your MIDI sound module.

12

Exit **OMS Setup**.

From the **File** menu, choose **[Exit]**. If the **AppleTalk confirmation** dialog box appears, click **[OK]** to close the dialog box.

13

Make MIDI device settings on your sequencer software. For details on the **MIDI OUT/IN device** to select, refer to “**About the ports when using a USB connection**” (p. 159).

MEMO

For details on MIDI device settings, refer to the owner's manual for the software you are using.

This completes the series of steps needed to connect the PCR-30/50/80 to the Macintosh, install the MIDI driver, and make the driver settings.

■ FreeMIDI settings

- 1 Use the **USB cable** to connect the **PCR-30/50/80** to your **computer**.
 1. With the power switch turned **OFF**, connect the **AC adaptor** to the **PCR-30/50/80**.
 2. Connect the **AC adaptor** to an electrical outlet.
 3. Use the **USB cable** to connect the **PCR-30/50/80** to your **computer**.
- 2 Set the PCR-30/50/80's **power switch** to the **ON** position.
- 3 From the CD-ROM, copy the **Driver E (Mac OS 9, 8) – FreeMIDI Setting** folder onto the hard disk of your Macintosh.
- 4 Open the **FreeMIDI Applications** folder from the location into which you installed FreeMIDI, and double-click the **FreeMIDI Setup** icon to start it up.
- 5 The first time you start up, use the following procedure.
 1. A dialog box saying “**Welcome to FreeMIDI!**” will appear. Click **[Continue]**.
 2. When the **FreeMIDI Preferences** dialog box appear. Click **[Cancel]**.
 3. The **About Quick Setup** dialog box will appear. Click **[Cancel]**.
- 6 From the **File** menu, choose **Open**.
- 7 Select **PCR** from the **FreeMIDI Setting** folder you copied in **step 3**, and click **[Open]**.
- 8 Verify that MIDI transmission and reception occur correctly. From the **MIDI** menu, choose **Check Connections**.

MEMO

Once the connections have been completed, turn on power to your various devices in the order specified. By turning on devices in the wrong order, you risk causing malfunction and/or damage to speakers and other devices.

MEMO

This unit is equipped with a protection circuit. A brief interval (a few seconds) after power up is required before the unit will operate normally.

MEMO

When “**OMS is installed on this computer...**” appears, click **[FreeMIDI]**.

MEMO

If you are unable to select **Open**, make settings as follows.

1. From the **File** menu, choose **FreeMIDI Preference**.
2. Uncheck “**Use OMS when available.**”
3. Close FreeMIDI.
4. Return to step 4 and continue the procedure.

9

Try playing the keyboard of the PCR-30/50/80. If the number 2 or 3 in the diagram at right blinks, the settings have been made correctly.

If a MIDI sound module is connected to the PCR-30/50/80's MIDI OUT connector, click the MIDI connector icon shown in the diagram at the right. If you hear sound, the settings have been made correctly.

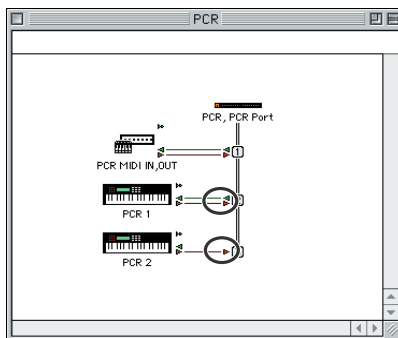

10

Once again choose the **MIDI** menu command **Check Connections** to end the test.

11

From the **File** menu, choose **Quit** to exit **FreeMIDI Setup**.

12

Make MIDI device settings on your sequencer software. For details on the **MIDI OUT/IN device** to select, refer to “**About the ports when using a USB connection**” (p. 159).

This completes the series of steps needed to connect the PCR-30/50/80 to the Macintosh, install the MIDI driver, and make the driver settings.

MEMO

For details on port, refer to “**About the ports when using a USB connection**” (p. 159).

MEMO

For details on connecting a MIDI sound module, refer to the owner's manual for your MIDI sound module.

MEMO

For details on MIDI device settings, refer to the owner's manual for the software you are using.

Mac OS X Users

■ Installing the driver

- 1** Disconnect all USB cables other than those for your keyboard and mouse, and restart your Macintosh.
- 2** Prepare the CD-ROM.
Insert the CD-ROM into the CD-ROM drive of your computer.
- 3** In the **Driver (Mac OS X)** folder of the CD-ROM, double-click **PCRUSBDriver.pkg**.
In Mac OS X v10.1.5, click the lock symbol for authentication.
- 4** In the **authentication** dialog box, input the password and click **[OK]**.
- 5** The display will indicate **“Welcome to EDIROL PCR USB Driver installation”**.
Click **[Continue]**.
- 6** The display will indicate **“Important message”**.
Read the contents and click **[Continue]**.
- 7** The display will indicate **“Select the location for installation”**.
Click the drive in which the operating system is installed to select it, and then click **[Continue]**.
- 8** The display will indicate **“Easy installation”**.
Click **Install** or **Upgrade**.
- 9** The display will indicate **“When you install this software, you must restart your computer after the installation is complete”**.
Click **[Continue installation]**.
- 10** The display will indicate **“The software was successfully installed”**.
Click **[Restart]** to restart your computer.

Cautions when using the PCR

Before you use your sequencer software, please note the following points.

- * *Connect the PCR-30/50/80 to your computer via a USB cable before you start up your sequencer or other software.*
- * *Do not disconnect the USB cable from the PCR-30/50/80 while your sequencer or other software is running.*
- * *Disconnect the USB cable from the PCR-30/50/80 only after you have quit your sequencer or other software.*
- * *Leave the Sleep function of your Macintosh turned off.*
- * *The PCR-30/50/80 will not work in the Classic environment of Mac OS X. Use the PCR when the Classic environment is not running.*

■ **Setting the driver**

1

Use the **USB cable** to connect the **PCR-30/50/80** to your **computer**.

1. With the power switch turned **OFF**, connect the **AC adaptor** to the **PCR-30/50/80**.
2. Connect the **AC adaptor** to an electrical outlet.
3. Use the **USB cable** to connect the **PCR-30/50/80** to your **computer**.

2

Set the PCR-30/50/80's **power switch** to the **ON** position.

3

Make MIDI device settings on your sequencer software. For details on the **MIDI OUT/IN device** to select, refer to "**About the ports when using a USB connection**" (p. 159).

This completes the series of steps needed to connect the PCR-30/50/80 to the Macintosh, install the MIDI driver, and make the driver settings.

MEMO

For details on MIDI device settings, refer to the owner's manual for the software you are using.

Installieren und Einrichten des Treibers (Windows)

Treiberinstallation

Die Vorgehensweise bei der Installation hängt von Ihrem System ab. Bitte lesen Sie abhängig von dem von Ihnen verwendeten System in einem der folgenden Abschnitte weiter.

- Windows XP-Anwender (S. 33)
- Windows 2000-Anwender..... (S. 38)
- Windows Me/98-Anwender (S. 42)

■ Windows XP-Anwender

1

Starten Sie Windows, wobei das PCR-30/50/80 angesteckt ist.

Stecken Sie alle USB-Kabel außer der USB-Tastatur und der USB-Maus aus (falls vorhanden).

2

Öffnen Sie das Dialogfeld **Systemeigenschaften**.

1. Klicken Sie auf die Windows-Schaltfläche **[Start]** und wählen Sie im daraufhin angezeigten Menü **Systemsteuerung**.
2. Klicken Sie in **“Wählen Sie eine Kategorie”** auf **“Leistung und Wartung”**.
3. Klicken Sie in **“oder wählen Sie ein Systemsteuerungssymbol”** auf das Symbol **System**.



Wenn Sie Windows XP Professional verwenden, müssen Sie sich mit einem Benutzernamen vom Typ Administrationskonto (zum Beispiel Administrator) anmelden. Einzelheiten zu Benutzerkonten erfahren Sie vom Systemadministrator Ihres Computers.



Abhängig von der Konfiguration Ihres Systems kann es vorkommen, dass das Symbol **System** nicht sofort in der **Systemsteuerung** (in der klassischen Anzeige) angezeigt wird. Doppelklicken Sie in diesem Fall auf das **System**-Symbol.

3 Klicken Sie auf die Registerkarte **Hardware** und klicken Sie anschließend auf **[Treibersignierung]**.

Öffnen Sie das Dialogfeld **Treibersignaturoptionen**.

4 Prüfen Sie, ob **“Wie soll Windows vorgehen?”** auf **“Ignorieren”** eingestellt ist.

Wenn **“Ignorieren”** eingestellt ist, klicken Sie einfach auf **[OK]**.

Wenn **“Ignorieren”** nicht eingestellt ist, notieren Sie sich die aktuelle Einstellung (**“Warnen”** oder **“Sperren”**). Anschließend ändern Sie die Einstellung auf **“Ignorieren”** und klicken auf **[OK]**.

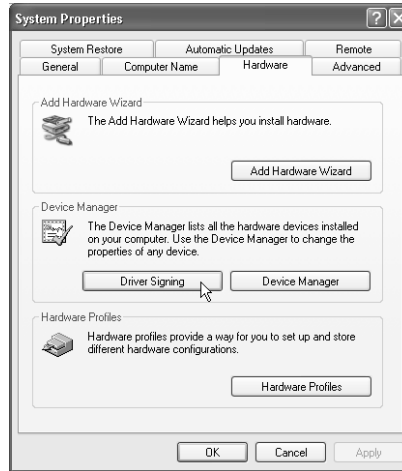

5 Klicken Sie auf **[OK]**, um das Dialogfeld **Systemeigenschaften** zu schließen.

6 Beenden Sie alle aktuell ausgeführten Programme (Anwendungen).

Schließen Sie außerdem alle noch geöffneten Programmfenster. Wenn Sie ein Virenschutzprogramm oder ähnliche Software verwenden, müssen Sie diese ebenfalls beenden.

7 Halten Sie die CD-ROM bereit.

Legen Sie die CD-ROM in das CD-ROM-Laufwerk Ihres Computers ein.

8 Klicken Sie auf die Windows-Schaltfläche **Start**. Wählen Sie im daraufhin angezeigten Menü die Option **“Ausführen...”**.

Öffnen Sie das Dialogfeld **Ausführen...**

9 Geben Sie im angezeigten Dialogfeld Folgendes in das Feld **“Öffnen”** ein und klicken Sie auf **[OK]**.

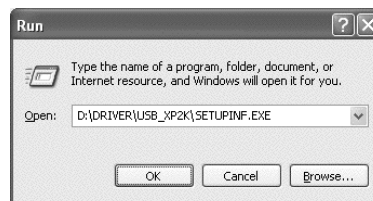

D:\Driver\USB_XP2K\SETUPINF.EXE

* Der Laufwerknamen **“D:”** kann auf Ihrem System anders lauten. Geben Sie statt dessen den Laufwerknamen Ihres CD-ROM-Laufwerks an.

MEMO

Wenn Sie **“Wie soll Windows vorgehen?”** in **Schritt 4** geändert haben, müssen Sie die vorherigen Einstellungen wieder herstellen, nachdem Sie den Treiber installiert haben.

10 Das Dialogfeld **SetupInf** wird angezeigt.
Jetzt kann der Treiber installiert werden.

11 Verwenden Sie das **USB-Kabel**, um das **PCR-30/50/80** mit Ihrem **Computer** zu verbinden.

1. Verbinden Sie bei **ausgeschaltetem** Netzschalter den **Wechselstromadapter** mit dem **PCR-30/50/80**.
2. Verbinden Sie den **Wechselstromadapter** mit einer elektrischen Steckdose.
3. Verwenden Sie das **USB-Kabel**, um das **PCR-30/50/80** mit Ihrem **Computer** zu verbinden.

12 Bringen Sie den **Netzschalter** des PCR-30/50/80 in die Position **ON**.

Der Computer zeigt neben der Task-Leiste folgende Meldung an: **“Neue Hardware gefunden”**. Bitte warten Sie.

13 Der **Assistent für das Suchen neuer Hardware** erscheint.

Prüfen Sie, ob der Bildschirm **“EDIROL PCR”** anzeigt, wählen Sie **“Software von einer Liste oder bestimmten Quelle installieren (für fortgeschrittene Benutzer)”** und klicken Sie auf **[Weiter]**.

14 Im Bildschirm wird folgende Meldung angezeigt: **“Wählen Sie die Such- und Installationsoptionen”**.
Wählen Sie **“Nicht suchen, sondern den zu installierenden Treiber selbst wählen”**, und klicken Sie auf **[Weiter]**.



Nachdem die Anschlüsse fertig gestellt wurden, schalten Sie die verschiedenen Geräte in der angegebenen Reihenfolge ein. Wenn Sie die Geräte in der falschen Reihenfolge einschalten, besteht die Gefahr von Fehlfunktionen und/oder Schäden an Lautsprechern und anderen Geräten.



Dieses Gerät ist mit einem Schutzschaltkreis ausgestattet. Nach dem Einschalten benötigt das Gerät eine kurze Zeitspanne (einige Sekunden), bis es den normalen Betrieb aufnimmt.

- 15** Prüfen Sie, ob das Feld **“Modell” “EDIROL PCR”** anzeigt und klicken Sie auf **[Weiter]**. Die Installation des Treibers beginnt.

Wenn die Einstellung für **“Wie soll Windows vorgehen?”** nicht **“Ignorieren”** lautet, wird das Dialogfeld **“Hardware-Installation”** angezeigt.

Wenn für Wie soll Windows vorgehen? “Warnen” aktiviert wurde,

1. klicken Sie auf **[Trotzdem fortsetzen]**.
2. Setzen Sie die Installation fort.

Wenn für “Wie soll Windows vorgehen?” “Sperrern” aktiviert wurde,

1. Klicken Sie auf **[OK]**.
2. Wenn der Assistent für **das Suchen neuer Hardware** erscheint, klicken Sie auf **[Beenden]**.
3. Führen Sie die Installation aus, wie im Abschnitt **“Fehlerbehebung”** in **Device Manager shows “?”, “I”, or “USB Composite Device”** (S. 172) beschrieben.

- 16** Das Dialogfeld **Diskette einlegen** wird angezeigt.
Klicken Sie auf **[OK]**.

- 17** Das Dialogfeld **Benötigte Dateien** wird angezeigt.

Geben Sie im angezeigten Dialogfeld Folgendes in das Feld **“Dateien kopieren von”** ein und klicken Sie auf **[OK]**.

D:\Driver\USB_XP2K

** Der Laufwerknamen **“D:”** kann auf Ihrem System anders lauten. Geben Sie statt dessen den Laufwerknamen Ihres CD-ROM-Laufwerks an.*

- 18** Der **Assistent für das Suchen neuer Hardware** erscheint.

Prüfen Sie, ob **EDIROL PCR** angezeigt wird, und klicken Sie auf **[Beenden]**.
Warten Sie, bis die Meldung **“Neue Hardware gefunden”** in der Nähe der Task-Leiste angezeigt wird.

- 19** Nachdem der Treiber installiert wurde, wird das Dialogfeld **Geänderte Systemeinstellungen** angezeigt.

Klicken Sie auf **[Ja]**. Windows startet anschließend automatisch neu.



Das Dialogfeld **Diskette einlegen** wird eventuell nicht angezeigt. Arbeiten Sie in diesem Fall mit **Schritt 17** weiter.

Wenn Sie die Einstellung für “Wie soll Windows vorgehen?” geändert haben

Wenn Sie die Einstellung “**Wie soll Windows vorgehen?**” geändert haben, müssen Sie die ursprüngliche Einstellung nach dem Neustart von Windows wiederherstellen.

1. Wenn Sie **Windows XP Professional** verwenden, melden Sie sich in Windows mit dem Benutzernamen eines **Administrationskontos** an (z.B. Administrator).
2. Klicken Sie auf die Windows-Schaltfläche **[Start]** und wählen Sie im daraufhin angezeigten Menü **Systemsteuerung**.
3. Klicken Sie in “**Wählen Sie eine Kategorie**” auf “**Leistung und Wartung**”.
4. Klicken Sie in “**oder wählen Sie ein Systemsteuerungssymbol**” auf das Symbol **System**. Daraufhin werden die Systemeigenschaften angezeigt.

** Abhängig von der Konfiguration Ihres Systems kann es vorkommen, dass das Symbol **System** nicht sofort in der **Systemsteuerung** (in der klassischen Anzeige) angezeigt wird. Doppelklicken Sie in diesem Fall auf das Symbol **System**.*

5. Klicken Sie auf die Registerkarte **Hardware** und klicken Sie anschließend auf **[Treibersignierung]**. Daraufhin werden die **Treibersignaturoptionen** angezeigt.
6. Stellen Sie die ursprünglichen Einstellungen für “**Wie soll Windows vorgehen?**” wieder her (entweder “Warnen” oder “Sperrern”) und klicken Sie auf “**OK**”.
7. Klicken Sie auf **[OK]**. Das Dialogfeld **Systemeigenschaften** wird geschlossen.

Als nächstes nehmen Sie die Einstellungen für den Treiber vor.
(→ **Eingabe- und Ausgabeziele für MIDI** (S. 44))

■ Windows 2000-Anwender

- 1** Starten Sie Windows, wobei das PCR-30/50/80 angesteckt ist.
Stecken Sie alle USB-Kabel außer der USB-Tastatur und der USB-Maus aus (falls vorhanden).
- 2** Melden Sie sich in Windows als **Benutzer mit Administratorrechten** an (z.B. als Administrator).
- 3** Öffnen Sie das Dialogfeld **Systemeigenschaften**.
Klicken Sie in Windows auf **Start** und wählen Sie im daraufhin angezeigten Menü **Einstellungen - Systemsteuerung**. Doppelklicken Sie in der **Systemsteuerung** auf das **System**-Symbol.
- 4** Klicken Sie auf die Registerkarte **Hardware** und klicken Sie anschließend auf **[Treibersignierung]**.
Öffnen Sie das Dialogfeld **Treibersignaturoptionen**.
- 5** Stellen Sie sicher, dass für **“Dateisignaturverifizierung”** **“Ignorieren”** aktiviert ist.
Wenn **“Ignorieren”** eingestellt ist, klicken Sie einfach auf **[OK]**.
Wenn **“Ignorieren”** nicht eingestellt ist, notieren Sie sich die aktuelle Einstellung (**“Warnen”** oder **“Sperren”**). Anschließend ändern Sie die Einstellung auf **“Ignorieren”** und klicken auf **[OK]**.
- 6** Schließen Sie das Dialogfeld **Systemeigenschaften**.
Klicken Sie auf **[OK]**.
- 7** Beenden Sie alle aktuell ausgeführten Programme (Anwendungen).
Schließen Sie außerdem alle noch geöffneten Programmfenster. Wenn Sie ein Virenschutzprogramm oder ähnliche Software verwenden, müssen Sie diese ebenfalls beenden.

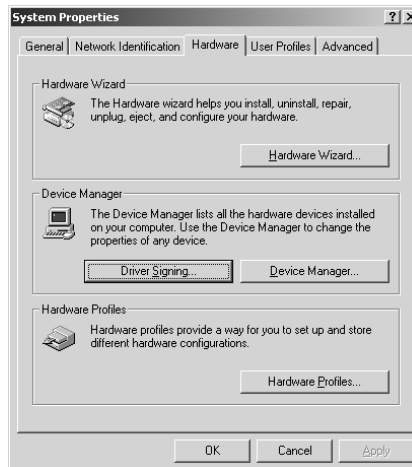

MEMO

Wenn Sie die Einstellung **“Dateisignaturverifizierung”** in **Schritt 5** geändert haben, müssen Sie die früheren Einstellungen wieder herstellen, nachdem Sie den Treiber installiert haben.

8

Halten Sie die CD-ROM bereit.

Legen Sie die CD-ROM in das CD-ROM-Laufwerk Ihres Computers ein.

9

Klicken Sie auf die Windows-Schaltfläche **Start**. Wählen Sie im daraufhin angezeigten Menü die Option **“Ausführen...”**

Öffnen Sie das Dialogfeld **Ausführen....**

10

Geben Sie im angezeigten Dialogfeld Folgendes in das Feld **“Öffnen”** ein und klicken Sie auf **[OK]**.

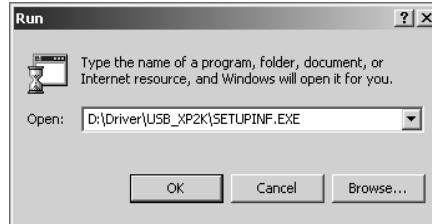

D:\Driver\USB_XP2K\SETUPINF.EXE

* Der Laufwerknamen **“D:”** kann auf Ihrem System anders lauten. Geben Sie statt dessen den Laufwerknamen Ihres CD-ROM-Laufwerks an.

11

Das Dialogfeld **SetupInf** wird angezeigt.

Jetzt kann der Treiber installiert werden.

12

Verwenden Sie das **USB-Kabel**, um das **PCR-30/50/80** mit Ihrem **Computer** zu verbinden.

1. Verbinden Sie bei **ausgeschaltetem** Netzschalter den **Wechselstromadapter** mit dem **PCR-30/50/80**.
2. Verbinden Sie den **Wechselstromadapter** mit einer elektrischen Steckdose.
3. Verwenden Sie das **USB-Kabel**, um das **PCR-30/50/80** mit Ihrem **Computer** zu verbinden.

13

Bringen Sie den **Netzschalter** des PCR-30/50/80 in die Position **ON**.

MEMO

Nachdem die Anschlüsse fertig gestellt wurden, schalten Sie die verschiedenen Geräte in der angegebenen Reihenfolge ein. Wenn Sie die Geräte in der falschen Reihenfolge einschalten, besteht die Gefahr von Fehlfunktionen und/oder Schäden an Lautsprechern und anderen Geräten.

MEMO

Dieses Gerät ist mit einem Schutzschaltkreis ausgestattet. Nach dem Einschalten benötigt das Gerät eine kurze Zeitspanne (einige Sekunden), bis es den normalen Betrieb aufnimmt.

Wenn in für **“Dateisignaturverifizierung”** nicht **“Ignorieren”** aktiviert wurde, erscheint die Meldung **“Digitalsignatur nicht gefunden”**.

Wenn für “Dateisignaturverifizierung” “Warnen” aktiviert ist,

1. Klicken Sie auf **[Ja]**.
2. Setzen Sie die Installation fort.

Wenn für “Dateisignaturverifizierung” “Sperrern” aktiviert ist,

1. Klicken Sie auf **[OK]**.
2. Wenn der Assistent für **das Suchen neuer Hardware** erscheint, klicken Sie auf **[Beenden]**.
3. Führen Sie die Installation aus, wie im Abschnitt **“Fehlerbehebung”** in **Device Manager shows “?”, “I”, or “USB Composite Device”** (S. 172) beschrieben.

14 Das Dialogfeld **Diskette einlegen** wird angezeigt.
Klicken Sie auf **[OK]**.

15 Das Dialogfeld **Benötigte Dateien** wird angezeigt.
Geben Sie im angezeigten Dialogfeld Folgendes in das Feld **“Dateien kopieren von”** ein und klicken Sie auf **[OK]**.

D:\Drivers\USB_XP2K

** Der Laufwerknamen **“D:”** kann auf Ihrem System anders lauten. Geben Sie statt dessen den Laufwerknamen Ihres CD-ROM-Laufwerks an.*

16 Das Dialogfeld **“Neue Hardware gefunden”** wird eventuell angezeigt.
Prüfen Sie, ob **“EDIROL PCR”** angezeigt wird und klicken Sie auf **[Beenden]**.

17 Möglicherweise wird das Dialogfeld **Geänderte Systemeinstellungen** angezeigt.
Klicken Sie auf **[Ja]**. Windows startet anschließend automatisch neu.



Wenn das Dialogfeld **Diskette einlegen** nicht angezeigt wird, lesen Sie bitte **The “Insert Disk” dialog box does not appear** (S. 171)

Wenn Sie “Dateisignaturverifizierung” geändert haben

Wenn Sie die Einstellung für “Dateisignaturverifizierung” geändert haben, müssen Sie die ursprüngliche Einstellung nach dem Neustart von Windows wiederherstellen.

1. Nachdem Windows neu gestartet ist, melden Sie sich als Benutzer mit **Administratorrechten** an (z.B. als Administrator).
2. Klicken Sie auf dem Windows Desktop mit der rechten Maustaste auf das Symbol **Arbeitsplatz** und wählen Sie im daraufhin angezeigten Menü **Eigenschaften**. Daraufhin wird das Dialogfeld **Systemeigenschaften** angezeigt.
3. Klicken Sie auf die Registerkarte **Hardware** und klicken Sie anschließend auf **[Treibersignierung]**. Daraufhin werden die **Treibersignaturoptionen** angezeigt.
4. Stellen Sie die ursprünglichen Einstellungen für “Dateisignaturverifizierung” wieder her (“Warnen” oder “Sperrern”) und klicken Sie auf **[OK]**.
5. Klicken Sie auf **[OK]**. Das Dialogfeld **Systemeigenschaften** wird geschlossen.

Als nächstes nehmen Sie die Einstellungen für den Treiber vor.
(→ **Eingabe- und Ausgabeziele für MIDI** (S. 44))

■ Windows Me/98-Anwender

- 1 Starten Sie Windows, wobei das PCR-30/50/80 angesteckt ist.
Stecken Sie alle USB-Kabel außer der USB-Tastatur und der USB-Maus aus (falls vorhanden).
- 2 Beenden Sie alle aktuell ausgeführten Programme (Anwendungen).
Schließen Sie außerdem alle noch geöffneten Programmfenster. Wenn Sie ein Virenschutzprogramm oder ähnliche Software verwenden, müssen Sie diese ebenfalls beenden.
- 3 Halten Sie die CD-ROM bereit.
Legen Sie die CD-ROM in das CD-ROM-Laufwerk Ihres Computers ein.
- 4 Klicken Sie auf die Windows-Schaltfläche **Start**. Wählen Sie im daraufhin angezeigten Menü die Option **“Ausführen...”**.
Öffnen Sie das Dialogfeld **Ausführen....**

- 5 Geben Sie im angezeigten Dialogfeld Folgendes in das Feld **“Öffnen”** ein und klicken Sie auf **[OK]**.

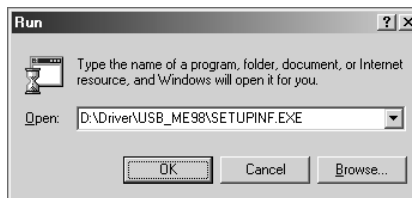

D:\Driver\USB_ME98\SETUPINF.EXE

** Der Laufwerknamen **“D:”** kann auf Ihrem System anders lauten. Geben Sie statt dessen den Laufwerknamen Ihres CD-ROM-Laufwerks an.*

- 6 Das Dialogfeld **SetupInf** wird angezeigt.
Jetzt kann der Treiber installiert werden.

7 Verwenden Sie das **USB-Kabel**, um das **PCR-30/50/80** mit Ihrem **Computer** zu verbinden.

1. Verbinden Sie bei **ausgeschaltetem** Netzschalter den **Wechselstromadapter** mit dem **PCR-30/50/80**.
2. Verbinden Sie den **Wechselstromadapter** mit einer elektrischen Steckdose.
3. Verwenden Sie das **USB-Kabel**, um das **PCR-30/50/80** mit Ihrem **Computer** zu verbinden.

8 Bringen Sie den **Netzschalter** des PCR-30/50/80 in die Position **ON**.

9 Der Treiber wird automatisch installiert werden.

10 Klicken Sie im Dialogfeld auf [OK].

* *Wenn Sie eine Meldung erhalten, die Ihnen empfiehlt, Windows neu zu starten, starten Sie Windows neu.*

Als nächstes nehmen Sie die Einstellungen für den Treiber vor.
 (→ **Eingabe- und Ausgabeziele für MIDI** (S. 44))

NOTE

Nachdem die Anschlüsse fertig gestellt wurden, schalten Sie die verschiedenen Geräte in der angegebenen Reihenfolge ein. Wenn Sie die Geräte in der falschen Reihenfolge einschalten, besteht die Gefahr von Fehlfunktionen und/oder Schäden an Lautsprechern und anderen Geräten.

MEMO

Dieses Gerät ist mit einem Schutzschaltkreis ausgestattet. Nach dem Einschalten benötigt das Gerät eine kurze Zeitspanne (einige Sekunden), bis es den normalen Betrieb aufnimmt.

Einstellungen

■ Eingabe- und Ausgabeziele für MIDI

Windows XP/2000/Me-Anwender

1

Öffnen Sie die **Systemsteuerung**.

Klicken Sie in Windows auf **Start** und wählen Sie im daraufhin angezeigten Menü **Einstellungen - Systemsteuerung**.

Windows XP

Klicken Sie in Windows auf **Start** und wählen Sie im daraufhin angezeigten Menü **Systemsteuerung**.

2

Öffnen Sie das Dialogfeld **Eigenschaften von Sounds und Audiogeräte** (bzw. in Windows 2000/Me **Eigenschaften von Sounds und Multimedia**).

Windows XP

Klicken Sie in **“Wählen Sie eine Kategorie”** auf **“Sounds, Sprachein-/ausgabe und Audiogeräte”**. Klicken Sie danach in **“oder wählen Sie ein Systemsteuerungssymbol”** auf das Symbol **Sounds und Audiogeräte**.

Windows 2000/Me

Doppelklicken Sie in der **Systemsteuerung** auf das Symbol **[Sounds und Multimedia]**, um das Dialogfeld **Eigenschaften für Sounds und Multimedia** zu öffnen.

3

Klicken Sie auf die Registerkarte **Audio**.

4

Klicken Sie bei **MIDI-Musikwiedergabe** auf das ▼, das sich rechts von **[Standardgerät]** befindet (bzw. in Windows 2000/Me rechts von **[Bevorzugtes Gerät]**) und wählen Sie das MIDI-Gerät aus der angezeigten Liste aus.

Wenn Sie den Media Player verwenden möchten, um ein Soundmodul abzuspielen, das mit dem MIDI-OUT-Stecker des PCR verbunden ist, wählen Sie **EDIROL PCR MIDI OUT**.

5

Schließen Sie das Dialogfeld **Eigenschaften von Sounds und Audiogeräte**. Klicken Sie auf **[OK]**, um die Konfiguration abzuschließen.



MEMO

Abhängig von der Konfiguration Ihres Systems kann es vorkommen, dass das Symbol **Sounds und Audiogeräte** nicht sofort in der **Systemsteuerung** (in der klassischen Anzeige) angezeigt wird. In diesem Fall doppelklicken Sie auf das Symbol **Sounds und Audiogeräte**.

MEMO

Wählen Sie das entsprechende MIDI-Gerät für Ihr System. Sie müssen nicht unbedingt **EDIROL PCR MIDI OUT** auswählen.

MEMO

Einzelheiten zu den Anschlüssen erhalten Sie unter **“About the ports when using a USB connection”** (S. 159).

- 6** Nehmen Sie die MIDI-Geräteeinstellungen auf Ihrer Sequenzer-Software vor. Wenn Sie weitere Informationen zu dem **MIDI OUT/IN-Gerät** erhalten möchten, lesen Sie bitte **About the ports when using a USB connection** (S. 159).

Damit sind die Treibereinstellungen abgeschlossen.



Detaillierte Informationen zu den MIDI-Geräteeinstellungen finden Sie im Handbuch Ihrer Software.

Windows 98-Anwender

- 1** Öffnen Sie die **Systemsteuerung**.
Klicken Sie in Windows auf **Start** und wählen Sie im daraufhin angezeigten Menü **Einstellungen - Systemsteuerung**.
- 2** Öffnen Sie das Dialogfeld **Eigenschaften für Multimedia**.
Doppelklicken Sie in der **Systemsteuerung** auf das Symbol **[Multimedia]**, um das Dialogfeld **Eigenschaften für Multimedia** zu öffnen.

- 3** Konfigurieren Sie die **"MIDI-Ausgabe"**.
Wählen Sie **[Einzelnes Instrument]** und wählen Sie das MIDI-Gerät aus der angezeigten Liste.

Wenn Sie den Media Player verwenden möchten, um ein Soundmodul abzuspielen, das mit dem MIDI-OUT-Stecker des PCR verbunden ist, wählen Sie **EDIROL PCR MIDI OUT**.

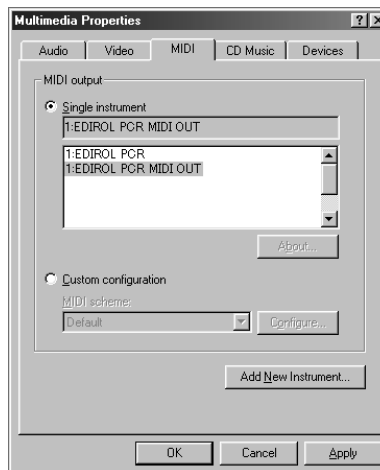

- 4** Schließen Sie das Dialogfeld **Eigenschaften für Multimedia**.
Klicken Sie auf **[OK]**, um die Konfiguration abzuschließen.
- 5** Nehmen Sie die MIDI-Geräteeinstellungen auf Ihrer Sequenzer-Software vor. Wenn Sie weitere Informationen zu dem **MIDI OUT/IN-Gerät** erhalten möchten, lesen Sie bitte **"About the ports when using a USB connection"** (S. 159).

Damit sind die Treibereinstellungen abgeschlossen.



Wählen Sie das entsprechende MIDI-Gerät für Ihr System. Sie müssen nicht unbedingt **EDIROL PCR MIDI OUT** auswählen.



Einzelheiten zu dem Anschluss erhalten Sie unter **"About the ports when using a USB connection"** (S. 159).



Detaillierte Informationen zu den MIDI-Geräteeinstellungen finden Sie im Handbuch Ihrer Software.

Installieren und Einrichten des Treibers (Macintosh)

The installation procedure will differ depending on your system.

Please proceed to one of the following sections, depending on the system you use.

- Mac OS 9/8 users (S. 46)
- Mac OS X users (S. 52)

Mac OS 9/8-Benutzer

■ Installation des Treibers

Der **PCR-30/50/80 OMS-Treiber** im Lieferumfang ist ein Add-On-Modul für die Verwendung des PCR-30/50/80 mit OMS oder FreeMIDI.

- * *Entsprechend der von Ihnen verwendeten Sequenzer-Software muss auf Ihrem Macintosh entweder **OMS** oder **FreeMIDI** installiert sein.*

Installieren Sie den PCR-30/50/80-Treiber wie anschließend beschrieben.

- * *Trennen Sie das PCR-30/50/80 vom Macintosh, bevor Sie die Installation ausführen.*

Wenn das PCR-30/50/80 eingeschaltet wird, wird eine Meldung ähnlich der folgenden Meldung angezeigt, wenn der Macintosh hochgefahren wird. Gehen Sie abhängig von der angezeigten Meldung vor wie nachfolgend beschrieben.

Wenn die Meldung lautet:

“Driver required for USB device ‘unknown device’ is not available. Search for driver on the Internet?” → klicken Sie auf **“Cancel”**.

Wenn die Meldung lautet:

“Software required for using device ‘unknown device’ cannot be found. Please refer to the manual included with the device, and install the necessary software”

→ klicken Sie auf **[OK]**.



OMS befindet sich im Ordner **OMS 2.3.8 E**, der sich im Ordner **OMS** der CD-ROM befindet. Wenn Sie mehr über OMS erfahren möchten, lesen Sie bitte die Datei **OMS_2.3_Mac.pdf** (Online-Handbuch) im Ordner **OMS2.3.8E**, der sich im Ordner **OMS** der CD-ROM befindet.

- 1** Beenden Sie alle aktuell ausgeführten Programme (Anwendungen).
Wenn Sie ein Virenschutzprogramm oder ähnliche Software verwenden, müssen Sie diese ebenfalls beenden.
- 2** Halten Sie die CD-ROM bereit.
Legen Sie die CD-ROM in das CD-ROM-Laufwerk ein.
- 3** Doppelklicken Sie auf das Symbol **PCR Driver-E Installer** (das sich im Ordner **Driver E (Mac OS 9, 8) -OMS** auf der CD-ROM befindet), um das Installationsprogramm zu starten.
- 4** Prüfen Sie den **Installationsort** und klicken Sie auf **[Install]**
- 5** Falls eine Meldung wie abgebildet angezeigt wird, klicken Sie auf **[Continue]**.
Alle anderen aktuell ausgeführten Anwendungen werden anschließend beendet und die Installation wird fortgesetzt.
- 6** Ein Dialogfeld zeigt Folgendes an: **Installation completed**.
Klicken Sie auf **[Restart]** , um den Macintosh neu zu starten.

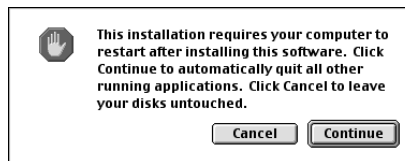

■ Einstellungen

OMS-Einstellungen

Bevor Sie die OMS-Einstellungen prüfen können, müssen Sie ein MIDI-Soundmodul mit dem MIDI OUT-Anschluss des PCR-30/50/80 verbinden.

1

Verwenden Sie das **USB-Kabel**, um das **PCR-30/50/80** mit Ihrem **Computer** zu verbinden.

1. Verbinden Sie bei **ausgeschaltetem** Netzschalter das **Wechselstromadapter** mit dem **PCR-30/50/80**.
2. Verbinden Sie das **Wechselstromadapter** mit einer elektrischen Steckdose.
3. Verwenden Sie das **USB-Kabel**, um das **PCR-30/50/80** mit Ihrem **Computer** zu verbinden.

2

Bringen Sie den **Netzschalter** des PCR-30/50/80 in die Position **ON**.

3

Ziehen Sie den Ordner **Driver E (Mac OS 9, 8) - OMS Setting** auf der CD-ROM auf die Festplatte Ihres Macintosh, um ihn zu kopieren.



4

Doppelklicken Sie im Ordner **Opcode-OMS Application**, in dem Sie OMS installiert haben, auf **OMS Setup**, um die Installation zu starten.



5

Wenn ein Dialogfeld ähnlich dem abgebildeten Dialogfeld angezeigt wird, klicken Sie auf **[Turn It Off]**. Anschließend wird ein Dialogfeld für die Bestätigung angezeigt. Klicken Sie hier auf **[OK]**.

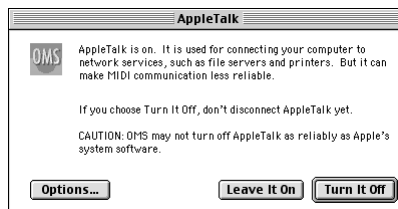

MEMO

Nachdem die Anschlüsse fertig gestellt wurden, schalten Sie die verschiedenen Geräte in der angegebenen Reihenfolge ein. Wenn Sie die Geräte in der falschen Reihenfolge einschalten, besteht die Gefahr von Fehlfunktionen und/oder Schäden an Lautsprechern und anderen Geräten.

MEMO

Vergewissern Sie sich stets, dass die Lautstärke reduziert wurde, bevor Sie den Netzschalter betätigen. Beim Einschalten wird eventuell auch dann Sound ausgegeben, wenn der Lautstärkeregler ganz zurückgestellt wurde. Das ist jedoch normal und kein Anzeichen für eine Fehlfunktion.

MEMO

Wir empfehlen Ihnen, **AppleTalk** zu deaktivieren, indem Sie im Apfelmenü den **Chooser** auswählen.

- 6** Das Dialogfeld **Create a New Studio Setup** wird angezeigt. Klicken Sie auf **[Cancel]**. Wenn Sie versehentlich auf **[OK]** geklickt haben, klicken Sie im nächsten Bildschirm auf **[Cancel]**.



- 7** Wählen Sie **“Open”** im Menü **File**. Wählen Sie im Ordner **Setting**, den Sie in **Schritt 3** kopiert haben, die Datei **PCR**, und klicken Sie auf **[Open]**. Ein Dialogfeld ähnlich dem hier gezeigten Dialogfeld wird angezeigt.

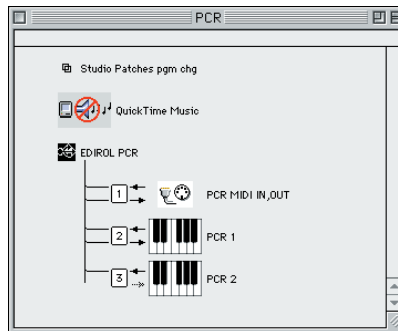

- 8** Wählen Sie im Menü **Edit** die Option **OMS MIDI Setup**. Aktivieren Sie im daraufhin angezeigten Dialogfeld **OMS MIDI Setup** die Option **Run MIDI in background** und klicken Sie auf **[OK]**.

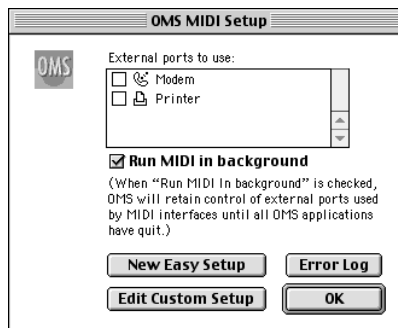

- 9** Wählen Sie im Menü **File** die Option **Make Current**. Wenn Sie die Option **Make Current** nicht auswählen können, wurde sie bereits angewendet und Sie können mit dem nächsten Schritt weiterarbeiten.

A diamond mark (◊) indicate in the settings are enabled.

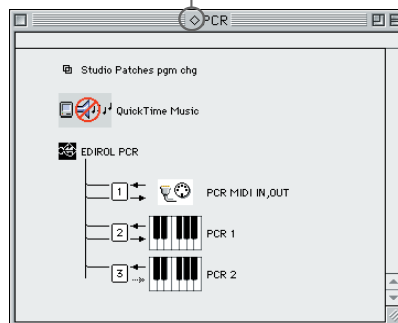

- 10** Prüfen Sie, ob die MIDI-Übertragung und der MIDI-Empfang fehlerfrei funktionieren. Wählen Sie im Menü **Studio** die Option **Test Studio**.

11

Drücken Sie die Tasten des Keyboards. Die Einstellungen wurden korrekt durchgeführt wenn der Pfeil neben Nummer 2 oder 3 im Diagramm rechts blinkt. Der Mauszeiger nimmt die Form einer Note wenn er in der Nähe des MIDI Connector Symbols gehalten wird.

Bei Anschluß eines MIDI Soundmoduls über den MIDI OUT des PCR 30/50/80 sollte bei Klicken des Midi Symbols ein Ton erklingen.

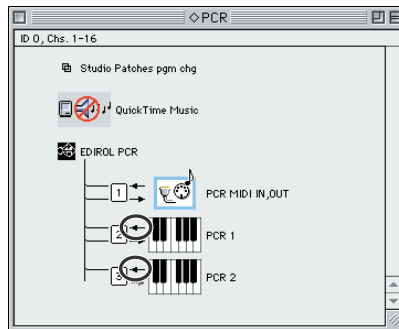

MEMO

Weitere Informationen zum Anschluss eines MIDI-Soundmoduls erhalten Sie im Benutzerhandbuch für Ihr MIDI-Soundmodul.

12

Beenden Sie **OMS Setup**.

Wählen Sie im Menü **File** die Option **[Exit]**. Klicken Sie im Dialogfeld **AppleTalk Confirmation** auf **[OK]**, um das Dialogfeld zu schließen.

Damit wurden die Schritte ausgeführt, die erforderlich sind, um das PCR-30/50/80 mit Ihrem Macintosh zu verbinden, die MIDI-Treiber zu installieren und die Treiber zu konfigurieren.

Einstellungen für FreeMIDI

- 1 Verwenden Sie das **USB-Kabel**, um das **PCR-30/50/80** mit Ihrem **Computer** zu verbinden.
 1. Verbinden Sie bei **ausgeschaltetem** Netzschalter das **Wechselstromadapter** mit dem **PCR-30/50/80**.
 2. Verbinden Sie das **Wechselstromadapter** mit einer elektrischen Steckdose.
 3. Verwenden Sie das **USB-Kabel**, um das **PCR-30/50/80** mit Ihrem **Computer** zu verbinden.
- 2 Bringen Sie den **Netzschalter** des PCR-30/50/80 in die Position **ON**.
- 3 Ziehen Sie den Ordner **Driver E (Mac OS 9, 8) - FreeMIDI Setting** auf der CD-ROM auf die Festplatte Ihres Macintosh, um ihn zu kopieren.
- 4 Öffnen Sie den Ordner **FreeMIDI Applications** an dem Ort, an dem Sie FreeMIDI installiert haben, und doppelklicken Sie auf das Symbol **FreeMIDI Setup**, um die Installation zu starten.
- 5 Wenn **“OMS is installed on this computer...”** angezeigt wird, klicken Sie auf **[FreeMIDI]**.
- 6 Wenn die Software zum ersten Mal ausgeführt wird, wird das Dialogfeld **“Welcome to FreeMIDI!”** angezeigt. Klicken Sie auf **[Continue]**.
- 7 Wenn das Dialogfeld **FreeMIDI Preferences** angezeigt wird, klicken Sie auf **[Cancel]**.
- 8 Wenn das Dialogfeld **About Quick Setup** angezeigt wird, klicken Sie auf **[Cancel]**.
- 9 Wählen Sie im Menü **File** die Option **Open**.
- 10 Wählen Sie im Ordner **FreeMIDI Setting**, den Sie in **Schritt 3** kopiert haben, die Datei **PCR**, und klicken Sie auf **[Open]**.
- 11 Prüfen Sie, ob die MIDI-Übertragung und der MIDI-Empfang fehlerfrei erfolgen. Wählen Sie im Menü **MIDI** die Option **Check Connections**.

MEMO

Nachdem die Anschlüsse fertig gestellt wurden, schalten Sie die verschiedenen Geräte in der angegebenen Reihenfolge ein. Wenn Sie die Geräte in der falschen Reihenfolge einschalten, besteht die Gefahr von Fehlfunktionen und/oder Schäden an Lautsprechern und anderen Geräten.

MEMO

Vergewissern Sie sich stets, dass die Lautstärke reduziert wurde, bevor Sie den Netzschalter betätigen. Beim Einschalten wird eventuell auch dann Sound ausgegeben, wenn der Lautstärkeregler ganz zurückgestellt wurde. Das ist jedoch normal und kein Anzeichen für eine Fehlfunktion.

- 12** Bei Anschluß eines MIDI Soundmoduls über den MIDI OUT des PCR 30/50/80 sollte bei Klicken des Midi Symbols ein Ton erklingen.

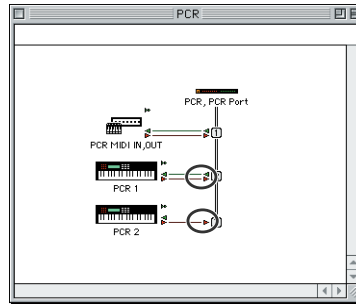

MEMO

Weitere Informationen zum Anschluss eines MIDI-Soundmoduls erhalten Sie im Benutzerhandbuch für Ihr MIDI-Soundmodul.

- 13** Wählen Sie im Menü **MIDI** erneut den Befehl **Check Connections**, um den Test zu beenden.
- 14** Wählen Sie im Menü **File** die Option **Quit**, um **FreeMIDI Setup** zu beenden.

Damit wurden die Schritte ausgeführt, die erforderlich sind, um das PCR-30/50/80 mit Ihrem Macintosh zu verbinden, die MIDI-Treiber zu installieren und die Treiber zu konfigurieren.

Mac OS X-Benutzer

■ Installation des Treibers

- 1** Stecken Sie alle USB-Kabel außer der Tastatur und der Maus aus, und starten Sie den Macintosh neu.
- 2** Halten Sie die CD-ROM bereit.
Legen Sie die CD-ROM in das CD-ROM-Laufwerk Ihres Computers ein.
- 3** Doppelklicken Sie im Ordner **Driver (Mac OS X)** auf der CD-ROM auf **PCRUSBDriver.pkg**.
Klicken Sie unter Mac OS X v10.1.5 auf das Schlüsselsymbol für die Authentifizierung.
- 4** Geben Sie in das Dialogfeld **Authentication** Ihr Kennwort ein und klicken Sie auf **[OK]**.

- 5** In der Anzeige wird **“Welcome to EDIROL PCR USB Driver installation”** angezeigt.
Klicken Sie auf **[Continue]**.
- 6** In der Anzeige erscheint die Meldung **“Important Message”**.
Lesen Sie diese Informationen und klicken Sie auf **[Continue]**.
- 7** In der Anzeige erscheint anschließend **“Select the location for installation”**.
Klicken Sie auf das Laufwerk, auf dem das Betriebssystem installiert ist, um es auszuwählen, und klicken Sie anschließend auf **[Continue]**.
- 8** In dieser Anzeige erscheint anschließend **“Easy installation”**.
Klicken Sie auf **Install** oder **Upgrade**.
- 9** In der Anzeige erscheint anschließend: **“When you install this software, you must restart your computer after the installation is complete”**
(Nach Installation ist ein Neustart erforderlich)
Klicken Sie anschließend auf **[Continue installation]**.
- 10** In der Anzeige erscheint Folgendes: **“The software was successfully installed”** (Das Programm wurde erfolgreich installiert).
Klicken Sie auf **[Restart]**, um Ihren Computer neu zu starten.

Vorsichtsmaßnahmen bei der Verwendung des PCR

Bevor Sie Ihr Sequenzerprogramm verwenden, beachten Sie bitte Folgendes.

- * *Verwenden Sie das USB-Kabel, um das PCR-30/50/80 mit Ihrem Computer zu verbinden, bevor Sie Ihren Sequenzer oder Ihre Software starten.*
- * *Trennen Sie das USB-Kabel nicht vom PCR-30/50/80, während Ihr Sequenzer oder andere Software ausgeführt wird.*
- * *Stecken Sie das USB-Kabel erst aus dem PCR-30/50/80 aus, nachdem Sie Ihren Sequenzer oder andere Software beendet haben.*
- * *Lassen Sie die Ruhezustandsfunktion Ihres Macintosh deaktiviert.*
- * *Das PCR-30/50/80 funktioniert nicht in der Classic-Umgebung von Mac OS X. Verwenden Sie das PCR, wenn die Classic-Umgebung nicht ausgeführt wird.*

■ Konfiguration des Treibers

1

Verwenden Sie das **USB-Kabel**, um das **PCR-30/50/80** mit Ihrem **Computer** zu verbinden.

1. Verbinden Sie den **Wechselstromadapter** mit dem **PCR-30/50/80** bei **AUSGESCHALTETEM** Netzschalter.
2. Verbinden Sie den **Wechselstromadapter** mit einer elektrischen Steckdose.
3. Verwenden Sie das **USB-Kabel**, um das **PCR-30/50/80** mit Ihrem **Computer** zu verbinden.

2

Bringen Sie den **Netzschalter** des **PCR-30/50/80** in die Position **ON**.

3

Nehmen Sie in Ihrem Sequenzerprogramm die Einstellungen für MIDI-Geräte vor. Nähere Informationen dazu, welches **MIDI OUT/IN - Gerät** ausgewählt werden sollte, erhalten Sie unter "**About the ports when using a USB connection**" (S. 159).

Nun haben Sie die Schritte ausgeführt, die erforderlich sind, um den **PCR-30/50/80** an den Macintosh anzuschließen, die MIDI-Treiber zu installieren und die Treiber zu konfigurieren.



Detaillierte Informationen zu den MIDI-Geräteeinstellungen erhalten Sie im Handbuch zu Ihrer Software.

Installation et configuration du pilote (Windows)

Installation du pilote

La procédure d'installation dépend de votre système d'exploitation.

Veuillez lire la section qui vous concerne.

- Windows XP..... (p. 55)
- Windows 2000..... (p. 59)
- Windows Me/98 (p. 62)

■ Windows XP

1

Le PCR-30/50/80 étant débranché, démarrez Windows.

Débranchez tous les câbles USB, à l'exception de ceux du clavier et de la souris (le cas échéant).

2

Ouvrez la boîte de dialogue **Propriétés Système**.

1. Cliquez sur le menu **Démarrer** de Windows, puis, dans le menu qui s'affiche, choisissez **Panneau de configuration**.
2. Dans "**Choisissez une catégorie**", cliquez sur "**Performances et maintenance**".
3. Dans "**ou choisissez une icône du Panneau de configuration**", cliquez sur l'icône **Système**.

3

Cliquez sur l'onglet **Matériel**, puis cliquez sur [**Signature du pilote**].

Ouvrez la boîte de dialogue **Options de signature du pilote**.

4

Vérifiez que le paramètre "**Que voulez-vous faire ?**" est défini sur "**Ignorer**".

Si ce paramètre est réglé sur "**Ignorer**", cliquez sur [**OK**].

Si elle n'est pas définie sur "**Ignorer**", notez le paramètre indiqué ("**Avertir**" ou "**Bloquer**"). Choisissez ensuite "**Ignorer**" et cliquez sur [**OK**].

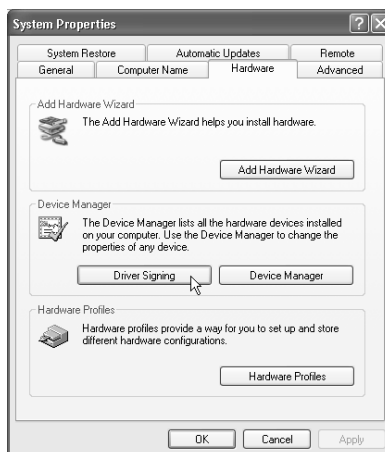

NOTE

Si vous utilisez Windows XP Professional, vous devez ouvrir une session avec un nom d'utilisateur disposant des droits d'administrateur. Pour plus de détails sur les comptes utilisateur, veuillez prendre contact avec l'administrateur système de votre ordinateur.

MEMO

Selon la configuration de votre ordinateur, l'icône **Système** s'affiche peut-être dans le **Panneau de configuration** (Vue classique). Dans ce cas, cliquez deux fois sur l'icône **Système**.

MEMO

Si vous avez modifié "**Que voulez-vous faire ?**" à l'étape 4, vous devez restaurer le réglage précédent après installation du pilote.

5 Cliquez sur **[OK]** pour fermer la boîte de dialogue **Propriétés système**.

6 Quittez tous les logiciels (applications) actifs.
Fermez également toutes les fenêtres éventuellement ouvertes. Si vous utilisez un anti-virus, quittez-le également.

7 Munissez-vous du CD-ROM.
Introduisez-le dans le lecteur de CD de votre ordinateur.

8 Cliquez sur le bouton **Démarrer** de Windows. Dans le menu qui s'affiche, sélectionnez **“Exécuter...”**.

Ouvrez la boîte de dialogue **“Exécuter...”** (voir ci-dessous).

9 Dans la boîte de dialogue qui s'affiche, tapez ce qui suit dans le champ **“Ouvrir”**, puis cliquez sur **[OK]**.

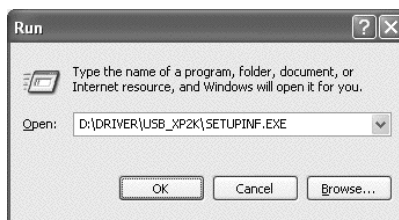

D:\Driver\USB_XP2K\SETUPINF.EXE

* La lettre du lecteur **“D:”** n'est pas forcément celle de votre ordinateur. Tapez la lettre affectée au lecteur de CD de votre ordinateur (par exemple, E: ou F:).

10 La boîte de dialogue **SetupInf** s'affiche.

Vous êtes maintenant prêt à installer le pilote.

11 Utilisez le **câble USB** pour brancher le **PCR-30/50/80** à votre **ordinateur**.

1. L'interrupteur d'alimentation sur **OFF**, branchez le **cordon secteur** sur le **PCR-30/50/80**.
2. Branchez le **cordon secteur** sur une prise électrique (secteur).
3. Utilisez le **câble USB** pour brancher le **PCR-30/50/80** à votre **ordinateur**.

12 Placez l'**interrupteur d'alimentation** du **PCR-30/50/80** sur **ON**.

Près de la barre des tâches, votre ordinateur indique **“Nouveau matériel détecté”**. Veuillez patienter.

MEMO

Une fois les connexions effectuées, mettez sous tension les différents appareils dans l'ordre spécifié. Ne pas respecter cet ordre peut entraîner des dysfonctionnements et/ou endommager les enceintes ou tout autre appareil.

MEMO

Cet appareil est équipé d'un circuit de protection. Après la mise sous tension, attendez quelques secondes avant d'utiliser l'appareil.

13 La boîte de dialogue **Assistant ajout de nouveau matériel** s'affiche.

Vérifiez que l'écran indique **EDIROL PCR**, sélectionnez **Installer à partir d'une liste ou d'un emplacement spécifique (Avancé)**, puis cliquez sur **[Suivant]**.

14 L'écran indiquera **“Veuillez choisir vos options de recherche et d'installation”**.

Sélectionnez **“Ne pas rechercher. Je vais choisir le pilote à installer”**, puis cliquez sur **[Suivant]**.

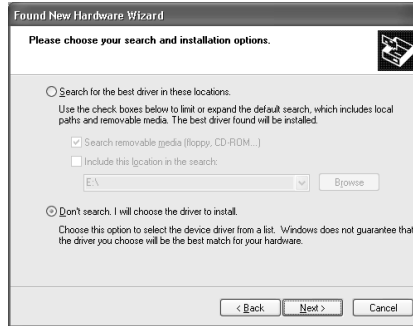

15 Vérifiez que le champ **Modèle** indique **EDIROL PCR**, puis cliquez sur **[Suivant]**. L'installation du pilote commence.

Si le paramètre **“Que voulez-vous faire ?”** n'est pas défini sur **“Ignorer”**, la boîte de dialogue **“Installation du matériel”** s'affiche.

Si “Que voulez-vous faire ?” est définie sur “Avertir”

1. Cliquez sur **[Continuer]**.
2. Poursuivez l'installation.

Si “Que voulez-vous faire ?” est définie sur “Bloc”

1. Cliquez sur **[OK]**.
2. Lorsque l'**“Assistant ajout de nouveau matériel”** s'affiche, cliquez sur **[Terminer]**.
3. Procédez à l'installation comme décrit à la section **“En cas de problème”** (voir **Device Manager shows “?”, “!”, or “USB Composite Device”** (p. 172).

16 La boîte de dialogue **Insérez le disque** s'affiche.
Cliquez sur **[OK]**.

17 La boîte de dialogue **Fichiers nécessaires** s'affiche.

Tapez ce qui suit dans le champ **“Copier les fichiers depuis”**, puis cliquez sur **[OK]**.

D:\Driver\USB_XP2K

* La lettre du lecteur **“D:”** n'est pas forcément celle de votre ordinateur. Tapez la lettre affectée au lecteur de CD de votre ordinateur (par exemple, **E:** ou **F:**).

MEMO

La boîte de dialogue **Insérez le disque** ne s'affiche pas. Dans ce cas,

18

La boîte de dialogue **Assistant ajout de nouveau matériel** s'affiche.

Vérifiez que l'écran indique **EDIROL PCR**, puis cliquez sur **[Terminer]**.

Attendez que "**Nouveau matériel détecté**" s'affiche près de la barre des tâches.

19

Une fois l'installation du pilote terminée, la boîte de dialogue **Modification des paramètres système** s'affiche.

Cliquez sur **[Oui]**. Windows redémarre automatiquement.

Si vous avez modifié "Que voulez-vous faire ?"

Si vous avez modifié "**Que voulez-vous faire ?**" restaurez le paramètre d'origine après le redémarrage de Windows.

1. Si vous utilisez **Windows XP Professional**, vous devez ouvrir une session avec un nom d'utilisateur disposant des **droits d'administrateur**.
 2. Cliquez sur le menu **Démarrer** de Windows, puis dans le menu qui s'affiche, choisissez **Panneau de configuration**.
 3. Dans "**Choisissez une catégorie**", cliquez sur "**Performances et maintenance**".
 4. Dans "**ou choisissez une icône du Panneau de configuration**", cliquez sur l'icône **Système**. La boîte de dialogue "Propriétés système" s'affiche.
- * Selon la configuration de votre ordinateur, l'icône **Système** s'affiche peut-être dans le **Panneau de configuration** (Vue classique). Dans ce cas, cliquez deux fois sur l'icône **Système**.
5. Cliquez sur l'onglet **Matériel**, puis cliquez sur **[Signature du pilote]**. La boîte de dialogue **Options de signature du pilote** s'affiche.
 6. Restaurez le paramètre "**Que voulez-vous faire ?**" ("Avertir" ou "Bloquer"), puis cliquez sur **[OK]**.
 7. Cliquez sur **[OK]**. La boîte de dialogue **Propriétés Système** se ferme.

Vous devez ensuite procéder à la configuration du pilote.
(→ **Paramètres d'entrée et de sortie MIDI** (p. 64))

■ Windows 2000

1 Le PCR-30/50/80 étant débranché, démarrez Windows.
Débranchez tous les câbles USB, à l'exception de ceux du clavier et de la souris (le cas échéant).

2 Ouvrez une session Windows en tant qu'**utilisateur doté de droits d'administration** (Administrateur, par exemple).

3 Ouvrez la boîte de dialogue **Propriétés Système**.
Cliquez sur le bouton **Démarrer** de Windows, puis dans le menu qui s'affiche, choisissez **Paramètres | Panneau de configuration**. Dans **Panneau de configuration**, cliquez deux fois sur l'icône **Système**.

4 Cliquez sur l'onglet **Matériel**, puis cliquez sur **[Signature du pilote]**.
Ouvrez la boîte de dialogue **Options de signature du pilote**.

5 Assurez-vous que l'option **"Vérification des signatures de fichiers"** est définie sur **"Ignorer"**.

Si ce paramètre est réglé sur **"Ignorer"**, cliquez sur **[OK]**.
S'il n'est pas défini sur **"Ignorer"**, notez le paramètre indiqué (**"Avertir"** ou **"Bloquer"**). Choisissez ensuite **"Ignorer"** et cliquez sur **[OK]**.

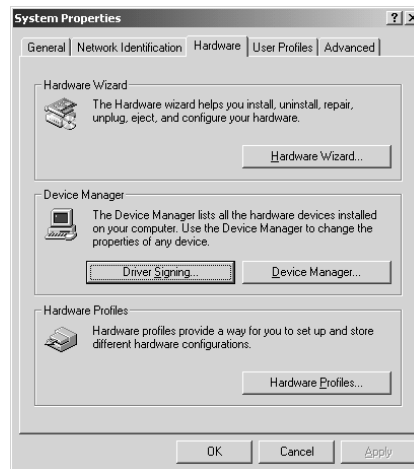

6 Fermez la boîte de dialogue **Propriétés Système**.
Cliquez sur **[OK]**.

7 Quittez tous les logiciels (applications) actifs.
Fermez également toutes les fenêtres éventuellement ouvertes. Si vous utilisez un anti-virus, quittez-le également.

8 Munissez-vous du CD-ROM.
Introduisez-le dans le lecteur de CD de votre ordinateur.

MEMO

Si vous avez modifié **Vérifier la signature des fichiers** à l'étape 5, vous devez restaurer le réglage précédent après installation du pilote.

9

Cliquez sur le bouton **Démarrer** de Windows. Dans le menu qui s'affiche, sélectionnez **"Exécuter..."**.

Ouvrez la boîte de dialogue **"Exécuter..."** (voir ci-dessous).

10

Dans la boîte de dialogue qui s'affiche, tapez ce qui suit dans le champ **"Ouvrir"**, puis cliquez sur **[OK]**.

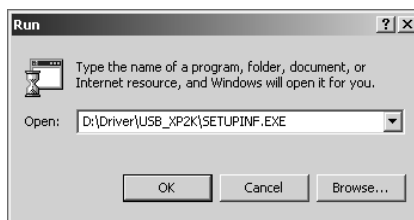

D:\Driver\USB_XP2K\SETUPINF.EXE

* La lettre du lecteur **"D:"** n'est pas forcément celle de votre ordinateur. Tapez la lettre affectée au lecteur de CD de votre ordinateur (par exemple, E: ou F:).

11

La boîte de dialogue **SetupInf** s'affiche.

Vous êtes maintenant prêt à installer le pilote.

12

Utilisez le **câble USB** pour brancher le **PCR-30/50/80** à votre **ordinateur**.

1. L'interrupteur d'alimentation sur **OFF**, branchez le **cordon secteur** sur le **PCR-30/50/80**.
2. Branchez le **cordon secteur** sur une prise électrique (secteur).
3. Utilisez le **câble USB** pour brancher le **PCR-30/50/80** à votre **ordinateur**.

13

Placez l'**interrupteur d'alimentation** du **PCR-30/50/80** sur **ON**.

MEMO

Une fois les connexions effectuées, mettez sous tension les différents appareils dans l'ordre spécifié. Ne pas respecter cet ordre peut entraîner des dysfonctionnements et/ou endommager les enceintes ou tout autre appareil.

MEMO

Cet appareil est équipé d'un circuit de protection. Après la mise sous tension, attendez quelques secondes avant d'utiliser l'appareil.

Si l'option **"Vérification de la signature des pilotes"** n'a pas été définie sur **"Ignorer"**, une boîte de dialogue **"Signature numérique introuvable"** s'affiche.

Si "Vérification des signatures des fichiers" est défini sur "Avertir"

1. Cliquez sur **[Oui]**.
2. Poursuivez l'installation.

Si "Vérification des signatures des fichiers" est définie sur "Bloquer"

1. Cliquez sur **[OK]**.
2. Lorsque l'**"Assistant ajout de nouveau matériel"** s'affiche, cliquez sur **[Terminer]**.
3. Procédez à l'installation comme décrit à la section **"En cas de problème"** (voir **Device Manager shows "?", "I", or "USB Composite Device"** (p. 172).

14 La boîte de dialogue **Insérez le disque** s'affiche.
Cliquez sur **[OK]**.

15 La boîte de dialogue **Fichiers nécessaires** s'affiche.
Tapez ce qui suit dans le champ "**Copier les fichiers depuis**", puis cliquez sur **[OK]**.

D:\Drivers\USB_XP2K

* La lettre du lecteur "**D:**" n'est pas forcément celle de votre ordinateur. Tapez la lettre affectée au lecteur de CD de votre ordinateur (par exemple, E: ou F:).

16 La boîte de dialogue **Assistant Nouveau matériel détecté** peut s'afficher.
Vérifiez que **EDIROL PCR** est affiché, puis cliquez sur **[Terminer]**.

17 La boîte de dialogue **Modification des paramètres système** peut s'afficher.
Cliquez sur **[Oui]**. Windows redémarre automatiquement.



Si la boîte de dialogue **Insérez le disque** ne s'affiche pas, lisez la section **The "Insert Disk" dialog box does not appear** (p. 171)

Si vous avez modifié l'option "Vérification de la signature des fichiers"

Si vous avez modifié "Vérification des signatures des fichiers", restaurez le paramètre original après le redémarrage de Windows.

1. Une fois Windows redémarré, ouvrez une session Windows avec des **privileges d'administration**, (par exemple, en ouvrant une session Administrateur).
2. Sur le bureau Windows, cliquez avec le bouton droit de la souris sur l'icône **Poste de travail** puis, dans le menu qui s'affiche, sélectionnez **Propriétés**. La boîte de dialogue **Propriétés Système** s'affiche.
3. Cliquez sur l'onglet **Profils matériels**, puis cliquez sur **[Signature des pilotes]**. La boîte de dialogue **Options de signature du pilote** s'affiche.
4. Restaurez l'option "**Vérification de la signature des fichiers**" à sa valeur d'origine ("**Avertir**" ou "**Bloquer**"), puis cliquez sur **[OK]**.
5. Cliquez sur **[OK]**. La boîte de dialogue **Propriétés Système** se ferme.

Vous devez ensuite procéder à la configuration du pilote.
(→ **Paramètres d'entrée et de sortie MIDI** (p. 64))

■ Windows Me/98

1

Le PCR-30/50/80 étant débranché, démarrez Windows.

Débranchez tous les câbles USB, à l'exception de ceux du clavier et de la souris (le cas échéant).

2

Quittez tous les logiciels (applications) actifs.

Fermez également toutes les fenêtres éventuellement ouvertes. Si vous utilisez un anti-virus, quittez-le également.

3

Munissez-vous du CD-ROM.

Introduisez-le dans le lecteur de CD de votre ordinateur.

4

Cliquez sur le bouton **Démarrer** de Windows. Dans le menu qui s'affiche, sélectionnez "**Exécuter...**".

Ouvrez la boîte de dialogue "**Exécuter...**" (voir ci-dessous).

5

Dans la boîte de dialogue qui s'affiche, tapez ce qui suit dans le champ "**Ouvrir**", puis cliquez sur **[OK]**.

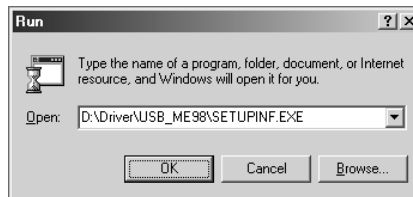

D:\Driver\USB_ME98\SETUPINF.EXE

* La lettre du lecteur "**D:**" n'est pas forcément celle de votre ordinateur. Tapez la lettre affectée au lecteur de CD de votre ordinateur (par exemple, **E:** ou **F:**).

6

La boîte de dialogue **SetupInf** s'affiche.

Vous êtes maintenant prêt à installer le pilote.

7 Utilisez le **câble USB** pour brancher le **PCR-30/50/80** à votre **ordinateur**.

1. L'interrupteur d'alimentation sur **OFF**, branchez le **cordon secteur** sur le **PCR-30/50/80**.
2. Branchez le **cordon secteur** sur une prise électrique (secteur).
3. Utilisez le **câble USB** pour brancher le **PCR-30/50/80** à votre **ordinateur**.

8 Placez l'**interrupteur d'alimentation** du PCR-30/50/80 sur **ON**.

9 Le pilote s'installe automatiquement.

10 Dans la boîte de dialogue, cliquez sur [OK].

* *Si un message vous recommande de relancer Windows, faites-le.*

Vous devez ensuite procéder à la configuration du pilote.
(→ **Paramètres d'entrée et de sortie MIDI** (p. 64))

NOTE

Une fois les connexions effectuées, mettez sous tension les différents appareils dans l'ordre spécifié. Ne pas respecter cet ordre peut entraîner des dysfonctionnements et/ou endommager les enceintes ou tout autre appareil.

MEMO

Cet appareil est équipé d'un circuit de protection. Après la mise sous tension, attendez quelques secondes avant d'utiliser l'appareil.

Paramètres

■ Paramètres d'entrée et de sortie MIDI

Windows XP/2000/Me :

1

Ouvrez le **Panneau de configuration**.

Cliquez sur le bouton **Démarrer** de Windows, puis dans le menu qui s'affiche, choisissez **Paramètres | Panneau de configuration**.

Windows XP

Cliquez sur le bouton **Démarrer** de Windows, puis dans le menu qui s'affiche, choisissez **Panneau de configuration**.

2

Ouvrez la boîte de dialogue **Propriétés sons et périphériques multimédia** (avec Windows 2000/Me, **Propriétés Son et multimédia**).

Windows XP

Dans "**Choisissez une catégorie**", cliquez sur "**Son, voix et périphériques audio**". Dans "**ou choisissez une icône du Panneau de configuration**", cliquez sur l'icône **Sons et périphériques audio**.

Windows 2000/Me

Dans le **Panneau de configuration**, cliquez deux fois sur l'icône **Sons et Multimédia** pour ouvrir la boîte de dialogue "**Propriétés de Sons et multimédia**".

3

Cliquez sur l'onglet **Audio**.

4

Pour **Lecture MIDI**, cliquez sur le ▼ situé à droite de [**Périphérique par défaut**] (avec Windows 2000/Me, [**Périphérique par défaut**]), puis sélectionnez un périphérique MIDI dans la liste qui s'affiche.

Si vous voulez utiliser Media Player pour piloter un module de sons branché au connecteur MIDI OUT du PCR, sélectionnez **EDIROL PCR MIDI OUT**.



5

Fermez la boîte de dialogue **Propriétés Son et périphériques multimédia**. Cliquez sur [**OK**] pour terminer les réglages.

MEMO

Selon la configuration de votre ordinateur, l'icône **Sons et périphériques audio** s'affiche peut-être dans le **Panneau de configuration** (Vue classique). Dans ce cas, cliquez deux fois sur l'icône **Sons et périphériques audio**.

MEMO

Sélectionnez le périphérique MIDI approprié. Vous n'êtes pas obligé de sélectionner **EDIROL PCR MIDI OUT**.

MEMO

Pour plus de détails sur cette connexion, reportez-vous à la section "**About the ports when using a USB connection**" (p. 159)

- 6** Procédez aux réglages MIDI du périphérique dans votre application (séquenceur). Pour plus de détails sur le **périphérique MIDI OUT/IN** à sélectionner, reportez-vous à la section **About the ports when using a USB connection** (p. 159).

Le paramétrage du pilote est terminé.

Windows 98

- 1** Ouvrez le **Panneau de configuration**.
Cliquez sur le bouton **Démarrer** de Windows, puis dans le menu qui s'affiche, choisissez **Paramètres | Panneau de configuration**.
- 2** Ouvrez la boîte de dialogue **Propriétés de Multimédia**.
Dans le **Panneau de configuration**, cliquez deux fois sur l'icône **Multimédia** pour ouvrir la boîte de dialogue **Propriétés de multimédia**.

- 3** Cliquez sur l'onglet **MIDI**.

- 4** Spécifiez la sortie MIDI (**MIDI output**).
Sélectionnez [**Single instrument**], puis sélectionnez le périphérique MIDI dans la liste qui s'affiche.

Si vous voulez utiliser Media Player pour piloter un module de sons branché au connecteur MIDI OUT du PCR, sélectionnez **EDIROL PCR MIDI OUT**.

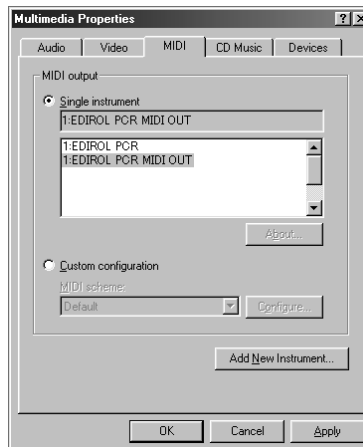

- 5** Fermez la boîte de dialogue **Propriétés de Multimédia**.
Cliquez sur [**OK**] pour terminer les réglages.

- 6** Procédez aux réglages MIDI du périphérique dans votre application (séquenceur). Pour plus de détails sur le **périphérique MIDI OUT/IN** à sélectionner, reportez-vous à la section **“About the ports when using a USB connection”** (p. 159).

Le paramétrage du pilote est terminé.

MEMO

Pour plus de détails sur les réglages MIDI, reportez-vous au manuel de l'application utilisée.

MEMO

Sélectionnez le périphérique MIDI approprié. Vous n'êtes pas obligé de sélectionner **EDIROL PCR MIDI OUT**.

MEMO

Pour plus de détails sur cette connexion, reportez-vous à la section **“About the ports when using a USB connection”** (p. 159).

MEMO

Pour plus de détails sur les réglages MIDI, reportez-vous au manuel de l'application utilisée.

Installation et configuration du pilote (Macintosh)

The installation procedure will differ depending on your system.

Please proceed to one of the following sections, depending on the system you use.

- Mac OS 9/8 users (p. 66)
- Mac OS X users (p. 71)

Utilisateurs Mac OS 9/8

■ Installation du pilote

Utilisation d'OMS ou de FreeMIDI comme pilote MIDI.

Le **pilote PCR-30/50/80** est un module supplémentaire fourni pour pouvoir faire fonctionner le PCR-30/50/80 avec OMS ou FreeMIDI.

- * **OMS ou FreeMIDI doit être installé sur votre Macintosh, selon le logiciel séquenceur utilisé.**

Procédez comme suit pour installer le pilote PCR-30/50/80.

MEMO

OMS se trouve dans le dossier **OMS 2.3.8 E** du dossier **OMS** sur le CD-ROM. Pour plus d'information sur OMS, veuillez lire le document **OMS_2.3_Mac.pdf** (manuel au format Acrobat) situé dans le dossier **OMS Driver** du dossier **OMS** sur le CD-ROM.

- * *Débranchez l'PCR-30/50/80 du Macintosh avant d'effectuer l'installation.*

Si le PCR-30/50/80 est allumé, un message similaire à celui présenté ici s'affiche à la mise sous tension du Macintosh. Suivez une des procédures décrites ci-après, selon le message qui s'affiche.

Si l'écran affiche :

"Driver required for USB device 'unknown device' is not available. Search for driver on the Internet?" → Cliquez sur **[Cancel]**.

Si l'écran affiche :

"Software required for using device 'unknown device' cannot be found. Please refer to the manual included with the device, and install the necessary software"
→ Cliquez sur **[OK]**.

- 1 Quittez tous les logiciels (applications) actifs.
Si vous utilisez un anti-virus, quittez-le également.
- 2 Munissez-vous du CD-ROM.
Insérez le CD-ROM dans le lecteur de CD-ROM.
- 3 Cliquez deux fois sur l'icône **PCR Driver-E Installer** (dans le dossier **Driver E (Mac OS 9, 8) - OMS** du CD-ROM) pour lancer l'installateur.
- 4 Vérifiez l'**emplacement de l'installation** et cliquez sur **[Install]**.
- 5 Si un message du type suivant s'affiche, cliquez sur **[Continuer]**.
Les autres applications actives se ferment et l'installation continue.
- 6 Une boîte de dialogue s'affiche : **Installation completed**.
Cliquez sur **[Redémarrer]** pour redémarrer le Macintosh.

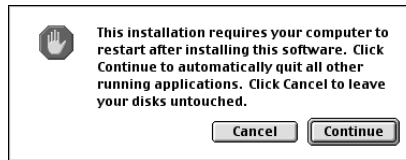

■ Paramètres

Paramètres OMS

- 1 Utilisez le **câble USB** pour relier le **PCR-30/50/80** à votre **ordinateur**.
 1. L'interrupteur d'alimentation sur **OFF**, branchez le **cordon secteur** sur le **PCR-30/50/80**.
 2. Branchez le **cordon secteur** sur une prise électrique (secteur).
 3. Utilisez le **câble USB** pour relier le **PCR-30/50/80** à votre **ordinateur**.
- 2 Placez l'**interrupteur d'alimentation** du PCR-30/50/80 sur **ON**.
- 3 Depuis le CD-ROM, faites glisser le dossier **Driver E (Mac OS 9, 8) - OMS Setting** vers le disque dur du Macintosh pour le copier.



MEMO

Une fois les connexions effectuées, mettez sous tension les différents appareils dans l'ordre spécifié. Ne pas respecter cet ordre peut entraîner des dysfonctionnements et/ou endommager les haut-parleurs ou tout autre appareil.

MEMO

Baissez toujours le volume avant la mise sous tension. Même avec le volume à zéro, il se peut que vous entendiez des sons lors de la mise sous tension, mais cela ne signifie rien d'anormal.

4

Dans le dossier **Opcode-OMS Application** où vous avez installé OMS, cliquez deux fois sur **OMS Setup** pour le lancer.



5

Si une boîte de dialogue similaire à celle présentée ici s'affiche, cliquez sur **[Turn It Off]**. Une boîte de confirmation s'affiche, cliquez sur **[OK]**.

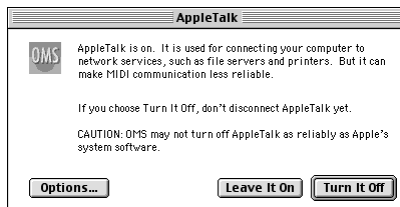

MEMO

Nous vous recommandons de désactiver **AppleTalk**, en activant le **Sélecteur** dans le menu Apple.

6

La boîte de dialogue **Create a New Studio setup** s'affiche. Cliquez sur **[Annuler]**.
Si vous avez cliqué sur **[OK]** par erreur, cliquez sur **[Annuler]** dans la boîte suivante.



7

Choisissez **"Open"** dans le menu **File**.

Dans le dossier **Setting** que vous avez copié à l'étape 3, sélectionnez le fichier **PCR**, puis cliquez sur **[Open]**.

Un écran similaire à celui présenté ici s'affiche.

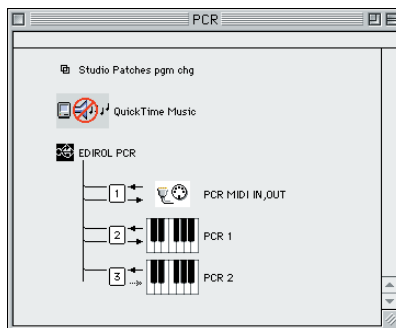

8

Dans le menu **Edit**, sélectionnez **OMS MIDI Setup**.

Dans la boîte de dialogue **OMS MIDI Setup** qui s'affiche, sélectionnez **Run MIDI in background** (Lancer MIDI en tâche de fond), puis cliquez sur **[OK]**.

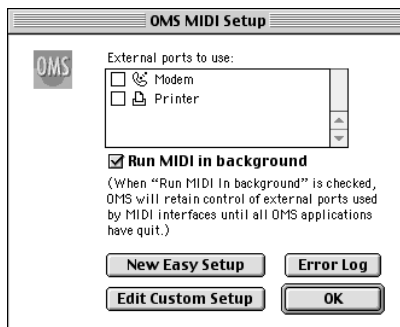

9

Dans le menu **File**, sélectionnez **Make Current** (Rendre actif).

Si vous ne pouvez pas sélectionner **Make Current**, cela signifie qu'il est déjà activé et que vous pouvez passer à l'étape suivante.

A diamond mark (◊) indicate in the settings are enabled.

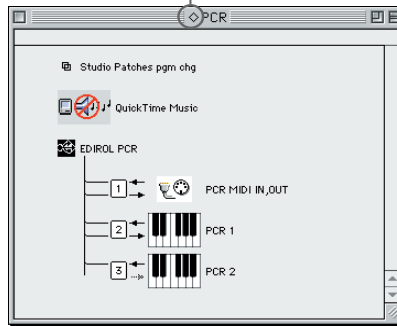

10

Vérifiez que l'envoi et la réception MIDI fonctionnent correctement. Dans le menu **Studio**, sélectionnez **Make Current** (Rendre actif).

11

Pressez une touche du clavier du PCR-30/50/80. Si la flèche à côté du numéro 2 ou 3 sur le schéma de droite clignote, les réglages sont corrects.

Lorsque vous déplacez le curseur de la souris sur l'icône représentant une prise MIDI, le curseur se transforme en note de musique.

Si un module de sons est branché en sortie MIDI OUT du PCR-30/50/80, cliquer sur l'icône de prise MIDI du schéma de droite produira un son: les réglages sont alors corrects.

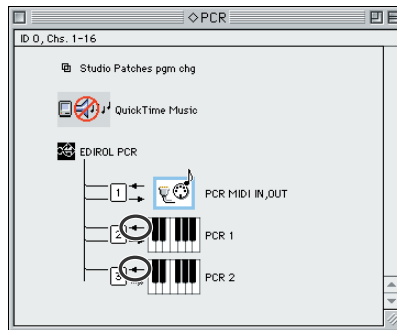

MEMO

Pour plus d'informations sur la connexion d'un module de sons MIDI, reportez-vous à la documentation de votre module de sons MIDI.

12

Quittez **OMS Setup**.

Dans le menu **File**, choisissez **[Exit]**. Si la boîte de dialogue **AppleTalk confirmation** s'affiche, cliquez sur **[OK]** pour la fermer.

La connexion du PCR-30/50/80 au Macintosh, l'installation du pilote MIDI ainsi que sa configuration sont terminées.

Paramètres FreeMIDI

- 1** Utilisez le **câble USB** pour relier le **PCR-30/50/80** à votre **ordinateur**.
 1. L'interrupteur d'alimentation sur **OFF**, branchez le **cordon secteur** sur le **PCR-30/50/80**.
 2. Branchez le **cordon secteur** sur une prise électrique (secteur).
 3. Utilisez le **câble USB** pour relier le **PCR-30/50/80** à votre **ordinateur**.
- 2** Placez l'**interrupteur d'alimentation** du PCR-30/50/80 sur **ON**.
- 3** Depuis le CD-ROM, copiez le dossier **Driver E (Mac OS 9, 8) – FreeMIDI Setting** sur le disque dur du Macintosh.
- 4** Ouvrez le dossier **FreeMIDI Applications** à l'emplacement où vous avez installé FreeMIDI, puis cliquez deux fois sur l'icône **FreeMIDI Setup** pour démarrer la configuration.
- 5** Quand le message suivant apparaît : "**OMS is installed on this computer...**", cliquez sur **[FreeMIDI]**.
- 6** Au premier lancement de FreeMIDI, une boîte de dialogue "**Welcome to FreeMIDI!**" s'affiche. Cliquez sur **[Continue]**.
- 7** Quand la boîte de dialogue **FreeMIDI Preferences** s'affiche, cliquez sur **[Cancel]**.
- 8** Quand la boîte de dialogue **About Quick Setup** s'affiche, cliquez sur **[Cancel]**.
- 9** Dans le menu **File**, sélectionnez **Open**.
- 10** Sélectionnez **PCR** dans le dossier **FreeMIDI Settings** que vous avez copié à l'étape 3, puis cliquez sur **[Open]**.
- 11** Vérifiez que l'envoi et la réception MIDI fonctionnent correctement. Dans le menu **MIDI**, choisissez **Check Connections**.

MEMO

Une fois les connexions effectuées, mettez sous tension les différents appareils dans l'ordre spécifié. Ne pas respecter cet ordre peut entraîner des dysfonctionnements et/ou endommager les haut-parleurs ou tout autre appareil.

MEMO

Baissez toujours le volume avant la mise sous tension. Même avec le volume à zéro, il se peut que vous entendiez des sons lors de la mise sous tension, mais cela ne signifie rien d'anormal.

12

Si un module de sons est branché en sortie MIDI OUT du PCR-30/50/80, cliquer sur l'icône de prise MIDI du schéma de droite produira un son: les réglages sont alors corrects.

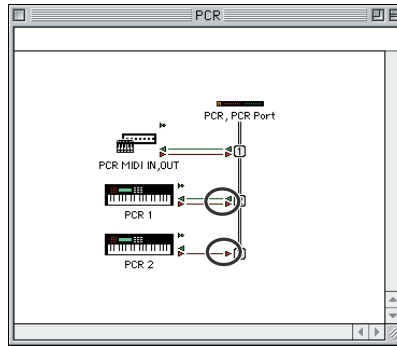
**MEMO**

Pour plus d'informations sur la connexion d'un module de sons MIDI, reportez-vous à la documentation de votre module de sons MIDI.

13

Choisissez à nouveau la commande **MIDI Check Connections** pour terminer le test.

14

Dans le menu **File**, choisissez **Quit** pour quitter **FreeMIDI Setup**.

La connexion du PCR-30/50/80 au Macintosh, l'installation du pilote MIDI ainsi que sa configuration sont terminées.

Utilisateurs Mac OS X

■ Installation du pilote

1

Déconnectez tous les câbles USB à l'exception de ceux de votre clavier et de votre souris, et redémarrez votre Macintosh.

2

Munissez-vous du CD-ROM.
Introduisez-le dans le lecteur de CD de votre ordinateur.

3

Dans le dossier **Driver (Mac OS X)** du CD-ROM, cliquez deux fois sur **PCRUSBDriver.pkg**.

Dans Mac OS X v10.1.5, cliquez sur le symbole du verrou pour vous identifier.

4

Dans la boîte de dialogue d'**identification**, entrez le mot de passe et cliquez sur **[OK]**.

5

L'indication **“Welcome to the EDIROL PCR USB Driver Installation”** s'affiche.

Cliquez sur **[Continue]**.

6

“Important message” s'affiche.

Lisez les informations, puis cliquez sur **[Continue]**.

7

“Select the location for installation” s'affiche.

Cliquez sur le lecteur dans lequel le système est installé pour le sélectionner, puis cliquez sur **[Continue]**.

8

“Easy Installation” s'affiche.

Cliquez sur **[Install]** ou sur **[Upgrade]**.

9

Le message **“When you install this software, you must restart your computer after the installation is complete”** s'affiche (“Vous devez redémarrer votre ordinateur une fois l'installation terminée”).

Cliquez sur **[Continue installation]**.

10

“The software was successfully installed” s'affiche (“Le logiciel a été installé avec succès”).

Cliquez sur **[Restart]** pour redémarrer votre ordinateur.

Précautions à prendre lors de l'utilisation de PCR

Avant d'utiliser votre logiciel séquenceur, tenez compte des points suivants.

- * *Branchez le PCR-30/50/80 à votre ordinateur avec un câble USB avant de lancer tout logiciel audio.*
- * *Ne débranchez pas le câble USB du PCR-30/50/80 pendant que le logiciel est actif.*
- * *Débranchez le câble USB du PCR-30/50/80 uniquement après avoir quitté votre logiciel.*
- * *Laissez la fonction Veille de votre Macintosh désactivée.*
- * *Le PCR-30/50/80 ne fonctionne pas dans l'environnement Classic de Mac OS X. Utilisez le PCR lorsque cet environnement est inactif.*

■ Réglage du pilote

1

Utilisez le **câble USB** pour brancher le **PCR-30/50/80** à votre **ordinateur**.

1. L'interrupteur d'alimentation sur **OFF**, branchez le **cordon secteur** sur le **PCR-30/50/80**.
2. Branchez le **cordon secteur** sur une prise électrique (secteur).
3. Utilisez le **câble USB** pour brancher le **PCR-30/50/80** à votre **ordinateur**.

2

Placez l'**interrupteur d'alimentation** du PCR-30/50/80 sur **ON**.

3

Procédez aux réglages MIDI du périphérique dans votre séquenceur logiciel. Pour plus de détails sur le **périphérique MIDI OUT/IN** à sélectionner, reportez-vous à la section "**About the ports when using a USB connection**" (p. 159).

La connexion du PCR-30/50/80 au Macintosh, l'installation du pilote MIDI ainsi que sa configuration sont terminées.

MEMO

Pour plus de détails sur les réglages MIDI, reportez-vous au manuel de l'application utilisée.

English

Deutsch

Français

Italiano

Español

Installazione e configurazione del driver (Windows)

Installazione del driver

La procedura d'installazione dipenderà dal sistema utilizzato.
Passare ad una delle sezioni seguenti a seconda del sistema utilizzato.

- Utenti Windows XP (pag. 74)
- Utenti Windows 2000..... (pag. 78)
- Utenti Windows Me/98 (pag. 81)

■ Utenti Windows XP

1

Dopo aver scollegato il PCR-30/50/80 , avviare Windows.

Scollegare tutti i cavi USB, ad eccezione della tastiera e del mouse USB, se utilizzati.

2

Aprire la finestra di dialogo **Proprietà del sistema**.

1. In Windows, fare clic sul pulsante **Start** e nel menu selezionare **Pannello di controllo**.
2. In **“Scegliere una categoria”**, fare clic su **“Prestazioni e manutenzione”**.
3. In **“o un'icona del Pannello di controllo”**, fare clic sull'icona **Sistema**.

3

Fare clic sulla scheda **Hardware** e poi sul pulsante **[Firma driver]**.

Aprire la finestra di dialogo **Opzioni firma driver**.

4

Accertarsi che **“Scegliere una delle seguenti opzioni”** sia impostato su **“Ignora”**

Se è attivata l'opzione **“Ignora”** fare clic su **[OK]**.

Se non è impostata su **“Ignora”** prendere nota dell'impostazione corrente (di avviso o di blocco). Modificare quindi l'impostazione su **“Ignora”** e fare clic su **[OK]**

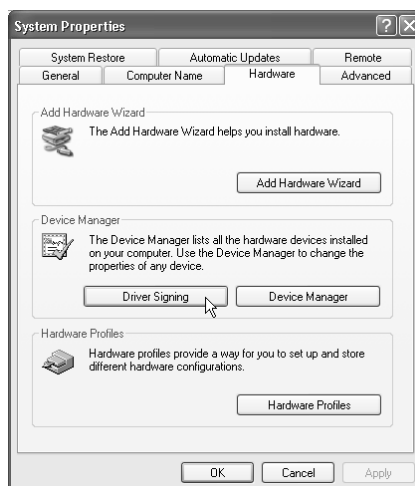

Se si utilizza Windows XP Professional, è necessario collegarsi come un nome utente dotato di privilegi amministrativi, ad esempio come Administrator. Per maggiori informazioni sugli account degli utenti, contattare l'amministratore del sistema.



A seconda di come il sistema è configurato, l'icona **Sistema** potrebbe essere visualizzata direttamente nel **Pannello di controllo** (visualizzazione classica). In tal caso fare doppio clic sull'icona **Sistema**.



Se al **passo 4** il parametro **“Scegliere una delle seguenti impostazioni”** è stato modificato, dopo aver installato il driver è necessario ripristinare l'impostazione d'origine.

5 Fare clic su **[OK]** per chiudere la finestra di dialogo **Proprietà del sistema**.

6 Chiudere tutti i programmi in corso di esecuzione.
Chiudere anche le altre finestre aperte. Se si utilizza un programma antivirus o simile, accertarsi che sia anch'esso chiuso.

7 Preparare il CD-ROM.
Inserire il CD nell'unità CD-ROM del computer.

8 Fare clic sul pulsante **Start** di Windows. Nel menu visualizzato, selezionare **"Esegui"**.
Aprire la finestra di dialogo **"Esegui..."**.

9 Nella finestra di dialogo che appare, immettere quanto segue nel campo **"Apri"** e fare clic su **[OK]**.

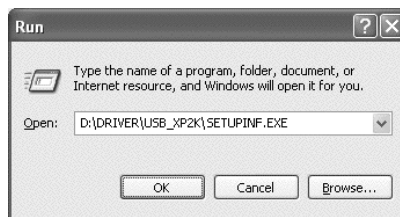

D:\Driver\USB_XP2K\SETUPINF.EXE

** L'identificativo dell'unità "D:" potrebbe essere diverso da quello del sistema utilizzato. In questo caso specificare il nome dell'unità CD-ROM utilizzata.*

10 Appare la finestra di dialogo **SetupInf**.
È ora possibile installare il driver.

11 Utilizzare il **cavo USB** per collegare il **PCR-30/50/80** al computer.

1. Dopo aver spostato l'interruttore di alimentazione su **OFF**, collegare l'**adattatore AC** al **PCR-30/50/80**.
2. Collegare l'**adattatore AC** a una presa elettrica.
3. Utilizzare il **cavo USB** per collegare il **PCR-30/50/80** al computer.

12 Spostare l'**interruttore di alimentazione** del **PCR-30/50/80** in posizione **ON**.
Nella barra delle applicazioni verrà visualizzato il messaggio **"Trovato nuovo hardware"**. Attendere qualche minuto.

MEMO

Una volta terminati i collegamenti, accendere i vari dispositivi nell'ordine indicato. Se i dispositivi vengono accesi nell'ordine sbagliato, si rischia di provocare malfunzionamenti e/o danni ai diffusori e agli altri dispositivi.

MEMO

Questo apparecchio è provvisto di un circuito di protezione. È necessario aspettare qualche secondo dopo l'accensione prima che l'apparecchio funzioni normalmente.

13 Verrà visualizzata la **finestra di dialogo Installazione guidata nuovo hardware**.

Accertarsi che sullo schermo compaia **“EDIROL PCR”**, selezionare **“Installa da un elenco o percorso specifico (per utenti esperti)”** e fare clic su **[Avanti]**.

14 La finestra visualizzerà il seguente messaggio **“Selezionare le opzioni di ricerca e di installazione”**.

Selezionare **“Non effettuare la ricerca. La scelta del driver da installare verrà effettuata manualmente”**, e fare clic su **[Avanti]**.



15 Accertarsi che il campo **“Modello”** visualizzi **“EDIROL PCR”** e fare clic su **[Avanti]**. La procedura di installazione del driver verrà avviata.

Se l'impostazione **“Scegliere una delle seguenti opzioni”** non è stata impostata su **“Ignora”** comparirà il messaggio **“Installazione guidata hardware”**.

Se “Scegliere una delle seguenti opzioni” è impostato su “Avvisa”

1. Fare clic su **[Continuare]**.
2. Continuare l'installazione.

Se “Scegliere una delle seguenti opzioni” è impostato su “Blocca”

1. Fare clic su **[OK]**.
2. Quando appare la finestra **“Installazione guidata nuovo hardware”**, fare clic su **[Fine]**.
3. Eseguire l'installazione come descritto nella sezione **“Troubleshooting”, Device Manager shows “?”, “!”, or “USB Composite Device”** (pag. 172).

16 Viene visualizzata la finestra di dialogo **Inserisci disco**

Fare clic su **[OK]**.

17 Viene visualizzata la finestra di dialogo **Richiesta file**

Immettere quanto segue nel campo **“Copia file da”** e fare clic su **[OK]**.

D:\Driver\USB_XP2K

** L'identificativo dell'unità **“D:”** potrebbe essere diverso da quello del sistema utilizzato. In questo caso specificare il nome dell'unità CD-ROM utilizzata.*



Viene visualizzata la finestra di dialogo **Inserire il disco**. In questo caso passare al **passo 17**.

18

Verrà visualizzata la **finestra di dialogo Installazione guidata nuovo hardware**.

Accertarsi che sullo schermo sia visualizzato “**EDIROL PCR**”, e fare clic su **[Fine]**.

Attendere fino a quando nella barra delle applicazioni non appare il messaggio “**Trovato nuovo hardware**”.

19

Alla fine dell'installazione del driver, comparirà la finestra di dialogo **Modifica impostazioni di sistema**.

Fare clic su **[Si]**. Windows verrà riavviato automaticamente.

Se è stato modificato il parametro “Scegliere una delle seguenti opzioni”

Se l'impostazione **Scegliere una delle seguenti opzioni** è stata modificata, ripristinare il parametro d'origine dopo aver riavviato Windows.

1. Se si utilizza **Windows XP Professional**, collegarsi con un nome utente dotato di privilegi di tipo **amministrativo** (ad esempio Administrator).
2. In Windows, fare clic sul menu **Start** e nel menu selezionare **Pannello di controllo**.
3. In “**Scegliere una categoria**”, fare clic su “**Prestazioni e manutenzione**”.
4. In “**o un'icona del Pannello di controllo**”, fare clic sull'icona **Sistema**. Viene visualizzata la finestra di dialogo **Proprietà del sistema**.

** A seconda di come il sistema è configurato, l'icona **Sistema** potrebbe essere visualizzata direttamente nel **Pannello di controllo** (visualizzazione classica). In tal caso fare doppio clic sull'icona **Sistema**.*

5. Fare clic sulla scheda **Hardware** e poi sul pulsante **[Firma driver]**. Verrà visualizzata la finestra di dialogo **Opzioni firma driver**.
6. Ripristinare l'impostazione **Scegliere una delle seguenti opzioni** al valore d'origine (di avviso o di blocco) e fare clic su **[OK]**.
7. Fare clic su **[OK]**. La finestra di dialogo **Proprietà di sistema** si chiude.

Successivamente sarà necessario configurare il driver.

(→ **Destinazioni input e output MIDI** (pag. 83))

■ Utenti Windows 2000

- 1 Dopo aver scollegato il PCR-30/50/80 , avviare Windows.
Scollegare tutti i cavi USB, ad eccezione della tastiera e del mouse USB, se utilizzati.
- 2 Collegarsi a Windows con i **privilegi di un amministratore**, ad esempio come Administrator.
- 3 Aprire la finestra di dialogo **Proprietà del sistema**.
In Windows, fare clic sul pulsante **Start** e nel menu selezionare **Impostazioni | Pannello di controllo**. Nel **Pannello di controllo**, fare doppio clic sull'icona **Sistema**.
- 4 Fare clic sulla scheda **Hardware** e poi sul pulsante [**Firma driver**].
Aprire la finestra di dialogo **Opzioni firma driver**.
- 5 Accertarsi che “**Verifica firma file**” sia impostato su “**Ignora**”.
Se è attivata l'opzione “**Ignora**” fare clic su [**OK**].
Se non è impostata su “**Ignora**” prendere nota dell'impostazione corrente (di avviso o di blocco). Modificare quindi l'impostazione su “**Ignora**” e fare clic su [**OK**]
- 6 Chiudere la finestra di dialogo **Proprietà del sistema**.
Fare clic su [**OK**].
- 7 Chiudere tutti i programmi in corso di esecuzione.
Chiudere anche le altre finestre aperte. Se si utilizza un programma antivirus o simile, accertarsi che sia anch'esso chiuso.
- 8 Preparare il CD-ROM.
Inserire il CD nell'unità CD-ROM del computer.

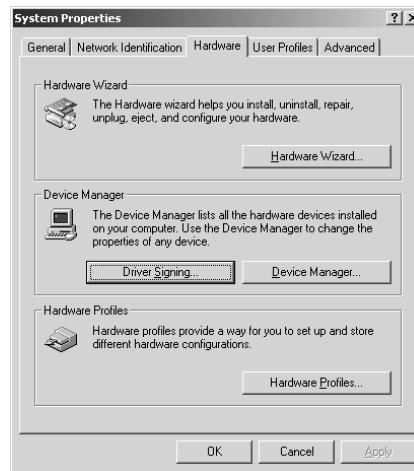

MEMO

Se “**Verifica firma file**” è stato modificato al **passo 5**, si dovrà ripristinare l'impostazione d'origine dopo aver installato il driver.

9 Fare clic sul pulsante **Start** di Windows. Nel menu visualizzato, selezionare **“Esegui”**.

Aprire la finestra di dialogo **“Esegui...”**.

10 Nella finestra di dialogo che appare, immettere quanto segue nel campo **“Apri”** e fare clic su **[OK]**.

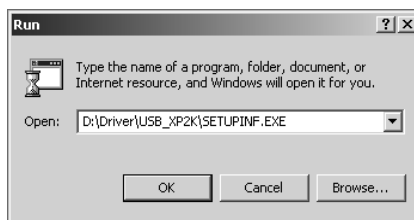

D:\Driver\USB_XP2K\SETUPINF.EXE

** L'identificativo dell'unità **“D:”** potrebbe essere diverso da quello del sistema utilizzato. In questo caso specificare il nome dell'unità CD-ROM utilizzata.*

11 Appare la finestra di dialogo **SetupInf**.

È ora possibile installare il driver.

12 Utilizzare il **cavo USB** per collegare il **PCR-30/50/80** al computer.

1. Dopo aver spostato l'interruttore di alimentazione su **OFF**, collegare l'**adattatore AC** al **PCR-30/50/80**.
2. Collegare l'**adattatore AC** a una presa elettrica.
3. Utilizzare il **cavo USB** per collegare il **PCR-30/50/80** al computer.

13 Spostare l'**interruttore di alimentazione** del **PCR-30/50/80** in posizione **ON**.

Se l'impostazione **“Verifica firma file”** non è stata impostata su **“Ignora”**, verrà visualizzato il messaggio **“Firma digitale non trovata”**.

Se “Verifica firma digitale” è “impostato su Avvisa”,

1. Fare clic su **[Si]**.
2. Continuare l'installazione.

Se “Verifica firma digitale” è “impostato su Blocca”,

1. Fare clic su **[OK]**.
2. Quando appare la finestra **“Installazione guidata nuovo hardware”**, fare clic su **[Fine]**.
3. Eseguire l'installazione come descritto nella sezione **“Troubleshooting”, Device Manager shows “?”, “!”, or “USB Composite Device”** (pag. 172).

MEMO

Una volta terminati i collegamenti, accendere i vari dispositivi nell'ordine indicato. Se i dispositivi vengono accesi nell'ordine sbagliato, si rischia di provocare malfunzionamenti e/o danni ai diffusori e agli altri dispositivi.

MEMO

Questo apparecchio è provvisto di un circuito di protezione. È necessario aspettare qualche secondo dopo l'accensione prima che l'apparecchio funzioni normalmente.

14 Viene visualizzata la finestra di dialogo **Inserisci disco**.
Fare clic su **[OK]**.

15 Viene visualizzata la finestra di dialogo **Richiesta file**.
Immettere quanto segue nel campo **“Copia file da”** e fare clic su **[OK]**.
D:\Drivers\USB_XP2K

* *L'identificativo dell'unità “D:” potrebbe essere diverso da quello del sistema utilizzato. In questo caso specificare il nome dell'unità CD-ROM utilizzata.*

16 Potrebbe essere visualizzata la finestra di dialogo **“Installazione guidata nuovo hardware”**.
Accertarsi che **“EDIROL PCR”** sia visualizzato e fare clic su **[Fine]**.

17 Viene visualizzata la finestra di dialogo **Modifica impostazioni di sistema**.
Fare clic su **[Sì]**. Windows verrà riavviato automaticamente.



Se la finestra di dialogo **Inserire il disco** non appare, leggere la sezione **The “Insert Disk” dialog box does not appear** (pag. 171).

Se è stata modificata l'impostazione “Verifica firma file”

Se l'impostazione “Verifica firma file” è stata cambiata, ripristinare l'impostazione d'origine dopo aver riavviato Windows.

1. Dopo aver riavviato Windows, collegarsi a Windows come un utente dotato di **privilegi di amministrazione**, ad esempio come Administrator.
2. Sul desktop di Windows, fare clic con il pulsante destro del mouse su **Risorse del computer** e nel menu visualizzato selezionare **Proprietà**. Viene visualizzata la finestra di dialogo **Proprietà del sistema**.
3. Fare clic sulla scheda **Hardware** e poi sul pulsante **[Firma driver]**. Verrà visualizzata la finestra di dialogo **Opzioni firma driver**.
4. Ripristinare l'impostazione **“Verifica firma file”** al valore d'origine (“**Avvisa**” o “**Blocca**”), e fare clic su **[OK]**.
5. Fare clic su **[OK]**. La finestra di dialogo **Proprietà di sistema** si chiude.

Successivamente sarà necessario configurare il driver.)
(→ **Destinazioni input e output MIDI** (pag. 83))

■ Utenti Windows Me/98

- 1 Dopo aver scollegato il PCR-30/50/80 , avviare Windows.
Scollegare tutti i cavi USB, ad eccezione della tastiera e del mouse USB, se utilizzati.
- 2 Chiudere tutti i programmi in corso di esecuzione.
Chiudere anche le altre finestre aperte. Se si utilizza un programma antivirus o simile, accertarsi che sia anch'esso chiuso.
- 3 Preparare il CD-ROM.
Inserire il CD nell'unità CD-ROM del computer.
- 4 Fare clic sul pulsante **Start** di Windows. Nel menu visualizzato, selezionare **"Esegui"**.
Aprire la finestra di dialogo **"Esegui..."**.

- 5 Nella finestra di dialogo che appare, immettere quanto segue nel campo **"Apri"** e fare clic su **[OK]**.

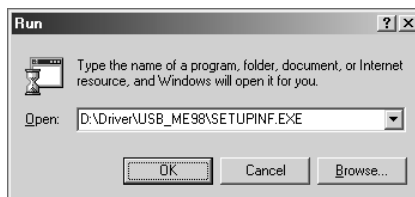

D:\Driver\USB_ME98\SETUPINF.EXE

** L'identificativo dell'unità "D:" potrebbe essere diverso da quello del sistema utilizzato. In questo caso specificare il nome dell'unità CD-ROM utilizzata.*

- 6 Appare la finestra di dialogo **SetupInf**.
È ora possibile installare il driver.

7

Utilizzare il **cavo USB** per collegare il **PCR-30/50/80** al **computer**.

1. Dopo aver spostato l'interruttore di alimentazione su **OFF**, collegare l'**adattatore AC** al **PCR-30/50/80**.
2. Collegare l'**adattatore AC** a una presa elettrica.
3. Utilizzare il **cavo USB** per collegare il **PCR-30/50/80** al **computer**.

8

Spostare l'**interruttore di alimentazione** del **PCR-30/50/80** in posizione **ON**.

9

Il driver verrà installato automaticamente.

10

Nella finestra di dialogo, fare clic su [OK].

* *Se appare un messaggio che invita a riavviare Windows, riavviarlo come consigliato.*

Successivamente sarà necessario configurare il driver.
(→ **Destinazioni input e output MIDI** (pag. 83))

NOTE

Una volta terminati i collegamenti, accendere i vari dispositivi nell'ordine indicato. Se i dispositivi vengono accesi nell'ordine sbagliato, si rischia di provocare malfunzionamenti e/o danni ai diffusori e agli altri dispositivi.

MEMO

Questo apparecchio è provvisto di un circuito di protezione. È necessario aspettare qualche secondo dopo l'accensione prima che l'apparecchio funzioni normalmente.

Impostazioni

■ Destinazioni input e output MIDI

Utenti Windows XP/2000/Me

1

Aprire il **Pannello di controllo**.

In Windows, fare clic sul pulsante **Start** e nel menu selezionare **Impostazioni | Pannello di controllo**.

Windows XP

In Windows, fare clic sul pulsante **Start** e nel menu selezionare **Pannello di controllo**.

2

Aprire la finestra di dialogo **Proprietà – Suoni e periferiche audio** (oppure in Windows 2000/Me, **Proprietà – Suoni e multimedia**).

Windows XP

In “**Scegliere una categoria**”, fare clic su “**Suoni, voce e periferiche audio**”. Successivamente in “**o un’icona del Pannello di controllo**”, fare clic sull’icona **Suoni e periferiche audio**.

Windows 2000/Me

Nel **Pannello di controllo**, fare doppio clic sull’icona **Suoni e multimedia** per aprire la finestra “**Proprietà suoni e multimedia**”.

3

Fare clic sulla scheda **Audio**.

4

Per **Riproduzione musica MIDI**, fare clic su ▼ a destra di **[Periferica predefinita]** (oppure in Windows 2000/Me, **[Periferica preferenziale]**) e selezionare la periferica MIDI nell’elenco visualizzato.

Per utilizzare Windows Media Player per riprodurre un modulo sonoro collegato al connettore MIDI OUT del PCR, selezionare **EDIROL PCR MIDI OUT**.

5

Chiudere la finestra di dialogo **Proprietà – Suoni e periferiche audio**. Fare clic su **OK** per completare le impostazioni.

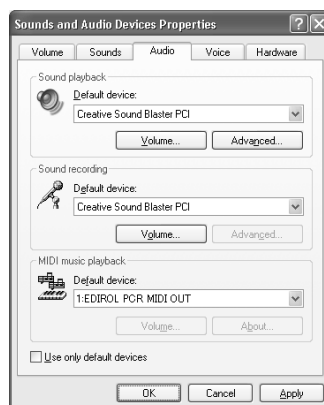

MEMO

A seconda di come il sistema è configurato, l’icona **Suoni e periferiche audio** potrebbe essere visualizzata direttamente nel **Pannello di controllo** (visualizzazione classica). In tal caso fare doppio clic sull’icona **Suoni e periferiche audio**.

MEMO

Selezionare la periferica MIDI opportuna per il sistema utilizzato. Non è necessario selezionare obbligatoriamente **EDIROL PCR MIDI OUT**.

MEMO

Per maggiori informazioni sulla porta, fare riferimento alla sezione “**About the ports when using a USB connection**” (pag. 159).

6

Configurare la periferica MIDI sul software sequencer. Per maggiori informazioni sulla **periferica MIDI OUT/IN** da selezionare, fare riferimento alla sezione **About the ports when using a USB connection** (pag. 159).

La procedura di configurazione del driver è giunta al termine.

Utenti Windows 98

1

Aprire il **Pannello di controllo**.

In Windows, fare clic sul pulsante **Start** e nel menu selezionare **Impostazioni | Pannello di controllo**.

2

Aprire la finestra di dialogo **Proprietà multimediali**.

Nel **Pannello di controllo**, fare doppio clic sull'icona **Multimedia** per aprire la finestra **Proprietà multimediali**.

3

Fare clic sulla scheda **MIDI**.

4

Impostare l'“**Uscita MIDI**”.

Selezionare [**Strumento singolo**] e scegliere la periferica MIDI nell'elenco visualizzato.

Per utilizzare Windows Media Player per riprodurre un modulo sonoro collegato al connettore MIDI OUT del PCR, selezionare **EDIROL PCR MIDI OUT**.

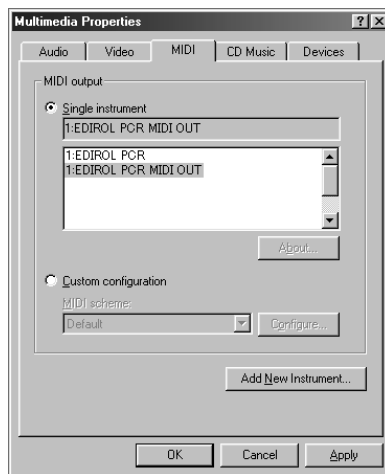

5

Chiudere la finestra di dialogo **Proprietà multimediali**. Fare clic su **OK** per completare le impostazioni.

6

Configurare la periferica MIDI sul software sequencer. Per maggiori informazioni sulla **periferica MIDI OUT/IN** da selezionare, fare riferimento alla sezione “**About the ports when using a USB connection**” (pag. 159).

La procedura di configurazione del driver è giunta al termine.

MEMO

Per maggiori informazioni sulle impostazioni della periferica MIDI, fare riferimento al manuale del software utilizzato.

MEMO

Selezionare la periferica MIDI opportuna per il sistema utilizzato. Non è necessario selezionare obbligatoriamente **EDIROL PCR MIDI OUT**.

MEMO

Per maggiori informazioni sulla porta, fare riferimento alla sezione “**About the ports when using a USB connection**” (pag. 159).

MEMO

Per maggiori informazioni sulle impostazioni della periferica MIDI, fare riferimento al manuale del software utilizzato.

Installazione e configurazione del driver (Macintosh)

The installation procedure will differ depending on your system.

Please proceed to one of the following sections, depending on the system you use.

- Mac OS 9/8 users (pag. 85)
- Mac OS X users (pag. 91)

Utenti Mac OS 9/8

■ Installazione del driver

Utilizzare come driver MIDI OMS o FreeMIDI.

Il driver **PCR-30/50/80** è un modulo aggiuntivo che permette di utilizzare l'SD-80 con OM0 o FreeMIDI.

- * *Sul Macintosh deve essere stato installato **OMS** o **FreeMIDI** a seconda del software sequencer utilizzato.*

Seguire la procedura sotto indicata per installare il driver PCR-30/50/80.

- * *Scollegare l'PCR-30/50/80 dal Macintosh prima di eseguire l'installazione*

Se l'PCR-30/50/80 è acceso, comparirà un messaggio, come quello sotto illustrato, quando viene avviato il Macintosh. Seguire una delle procedure sotto indicate a seconda del messaggio visualizzato.

Se appare il seguente messaggio:

"Driver required for USB device 'unknown device' is not available. Search for driver on the Internet?" → fare clic su **[Cancel]**.

Se appare il seguente messaggio:

"Software required for using device 'unknown device' cannot be found. Please refer to the manual included with the device, and install the necessary software"

→ fare clic su **[OK]**.



L'applicazione **OMS** si trova nella cartella **OMS 2.3.8 E** all'interno della cartella **OMS** del CD-ROM. Per avere maggiori informazioni sul software **OMS**, consultare il file **OMS_2.3_Mac.pdf** (manuale in linea) che si trova nella cartella **OMS 2.3.8E** all'interno della cartella **OMS** sul CD-ROM.

- 1** Chiedere tutti i programmi in corso di esecuzione.
Se si utilizza un programma antivirus o simili, accertarsi che sia anch'esso chiuso.
- 2** Preparare il CD-ROM.
Inserire il CD-ROM nell'unità CD-ROM.
- 3** Fare doppio clic sull'icona **PCR Driver-E Installer**, che si trova nella cartella **Driver E (Mac OS 9, 8)** del CD-ROM, per avviare il programma d'installazione.
- 4** Controllare la **destinazione dell'installazione** e fare clic su **[Install]**.
- 5** Se appare un messaggio come quello sotto indicato, fare clic su **[Continue]**.
Le applicazioni in corso di esecuzione verranno chiuse e l'installazione proseguirà.
- 6** Verrà visualizzata una finestra di dialogo indicante **Installation completed**.
Fare clic su **[Restart]** per riavviare il Macintosh.

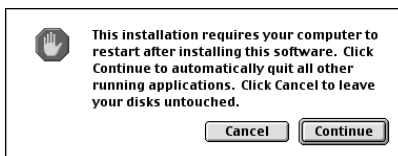

■ Impostazioni

Impostazioni OMS

- 1** Utilizzare il **cavo USB** per collegare l'**PCR-30/50/80** al **computer**.
 1. Dopo aver spostato l'interruttore di alimentazione su **OFF**, collegare il **adattatore AC** all'**PCR-30/50/80**.
 2. Collegare il **adattatore AC** a una presa elettrica.
 3. Utilizzare il **cavo USB** per collegare l'**PCR-30/50/80** al **computer**.

MEMO

Una volta terminati i collegamenti, accendere i vari dispositivi nell'ordine indicato. Se i dispositivi vengono accesi nell'ordine sbagliato, si rischia di provocare malfunzionamenti e/o danni ai diffusori e agli altri dispositivi.

2 Spostare l'interruttore di alimentazione dell'PCR-30/50/80 in posizione **ON**.

3 Dal CD-ROM, selezionare e trascinare la cartella **Driver E (Mac OS 9, 8) - OMS Setting** sul disco fisso del Macintosh per copiarvela.



4 Nella cartella **Opcode-OMS Application** dove è stato installato OMS, fare doppio clic su **OMS Setup** per avviarlo.



5 Se compare una finestra di dialogo come quella illustrata, fare clic su **[Turn It Off]**. Verrà visualizzata una finestra di dialogo di conferma; fare clic su **[OK]**.

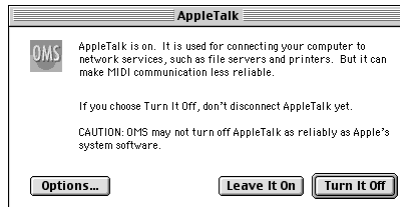

6 Verrà visualizzata la finestra di dialogo **“Create a New Studio Setup”**. Fare clic su **[Cancel]**. Se è stato selezionato accidentalmente il pulsante **[OK]**, fare clic su **[Cancel]** nella finestra successiva.

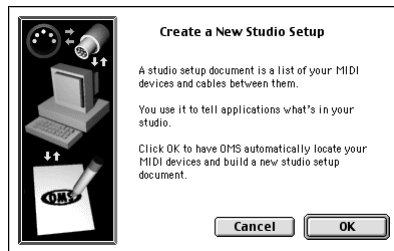

7 Selezionare **“Open”** nel menu **File**.

Nella cartella **Settings** copiata al **passo 3**, selezionare il file **PCR** e fare clic su **[Open]**. Verrà visualizzata una finestra di dialogo simile a quella illustrata.

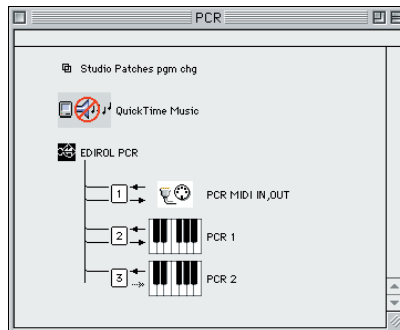

MEMO

Prima di accendere gli apparecchi, accertarsi che il livello del volume sia al minimo. Si potrebbero sentire comunque dei suoni all'accensione, anche se il volume è al minimo; è normale e non c'è motivo di preoccuparsi.

MEMO

Si consiglia di disattivare **AppleTalk** selezionando **Chooser** nel menu **Apple**.

8

Nel menu **Edit** selezionare **OMS MIDI Setup**.

Nella finestra di dialogo **OMS MIDI Setup** visualizzata, selezionare **Run MIDI in background** e fare clic su **[OK]**.

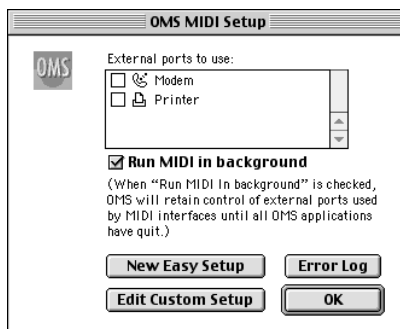

9

Nel menu **File** selezionare **Make Current**.

Se non è possibile selezionare **Make Current**, vuol dire che è stata già attivata e si può quindi passare all'operazione successiva.

A diamond mark (◊) indicate in the settings are enabled.

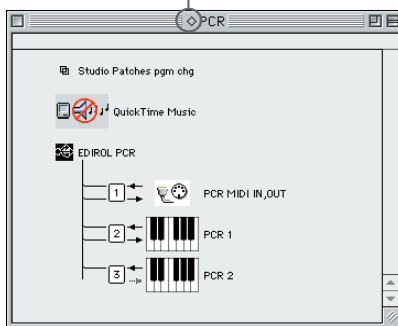

10

Accertarsi che la trasmissione e la ricezione MIDI siano corrette. Nel menu **Studio** selezionare **Test Studio**.

11

Prova a suonare la tastiera PCR-30/50/80. Se la freccia sotto al numero 2 o al numero 3 lampeggia (vedi diagramma a destra), le impostazioni sono state eseguite correttamente. Spostando il cursore del mouse vicino all'icona  del connettore MIDI, il puntatore cambierà forma in quella di una nota musicale.

Se un modulo sonoro MIDI è collegato alla presa MIDI OUT della tastiera PCR-30/50/80, fai click sull'icona del connettore MIDI che appare nel diagramma a destra. Se viene generato un suono, le impostazioni sono state eseguite correttamente.

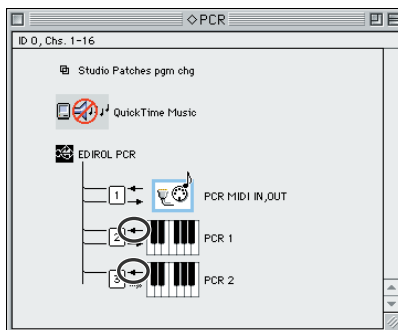

MEMO

Si consiglia di disattivare AppleTalk per maggiori informazioni sul collegamento del modulo sonoro MIDI, fare riferimento al manuale utente del modulo sonoro MIDI.

12

Chiudere **OMS Setup**.

Nel menu **File** selezionare **[Exit]**. Se appare la finestra di dialogo di conferma **AppleTalk confirmation**, fare clic su **[OK]** per chiuderla.

La procedura di collegamento dell'PCR-30/50/80 al Macintosh, di installazione del driver MIDI e di configurazione del driver è giunta al termine.

■ Impostazioni FreeMIDI

1

Utilizzare il **cavo USB** per collegare l'**PCR-30/50/80** al **computer**.

1. Dopo aver spostato l'interruttore di alimentazione su **OFF**, collegare il **adattatore AC** all'**PCR-30/50/80**.
2. Collegare il **adattatore AC** a una presa elettrica.
3. Utilizzare il **cavo USB** per collegare l'**PCR-30/50/80** al **computer**.

2

Spostare l'**interruttore di alimentazione** dell'**PCR-30/50/80** in posizione **ON**.

3

Dal CD-ROM, copiare la cartella **Driver E (Mac OS 9, 8) – FreeMIDI Setting** sul disco fisso del Macintosh.

4

Aprire la cartella **FreeMIDI Applications** dove è stata eseguita l'installazione FreeMIDI e fare doppio clic sull'icona **FreeMIDI Setup** per avviare l'applicazione.

5

Quando appare il messaggio "**OMS is installed on this computer...**", fare clic su **[FreeMIDI]**.

6

Al primo avvio di FreeMIDI, comparirà la finestra di dialogo "**Welcome to FreeMIDI!**". Fare clic su **[Continue]**.

7

Nella finestra di dialogo **FreeMIDI Preferences**, fare clic su **[Cancel]**.

8

Nella finestra di dialogo **About Quick Setup**, fare clic su **[Cancel]**.

9

Nel menu **File** selezionare **Open**.

MEMO

Una volta terminati i collegamenti, accendere i vari dispositivi nell'ordine indicato. Se i dispositivi vengono accesi nell'ordine sbagliato, si rischia di provocare malfunzionamenti e/o danni ai diffusori e agli altri dispositivi.

MEMO

Prima di accendere gli apparecchi, accertarsi che il livello del volume sia al minimo. Si potrebbero sentire comunque dei suoni all'accensione, anche se il volume è al minimo; è normale e non c'è motivo di preoccuparsi.

10 Selezionare **PCR** nella cartella **FreeMIDI Setting** copiata al **passo 3** e fare clic su **[Open]**.

11 Controllare che l'invio e la ricezione MIDI siano corrette.
Nel menu **MIDI** selezionare **Check Connections**.

12 Se un modulo sonoro MIDI è collegato alla presa MIDI OUT della tastiera PCR-30/50/80, fai click sull'icona del connettore MIDI che appare nel diagramma a destra. Se viene generato un suono, le impostazioni sono state eseguite correttamente.

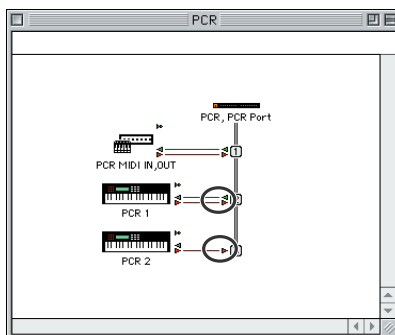

13 Scegliere di nuovo il comando **Check Connections** nel menu **MIDI** per concludere il test.

14 Nel menu **File**, scegliere **Quit** per uscire da **FreeMIDI Setup**.

La procedura di collegamento dell'PCR-30/50/80 al Macintosh, di installazione del driver MIDI e di configurazione del driver è giunta al termine.

MEMO

Si consiglia di disattivare AppleTalPer maggiori informazioni sul collegamento del modulo sonoro MIDI, fare riferimento al manuale utente del modulo sonoro MIDI.

Utenti Mac OS X

■ Installazione del driver

- 1** Scollegare tutti i cavi USB a parte quelli della tastiera e del mouse e riavviare il Macintosh.
- 2** Preparare il CD-ROM.
Inserire il CD nell'unità CD-ROM del computer.
- 3** Nella cartella **Driver (Mac OS X)** del CD-ROM, fare doppio clic su **PCRUSBDriver.pkg**.
In Mac OS X v10.1.5, fare clic sul simbolo del lucchetto per l'autenticazione.
- 4** Nella finestra di dialogo **authentication**, immettere la password e fare clic su **[OK]**.
- 5** Sullo schermo comparirà il seguente messaggio **"Welcome to the EDIROL PCR USB Driver installation"**.
Fare clic su **[Continue]**.
- 6** Verrà visualizzato il seguente messaggio **"Important message"**.
Controllare il contenuto della finestra e fare clic su **[Continue]**.
- 7** Sullo schermo comparirà il messaggio **"Select the location for installation"**.
Selezionare l'unità dove è installato il sistema e fare clic su **[Continue]**.
- 8** Verrà visualizzato il seguente messaggio **"Easy installation"**.
Fare clic su **Install** o **Upgrade**.
- 9** Sullo schermo comparirà il seguente messaggio **"When you install this software, you must restart your computer after the installation is complete"**.
Fare clic su **[Continue installation]**.
- 10** Verrà visualizzato il seguente messaggio **"The software was successfully installed"**.
Fare clic su **[Restart]** per riavviare il Macintosh.

Precauzioni da rispettare quando si utilizza la tastiera PCR

Prima di utilizzare il software sequencer, tenere presente i seguenti punti.

- * *Collegare la tastiera PCR-30/50/80 al computer mediante il cavo USB prima di avviare il software sequencer o altri programmi.*
- * *Non scollegare il cavo USB dalla tastiera PCR-30/50/80 mentre è in esecuzione il software sequencer o un altro programma.*
- * *Scollegare il cavo USB dalla tastiera PCR-30/50/80 solo dopo aver chiuso il sequencer o qualsiasi altro programma utilizzato.*
- * *Non attivare la funzione Sleep del Macintosh.*
- * *La tastiera PCR-30/50/80 non funziona nella configurazione Classic di Mac OS X. Utilizzare la tastiera PCR quando la configurazione Classic non è in esecuzione.*

■ Configurazione del driver

1

Utilizzare il **cavo USB** per collegare la tastiera **PCR-30/50/80** al **computer**.

1. Dopo aver spostato l'interruttore di alimentazione su **OFF**, collegare l'**adattatore AC** alla tastiera **PCR-30/50/80**.
2. Collegare l'**adattatore AC** a una presa elettrica.
3. Utilizzare il **cavo USB** per collegare la tastiera **PCR-30/50/80** al **computer**.

2

Spostare l'**interruttore di alimentazione** della tastiera PCR-30/50/80 in posizione **ON**.

3

Configurare la periferica MIDI sul software sequencer. Per maggiori informazioni sulla **periferica MIDI OUT/IN** da selezionare, fare riferimento alla sezione "**About the ports when using a USB connection**" (pag.159).

La procedura di collegamento della tastiera PCR-30/50/80 al Macintosh, di installazione del driver MIDI e di configurazione del driver è giunta al termine.

MEMO

Per maggiori informazioni sulle impostazioni della periferica MIDI, fare riferimento al manuale del software utilizzato.

English

Deutsch

Français

Italiano

Español

Instalación y configuración del controlador (Windows)

Instalación del controlador

El procedimiento de instalación variará en función del sistema.

Pase a uno de los siguientes apartados, en función del sistema que utilice.

- Usuarios de Windows XP (pág. 94)
- Usuarios de Windows 2000 (pág. 98)
- Usuarios de Windows Me/98 (pág. 101)

■ Usuarios de Windows XP

1

Con la unidad PCR-30/50/80 desconectada, inicie Windows.

Desconecte todos los cables USB excepto el del teclado USB y el ratón USB (si se utilizan).

2

Abra el cuadro de diálogo **Propiedades del sistema**.

1. Haga clic en el menú **Inicio** de Windows y seleccione **Panel de control**.
2. En **“Elija una categoría”**, haga clic en **“Rendimiento y mantenimiento”**.
3. En **“o elija un icono del Panel de control”**, haga clic en el icono **Sistema**.

3

Haga clic en la ficha **Hardware** y, a continuación, en **[Firma del controlador]**.

Abra el cuadro de diálogo **Opciones de firma del controlador**.

4

Asegúrese de que **“¿Qué acción desea que realice Windows?”** esté establecido en **“Omitir”**.

Si ya está establecido en **“Omitir”**, haga clic en **[Aceptar]**.

Si no está en **“Omitir”**, anótese la configuración actual (**“Avisar”** o **“Bloquear”**). A continuación, cambie la configuración a **“Omitir”** y haga clic en **[Aceptar]**.

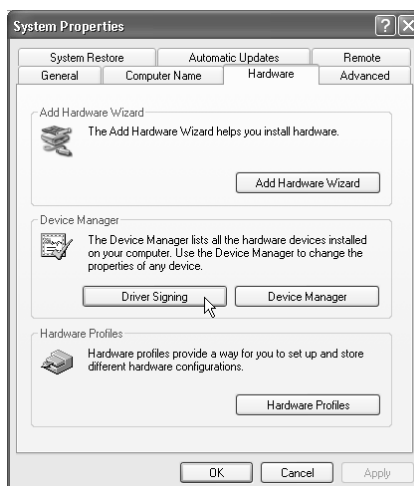

NOTE

Si es usuario de Windows XP Professional, deberá iniciar la sesión con un nombre de usuario con algún tipo de cuenta de administración (por ejemplo, Administrador). Para obtener información detallada acerca de las cuentas de usuario, consulte al administrador de sistemas de su PC.

MEMO

En función de cómo tenga configurado el sistema, puede que el icono **Sistema** aparezca directamente en el **Panel de control** (en la vista Clásica). En ese caso, haga doble clic en el icono **Sistema**.

MEMO

Si ha modificado **“¿Qué acción desea que realice Windows?”** en el **paso 4**, deberá restaurar la configuración anterior después de instalar el controlador.

5 Haga clic en [**Aceptar**] para cerrar el cuadro de diálogo **Propiedades del sistema**.

6 Salga de todo el software que se esté ejecutando (aplicaciones).
Cierre cualquier ventana que esté abierta. Si utiliza un programa antivirus o software similar, también deberá cerrarlo.

7 Prepare el CD-ROM.
Inserte el CD-ROM en la unidad de CD-ROM del PC.

8 Haga clic en el botón **Inicio** de Windows. En el menú que aparecerá, seleccione “**Ejecutar...**”.
Abra el cuadro de diálogo “**Ejecutar...**”.

9 En el cuadro de diálogo que aparece, escriba lo siguiente en el campo “**Abrir**” y haga clic en [**Aceptar**].

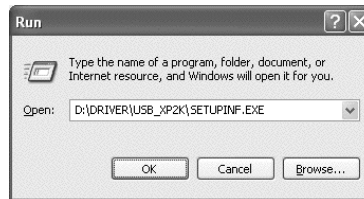

D:\DRIVER\USB_XP2K\SETUPINF.EXE

* *El nombre de la unidad “D:” puede ser diferente para su sistema. Especifique el nombre de su unidad de CD-ROM.*

10 Aparecerá el cuadro de diálogo **SetupInf**.
Ahora puede instalar el controlador.

11 Utilice el **cable USB** para conectar la unidad **PCR-30/50/80** al **PC**.

1. Con el interruptor de alimentación apagado (**OFF**), conecte el **adaptador de CA** a la unidad **PCR-30/50/80**.
2. Conecte el **adaptador de CA** a una toma de corriente eléctrica.
3. Utilice el **cable USB** para conectar la unidad **PCR-30/50/80** al **PC**.

12 Coloque el **interruptor de alimentación** de la unidad **PCR-30/50/80** en la posición **ON** (encendido).

Cerca de la barra de tareas, el PC indicará “**Nuevo hardware encontrado**”. Espere, por favor.

MEMO

Una vez completadas las conexiones, encienda los diferentes aparatos en el orden especificado. Si enciende los aparatos en un orden incorrecto, podrían producirse anomalías en el funcionamiento o daños en los altavoces y otros aparatos.

MEMO

Esta unidad viene equipada con un circuito de protección. Es necesario dejar pasar un pequeño intervalo (unos segundos) después de encender la unidad para que ésta funcione correctamente.

13 Aparecerá el **Asistente para hardware nuevo encontrado**.

Asegúrese de que la pantalla indique **“EDIROL PCR”**, seleccione **“Instalar desde una lista o ubicación específica (avanzado)”** y haga clic en **[Siguiente]**.

14 La pantalla indicará **“Elija sus opciones de búsqueda e instalación”**.

Seleccione **“No buscar. Seleccionaré el controlador que se va a instalar”** y haga clic en **[Siguiente]**.

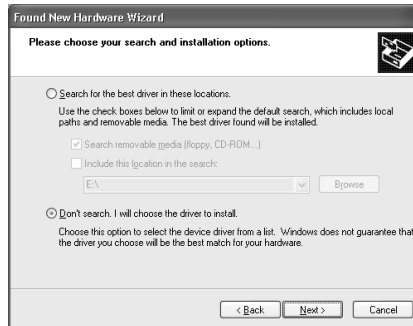

15 Asegúrese de que el campo **“Modelo”** indique **“EDIROL PCR”**, y haga clic en **[Siguiente]**. Entonces empezará la instalación del controlador.

Si el valor de **“¿Qué acción desea que realice Windows?”** no se ha establecido en **“Omitir”**, aparecerá el cuadro de diálogo **“Instalación de hardware”**.

Si la opción “¿Qué acción desea que realice Windows?” está establecida en “Avisar”:

1. Haga clic en **[Continuar]**.
2. Prosiga con la instalación.

Si la opción “¿Qué acción desea que realice Windows?” está establecida en “Avisar”:

1. Haga clic en **[Aceptar]**.
2. Cuando aparezca **“Asistente para hardware nuevo encontrado”**, haga clic en **[Finalizar]**.
3. Efectúe la instalación tal como se describe en el apartado **“Resolución de problemas”** del apartado **Device Manager shows “?”, “!”, or “USB Composite Device”** (pág. 172).

16 Aparecerá el cuadro de diálogo **Insertar disco**.

Haga clic en **[Aceptar]**.

17 Aparecerá el cuadro de diálogo **Archivos necesarios**.

Especifique lo siguiente en el campo **“Copiar archivos de”** y haga clic en **[Aceptar]**.

D:\Driver\USB_XP2K

** El nombre de la unidad **“D:”** puede ser diferente para su sistema. Especifique el nombre de la unidad de CD-ROM.*

MEMO

Puede que el cuadro de diálogo **Insertar disco** no aparezca. En ese caso, vaya al **paso 17**.

18 Aparecerá el **Asistente para hardware nuevo encontrado**.

Asegúrese de que la pantalla indica “**EDIROL PCR**” y haga clic en **[Finalizar]**. Espere hasta que aparezca “**Nuevo hardware encontrado**” cerca de la barra de tareas.

19 Una vez finalizada la instalación del controlador, aparecerá el cuadro de diálogo **Cambio de configuración del sistema**.

Haga clic en **[Sí]**. Windows se reiniciará automáticamente.

Si ha modificado “¿Qué acción desea que realice Windows?”

Si ha modificado el valor para “¿Qué acción desea que realice Windows?” restaure la configuración original después de reiniciar Windows.

1. Si es usuario de **Windows XP Professional**, debe iniciar la sesión de Windows utilizando un nombre de usuario con algún tipo de **cuenta de administración** (Administrador, por ejemplo).
 2. Haga clic en el menú **Inicio** de Windows y seleccione **Panel de control**.
 3. En “**Elija una categoría**”, haga clic en “**Rendimiento y mantenimiento**”.
 4. En “**o elija un icono del Panel de control**”, haga clic en el icono **Sistema**. Aparecerá el cuadro de diálogo **Propiedades del sistema**.
- * *En función de cómo tenga configurado el sistema, puede que el icono **Sistema** aparezca directamente en el **Panel de control** (en la vista *Clásica*). En ese caso, haga doble clic en el icono **Sistema**.*
5. Haga clic en la ficha **Hardware** y, a continuación, en **[Firma del controlador]**. Aparecerá el cuadro de diálogo **Opciones de firma del controlador**.
 6. Restablezca el valor de **¿Qué acción desea que realice Windows?** al valor original (“**Advertir**” o “**Bloquear**”) y haga clic en **[Aceptar]**.
 7. Haga clic en **[Aceptar]**. El cuadro de diálogo **Propiedades del sistema** se cerrará.

A continuación, deberá configurar el controlador.
 (→ **Destinos de entrada y salida MIDI** (pág. 103))

■ Usuarios de Windows 2000

- 1 Con la unidad PCR-30/50/80 desconectada, inicie Windows.
Desconecte todos los cables USB excepto el del teclado USB y el ratón USB (si se utilizan).
- 2 Inicie Windows con un **usuario con privilegios administrativos** (como Administrador).
- 3 Abra el cuadro de diálogo **Propiedades del sistema**.
Haga clic en el botón **Inicio** y, en el menú que aparecerá, seleccione **Configuración | Panel de control**. En **Panel de control**, haga doble clic en el icono **Sistema**.

- 4 Haga clic en la ficha **Hardware** y, a continuación, en [**Firma del controlador**].
Abra el cuadro de diálogo **Opciones de firma del controlador**.

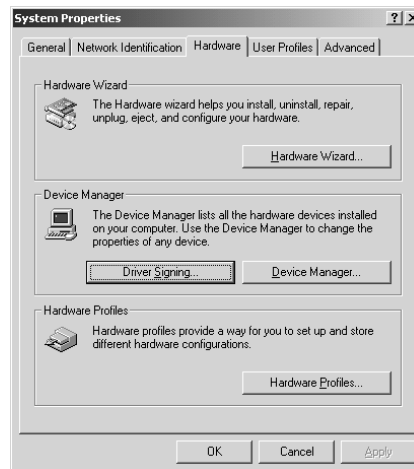

- 5 Asegúrese de establecer **“Verificación de la firma de archivo”** en **“Omitir”**.
Si ya está establecido en **“Omitir”**, haga clic en [**Aceptar**].
Si no está establecido en **“Omitir”**, anote el valor actual (**“Avisar”** o **“Bloquear”**). A continuación, cambie la configuración a **“Omitir”** y haga clic en [**Aceptar**].

- 6 Cierre el cuadro de diálogo **Propiedades del sistema**.
Haga clic en [**Aceptar**].

- 7 Salga de todo el software que se esté ejecutando (aplicaciones).
Cierre cualquier ventana que esté abierta. Si utiliza un programa antivirus o software similar, también deberá cerrarlo.

- 8 Prepare el CD-ROM.
Inserte el CD-ROM en la unidad de CD-ROM del PC.

MEMO

Si ha cambiado el valor **“Verificación de la firma del archivo”** en el **paso 5**, deberá restaurar la configuración anterior después de instalar el controlador.

9

Haga clic en el botón **Inicio** de Windows. En el menú que aparecerá, seleccione **“Ejecutar...”**.

Abra el cuadro de diálogo **“Ejecutar...”**.

10

En el cuadro de diálogo que aparecerá, escriba lo siguiente en el campo **“Abrir”** y haga clic en **[Aceptar]**.

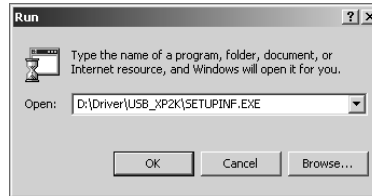

D:\DRIVER\USB_XP2K\SETUPINF.EXE

* El nombre de la unidad **“D:”** puede ser diferente para su sistema. Especifique el nombre de la unidad de CD-ROM.

11

Aparecerá el cuadro de diálogo **SetupInf**.

Ahora puede instalar el controlador.

12

Utilice el **cable USB** para conectar la unidad **PCR-30/50/80** al **PC**.

1. Con el interruptor de alimentación apagado (**OFF**), conecte el **adaptador de CA** a la unidad **PCR-30/50/80**.
2. Conecte el **adaptador de CA** a una toma de corriente eléctrica.
3. Utilice el **cable USB** para conectar la unidad **PCR-30/50/80** al **PC**.

13

Coloque el **interruptor de alimentación** de la unidad **PCR-30/50/80** en la posición **ON** (encendido).

MEMO

Una vez completadas las conexiones, encienda los diferentes aparatos en el orden especificado. Si enciende los aparatos en un orden incorrecto, podrían producirse anomalías en el funcionamiento o daños en los altavoces y otros aparatos.

MEMO

Esta unidad viene equipada con un circuito de protección. Es necesario dejar pasar un pequeño intervalo (unos segundos) después de encender la unidad para que ésta funcione correctamente.

Si la configuración de **“Verificación de la firma del archivo”** no se ha establecido en **“Omitir”**, aparecerá el cuadro de diálogo **“No se ha encontrado la firma digital”**.

Si “Verificación de la firma del archivo” está establecida en “Avisar”:

1. Haga clic en **[Sí]**.
2. Prosiga con la instalación.

Si “Verificación de la firma del archivo” está establecido en “Bloquear”:

1. Haga clic en **[Aceptar]**.
2. Cuando aparezca **“Asistente para hardware nuevo encontrado”**, haga clic en **[Finalizar]**.
3. Efectúe la instalación tal como se describe en el apartado **“Resolución de problemas”** del apartado **Device Manager shows “?”, “!”, or “USB Composite Device”** (pág. 172).

14 Aparecerá el cuadro de diálogo **Insertar disco**.
Haga clic en **[Aceptar]**.

15 Aparecerá el cuadro de diálogo **Archivos necesarios**.
Especifique lo siguiente en el campo “**Copiar archivos de**” y haga clic en **[Aceptar]**.

D:\Drivers\USB_XP2K

* El nombre de la unidad “**D:**” puede ser diferente para su sistema. Especifique el nombre de la unidad de CD-ROM.

16 Es posible que aparezca el “**Asistente para hardware nuevo encontrado**”.
Compruebe que “**EDIROL PCR**” aparece en pantalla y haga clic en **[Finalizar]**.

17 Puede que aparezca el cuadro de diálogo **Cambio de configuración del sistema**.
Haga clic en **[Sí]**. Windows se reiniciará automáticamente.



Si no aparece el cuadro de diálogo **Insertar disco**, consulte el apartado **The “Insert Disk” dialog box does not appear** (pág. 171).

Si ha cambiado “Verificación de la firma del archivo”

Si ha modificado el valor de “Verificación de la firma del archivo”, restaure el valor original después de que se reinicie Windows.

1. Una vez se haya reiniciado Windows, inicie la sesión de Windows como un usuario con **privilegios de administración** (como por ejemplo Administrador).
2. En el escritorio de Windows, haga clic con el botón secundario del ratón en el icono **Mi PC** y, en el menú que aparecerá, seleccione **Propiedades**. Aparecerá el cuadro de diálogo **Propiedades del sistema**.
3. Haga clic en la ficha **Hardware** y, a continuación, haga clic en **[Firma del controlador]**. Aparecerá el cuadro de diálogo **Opciones de firma del controlador**.
4. Vuelva a establecer la configuración original de “**Verificación de firma del controlador**” (ya sea “**Avisar**” o “**Bloquear**”) y haga clic en **[Aceptar]**.
5. Haga clic en **[Aceptar]**. El cuadro de diálogo **Propiedades del sistema** se cerrará.

A continuación, deberá configurar el controlador.
(→ **Destinos de entrada y salida MIDI** (pág. 103))

■ Usuarios de Windows Me/98

- 1 Con la unidad PCR-30/50/80 desconectada, inicie Windows.
Desconecte todos los cables USB excepto el del teclado USB y el ratón USB (si se utilizan).
- 2 Salga de todo el software que se esté ejecutando (aplicaciones).
Cierre cualquier ventana que esté abierta. Si utiliza un programa antivirus o software similar, también deberá cerrarlo.
- 3 Prepare el CD-ROM.
Inserte el CD-ROM en la unidad de CD-ROM del PC.
- 4 Haga clic en el botón **Inicio** de Windows. En el menú que aparecerá, seleccione **“Ejecutar...”**.
Abra el cuadro de diálogo **“Ejecutar...”**.

- 5 En el cuadro de diálogo que aparecerá, escriba lo siguiente en el campo **“Abrir”** y haga clic en **[Aceptar]**.



D:\Driver\USB_ME98\SETUPINF.EXE

** El nombre de la unidad “D:” puede ser diferente para su sistema. Especifique el nombre de la unidad de CD-ROM.*

- 6 Aparecerá el cuadro de diálogo **SetupInf**.
Ahora puede instalar el controlador.

7

Utilice el **cable USB** para conectar la unidad **PCR-30/50/80** al **PC**.

1. Con el interruptor de alimentación apagado (**OFF**), conecte el **adaptador de CA** a la unidad **PCR-30/50/80**.
2. Conecte el **adaptador de CA** a una toma de corriente eléctrica.
3. Utilice el **cable USB** para conectar la unidad **PCR-30/50/80** al **PC**.

8

Coloque el **interruptor de alimentación** de la unidad PCR-30/50/80 en la posición **ON** (encendido).

9

El controlador se instalará automáticamente.

10

En el cuadro de diálogo, haga clic en [Aceptar].

- * *Si aparece un mensaje que le recomienda que reinicie Windows, reinicie el sistema operativo como se le indica.*

NOTE

Una vez completadas las conexiones, encienda los diferentes aparatos en el orden especificado. Si enciende los aparatos en un orden incorrecto, podrían producirse anomalías en el funcionamiento o daños en los altavoces y otros aparatos.

MEMO

Esta unidad viene equipada con un circuito de protección. Es necesario dejar pasar un pequeño intervalo (unos segundos) después de encender la unidad para que ésta funcione correctamente.

A continuación, deberá configurar el controlador.
(→ **Destinos de entrada y salida MIDI** (pág. 103))

Configuración

■ Destinos de entrada y salida MIDI

Usuarios de Windows XP/2000/Me

1

Abra el **Panel de control**.

Haga clic en el botón **Inicio** y, en el menú que aparecerá, seleccione **Configuración | Panel de control**.

Windows XP

Haga clic en el botón **Inicio** de Windows y, en el menú que aparecerá, seleccione **Panel de control**.

2

Abra el cuadro de diálogo **Propiedades de sonidos y dispositivos de audio** (o **Propiedades de sonidos y multimedia**, en Windows 2000 o ME).

Windows XP

En “**Elija una categoría**”, haga clic en “**Dispositivos de sonido, audio y voz**”. A continuación, en “**o elija un icono del Panel de control**”, haga clic en el icono **Dispositivos de sonido y audio**.

Windows 2000/Me

En **Panel de control**, haga doble clic en el icono **Sonidos y multimedia** para abrir el cuadro de diálogo “**Propiedades de sonidos y multimedia**”.

3

Haga clic en la ficha **Audio**.

4

Para la **reproducción de música MIDI**, haga clic en ▼ que aparece a la derecha de **[Dispositivo predeterminado]** (o **[Dispositivo preferido]** en Windows 2000/Me) y seleccione el dispositivo MIDI en la lista que aparece.

Para utilizar Media Player para reproducir el audio de un módulo de sonido conectado al conector MIDI OUT del PCR, seleccione **EDIROL PCR MIDI OUT**.

5

Cierre el cuadro de diálogo **Propiedades de sonidos y dispositivos de audio**.

Haga clic en **Aceptar** para finalizar la configuración.

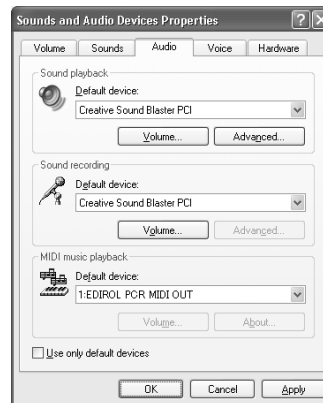

MEMO

En función de cómo tenga configurado el sistema, puede que el icono **Dispositivos de sonido y audio** aparezca directamente en el **Panel de control** (en la vista Clásica). En ese caso, haga doble clic en el icono **Dispositivos de sonido y audio**.

MEMO

Seleccione el dispositivo MIDI apropiado para el sistema. No tiene por qué seleccionar necesariamente **EDIROL PCR MIDI OUT**.

MEMO

Para obtener más información, consulte el apartado “**About the ports when using a USB connection**” (pág. 159).

- 6 Configure el dispositivo MIDI en el software secuenciador. Para obtener información sobre el **dispositivo MIDI OUT/IN** que debe seleccionar, consulte el apartado **About the ports when using a USB connection** (pág. 159).

Con esto finaliza la configuración del controlador.

Usuarios de Windows 98

- 1 Abra el **Panel de control**.
Haga clic en el botón **Inicio** y, en el menú que aparecerá, seleccione **Configuración | Panel de control**.
- 2 Abra el cuadro de diálogo **Propiedades multimedia**.
En **Panel de control**, haga doble clic en el icono **Multimedia** para abrir el cuadro de diálogo **Propiedades multimedia**.

- 3 Haga clic en la ficha **MIDI**.

- 4 Especifique la **“Salida de MIDI”**.
Seleccione **[Instrumento único]** y seleccione el dispositivo MIDI en la lista que aparece.

Para utilizar Media Player para reproducir el audio de un módulo de sonido conectado al conector MIDI OUT del PCR, seleccione **EDIROL PCR PCR MIDI OUT**.

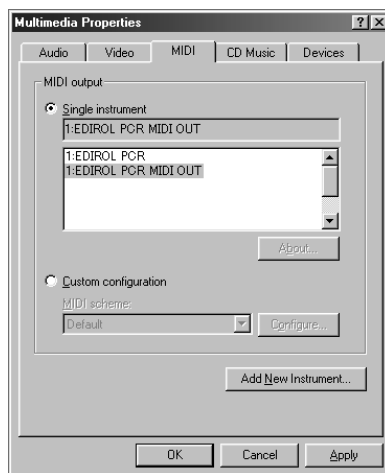

- 5 Cierre el cuadro de diálogo **Propiedades multimedia**.
Haga clic en **Aceptar** para finalizar la configuración.

- 6 Configure el dispositivo MIDI en el software secuenciador. Para obtener información sobre el **dispositivo MIDI OUT/IN** que debe seleccionar, consulte el apartado **“About the ports when using a USB connection”** (pág. 159).

Con esto finaliza la configuración del controlador.

MEMO

Si desea obtener detalles sobre la configuración de dispositivos MIDI, consulte el manual del usuario que se adjunta con el software.

MEMO

Seleccione el dispositivo MIDI apropiado para el sistema. No tiene por qué seleccionar necesariamente **EDIROL PCR MIDI OUT**.

MEMO

Para obtener más información, consulte el apartado **“About the ports when using a USB connection”** (pág. 159).

MEMO

Si desea obtener detalles sobre la configuración de dispositivos MIDI, consulte el manual del propietario que se adjunta con el software que esté utilizando.

Instalación y configuración del controlador (Macintosh)

The installation procedure will differ depending on your system.

Please proceed to one of the following sections, depending on the system you use.

- Mac OS 9/8 users (pág. 105)
- Mac OS X users (pág. 105)

Usuarios de Mac OS 9/8

■ Instalación del controlador

Utilice OMS o FreeMIDI como controlador MIDI.

El controlador del PCR-30/50/80 que se incluye es un módulo adicional para utilizar el PCR-30/50/80 con OMS o FreeMIDI.

* *Debe instalar OMS o FreeMIDI en su Macintosh, según el software secuenciador que vaya a utilizar.*

Lleve a cabo el siguiente procedimiento para instalar el controlador del PCR-30/50/80.

* *Desconecte el PCR-30/50/80 del Macintosh antes de realizar la instalación.*

Si el PCR-30/50/80 está encendido, al iniciarse el Macintosh aparecerá un mensaje como el siguiente. Realice los pasos que se describen a continuación según el mensaje que se muestre.

Si la pantalla indica:

“Driver required for USB device ‘unknown device’ is not available. Search for driver on the Internet?” → Haga clic en [Cancel].

Si la pantalla indica:

“Software required for using device ‘unknown device’ cannot be found. Please refer to the manual included with the device, and install the necessary software” → Haga clic en [OK].

MEMO

OMS se encuentra en la carpeta **OMS 2.3.8 E** dentro de la carpeta **OMS** del CD-ROM. Si desea obtener más información sobre OMS, consulte el manual en línea **OMS_2.3_Mac.pdf** en la carpeta **OMS2.3.8E** que se encuentra dentro de la carpeta **OMS** del CD-ROM.

- 1 Salga de todo el software que se esté ejecutando (aplicaciones).
Si utiliza un programa antivirus o software similar, también debe cerrarlo.
- 2 Prepare el CD-ROM.
Inserte el CD-ROM en la unidad de CD-ROM.
- 3 Haga doble clic en el icono **PCR Driver-E Installer** (que se encuentra en la carpeta **Driver E (Mac OS 9, 8)** del CD-ROM) para iniciar el programa de instalación.
- 4 Verifique la **ubicación de la instalación** y haga clic en **[Install]**.
- 5 Si aparece un mensaje como el siguiente, haga clic en **[Continue]**.
Saldrá de todas las aplicaciones que se estén ejecutando y proseguirá con la instalación.
- 6 Aparecerá un cuadro de diálogo que indicará **Installation completed**.
Haga clic en **[Restart]** para reiniciar el Macintosh.

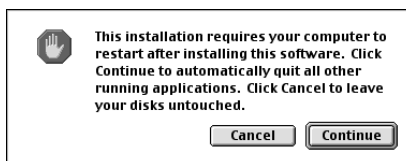

■ Configuración

Configuración de OMS

- 1 Utilice el **cable USB** para conectar el **PCR-30/50/80** al **PC**.
 1. Con el interruptor de alimentación en **OFF**, conecte el **adaptador de CA** al **PCR-30/50/80**.
 2. Conecte el **adaptador de CA** a una toma de corriente eléctrica.
 3. Utilice el **cable USB** para conectar el **PCR-30/50/80** al **PC**.
- 2 Disponga el **interruptor de alimentación** del PCR-30/50/80 en la posición **ON**.
- 3 En el CD-ROM, arrastre la carpeta **Driver E (Mac OS 9, 8) - OMS Setting** al disco duro del Macintosh para copiarla.



MEMO

Establecidas las conexiones, encienda los diferentes dispositivos en el orden especificado. Si enciende los dispositivos en un orden incorrecto, puede causar anomalías en el funcionamiento o daños en los altavoces y otros aparatos.

MEMO

Asegúrese siempre de tener bajado el volumen antes de encender la unidad. Aunque tenga el volumen completamente bajado, puede que oiga algún sonido al encender la unidad, pero esto es algo normal y no es indicio de un mal funcionamiento.

- 4** En la carpeta **Opcode-OMS Application** donde ha instalado OMS, haga doble clic en **OMS Setup** para iniciarlo.



- 5** Si aparece un cuadro de diálogo como éste, haga clic en **[Turn It Off]**. Aparecerá un cuadro de diálogo de confirmación; haga clic en **[OK]**.

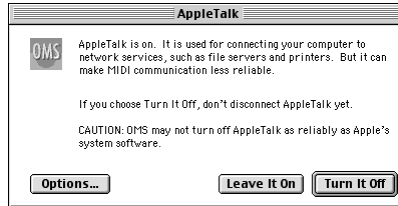

Es conveniente desactivar **AppleTalk**, seleccionando **Chooser** en el menú **Apple**.

- 6** Aparecerá el cuadro de diálogo **Create a New Studio Setup**. Haga clic en **[Cancel]**. Si, por error, hace clic en **[OK]**, haga clic en **[Cancel]** en la siguiente pantalla.

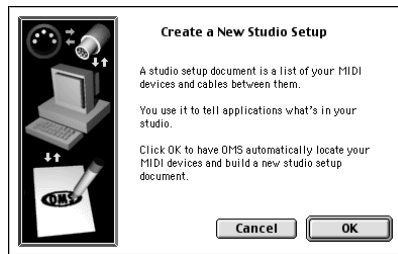

- 7** Elija **"Open"** en el menú **File**. En la carpeta **Setting** que ha copiado en el **paso 3**, seleccione el archivo **PCR** y haga clic en **[Open]**. Aparecerá una pantalla como ésta.

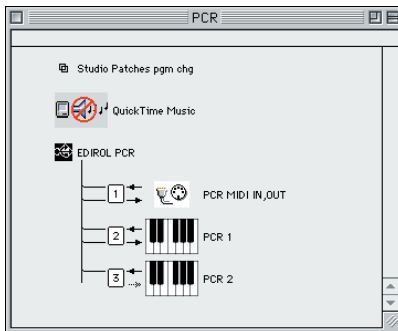

- 8** En el menú **Edit**, seleccione **OMS MIDI Setup**. En el cuadro de diálogo **OMS MIDI Setup** que aparece, marque **Run MIDI in background** y haga clic en **[OK]**.

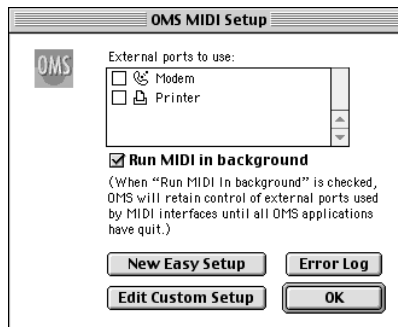

9

En el menú **File**, elija **Make Current**.

Si no puede seleccionar **Make Current**, significa que ya se ha aplicado y puede continuar por el siguiente paso.

A diamond mark (◊) indicate in the settings are enabled.

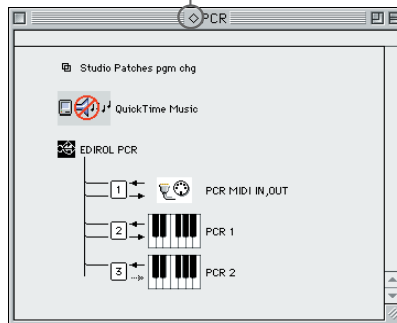

10

Compruebe que la transmisión y la recepción MIDI se realicen correctamente. En el menú **Studio**, seleccione **Test Studio**.

11

Pruebe de tocar el teclado del PCR-30/50/80. Si la flecha al lado del número 2 ó 3 del diagrama de la derecha parpadea, significa que los ajustes se han realizado correctamente. Cuando mueva el cursor del mouse cerca del icono del conector MIDI, el cursor cambiará a sostenido (nota musical).

Si un módulo de sonido MIDI se conecta al conector MIDI OUT del PCR-30/50/80, pulse el icono del conector MIDI mostrado en el diagrama de la derecha. Si escucha sonido, los ajustes se han realizado correctamente.

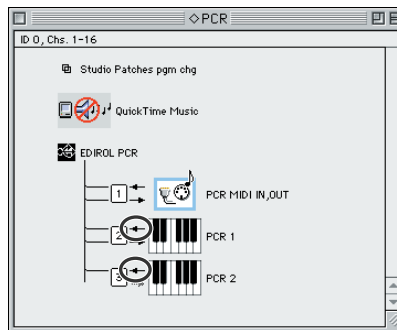

MEMO

Para obtener información sobre cómo conectar un módulo de sonido MIDI, consulte el manual del usuario de su módulo de sonido MIDI.

12

Salga de **OMS Setup**.

En el menú **File**, elija **[Exit]**. Si aparece el cuadro de diálogo **AppleTalk confirmation**, haga clic en **[OK]** para cerrarlo.

Con esto, habrá completado todos los pasos necesarios para conectar el PCR-30/50/80 al Macintosh, instalar el controlador MIDI y efectuar la configuración del controlador.)

Configuración de FreeMIDI

- 1 Utilice el **cable USB** para conectar el **PCR-30/50/80** al **PC**.
 1. Con el interruptor de alimentación en **OFF**, conecte el **adaptador de CA** al **PCR-30/50/80**.
 2. Conecte el **adaptador de CA** a una toma de corriente eléctrica.
 3. Utilice el **cable USB** para conectar el **PCR-30/50/80** al **PC**.
- 2 Disponga el **interruptor de alimentación** del **PCR-30/50/80** en la posición **ON**.
- 3 Desde el CD-ROM, copie la carpeta **Driver E (Mac OS 9, 8) - FreeMIDI Setting** en el disco duro del Macintosh.
- 4 Abra la carpeta **FreeMIDI Applications** desde la ubicación en la que ha instalado FreeMIDI y haga doble clic en el icono **FreeMIDI Setup** para iniciarlo.
- 5 Cuando aparezca **"OMS is installed on this computer..."**, haga clic en **[FreeMIDI]**.
- 6 La primera vez que inicie el software, aparecerá el cuadro de diálogo **"Welcome to FreeMIDI!"**. Haga clic en **[Continue]**.
- 7 Cuando aparezca el cuadro de diálogo **FreeMIDI Preferences**, haga clic en **[Cancel]**.
- 8 Cuando aparezca el cuadro de diálogo **About Quick Setup**, haga clic en **[Cancel]**.
- 9 En el menú **File**, elija **Open**.
- 10 Seleccione **PCR** en la carpeta **FreeMIDI Setting** que ha copiado en el **paso 3** y haga clic en **[Open]**.
- 11 Compruebe que la transmisión y la recepción MIDI se realicen correctamente. En el menú **MIDI**, seleccione **Check Connections**.

MEMO

Establecidas las conexiones, encienda los diferentes dispositivos en el orden especificado. Si enciende los dispositivos en un orden incorrecto, puede causar anomalías en el funcionamiento o daños en los altavoces y otros aparatos.

MEMO

Asegúrese siempre de tener bajado el volumen antes de encender la unidad. Aunque tenga el volumen completamente bajado, puede que oiga algún sonido al encender la unidad, pero esto es algo normal y no es indicio de un mal funcionamiento.

- 12** Si un módulo de sonido MIDI se conecta al conector MIDI OUT del PCR-30/50/80, pulse el icono del conector MIDI mostrado en el diagrama de la derecha. Si escucha sonido, los ajustes se han realizado correctamente.

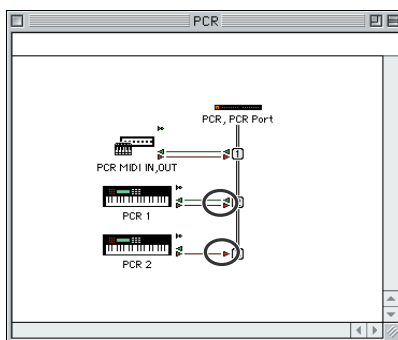

MEMO

Para obtener información sobre cómo conectar un módulo de sonido MIDI, consulte el manual del usuario de su módulo de sonido MIDI.

- 13** Vuelva a elegir el comando **Check Connections** del menú **MIDI** para finalizar la prueba.

- 14** En el menú **File**, seleccione **Quit** para salir de **FreeMIDI Setup**.

Con esto, habrá completado todos los pasos necesarios para conectar el PCR-30/50/80 al Macintosh, instalar el controlador MIDI y efectuar la configuración del controlador.)

Usuarios de Mac OS X

■ Instalación del controlador

- 1** Desconecte todos los cables USB que no sean del teclado o del ratón y reinicie el sistema Macintosh.
- 2** Prepare el CD-ROM.
Inserte el CD-ROM en la unidad de CD-ROM del sistema.
- 3** En la carpeta **Driver (Mac OS X)** del CD-ROM, haga doble clic en **PCRUSBDriver.pkg**.
En Mac OS X v10.1.5, haga clic en el símbolo de bloqueo para la autenticación.
- 4** En el cuadro de diálogo de **authentication** (autenticación), escriba la contraseña y haga clic en **[OK]** (Aceptar).

5 La pantalla indicará **“Welcome to EDIROL PCR USB Driver installation”** (Bienvenido a la instalación del controlador USB del PCR de Edirol).
Haga clic en **[Continue]** (Continuar).

6 La pantalla indicará **“Important message”** (Mensaje importante).
Lea su contenido y haga clic en **[Continue]** (Continuar).

7 La pantalla indicará **“Select the location for installation”** (Seleccione la ubicación de instalación).
Seleccione la unidad en la que esté instalado el sistema operativo haciendo clic sobre la misma y, a continuación, haga clic en **[Continue]** (Continuar).

8 La pantalla indicará **“Easy installation”** (Instalación fácil).
Haga clic en **Install** (Instalar) o **Upgrade** (Actualizar).

9 La pantalla indicará **“When you install this software, you must restart your computer after the installation is complete”** (Al instalar el software, debe reiniciar el sistema una vez finalizada la instalación).
Haga clic en **[Continue installation]** (Continuar la instalación).

10 La pantalla indicará **“The software was successfully installed”** (El software se ha instalado correctamente).
Haga clic en **[Restart]** (Reiniciar) para reiniciar el sistema.

Precauciones al utilizar el PCR

Antes de utilizar el software secuenciador, tenga en cuenta los siguientes aspectos:

- * *Conecte el PCR-30/50/80 al sistema mediante un cable USB antes de iniciar el software secuenciador u otro software.*
- * *No desconecte el cable USB del PCR-30/50/80 mientras se esté ejecutando el software secuenciador u otro software.*
- * *Desconecte el cable USB del PCR-30/50/80 sólo después de haber salido del software secuenciador u otro software.*
- * *Deje la función Sleep del Macintosh desactivada.*
- * *El PCR-30/50/80 no funcionará en el entorno Classic de Mac OS X. Utilice el PCR cuando no se esté ejecutando el entorno Classic.*

■ Configuración del controlador

1

Utilice el **cable USB** para conectar el **PCR-30/50/80** al **sistema**.

1. Con el interruptor **POWER** apagado (**OFF**), conecte el **adaptador de CA** al **PCR-30/50/80**.
2. Conecte el **adaptador de CA** a una toma de corriente eléctrica.
3. Utilice el **cable USB** para conectar el **PCR-30/50/80** al **sistema**.

2

Coloque el **Interruptor POWER** del **PCR-30/50/80** en la posición **ON** (encendido).

3

Configure el dispositivo **MIDI** en el software secuenciador. Para obtener más información sobre el **aparato MIDI de entrada/salida** que debe seleccionar, consulte el apartado “**About the ports when using a USB connection**” (pág. 159).

Con esto se finaliza el procedimiento para conectar el **PCR-30/50/80** al sistema Macintosh, instalar el controlador **MIDI** y configurar el controlador.

MEMO

Si desea obtener detalles sobre la configuración de aparatos **MIDI**, consulte el manual del usuario para el software que esté utilizando.

Operation

The PCR-30/50/80 is a controller that transmits MIDI messages. You cannot perform using only the PCR-30/50/80 by itself. You will need to connect it to a sound module or computer.

The various controllers ([R1--R8], [S1--S8], [B1--B6], [L1--L3], [P1, P2]) can be assigned almost any message you want to get the control you need for your particular setup. For details on the messages that can be assigned, refer to “**Controller settings**” (p. 126).

Connection and MIDI data flow

This section explains how to make basic connections for the PCR-30/50/80.

- * *To prevent malfunction and/or damage to speakers or other devices, always turn down the volume, and turn off the power on all devices before making any connections.*
- * *Use only the specified expression pedal (EV-5; sold separately). By connecting any other expression pedals, you risk causing malfunction and/or damage to the unit.*

When using MIDI connections

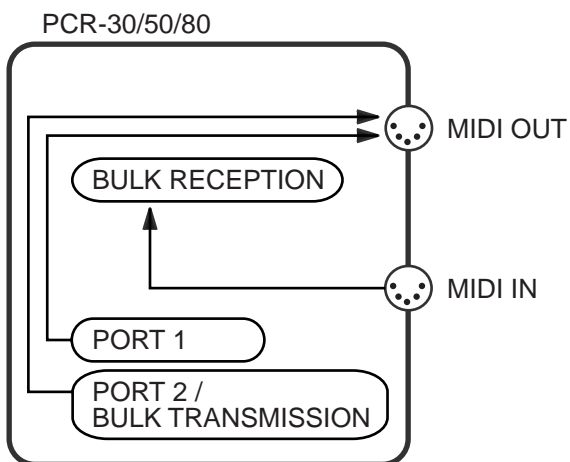
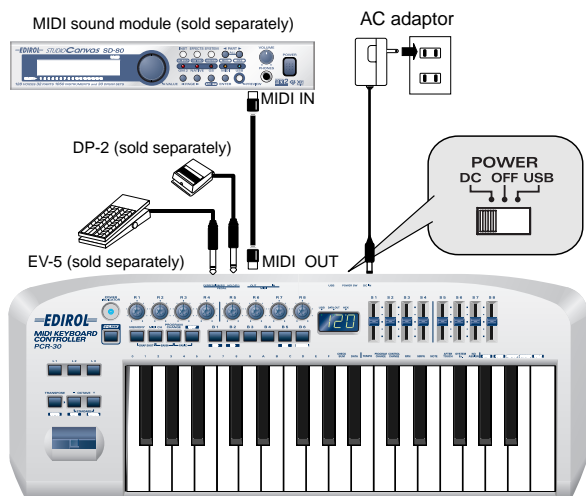

- * *For an explanation of the items in the diagram, refer to “About the ports when using a USB connection” (p. 159).*

When using a USB connection

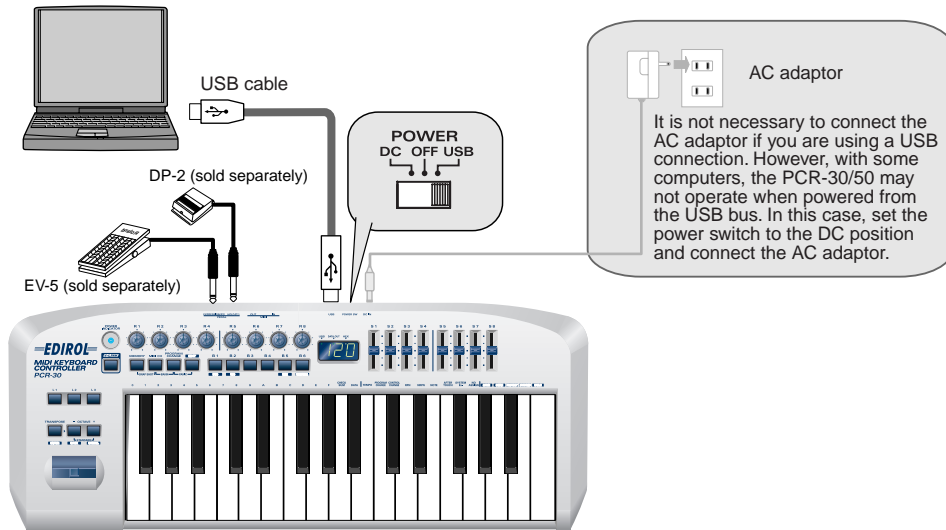

V-LINK OFF

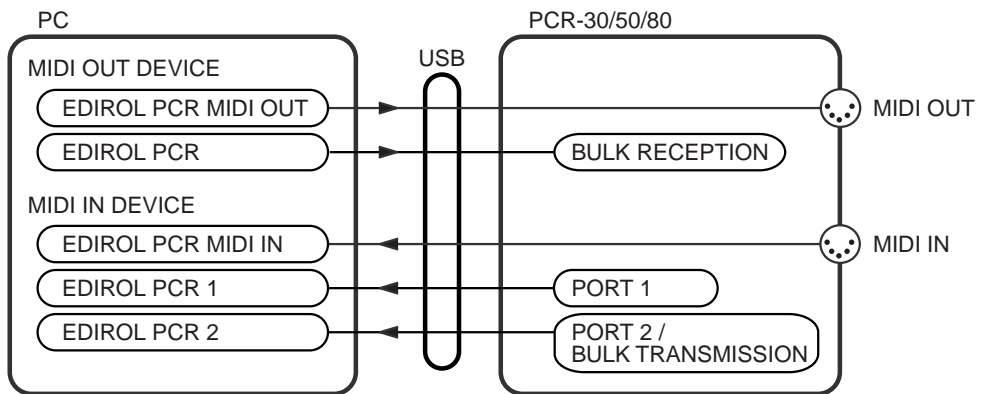

V-LINK ON

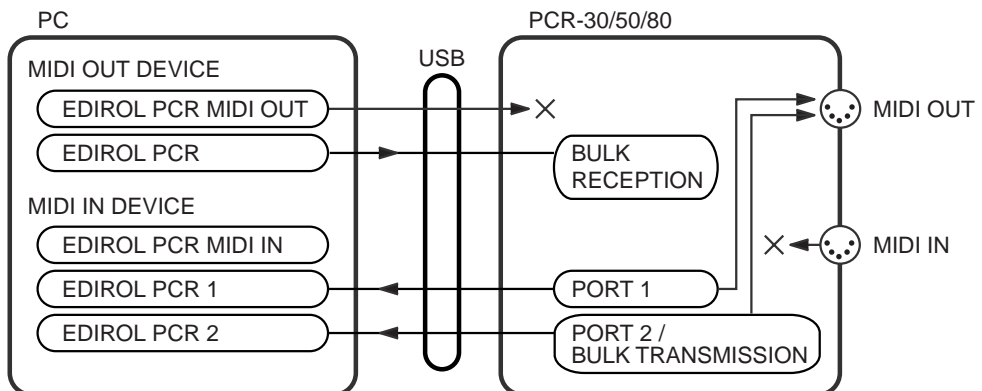



* If V-LINK is ON, PCR 1 and PCR 2 messages will be sent both to USB and to the MIDI connector.

* For an explanation of the items in the diagram, refer to "About the ports when using a USB connection" (p. 159).

Basic operation

How to switch modes

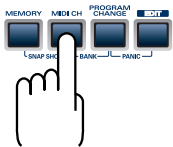
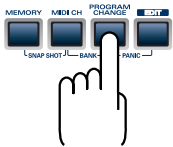
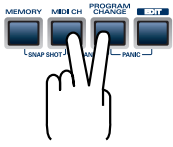
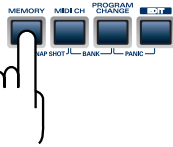
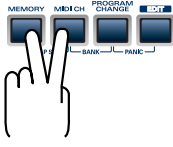
You can switch modes at any time, as shown below.

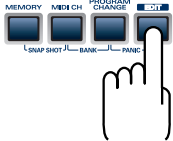
Mode	Switching modes	Explanation
PLAY mode (p. 117)	When you turn on the power, the PCR-30/50/80 will start up in PLAY mode.	Transmit MIDI messages by playing the keyboard or operating the controllers.
MIDI Channel mode (MIDI CH) (p. 118)	Press the [MIDI CH] button. 	Set the transmit channel (current channel) for the keyboard and bender lever.
Program Change mode (PROGRAM CHANGE) (p. 119)	Press the [PROGRAM CHANGE] button. 	Transmit program change messages on the current channel.
Bank mode (BANK) (p. 120)	Simultaneously press the [PROGRAM CHANGE] button and [MIDI CH] button. 	Transmit bank select messages (MSB, LSB) on the current channel.
Memory mode (MEMORY) (p. 121)	Press the [MEMORY] button. 	Recall a memory set from internal memory into the current memory (p. 136).
Snapshot mode (SNAPSHOT) (p. 122)	Simultaneously press the [MEMORY] button and the [MIDI CH] button. 	Transmit the current values of all controllers ([R1--R8], [S1--S8]) at once.
Panic mode (PANIC) (p. 123)	Simultaneously press the [PROGRAM CHANGE] button and the [EDIT] button. 	Stop "stuck" notes or other problems with the sound on a connected MIDI sound module.
Edit mode (EDIT) (p. 125)	Press the [EDIT] button. 	Assign MIDI messages to the controllers, transmit/receive bulk data, or make system settings.

You are returned to Play mode once a setting or a process has been completed within the other modes. If you want to return to Play mode without completing a setting or operation, press the button for the current mode (i.e., the button that is lit). Alternatively, press the **[CANCEL]** button. The setting you were in the process of making will be discarded.

PLAY mode

When you power up the PCR-30/50/80, it will start up in PLAY mode. The display will show the current channel (p. 118).

- * The PCR-30/50/80 will start up according to the Startup Memory settings (p. 164). With the factory settings, it will start up with the GM2 MEMORY. For the messages that are assigned to each controller by the GM2 MEMORY, refer to p. 164.

■ Controllers you can operate

[R1–R8], [S1–S8], [B1–B6] [L1–L3], [P1, P2]	These controllers will transmit the messages that are assigned to each. * The transmitted value will be shown in the display.
[OCTAVE +/-]	Octave shift * [OCTAVE -] or [OCTAVE +] will light depending on the current octave shift setting. The actual octave shift value will appear in the display only while you are editing the setting (-4-5).
[TRANSPOSE]+[OCTAVE +/-]	Transpose * If you hold down [TRANSPOSE] for a while, [OCTAVE -] or [OCTAVE +] will light depending on the current transpose setting. The actual transpose value will appear in the display only while you are editing the setting (-12-12).
Bender lever	Bender or modulation messages will be transmitted on the current channel
Keyboard	Note messages will be transmitted on the current channel

- * Octave Shift and Transpose are set independently.
- * If you simultaneously press [OCTAVE -] and [OCTAVE +], the Octave Shift setting will be reset to 0.
- * If you hold down [TRANSPOSE] and press [OCTAVE -] and [OCTAVE +] simultaneously, the Transpose setting will be reset to 0.

MIDI Channel mode (MIDI CH)

This mode lets you set the transmission channel (current channel) of the keyboard and bender lever.

Each controller has its own independent transmission channel setting. However, if OMNI mode (p. 149) is on, the controllers will also transmit on the current channel you specify here.

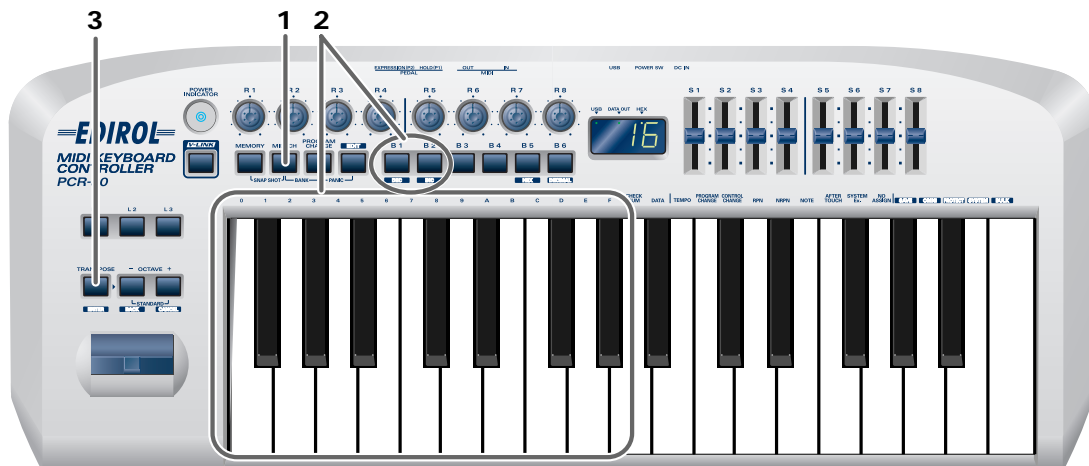

1

Press the **[MIDI CH]** button.

The **[MIDI CH]** button will light. The display will show the current channel setting.

* The **[HEX]** or **[DECIMAL]** button will also light according to the input mode (p. 158).

2

Use the **[DEC]** **[INC]** buttons or the **[0]**–**[F]** keys of the keyboard to specify the desired channel number.

DEC	Change the current value by -1
INC	Change the current value by +1
0–F	The input value HEX ...0–F DECIMAL ...1–16

3

Press the **[ENTER]** button.

The setting will be cancelled if you press another button instead of the **[ENTER]** button.

The current channel has now been set.

Program Change mode (PROGRAM CHANGE)

This mode lets you transmit a program change message on the current channel.

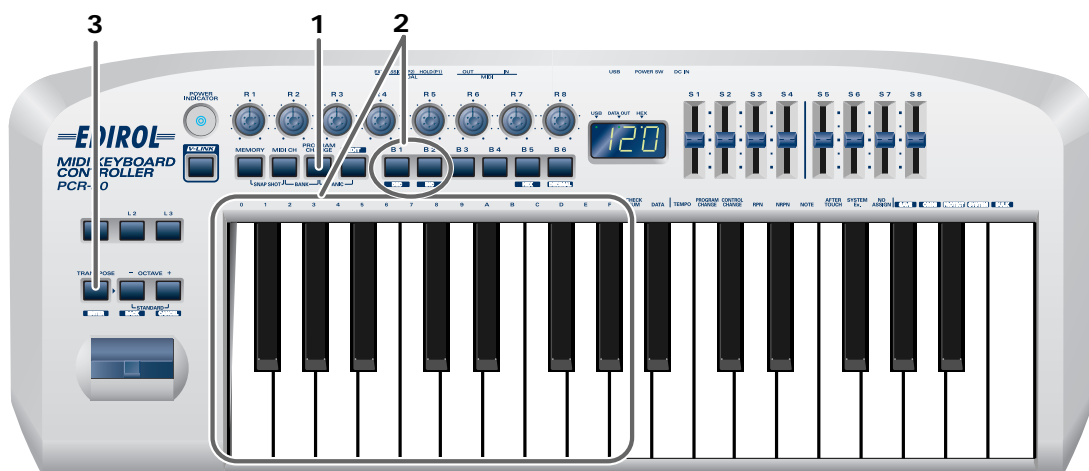

1

Press the **[PROGRAM CHANGE]** button.

The **[PROGRAM CHANGE]** button will light. The display will indicate the program change that was transmitted most recently.

* The **[HEX]** or **[DECIMAL]** button will also light according to the input mode (p. 158).

2

Use the **[DEC]****[INC]** buttons or the **[0]**-**[F]** keys of the keyboard to specify the program change you want to transmit.

DEC	Change the current value by -1
INC	Change the current value by +1
0-F	The input value HEX ...00-7F DECIMAL ...1-128

3

Press the **[ENTER]** button.

The setting will be cancelled if you press another button instead of the **[ENTER]** button.
The program change has now been transmitted.

Bank mode (BANK)

This mode lets you transmit a bank select (MSB, LSB) message on the current channel. The program change message you most recently transmitted (specified) in Program Change mode (p. 119) will also be transmitted following the bank select message.

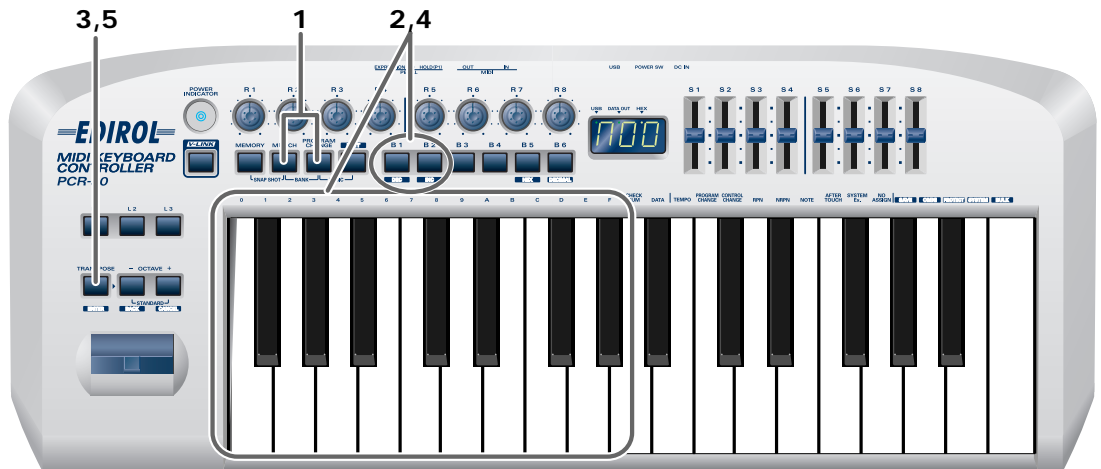

- 1 Simultaneously press the **[PROGRAM CHANGE]** button and **[MIDI CH]** button.

The **[PROGRAM CHANGE]** and **[MIDI CH]** buttons will light. The display will indicate the most recently transmitted bank select (MSB) value.

* The **[HEX]** or **[DECIMAL]** button will also light according to the input mode (p. 158).

- 2 First, specify the **bank select MSB** (CC#00).

Use the **[DEC][INC]** buttons or the **[0]–[F]** keys of the keyboard to specify the bank select MSB that you want to transmit.



*1 Reference

- 3 Press the **[ENTER]** button.

The setting will be cancelled if you press another button instead of the **[ENTER]** button.

- 4 Next, specify the **bank select LSB** (CC#32).

The display will indicate the most recently transmitted bank select (LSB) value.

Use the **[DEC][INC]** buttons or the **[0]–[F]** keys of the keyboard to specify the bank select LSB that you want to transmit.

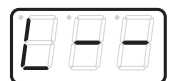

*1 Reference

- 5 Press the **[ENTER]** button.

The setting will be cancelled if you press another button instead of the **[ENTER]** button.
The bank select has now been transmitted.

Memory mode (MEMORY)

This mode lets you recall one of the stored memory sets into the current memory (p. 148).

When the PCR-30/50/80 is shipped, its internal memory contains sixteen different settings.

For details on the contents of each memory number, refer to “**Memory sets**” (p. 164).

If you edit the controller settings of a memory you recall, and want to keep your changes, you must save the memory before powering down the PCR-30/50/80. For the procedure, refer to “**EDIT-Save**” p. 148.

For details on customizing (editing) the controller settings, refer to “**Edit mode (EDIT)**” (p. 125).

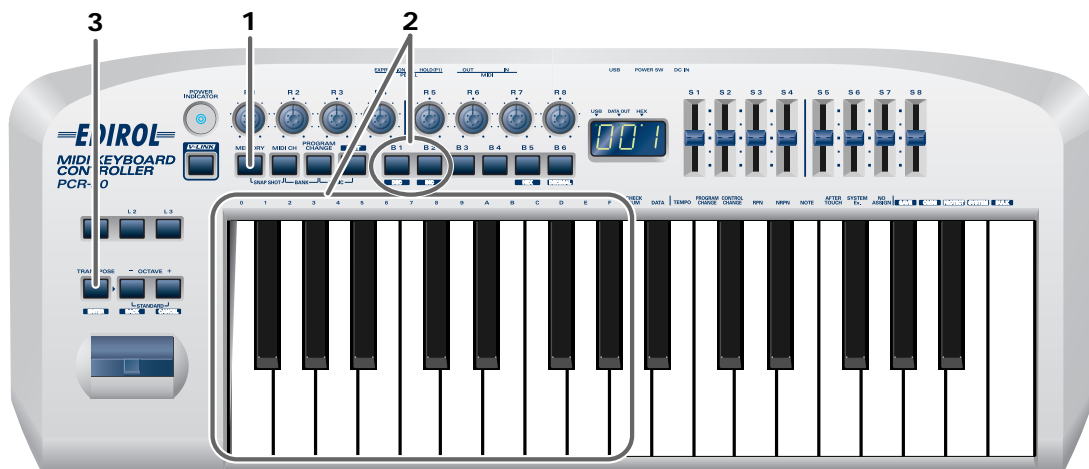

1

Press the **[MEMORY]** button.

The **[MEMORY]** button will light. The display will indicate the memory number that you selected most recently.

2

Use the **[DEC]**/**[INC]** buttons or the **[0]**–**[F]** keys of the keyboard to specify the memory number that you want to recall.

3

Press the **[ENTER]** button.

The setting will be cancelled if you press another button instead of the **[ENTER]** button. The memory has now been recalled.

Snapshot mode (SNAPSHOT)

Once you have set the various controllers to the desired settings, you can transmit a detailed description of this state in the form of a “snapshot”. When you execute this function, the current values of the controllers (**[R1–R8]**, **[S1–S8]**) will be transmitted.

This is convenient when you want to record the state of these controllers together at the beginning of a song in your sequencer, as the initial values.



- 1** Simultaneously press the **[MEMORY]** button and the **[MIDI CH]** button.
The **[MEMORY]** and **[MIDI CH]** buttons will light.
- 2** Press the **[ENTER]** button.
The **[MEMORY]** button and **[MIDI CH]** button will blink several times.
The snapshot will be transmitted.

Panic mode (PANIC)

If notes on a connected MIDI sound module become “stuck”, or if there is something wrong with the sound, you can execute the Panic function to solve the problem.

When you execute the Panic function, All Sound Off, All Notes Off, and Reset All Controllers messages will be transmitted on all channels.

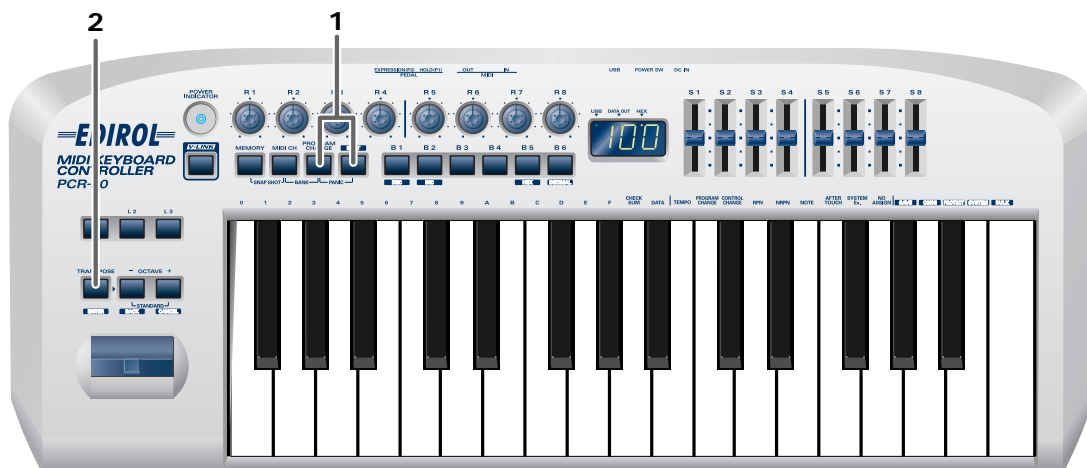

- 1** Simultaneously press the **[PROGRAM CHANGE]** button and **[EDIT]** button.
The **[PROGRAM CHANGE]** button and **[EDIT]** button will light.
- 2** Press the **[ENTER]** button.
The **[PROGRAM CHANGE]** button and **[EDIT]** button will blink.
The Panic function has now been executed.

MEMO

Edit mode (EDIT)

Press the [EDIT] button to enter Edit mode. In Edit mode you can make the following settings.

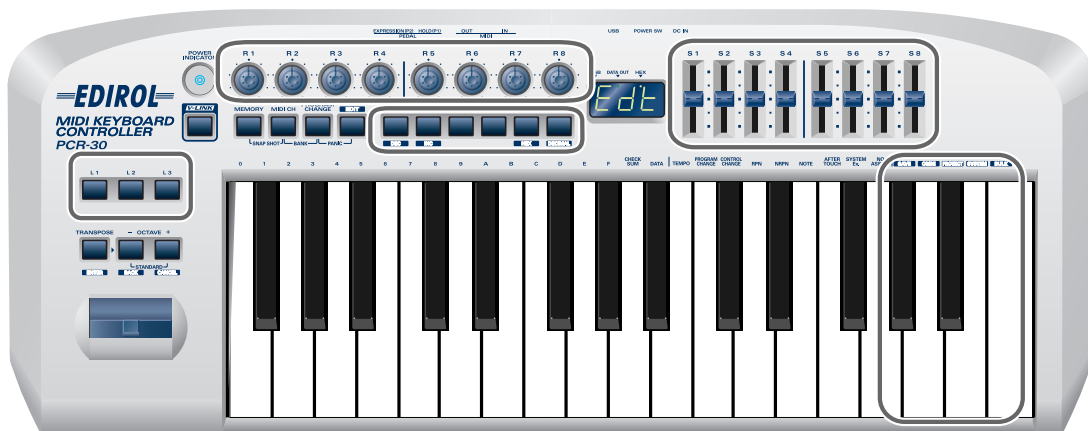









Selected item	Display	Refer to	Description
[R1--R8] [S1--S8] [B1--B6] [L1--L3] [P1, P2]	 Indicates the number of the selected controller	"Controller settings" (p. 126)	Assign a desired MIDI message to the controller.
Keyboard [BULK]	 Indicates the number of the selected controller	"BULK" (p. 151)	Transmit or receive the contents of a memory set as bulk data.
Keyboard [SYSTEM]	 Indicates the number of the selected controller	"SYSTEM" (p. 154)	Make system settings for the PCR.
Keyboard [SAVE]	 Indicates the number of the selected controller	"SAVE" (p. 148)	Save the current memory settings into a memory.
Keyboard [OMNI]	 Indicates the number of the selected controller	"OMNI" (p. 149)	Specify whether the output channel and output port for messages will follow the setting of the controller or the system setting.
Keyboard [PROTECT]	 Indicates the number of the selected controller	"PROTECT" (p. 150)	Specify whether ALL BULK reception and SAVE operations will be prohibited.

For details, refer to the explanation of how to set each item.

Controller settings

You can assign the following functions to a controller.

- * After you have modified the controller settings, perform the **“SAVE”** (p. 148) operation as needed. If you turn off the power without executing **“SAVE”**, your changes will be lost.

NOTE		“NOTE ASSIGN” (p. 127)
AFTERTOUCH		“AFTERTOUCH ASSIGN” (p. 129)
CONTROL CHANGE		“CONTROL CHANGE ASSIGN” (p. 132)
PROGRAM CHANGE		“PROGRAM CHANGE ASSIGN” (p. 135)
RPN		“RPN/NRPN ASSIGN” (p. 138)
NRPN		“RPN/NRPN ASSIGN” (p. 138)
SYSTEM Ex.		“SYS EX. ASSIGN” (p. 140)
TEMPO		“TEMPO ASSIGN” (p. 146)
NO ASSIGN		“NO ASSIGN” (p. 146)

A **Copy** function is also available. For the procedure, refer to **“ASSIGN COPY”** (p. 147).

- * For **NOTE**, **AFTERTOUCH**, **CONTROL CHANGE**, **PROGRAM CHANGE**, **RPN**, **NRPN**, and **SYSTEM Ex.**, the rightmost digit (third place) in the display is a number that indicates the mode (Basic mode or Advanced mode).
- * If you want to assign a single-byte system message (system realtime message, tune request) or a freely specified message of up to 24 bytes, refer to **“SYS EX. ASSIGN”** (p. 140).

How Basic mode and Advanced mode differ

Each assignment can be made either in **Basic mode** or **Advanced mode**.

Use the mode that is appropriate for your purpose.

- **Basic mode** You can make assignments easily, with the minimum number of steps.
- **Advanced mode** A greater number of steps are required, but you can specify more parameters and make more sophisticated assignments.

NOTE ASSIGN

Here's how to assign a Note message to a controller. In addition to being used to play sounds, note messages can also be used to control a sequencer.

Mode	Keyboard	Velocity	Port
Basic mode	0	100 (64H)	PCR 1
Advanced mode	1	Assignable	Assignable

Basic mode

1

Press the **[EDIT]** button.

The display will indicate "EDT."



2

Slightly move the controller to which you want to assign a Note message. In the case of a button, press that button.

The display will indicate the number of the selected controller.



3

Verify that the display shows the correct controller number, and press the **[ENTER]** button.

4

Press the **[NOTE]** key.

The display will indicate "NT0."



5

Press the **[ENTER]** button.

The display will indicate "C--."

*1 Reference



6

Input the channel. Use the **[DEC][INC]** buttons or the **[0]-[F]** keys to specify the channel.

7

Press the **[ENTER]** button.

The display will indicate "N--."

*1 Reference



8

Input the note number. Use the **[DEC][INC]** buttons or the **[0]-[F]** keys to specify the note number.

9

Press the **[ENTER]** button.

10

If you are making an assignment for a button, specify the button mode. (→ "**Specifying the button mode**" (p. 158))

*1 The -- area displays the currently set value. If it has not been set, the default setting will be displayed. Even if you change the type or mode of the MIDI message that is assigned, the default setting will be displayed. This will be lit if the value is the same as the currently set value, or will blink if the value is different.

Advanced mode

Advanced mode 1 of NOTE ASSIGN lets you specify the velocity value in addition to the items of Basic mode.

1. Press the **[EDIT]** button.
2. Slightly move the controller to which you want to assign a Note message. In the case of a button, press that button.
The display will indicate the number of the selected controller.
3. Verify that the display indicates the correct controller, and press the **[ENTER]** button.
4. Press the **[NOTE]** key and then press key **[1]**.
The display will indicate "NT1."
5. Press the **[ENTER]** button.
6. Input the channel.
7. Press the **[ENTER]** button.
8. Input the note number.
9. Press the **[ENTER]** button.

The display will indicate "V--."

*1 Reference



10. Input the velocity.
11. Press the **[ENTER]** button.

The display will indicate "P--."

*1 Reference



12. Specify the output port. (→**"Specifying the port"** (p. 159))
13. If you are making an assignment for a button, specify the button mode.
(→**"Specifying the button mode"** (p. 158))

- If you set [S1--S8], [R1--R8], or [P2] to NOTE ASSIGN, setting the controller to the maximum position will transmit the specified velocity value. Setting the controller to the minimum position will transmit a note message with a velocity of 0.
- If you assign this to [B1--B6] or [P1], the specified velocity value will be transmitted when you turn the controller on. When you turn the controller off, a note message with a velocity value of 0 will be transmitted.

■ AFTERTOUCHESSIGN

Here's how to assign an Aftersouch message to a controller.

Mode	Keyboard	Message	Value range	Port
Basic mode	0	Channel Pressure	00-7FH	Port 1
Advanced mode 1	1	Channel Pressure	Assignable	Assignable
Advanced mode 2	2	Polyphonic Key Pressure	00-7FH	Port 1
Advanced mode 3	3	Polyphonic Key Pressure	Assignable	Assignable

Basic mode

1

Press the **[EDIT]** button.

The display will indicate "EDT."



2

Slightly move the controller to which you want to assign an Aftersouch message. In the case of a button, press that button.

The display will indicate the number of the selected controller.



3

Verify that the display shows the correct controller number, and press the **[ENTER]** button.

4

Press the **[AFTERTOUCHESSIGN]** key.

The display will indicate "AT0".



5

Verify that the display is correct, and press the **[ENTER]** button.

The display will indicate "C--".

*1 Reference



6

Input the channel. Use the **[DEC][INC]** buttons or the **[0]-[F]** keys to specify the channel.

7

Press the **[ENTER]** button.

8

If you are making an assignment for a button, specify the button mode. (→ "Specifying the button mode" (p. 158))

Advanced mode 1–3

Advanced mode 1 of AFTERTOUCHESSIGN lets you specify the upper and lower limits of the aftertouch value in addition to the items of Basic mode. Advanced modes 2 and 3 let you specify an aftertouch message for an individual note (Polyphonic Key Pressure) instead of specifying the channel.

1. Press the **[EDIT]** button.
2. Slightly move the controller to which you want to assign an Aftertouch message. In the case of a button, press that button.
The display will indicate the number of the selected controller.
3. Verify that the display indicates the correct controller, and press the **[ENTER]** button.
4. Press the **[AFTERTOUCHESSIGN]** key and then press a key **[1]–[3]**.
The display will indicate the selected mode.
5. Press the **[ENTER]** button.
6. Input the channel.
7. Press the **[ENTER]** button.
8. If you are using **Advanced modes 2 or 3**, input the note number.
9. If you are using **Advanced modes 2 or 3**, Press the **[ENTER]** button.
10. If you are using **Advanced modes 1 or 3**, specify the upper limit and lower limit of the value as described in “**Aftertouch Assign upper/lower limit and port settings**” (p. 131), and specify the output port.
11. If you are making an assignment for a button, specify the button mode.
(→ “**Specifying the button mode**” (p. 158))



Aftertouch Assign upper/lower limit and port settings

In the case of Aftertouch Assign 1 or 3, you can set the upper limit and lower limit of the value, and specify the port.

1. The following display will appear.

*1 Reference



2. Use the **[DEC]**/**[INC]** buttons or the **[0]**–**[F]** keys to specify the upper limit.

3. Press the **[ENTER]** button.

The following display will appear.

*1 Reference



4. Use the **[DEC]**/**[INC]** buttons or the **[0]**–**[F]** keys to specify the lower limit.

5. Press the **[ENTER]** button.

The display will indicate “P--”.

*1 Reference



6. Specify the output port. (→“**Specifying the port**” (p. 159))

■ CONTROL CHANGE ASSIGN

Here's how to assign a control change message to a controller.

Mode	keyboard	Value range	Port
Basic mode	0	00-7FH	PCR 1
Advanced mode 1	1	Assignable	Assignable
Advanced mode 2	2	Simulates a rotary encoder	Assignable

Basic mode

1

Press the **[EDIT]** button.

The display will indicate "EDT".



2

Slightly move the controller to which you want to assign a Control Change message. In the case of a button, press that button.

The display will indicate the number of the selected controller.

3

Confirm what's indicated, and press the **[ENTER]** button.



4

Press the **[CONTROL CHANGE]** key.

The display will indicate "CC0".



5

Confirm what's indicated, and press the **[ENTER]** button.

The display will indicate "C--".

*1 Reference



6

Input the channel. Use the **[DEC][INC]** buttons or the **[0]-[F]** keys to specify the channel.

7

Press the **[ENTER]** button.

The display will indicate "N--".

*1 Reference



8

Use the **[DEC][INC]** buttons or the **[0]-[F]** keys to specify the control change number.

9

Press the **[ENTER]** button.

10

If you are making an assignment for a button, specify the button mode. (→ "**Specifying the button mode**" (p. 158))

Advanced mode 1

Advanced mode 1 of CONTROL CHANGE ASSIGN lets you specify the upper and lower limits of the control change value in addition to the items of Basic mode.

1. Press the **[EDIT]** button.
2. Slightly move the controller to which you want to assign a Control Change message. In the case of a button, press that button.
The display will indicate the number of the selected controller.

3. Confirm what's indicated, and press the **[ENTER]** button.
4. Press the **[CONTROL CHANGE]** key and then press key **[1]**.
The display will indicate "CC1".

5. Press the **[ENTER]** button.

6. Input the channel.

7. Press the **[ENTER]** button.

8. Input the control change number.

9. Press the **[ENTER]** button.

10. The following display will appear.

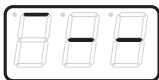

*1 Reference

11. Use the **[DEC][INC]** buttons or the **[0]–[F]** keys to specify the upper limit value.

12. Press the **[ENTER]** button.

13. The following display will appear.



*1 Reference

14. Use the **[DEC][INC]** buttons or the **[0]–[F]** keys to specify the lower limit value.

15. Press the **[ENTER]** button.

16. The display will indicate "P--".



*1 Reference

17. Specify the output port. (→**"Specifying the port"** (p. 159))

18. If you are making an assignment for a button, specify the button mode. (→**"Specifying the button mode"** (p. 158))

Advanced mode 2

Advanced mode 2 simulates the operation of a conventional rotary encoder. If this is assigned to a controller, moving that controller toward the right (upward) of center will have the same effect as turning the encoder clockwise, and moving the controller toward the left (downward) of center will have the same effect as turning the encoder counterclockwise. As the controller is moved further away from the center, the result will be the same as if the rotary encoder were moved more quickly. You can assign advanced mode 2 to a button, but it will not function.

1. Press the **[EDIT]** button.
2. Slightly move the controller to which you want to assign a Control Change message. The display will indicate the number of the selected controller.
3. Confirm what's indicated, and press the **[ENTER]** button.
4. Press the **[CONTROL CHANGE]** key and then press key **[2]**. The display will indicate "CC2".
5. Press the **[ENTER]** button.
6. Input the channel.
7. Press the **[ENTER]** button.
8. Input the control change number. Use the **[DEC][INC]** buttons or the **[0]–[F]** keys to specify the control change number.
9. Press the **[ENTER]** button.
10. The display will indicate "P--".

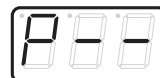

*1 Reference

11. Specify the output port. (→ "Specifying the port" (p. 159))

PROGRAM CHANGE ASSIGN

Here's how to assign a program change message to a controller.

Mode	Number	Effect	Bank	Port
Basic mode	0	Fixed value	Not output	PCR 1
Advanced mode 1	1	Assignable range of values	Not output	PCR 1
Advanced mode 2	2	Fixed value	Output	Assignable
Advanced mode 3	3	PC DEC	Not output	KEYBOARD PORT (p. 154)
Advanced mode 4	4	PC INC	Not output	KEYBOARD PORT (p. 154)

Basic mode

1

Press the **[EDIT]** button.

The display will indicate "EDT."



2

Slightly move the controller to which you want to assign a Program Change message. In the case of a button, press that button.

The display will indicate the number of the selected controller.

3

Confirm what's indicated, and press the **[ENTER]** button.



4

Press the **[PROGRAM CHANGE]** key.

The display will indicate "PC0".



5

Confirm what's indicated, and press the **[ENTER]** button.

The display will indicate "C--".

*1 Reference



6

Input the channel. Use the **[DEC][INC]** buttons or the **[0]-[F]** keys to specify the channel.

7

Press the **[ENTER]** button.

The display will indicate "N--".

*1 Reference



8

Use the **[DEC][INC]** buttons or the **[0]-[F]** keys to specify the program change number.

9

Press the **[ENTER]** button.

* If you assign Basic mode to [S1--S8], [R1--R8], or [P2], moving the controller from the minimum to the maximum position will transmit the assigned control change messages.

Advance mode 1, 2

Advanced mode 1 of PROGRAM CHANGE ASSIGN lets you specify the upper and lower limits of the program change value. Advanced mode 2 lets you transmit BANK LSB/MSB settings in addition to the program change.

1. Press the **[EDIT]** button.
2. Slightly move the controller to which you want to assign a Program Change message. In the case of a button, press that button. The display will indicate the number of the selected controller.
3. Confirm what's indicated, and press the **[ENTER]** button.

Advanced mode 1 —Specifying the range of values

4. Press the **[PROGRAM CHANGE]** key and then press key **[1]**.
5. Press the **[ENTER]** button.
6. Input the channel.
7. Press the **[ENTER]** button.
8. The following display will appear.



*1 Reference

9. Use the **[DEC][INC]** buttons or the **[0]–[F]** keys to specify the upper value limit.
10. Press the **[ENTER]** button.
11. The following display will appear.



*1 Reference

12. Use the **[DEC][INC]** buttons or the **[0]–[F]** keys to specify the lower value limit.
13. Press the **[ENTER]** button.

Advanced mode 2 —Transmitting bank data

4. Press the **[PROGRAM CHANGE]** key and then press key **[2]**.
5. Press the **[ENTER]** button.
6. Input the channel.
7. Press the **[ENTER]** button.
8. Specify the bank select MSB (CC#00). Use the **[DEC][INC]** buttons or the **[0]–[F]** keys to specify the MSB.



*1 Reference

9. Press the **[ENTER]** button.
10. Specify the bank select LSB (CC#32). Use the **[DEC][INC]** buttons or the **[0]–[F]** keys to specify the LSB.



*1 Reference

11. Press the **[ENTER]** button.
12. Input the program change number.
13. Press the **[ENTER]** button.
14. The display will indicate "P--".

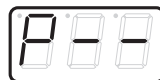

*1 Reference

15. Specify the output port. (→**"Specifying the port"** (p. 159))

Advanced modes 3 and 4

Advanced mode 3 lets you assign the Program Change Decrement function (**PC DEC**) to a controller.

Advanced mode 4 lets you assign the Program Change Increment function (**PC INC**) to a controller.

1. Press the **[EDIT]** button.
2. Slightly move the controller to which you want to assign Program Change DEC/INC.
In the case of a button, press that button.
The display will indicate the number of the selected controller.
3. Confirm what's indicated, and press the **[ENTER]** button.
4. Press the **[PROGRAM CHANGE]** key and then press key **[3]** or **[4]**.
5. Press the **[ENTER]** button.

Program Change Decrement function (PC DEC)

This transmits a program change that is one less than the previously transmitted program change number.

Program Change Increment function (PC INC)

This transmits a program change that is one greater than the previously transmitted program change number.

The **PC DEC** or **PC INC** is transmitted on the current channel, just as in "**Program Change mode (PROGRAM CHANGE)**" (p. 119). The value that is actually transmitted will appear in the display.

- * *In the explanation here, the "previously transmitted program number" refers to the one that was last transmitted by Advanced Mode 3 or 4 or in "**Program Change mode (PROGRAM CHANGE)**" (p. 119).*
- * *Program changes transmitted by basic mode or advanced modes 1 and 2 will not affect the increment/decrement functions.*

■ RPN/NRPN ASSIGN

Here's how you can assign an RPN or NRPN message to a controller.

Mode	Keyboard	Data entry MSB (CC#6) range	Data entry LSB (CC#38) range	Port
Basic mode	0	00-7FH	Not transmitted	PCR 1
Advanced mode 1	1	Assignable	00-7FH	Assignable

1

Press the **[EDIT]** button.

The display will indicate "EDT".



2

Slightly move the controller to which you want to assign an RPN or NRPN message. In the case of a button, press that button.

The display will indicate the number of the selected controller.

3

Confirm what's indicated, and press the **[ENTER]** button.

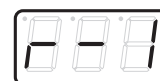

4

Press the **[RPN]** key.

The display will indicate "RP0".



* If you want to assign an NRPN message, press the **[NRPN]** key. The following procedure is the same as for RPN.



5

Confirm what's indicated, and press the **[ENTER]** button.

The display will blink "C--".

*1 Reference



6

Input the channel. Use the **[DEC][INC]** buttons or the **[0]-[F]** keys to specify the channel.

7

Press the **[ENTER]** button.

8

Use the **[DEC][INC]** buttons or the **[0]-[F]** keys to specify the RPN MSB (CC#101) or NRPN MSB (CC#99).

*1 Reference



9

Press the **[ENTER]** button.

- 10** Use the **[DEC][INC]** buttons or the **[0]-[F]** keys to specify the RPN LSB (CC#100) or NRPN LSB (CC#98).

*1 Reference

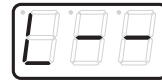

- 11** Press the **[ENTER]** button.

- 12** If you are making an assignment for a button, specify the button mode. (→“**Specifying the button mode**” (p. 158))

Advanced mode

In Advanced mode for RPN/NRPN, you can specify the upper and lower limit of the data entry MSB (CC#6) value when the RPN/NRPN message is transmitted, as well as the various settings available in Basic mode.

1. Press the **[EDIT]** button.
2. Slightly move the controller to which you want to assign the RPN or NRPN message. In the case of a button, press that button.
The display will indicate the number of the selected controller.
3. Confirm what's indicated, and press the **[ENTER]** button.
4. Press the **[RPN]** key and then press key **[1]**.
* If you want to assign an NRPN message, press the **[NRPN]** key. The following procedure is the same as for RPN.
5. Press the **[ENTER]** button.
6. Input the channel. Use the **[DEC][INC]** buttons or the **[0]-[F]** keys to specify the channel.
7. Press the **[ENTER]** button.
8. Use the **[DEC][INC]** buttons or the **[0]-[F]** keys to specify the RPN MSB (CC#101) or NRPN MSB (CC#99).
9. Press the **[ENTER]** button.
10. Use the **[DEC][INC]** buttons or the **[0]-[F]** keys to specify the RPN LSB (CC#100) or NRPN LSB (CC#98).
11. Press the **[ENTER]** button.
12. The following display will appear.



*1 Reference



*1 Reference



*1 Reference

■ SYS EX. ASSIGN

Here's how you can assign a system exclusive message to a controller. Advanced mode 2 lets you assign a single-byte system message (System realtime message, tune request). Advanced modes 3 and 4 let you assign any desired message. (Input up to 24 bytes)

Mode number	Key-board	Mode	Value range	Required ending	Notes/restrictions
Basic mode	0	Sys Ex. message	Default range	Input F7	1st byte fixed at F0
Advanced mode 1	1	Sys Ex. message	Assignable	Input F7	1st byte fixed at F0
Advanced mode 2	2	Single byte system message	-	-	[0-5, 7, 9, D, E] [DATA] [CHECKSUM] buttons are invalid
Advanced mode 3	3	Any desired MIDI message	Default range	Specified number of bytes	[CHECKSUM] button is invalid
Advanced mode 4	4	Any desired MIDI message	Assignable	Specified number of bytes	[CHECKSUM] button is invalid

SYS EX. ASSIGN can calculate the checksum automatically, and lets you specify a variable (data) range or embed a channel/block number within the message. ("Sys Ex. ASSIGN items" (p. 160)) In SYS EX. ASSIGN, the input mode will be HEX mode.

1

Press the [EDIT] button.

The display will indicate "EDT".



2

Slightly move the controller to which you want to assign the system exclusive message. In the case of a button, press that button.

The display will indicate the number of the selected controller.

3

Confirm what's indicated, and press the [ENTER] button.



4

Press the [SYSTEM Ex.] key.



5

If you want to select an Advanced mode, press a key from [1] to [4].

The selected mode will blink in the display.

6

Confirm what's indicated, and press the [ENTER] button.

For Basic mode or Advanced mode 1

The display will blink "F0", which is the first byte (starting status byte) of a system exclusive message. (This cannot be changed.)



7

Confirm what's indicated, and press the [ENTER] button.

8

Use the [0]-[F] keys to input the second byte.

9

Press the [ENTER] button.

10 Input the third and subsequent bytes in the same way.

11 When you have finished inputting the message, use the keyboard to enter **[F]** and **[7]**, specifying the ending status byte "F7".

12 Press the **[ENTER]** button.

13 Specify the output port. (→**"Specifying the port"** (p. 159))

14 If you are making an assignment for a button, specify the button mode.
(→**"Specifying the button mode"** (p. 158))

For Advanced mode 2

The display will indicate "F-."

7 Use the **[6]**, **[8]**, **[A]–[C]**, **[F]** keys to specify the system message.

8 Press the **[ENTER]** button.

9 Specify the output port. (→**"Specifying the port"** (p. 159))



For Advanced modes 3 or 4

The display will indicate "L--".

7 Use the **[0]–[F]** keys of the keyboard to specify the number (decimal) of bytes you want to input.



*1 Reference

8 Press the **[ENTER]** button.

9 Use the **[0]–[F]** keys to input the first byte.

10 Press the **[ENTER]** button.

11 Input the second and subsequent bytes in the same way.

12 After you have input the number of bytes you specified in step 7, the PCR-30/50/80 will check whether the messages you've input are indeed valid MIDI messages. If there is a problem, the display will indicate "ERR".

In this case, you should press the **[ENTER]** button, which takes you back to step 7, where you can input the values over again.

13 In the case of Advanced mode 4, specify the upper and lower limits.

14 Specify the output port. (→“**Specifying the port**” (p. 159))

15 If you are making an assignment for a button, specify the button mode. (→“**Specifying the button mode**” (p. 158))

Here are some examples of inputting various actual system exclusive messages.

● GM2 System On

F0 7E 7F 09 03 F7

Here's how to assign a GM2 System On system exclusive message in **Basic mode**.

1. Press the **[EDIT]** button.
The display will indicate “EDT”.
2. Slightly move the controller to which you want to assign the system exclusive message. In the case of a button, press that button.
The display will indicate the number of the selected controller.
3. Confirm what's indicated, and press the **[ENTER]** button.
4. Press the **[SYSTEM Ex.]** key.
The display will indicate “SE0”.
5. Confirm what's indicated, and press the **[ENTER]** button.
The display will indicate “F0”, which is the first byte (beginning status) of a system exclusive message. This cannot be changed. (This cannot be changed.)
6. Confirm what's indicated, and press the **[ENTER]** button.
7. Use the **[7]** and **[E]** keys to input the second byte “7E”.
8. Confirm what's indicated, and press the **[ENTER]** button.
9. Use the **[7]** and **[F]** keys to input the third byte “7F”.
10. Confirm what's indicated, and press the **[ENTER]** button.
Input the fourth and fifth bytes in the same way.
11. Finally, use the **[F]** and **[7]** keys to input the ending status byte “F7”.
12. Confirm what's indicated, and press the **[ENTER]** button.
13. Specify the output port. (→“**Specifying the port**” (p. 159))
14. If you are making an assignment for a button, specify the button mode.
(→“**Specifying the button mode**” (p. 158))

The GM2 System On message has now been assigned.

● Master Volume

F0 7F 7F 04 01 vL vM F7

Since a Master Volume message has a data range of 00 00–7F 7F and we do not need to specify the range, we will use **Basic mode**. Since the two bytes of data are in the order of LSB and then MSB, we will select “DT3” when we input the data.

1. Press the **[EDIT]** button.
The display will indicate “EDT”.
2. Slightly move the controller to which you want to assign the system exclusive message. In the case of a button, press that button.
The display will indicate the number of the selected controller.
3. Confirm what’s indicated, and press the **[ENTER]** button.
4. Press the **[SYSTEM Ex.]** key.
The display will blink “SE0”.
5. Confirm what’s indicated, and press the **[ENTER]** button.
The display will indicate “F0,” which is the first byte (beginning status) of a system exclusive message. (This cannot be changed.)
6. Confirm what’s indicated, and press the **[ENTER]** button.
7. Use the **[7]** and **[F]** keys to input the second byte “7F”.
8. Confirm what’s indicated, and press the **[ENTER]** button.
Input the third, fourth and fifth bytes in the same way.
9. Since the sixth byte is the data area, press the **[DATA]** key, and then press **[3]**.
The display will indicate “DT3”.
10. Confirm what’s indicated, and press the **[ENTER]** button.
11. Since we selected “DT3” as the sixth byte, the seventh byte will automatically be allocated as the data area and cannot be modified.
12. Confirm what’s indicated, and press the **[ENTER]** button.
13. Use the **[F]** and **[7]** keys to input the ending status byte “F7”.
14. Confirm what’s indicated, and press the **[ENTER]** button.
15. Specify the output port. (→“**Specifying the port**” (p. 159))
16. If you are making an assignment for a button, specify the button mode.
(→“**Specifying the button mode**” (p. 158))

The Master Volume message has now been assigned.

● Bend Pitch Control

Since the GS Bend Pitch Control message has a data range of 40H–58H (0–24 semitones), we will select **Advanced mode 1**, which lets us specify the range. Since the data format is one byte, we will select “DT0” (p. 161) when inserting the data.

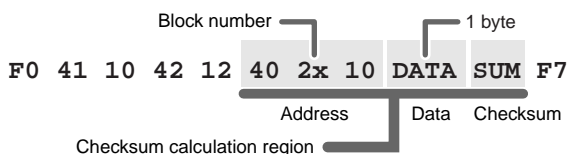

1. Press the **[EDIT]** button.
The display will indicate “EDT”.
2. Slightly move the controller to which you want to assign the system exclusive message. In the case of a button, press that button.
The display will indicate the number of the selected controller.
3. Confirm what’s indicated and press **[ENTER]**.
4. Press the **[SYSTEM Ex.]** key, and then press the **[1]** key.
The display will indicate “SE1”.
5. Confirm what’s indicated and press **[ENTER]**.
The display will blink “F0”, which is the first byte (beginning status) of a system exclusive message. (This cannot be changed.)
6. Confirm what’s indicated and press **[ENTER]**.
7. Use the **[4]** and **[1]** keys to input the second byte “41”.
8. Confirm what’s indicated and press **[ENTER]**.
Input the third, fourth and fifth bytes in the same way.
9. Since the sixth byte is the beginning of the checksum calculation area, press the **[CHECKSUM]** key to specify this byte as the beginning of the area for which the checksum will be calculated.
10. Confirm what’s indicated and press **[ENTER]**.
11. Input the sixth byte.
12. Since the seventh byte will have “2” in the upper bits and the block number in the lower bits, press **[DATA]** three times.
The display will indicate “OBL”.

13. To specify "2" for the upper bits, press the **[2]** key.
The display will indicate "2BL".
 14. Confirm what's indicated and press **[ENTER]**.
 15. In the same way, enter bytes 8.
 16. Since the ninth byte is the data area, press the **[DATA]** key.
The display will indicate "DT0."
 17. Confirm what's indicated and press **[ENTER]**.
 18. Since the ten byte will contain the checksum, press the **[CHECKSUM]** key to specify the location at which the checksum will be input.
The display will blink "CS1" (Checksum Type 1).
 19. Confirm what's indicated and press **[ENTER]**.
 20. Press the **[F]** and then **[7]** keys to input the ending status "F7."
 21. Confirm what's indicated and press **[ENTER]**.
 22. Next, specify an upper limit value of "58" for the data area.
 23. Press **[ENTER]**.
 24. Specify a lower limit value of "40" for the data area.
 25. Press **[ENTER]**.
 26. Specify the output port.
(→ "Specifying the port" (p. 159))
 27. If you are making an assignment for a button, specify the button mode. (→ "Specifying the button mode" (p. 158))
- The GS Bend Pitch Control message has been assigned.

■ TEMPO ASSIGN

You can assign a controller to adjust the speed (20–250) of the F8 Clock message.

- * *In order to transmit F8 Clock messages, the F8 CLOCK setting must be “ON”.
(→“F8 CLOCK ON/OFF” (p. 154))*

1 Press the [EDIT] button.

The display will indicate “EDT.”



2 Slightly move the controller to which you want to assign TEMPO. In the case of a button, press that button.

The display will indicate the number of the selected controller.

3 Confirm what’s indicated and press the [ENTER] button.



4 Press the [TEMPO] key.

The display will indicate “TMP”.

5 Confirm what’s indicated and press the [ENTER] button.



6 If you are making the assignment for a button, specify the button mode.
(→“Specifying the button mode” (p. 158))

- * *In the case of a button, the value will be fixed at maximum (250) for ON, and minimum (20) for OFF.*

■ NO ASSIGN

Here’s how you can cancel the message assigned to a controller. Once its assignment is cancelled, no message will be transmitted when you operate that particular controller.

1 Press the [EDIT] button.

The display will indicate “EDT”.



2 Slightly move the controller whose assignment you want to cancel. In the case of a button, press that button.

The display will indicate the number of the selected controller.

3 Confirm what’s indicated and press the [ENTER] button.



- 4** Press the **[NO ASSIGN]** key.
The display will indicate “NOA”.



- 5** Press the **[ENTER]** button.

- 6** The display will blink “YES,” so press the **[ENTER]** button once again.



■ ASSIGN COPY

Here's how a message assigned to a controller can be copied to another controller.

- 1** Press the **[EDIT]** button.
The display will indicate “EDT”.



- 2** Slightly move the controller to which you want to copy the assignment (the “copy destination”). In the case of a button, press that button.

The display will indicate the number of the selected controller.

- 3** Confirm what's indicated and press the **[ENTER]** button.

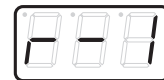

- 4** Slightly move the controller whose assignment you want to copy (the “copy source”). In the case of a button, press that button.

The display will indicate “CPY”.

- 5** Press the **[ENTER]** button.
The display will blink the copy-source controller number.



- 6** Confirm what's indicated and press the **[ENTER]** button.



SAVE

Here's how to save the settings of the current memory into internal memory.

You can save settings into internal memory numbers 1-F.

You cannot save to memory number 0 (GM2).

* After you edit the settings, perform the **"SAVE"** (p. 148) operation as needed. If you turn off the power without performing **"SAVE"**, your changes will be lost.

1

Press the **[EDIT]** button.

The display will indicate "EDT".



2

Press the **[SAVE]** key.

The display will blink "SAV."



3

Confirm what's indicated and press the **[ENTER]** button.

* If the display indicates "PTC", it means that the Save could not be carried out because the **PROTECT** setting (p. 62) is on. Turn **PROTECT** off, and then try the operation once again from step 1.



4

Select a memory number 1-F. Use the **[DEC]** **[INC]** buttons or the **[1]-[F]** keys to specify the save-destination memory number.

The specified memory number will blink in the display.

5

Confirm what's indicated and press the **[ENTER]** button.

About the memories of the PCR

The PCR has the following sixteen memories.

Memory number 0	GM2 SET	Cannot be saved
Memory number 1	User memories (15)	Can be saved
:		
Memory number F		

"Current memory" is a location into which you can recall one of these memories.

In order to use one of the saved memories, you must recall it into current memory as described in **"Memory mode (MEMORY)"** (p. 121).

The contents of current memory will be lost when you turn off the power. If you have modified the settings in current memory, perform the **"SAVE"** operation if you want to keep your changes.

You can set the **"STARTUP MEMORY"** (p. 154) setting to specify the memory that will be loaded into current memory when you turn on the power.

OMNI

If you turn the Omni setting ON, all messages will be transmitted on the current channel (p. 118) regardless of the channel that is specified for each controller.

Also, all messages will be transmitted to the “**KEYBOARD PORT SET**” (p. 154) regardless of the port that is specified for each controller.

1

Press the **[EDIT]** button.

The display will indicate “EDT”.



2

Press the **[OMNI]** key.

The display will blink “OMN”.



3

Confirm what's indicated and press the **[ENTER]** button.

4

The display will show the current setting.

0		OMNI OFF	Messages will be transmitted on the channel and port specified for each controller.
1		OMNI ON	Messages will be transmitted on the current channel from the Keyboard Port, regardless of the channel and port specified for each controller.

5

Use the **[DEC]** **[INC]** buttons or the **[0]** **[1]** keys to select the mode.

6

Press the **[ENTER]** button.

PROTECT

If you turn the Protect setting ON, All Bulk (p. 151) reception and Save (p. 148) operations will be disabled.

1

Press the **[EDIT]** button.

The display will indicate "EDT".



2

Press the **[PROTECT]** key.

The display will blink "PTC".



3

Confirm what's indicated and press the **[ENTER]** button.

4

The display will show the current setting.

0		PROTECT OFF	Allow changes.
1		PROTECT ON	Prohibit changes.

5

Use the **[DEC]** **[INC]** buttons or the **[0]** **[1]** keys to select the mode.

6

Press the **[ENTER]** button.

BULK

Controller assignments can be received or transmitted as bulk data.

- * *When you transmit or receive Bulk data, the contents of the current memory will be lost. Save the current memory settings as needed before you perform this operation.*

■ Receive mode

1

Press the **[EDIT]** button.

The display will indicate "EDT".



2

Press the **[BULK]** key.

The display will blink "BLR" (Bulk Receive).



3

Confirm what's indicated and press the **[ENTER]** button.

The display will indicate "RS", and the "S" will blink.



4

Use the **[DEC]** **[INC]** buttons or the **[0]** **[1]** keys to select the mode.

0		SINGLE BULK	A memory will be received as bulk data. The received data will overwrite the current memory. Memories 1-F will not be affected.
1		ALL BULK	All memories will be received as bulk data. The received data will overwrite memories 1-F.

5

Confirm what's indicated and press the **[ENTER]** button.

The third digit of the display will blink, and the PCR-30/50/80 will wait to receive bulk data.



About the display in Bulk mode

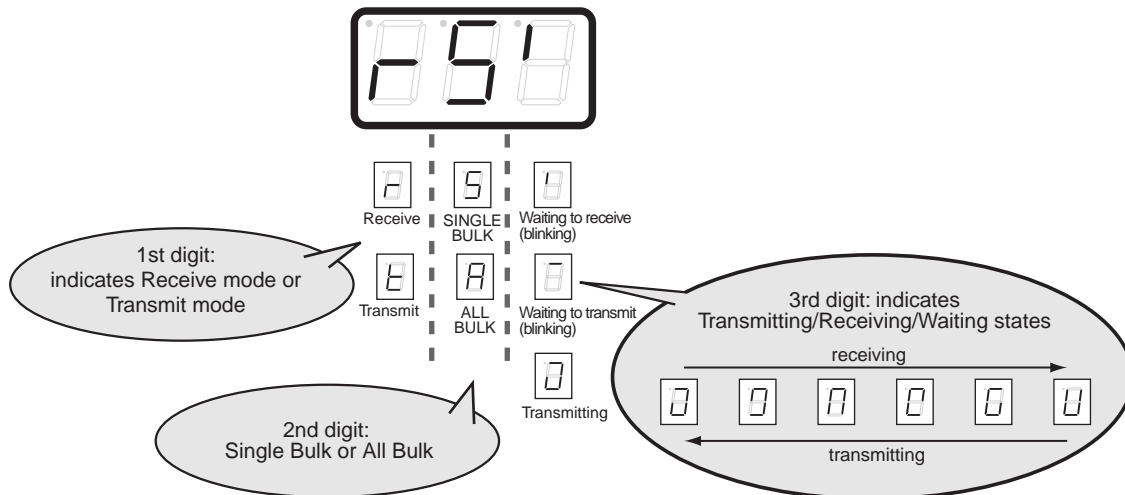

6

Transmit bulk data from your sequencer or other device.

Specify "PCR" (Mac OS 9/8: PCR 1) as the MIDI output device for your sequencer software. For details on this setting, refer to the manual of your sequencer software.

For details on the port that will be used to transfer bulk data, refer to "**About the ports when using a USB connection**" (p. 159).

7

When the PCR finishes receiving the bulk data, the display will indicate "END".



Error display



If the data could not be received correctly, the display will blink "ERR".

If this occurs, press the **[CANCEL]** button to cancel the "ERR" display.

Once "ERR" has been dismissed, perform the bulk reception procedure over again, from step 1.

8

Confirm what's indicated and press the **[ENTER]** button.

■ Transmit mode

- 1** Press the **[EDIT]** button.
The display will indicate “EDT”.



- 2** Press the **[BULK]** key.

- 3** Press the **[1]** key.

The display will blink “BLT” (Bulk Transmit).

- 4** Confirm what’s indicated and press the **[ENTER]** button.



The display will indicate “TS”, and the “S” will blink.

- 5** Use the **[DEC]** **[INC]** buttons or the **[0]** **[1]** keys to select the mode.



0		SINGLE BULK	The currently recalled memory (the current memory) will be transmitted as bulk data
1		ALL BULK	All memories (memories 1–F) will be transmitted as bulk data.

- 6** Confirm what’s indicated and press the **[ENTER]** button.

- 7** The third digit of the display will blink, and the PCR-30/50/80 will wait to transmit bulk data.



- 8** Press the **[ENTER]** button.

On your sequencer software, specify “PCR 2” as the MIDI input device. For details on this setting, refer to the manual of your sequencer software.

For details on the port that will be used to transfer bulk data, refer to “**About the ports when using a USB connection**” (p. 159).

- 9** When the PCR finishes receiving the bulk data, the display will indicate “END”.



- 10** Confirm what’s indicated and press the **[ENTER]** button.

SYSTEM

Here's how you can make various system settings for the PCR-30/50/80.

1

Press the **[EDIT]** button.

The display will indicate "EDT".



2

Press the **[SYSTEM]** key.

The display will indicate "SY0".

3

Use the **[0]–[8]** keys to specify the System setting that you want to set, and then press the **[ENTER]** button.

Confirm what's indicated and use the appropriate method to make the setting.



Key-board	Mode	Content of the setting	Default	Setting method
0	F8 CLOCK ON/OFF	Specify whether F8 Clock is to be transmitted.	OFF	A (p. 155)
1	F8 CLOCK DEFAULT TEMPO	If "F8 CLOCK ON/OFF" is ON, specify the default value of the F8 Clock. After the power is turned on, this tempo will continue to be output until you move a controller to which TEMPO is assigned.	120	B (p. 155)
2	F8 CLOCK PORT SET	If "F8 CLOCK ON/OFF" is ON, specify the port from which the F8 Clock is to be transmitted.	PCR 1	C (p. 155)
3	VELOCITY OFFSET	The value you specify here will be added to the velocity of the notes played from the keyboard. * If the result of the addition would exceed 7FH, the velocity will be 7FH.	0	B (p. 155)
4	KEYBOARD PORT SET	Specify the port from which messages produced by the BENDER lever of the keyboard are to be transmitted.	PCR 1	C (p. 155)
5	H-ACTIVITY ON/OFF	Turn this ON if you are using certain applications (such as Pro Tools LE). When ON, "90 00 7F" will be output from PCR 2 approximately every 500 ms.	OFF	A (p. 155)
6	USB DRIVER MODE	Specify the type of driver used for USB connection.	Original Driver	D (p. 156)
7	STARTUP MEMORY	Specify the memory that will be selected when the power is turned on.	GM2	E (p. 156)
8	FACTORY RESET	Restore all settings of the PCR-30/50/80 to their factory-set condition.	-	F (p. 156)

■ Setting method A

Perform steps 1–3.

4

Use the [DEC][INC] buttons or the [0] or [1] keys to switch F8 CLOCK or H-ACTIVITY on/off.

0	OFF
1	ON

The display will indicate either “ON” or “OFF”.

5

Press the [ENTER] button.

■ Setting method B

Perform steps 1–3.

4

Use the [DEC][INC] buttons or the [0]–[F] keys to specify the F8 CLOCK DEFAULT TEMPO or the VELOCITY OFFSET value.

Keyboard	Mode	Value range
1	F8 CLOCK DEFAULT TEMPO	20–250
3	VELOCITY OFFSET	0–127

The display will indicate the value.

5

Press the [ENTER] button.

■ Setting method C

Perform steps 1–3.

4

Use the [DEC][INC] buttons or the [0]–[F] keys to specify F8 CLOCK PORT SET or KEYBOARD PORT SET. (→“**Specifying the port**” (p. 159))

The specified port will indicate in the display.

5



Press the [ENTER] button.

■ Setting method D

Perform steps 1-3.

4

Use the [DEC][INC] buttons or the [0] or [1] keys to specify the USB DRIVER MODE.

0		Original driver	FPT technology is used to perform high-speed MIDI transfer. Normally, we recommend that you use this mode.
1		Generic driver	Select this if you are using the standard MIDI driver provided by your operating system.

* **FPT = Fast Processing Technology for MIDI Transmission:**

Effective use is made of the USB bandwidth according to the amount of MIDI data to be transmitted, ensuring that MIDI data processing will always occur optimally.

5



Press the [ENTER] button.

■ Setting method E

Perform steps 1-3.

4

Use the [DEC][INC] buttons or the [0] or [1] keys to specify the GM2/LAST ACCESS MEMORY setting.

0		GM2 MEMORY	When the PCR starts up, memory number 0 (GM2) will be loaded into current memory (p. 148) regardless of the state in which the power was turned off.
1		LAST ACCESS MEMORY	Upon power-up, the PCR-30/50/80 will recall the memory that was last recalled or saved into current memory (p. 148).

5

Press the [ENTER] button.

■ Setting method F

Perform steps 1-3.

4

The display will indicate "RST".



5

Press the [ENTER] button.

6

The display will blink "YES".



7

Press the [ENTER] button.

Appendices

This section contains troubleshooting information and explanations of convenient functions. You may read this material as necessary.

Convenient functions	p. 158
Memory sets	p. 164
Troubleshooting.....	p. 170
MIDI implementation	p. 174
Main specifications.....	p. 179

Convenient functions

Setting the input mode

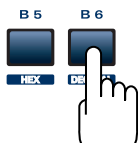

If you are not in Play mode, you can use one of two ways to input a numerical value into the PCR-30/50/80: **Decimal input mode** or **Hexadecimal input mode**.

If you want to input decimal numbers, press the **[DECIMAL]** button. If you want to input hexadecimal numbers, press the **[HEX]** button. When you turn on the power, the PCR-30/50/80 will start up in Decimal mode.

Decimal and hexadecimal numbers correspond as follows.

Decimal: **0–127**

Hexadecimal: **00–7F**

However, for MIDI CH and PROGRAM CHANGE, the values are as follows.

	Decimal	Hexadecimal
MIDI CH	1–16	0–F
PROGRAM CHANGE	1–128	00–7F

- * Normally, the display will show three digits when using Decimal input mode. For this reason, there will be no indication of the parameter you are now inputting, and you may lose track of what you are doing. If this occurs, you can temporarily switch back to Hexadecimal mode to check the parameter you are inputting. Then switch back to Decimal mode and continue.

Specifying the button mode

When you make Assign settings (p. 126) in Edit mode to assign a message to a button, you must specify the operating mode of the button (button mode).

1. Press the **[0]** or **[1]** key to select either Latch mode or Toggle mode.

0		Latch mode	The setting will turn on when you press the button, and off when you release it. The button will remain lit while you are pressing it.
1		Toggle mode	The setting will alternate on/off each time you press the button. The button will light when an On message is transmitted, and will go dark when an Off message is transmitted.



2. Press the **[ENTER]** button.

- * When you use a button as a controller, turning the button on will transmit the maximum specified value, and turning it off will transmit the minimum value.

Specifying the port

When you are making Assign settings (p. 41) in Edit mode and have selected Advanced mode, you must specify the USB port to which the message assigned to the controller will be sent when using a USB connection.

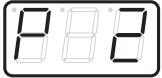
1. Press a key [1]-[3] to select the port.

1		PORT 1	Messages will be sent to "PCR 1."
2		PORT 2	Messages will be sent to "PCR 2."
3		PORT 1,2	Messages will be sent to both "PCR 1" and "PCR 2."

2. Press the [ENTER] button.

* If you are using the PCR-30/50/80 with a MIDI connection, the messages will be transmitted from the MIDI OUT connector regardless of this port setting.

About the ports when using a USB connection

The ports correspond to the PCR-30/50/80 as follows.

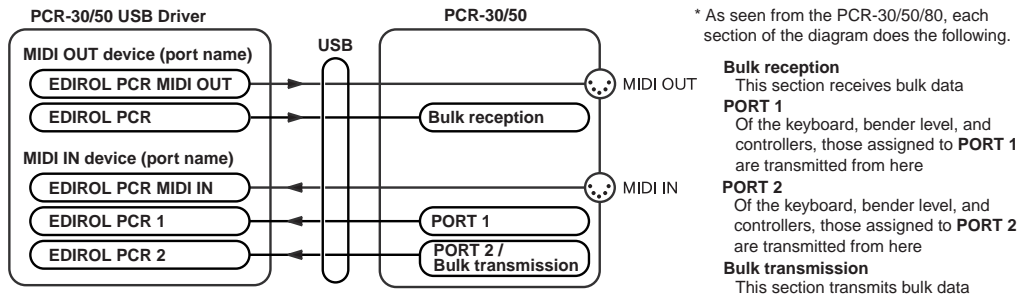

MIDI OUT device	
PCR MIDI OUT (Mac OS 9/8 : PCR MIDI IN, OUT)	If you specify PCR MIDI OUT as the output port for your sequencer software, the MIDI messages will be sent from the MIDI OUT connector of the PCR-30/50/80.
PCR (Mac OS 9/8 : PCR 1)	This is the Bulk reception port. When receiving bulk data into the PCR-30/50/80, specify PCR as the output port for your sequencer software.
MIDI IN device	
PCR MIDI IN (Mac OS 9/8 : PCR MIDI IN, OUT)	If you specify PCR MIDI IN as the input port for your sequencer software, MIDI messages from the MIDI IN connector of the PCR-30/50/80 can be received.
PCR 1 PCR 2	This is the port at which messages from the keyboard, BENDER lever, and controllers will be input. The keyboard, BENDER lever, and controllers will be mapped to PCR 1 and/or PCR 2 according to the port setting. You may find it convenient to specify PCR 1 for messages used to play a software synthesizer or for realtime recording on a sequencer track, and specify PCR 2 for messages used to control the sequencer, such as sequencer play/stop or track fader control. PCR 2 is the bulk transmission port. When transmitting bulk data from the PCR-30/50/80, specify PCR 2 as the input port for your sequencer software.

Sys Ex. ASSIGN items

■ Specifying the checksum

The PCR-30/50/80 can automatically calculate the checksum of a system exclusive message and embed it in the message. In order to use this function, you must use the following procedure to specify the starting location from which the checksum is calculated, and the location at which the checksum is inserted. You can also select the type of checksum.

For an actual example, please read the Sys Ex.ASSIGN section “**Bend Pitch Control**” (p. 144)

1. Press the **[CHECKSUM]** key before you input the byte at which checksum calculation should begin.

The display will indicate “CSS” (Checksum Start).

If you press the **[CHECKSUM]** key once again, “CSS” (Checksum Start) will be cancelled.



2. Press the **[ENTER]** button.

3. Continue inputting data.

4. Press the **[CHECKSUM]** key at the location where the checksum should be inserted.

The display will indicate “CS1” (Checksum type 1).

5. Press the **[ENTER]** button.



Checksum types

There are two types of checksum, as follows.

1		CHECKSUM TYPE 1	This is the method used by Roland and most other manufacturers
2		CHECKSUM TYPE 2	Select this if the method other than type 1 is used

Switching the type

If you want to switch to **type 2**, press the **[2]** key after you press **[CHECKSUM]** in step 4. To switch back to **type 1**, press the **[1]** key.

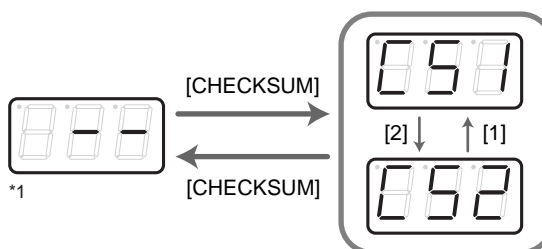

■ Specifying the location of the data

Here's how to specify the location and data type of the variable portion (data) within a system exclusive message.

The range of data values will be the default range in the case of Basic mode or Advanced mode 3.

In the case of Advanced modes 1 and 4, you can specify the range of data values.

For an actual example, please read the Sys Ex,ASSIGN section “**Master Volume**” (p. 143).

1. Press the **[DATA]** key at the location where you want to input the data.
The display will indicate “DT0”.
2. Use the **[0]–[4]** keys to select the type of data.

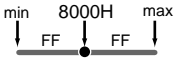
Data number	Data type	Default range	Target of range setting	Example (specified upper/lower limits)
DT0	7bit	00H–7F	Specify the range of data (00–7FH)	04–45 (lower limit 4H, upper limit 45H)
DT1	4bit/4bit	0H/0H–FH/FH	Specify the range of the first byte (0–FH), second byte is fixed at 0–FH	0/0–D/F (lower limit 0H, upper limit DH)
DT2	7bit/7bit (MSB/LSB)	00H/00H–7FH/7FH	Specify the MSB range (00–7F), LSB is fixed at 00–7F	23/00–68/7F (lower limit 23H, upper limit 68H)
DT3	7bit/7bit (LSB/MSB)	00H/00H–7FH/7FH	Specify the MSB range (00–7F), LSB is fixed at 00–7F	00/23–7F/68 (lower limit 23H, upper limit 68H)
DT4	4bit/4bit/ 4bit/4bit	7H/FH/0H/1H– 8H/0H/FH/FH	Specify the limits of positive/negative change as a value from 00H to FFH, centered on 8000H. 	7/F/0/2–8/0/5/0 (lower limit FEH, upper limit 50H)

* In the case of DT1--DT4 (data consisting of two or more bytes), a data location will automatically be allocated for the next byte, and "-DT" will be displayed. (This cannot be changed.)

3. Press the **[ENTER]** button.
4. If you selected DT1 through DT4, the display will indicate “-DT”.
Press the **[ENTER]** button.

■ Inputting channel/block data

If a system exclusive message includes a channel or GS block number, here's how to specify the type and the value of the upper bits. For the channel and block number, the setting of the current channel (p. 118) will be inserted as the lower bits. (The block number is not actually a channel, but corresponds to the "part" within a GS sound module. On the PCR-30/50/80, this corresponds to the channel for the sake of convenience.)

Current channel	1	2	3	4	5	6	7	8	9	10	11	12	13	14	15	16
CH	0	1	2	3	4	5	6	7	8	9	A	B	C	D	E	F
BL	1	2	3	4	5	6	7	8	9	0	A	B	C	D	E	F

For an actual example, refer to "Bend Pitch Control" (p. 144) in the section on the Edit Mode.

1. Press the **[DATA]** key several times at the location where you want to input the channel/block number, to select "0CH" for the channel or "0BL" for the block.

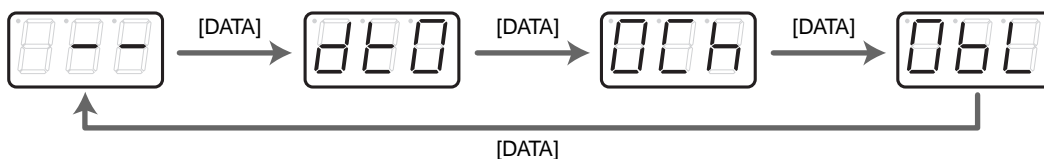

2. Use the **[0]–[7]** keys to input the value of the upper four bits. The "0" in the display will change to the numerical value that you input.
3. Press the **[ENTER]** button.

V-LINK mode

When you press the [V-LINK] button, the PCR will transmit a V-LINK ON message and will enter V-LINK mode. When you press the [V-LINK] button once again, the PCR will transmit a V-LINK OFF message and will exit V-LINK mode.

When the PCR enters V-LINK mode, it will transmit the following parameters to the V-LINK host.

- **Clip Ctrl Rx MIDI ch : 16**
- **Color Ctrl Rx MIDI ch : 16**
- **Sender Model Name : EDIROL PCR**

In V-LINK mode, the PCR will operate as follows.

- Messages from the PCR itself will be transmitted to both the MIDI connector and the USB connector.
- * *In V-LINK mode, you cannot use the MIDI connectors as a USB MIDI interface.*
- When you play the keyboard, program change messages or bank select MSB messages will be transmitted in addition to note messages.
- * *The program change messages and bank select MSB messages will be transmitted on channel 16.*

Note	Number	Program Change	Bank Select MSB
C2	36	1	
C#2	37		0
D2	38	2	
D#2	39		1
E2	40	3	
F2	41	4	
F#2	42		2
G2	43	5	
G#2	44		3
A2	45	6	
A#2	46		4
B2	47	7	
C3	48	8	
C#3	49		5
D3	50	9	
D#3	51		6
E3	52	10	
F3	53	11	
F#3	54		7
G3	55	12	
G#3	56		8
A3	57	13	
A#3	58		9
B3	59	14	
C4	60	15	
C#4	61		10
D4	62	16	
D#4	63		11
E4	64	17	
F4	65	18	
F#4	66		12
G4	67	19	
G#4	68		13
A4	69	20	
A#4	70		14
B4	71	21	
C5	72	22	
C#5	73		15
D5	74	23	
D#5	75		16
E5	76	24	
F5	77	25	
F#5	78		17
G5	79	26	
G#5	80		18
A5	81	27	
A#5	82		19
B5	83	28	
C6	84	29	
C#6	85		
D6	86	30	
D#6	87		
E6	88	31	
F6	89	21	

Memory sets

With the factory settings, the GM2 set shown in the illustration is assigned to the controllers.

Use the included template.

The following memory sets are also provided.

GM2 set (MEMORY: 0) (p. 164)
MCR-8 MODE 3(SONAR 2) SET (p. 165)
 MCR-8 MODE 3(SONAR 2) - A (MEMORY: 1) (p. 165)
 MCR-8 MODE 3(SONAR 2) - B (MEMORY: 2) (p. 165)
 MCR-8 MODE 3(SONAR 2) - C (MEMORY: 3) (p. 165)
 MCR-8 MODE 3(SONAR 2) - D (MEMORY: 4) (p. 165)
MCR-8 MODE 4(Cubase 5/SX) SET (p. 166)
 MCR-8 MODE 4(Cubase 5/SX) - A (MEMORY: 5) (p. 166)
 MCR-8 MODE 4(Cubase 5/SX) - B (MEMORY: 6) (p. 166)
 MCR-8 MODE 4(Cubase 5/SX) - C (MEMORY: 7) (p. 166)
 MCR-8 MODE 4(Cubase 5/SX) - D (MEMORY: 8) (p. 166)

H-COMPATIBLE (ProTools LE, Digital Performer) SET (MEMORY: 9) (p. 167)
GS SET (p. 167)
 GS-A (MEMORY: A) (p. 167)
 GS-B (MEMORY: B) (p. 168)
 GS-C (MEMORY: C) (p. 168)
XG SET (p. 169)
 XG-A (MEMORY: D) (p. 169)
 XG-B (MEMORY: E) (p. 169)

For details on settings for actually using each memory set with your application, refer to the Read Me file for each memory set, located in the Memory Files folder of the CD-ROM.

You can download the latest additional memory sets from the following website.

■ GM2 set (MEMORY: 0)

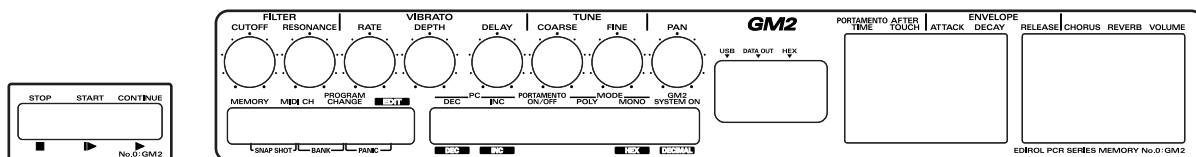

	Parameter	Message (Hex.)	Range (Hex.)	Ch.	Port
R1	FILTER CUTOFF	CC 74(4A)	0(00) - 127(7F)	1	1
R2	FILTER RESONANCE	CC 71(47)	0(00) - 127(7F)	1	1
R3	VIBRATO RATE	CC 76(4C)	0(00) - 127(7F)	1	1
R4	VIBRATO DEPTH	CC 77(4D)	0(00) - 127(7F)	1	1
R5	VIBRATO DELAY	CC 78(4E)	0(00) - 127(7F)	1	1
R6	COARSE TUNING	RPN 0/2(00/02)	0/- (00/--) - 127/- (-7F/--)	1	1
R7	FINE TUNING	RPN 0/1(00/01)	0/0(00/00) - 127/127(7F/7F)	1	1
R8	PAN (CHANNEL)	CC 10(0A)	0(00) - 127(7F)	1	1
S1	PORTAMENTO TIME	CC 5(05)	0(00) - 127(7F)	1	1
S2	AFTERTOUCH	CHANNEL PRESSURE	0(00) - 127(7F)	1	1
S3	ENVELOPE ATTACK	CC 73(49)	0(00) - 127(7F)	1	1
S4	ENVELOPE DECAY	CC 75(4B)	0(00) - 127(7F)	1	1
S5	ENVELOPE RELEASE	CC 72(48)	0(00) - 127(7F)	1	1
S6	CHORUS	CC 93(5D)	0(00) - 127(7F)	1	1
S7	REVERB	CC 91(5B)	0(00) - 127(7F)	1	1
S8	VOLUME (CHANNEL)	CC 7(07)	0(00) - 127(7F)	1	1
B1	PROGRAM CHANGE DEC	PROGRAM CHANGE	min:1(00)	-	-
B2	PROGRAM CHANGE INC	PROGRAM CHANGE	max:128(7F)	-	-
B3	PORTAMENTO ON/OFF	CC 65(41)	0(00) / 127(7F)	1	1
B4	POLY MODE ON	B0 7F 00	-	1	1
B5	MONO MODE ON	B0 7E 01	-	1	1
B6	GM2 SYSTEM ON	F0 7E 7F 09 03 F7	-	-	1
L1	STOP	FC	-	-	2
L2	START	FA	-	-	2
L3	CONTINUE	FB	-	-	2
P1	HOLD	CC 64(40)	0(00) / 127(7F)	1	1
P2	EXPRESSION	CC 11(0B)	0(00) - 127(7F)	1	1

■ MCR-8 MODE 3(SONAR 2) SET

When using this memory set, turn the PCR-30/50/80's OMNI (p. 149) setting OFF.

* To display the external controller toolbar, open Display / Toolbars, and select External Controllers.

MCR-8 MODE 3(SONAR 2) - A (MEMORY: 1)

	Parameter	Message (Hex.)	Range (Hex.)	Ch.	Port
R1	TRACK 1 *1	CC 16(10)	0(00) - 127(7F)	1	2
R2	TRACK 2 *1	CC 16(10)	0(00) - 127(7F)	2	2
R3	TRACK 3 *1	CC 16(10)	0(00) - 127(7F)	3	2
R4	TRACK 4 *1	CC 16(10)	0(00) - 127(7F)	4	2
R5	TRACK 5 *1	CC 16(10)	0(00) - 127(7F)	5	2
R6	TRACK 6 *1	CC 16(10)	0(00) - 127(7F)	6	2
R7	TRACK 7 *1	CC 16(10)	0(00) - 127(7F)	7	2
R8	TRACK 8 *1	CC 16(10)	0(00) - 127(7F)	8	2
S1	TRACK 1 *2	CC 17(11)	0(00) - 127(7F)	1	2
S2	TRACK 2 *2	CC 17(11)	0(00) - 127(7F)	2	2
S3	TRACK 3 *2	CC 17(11)	0(00) - 127(7F)	3	2
S4	TRACK 4 *2	CC 17(11)	0(00) - 127(7F)	4	2
S5	TRACK 5 *2	CC 17(11)	0(00) - 127(7F)	5	2
S6	TRACK 6 *2	CC 17(11)	0(00) - 127(7F)	6	2
S7	TRACK 7 *2	CC 17(11)	0(00) - 127(7F)	7	2
S8	TRACK 8 *2	CC 17(11)	0(00) - 127(7F)	8	2
B1	TRACK 1 *3	CC 80(50)	0(00) / 127(7F)	1	2
B2	TRACK 2 *3	CC 80(50)	0(00) / 127(7F)	2	2
B3	TRACK 3 *3	CC 80(50)	0(00) / 127(7F)	3	2
B4	TRACK 4 *3	CC 80(50)	0(00) / 127(7F)	4	2
B5	TRACK 5 *3	CC 80(50)	0(00) / 127(7F)	5	2
B6	TRACK 6 *3	CC 80(50)	0(00) / 127(7F)	6	2
L1	<<	CC 82(52)	0(00) / 127(7F)	13	2
L2	■ Stop	CC 82(52)	0(00) / 127(7F)	14	2
L3	> Play	CC 82(52)	0(00) / 127(7F)	15	2
P1	HOLD	CC 64(40)	0(00) / 127(7F)	1	1
P2	EXPRESSION	CC 11(0B)	0(00) - 127(7F)	1	1

MCR-8 MODE 3(SONAR 2) - B (MEMORY: 2)

	Parameter	Message (Hex.)	Range (Hex.)	Ch.	Port
R1	TRACK 1 *1	CC 16(10)	0(00) - 127(7F)	1	2
R2	TRACK 2 *1	CC 16(10)	0(00) - 127(7F)	2	2
R3	TRACK 3 *1	CC 16(10)	0(00) - 127(7F)	3	2
R4	TRACK 4 *1	CC 16(10)	0(00) - 127(7F)	4	2
R5	TRACK 5 *1	CC 16(10)	0(00) - 127(7F)	5	2
R6	TRACK 6 *1	CC 16(10)	0(00) - 127(7F)	6	2
R7	TRACK 7 *1	CC 16(10)	0(00) - 127(7F)	7	2
R8	TRACK 8 *1	CC 16(10)	0(00) - 127(7F)	8	2
S1	TRACK 1 *2	CC 17(11)	0(00) - 127(7F)	1	2
S2	TRACK 2 *2	CC 17(11)	0(00) - 127(7F)	2	2
S3	TRACK 3 *2	CC 17(11)	0(00) - 127(7F)	3	2
S4	TRACK 4 *2	CC 17(11)	0(00) - 127(7F)	4	2
S5	TRACK 5 *2	CC 17(11)	0(00) - 127(7F)	5	2
S6	TRACK 6 *2	CC 17(11)	0(00) - 127(7F)	6	2
S7	TRACK 7 *2	CC 17(11)	0(00) - 127(7F)	7	2
S8	TRACK 8 *2	CC 17(11)	0(00) - 127(7F)	8	2
B1	TRACK 1 *4	CC 81(51)	0(00) / 127(7F)	1	2
B2	TRACK 2 *4	CC 81(51)	0(00) / 127(7F)	2	2
B3	TRACK 3 *4	CC 81(51)	0(00) / 127(7F)	3	2
B4	TRACK 4 *4	CC 81(51)	0(00) / 127(7F)	4	2
B5	TRACK 5 *4	CC 81(51)	0(00) / 127(7F)	5	2
B6	TRACK 6 *4	CC 81(51)	0(00) / 127(7F)	6	2
L1	<<	CC 82(52)	0(00) / 127(7F)	13	2
L2	■ Stop	CC 82(52)	0(00) / 127(7F)	14	2
L3	> Play	CC 82(52)	0(00) / 127(7F)	15	2
P1	HOLD	CC 64(40)	0(00) / 127(7F)	1	1
P2	EXPRESSION	CC 11(0B)	0(00) - 127(7F)	1	1

MCR-8 MODE 3(SONAR 2) - C (MEMORY: 3)

	Parameter	Message (Hex.)	Range (Hex.)	Ch.	Port
R1	TRACK 9 *1	CC 16(10)	0(00) - 127(7F)	9	2
R2	TRACK 10 *1	CC 16(10)	0(00) - 127(7F)	10	2
R3	TRACK 11 *1	CC 16(10)	0(00) - 127(7F)	11	2
R4	TRACK 12 *1	CC 16(10)	0(00) - 127(7F)	12	2
R5	TRACK 13 *1	CC 16(10)	0(00) - 127(7F)	13	2
R6	TRACK 14 *1	CC 16(10)	0(00) - 127(7F)	14	2
R7	TRACK 15 *1	CC 16(10)	0(00) - 127(7F)	15	2
R8	TRACK 16 *1	CC 16(10)	0(00) - 127(7F)	16	2
S1	TRACK 9 *2	CC 17(11)	0(00) - 127(7F)	9	2
S2	TRACK 10 *2	CC 17(11)	0(00) - 127(7F)	10	2
S3	TRACK 11 *2	CC 17(11)	0(00) - 127(7F)	11	2
S4	TRACK 12 *2	CC 17(11)	0(00) - 127(7F)	12	2
S5	TRACK 13 *2	CC 17(11)	0(00) - 127(7F)	13	2
S6	TRACK 14 *2	CC 17(11)	0(00) - 127(7F)	14	2
S7	TRACK 15 *2	CC 17(11)	0(00) - 127(7F)	15	2
S8	TRACK 16 *2	CC 17(11)	0(00) - 127(7F)	16	2
B1	TRACK 9 *3	CC 80(50)	0(00) / 127(7F)	9	2
B2	TRACK 10 *3	CC 80(50)	0(00) / 127(7F)	10	2
B3	TRACK 11 *3	CC 80(50)	0(00) / 127(7F)	11	2
B4	TRACK 12 *3	CC 80(50)	0(00) / 127(7F)	12	2
B5	TRACK 13 *3	CC 80(50)	0(00) / 127(7F)	13	2
B6	TRACK 14 *3	CC 80(50)	0(00) / 127(7F)	14	2
L1	Automation Write	CC 82(52)	0(00) / 127(7F)	12	2
L2	■ Stop	CC 82(52)	0(00) / 127(7F)	14	2
L3	Rec	CC 82(52)	0(00) / 127(7F)	11	2
P1	HOLD	CC 64(40)	0(00) / 127(7F)	1	1
P2	EXPRESSION	CC 11(0B)	0(00) - 127(7F)	1	1

MCR-8 MODE 3(SONAR 2) - D (MEMORY: 4)

	Parameter	Message (Hex.)	Range (Hex.)	Ch.	Port
R1	TRACK 9 *1	CC 16(10)	0(00) - 127(7F)	9	2
R2	TRACK 10 *1	CC 16(10)	0(00) - 127(7F)	10	2
R3	TRACK 11 *1	CC 16(10)	0(00) - 127(7F)	11	2
R4	TRACK 12 *1	CC 16(10)	0(00) - 127(7F)	12	2
R5	TRACK 13 *1	CC 16(10)	0(00) - 127(7F)	13	2
R6	TRACK 14 *1	CC 16(10)	0(00) - 127(7F)	14	2
R7	TRACK 15 *1	CC 16(10)	0(00) - 127(7F)	15	2
R8	TRACK 16 *1	CC 16(10)	0(00) - 127(7F)	16	2
S1	TRACK 9 *2	CC 17(11)	0(00) - 127(7F)	9	2
S2	TRACK 10 *2	CC 17(11)	0(00) - 127(7F)	10	2
S3	TRACK 11 *2	CC 17(11)	0(00) - 127(7F)	11	2
S4	TRACK 12 *2	CC 17(11)	0(00) - 127(7F)	12	2
S5	TRACK 13 *2	CC 17(11)	0(00) - 127(7F)	13	2
S6	TRACK 14 *2	CC 17(11)	0(00) - 127(7F)	14	2
S7	TRACK 15 *2	CC 17(11)	0(00) - 127(7F)	15	2
S8	TRACK 16 *2	CC 17(11)	0(00) - 127(7F)	16	2
B1	TRACK 9 *4	CC 81(51)	0(00) / 127(7F)	9	2
B2	TRACK 10 *4	CC 81(51)	0(00) / 127(7F)	10	2
B3	TRACK 11 *4	CC 81(51)	0(00) / 127(7F)	11	2
B4	TRACK 12 *4	CC 81(51)	0(00) / 127(7F)	12	2
B5	TRACK 13 *4	CC 81(51)	0(00) / 127(7F)	13	2
B6	TRACK 14 *4	CC 81(51)	0(00) / 127(7F)	14	2
L1	Automation Write	CC 82(52)	0(00) / 127(7F)	12	2
L2	■ Stop	CC 82(52)	0(00) / 127(7F)	14	2
L3	Rec	CC 82(52)	0(00) / 127(7F)	11	2
P1	HOLD	CC 64(40)	0(00) / 127(7F)	1	1
P2	EXPRESSION	CC 11(0B)	0(00) - 127(7F)	1	1

Generic Surface Preset	*1	*2	*3	*4
Roland MCR-8 (Aux Send 1)	Aux Send 1 Pan	Aux Send 1 Level	Aux Send 1 Pre/Post	Aux Send 1 Enable
Roland MCR-8 (Aux Send 2)	Aux Send 2 Pan	Aux Send 2 Level	Aux Send 2 Pre/Post	Aux Send 2 Enable
Roland MCR-8 (Mute + Solo)	Pan	Volume	Mute	Solo
Roland MCR-8 (Record Arming)	Pan	Volume	White Arm	Record Arm

■ MCR-8 MODE 4(Cubase 5/SX) SET

When using this memory set, turn the PCR-30/50/80's OMNI (p. 149) setting OFF.

MCR-8 MODE 4(Cubase 5/SX) - A (MEMORY: 5)

	Parameter	Message (Hex.)	Range (Hex.)	Ch.	Port
R1	TRACK 1 PAN	CC 72(48)	0(00) - 127(7F)	16	2
R2	TRACK 2 PAN	CC 73(49)	0(00) - 127(7F)	16	2
R3	TRACK 3 PAN	CC 74(4A)	0(00) - 127(7F)	16	2
R4	TRACK 4 PAN	CC 75(4B)	0(00) - 127(7F)	16	2
R5	TRACK 5 PAN	CC 76(4C)	0(00) - 127(7F)	16	2
R6	TRACK 6 PAN	CC 77(4D)	0(00) - 127(7F)	16	2
R7	TRACK 7 PAN	CC 78(4E)	0(00) - 127(7F)	16	2
R8	TRACK 8 PAN	CC 79(4F)	0(00) - 127(7F)	16	2
S1	TRACK 1 FADER	CC 64(40)	0(00) - 127(7F)	16	2
S2	TRACK 2 FADER	CC 65(41)	0(00) - 127(7F)	16	2
S3	TRACK 3 FADER	CC 66(42)	0(00) - 127(7F)	16	2
S4	TRACK 4 FADER	CC 67(43)	0(00) - 127(7F)	16	2
S5	TRACK 5 FADER	CC 68(44)	0(00) - 127(7F)	16	2
S6	TRACK 6 FADER	CC 69(45)	0(00) - 127(7F)	16	2
S7	TRACK 7 FADER	CC 70(46)	0(00) - 127(7F)	16	2
S8	TRACK 8 FADER	CC 71(47)	0(00) - 127(7F)	16	2
B1	TRACK 1 SOLO	CC 0(00)	0(00) / 127(7F)	16	2
B2	TRACK 2 SOLO	CC 1(01)	0(00) / 127(7F)	16	2
B3	TRACK 3 SOLO	CC 2(02)	0(00) / 127(7F)	16	2
B4	TRACK 4 SOLO	CC 3(03)	0(00) / 127(7F)	16	2
B5	TRACK 5 SOLO	CC 4(04)	0(00) / 127(7F)	16	2
B6	TRACK 6 SOLO	CC 5(05)	0(00) / 127(7F)	16	2
L1	<<	CC 19(13)	0(00) / 127(7F)	16	2
L2	■ Stop	CC 21(15)	0(00) / 127(7F)	16	2
L3	> Play	CC 22(16)	0(00) / 127(7F)	16	2
P1	HOLD	CC 64(40)	0(00) / 127(7F)	1	1
P2	EXPRESSION	CC 11(0B)	0(00) - 127(7F)	1	1

MCR-8 MODE 4(Cubase 5/SX) - B (MEMORY: 6)

	Parameter	Message (Hex.)	Range (Hex.)	Ch.	Port
R1	TRACK 1 PAN	CC 72(48)	0(00) - 127(7F)	16	2
R2	TRACK 2 PAN	CC 73(49)	0(00) - 127(7F)	16	2
R3	TRACK 3 PAN	CC 74(4A)	0(00) - 127(7F)	16	2
R4	TRACK 4 PAN	CC 75(4B)	0(00) - 127(7F)	16	2
R5	TRACK 5 PAN	CC 76(4C)	0(00) - 127(7F)	16	2
R6	TRACK 6 PAN	CC 77(4D)	0(00) - 127(7F)	16	2
R7	TRACK 7 PAN	CC 78(4E)	0(00) - 127(7F)	16	2
R8	TRACK 8 PAN	CC 79(4F)	0(00) - 127(7F)	16	2
S1	TRACK 1 FADER	CC 64(40)	0(00) - 127(7F)	16	2
S2	TRACK 2 FADER	CC 65(41)	0(00) - 127(7F)	16	2
S3	TRACK 3 FADER	CC 66(42)	0(00) - 127(7F)	16	2
S4	TRACK 4 FADER	CC 67(43)	0(00) - 127(7F)	16	2
S5	TRACK 5 FADER	CC 68(44)	0(00) - 127(7F)	16	2
S6	TRACK 6 FADER	CC 69(45)	0(00) - 127(7F)	16	2
S7	TRACK 7 FADER	CC 70(46)	0(00) - 127(7F)	16	2
S8	TRACK 8 FADER	CC 71(47)	0(00) - 127(7F)	16	2
B1	TRACK 1 MUTE	CC 40(28)	0(00) / 127(7F)	16	2
B2	TRACK 2 MUTE	CC 41(29)	0(00) / 127(7F)	16	2
B3	TRACK 3 MUTE	CC 42(2A)	0(00) / 127(7F)	16	2
B4	TRACK 4 MUTE	CC 43(2B)	0(00) / 127(7F)	16	2
B5	TRACK 5 MUTE	CC 44(2C)	0(00) / 127(7F)	16	2
B6	TRACK 6 MUTE	CC 45(2D)	0(00) / 127(7F)	16	2
L1	<<	CC 19(13)	0(00) / 127(7F)	16	2
L2	■ Stop	CC 21(15)	0(00) / 127(7F)	16	2
L3	> Play	CC 22(16)	0(00) / 127(7F)	16	2
P1	HOLD	CC 64(40)	0(00) / 127(7F)	1	1
P2	EXPRESSION	CC 11(0B)	0(00) - 127(7F)	1	1

MCR-8 MODE 4(Cubase 5/SX) - C (MEMORY: 7)

	Parameter	Message (Hex.)	Range (Hex.)	Ch.	Port
R1	TRACK 9 PAN	CC 56(38)	0(00) - 127(7F)	16	2
R2	TRACK 10 PAN	CC 57(39)	0(00) - 127(7F)	16	2
R3	TRACK 11 PAN	CC 58(3A)	0(00) - 127(7F)	16	2
R4	TRACK 12 PAN	CC 59(3B)	0(00) - 127(7F)	16	2
R5	TRACK 13 PAN	CC 60(3C)	0(00) - 127(7F)	16	2
R6	TRACK 14 PAN	CC 61(3D)	0(00) - 127(7F)	16	2
R7	TRACK 15 PAN	CC 62(3E)	0(00) - 127(7F)	16	2
R8	TRACK 16 PAN	CC 63(3F)	0(00) - 127(7F)	16	2
S1	TRACK 9 FADER	CC 48(30)	0(00) - 127(7F)	16	2
S2	TRACK 10 FADER	CC 49(31)	0(00) - 127(7F)	16	2
S3	TRACK 11 FADER	CC 50(32)	0(00) - 127(7F)	16	2
S4	TRACK 12 FADER	CC 51(33)	0(00) - 127(7F)	16	2
S5	TRACK 13 FADER	CC 52(34)	0(00) - 127(7F)	16	2
S6	TRACK 14 FADER	CC 53(35)	0(00) - 127(7F)	16	2
S7	TRACK 15 FADER	CC 54(36)	0(00) - 127(7F)	16	2
S8	TRACK 16 FADER	CC 55(37)	0(00) - 127(7F)	16	2
B1	TRACK 9 SOLO	CC 32(20)	0(00) / 127(7F)	16	2
B2	TRACK 10 SOLO	CC 33(21)	0(00) / 127(7F)	16	2
B3	TRACK 11 SOLO	CC 34(22)	0(00) / 127(7F)	16	2
B4	TRACK 12 SOLO	CC 35(23)	0(00) / 127(7F)	16	2
B5	TRACK 13 SOLO	CC 36(24)	0(00) / 127(7F)	16	2
B6	TRACK 14 SOLO	CC 37(25)	0(00) / 127(7F)	16	2
L1	<<	CC 20(14)	0(00) / 127(7F)	16	2
L2	■ Stop	CC 21(15)	0(00) / 127(7F)	16	2
L3	Rec	CC 23(17)	0(00) / 127(7F)	16	2
P1	HOLD	CC 64(40)	0(00) / 127(7F)	1	1
P2	EXPRESSION	CC 11(0B)	0(00) - 127(7F)	1	1

MCR-8 MODE 4(Cubase 5/SX) - D (MEMORY: 8)

	Parameter	Message (Hex.)	Range (Hex.)	Ch.	Port
R1	TRACK 9 PAN	CC 56(38)	0(00) - 127(7F)	16	2
R2	TRACK 10 PAN	CC 57(39)	0(00) - 127(7F)	16	2
R3	TRACK 11 PAN	CC 58(3A)	0(00) - 127(7F)	16	2
R4	TRACK 12 PAN	CC 59(3B)	0(00) - 127(7F)	16	2
R5	TRACK 13 PAN	CC 60(3C)	0(00) - 127(7F)	16	2
R6	TRACK 14 PAN	CC 61(3D)	0(00) - 127(7F)	16	2
R7	TRACK 15 PAN	CC 62(3E)	0(00) - 127(7F)	16	2
R8	TRACK 16 PAN	CC 63(3F)	0(00) - 127(7F)	16	2
S1	TRACK 9 FADER	CC 48(30)	0(00) - 127(7F)	16	2
S2	TRACK 10 FADER	CC 49(31)	0(00) - 127(7F)	16	2
S3	TRACK 11 FADER	CC 50(32)	0(00) - 127(7F)	16	2
S4	TRACK 12 FADER	CC 51(33)	0(00) - 127(7F)	16	2
S5	TRACK 13 FADER	CC 52(34)	0(00) - 127(7F)	16	2
S6	TRACK 14 FADER	CC 53(35)	0(00) - 127(7F)	16	2
S7	TRACK 15 FADER	CC 54(36)	0(00) - 127(7F)	16	2
S8	TRACK 16 FADER	CC 55(37)	0(00) - 127(7F)	16	2
B1	TRACK 9 MUTE	CC 88(58)	0(00) / 127(7F)	16	2
B2	TRACK 10 MUTE	CC 89(59)	0(00) / 127(7F)	16	2
B3	TRACK 11 MUTE	CC 90(5A)	0(00) / 127(7F)	16	2
B4	TRACK 12 MUTE	CC 91(5B)	0(00) / 127(7F)	16	2
B5	TRACK 13 MUTE	CC 92(5C)	0(00) / 127(7F)	16	2
B6	TRACK 14 MUTE	CC 93(5D)	0(00) / 127(7F)	16	2
L1	<<	CC 20(14)	0(00) / 127(7F)	16	2
L2	■ Stop	CC 21(15)	0(00) / 127(7F)	16	2
L3	Rec	CC 23(17)	0(00) / 127(7F)	16	2
P1	HOLD	CC 64(40)	0(00) / 127(7F)	1	1
P2	EXPRESSION	CC 11(0B)	0(00) - 127(7F)	1	1

■ H-COMPATIBLE (ProTools LE, Digital Performer) SET (MEMORY: 9)

When using this memory set, turn the PCR-30/50/80's OMNI (p. 149) setting OFF, and turn the H-ACTIVITY (p. 154) setting ON.

	Parameter	Message (Hex.)	Range (Hex.)	Ch.	Port
R1	ROTARY ENCODER 1	B0 40 dd	DEC(01) / INC(41)	-	2
R2	ROTARY ENCODER 2	B0 41 dd	DEC(01) / INC(41)	-	2
R3	ROTARY ENCODER 3	B0 42 dd	DEC(01) / INC(41)	-	2
R4	ROTARY ENCODER 4	B0 43 dd	DEC(01) / INC(41)	-	2
R5	ROTARY ENCODER 5	B0 44 dd	DEC(01) / INC(41)	-	2
R6	ROTARY ENCODER 6	B0 45 dd	DEC(01) / INC(41)	-	2
R7	ROTARY ENCODER 7	B0 46 dd	DEC(01) / INC(41)	-	2
R8	ROTARY ENCODER 8	B0 47 dd	DEC(01) / INC(41)	-	2
S1	FADER 1	B0 0F 00 B0 2F 40 B0 00 dd B0 20 00 B0 0F 00 B0 2F 00	0(00) - 127(7F)	-	2
S2	FADER 2	B0 0F 01 B0 2F 40 B0 01 dd B0 21 00 B0 0F 01 B0 2F 00	0(00) - 127(7F)	-	2
S3	FADER 3	B0 0F 02 B0 2F 40 B0 02 dd B0 22 00 B0 0F 02 B0 2F 00	0(00) - 127(7F)	-	2
S4	FADER 4	B0 0F 03 B0 2F 40 B0 03 dd B0 23 00 B0 0F 03 B0 2F 00	0(00) - 127(7F)	-	2
S5	FADER 5	B0 0F 04 B0 2F 40 B0 04 dd B0 24 00 B0 0F 04 B0 2F 00	0(00) - 127(7F)	-	2
S6	FADER 6	B0 0F 05 B0 2F 40 B0 05 dd B0 25 00 B0 0F 05 B0 2F 00	0(00) - 127(7F)	-	2
S7	FADER 7	B0 0F 06 B0 2F 40 B0 06 dd B0 26 00 B0 0F 06 B0 2F 00	0(00) - 127(7F)	-	2
S8	FADER 8	B0 0F 07 B0 2F 40 B0 07 dd B0 27 00 B0 0F 07 B0 2F 00	0(00) - 127(7F)	-	2
B1	MUTE 1	B0 0F 00 B0 2F dd	ON(42) / OFF(02)	-	2
B2	SOLO 1	B0 0F 00 B0 2F dd	ON(43) / OFF(03)	-	2
B3	REC 1	B0 0F 00 B0 2F dd	ON(47) / OFF(07)	-	2
B4	WRITE 1	B0 0F 00 B0 2F dd	ON(44) / OFF(04)	-	2
B5	TRACK <	B0 0F 0A B0 2F dd	ON(40) / OFF(00)	-	2
B6	TRACK >	B0 0F 0A B0 2F dd	ON(42) / OFF(02)	-	2
L1	REWIND	B0 0F 0E B0 2F dd	ON(41) / OFF(01)	-	2
L2	STOP	B0 0F 0E B0 2F dd	ON(43) / OFF(03)	-	2
L3	PLAY	B0 0F 0E B0 2F dd	ON(44) / OFF(04)	-	2
P1	HOLD	CC 64(40)	0(00) / 127(7F)	1	1
P2	EXPRESSION	CC 11(0B)	0(00) - 127(7F)	1	1

■ GS SET

When using this memory set, you will find it convenient to turn the PCR-30/50/80's OMNI (p. 149) setting ON.

GS-A (MEMORY: A)

	Parameter	Message (Hex.)	Range (Hex.)	Ch.	Port
R1	REVERB MACRO	F0 41 10 42 12 40 01 30 dd SUM F7	0(00) - 7(07)	-	1
R2	REVERB CHARACTER	F0 41 10 42 12 40 01 31 dd SUM F7	0(00) - 7(07)	-	1
R3	REVERB PRE-LPF	F0 41 10 42 12 40 01 32 dd SUM F7	0(00) - 7(07)	-	1
R4	REVERB TIME	F0 41 10 42 12 40 01 34 dd SUM F7	0(00) - 127(7F)	-	1
R5	REVERB PREDELAY TIME	F0 41 10 42 12 40 01 37 dd SUM F7	0(00) - 127(7F)	-	1
R6	REVERB DELAY FEEDBACK	F0 41 10 42 12 40 01 35 dd SUM F7	0(00) - 127(7F)	-	1
R7	REVERB LEVEL	F0 41 10 42 12 40 01 33 dd SUM F7	0(00) - 127(7F)	-	1
R8	PART PANPOT	F0 41 10 42 12 40 1x 1C dd SUM F7	1(01) - 127(7F)	BLOCK	1
S1	VIBRATO RATE	F0 41 10 42 12 40 1x 30 dd SUM F7	0(00) - 64(40) - 127(7F)	BLOCK	1
S2	VIBRATO DEPTH	F0 41 10 42 12 40 1x 31 dd SUM F7	0(00) - 64(40) - 127(7F)	BLOCK	1
S3	VIBRATO DELAY	F0 41 10 42 12 40 1x 37 dd SUM F7	0(00) - 64(40) - 127(7F)	BLOCK	1
S4	TVF&TV A ENV. ATTACK	F0 41 10 42 12 40 1x 34 dd SUM F7	0(00) - 64(40) - 127(7F)	BLOCK	1
S5	TVF&TV A ENV. DECAY	F0 41 10 42 12 40 1x 35 dd SUM F7	0(00) - 64(40) - 127(7F)	BLOCK	1
S6	TVF&TV A ENV. RELEASE	F0 41 10 42 12 40 1x 36 dd SUM F7	0(00) - 64(40) - 127(7F)	BLOCK	1
S7	REVERB SEND LEVEL	F0 41 10 42 12 40 1x 22 dd SUM F7	0(00) - 127(7F)	BLOCK	1
S8	PART LEVEL	F0 41 10 42 12 40 1x 19 dd SUM F7	0(00) - 127(7F)	BLOCK	1
B1	PROGRAM CHANGE DEC	PROGRAM CHANGE	min:1 (00)	-	-
B2	PROGRAM CHANGE INC	PROGRAM CHANGE	max:128 (7F)	-	-
B3	NRPN ON/OFF	F0 41 10 42 12 40 1x 0A dd SUM F7	OFF(00) / ON(01)	BLOCK	1
B4	RANDOM PAN	F0 41 10 42 12 40 1x 1C 00 SUM F7	-	BLOCK	1
B5	MODE POLY/MONO	F0 41 10 42 12 40 1x 13 dd SUM F7	MONO(00) / POLY(01)	BLOCK	1
B6	GS RESET	F0 41 10 42 12 40 00 7F 00 41 F7	-	-	1
L1	STOP	FC	-	-	2
L2	START	FA	-	-	2
L3	CONTINUE	FB	-	-	2
P1	HOLD	CC 64(40)	0(00) / 127(7F)	1	1
P2	EXPRESSION	CC 11(0B)	0(00) - 127(7F)	1	1

GS-B (MEMORY: B)

	Parameter	Message (Hex.)	Range (Hex.)	Ch.	Port
R1	CHORUS MACRO	F0 41 10 42 12 40 01 38 dd SUM F7	0(00) - 7(07)	-	1
R2	CHORUS PRE-LPF	F0 41 10 42 12 40 01 39 dd SUM F7	0(00) - 7(07)	-	1
R3	CHORUS DELAY	F0 41 10 42 12 40 01 3C dd SUM F7	0(00) - 127(7F)	-	1
R4	CHORUS RATE	F0 41 10 42 12 40 01 3D dd SUM F7	0(00) - 127(7F)	-	1
R5	CHORUS DEPTH	F0 41 10 42 12 40 01 3E dd SUM F7	0(00) - 127(7F)	-	1
R6	CHORUS FEEDBACK	F0 41 10 42 12 40 01 3B dd SUM F7	0(00) - 127(7F)	-	1
R7	CHORUS LEVEL	F0 41 10 42 12 40 01 3A dd SUM F7	0(00) - 127(7F)	-	1
R8	PART PANPOT	F0 41 10 42 12 40 1x 1C dd SUM F7	1(01) - 127(7F)	BLOCK	1
S1	CHORUS SEND LEVEL TO REVERB	F0 41 10 42 12 40 01 3F dd SUM F7	0(00) - 64(40) - 127(7F)	BLOCK	1
S2	CHORUS SEND LEVEL TO DELAY	F0 41 10 42 12 40 01 40 dd SUM F7	0(00) - 64(40) - 127(7F)	BLOCK	1
S3	TVF CUTOFF FREQ	F0 41 10 42 12 40 1x 32 dd SUM F7	0(00) - 64(40) - 127(7F)	BLOCK	1
S4	TVF RESONANCE	F0 41 10 42 12 40 1x 33 dd SUM F7	0(00) - 64(40) - 127(7F)	BLOCK	1
S5	MODULATION DEPTH	F0 41 10 42 12 40 2x 04 dd SUM F7	0(00) - 127(7F)	BLOCK	1
S6	BEND RANGE	F0 41 10 42 12 40 2x 10 dd SUM F7	64(40) - 88(58)	BLOCK	1
S7	CHORUS SEND LEVEL	F0 41 10 42 12 40 1x 21 dd SUM F7	0(00) - 127(7F)	BLOCK	1
S8	PART LEVEL	F0 41 10 42 12 40 1x 19 dd SUM F7	0(00) - 127(7F)	BLOCK	1
B1	PROGRAM CHANGE DEC	PROGRAM CHANGE	min:1 (00)	-	-
B2	PROGRAM CHANGE INC	PROGRAM CHANGE	max:128 (7F)	-	-
B3	NRPN ON/OFF	F0 41 10 42 12 40 1x 0A dd SUM F7	OFF(00) / ON(01)	BLOCK	1
B4	RANDOM PAN	F0 41 10 42 12 40 1x 1C 00 SUM F7	-	BLOCK	1
B5	MODE POLY/MONO	F0 41 10 42 12 40 1x 13 dd SUM F7	MONO(00) / POLY(01)	BLOCK	1
B6	GS RESET	F0 41 10 42 12 40 00 7F 00 41 F7	-	-	1
L1	STOP	FC	-	-	2
L2	START	FA	-	-	2
L3	CONTINUE	FB	-	-	2
P1	HOLD	CC 64(40)	0(00) / 127(7F)	1	1
P2	EXPRESSION	CC 11(0B)	0(00) - 127(7F)	1	1

GS-C (MEMORY: C)

	Parameter	Message (Hex.)	Range (Hex.)	Ch.	Port
R1	DELAY MACRO	F0 41 10 42 12 40 01 50 dd SUM F7	0(00) - 9(09)	-	1
R2	DELAY PRE-LPF	F0 41 10 42 12 40 01 51 dd SUM F7	0(00) - 7(07)	-	1
R3	DELAY TIME RATIO LEFT	F0 41 10 42 12 40 01 53 dd SUM F7	1(01) - 120(78)	-	1
R4	DELAY TIME CENTER	F0 41 10 42 12 40 01 52 dd SUM F7	1(01) - 115(73)	-	1
R5	DELAY TIME RATIO RIGHT	F0 41 10 42 12 40 01 54 dd SUM F7	1(01) - 120(78)	-	1
R6	DELAY FEEDBACK	F0 41 10 42 12 40 01 59 dd SUM F7	0(00) - 64(40) - 127(7F)	-	1
R7	DELAY LEVEL	F0 41 10 42 12 40 01 58 dd SUM F7	0(00) - 127(7F)	-	1
R8	PART PANPOT	F0 41 10 42 12 40 1x 1C dd SUM F7	1(01) - 127(7F)	BLOCK	1
S1	DELAY SEND LEVEL TO REVERB	F0 41 10 42 12 40 01 5A dd SUM F7	0(00) - 127(7F)	-	1
S2	DELAY LEVEL LEFT	F0 41 10 42 12 40 01 56 dd SUM F7	0(00) - 127(7F)	-	1
S3	DELAY LEVEL CENTER	F0 41 10 42 12 40 01 55 dd SUM F7	0(00) - 127(7F)	-	1
S4	DELAY LEVEL RIGHT	F0 41 10 42 12 40 01 57 dd SUM F7	0(00) - 127(7F)	-	1
S5	EQ LOW GAIN	F0 41 10 42 12 40 02 01 dd SUM F7	22(34) - 64(40) - 76(4C)	-	1
S6	EQ HIGH GAIN	F0 41 10 42 12 40 02 03 dd SUM F7	22(34) - 64(40) - 76(4C)	-	1
S7	DELAY SEND LEVEL	F0 41 10 42 12 40 1x 2C dd SUM F7	0(00) - 127(7F)	BLOCK	1
S8	PART LEVEL	F0 41 10 42 12 40 1x 19 dd SUM F7	0(00) - 127(7F)	BLOCK	1
B1	EQ ON / OFF	F0 41 10 42 12 40 4x 20 dd SUM F7	OFF(00) / ON(01)	BLOCK	1
B2	EQ LOW FREQ (200Hz/400Hz)	F0 41 10 42 12 40 02 00 dd SUM F7	200Hz(00) / 400Hz(01)	-	1
B3	EQ HIGH FREQ (3kHz/6kHz)	F0 41 10 42 12 40 02 02 dd SUM F7	3kHz(00) / 6kHz(01)	-	1
B4	RANDOM PAN	F0 41 10 42 12 40 1x 1C 00 SUM F7	-	BLOCK	1
B5	MODE POLY/MONO	F0 41 10 42 12 40 1x 13 dd SUM F7	MONO(00) / POLY(01)	BLOCK	1
B6	GS RESET	F0 41 10 42 12 40 00 7F 00 41 F7	-	-	1
L1	STOP	FC	-	-	2
L2	START	FA	-	-	2
L3	CONTINUE	FB	-	-	2
P1	HOLD	CC 64(40)	0(00) / 127(7F)	1	1
P2	EXPRESSION	CC 11(0B)	0(00) - 127(7F)	1	1

■ XG SET

When using this memory set, you will find it convenient to turn the PCR-30/50/80's OMNI (p. 149) setting ON.

XG-A (MEMORY: D)

	Parameter	Message (Hex.)	Range (Hex.)	Ch.	Port
R1	BEND PITCH CONTROL	F0 43 10 4C 08 0ch 23 dd F7	0(00) - 64(40) - 127(7F)	CURRENT CH	1
R2	BEND FILTER CONTROL	F0 43 10 4C 08 0ch 24 dd F7	0(00) - 64(40) - 127(7F)	CURRENT CH	1
R3	BEND AMPLITUDE CONTROL	F0 43 10 4C 08 0ch 25 dd F7	0(00) - 64(40) - 127(7F)	CURRENT CH	1
R4	PITCH EG INITIAL LEVEL	F0 43 10 4C 08 0ch 69 dd F7	0(00) - 64(40) - 127(7F)	CURRENT CH	1
R5	PITCH EG ATTACK TIME	F0 43 10 4C 08 0ch 6A dd F7	0(00) - 64(40) - 127(7F)	CURRENT CH	1
R6	PITCH EG RELEASE LEVEL	F0 43 10 4C 08 0ch 6B dd F7	0(00) - 64(40) - 127(7F)	CURRENT CH	1
R7	PITCH EG RELEASE TIME	F0 43 10 4C 08 0ch 6C dd F7	0(00) - 64(40) - 127(7F)	CURRENT CH	1
R8	PAN	F0 43 10 4C 08 0ch 0E dd F7	1(01) - 64(40) - 127(7F)	CURRENT CH	1
S1	BEND LFO PMOD DEPTH	F0 43 10 4C 08 0ch 26 dd F7	0(00) - 127(7F)	CURRENT CH	1
S2	BEND LFO FMOD DEPTH	F0 43 10 4C 08 0ch 27 dd F7	0(00) - 127(7F)	CURRENT CH	1
S3	BEND LFO AMOD DEPTH	F0 43 10 4C 08 0ch 28 dd F7	0(00) - 127(7F)	CURRENT CH	1
S4	REVERB SEND	F0 43 10 4C 08 0ch 13 dd F7	0(00) - 127(7F)	CURRENT CH	1
S5	CHORUS SEND	F0 43 10 4C 08 0ch 12 dd F7	0(00) - 127(7F)	CURRENT CH	1
S6	VARIATION SEND	F0 43 10 4C 08 0ch 14 dd F7	0(00) - 127(7F)	CURRENT CH	1
S7	DRY LEVEL	F0 43 10 4C 08 0ch 11 dd F7	0(00) - 127(7F)	CURRENT CH	1
S8	VOLUME	F0 43 10 4C 08 0ch 0B dd F7	0(00) - 127(7F)	CURRENT CH	1
B1	PROGRAM CHANGE DEC	PROGRAM CHANGE	min:1 (00)	-	-
B2	PROGRAM CHANGE INC	PROGRAM CHANGE	max:128 (7F)	-	-
B3	PART MODE NORMAL/DRUM	F0 43 10 4C 08 0ch 07 dd F7	OFF(00) / ON(01)	CURRENT CH	1
B4	RANDOM PAN	F0 43 10 4C 08 0ch 0E 00 F7	-	CURRENT CH	1
B5	MONO/POLY MODE	F0 43 10 4C 08 0ch 05 dd F7	MONO(00) / POLY(01)	CURRENT CH	1
B6	XG SYSTEM ON	F0 43 10 4C 00 00 7E 00 F7	-	-	1
L1	STOP	FC	-	-	2
L2	START	FA	-	-	2
L3	CONTINUE	FB	-	-	2
P1	HOLD	CC 64(40)	0(00) / 127(7F)	1	1
P2	EXPRESSION	CC 11(0B)	0(00) - 127(7F)	1	1

XG-B (MEMORY: E)

	Parameter	Message (Hex.)	Range (Hex.)	Ch.	Port
R1	MW PITCH CONTROL	F0 43 10 4C 08 0ch 1D dd F7	0(00) - 64(40) - 127(7F)	CURRENT CH	1
R2	MW FILTER CONTROL	F0 43 10 4C 08 0ch 1E dd F7	0(00) - 64(40) - 127(7F)	CURRENT CH	1
R3	MW AMPLITUDE CONTROL	F0 43 10 4C 08 0ch 1F dd F7	0(00) - 64(40) - 127(7F)	CURRENT CH	1
R4	REVERB PAN	F0 43 10 4C 02 01 0D dd F7	0(00) - 64(40) - 127(7F)	-	1
R5	CHORUS PAN	F0 43 10 4C 02 01 2D dd F7	0(00) - 64(40) - 127(7F)	-	1
R6	VARIATION PAN	F0 43 10 4C 02 01 57 dd F7	0(00) - 64(40) - 127(7F)	-	1
R7	SEND VARIATION TO REVERB	F0 43 10 4C 02 01 58 dd F7	0(00) - 127(7F)	-	1
R8	SEND VARIATION TO CHORUS	F0 43 10 4C 02 01 59 dd F7	0(00) - 127(7F)	-	1
S1	MW LFO PMOD DEPTH	F0 43 10 4C 08 0ch 20 dd F7	0(00) - 127(7F)	CURRENT CH	1
S2	MW LFO FMOD DEPTH	F0 43 10 4C 08 0ch 21 dd F7	0(00) - 127(7F)	CURRENT CH	1
S3	MW LFO AMOD DEPTH	F0 43 10 4C 08 0ch 22 dd F7	0(00) - 127(7F)	CURRENT CH	1
S4	REVERB RETURN	F0 43 10 4C 02 01 0C dd F7	0(00) - 127(7F)	-	1
S5	CHORUS RETURN	F0 43 10 4C 02 01 2C dd F7	0(00) - 127(7F)	-	1
S6	VARIATION RETURN	F0 43 10 4C 02 01 56 dd F7	0(00) - 127(7F)	-	1
S7	SEND CHORUS TO REVERB	F0 43 10 4C 02 01 2E dd F7	0(00) - 127(7F)	-	1
S8	VOLUME	F0 43 10 4C 08 0ch 0B dd F7	0(00) - 127(7F)	CURRENT CH	1
B1	PROGRAM CHANGE DEC	PROGRAM CHANGE	min:1 (00)	-	-
B2	PROGRAM CHANGE INC	PROGRAM CHANGE	max:128 (7F)	-	-
B3	PART MODE NORMAL/DRUM	F0 43 10 4C 08 0ch 07 dd F7	OFF(00) / ON(01)	CURRENT CH	1
B4	RANDOM PAN	F0 43 10 4C 08 0ch 0E 00 F7	-	CURRENT CH	1
B5	MONO/POLY MODE	F0 43 10 4C 08 0ch 05 dd F7	MONO(00) / POLY(01)	CURRENT CH	1
B6	XG SYSTEM ON	F0 43 10 4C 00 00 7E 00 F7	-	-	1
L1	STOP	FC	-	-	2
L2	START	FA	-	-	2
L3	CONTINUE	FB	-	-	2
P1	HOLD	CC 64(40)	0(00) / 127(7F)	1	1
P2	EXPRESSION	CC 11(0B)	0(00) - 127(7F)	1	1

Troubleshooting



Problems common to Windows and Macintosh



Problems occurring only in Windows



Problems occurring only in Macintosh

Problems related to the USB driver



Cannot install the driver correctly

- **Is the CD-ROM correctly inserted into your CD-ROM drive?**
Installation is not possible unless the CD-ROM included with the PCR-30/50/80 is inserted in your CD-ROM drive. Make sure that the CD-ROM is correctly inserted into your CD-ROM drive.
- **Is the CD-ROM or the lens of the CD-ROM dirty?**
If the CD-ROM or the lens of the CD-ROM drive is dirty, the installer may not work correctly. Clean the disc and/or lens using a commercially-available CD cleaner or lens cleaner.
- **Are you installing the software from a networked CD-ROM drive?**
The software cannot be installed from a networked CD-ROM drive.
- **Is there sufficient free space on your hard disk?**
Delete unneeded files to increase the amount of free space. After deleting the unneeded files, empty the recycling bin.
- **Is the PCR-30/50/80 connected correctly?**
Make sure that the USB connector of your computer is connected to the PCR-30/50/80 by a USB cable.
- **Is the power of the PCR-30/50/80 turned on?**
- **The power switch of the PCR-30/50/80 may have been set to the USB position.**
Make sure that the power switch of the PCR-30/50/80 is set to the DC position. Do not use bus power while installing the driver. Check this, and if you are using Windows, close the **Sound and Multimedia Properties** dialog box (**Sounds and Audio Devices Properties** in Windows XP, and **Multimedia Properties** in Windows 98), re-open the same dialog box once again, and specify the MIDI input/output destinations.



- Using the procedure for **“Deleting the driver”** (p. 173), delete the USB audio device driver installed in your computer, and then re-install the PCR-30/50/80 driver as described in **“Setup”** (p. 13). Also check whether there is any **“Other devices”** in **“Device Manager”** or **“Unknown device”** in **“Universal Serial Bus Controllers”**. If you find any, delete them.



- **Is OMS or FreeMIDI installed?**

The PCR-30/50/80 driver cannot be installed unless **OMS** or **FreeMIDI** are installed. Please install **OMS** or **FreeMIDI**. (→ “Installing & Setting Up the Driver (Macintosh)” (p. 25))



PCR-30/50/80 is not detected when making OMS or FreeMIDI settings

- **Is the PCR-30/50/80 detected?**

Turn the power of the PCR-30/50/80 off, then on again.

Reconnect the USB cable.

If other USB devices are connected, connect only the PCR-30/50/80.

It is possible that the Macintosh did not correctly detect and initialize the PCR-30/50/80. Leave the PCR-30/50/80's USB cable connected, and restart your Macintosh. If it is still not detected, shut down your Macintosh, and then restart it.

The PCR-30/50/80 will not be detected if it is connected to the USB connector on the Macintosh keyboard.

Please connect the PCR-30/50/80 to a USB connector on the Macintosh itself.



“Find new hardware wizard” does not execute automatically



The “Insert Disk” dialog box does not appear



“Find new hardware wizard” ends before the process is completed

- **It may take about 15 seconds (or more) after the USB cable is connected for the PCR-30/50/80 to be detected.**
- **Is the USB cable connected correctly?**
Make sure that the PCR-30/50/80 and your computer are correctly connected via a USB cable.
- **Is USB enabled on your computer?**
Refer to the operation manual for your computer, and make sure that USB is enabled.
- **It has been found that in some cases, not all of the Windows 98 files required to support audio via USB are installed when a computer is shipped.**
Please contact the manufacturer of your computer.
- **Does your computer meet the USB specifications?**
If you are using a computer that does not fulfill the electrical requirements of the USB specifications, operation may be unstable. In this case, you may be able to solve the problem by connecting a USB hub.
If the above actions do not solve the problem, it is possible that the PCR-30/50/80 has been incorrectly detected by the computer. Please reinstall the driver from the beginning of the procedure. (→ “Setup” (p. 13))

“Found unknown device” appears even though you installed the driver

If your computer or USB hub has two or more USB connectors, and you connect the PCR-30/50/80 to a USB connector to which the PCR-30/50/80 has never been connected before, the **“Unknown device”** dialog box may appear even on a computer onto which you have already installed the driver. Refer to **“Setup”** (p. 13), and install the driver once again. This is not a malfunction.

If the "Found unknown device" dialog box appears even though the PCR-30/50/80 is connected to the same USB connector as before, it is possible that the computer has detected the PCR-30/50/80 incorrectly. Please reinstall the driver from the beginning of the procedure. (→**“Setup”** (p. 13))

An “Unknown driver found” dialog box appears, and you are unable to install the driver

Device Manager shows “?”, “!”, or “USB Composite Device”

Driver is not installed correctly

It is possible that the computer has detected the PCR-30/50/80 incorrectly. Please reinstall the driver from the beginning of the procedure. (→**“Setup”** (p. 13))

Can’t install/delete/use the driver in Windows XP/2000

- **Did you log on to Windows as a user with administrative privileges?**
In order to install/delete/re-install the driver in Windows XP/2000, you must be logged into Windows as a user with administrative privileges, such as Administrator. For details, please contact the system administrator for your computer system.
- **Did you make “Driver Signing Options”?**
In order to install/re-install the driver, you must make **“Driver Signing Options”**.
(Windows XP → p. 14, Windows 2000 → p. 18)

Windows XP/2000 displays a “Hardware Installation” or “Digital Signature Not Found” dialog box

- **Did you make “Driver Signing Options”?**
In order to install/re-install the driver, you must make the settings described in **“Driver Signing Options”**.
(Windows XP → p. 14, Windows 2000 → p. 18)

Deleting the driver

If you were unable to install the driver according to the procedure given, the PCR-30/50/80 may not be recognized correctly by the computer. In this case, use the following procedure to delete the driver, and then follow the procedure in “**Setup**” (p. 13) to install the driver once again.

Windows users

Here's how to uninstall the dedicated driver.

1. Start up Windows with the PCR-30/50/80 disconnected.
Disconnect all USB cables other than a USB keyboard or USB mouse.
** If you are using Windows XP Professional/2000, log on as a user that has administrative privileges (e.g., Administrator).*
2. Insert the CD-ROM into the CD-ROM drive of your computer.
3. From the Windows **Start menu**, choose “**Run...**”.
In the **Run dialog** box, input the following into the **Open** field, and click [**OK**].

Windows XP/2000 users:

D:\DRIVER\USB_XP2K\Uninstal.EXE

Windows Me/98 users:

D:\DRIVER\USB_ME98\Uninstal.EXE

** The drive name D: may be different on your system. Use the drive name for your CD-ROM drive.*

4. Follow the on-screen instructions to uninstall the driver.

Macintosh users

1. Turn off the power of the PCR-30/50/80.
Also disconnect the USB cable (by which the PCR-30/50/80 is connected) from your Macintosh.
2. From the **system extensions** folder, drag “**USB PCR**” into the trash to delete it.
3. Delete **PCR** from the **OMS Folder** inside the **System folder**, or drag **PCR Driver** from the **FreeMIDI Folder** inside the **System folder** to the trash.
4. Restart the Macintosh.

MIDI implementation

1. Receive data

■ System exclusive messages

● Universal non-realtime system exclusive message

○ Identity request message

Status	Data byte	Status
F0H	7EH, dev, 06H, 01H	F7H

Byte	Explanation
F0H	Exclusive status
7EH	ID number (Universal non-realtime system exclusive message)
dev	Device ID (10 or 7FH (Broadcast))
06H	Sub ID #1 (PCR-30/50/80)
01H	Sub ID #1 (PCR-30/50/80)
F7H	EOX (End of Exclusive)

● Data transmission

The PCR-30/50/80 can use Bulk Dump (p. 177) to transfer its internal memory set data (p. 164).

○ Data Set 1 (DT1)

These messages transmit the actual data, and are used to transfer data settings to a device.

Status	Data byte	Status
F0H	41H, 10H, 00H, 62H, 12H, aaH, ddH, ...eeH, sum	F7H

Byte	Explanation
F0H	Exclusive status
41H	ID number (Roland)
10H	Device ID (For the PCR-30/50/80, fixed at 10H)
00H	Model ID #1 (PCR-30/50/80)
62H	Model ID #1 (PCR-30/50/80)
12H	Command ID (RQ1)
aaH	Address
ddH	Data
:	:
:	:
:	:
eeH	Data
sum	Checksum
F7H	EOX (End of Exclusive)

* The amount of data that can be transmitted at once is fixed for each type of data. Data that does not have the specified starting address and data size will not be received. Refer to the explanation in 3. Bulk Dump (p. 177).

* There must be an interval of at least 40 ms between each exclusive message that is sent.

* Also, you must leave an interval of at least 500 ms after transmitting one set of bulk dump data.

2. Transmit data

■ Channel voice messages

In addition to the channel voice messages that can be transmitted in each mode, the PCR-30/50/80 lets you assign any channel voice message to any controller and transmit it.

● Note off

Status	2nd byte	3rd byte
9nH	kkH	00H

n = MIDI channel number: 0H - FH (Ch.1 - 16)

kk = note number: 00H - 7FH (0 - 127)

* Transmitted when you release a key in Play mode.

● Note on

Status	2nd byte	3rd byte
9nH	kkH	vvH

n = MIDI channel number: 0H - FH (Ch.1 - 16)

kk = note number: 00H - 7FH (0 - 127)

vv = note on velocity: 01H - 7FH (1 - 127)

* Transmitted when you push a key in Play mode.

● Polyphonic key pressure

Status	2nd byte	3rd byte
AnH	kkH	vvH

n = MIDI channel number: 0H - FH (Ch.1 - 16)

kk = note number: 00H - 7FH (0 - 127)

vv = key pressure: 00H - 7FH (0 - 127)

● Control change

Status	2nd byte	3rd byte
BnH	ccH	vvH

n = MIDI channel number: 0H - FH (Ch.1 - 16)

cc = controller number: 00H - 7FH

vv = control value: 00H - 7FH

○ Bank Select (Controller number 0, 32)

Status	2nd byte	3rd byte
BnH	00H	mmH
BnH	20H	llH

n = MIDI channel number: 0H - FH (Ch.1 - 16)

mm = Bank number MSB: 00H - 7FH

ll = Bank number LSB: 00H - 7FH

* Transmitted in Bank mode.

○ Modulation (Controller number 1)

Status	2nd byte	3rd byte
BnH	01H	vvH

n = MIDI channel number: 0H - FH (Ch.1 - 16)

vv = Modulation depth: 00H - 7FH (0 - 127)

* Transmitted by upward/downward operation of the BENDER lever in Play mode.

● Program change

<u>Status</u>	<u>2nd byte</u>
CnH	ppH

n = MIDI channel number: 0H - FH (Ch.1 - 16)
 pp = Program number: 00H - 7FH (prog. 1 - prog. 128)

* Transmitted in Program change mode.

● Channel pressure

<u>Status</u>	<u>2nd byte</u>
DnH	vvH

n = MIDI channel number: 0H - FH (Ch.1 - 16)
 vv = Channel pressure: 00H - 7FH (0 - 127)

● Pitch bend change

<u>Status</u>	<u>2nd byte</u>	<u>3rd byte</u>
EnH	llH	mmH

n = MIDI channel number: 0H - FH (Ch.1 - 16)
 mm, ll = Pitch Bend value: 00 00H - 40 00H - 7FH 7FH
 (-8192 - 0 - +8191)

* Transmitted by rightward/leftward operation of the BENDER lever in Play mode.

■ Channel mode messages

In addition to the channel mode messages that can be transmitted in Panic mode, the PCR-30/50/80 lets you assign any channel voice message to any controller and transmit it.

● Channel mode messages

<u>Status</u>	<u>2nd byte</u>	<u>3rd byte</u>
BnH	ccH	vvH

n = MIDI channel number: 0H - FH (Ch.1 - 16)
 cc = controller number: 78H - 7FH
 vv = control value: 00H - 7FH

○ All sounds off (Controller number 120)

<u>Status</u>	<u>2nd byte</u>	<u>3rd byte</u>
BnH	78H	00H

n = MIDI channel number: 0H - FH (Ch.1 - 16)

* Transmitted in Panic mode.

○ Reset all controllers (Controller number 121)

<u>Status</u>	<u>2nd byte</u>	<u>3rd byte</u>
BnH	79H	00H

n = MIDI channel number: 0H - FH (Ch.1 - 16)

* Transmitted in Panic mode.

○ All notes off (Controller number 123)

<u>Status</u>	<u>2nd byte</u>	<u>3rd byte</u>
BnH	7BH	00H

n = MIDI channel number: 0H - FH (Ch.1 - 16)

* Transmitted in Panic mode.

■ System common message

On the PCR-30/50/80 you can assign the following system common messages to any controller and transmit them.

● MTC quarter frame

<u>Status</u>	<u>2nd byte</u>
F1H	mmH

mm = Message type/value

● Song position pointer

<u>Status</u>	<u>2nd byte</u>	<u>3rd byte</u>
F2H	mmH	llH

mm, ll = Song position: 00 00H - 7F 7FH (0-16383)

● Song select

<u>Status</u>	<u>2nd byte</u>
F3H	mmH

mm = Song number: 00 00H - 7F 7FH (0-16383)

● Tune request

<u>Status</u>
F6H

■ System realtime message

In addition to the Active Sensing messages that are transmitted constantly, the PCR-30/50/80 allows you to assign the following system realtime messages (other than Active Sensing) to any controller and transmit them.

● Start

<u>Status</u>
F8H

* Transmitted if the System setting F8 CLOCK is ON.

● Start

<u>Status</u>
FAH

● Continue

<u>Status</u>
FBH

● Stop

<u>Status</u>
FCH

● Active sensing

<u>Status</u>
FEH

* Transmitted at intervals of approximately 250 ms.

* Cannot be assigned to a controller.

● System reset

<u>Status</u>
FFH

■ System exclusive message

The PCR-30/50/80 is able to transmit the following exclusive messages: exclusive messages assigned to the controllers, Identity Reply, V-LINK messages, and Bulk Dump.

● Universal non-realtime system exclusive

○ Identity reply

This message will be transmitted when an Identity Request message is received.

Status	Data byte	Status
F0H	7EH,10H,06H,02H,41H,62H,01H, 00H,00H,00H,01H,00H,00H	F7H

Byte	Explanation
F0H	Exclusive status
7EH	ID number (Universal non-realtime message)
10H	Device ID (For the PCR-30/50/80, fixed at 10H)
06H	Sub ID #1 (General Information)
02H	Sub ID #1 (Identity Reply)
41H	ID number (Roland)
62H 01H	Device family code
00H 00H	Device family number code
00H 01H	Software revision level
00H 00H	:
F7H	EOX (End of Exclusive)

● V-LINK message

○ V-LINK ON

Transmitted when entering V-LINK mode.

Status	Data byte	Status
F0H	41H,10H,00H,51H,12H, 10H,00H,00H,01H,0FH,0FH,51H	F7H

Byte	Explanation
F0H	Exclusive status
41H	ID number (Roland)
10H	Device ID (For the PCR-30/50/80, fixed at 10H)
00H 51H	Model ID (V-LINK)
12H	Command ID (DT1)
10H 00H 00H	Address
01H	V-LINK ON
0FH	Clip Control Rx. MIDI Ch. (16ch)
0FH	Color Control Rx. MIDI Ch. (16ch)
51H	Checksum
F7H	EOX (End of Exclusive)

○ V-LINK OFF

Transmitted when exiting V-LINK mode.

Status	Data byte	Status
F0H	41H,10H,00H,51H,12H, 10H,00H,00H,00H,70H	F7H

Byte	Explanation
F0H	Exclusive status
41H	ID number (Roland)
10H	Device ID (For the PCR-30/50/80, fixed at 10H)
00H 51H	Model ID (V-LINK)
12H	Command ID (DT1)
10H 00H 00H	Address
00H	V-LINK OFF
51H	Checksum
F7H	EOX (End of Exclusive)

○ Sender Model Name

Transmitted when entering V-LINK mode.

Status	Data byte	Status
F0H	41H,10H,00H,51H,12H, 10H,71H,00H,45H,44H,49H,52H,4FH,4CH, 20H,50H,43H,52H,00H,3BH	F7H

Byte	Explanation
F0H	Exclusive status
41H	ID number (Roland)
10H	Device ID (For the PCR-30/50/80, fixed at 10H)
00H 51H	Model ID (V-LINK)
12H	Command ID (DT1)
aaH	Address
10H 71H 00H	Data
45H 44H 49H	Model name (EDIROL PCR)
52H 4FH 4CH	:
20H 50H 43H	:
52H 00H	:
3BH	Checksum
F7H	EOX (End of Exclusive)

● Data Set 1 DT1 (12H)

Transmitted when you execute Bulk TX in the Bulk mode.

Status	Data byte	Status
F0H	41H, 10H, 00H, 62H, 12H, aaH, ddH, ...eeH, sum	F7H

Byte	Explanation
F0H	Exclusive status
41H	ID number (Roland)
10H	Device ID
00H	Model ID #1 (PCR-30/50/80)
62H	Model ID #1 (PCR-30/50/80)
12H	Command ID (RQ1)
aaH	Address
ddH	Data
:	:
:	:
:	:
eeH	Data
sum	Checksum
F7H	EOX (End of Exclusive)

- * The amount of data that can be transmitted at once is fixed for each type of data. Data that does not have the specified starting address and data size will not be received. Refer to the explanation in 3. Bulk Dump.
- * There must be an interval of at least 40 ms between each exclusive message that is sent.
- * Also, you must leave an interval of at least 500 ms after transmitting one set of bulk dump data.

3. Bulk dump

Bulk dump allows a large amount of data to be transferred in a single operation. For example, this can be used to store all settings of a device into a computer or sequencer.

On the PCR-30/50/80, a bulk dump will be transmitted when you execute the Bulk mode operation BULK TX. The bulk dump is transmitted as several exclusive messages.

Address	Parameter	Packets
00H, 00H, 00H, 00H--00H, 00H, 1A, 7F	Current memory	27

- * You must leave an interval of at least 40 ms between each exclusive message.
- * In the case of ALL BULK, the contents of memories 1--F will be transmitted as the current memory, consecutively from memory 1 through memory F. After transmitting one set of bulk dump data, you must leave an interval of at least 500 ms.
- * Please be aware that if you modify the data dumped from the PCR-30/50/80 by changing the order in which the exclusive messages are transmitted, by inserting other messages between the system exclusive messages, or by speeding up the timing of the transmission, the data may not be set correctly when the PCR-30/50/80 receives it.

4. Supplementary material

●Decimal and Hexadecimal table

(An "H" is appended to the end of numbers in hexadecimal notation.)

In MIDI documentation, data values and addresses/sizes of Exclusive messages, etc. are expressed as hexadecimal values for each 7 bits.

The following table shows how these correspond to decimal numbers.

Dec.	Hex.	Dec.	Hex.	Dec.	Hex.	Dec.	Hex.
0	00H	32	20H	64	40H	96	60H
1	01H	33	21H	65	41H	97	61H
2	02H	34	22H	66	42H	98	62H
3	03H	35	23H	67	43H	99	63H
4	04H	36	24H	68	44H	100	64H
5	05H	37	25H	69	45H	101	65H
6	06H	38	26H	70	46H	102	66H
7	07H	39	27H	71	47H	103	67H
8	08H	40	28H	72	48H	104	68H
9	09H	41	29H	73	49H	105	69H
10	0AH	42	2AH	74	4AH	106	6AH
11	0BH	43	2BH	75	4BH	107	6BH
12	0CH	44	2CH	76	4CH	108	6CH
13	0DH	45	2DH	77	4DH	109	6DH
14	0EH	46	2EH	78	4EH	110	6EH
15	0FH	47	2FH	79	4FH	111	6FH
16	10H	48	30H	80	50H	112	70H
17	11H	49	31H	81	51H	113	71H
18	12H	50	32H	82	52H	114	72H
19	13H	51	33H	83	53H	115	73H
20	14H	52	34H	84	54H	116	74H
21	15H	53	35H	85	55H	117	75H
22	16H	54	36H	86	56H	118	76H
23	17H	55	37H	87	57H	119	77H
24	18H	56	38H	88	58H	120	78H
25	19H	57	39H	89	59H	121	79H
26	1AH	58	3AH	90	5AH	122	7AH
27	1BH	59	3BH	91	5BH	123	7BH
28	1CH	60	3CH	92	5CH	124	7CH
29	1DH	61	3DH	93	5DH	125	7DH
30	1EH	62	3EH	94	5EH	126	7EH
31	1FH	63	3FH	95	5FH	127	7FH

- * The decimal expression of the MIDI channel, program change, etc., is one greater than the decimal value shown in the table above.
- * The hexadecimal expression for each 7 bits allows a maximum of 128 steps (0--127) to be expressed by one byte of data. Multiple bytes are used if the data requires greater resolution than this. For example, a value expressed by two 7-bit bytes "aa" and "bbH" would be $aa \times 128 + bb$.
- * In the case of signed (+/-) data, 00H = -64, 40H = +/-0, and 7FH = +63; i.e., a value 64 less than the decimal value shown in the above table is used. In the case of a two-byte value, 00 00H = -8192, 40 00 = +/-0, and 7F 7F = +8191. For example, a value of "aa" and "bbH" would have a decimal expression of $aa \text{ bbH} - 40 \text{ 00H} = aa \times 128 + bb - 64 \times 128$.
- * In the case of data indicated as "use nibble data," hexadecimal expression in 4-bit units is used. A nibble-expressed value of the two bytes 0a and 0bH would have a value of $a \times 16 + b$.

<Example1>

What is the decimal expression of 5AH?

From the preceding table, 5AH = 90.

<Example2>

What is the decimal expression of the 7-bit hexadecimal value 12 34H?

From the preceding table, 12H = 18, and 34H = 52.

Thus, this is $18 \times 128 + 52 = 2356$

<Example3>

What is the decimal expression of the nibble-expressed value 0A 03 09 0D?

From the preceding table, 0AH = 10, 03H = 3, 09H = 9, and 0DH = 13.

Thus, this is $((10 \times 16 + 3) \times 16 + 9) \times 16 + 13 = 41885$

<Example4> What is the nibble-expressed value of decimal 1258?

$1258 \div 16 = 78$ (quotient) ... 10 (remainder)

$78 \div 16 = 4$ (quotient) ... 14 (remainder)

$4 \div 16 = 0$ (quotient) ... 4 (remainder)

From the preceding table, 0 = 00H, 4 = 04H, 14 = 0EH, 10 = 0AH.

Thus, the nibble-expressed value is 00 04 0E 0AH

●Example of an actual MIDI message

<Example1> CE 04

CnH is the Program Change status. "n" is the MIDI channel number. EH = 14, and 04H = 04. Thus, this is a program change message on MIDI channel 15, for program number 05.

●Checksum calculation

In order to verify that the message was received correctly, Roland exclusive messages (RQ1, DT1) add a checksum following the end of the data (before the F7). The checksum value is determined by the address and data (or size) of the exclusive message that is transmitted.

○Calculating the checksum

("H" has been added following hexadecimal values)

The checksum is a value that results in a lower 7 bits of 0 when the address, size, and checksum itself are added together.

Specifically, the calculation will be as follows when the exclusive message you want to transmit has an address of aa bb cCH and data or size of dd ee fFH.

$$\begin{aligned}
 aa + bb + cc + dd + ee + ff &= \text{total} \\
 \text{total} \div 128 &= \text{quotient} \dots \text{remainder} \\
 128 - \text{remainder} &= \text{checksum}
 \end{aligned}$$

- * However, as an exception, the checksum for a remainder of 0 is not 80H but rather 00H.

MIDI KEYBOARD CONTROLLER

Date : Nov. 1, 2002

Model PCR-30/50/80

MIDI Implementation Chart

Version : 1.00

Function...	Transmitted	Recognized	Remarks
Basic Channel Default Changed	1 1-16	X X	
Mode Default Messages Altered	Mode 3 OMNI ON/OFF, MONO, POLY *****	X X X	
Note Number : True Voice	0-127 *****	X X	
Velocity Note On Note Off	O (9n v=1-127) O (9n v=0)	X X	
After Touch Key's Channel's	O O	X X	
Pitch Bend	O	X	
Control Change 0-119	O	X	
Program Change : True Number	O (0-127) *****	X X	
System Exclusive	O	O	
System Common : Song Position : Song Select : Tune Request	O O (0-127) O	X X X	
System Real Time : Clock : Commands	O O	X X	
Aux Messages : All Sound Off : Reset All Controllers : Local On/Off : All Notes Off : Active Sensing : System Reset	O *1 (120) O *1 (121) O O *1 (123) O O	X X X X X X	
Notes	* 1 When PANIC is transmitted.		

Mode 1 : OMNI ON, POLY
Mode 3 : OMNI OFF, POLY

Mode 2 : OMNI ON, MONO
Mode 4 : OMNI OFF, MONO

O : Yes
X : No

Main specifications

■ PCR-30/50/80: MIDI KEYBOARD CONTROLLER

● Keyboard

PCR-30: 32 Keys (with velocity)

PCR-50: 49 Keys (with velocity)

PCR-80: 61 Keys (with velocity)

● Controller

Memory Button

MIDI Channel Button

Program Change Button

Edit Button

V-LINK Button

Octave Shift Button (+/-)

Transpose Button

Assignable Button (B1--6, L1--3)

Bender/Modulation Lever

Assignable Rotary Volume (R1--8)

Assignable Slider (S1--8)

Assignable Pedal (P1--2)

● Display

7 segments, 3 characters (LED)

Power Indicator

● Rear Panel

Power Switch (USB BUS/OFF/DC IN)

● Connectors

Hold Pedal Jack

Expression Pedal Jack

MIDI Jacks (IN/OUT)

USB Jack

DC IN Jack

● Power Supply

DC 9 V (AC Adaptor) or USB Bus Powered

● Current Draw

300 mA (AC Adaptor)

300 mA (USB Bus Power)

● Dimensions

PCR-30:

600 (W) x 232 (D) x 86.4 (H) mm

23-5/8 (W) x 9-3/16 (D) x 3-7/16 (H) inches

PCR-50:

833 (W) x 232 (D) x 86.4 (H) mm

32-13/16 (W) x 9-3/16 (D) x 3-7/16 (H) inches

PCR-80:

1,000(W) x 232(D) x 86.4 (H) mm

39-3/8(W) x 9-3/16 (D) x 3-7/16 (H) inches

● Weight

PCR-30: 2.4 kg / 5 lbs 5 oz (excluding AC adaptor)

PCR-50: 3.3 kg / 7 lbs 5 oz (excluding AC adaptor)

PCR-80: 3.7 kg / 8 lbs 3 oz (excluding AC adaptor)

● Accessories

AC Adaptor (ACP Series)

CD-ROM

USB Cable

Owner's Manual

Template Sheets (GM2/BLANK)

● Options

Pedal Switch: DP Series

Expression Pedal: EV Series

** In the interest of product improvement, the specifications and/or appearance of this unit are subject to change without prior notice.*

INDEX

- A**
- AC adaptor 9
- AC adaptor jack 12
- AFTERTOUCHE ASSIGN 129
- ALL BULK 151, 153
- AppleTalk 27
- ASSIGN COPY 147
- B**
- BANK 120
- Bank mode 120
- Bank select 120
- Bend Pitch Control 144
- BENDER Lever 11
- Bevorzugtes Gerät 44
- Block 162
- BULK 151
- Bus 12
- Button mode 158
- C**
- Channel 162
- Channel Pressure 129
- checksum 160
- CONTROL CHANGE ASSIGN 132
- Controller 11–12, 126
- Controllers 10
- Copy 126
- Cubase 166
- Current channel 10
- D**
- DATA OUT 11
- Data Set 1 174, 176
- DC 12
- DEC Button 10
- DECIMAL 158
- Decimal 158
- DECIMAL Button 11
- Default device 23
- Deleting the driver 173
- Device Manager 172
- Display 11
- Dispositivo predeterminado 103
- Dispositivo preferido 103
- Driver 13
- Driver Signing Options 14, 18
- E**
- EDIT 125
- EDIT Button 10
- Edit mode 125
- ENTER Button 11
- Error 152
- EXPRESSION 12
- F**
- F8 CLOCK DEFAULT TEMPO 154
- F8 CLOCK ON/OFF 154
- F8 CLOCK PORT SET 154
- FACTORY RESET 154
- Find new hardware wizard 171
- FreeMIDI 29
- G**
- Generic driver 156
- GM2 System On 142
- GS 167–168
- H**
- H-ACTIVITY ON/OFF 154
- HEX 11, 158
- HEX Button 10
- Hexadecimal 158
- HOLD 12
- I**
- INC Button 10
- Input mode 158
- K**
- KEYBOARD PORT SET 154
- L**
- Latch mode 158

- LSB 120
- M**
- Master Volume 143
- MCR-8 165–166
- MEMORY 121
- MEMORY Button 10
- Memory mode 121
- MIDI 114
- MIDI CH 118, 158
- MIDI CH Button 10
- MIDI Channel mode 118
- MIDI IN 159
- MIDI IN/OUT connectors 12
- MIDI OUT 159
- MIDI output 24
- MIDI-Ausgabe 45
- MSB 120
- N**
- NO ASSIGN 146
- NOTE ASSIGN 127
- O**
- OCTAVE 11
- OMNI 149
- OMS 26
- Opciones de firma del controlador 94, 98
- Options de signature du pilote 55, 59
- Opzioni firma driver 74, 78
- Original driver 156
- P**
- PANIC 123
- Panic mode 123
- PCR 159
- PCR MIDI IN 159
- PCR MIDI OUT 159
- PCR1 159
- PCR2 159
- Periferica predefinita 83
- Periferica preferenziale 83
- Périphérique par défaut 64
- PLAY mode 116
- Polyphonic Key Pressure 129
- Port 159
- Power Indicator 10
- Power switch 12
- Preferred device 23
- PROGRAM CHANGE 119, 158
- PROGRAM CHANGE ASSIGN 135
- PROGRAM CHANGE Button 10
- Program Change mode 119
- PROTECT 150
- R**
- Receive mode 151
- RPN/NRPN ASSIGN 138
- S**
- Salida de MIDI 104
- SAVE 148
- Security Slot 12
- SINGLE BULK 151, 153
- SNAPSHOT 122
- Snapshot mode 122
- SONAR 165
- Sortie MIDI 65
- Standardgerät 44
- STARTUP MEMORY 154
- SYS EX. ASSIGN 140
- Sys Ex. ASSIGN 160
- SYSTEM 154
- System exclusive message 140
- System exclusive messages 174
- T**
- Template sheets 9
- Toggle mode 158
- Transmit mode 153
- TRANSPOSE 11
- TRANSPOSE/ENTER Button 11
- Treibersignaturoptionen 34, 38
- U**
- Unknown driver found 172
- USB 11, 115
- USB cable 9

USB connector 12
USB DRIVER MODE 154
Uscita MIDI 84

V

VELOCITY OFFSET 154
V-LINK 10
V-LINK Button 10
V-LINK mode 10

X

XG 169



This product complies with the requirements of European Directive 89/336/EEC.

For EU Countries

For the USA

FEDERAL COMMUNICATIONS COMMISSION RADIO FREQUENCY INTERFERENCE STATEMENT

This equipment has been tested and found to comply with the limits for a Class B digital device, pursuant to Part 15 of the FCC Rules. These limits are designed to provide reasonable protection against harmful interference in a residential installation. This equipment generates, uses, and can radiate radio frequency energy and, if not installed and used in accordance with the instructions, may cause harmful interference to radio communications. However, there is no guarantee that interference will not occur in a particular installation. If this equipment does cause harmful interference to radio or television reception, which can be determined by turning the equipment off and on, the user is encouraged to try to correct the interference by one or more of the following measures:

- Reorient or relocate the receiving antenna.
- Increase the separation between the equipment and receiver.
- Connect the equipment into an outlet on a circuit different from that to which the receiver is connected.
- Consult the dealer or an experienced radio/TV technician for help.

This device complies with Part 15 of the FCC Rules. Operation is subject to the following two conditions:

- (1) This device may not cause harmful interference, and
- (2) This device must accept any interference received, including interference that may cause undesired operation.

Tested To Comply With FCC Standards

FOR HOME OR OFFICE USE

Unauthorized changes or modification to this system can void the users authority to operate this equipment.
This equipment requires shielded interface cables in order to meet FCC class B Limit.

For Canada

NOTICE

This Class B digital apparatus meets all requirements of the Canadian Interference-Causing Equipment Regulations.

AVIS

Cet appareil numérique de la classe B respecte toutes les exigences du Règlement sur le matériel brouilleur du Canada.

For the USA

DECLARATION OF CONFORMITY Compliance Information Statement

Model Name : PCR-30/50/80
Type of Equipment : USB MIDI KEYBOARD CONTROLLER
Responsible Party : Ediol Corporation North America
Address : 425 Sequoia Drive, Suite 114, Bellingham, WA 98226
Telephone : (360) 594-4276

Free Manuals Download Website

<http://myh66.com>

<http://usermanuals.us>

<http://www.somanuals.com>

<http://www.4manuals.cc>

<http://www.manual-lib.com>

<http://www.404manual.com>

<http://www.luxmanual.com>

<http://aubethermostatmanual.com>

Golf course search by state

<http://golfingnear.com>

Email search by domain

<http://emailbydomain.com>

Auto manuals search

<http://auto.somanuals.com>

TV manuals search

<http://tv.somanuals.com>