



Thank you, and congratulations on your choice of the Roland PD-85 V-Pad.

Before using this unit, carefully read the sections entitled: "USING THE UNIT SAFELY" and "IMPORTANT NOTES" (p. 6; p. 7). These sections provide important information concerning the proper operation of the unit. Additionally, in order to feel assured that you have gained a good grasp of every feature provided by your new unit, Owner's manual should be read in its entirety. The manual should be saved and kept on hand as a convenient reference.

**VERY IMPORTANT!!!**

**BEFORE** playing the pad, you must **TUNE** it to your preferred playing tension. They are **NOT** tuned before shipping. Failure to adjust tension may result in damage to the trigger sensor.

**Contents of the Package**

- PD-85 (pad unit)
- Connection Cable
- Tuning Key
- Owner's Manual (this manual)

**Names of Components**

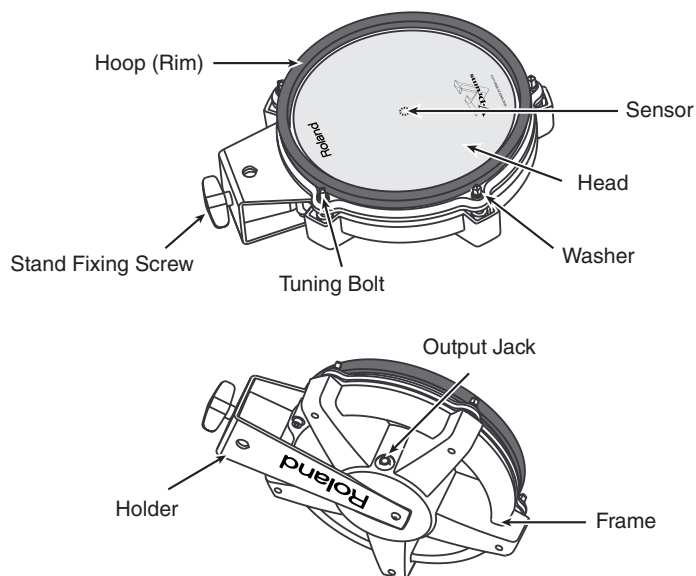

Copyright © 2005 ROLAND CORPORATION

All rights reserved. No part of this publication may be reproduced in any form without the written permission of ROLAND CORPORATION.

The band has a width of 7 mm.  
Use this for adjusting the head tension.

→ | ← 7 mm

## Features

- Snare/tom pad with embedded-mesh head for superior playing feel, and quiet response.
- Compact, eight-inch pad allows for greater versatility when setting up.
- You can use cross-stick (closed rim shot), and rim shot playing techniques.
- Brushes (nylon) can be used for brush playing.
- Tonal changes can be expressed by varying the location at which the pad is struck.

## Adjusting the Head Tension

When adjusting, use the included tuning key.

### Be sure to adjust the head tension before use.

In general, a tension that produces a strike response approximately the same as an acoustic drum will be appropriate.

#### NOTE

Striking the head when the head tension is loose may damage the sensor and head.

Should you neglect to make the appropriate settings, you could likely experience the following problems:

- Sometimes it does not sound (uneven volume).
- The volume is too low (reduced sensitivity).

#### MEMO

- On the PD-85, adjusting the head tension affects only the head response, and does not change the pitch of the sound as it would on an acoustic drum.
- The head tension will change as the instrument is used, so you should readjust when necessary.
- The head stretches when used for extended periods, so even when this is adjusted to 7 mm in the following procedure, you may not achieve the same degree of tension as when the head was initially adjusted. Strike the head to check the feel and response as you adjust the tension.

### 1. Use the included tuning key to tighten the tuning bolts.

Tighten the bolts until there is a space of approximately 7 mm between the frame and the hoop.

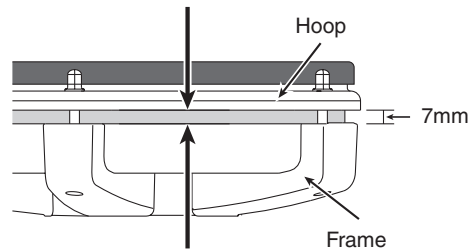

#### HINT

A black, 7 mm strip is printed at the edge of this page. Use this as a reference when making the adjustment.

#### NOTE

Tighten each tuning bolt one by one, observing the numerical order shown in the diagram. Do not firmly tighten a single tuning bolt by itself. Doing so will make it impossible to tension the head evenly, and will cause malfunctions.

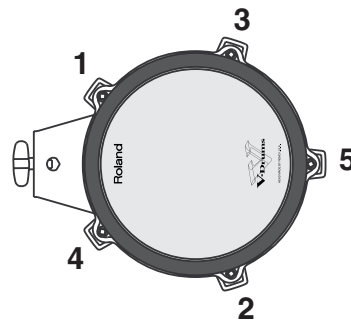

### 2. Fine-tune the adjustment while continuing to check the pad feel and response.

## Attaching the Pad to a Stand

Attach the PD-85 to a stand (MDS series).

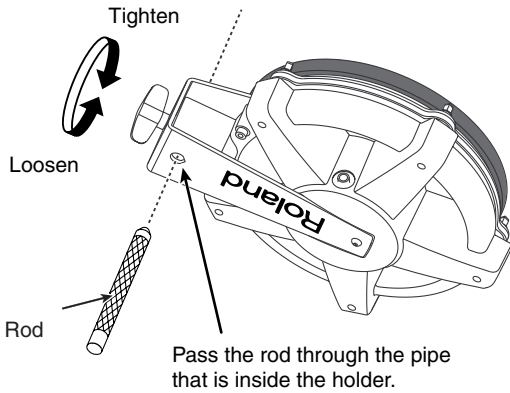

### MEMO

When attaching the PD-85 to a tom stand, check the dimensions of the rod. Depending on the dimensions of the rod, it may not be possible to attach the pad to the stand.

**Acceptable rod diameters:  
8.5–11.5 mm (3/8 to 1/2 inch)**

## Connecting To A Percussion Sound Module

Connecting to a percussion sound module (TD-20, TD-12, TD-10, TD-8, TD-6V/6, TD-3, etc.).

When you have finished connecting to your percussion sound module, refer to the owner's manual supplied with the sound module, and make the settings for it.

### NOTE

- To prevent malfunction and/or damage to speakers or other devices, always turn down the volume, and turn off the power on all devices before making any connections.
- Use the included stereo cable to make connections. Otherwise (if you use a monaural cable), you won't be able to employ rim shot and cross stick playing techniques.
- Connect the L-shaped plug of the included cable to the PD-85. This will prevent strain from being applied to the PD-85.

Percussion Sound Module	Rim Shot Capable Trigger Inputs
TD-20	2 (SNARE), 3–6 (TOM 1–4), 12–15 (AUX 1–4)
TD-12	2 (SNARE), 3–5 (TOM 1–3), 11 (AUX 1), 12 (AUX 2)
TD-10	2 (SNARE)
TD-8	3 (SNARE)
TD-6V/6	2 (SNARE)
TD-3	SNARE

# Playing Methods

## Head Shots

Hit only the head of the pad. With certain snare sounds, playing position will change the nuance of the sound.

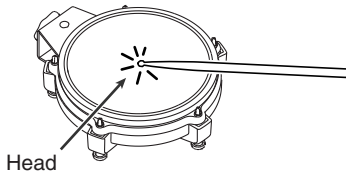

## Rim Shots

Strike the head and the rim of the pad simultaneously.

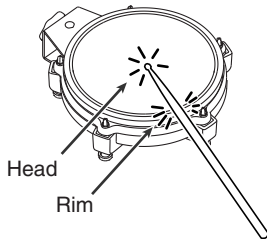

## Cross Stick

Only strike the rim of the pad.  
Depending on the instrument assigned to the rim, you can play rim shots and/or cross stick sounds.

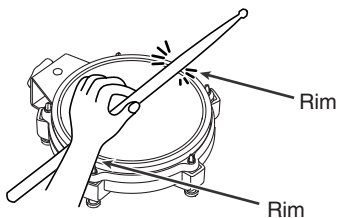

\* To play the cross stick, be sure that you only strike the rim of the pad. Placing your hand on the head of the pad might prevent the cross stick sound from being played properly.

## Sound Module Compatibility Chart

	TD-20, TD-12, TD-10, TD-8	TD-6V/6, TD-3
Head Shot	o	o
Positional Sensing	o	—
Rim Shot	o	o
Cross Stick	o	o

\* For more on settings and tones, see the respective module's owner's manual.

### MEMO

Using with some sound module that has correspondence to the nuance of the rim shot, the sound will be changed according to the way you play rim shots.  
See the owner's manual of each sound module.

### HINT

If hitting the head produces a rim sound instead, reduce the Rim Sens (or RimShot Adjust) value.  
On the other hand, if you find it difficult to get rim shot sounds to play, raise the Rim Sens (or RimShot Adjust) value.

# Head Replacement

## When the Head Should Be Replaced

The head is an expendable item that eventually will wear out and need to be replaced. Replace the head when the following occurs:

- The head surface is torn
- Slack portions remain in the head even when the head tension is properly adjusted.

**Replacement heads (optional): MH-8 Mesh Head**

## Replacing the Head

### 1. Remove all tuning bolts and washers from the PD-85.

Press the lock bushing (in figure below) in place with your finger as you remove each tuning bolt, to prevent the bushings from being pulled off the frame.

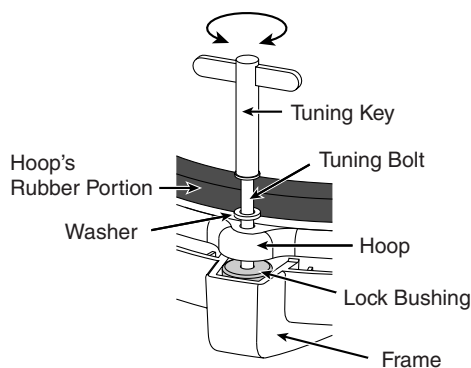

\* The lock bushings prevent rotation and loosening of the tuning bolts caused by vibrations that are transmitted from the hoop as you play.

2. Remove the hoop.
3. Remove the old head.
4. Place the new head on the frame.
5. Place the hoop onto the head.
6. Pass the tuning bolts through the washers, then attach them to the hoop and frame.
7. Next, adjust the tension of the head. Refer to "Adjusting the Head Tension" (p. 2).

### NOTE

Do not firmly tighten a single tuning bolt by itself. Doing so will make it impossible to tension the head evenly, and will cause malfunctions.

### MEMO

If a lock bushing happens to become separated from the frame while the head is being replaced, position the bushing so its four slots are aligned with the corresponding ridges in the frame, then press down firmly on the bushing.

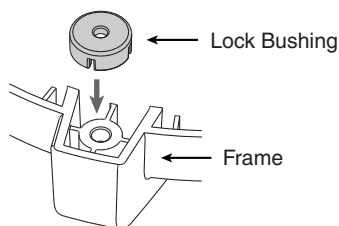

## Specifications

### PD-85 (V-Pad)

Pad size:	8 inches
Triggers:	2 (Head, Rim)
Dimensions:	245 (W) x 310 (D) x 95 (H) mm 9-11/16 (W) x 12-1/4 (D) x 3-3/4 (H) inches
Weight:	1.7 kg 3 lbs 12 oz
Accessories:	Owner's Manual, Connection Cable, Tuning Key
Options:	Mesh Head (MH-8), Pad Mount (MDH-10U), Drum Stands (MDS-3C, MDS-12BK, MDS-20BK)

\* In the interest of product improvement, the specifications and/or appearance of this unit are subject to change without prior notice.

# USING THE UNIT SAFELY

## INSTRUCTIONS FOR THE PREVENTION OF FIRE, ELECTRIC SHOCK, OR INJURY TO PERSONS

### About ⚠ WARNING and ⚠ CAUTION Notices

<b>⚠ WARNING</b>	Used for instructions intended to alert the user to the risk of death or severe injury should the unit be used improperly.
<b>⚠ CAUTION</b>	Used for instructions intended to alert the user to the risk of injury or material damage should the unit be used improperly. * Material damage refers to damage or other adverse effects caused with respect to the home and all its furnishings, as well to domestic animals or pets.

### About the Symbols

	The ⚠ symbol alerts the user to important instructions or warnings. The specific meaning of the symbol is determined by the design contained within the triangle. In the case of the symbol at left, it is used for general cautions, warnings, or alerts to danger.
	The ⓧ symbol alerts the user to items that must never be carried out (are forbidden). The specific thing that must not be done is indicated by the design contained within the circle. In the case of the symbol at left, it means that the unit must never be disassembled.
	The ● symbol alerts the user to things that must be carried out. The specific thing that must be done is indicated by the design contained within the circle. In the case of the symbol at left, it means that the power-cord plug must be unplugged from the outlet.

## ALWAYS OBSERVE THE FOLLOWING

### ⚠ WARNING

- Before using this unit, make sure to read the instructions below, and the Owner's Manual.

---

- Do not open or perform any internal modifications on the unit. (The only exception would be where this manual provides specific instructions which should be followed in order to put in place user-installable options; see p. 5.)

---

- Do not attempt to repair the unit, or replace parts within it (except when this manual provides specific instructions directing you to do so). Refer all servicing to your retailer, the nearest Roland Service Center, or an authorized Roland distributor, as listed on the "Information" page.

---

- Never use or store the unit in places that are:
  - Subject to temperature extremes (e.g., direct sunlight in an enclosed vehicle, near a heating duct, on top of heat-generating equipment); or are
  - Damp (e.g., baths, washrooms, on wet floors); or are
  - Humid; or are
  - Exposed to rain; or are
  - Dusty; or are
  - Subject to high levels of vibration.

---

- This unit should be used only with a stand that is recommended by Roland.

### ⚠ WARNING

- When using the unit with a stand recommended by Roland, the rack or stand must be carefully placed so it is level and sure to remain stable. If not using a rack or stand, you still need to make sure that any location you choose for placing the unit provides a level surface that will properly support the unit, and keep it from wobbling.

---

- Do not allow any objects (e.g., flammable material, coins, pins); or liquids of any kind (water, soft drinks, etc.) to penetrate the unit.

---

- In households with small children, an adult should provide supervision until the child is capable of following all the rules essential for the safe operation of the unit.

---

- Protect the unit from strong impact. (Do not drop it!)

### ⚠ CAUTION

- Try to prevent cords and cables from becoming entangled. Also, all cords and cables should be placed so they are out of the reach of children.





---

- Never climb on top of, nor place heavy objects on the unit.



---

- Should you remove tuning bolts, washers, and/or lock bushings, keep them in a safe place out of children's reach, so there is no chance of them being swallowed accidentally.

### CAUTION

- Attach the pad to a stand with care to avoid danger of pinching the fingers. 
- Do not apply excessive force to the sensor located below the center of the head. Doing so can interfere with accurate detection, and may damage it. 
- Due to the nature of the materials used in the sensor, changes in room temperature may affect the sensitivity of the sensor. 
- Brushes can be used to play the PD-85 when the TD-20, TD-12, TD-10, or TD-8 is used as the sound module. When using brushes, be sure to use nylon brushes. Using metal brushes will not only scratch the head, but can also be hazardous, since the tip of the brush may catch in the mesh of the net. 

### CAUTION

- This unit is shipped from the factory with the head tension loosened. Be sure to tighten the tension before use. Striking the head when the head tension is loose may damage the sensor and head. 
- The hoop's rubber portion is one component that eventually wears out (the more so if numerous rim shots are performed), and will require replacement. Rim shots may not be performed correctly when the rubber portion is worn out. If this occurs, replace the hoop rubber. Consult Roland Service for more on replacing the hoop rubber. 

## IMPORTANT NOTES

In addition to the items listed under "USING THE UNIT SAFELY" on pages 6–7, please read and observe the following:

### Placement

- Do not expose the unit to direct sunlight, place it near devices that radiate heat, leave it inside an enclosed vehicle, or otherwise subject it to temperature extremes. Excessive heat can deform or discolor the unit.
- When moved from one location to another where the temperature and/or humidity is very different, water droplets (condensation) may form inside the unit. Damage or malfunction may result if you attempt to use the unit in this condition. Therefore, before using the unit, you must allow it to stand for several hours, until the condensation has completely evaporated.
- Do not allow rubber, vinyl, or similar materials to remain on the unit for long periods of time. Such objects can discolor or otherwise harmfully affect the finish.

### Maintenance

- For everyday cleaning wipe the unit with a soft, dry cloth or one that has been slightly dampened with water. To remove stubborn dirt, use a cloth impregnated with a mild, non-abrasive detergent. Afterwards, be sure to wipe the unit thoroughly with a soft, dry cloth.
- Never use benzine, thinners, alcohol or solvents of any kind, to avoid the possibility of discoloration and/or deformation.

### Additional Precautions

- Use a reasonable amount of care when using the unit's buttons, sliders, or other controls; and when using its jacks and connectors. Rough handling can lead to malfunctions.
- When connecting / disconnecting all cables, grasp the connector itself—never pull on the cable. This way you will avoid causing shorts, or damage to the cable's internal elements.
- To avoid disturbing your neighbors, try to keep the unit's volume at reasonable levels. You may prefer to use headphones, so you do not need to be concerned about those around you (especially when it is late at night).
- This instrument is designed to minimize the extraneous sounds produced when it's played. However, since sound vibrations can be transmitted through floors and walls to a greater degree than expected, take care not to allow these sounds to become a nuisance to neighbors, especially when performing at night and when using headphones.
- When you need to transport the unit, package it in the box (including padding) that it came in, if possible. Otherwise, you will need to use equivalent packaging materials.



This product complies with the requirements of European Directive 89/336/EEC.

For EU Countries





## Free Manuals Download Website

<http://myh66.com>

<http://usermanuals.us>

<http://www.somanuals.com>

<http://www.4manuals.cc>

<http://www.manual-lib.com>

<http://www.404manual.com>

<http://www.luxmanual.com>

<http://aubethermostatmanual.com>

Golf course search by state

<http://golfingnear.com>

Email search by domain

<http://emailbydomain.com>

Auto manuals search

<http://auto.somanuals.com>

TV manuals search

<http://tv.somanuals.com>