

Roland



# SPECIAL SRX BOARD 2006 ANALOG ESSENTIALS OWNER'S MANUAL

Before using this unit, carefully read the sections entitled: "USING THE UNIT SAFELY" and "IMPORTANT NOTES" (p. 2; p. 3). These sections provide important information concerning the proper operation of the unit. Additionally, in order to feel assured that you have gained a good grasp of every feature provided by your new unit, Owner's Manual should be read in its entirety. The manual should be saved and kept on hand as a convenient reference.

## Welcome to the SRX-98 "Analog Essentials" Special SRX Board 2006

Congratulations on owning this special collection of sounds. All SRX-98 waveforms have been newly sampled, and are derived from world-famous analog synthesizers such as Roland's Jupiter-8. The entire range of notes from each synth has been multisampled for the ultimate in realism and playability. In some instances, up to 92 consecutive notes have been sampled per instrument.

We hope you will enjoy these authentic and superb sounds!

- \* *This SPECIAL SRX BOARD 2006 SRX-98 is not for sale.*
- \* *The SRX-98 is compatible with following Roland products. No other products can be used.*  
Fantom-X6/X7/X8/XR/Xa  
JUNO-G  
Fantom-S/S88  
Fantom (FA-76)  
XV-5080/5050

### **Fantom-S/S88 users**

If the instrument in which you want to install the SRX-98 is running system program **version 1.05 or earlier**, you must update the system before you can use the SRX-98.

For information regarding the system update program, please access the Roland website or contact the nearest Roland Service Center.

- \* *In the interest of product improvement, the specifications and/or contents of this package are subject to change without prior notice.*



Copyright © 2005 ROLAND CORPORATION

All rights reserved. No part of this publication may be reproduced in any form without the written permission of ROLAND CORPORATION.







# USING THE UNIT SAFELY

## INSTRUCTIONS FOR THE PREVENTION OF FIRE, ELECTRIC SHOCK, OR INJURY TO PERSONS

About  WARNING and  CAUTION Notices







 <b>WARNING</b>	Used for instructions intended to alert the user to the risk of death or severe injury should the unit be used improperly.
 <b>CAUTION</b>	Used for instructions intended to alert the user to the risk of injury or material damage should the unit be used improperly. * Material damage refers to damage or other adverse effects caused with respect to the home and all its furnishings, as well to domestic animals or pets.

About the Symbols



	The  symbol alerts the user to important instructions or warnings. The specific meaning of the symbol is determined by the design contained within the triangle. In the case of the symbol at left, it is used for general cautions, warnings, or alerts to danger.
	The  symbol alerts the user to items that must never be carried out (are forbidden). The specific thing that must not be done is indicated by the design contained within the circle. In the case of the symbol at left, it means that the unit must never be disassembled.
	The  symbol alerts the user to things that must be carried out. The specific thing that must be done is indicated by the design contained within the circle. In the case of the symbol at left, it means that the power-cord plug must be unplugged from the outlet.

### ALWAYS OBSERVE THE FOLLOWING



#### WARNING

- Before using this unit, make sure to read the instructions below, and the Owner's Manual. 
- Do not open or perform any internal modifications on the unit. 
- Do not attempt to repair the unit, or replace parts within it (except when this manual provides specific instructions directing you to do so). Refer all servicing to your retailer, the nearest Roland Service Center, or an authorized Roland distributor. 
- Never use or store the unit in places that are:
  - Subject to temperature extremes (e.g., direct sunlight in an enclosed vehicle, near a heating duct, on top of heat-generating equipment); or are 
  - Damp (e.g., baths, washrooms, on wet floors); or are 
  - Humid; or are
  - Exposed to rain; or are
  - Dusty; or are
  - Subject to high levels of vibration.
- Do not allow any objects (e.g., flammable material, coins, pins); or liquids of any kind (water, soft drinks, etc.) to penetrate the unit.   

#### WARNING

- In households with small children, an adult should provide supervision until the child is capable of following all the rules essential for the safe operation of the unit. 
- Protect the unit from strong impact. (Do not drop it!) 
- Before installing the SRX-98, you must first always turn off the unit (Fantom-X6/X7/X8/XR/Xa, JUNO-G, Fantom-S/S88, Fantom (FA-76), and XV-5080/5050) and unplug its power cord. 

#### CAUTION

- Never climb on top of, nor place heavy objects on the unit. 
- Install the circuit board only into the specified unit (Fantom-X6/X7/X8/XR/Xa, JUNO-G, Fantom-S/S88, Fantom (FA-76), and XV-5080/5050). Remove only the specified screws during the installation. 
- Should you remove screws, keep them in a safe place out of children's reach, so there is no chance of them being swallowed accidentally. 



This product must be disposed of separately at your local waste recycling centre. Do not dispose of in household waste bin.

## IMPORTANT NOTES

When you purchase the SRX-98 Special SRX Board 2006 from an authorized Roland dealer, the included sounds and samples are licensed, not sold, to you by Roland Corporation, for commercial use in music production, public performance, broadcast, etc.

You may use any of the included phrases and/or samples in a commercial or non-commercial recording without paying any additional license fees. However, you must strictly adhere to the following crediting guidelines on any music recording that utilize material from SRX-98.

Reproduction or duplication of this collection or any of the sound recording contained in the SRX-98, either as they exist on this expansion board or by any means of reformatting, mixing, filtering, re-synthesizing, processing, or otherwise editing for use in another product or for re-sale, is strictly prohibited without the express written consent of Roland. All unauthorized giving, trading, lending, renting, re-issue, re-distribution, or re-sale of the sounds included in the SRX-98 are expressly prohibited.

In Plain English: Be creative in your application of the SRX-98 sounds, and keep this library for your use only. **DO NOT COPY IT.** Roland constantly monitors other soundware releases to check for copyright infringements, and will prosecute all piracy and copyright violations to the fullest extent of the law.

THIS LIBRARY IS GUARANTEED TO BE 100% COPYRIGHT CLEAN.

In addition to the items listed under "USING THE UNIT SAFELY" on page 2, please read and observe the following:

### Handling the Board

To avoid the risk of damage to internal components that can be caused by static electricity, please carefully observe the following whenever you handle the board.

- \* Before you touch the board, always first grasp a metal object (such as a water pipe), so you are sure that any static electricity you might have been carrying has been discharged.
- \* When handling the board, grasp it only by its edges. Avoid touching any of the electronic components or connectors.
- \* Save the bag in which the board was originally shipped, and put the board back into it whenever you need to store or transport it.

### French language for Canadian Safety Standard

Veillez suivre attentivement les instructions suivantes quand vous manipulez la carte afin d'éviter tout risque d'endommagement des pièces internes par l'électricité statique.

- \* Toujours toucher un objet métallique relié à la terre (comme un tuyau par exemple) avant de manipuler la carte pour vous décharger de l'électricité statique que vous auriez pu accumuler.
- \* Lorsque vous manipulez la carte, la tenir par les côtés. Évitez de toucher aux composants ou aux connecteurs.
- \* Conservez le sachet d'origine dans lequel était la carte lors de l'envoi et remettez la carte dedans si vous devez la ranger ou la transporter.

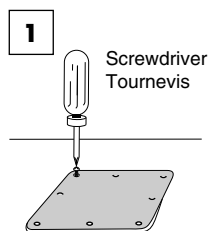

**2** Wave Expansion Board (SRX series)  
Carte d'extension Wave (serie SRX)

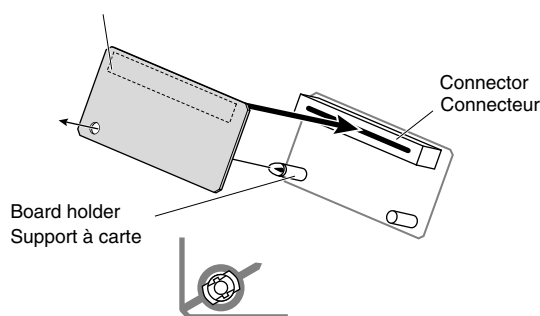

Position them as shown before you install the board.  
Avant l'installation, orienter les supports à carte tel qu'indiqué sur le schéma.

**3**

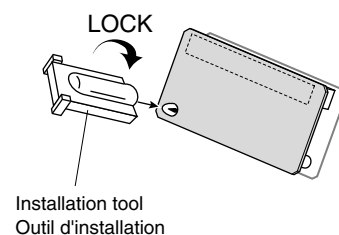

## INSTALLING THE WAVE EXPANSION BOARD

- \* Turn off your instrument.

1. Remove the cover located on the top (or rear) of your instrument.
  - \* When turning the unit upside-down, get a bunch of newspapers or magazines, and place them under the four corners or at both ends to prevent damage to the buttons and controls. Also, you should try to orient the unit so no buttons or controls get damaged.
  - \* When turning the unit upside-down, handle with care to avoid dropping it, or allowing it to fall or tip over.
2. Insert the Wave Expansion Board connector into a connector for an SRX Series slot, while simultaneously inserting the board holders into the holes in the Wave Expansion Board.
  - \* Do not touch any of the printed circuit pathways or connection terminals.
  - \* Never use excessive force when installing a circuit board. If it doesn't fit properly on the first attempt, remove the board and try again.
3. Use the supplied Installation Tool to turn the holders in the LOCK direction, so the board will be fastened in place.  
(To remove the Wave Expansion Board, turn the board holders in the UNLOCK direction, and lift up the board.)
  - \* When circuit board installation is complete, double-check your work.
4. Using the screws removed in Step 1, refasten the cover in its original position.
5. Check if the Wave Expansion Board is correctly installed.
  - \* If the "EXP" display cannot be selected (doesn't appear) in the Waveform Selection Screen (refer to the owner's manual of the instrument you use), remove the Wave Expansion Board and install it properly.

### French language for Canadian Safety Standard

- \* Éteindre l'instrument.
1. Retirer le couvercle situé sur le dessus (ou à l'arrière) de l'instrument.
  2. Insérer le connecteur de la carte dans un des creneaux pour la serie SRX tout en enfonçant les supports à carte dans les trous de celle-ci.
    - \* Ne pas toucher aux circuits imprimés ou aux connecteurs.
    - \* Ne jamais forcer lors de l'installation de la carte de circuits imprimés. Si la carte s'ajuste mal au premier essai, enlevez la carte et recommencez l'installation.
  3. Utiliser l'outil d'installation fourni pour tourner les clips de retenue vers la position de blocage (LOCK) de façon à ce que la carte soit retenue en place.  
(Pour retirer la carte d'expansion Wave, tourner les clips de retenue de la carte vers la position déblocage (UNLOCK) et retirer la carte en la soulevant.)
    - \* Quand l'installation de la carte de circuits imprimés est terminée, revérifiez si tout est bien installé.
  4. Remettre la plaque à sa place et la fixer à l'aide des vis enlevées à l'étape 1.
  5. S'assurer que la carte d'expansion Wave est installée correctement.
    - \* S'il est impossible de sélectionner l'affichage "EXP" (il n'apparaît pas) à l'écran de sélection Waveform (se reporter au guide du propriétaire de l'instrument utilisé), retirer la carte d'expansion Wave et la réinstaller correctement.

# Patch List

(BANK SELECT MSB:93; LSB:98)

No.	Name	Voices	Category
1	[RealAnaSaw]	1	OTHER SYNTH
2	[FullAnaSaw]	1	OTHER SYNTH
3	[Forever]	4	SOFT PAD
4	[StringsEns]	2	STRINGS
5	[DryMG Lead]	2	SOFT LEAD
6	[EPw/GtrAMP]	2	EL.PIANO
7	[TrancySaw1]	6	OTHER SYNTH
8	[Distorted]	4	HARD LEAD
9	[Sweep Saw]	1	OTHER SYNTH
10	[MG Bass 1]	1	SYNTH BASS
11	[Dist Saw]	2	SYNTH BASS
12	[C-Piano]	1	AC.PIANO
13	[Retro Flt]	1	FLUTE
14	[UnisonSaws]	4	STRINGS
15	[90's EP]	4	EL.PIANO
16	[SawBrs2006]	4	SYNTH BRASS
17	[LoFi Ambi]	5	SYNTH FX
18	[Saw Lead]	2	HARD LEAD
19	[MagicPiano]	2	SYNTH FX
20	[Synth Key]	2	OTHER SYNTH
21	[SquLead 06]	4	SOFT LEAD
22	[Old EP]	1	EL.PIANO
23	[HimalayaFl]	3	FLUTE
24	[Curse]	4	SYNTH FX
25	[Echo EP]	1	EL.PIANO
26	[Big Sect]	7	STRINGS

No.	Name	Voices	Category
27	[Flare Pad]	4	SOFT PAD
28	[MG Bass 2]	1	SYNTH BASS
29	[MG SawLead]	2	HARD LEAD
30	[Dry Str]	5	STRINGS
31	[Poly Synth]	2	OTHER SYNTH
32	[Blue EP]	2	EL.PIANO
33	[Reso Bass]	1	SYNTH BASS
34	[DetuneBrs]	4	SYNTH BRASS
35	[5th EP Pad]	4	SOFT PAD
36	[SquareBass]	1	SYNTH BASS
37	[Hybrid Str]	3	STRINGS
38	[Old Phaser]	1	EL.PIANO
39	[SuperSaw 1]	2	OTHER SYNTH
40	[Pluck Clav]	2	KEYBOARDS
41	[101 Bass]	1	SYNTH BASS
42	[Solo Sine]	1	SOFT LEAD
43	[Arie EP]	3	EL.PIANO
44	[SftDist Ld]	2	SOFT LEAD
45	[Tre EP]	2	EL.PIANO
46	[Vinyl Str]	6	STRINGS
47	[Cave 2006]	4	OTHER SYNTH
48	[Motion]	5	SOFT PAD
49	[JP8 Square]	4	SOFT LEAD
50	[Creation]	5	SYNTH FX
51	[Super-S]	5	BRIGHT PAD
52	[Saw Brass]	4	SYNTH BRASS

No.	Name	Voices	Category
53	[Phase EP]	1	EL.PIANO
54	[Phase Bs]	2	SYNTH BASS
55	[SuperSaw2]	4	OTHER SYNTH
56	[TrancySaw2]	6	OTHER SYNTH
57	[POP EP]	5	EL.PIANO
58	[Treck Pad]	8	PULSATING
59	[Dyno Str]	3	STRINGS
60	[JP8 SquPad]	4	SOFT PAD
61	[Phase Pad]	4	SOFT PAD
62	[JP-8 Lead]	2	HARD LEAD
63	[Tekno Bass]	2	SYNTH BASS
64	[Magma]	4	SYNTH FX
65	[Old Days]	4	SOFT PAD
66	[TapeEchoEP]	1	EL.PIANO
67	[FlareSweep]	4	SOFT PAD
68	[Sweep Saw2]	2	OTHER SYNTH
69	[Saw Stack]	3	OTHER SYNTH
70	[Retro Str]	4	STRINGS
71	[EP w/SP]	2	EL.PIANO
72	[StrMachine]	4	STRINGS
73	[Saw/SquPad]	4	SOFT PAD
74	[Power Saws]	4	OTHER SYNTH
75	[70's EP]	2	EL.PIANO
76	[Reso Lead]	2	SOFT LEAD
77	[Phase Saws]	3	OTHER SYNTH
78	[Explosion]	2	HIT&STAB

When playing patches on the expansion board, we recommend that you set all the EFFECTS ON/OFF settings to "ON." If such settings are set to "OFF," you may not obtain the intended sound.

- \* Note that the Release Time has been set to a fairly long value for some of the patches. As a result, if your sound generator has been set so "Patch Remain" is "ON," the release portion of a previously sounding patch may continue to be heard even after switching to a new patch.
- \* Refer to the owner's manual for your instrument for specific instructions on how to play Patches on the expansion board.

# Waveform List

No.	Name
1	[Str2006A L]
2	[Str2006A R]
3	[Str2006B L]
4	[Str2006B R]
5	[Str2006C L]
6	[Str2006C R]
7	[SuperSawAL]
8	[SuperSawAR]
9	[SuperSawBL]
10	[SuperSawBR]
11	[SuperSawCL]
12	[SuperSawCR]
13	[XT Fazz A]
14	[XT Fazz B]
15	[XT Fazz C]
16	[JP-8 Brs A]
17	[JP-8 Brs B]
18	[JP-8 Brs C]
19	[EP Mkl ppA]
20	[EP Mkl ppB]

No.	Name
21	[EP Mkl ppC]
22	[EP Mkl mpA]
23	[EP Mkl mpB]
24	[EP Mkl mpC]
25	[EP Mkl mfA]
26	[EP Mkl mfB]
27	[EP Mkl mfC]
28	[EP Mkl fFA]
29	[EP Mkl fFB]
30	[EP Mkl fFC]
31	[XT EP A L]
32	[XT EP A R]
33	[XT EP B L]
34	[XT EP B R]
35	[XT EP C L]
36	[XT EP C R]
37	[C.Grand pA]
38	[C.Grand pB]
39	[C.Grand pC]
40	[C.Grand fA]

No.	Name
41	[C.Grand fB]
42	[C.Grand fC]
43	[SynBass1 A]
44	[SynBass1 B]
45	[SynBass1 C]
46	[SynBass2 A]
47	[SynBass2 B]
48	[SynBass2 C]
49	[SynBass3 A]
50	[SynBass3 B]
51	[SynBass3 C]
52	[SynBass4 A]
53	[SynBass4 B]
54	[SynBass4 C]
55	[101NovaBsA]
56	[101NovaBsB]
57	[101NovaBsC]
58	[Hover Bs A]
59	[Hover Bs B]
60	[Hover Bs C]

No.	Name
61	[XT Flute A]
62	[XT Flute B]
63	[XT Flute C]
64	[EstnLead A]
65	[EstnLead B]
66	[EstnLead C]
67	[ClickLeadA]
68	[ClickLeadB]
69	[ClickLeadC]
70	[FlarePadAL]
71	[FlarePadAR]
72	[FlarePadBL]
73	[FlarePadBR]
74	[FlarePadCL]
75	[FlarePadCR]
76	[Real MGSaw]
77	[TunedMGSaw]
78	[XT Sine]

When you create a Patch using the waveforms stored in the Expansion Board, observe the following points:

- \* If you make a Patch with a single voice and then later play it in a chord, the sound may be distorted with certain settings for the Effects and TVA. If this happens, adjust the level of the Effects and TVA.



## Free Manuals Download Website

<http://myh66.com>

<http://usermanuals.us>

<http://www.somanuals.com>

<http://www.4manuals.cc>

<http://www.manual-lib.com>

<http://www.404manual.com>

<http://www.luxmanual.com>

<http://aubethermostatmanual.com>

Golf course search by state

<http://golfingnear.com>

Email search by domain

<http://emailbydomain.com>

Auto manuals search

<http://auto.somanuals.com>

TV manuals search

<http://tv.somanuals.com>