



VGA-3

Owner's Manual

Thank you, and congratulations on your choice of the Roland VGA-3 V-Guitar Amplifier.

Before using this unit, carefully read the sections entitled: "IMPORTANT SAFETY INSTRUCTIONS" (page 2), "USING THE UNIT SAFELY" (page 3–4), and "IMPORTANT NOTES" (page 5–6).

These sections provide important information concerning the proper operation of the unit.

Additionally, in order to feel assured that you have gained a good grasp of every feature provided by your new unit, owner's manual should be read in its entirety.

The manual should be saved and kept on hand as a convenient reference.

Main Features

The VGA-3 guitar amp provides 50-watt output from a high-volume, 30-cm speaker housed in a portable cabinet. The unit features an advanced combination of core functions plus COSM technology for realistic V-Guitar amp sounds.

- **COSM AMPLIFIER**

The VGA-3's amp modeling function reproduces the sounds of many popular guitar amps. This amp features eleven amp types including modeled amp sounds, from the delicate clean sound of the combo type to the large stack's massive distortion sound, and also an original flat amp perfect for use with acoustic guitar and synthesizer sound.

- **EFFECT**

Including a newly developed spring reverb, the VGA-3 incorporates ten DSP effect types perfectly suited for use with guitar sounds.

- **COSM GUITAR**

In addition to the regular guitar input, this amp also features GK input for guitar modeling. Guitar modeling provides eleven realistic sound simulations, from electric and acoustic guitar sounds to special sounds available only with GK. Achieve a whole range of sound variations, without having to switch your guitar.

- **MEMORY**

The VGA-3's memory lets you store and instantly call up ten amp and effect settings internally. Additionally, with the use of a foot controller (optional), you can store and call up forty settings.



- **TUNER**

A chromatic tuner is included.

- **EXPANDABILITY**

Not only can you connect a foot switch, the VGA-3 also provides an input for an expression pedal, which can be used as a volume pedal or wah pedal.

Also included are an EXT IN jack for connecting a CD or rhythm machine, and a RECORDING OUT/PHONES jack, which comes in handy for recording sessions or when practicing at home.

	CAUTION RISK OF ELECTRIC SHOCK DO NOT OPEN	
ATTENTION: RISQUE DE CHOC ELECTRIQUE NE PAS OUVRIR		
CAUTION: TO REDUCE THE RISK OF ELECTRIC SHOCK, DO NOT REMOVE COVER (OR BACK). NO USER-SERVICEABLE PARTS INSIDE. REFER SERVICING TO QUALIFIED SERVICE PERSONNEL.		



The lightning flash with arrowhead symbol, within an equilateral triangle, is intended to alert the user to the presence of uninsulated "dangerous voltage" within the product's enclosure that may be of sufficient magnitude to constitute a risk of electric shock to persons.



The exclamation point within an equilateral triangle is intended to alert the user to the presence of important operating and maintenance (servicing) instructions in the literature accompanying the product.

INSTRUCTIONS PERTAINING TO A RISK OF FIRE, ELECTRIC SHOCK, OR INJURY TO PERSONS.

IMPORTANT SAFETY INSTRUCTIONS SAVE THESE INSTRUCTIONS

WARNING - When using electric products, basic precautions should always be followed, including the following:

1. Read these instructions.
2. Keep these instructions.
3. Heed all warnings.
4. Follow all instructions.
5. Do not use this apparatus near water.
6. Clean only with a dry cloth.
7. Do not block any of the ventilation openings. Install in accordance with the manufacturers instructions.
8. Do not install near any heat sources such as radiators, heat registers, stoves, or other apparatus (including amplifiers) that produce heat.
9. Do not defeat the safety purpose of the polarized or grounding-type plug. A polarized plug has two blades with one wider than the other. A grounding type plug has two blades and a third grounding prong. The wide blade or the third prong are provided for your safety. When the provided plug does not fit into your outlet, consult an electrician for replacement of the obsolete outlet.
10. Protect the power cord from being walked on or pinched particularly at plugs, convenience receptacles, and the point where they exit from the apparatus.
11. Only use attachments/accessories specified by the manufacturer.
12. Never use with a cart, stand, tripod, bracket, or table except as specified by the manufacturer, or sold with the apparatus. When a cart is used, use caution when moving the cart/apparatus combination to avoid injury from tip-over.
13. Unplug this apparatus during lightning storms or when unused for long periods of time.
14. Refer all servicing to qualified service personnel. Servicing is required when the apparatus has been damaged in any way, such as power-supply cord or plug is damaged, liquid has been spilled or objects have fallen into the apparatus, the apparatus has been exposed to rain or moisture, does not operate normally, or has been dropped.



For the U.K.

WARNING: THIS APPARATUS MUST BE EARTHED

IMPORTANT: THE WIRES IN THIS MAINS LEAD ARE COLOURED IN ACCORDANCE WITH THE FOLLOWING CODE.
 GREEN-AND-YELLOW: EARTH, BLUE: NEUTRAL, BROWN: LIVE

As the colours of the wires in the mains lead of this apparatus may not correspond with the coloured markings identifying the terminals in your plug, proceed as follows:

The wire which is coloured GREEN-AND-YELLOW must be connected to the terminal in the plug which is marked by the letter E or by the safety earth symbol  or coloured GREEN or GREEN-AND-YELLOW.

The wire which is coloured BLUE must be connected to the terminal which is marked with the letter N or coloured BLACK.

The wire which is coloured BROWN must be connected to the terminal which is marked with the letter L or coloured RED.

USING THE UNIT SAFELY

INSTRUCTIONS FOR THE PREVENTION OF FIRE, ELECTRIC SHOCK, OR INJURY TO PERSONS

About ⚠ WARNING and ⚠ CAUTION Notices

⚠ WARNING	Used for instructions intended to alert the user to the risk of death or severe injury should the unit be used improperly.
⚠ CAUTION	Used for instructions intended to alert the user to the risk of injury or material damage should the unit be used improperly. * Material damage refers to damage or other adverse effects caused with respect to the home and all its furnishings, as well to domestic animals or pets.

About the Symbols

	The ⚠ symbol alerts the user to important instructions or warnings. The specific meaning of the symbol is determined by the design contained within the triangle. In the case of the symbol at left, it is used for general cautions, warnings, or alerts to danger.
	The ⓧ symbol alerts the user to items that must never be carried out (are forbidden). The specific thing that must not be done is indicated by the design contained within the circle. In the case of the symbol at left, it means that the unit must never be disassembled.
	The 🔥 symbol alerts the user to things that must be carried out. The specific thing that must be done is indicated by the design contained within the circle. In the case of the symbol at left, it means that the power-cord plug must be unplugged from the outlet.

ALWAYS OBSERVE THE FOLLOWING

⚠ WARNING

- Before using this unit, make sure to read the instructions below, and the Owner's Manual.
- Do not open or perform any internal modifications on the unit.
- Do not attempt to repair the unit, or replace parts within it (except when this manual provides specific instructions directing you to do so). Refer all servicing to your retailer, the nearest Roland Service Center, or an authorized Roland distributor, as listed on the "Information" sheet.
- Never use or store the unit in places that are:
 - Subject to temperature extremes (e.g., direct sunlight in an enclosed vehicle, near a heating duct, on top of heat-generating equipment); or are
 - Damp (e.g., baths, washrooms, on wet floors); or are
 - Humid; or are
 - Exposed to rain; or are
 - Dusty; or are
 - Subject to high levels of vibration.
- Make sure you always have the unit placed so it is level and sure to remain stable. Never place it on stands that could wobble, or on inclined surfaces.

⚠ WARNING

- The unit should be connected to a power supply only of the type described in the operating instructions, or as marked on the unit.
- Do not excessively twist or bend the power cord, nor place heavy objects on it. Doing so can damage the cord, producing severed elements and short circuits. Damaged cords are fire and shock hazards!
- This unit, either alone or in combination with an amplifier and headphones or speakers, may be capable of producing sound levels that could cause permanent hearing loss. Do not operate for a long period of time at a high volume level, or at a level that is uncomfortable. If you experience any hearing loss or ringing in the ears, you should immediately stop using the unit, and consult an audiologist.
- Do not allow any objects (e.g., flammable material, coins, pins); or liquids of any kind (water, soft drinks, etc.) to penetrate the unit.

⚠ WARNING

- Immediately turn the power off, remove the power cord from the outlet, and request servicing by your retailer, the nearest Roland Service Center, or an authorized Roland distributor, as listed on the "Information" sheet when:
 - The power-supply cord, or the plug has been damaged; or
 - If smoke or unusual odor occurs
 - Objects have fallen into, or liquid has been spilled onto the unit; or
 - The unit has been exposed to rain (or otherwise has become wet); or
 - The unit does not appear to operate normally or exhibits a marked change in performance.
- In households with small children, an adult should provide supervision until the child is capable of following all the rules essential for the safe operation of the unit.
- Protect the unit from strong impact. (Do not drop it!)
- Do not force the unit's power-supply cord to share an outlet with an unreasonable number of other devices. Be especially careful when using extension cords—the total power used by all devices you have connected to the extension cord's outlet must never exceed the power rating (watts/amperes) for the extension cord. Excessive loads can cause the insulation on the cord to heat up and eventually melt through.
- Before using the unit in a foreign country, consult with your retailer, the nearest Roland Service Center, or an authorized Roland distributor, as listed on the "Information" sheet.
- Please stow AC cable inside cabinet as shown in Fig. A to protect AC cable, when you carry this model or you do not use. When doing so, be careful not to touch the speaker unit.

Fig. A

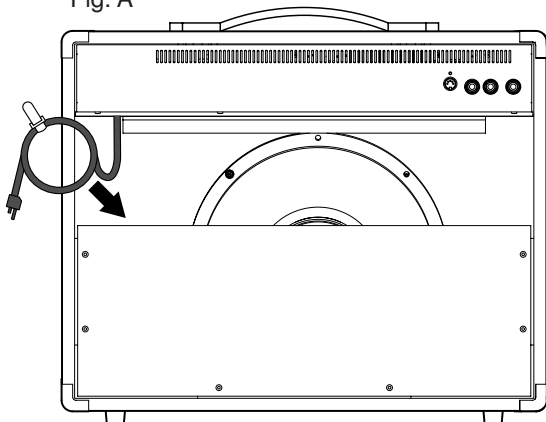

⚠ CAUTION

- The unit should be located so that its location or position does not interfere with its proper ventilation.
- Always grasp only the plug on the power-supply cord when plugging into, or unplugging from an outlet.
- Try to prevent cords and cables from becoming entangled. Also, all cords and cables should be placed so they are out of the reach of children.
- Never climb on top of, nor place heavy objects on the unit.
- Never handle the power cord or its plug with wet hands when plugging into, or unplugging from, an outlet.
- Before moving the unit, disconnect the power plug from the outlet, and pull out all cords from external devices.
- Before cleaning the unit, turn off the power and unplug the power cord from the outlet.
- Whenever you suspect the possibility of lightning in your area, pull the plug on the power cord out of the outlet.

IMPORTANT NOTES

In addition to the items listed under “IMPORTANT SAFETY INSTRUCTIONS” and “USING THE UNIT SAFELY” on pages 2 and 3–4, please read and observe the following:

This unit is equipped with a protection circuit. The protection circuit helps ensure safety by operating when excessive input continues for a long time while the device is at a location with a high ambient temperature. Sound drop-out may occur when the protection circuit is actuated during use. Please read through the documentation carefully to ensure correct use.

Power Supply

- Do not use this unit on the same power circuit with any device that will generate line noise (such as an electric motor or variable lighting system).
- Before connecting this unit to other devices, turn off the power to all units. This will help prevent malfunctions and/or damage to speakers or other devices.

Placement

- Using the unit near power amplifiers (or other equipment containing large power transformers) may induce hum. To alleviate the problem, change the orientation of this unit; or move it farther away from the source of interference.
- This device may interfere with radio and television reception. Do not use this device in the vicinity of such receivers.
- Noise may be produced if wireless communications devices, such as cell phones, are operated in the vicinity of this unit. Such noise could occur when receiving or initiating a call, or while conversing. Should you experience such problems, you should relocate such wireless devices so they are at a greater distance from this unit, or switch them off.
- Do not expose the unit to direct sunlight, place it near devices that radiate heat, leave it inside an enclosed vehicle, or otherwise subject it to temperature extremes. Also, do not allow lighting devices that normally are used while their light source is very close to the unit (such as a piano light), or powerful spotlights to shine upon the same area of the unit for extended periods of time. Excessive heat can deform or discolor the unit.
- To avoid possible breakdown, do not use the unit in a wet area, such as an area exposed to rain or other moisture.
- Do not allow rubber, vinyl, or similar materials to remain on the unit for long periods of time. Such objects can discolor or otherwise harmfully affect the finish.
- Do not put anything that contains water (e.g., flower vases) on the unit. Also, avoid the use of insecticides, perfumes, alcohol, nail polish, spray cans, etc., near the unit. Swiftly wipe away any liquid that spills on the unit using a dry, soft cloth.
- Do not paste stickers, decals, or the like to this instrument. Peeling such matter off the instrument may damage the exterior finish.

Maintenance

- For everyday cleaning wipe the unit with a soft, dry cloth or one that has been slightly dampened with water. To remove stubborn dirt, use a cloth impregnated with a mild, non-abrasive detergent. Afterwards, be sure to wipe the unit thoroughly with a soft, dry cloth.
- Never use benzene, thinners, alcohol or solvents of any kind, to avoid the possibility of discoloration and/or deformation.

Additional Precautions

- Please be aware that the contents of memory can be irretrievably lost as a result of a malfunction, or the improper operation of the unit. To protect yourself against the risk of losing important data, we recommend that you periodically save a backup copy of important data you have written on the paper.
- Unfortunately, it may be impossible to restore the contents of data that was stored in the unit's memory once it has been lost. Roland Corporation assumes no liability concerning such loss of data.
- Use a reasonable amount of care when using the unit's buttons, sliders, or other controls; and when using its jacks and connectors. Rough handling can lead to malfunctions.
- When connecting / disconnecting all cables, grasp the connector itself—never pull on the cable. This way you will avoid causing shorts, or damage to the cable's internal elements.
- A small amount of heat will radiate from the unit during normal operation.
- To avoid disturbing your neighbors, try to keep the unit's volume at reasonable levels. You may prefer to use headphones, so you do not need to be concerned about those around you (especially when it is late at night).
- When you need to transport the unit, package it in the box (including padding) that it came in, if possible. Otherwise, you will need to use equivalent packaging materials.
- Use only the specified expression pedal (EV-5, BOSS FV-300L; sold separately). By connecting any other expression pedals, you risk causing malfunction and/or damage to the unit.
- Use a cable from Roland to make the connection. If using some other make of connection cable, please note the following precautions.
 - Some connection cables contain resistors. Do not use cables that incorporate resistors for connecting to this unit. The use of such cables can cause the sound level to be extremely low, or impossible to hear. For information on cable specifications, contact the manufacturer of the cable.

Contents

IMPORTANT SAFTY INSTRUCTIONS	2	MEMORY	21
USING THE UNIT SAFELY	3	Calling Up Memory	21
IMPORTANT NOTES.....	5	Changing the Memory Settings (Edit)	21
Basic Operation	8	Storing Knob and Button Settings to Memory (Write)....	21
Front Panel.....	8	Confirming the Settings Stored in Memory (Memory Utility)	21
Rear Panel	10	Using the GFC-50 to Operate the VGA-3 ... 22	
Turning the Power On	10	Connecting the VGA-3 and the GFC-50	22
Settings for the GK Pickup (GK Setup)	11	Switching Memories With the GFC-50	22
Preparations for using the GK Pickup.....	11	How to Call Up the VGA-3's Memories	
Basic Setting Procedure.....	11	Using the GFC-50	22
The Type of Settings.....	12	Storing (Writing) to the VGA-3's Memories	
GK SETTING Settings.....	12	Using the GFC-50	23
GK DIRECTION Setting.....	12	Control Using an External Foot Switch or Pedal.....	23
GK PHASE Setting	13	Making the SYSTEM Settings	
GK S1/S2 Setting	13	(SYSTEM Setup)	24
GK SENS 6-1 Settings.....	13	Basic Setting Procedure.....	24
GK LEVEL Setting	14	The Type of Settings	24
COSM GUITAR.....	15	TUNER PITCH Setting	24
List of Guitar Types.....	15	TUNER LEVEL Setting.....	24
More Advanced Operation	16	NS THRESHOLD Setting	25
SYNTH FILTER	16	FOOT SW (FS1/FS2) Setting.....	25
POLY OCTAVE STRING SELECT.....	16	EXP PEDAL MODE Setting	25
COSM AMPLIFIER	17	EXP PEDAL HOLD Setting	25
List of Amp Types	17	MIDI OMNI MODE Setting.....	26
Effects	18	Additional Data	27
EFX.....	18	Restoring the Factory Settings.....	27
CHORUS.....	18	Calling Up the Factory Tone Settings	
FLANGER.....	18	for Each Individual Bank	28
PHASER.....	18	Troubleshooting	29
TREMOLO.....	18	Block Diagram/Effect Connection Procedure	30
WAH	18	MIDI Implementation Chart	31
DELAY	19	Specifications	32
CLEAR	19	Memory Sheet (Factory Settings)	33
WARM	19		
DOUBLING.....	19		
REVERB.....	20		
PLATE.....	20		
SPRING.....	20		

Conversions Used in This Manual

- Words or numerals enclosed in square brackets [] indicate panel buttons or knobs.
(Example)
[MANUAL]: MANUAL button
[VOLUME]: VOLUME knob
[1]: Memory button 1
- (p. **) indicates a reference page.

Basic Operation

Front Panel

TUNER

This is a built-in chromatic tuner.

When you press the button, the indicator lights, and the tuner is activated.

Tune your guitar so that the green indicator in the center lights up.

The MEMORY button indicators show the name of the note being played.

* You can change the volume and basic pitch when using the tuner.

👉 "TUNER PITCH Setting" (p. 24)

👉 "TUNER LEVEL Setting" (p. 24)

MANUAL Button

Press [MANUAL], lighting the indicator, when you want to operate the VGA-3 as you would a regular analog amplifier, whereby you make new settings with the knobs, and sound is produced in accord with the positions of the knobs on the front panel.

Memory Buttons [1]-[10]

Used for calling up memories and storing settings.

Calling up Memory

When the [A/B] button is not lighted, the memories numbered from 1 through 5 can be selected (in the illustration, Memory 1 is selected).

Not Lit →      

When the [A/B] button is lit, the memories numbered from 6 through 10 can be selected (in the illustration, Memory 6 is selected).

Lit →      

* Memories contain the factory-set knob settings.

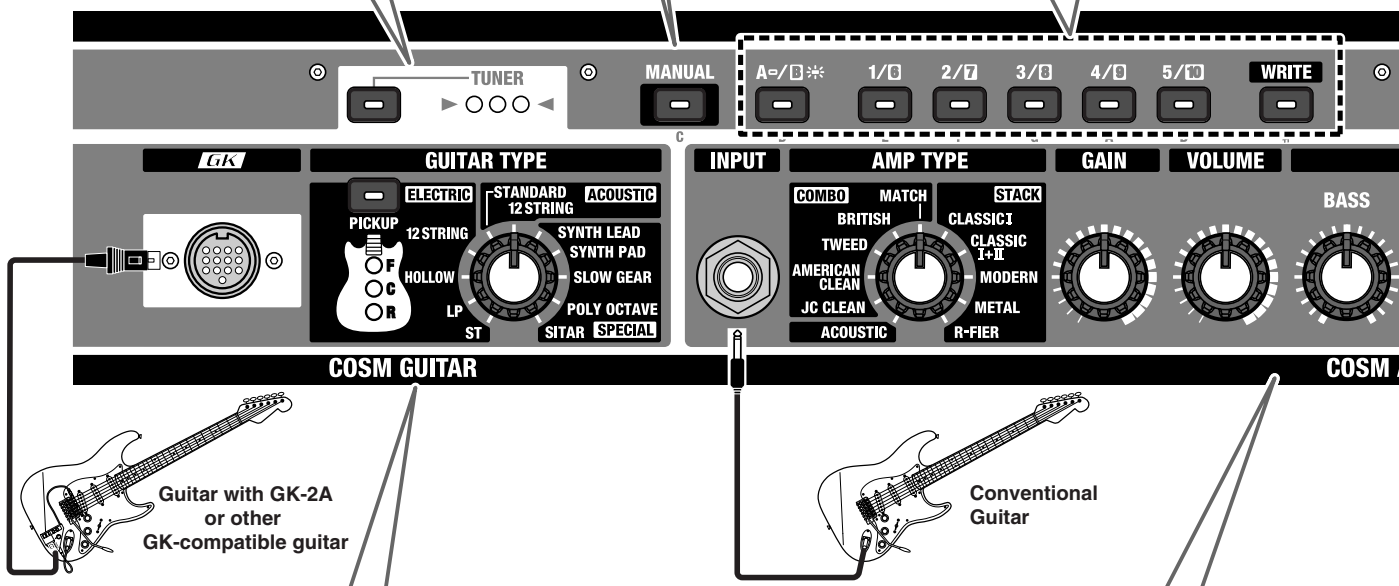

COSM GUITAR

Connect guitars equipped with GK pickups here. The VGA-3 includes models of eleven guitar types, from a general guitar to more specialized sounds, including 12-string, synth, and sitar.

[GUITAR TYPE]: Select the modeling type.

[PICKUP]: Select the pickup position.
(only electric guitar modeling)

With the SYNTH model, you can use an optional expression pedal to change the tone in real time, offering even richer expression in your performances.

👉 "Settings for the GK Pickup" (p. 11)

👉 "COSM GUITAR" (p. 15)

COSM AMPLIFIER

You can adjust the tone simply and easily just by turning the knobs. You can even connect a conventional electric guitar to this amp.

[AMP TYPE]: Selects the type of amp.

[GAIN]: Adjusts the amount of distortion.

[VOLUME]: Adjusts the volume level.

[EQUALIZER] (BASS, MIDDLE, TREBLE):
Adjust the tone in the corresponding tone range.

* Adjust the overall volume with [MASTER].

* The Acoustic Guitar Simulator function is turned on when [ACOUSTIC] is selected. This allows you to obtain an acoustic guitar sound using an electric guitar connected to the normal guitar input.

👉 "COSM AMPLIFIER" (p. 17)

WRITE Button

Press this button to store knob and button settings to memory.

Procedure

1. Press [WRITE].
2. Press a Memory button to select the memory number to which you want to store the setting.
3. Press [WRITE] again.

- ☞ "MEMORY" (p. 21)
- ☞ "Storing (Writing) to the VGA-3's Memories Using the GFC-50" (p. 23)
- ☞ "Memory Sheet" (p. 33)

COSM (Composite Object Sound Modeling)

Composite Object Sound Modeling (COSM) is Roland's innovative and powerful sound modeling technology. COSM analyzes the many factors that make up the original sound, such as the electrical and physical characteristics of the original, and then produces a digital model that can reproduce the same sound.

MASTER Knob

Adjusts the VGA-3's speaker volume level or the volume from RECORDING OUT/PHONES.

- * The MASTER knob settings are not stored in memory.

POWER Switch

This turns the VGA-3's power on and off.

- * This unit is equipped with a protection circuit. A brief interval (a few seconds) after power up is required before the unit will operate normally.

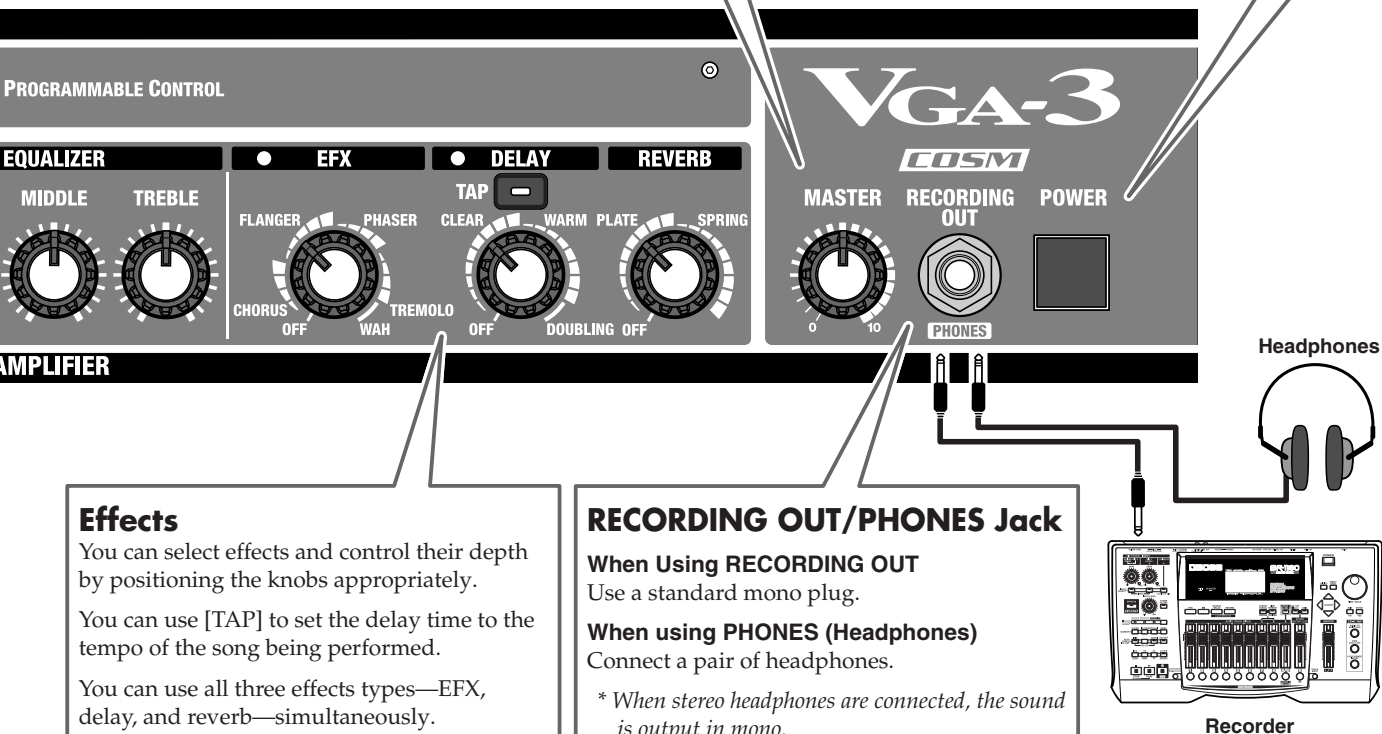
**Effects**

You can select effects and control their depth by positioning the knobs appropriately.

You can use [TAP] to set the delay time to the tempo of the song being performed.

You can use all three effects types—EFX, delay, and reverb—simultaneously.

- * The panel position markings are approximate. Check the sound of the effects as you make adjustments.

- * When an expression pedal is connected with EFX set to WAH, the pedal is then used for a pedal wah effect.

- ☞ "Effects" (p. 18)

RECORDING OUT/PHONES Jack**When Using RECORDING OUT**

Use a standard mono plug.

When using PHONES (Headphones)

Connect a pair of headphones.

- * When stereo headphones are connected, the sound is output in mono.

- * No sound is output from the VGA-3's speaker while the RECORDING OUT/PHONES jack is in use.

Rear Panel

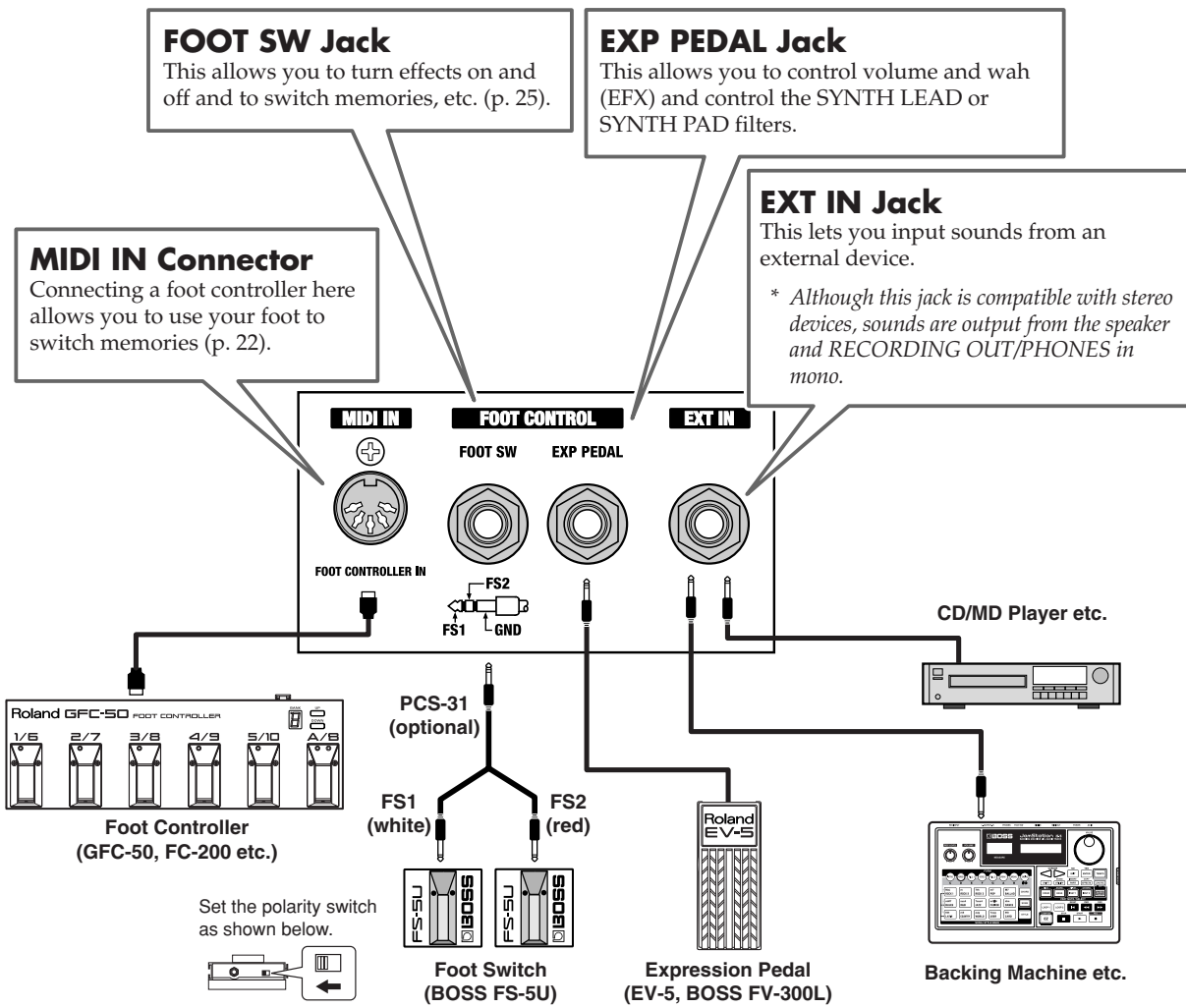

* To prevent malfunction and/or damage to speakers or other devices, always turn down the volume, and turn off the power on all devices before making any connections.

* Use only the specified expression pedal (EV-5 or BOSS FV-300L; sold separately). By connecting any other expression pedals, you risk causing malfunction and/or damage to the unit.

Turning the Power On

Once the connections have been completed, turn on power to your various devices in the order specified. By turning on devices in the wrong order, you risk causing malfunction and/or damage to speakers and other devices.

1. The device connected to GK IN, INPUT or EXT IN
2. VGA-3
3. The device connected to RECORDING OUT/PHONES

* This unit is equipped with a protection circuit. A brief interval (a few seconds) after power up is required before the unit will operate normally. You should also turn down the volume level to protect the unit from any sudden peak in volume. Even with the volume all the way down, you may still hear some sound when the power is switched on, but this is normal, and does not indicate a malfunction.

Settings for the GK Pickup (GK Setup)

The tonal character of the VGA-3 (COSM Guitar) is greatly affected by how the divided pickup is installed.

You need to enter the appropriate GK pickup settings (GK Setup) so as to minimize any tonal inconsistency that might arise from differences in how the divided pickup is installed.

NOTE

Be sure to redo the settings when you switch to a different guitar.

Preparations for using the GK Pickup

Attaching the GK-2A to your guitar

First, attach the GK-2A divided pickup (optional) to your guitar.

To learn how, refer to the owner's manual for the GK-2A.

The GK-2A cannot be used with the following types of guitar. (When attached to one of these guitars, the GK-2A will not function correctly.)

- Guitars with unconventional string structures, such as twelve-string guitars or pedal steel guitars
- Guitars that use nylon or gut strings
- Bass guitars
- Other guitars that, for structural reasons, have no location where the GK-2A divided pickup can be attached correctly

About the GK Pickup select switch

SYNTH: When using COSM guitar

MIX: When combining COSM guitar with the normal pickup of the guitar

GUITAR: When using the normal pickup of the guitar

About the SYNTH VOL knob of the GK Pickup

This controls the volume of the COSM guitar.

About the S1/S2 button of the GK Pickup

This allows you to select the pickups, memories, etc. (p. 13).

Basic Setting Procedure

Follow this basic process to set the GK pickup settings (GK Setup).

Start the GK Setup

1. Connect a guitar equipped with a GK pickup to the VGA-3.
2. Hold down [TUNER] and press [PICKUP].
The VGA-3 is now in the mode where settings for the GK Setup can be made.

* The TUNER indicator (▶) lights up, and all tone adjustments made with knobs other than [MASTER] are disabled.

3. Rotate [GUITAR TYPE] to select the type of setting you want to make, then press the MEMORY buttons to select the values.

The MEMORY buttons that can be used for selecting values are lit, while the MEMORY button corresponding to the current value flashes.

(Ex.) When "ST" (GK SETTING) is selected

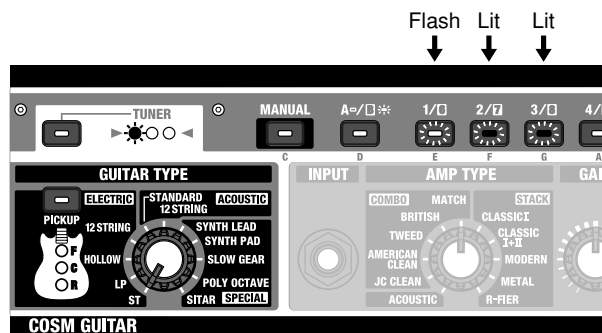

- * Do not turn off the power while making the settings. This may corrupt the settings already stored in the VGA-3. Always be sure to exit from GK Setup mode before turning off the power.
- * When you have finished GK Setup, press [TUNER] once more.
- * There is no prescribed sequence for the GK Setup settings. You are free to set only the parameters needed.

The Type of Settings

GK SETTING Settings

You can store three sets of settings in the VGA-3. This conveniently allows you to prepare separate settings for a multiple number of guitars equipped with a GK pickup.

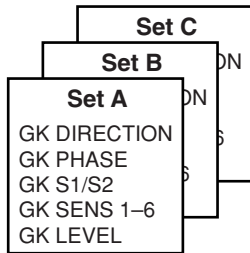

1. Rotate [GUITAR TYPE] to select "ST" (GK SETTING).
2. Press a MEMORY button [1]–[3] to select the GK SETTING set you want to enable (the settings you want to change).

Memory button	Setting
[1]	Set A
[2]	Set B
[3]	Set C

* There is no need to change the settings if you are making them for the first time or if you are not using multiple GK settings. In this case, select [1] Set A, the factory default setting.

GK DIRECTION Setting

This sets the direction of the GK pickup's installation.

1. Rotate [GUITAR TYPE] to select "LP" (GK DIRECTION).
2. Press the MEMORY button [1] or [2] to select the direction in which the pickup is attached.

Memory button	Setting
[1]	NORMAL In this direction, the cable exits on the side of string 6.
[2]	REVERSE In this direction, the cable exits on the side of string 1.

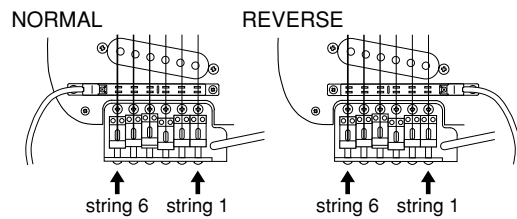

* If it is difficult to determine the direction in which the GK pickup was installed on a GK compatible guitar, try it out initially at the [1] NORMAL setting. If there is no response from the meter when you play string 6 during the GK SENS 6 settings (p. 13), but there is a response when you play string 1, change the setting to [2] REVERSE.

GK PHASE Setting

This matches the phase of the GK pickup's sound with the sound from the guitar's pickup.

* If the phases are not matched, the sound from each source will interfere with each other when mixed, altering the tonal qualities and volume levels.

1. Set the GK pickup's select switch to "MIX."
2. Rotate [GUITAR TYPE] to select "HOLLOW" (GK PHASE).
3. While playing the sixth string, press MEMORY button [1] or [2] to select the setting which does not diminish the volume level in the low end.

Memory button	Setting
[1]	NORMAL The phase will remain unchanged.
[2]	INVERSE The phase will be inverted.

GK S1/S2 Setting

This selects the functions for the GK pickup's S1 and S2 buttons.

1. Rotate [GUITAR TYPE] to select "12 STRING/ELECTRIC" (GK S1/S2).
2. Press MEMORY button [1], [2], [3], or [4] to select the functions for the S1 and S2 buttons.

Memory button	Setting
[1]	PICKUP Switching the pickup of COSM guitar S1 button: R→C→F S2 button: F→C→R
[2]	PICKUP (REVERSE) Switching the pickup of COSM guitar S1 button: F→C→R S2 button: R→C→F
[3]	MANUAL/TUNER S1 button: Switching the Manual/Memory mode. S2 button: Switching the Tuner on/off.
[4]	MEMORY ▼/▲ S1 button: memory number down S2 button: memory number up

GK SENS 6-1 Settings

This sets the GK pickup sensitivity for each string and adjusts the volume balance between the strings.

1. Set the GK pickup's select switch to "SYNTH."
2. Rotate [GUITAR TYPE] to select "STANDARD" (GK SENS 6).
3. While playing the sixth string, press a MEMORY button [1]–[10] to set the sensitivity for the sixth string. The sensitivity increases the higher you set the value, resulting in higher volume levels. The PICKUP indicators show the level. The indicators light from the bottom up in response to how strongly you play the string.

* Set this to a value such that the center (C) indicator lights, and the upper (F) indicator flashes from time to time during the most dynamic moments of a performance. Also, monitor the actual sound to make sure it is not distorted.



High
(Lower the SENS setting)



Correct



Low
(Raise the SENS setting)

Memory button	Setting
[1]–[10]	1–10

4. Set the sensitivity for the fifth through first strings in the same way.

5th String: Rotate [GUITAR TYPE] to select "12 STRING/ACOUSTIC" (GK SENS 5).

4th String: Rotate [GUITAR TYPE] to select "SYNTH LEAD" (GK SENS 4).

3rd String: Rotate [GUITAR TYPE] to select "SYNTH PAD" (GK SENS 3).

2nd String: Rotate [GUITAR TYPE] to select "SLOW GEAR" (GK SENS 2).

1st String: Rotate [GUITAR TYPE] to select "POLY OCTAVE" (GK SENS 1).

* If you cannot attain a suitable level even when the value is set to its maximum (10), check the installation of the GK pickup (the clearance between the strings and the pickup).

* If any string produces a particularly loud sound, lower the sensitivity for that string in order to minimize volume differences between strings.

GK LEVEL Setting

This sets the level for the GK pickup sound and adjusts the volume balance with the sound from the guitar pickup.

1. Set the GK pickup's select switch to "SYNTH."
2. Rotate [GUITAR TYPE] to select "SITAR" (GK LEVEL).
3. Press a MEMORY button [1]-[10] to set the level for the GK pickup.

The level increases the higher you set the value, resulting in higher volume levels.

Memory button	Setting
[1]-[10]	1-10

Move the select switch of the GK pickup between "SYNTH" and "GUITAR," and adjust the volume balance while playing your instrument in each position.

Finishing the GK SETUP

1. Press [TUNER].

* The VGA-3 automatically stores the new value of a setting at the time the change is made. No separate action is needed to save the settings.

GK Setup Chart

Parameter	Value
ST → GK SETTING	1 A 2 B 3 C
LP → GK DIRECTION	1 NORMAL 2 REVERSE
HOLLOW → GK PHASE	1 NORMAL 2 INVERSE
12 STRING → GK S1/S2	1 PICKUP 2 PICKUP(REV)
	3 MANUAL/TUNER
	4 MEMORY ▼/▲
STANDARD → GK SENS 6	1 - 10
12 STRING → GK SENS 5	1 - 10
SYNTH LEAD → GK SENS 4	1 - 10
SYNTH PAD → GK SENS 3	1 - 10
SLOW GEAR → GK SENS 2	1 - 10
POLY OCTAVE → GK SENS 1	1 - 10
SITAR → GK LEVEL	1 - 10

COSM GUITAR

This section provides an introduction to the characteristics of each of the guitars modeled.

List of Guitar Types

ELECTRIC

ST

This is a solid body guitar with single coil pickups set in three positions. The characteristically clear and delicate sound is used in many musical genres.

LP

This is a solid body guitar with two separate humbucking pickups. This type of guitar features a powerful sound with good sustain, making it an indispensable sound for rock music.

HOLLOW

This models the sound of a hollow body guitar with two humbucking pickups. It features a sweet, boxy tone that is used frequently in jazz music.

12 STRING

This models the unique sound of semi-hollow body twelve-string guitar equipped with two single coil pickups that was a favorite of vocal groups in the sixties.

ACOUSTIC

STANDARD

This is the sound of an acoustic guitar with a flat top and back.

12 STRING

This is the sound of an acoustic twelve-string guitar.

SPECIAL

SYNTH LEAD

This is an analog synth sound that is suitable for lead and solos. This features a fat tone with a boosted midrange.



“SYNTH FILTER” (p. 16)

SYNTH PAD

This is an analog synth sound that is good for chord playing. This sound features a wide range and gorgeous tone.



“SYNTH FILTER” (p. 16)

SLOW GEAR

This is an effect that is automatically applied according to the way the guitar strings are picked to produce a sound resembling that of a violin being played (see Note). The VGA-3 processes each of the six strings independently, allowing the type of performance expression impossible with a conventional guitar.

(Note)

What is meant by “resembling that of a violin being played” is an effect whereby the volume is reduced when the guitar is picked, and then it is gradually brought back up.

POLY OCTAVE

This adds a sound one octave below the source sound. Octaves are processed independently for each string, providing a fat sound that is rich in expressive power.



“POLY OCTAVE STRING SELECT” (p. 16)

SITAR

This produces a sitar-like sound.

More Advanced Operation

SYNTH FILTER

With SYNTH LEAD or SYNTH PAD selected, you can use an optional expression pedal (EV-5; optional) to shift the synth filter.

NOTE

When using an expression pedal (EV-5; optional) to shift the synth filter, set EXP PEDAL MODE in the System Setup to [1] VOLUME/GK/WAH or [2] GK/WAH.



“EXP PEDAL MODE Setting” (p. 25)

POLY OCTAVE STRING SELECT

When POLY OCTAVE is selected, you can then select the strings to which the octave sound is added.

* As set at the factory, an octave sound is added to the sound from all of the strings.

Use the following procedure to select the pattern.

1. Select POLY OCTAVE.
2. Press [PICKUP] to select the pattern.

[PICKUP] Indicator Section



(F) Lit
String 1–6



(C) Lit
String 4–6



(R) Lit
String 5, 6

* The indicator goes off after a few moments if no button is pressed.

COSM AMPLIFIER

This section provides an introduction to the characteristics of each modeled amp.

NOTE

The trademarks listed in this document are trademarks of their respective owners, which are separate companies from Roland. Those companies are not affiliated with Roland and have not licensed or authorized Roland's VGA-3. Their marks are used solely to identify the equipment whose sound is simulated by Roland's VGA-3.

List of Amp Types

ACOUSTIC

This original amp that gives a flat response from the low end on up to the high frequencies. This setting is suitable for acoustic guitar and synth sounds.

The Acoustic Guitar Simulator is turned on for normal pickup.

COMBO

JC CLEAN

This models the Roland JC-120. The sound extends smoothly into the high end. Can be combined with external effect device for an even greater effect.

AMERICAN CLEAN

This is modeled on the Fender Twin Reverb amp. This amp is used in a wide variety of musical styles, from Country, Blues, and Jazz to Rock. This amp features rich lows and a bright high end.

TWEED

This is modeled on the Fender Bassman 4 x 10" Combo. The amp features a clear upper-midrange with a fat low end, and the persistent distortion attained with a crunch tone is a favorite of Blues-Rock guitarists.

MATCH

This is modeled on the Matchless D/C-30, a modern tube combo amp used widely in different genres, from Blues and Rock to Fusion.

STACK

CLASSIC I

This is modeled on the sound input to the Marshall JMP1987 Input I. The tone extends smoothly all the way up into the presence range.

CLASSIC I+II

This is modeled on the sound of Marshall JMP1987 Inputs I and II connected in parallel. The low end from Input II added to the smooth Input I tone provides that representative Hard Rock sound.

MODERN

This is modeled on the Soldano SLO-100. This is a modern tube amp featuring a high-gain preamp.

METAL

This is modeled on the PEAVEY EVH 5150. This high-gain amp produces heavy distortion and sustain even at low volumes.

R-FIER

This is modeled on the MESA/Boogie Rectifier, a super high-gain amp. This amp is used for Slash Metal, Grunge, and a wide variety of other lead sounds.

MEMO

About the Acoustic Guitar Simulator

Tonal quality varies with the type of electric guitar pickups used, so try using the pickups in different positions.

Effects

This section provides an introduction to the characteristics of each effect.

EFX

Use the knob to switch to any of five different effects, CHORUS, FLANGER, PHASER, TREMOLO, or WAH. You can adjust the amount of effect applied according to the knob position.

* The panel markings for CHORUS, FLANGER, PHASER, and TREMOLO are approximate. Check the sound of the effects as you make adjustments.

The indicator is lit when EFX is on, and goes off when EFX is turned off. You can also use an optional foot switch (BOSS FS-5U) to switch EFX on and off.



“FOOT SW (FS1/FS2) Setting” (p. 25)

CHORUS

This adds a slightly detuned sound to the direct sound to give it a sense of breadth and more body.

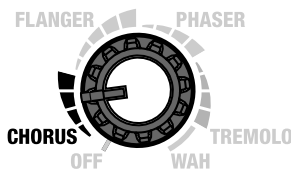

TREMOLO

This is an effect that cyclically changes the volume level.

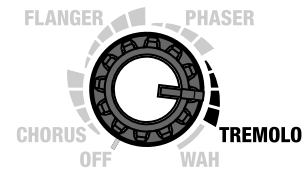

FLANGER

This produces a flanging effect that adds a kind of trembling undulation to the sound.

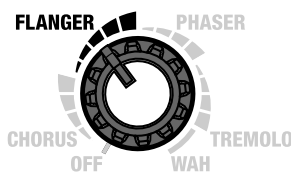

WAH

This effect provides a unique tone by changing the frequencies that are filtered.

An expression pedal (EV-5; optional) is required to change these frequencies.



PHASER

By adding phase-shifted sound to the direct sound, this produces a phase effect that adds a rotating sensation to the sound.

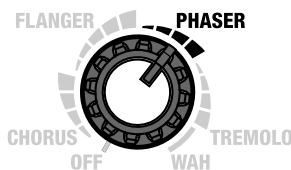

DELAY

Use the knob to switch to any of three different Delay, CLEAR, WARM, or DOUBLING. You can adjust the amount of effect applied according to the knob position.

* The panel markings for CLEAR, WARM, and DOUBLING are approximate. Check the sound of the effects as you make adjustments.

The indicator is lit when Delay is on, and goes off when Delay is turned off. You can also use an optional foot switch (BOSS FS-5U) to switch Delay on and off.



"FOOT SW (FS1/FS2) Setting" (p. 25)

CLEAR

This provides a clear delay sound with a distinct sonic image.



WARM

This produces a warmer delay sound in which the higher frequencies are de-emphasized.



DOUBLING

This extremely short delay produces an effect that makes it appear that two guitars are being played.



Changing the DOUBLING Delay Time

When DOUBLING is selected, you can select from two different delay times.

Select the delay time with the following procedure.

1. Select the DOUBLING.
2. Press [TAP], then select the delay time.

[TAP] Indicator Section



Lit: 30 msec



Flash: 60 msec

Setting the Delay Time with TAP Input

When CLEAR or WARM is selected as the delay variation, you press [TAP] twice in time with the tempo of the song being performed, the [TAP] indicator flashes at the tempo at which the button is pressed, and the delay time is set.

You can set the delay time in the range of 0–1.8 seconds.

* The interval at which the [TAP] indicator flashes shows the approximate tempo.

You can also use an optional foot switch to set the delay time with TAP input.



"FOOT SW (FS1/FS2) Setting" (p. 25)

REVERB

Use the knob to switch to any of two different Reverb, PLATE, or SPRING. You can adjust the amount of effect applied according to the knob position.

* *The panel markings for PLATE, and SPRING are approximate. Check the sound of the effects as you make adjustments.*

PLATE

This simulates a plate reverb (reverb unit that uses the vibrations of a metal plate). Provides a bright reverberation with an extended high end.

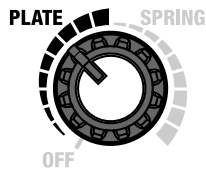

SPRING

Simulates a spring reverb (a reverb unit that uses the vibrations of a spring). The interference of the vibrations of the two springs produces a unique type of reverberation.

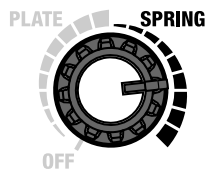

MEMORY

You can store and call up ten knob and button settings on the VGA-3. Additionally, with the use of a foot controller (such as the optional GFC-50 or FC-200), you can store and call up forty knob and button settings (p. 22).

* The settings controlled by the following external devices are also stored to the memory along with knob and button settings.
Foot Switch (EFX ON/OFF, DELAY ON/OFF), Expression Pedal (VOLUME, GK, WAH)

Calling Up Memory

1. Press **MEMORY** button to select the memory to be called up.

When the [A/B] button is not lit, the memories numbered from 1 through 5 can be selected.

When the [A/B] button is lit, the memories numbered from 6 through 10 can be selected.

Changing the Memory Settings (Edit)

1. Press memory button to select the memory whose settings are to be changed.

2. Operate the knobs/buttons.

When you change the knob or button settings, the button indicator corresponding to the selected memory flashes.

MEMO

Immediately after you switch memories, the knob positions may not correspond to the settings stored in the memory. When you turn a knob, the knob's adjustment function is enabled as you approach the position stored in the memory. If you are not sure of the setting stored in memory, turn the knob completely to the left (counterclockwise); the knob's function is enabled at that time.

NOTE

If before the setting is stored the mode is switched to Manual or Memory, or the power is turned off, all changes in the settings will be discarded. Whenever working with important settings, be sure to carry out the Write procedure.

Storing Knob and Button Settings to Memory (Write)

1. When you have finished making the knob and/or button settings, press [WRITE], causing the indicator to flash.
2. Press **MEMORY** button for the memory in which you want the settings stored.

* If you want to cancel the Write procedure, press [MANUAL].

3. Press [WRITE] once more to carry out the write.

During the write, the [WRITE] indicator flashes rapidly; the write is completed when the [WRITE] indicator stops flashing and stays off.

Confirming the Settings Stored in Memory (Memory Utility)

This reproduces the knob positions (settings values) stored in memory.

* This function is disabled whenever [MANUAL] is selected.

* During confirmation, the volume and tone are not changed when any knob other than [MASTER] is rotated.

1. Hold down [TUNER] and press [MANUAL].

* The [TUNER] flashes.

2. Operate the knob for the setting you want to check.

* One of the TUNER meter indicators lights up.

3. While monitoring TUNER meter indicators, rotate the knob further until the green indicator in the center is lit.

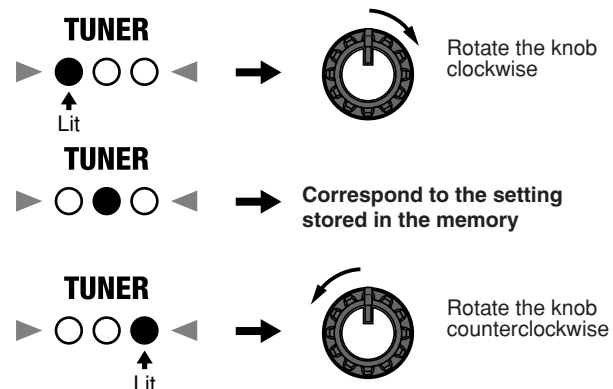

4. Repeat Steps 2 and 3 for any knob you want to check.
5. Press [TUNER] again to complete the confirmation procedure.

Using the GFC-50 to Operate the VGA-3

By connecting a GFC-50 foot controller (optional), you can use your foot to operate the VGA-3. Use the VGA-3's factory MIDI settings.

Connecting the VGA-3 and the GFC-50

Connect the VGA-3 and the GFC-50 with a MIDI cable.

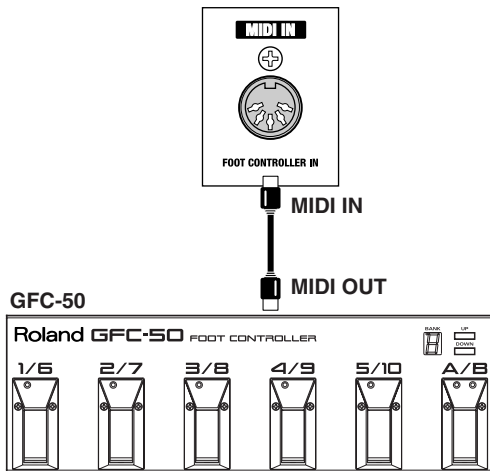

Switching Memories With the GFC-50

The VGA-3's forty memories are divided up into Banks 0, 1, 2, and 3 as shown below.

You can use the GFC-50 to call up and store (write) settings in all of the memories.

The forty memories can be accessed by specifying them in terms of the GFC-50's banks (0-3) and numbers (1-10).

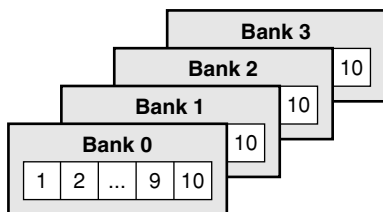

How to Call Up the VGA-3's Memories Using the GFC-50

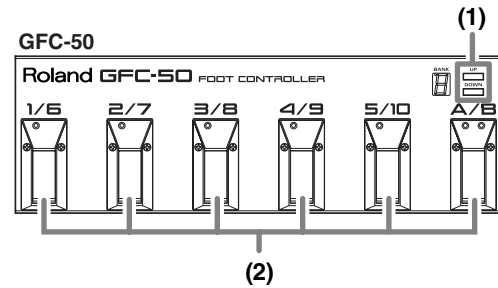

1. Press the GFC-50's Bank button (1) to select from Banks 0, 1, 2, or 3.
2. Select a memory Number 1-10 with the GFC-50's pedal (2).

Here, the memory number selected with the pedal is also indicated by the VGA-3's memory button indicator.

If Bank 1, 2, or 3 is specified with the foot controller, and the power is turned off and then on again, the VGA-3's memory still returns to Bank 0.

Storing (Writing) to the VGA-3's Memories Using the GFC-50

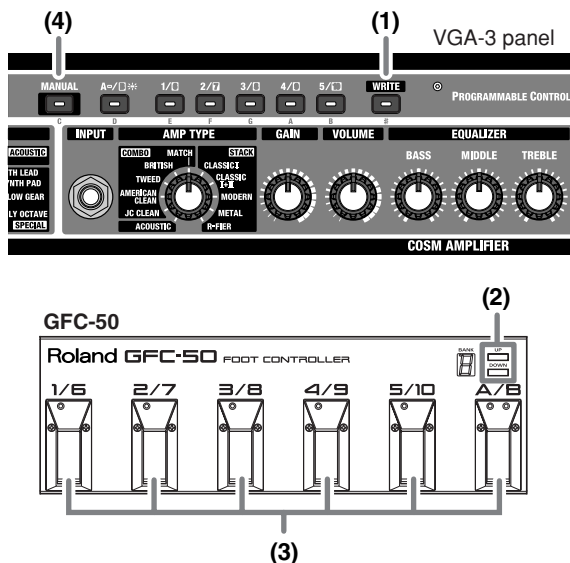

1. Using the VGA-3's knobs and buttons, prepare a tone you want to store.
2. Press the VGA-3's [WRITE] (1), causing the indicator to flash.
3. Press the GFC-50's pedal (2) to select which of the Banks 0-3 in which you want to write the tone.
4. Press the GFC-50's pedal (3) to select which of the memory numbers 1-10 to which you want to write the tone.

* If you want to cancel, press the VGA-3's [MANUAL] (4).

5. Press the VGA-3's [WRITE] (1) once more.
During the write, the [WRITE] indicator flashes rapidly; the write is completed when the [WRITE] indicator stops flashing and stays off.

Control Using an External Foot Switch or Pedal

Connecting an external foot switch or expression pedal to the GFC-50 allows you to use your foot to control the following VGA-3 functions.

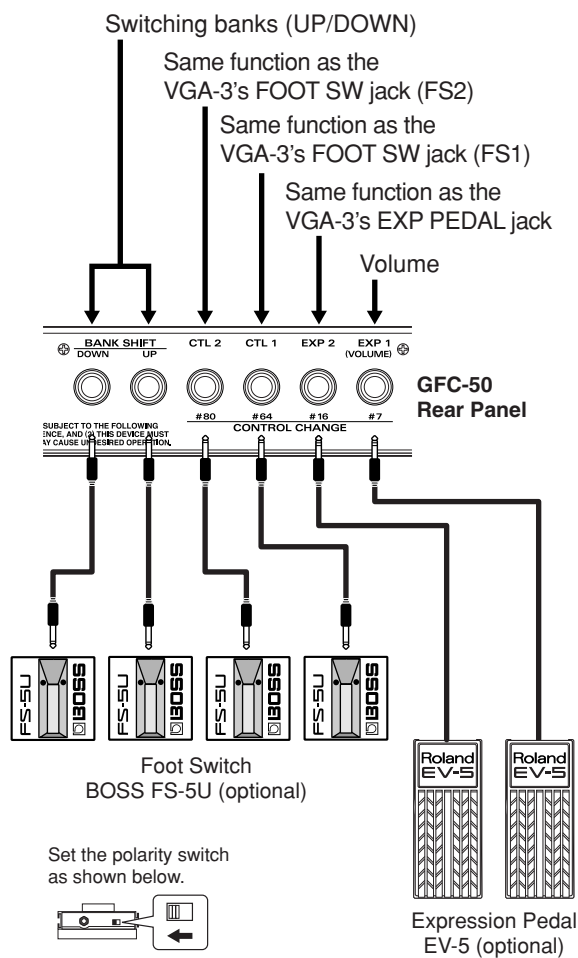

When using two external expression pedals, set the EXP PEDAL mode in the SYSTEM settings to [2] GK/WAH.



"EXP PEDAL MODE Setting" (p. 25)

Making the SYSTEM Settings (SYSTEM Setup)

With the VGA-3, you can make the following system (the parameters that can be changed so that the VGA-3 operates according to the performer's taste and particular application) settings.

Basic Setting Procedure

Follow this basic process to make the settings for the system (SYSTEM Setup).

Start the SYSTEM Setup

1. Hold down [TUNER] and press [PICKUP].

The VGA-3 is now in the mode where settings for the SYSTEM Setup can be made.

* The TUNER meter indicator (▶) lights up, and all tone adjustments made with knobs other than [MASTER] are disabled.

2. Rotate [AMP TYPE] to select the type of setting you want to make, then press the MEMORY buttons to select the values.

The TUNER meter indicator (◀) lights up.

The MEMORY buttons that can be used for selecting values are lit, while the MEMORY button corresponding to the current value flashes.

(Ex.) When "BRITISH" (EXP PEDAL MODE) is selected

fig.0221

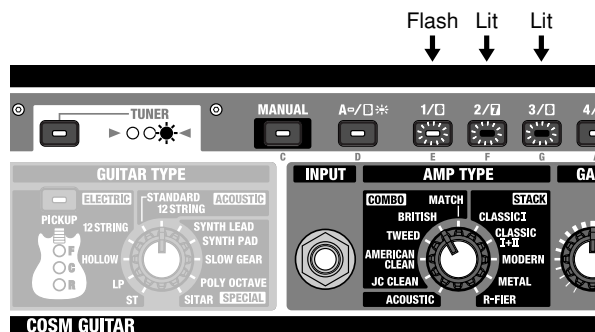

- * Do not turn off the power while making the settings. This may corrupt the settings already stored in the VGA-3. Always be sure to exit from SYSTEM Setup mode before turning off the power.
- * When you have finished SYSTEM Setup, press [TUNER] once more.
- * There is no prescribed sequence for the SYSTEM Setup settings. You are free to set only the parameters needed.

The Type of Settings

TUNER PITCH Setting

This changes the internal tuner's reference pitch. It can be convenient to change this setting when you want to tune your guitar to another instrument whose tuning cannot be changed easily (for example, an acoustic piano).

"Reference pitch" refers to the frequency of the A4 note—middle A on a piano—of the instruments serving as the reference pitch for tuning.

1. Rotate [AMP TYPE] to select "ACOUSTIC" (TUNER PITCH).
2. Press a MEMORY button [1]–[5], [6]–[10], or [MANUAL] to select the reference pitch.

Memory button	Setting
[1]–[5]	441 Hz–445 Hz.
[6]–[10]	436 Hz–440 Hz.
[MANUAL]	440 Hz.

TUNER LEVEL Setting

This adjusts the volume output by the VGA-3's speaker when the internal tuner is used.

* A special tuner tone is selected automatically when the internal tuner is in use.

1. Rotate [AMP TYPE] to select "JC CLEAN" (TUNER LEVEL).
2. Press a MEMORY button [1]–[10] to set the level.

Memory button	Setting
[1]–[10]	0 (mute)–9

NS THRESHOLD Setting

This sets how much of the internal noise suppressor is applied.

The noise suppressor is an effect that reduces guitar-generated noise and hum.

1. Rotate [AMP TYPE] to select "AMERICAN CLEAN" (NS THRESHOLD).
2. Press a MEMORY button [1]–[10] to set the amount of effect.

Memory button	Setting
[1]–[10]	0 (Off)–9

FOOT SW (FS1/FS2) Setting

This selects the action for the foot switch (BOSS FS-5U; optional) connected to the FOOT SW jack.

1. Rotate [AMP TYPE] to select "TWEED" (FOOT SW (FS1/FS2)).
2. Press MEMORY button [1], [2], [3], or [4] to select the function for the foot switch.

Memory button	Setting
[1]	EFX/DELAY FS1: Switchng the EFX on/off FS2: Switchng the Delay on/off
[2]	MEMORY ▼/▲ FS1: Memory number down FS2: Memory number up
[3]	TAP/DELAY FS1: Tap input FS2: Switchng the Delay on/off
[4]	MANUAL/TUNER FS1: Switching the Manual/Memory mode FS2: Switchng the Tuner on/off

* When a single foot switch is connected with one cable to the FOOT SW jack, the switch is used for FS1 function.

EXP PEDAL MODE Setting

This selects the pedal function when an expression pedal is connected.

1. Rotate [AMP TYPE] to select "BRITISH" (EXP PEDAL MODE).
2. Press MEMORY button [1], [2], or [3] to select the function for the expression pedal.

Memory button	Setting
[1]	VOLUME/GK/WAH • When GUITAR TYPE is set to SYNTH LEAD or SYNTH PAD, the pedal controls the filter. • When WAH is selected for EFX, it functions as a wah pedal. • With all other settings, it functions as a volume pedal.
[2]	GK/WAH • When GUITAR TYPE is set to SYNTH LEAD or SYNTH PAD, the pedal controls the filter. • When WAH is selected for EFX, it functions as a wah pedal.
[3]	VOLUME The pedal functions as a volume pedal at all times.

EXP PEDAL HOLD Setting

This selects the action for the expression pedal when switching memories.

1. Rotate [AMP TYPE] to select "MATCH" (EXP PEDAL HOLD).
2. Press MEMORY button [1] or [2] to select the function for the expression pedal.

Memory button	Setting
[1]	ON When memories are switched, the volume (setting) will be as specified by the position of the pedal.
[2]	OFF When memories are switched, the level settings stored in the memories are used, regardless of the pedal position. The pedal functions as an expression pedal as soon as it is adjusted.

MIDI OMNI MODE Setting

You can set the MIDI Receive channel to Omni ON, whereby MIDI is received over any channel; or Omni OFF, whereby channel 1 is used only.

1. Rotate [AMP TYPE] to select "CLASSIC I" (MIDI OMNI MODE).
2. Press MEMORY button [1] or [2] to set the MIDI OMNI MODE.

Memory button	Setting
[1]	ON Data can be received on any channel (Omni On).
[2]	OFF Only MIDI channel 1 is used (Omni Off). This will function only with the channel on the transmitting MIDI device set to 1.

Finishing the SYSTEM Setup

1. Press [TUNER].

* The settings are stored in the VGA-3 at the time the settings values are changed. No separate action is needed to save the settings.

SYSTEM Setup Chart

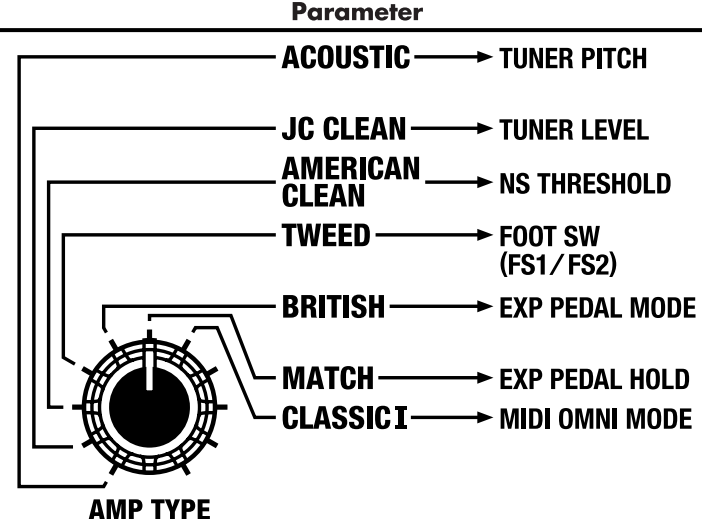
Parameter	Value
 ACOUSTIC → TUNER PITCH JC CLEAN → TUNER LEVEL AMERICAN CLEAN → NS THRESHOLD TWEED → FOOT SW (FS1/FS2) BRITISH → EXP PEDAL MODE MATCH → EXP PEDAL HOLD CLASSIC I → MIDI OMNI MODE	MANUAL 440Hz 1 441Hz - 5 445Hz 6 436Hz - 10 440Hz 1 (MUTE) - 10 1 (OFF) - 10 1 EFX/DELAY 2 MEMORY ▼/▲ 3 TAP/DELAY 4 MANUAL/TUNER 1 VOLUME/GK/WAH 2 GK/WAH 3 VOLUME 1 ON 2 OFF 1 ON 2 OFF

Additional Data

Restoring the Factory Settings



The data created up to the point when the factory settings are restored is lost.

When Restoring All Settings to Their Factory Settings

You can reinitialize the content of the VGA-3's forty memories, GK Setup settings, and the SYSTEM Setup settings to their original factory settings.

1. Hold down [WRITE] while you switch ON the POWER switch.

MEMORY [1] flashes, while MEMORY [2] and [3] remain lit.

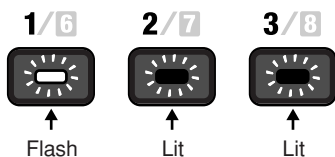

* If you want to cancel the reset, turn the power off.

2. If you want to continue and reinitialize the data, press [WRITE] two times.

The [WRITE] indicator flashes, and when the settings are completed, the VGA-3 returns to MEMORY Number 1.

When Restoring Only the Memories to Their Factory Settings

1. Hold down [WRITE] while you switch ON the POWER switch.

MEMORY [1] flashes, while MEMORY [2] and [3] remain lit.

2. Press MEMORY button [2].

MEMORY [2] flashes, while MEMORY [1] and [3] remain lit.

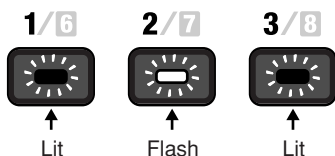

* If you want to cancel the reset, turn the power off.

3. If you want to continue and reinitialize the data, press [WRITE] two times.

The [WRITE] indicator flashes, and when the settings are completed, the VGA-3 returns to MEMORY Number 1.

When Restoring GK Setup settings and SYSTEM Setup Settings to Their Factory Settings

1. Hold down [WRITE] while you switch ON the POWER switch.

MEMORY [1] flashes, while MEMORY [2] and [3] remain lit.

2. Press MEMORY button [3].

MEMORY [3] flashes, while MEMORY [1] and [2] remain lit.

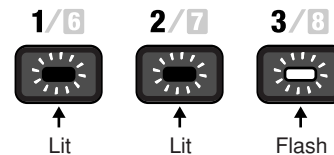

* If you want to cancel the reset, turn the power off.

3. If you want to continue and reinitialize the data, press [WRITE] two times.

The [WRITE] indicator flashes, and when the settings are completed, the VGA-3 returns to MEMORY Number 1.

Calling Up the Factory Tone Settings for Each Individual Bank

You can select any one of the Banks 0–3 listed on the Memory Sheet (p. 33) and call up that bank's factory-loaded settings to MEMORY buttons 1–10.

* *Calling up these settings clears all of the Memories 1–10 previously stored in Bank 0.*

1. While holding down the Memory button corresponding to the bank on the Memory Sheet that you want to call up, switch ON the POWER switch.

To call up the Memory Sheet Bank 0 tone settings: [1/6]

To call up the Memory Sheet Bank 1 tone settings: [2/7]

To call up the Memory Sheet Bank 2 tone settings: [3/8]

To call up the Memory Sheet Bank 3 tone settings: [4/9]

For example, if you want to call up the tone settings for Bank 2 on the Memory Sheet, hold down [3/8] and switch the power on. The [3/8] indicator flashes.

* *If you want to cancel the operation, turn the power off.*

2. Press [WRITE] two times.

The [WRITE] indicator flashes; once the settings have been called up, the VGA-3 returns to memory Number 1.

Troubleshooting

This section explains some things that might go wrong when using the VGA-3, and what needs to be done to correct the problem. If you think there may be something wrong with your VGA-3, please check through the following first. If these suggestions don't fix the problem, then go ahead and contact the store you bought it from, or your nearest Roland Service Station.

Trouble with the Sound

Odd Sound / No Sound When Guitar Is Played

- Is the value for the [MASTER], [GAIN], or [VOLUME] knobs, or for the [GAIN] or [VOLUME] settings stored in the memory set to "0"?
 - Raise the volume to a suitable level.
- Are the [BASS], [MIDDLE], or [TREBLE] knobs set to "0"?
 - Depending on the model selected with the Amp Type (p. 17), no sound may be produced when [BASS], [MIDDLE], and [TREBLE] are all set to "0."
- Are you using an expression pedal?
 - There may be no sound produced when the pedal portion is set to the released position. Try operating the pedal.
- If controlling the volume with MIDI, was the MIDI connection disrupted while the volume was set to "0"?
 - Reconnect the MIDI device and raise the volume, or turn the VGA-3's power off and then on again.
- Is TUNER set to ON?
 - Turn TUNER off, or set the volume to be used for the TUNER function (p. 24).
- Is the unit in SYSTEM SETUP mode?
 - Exit SYSTEM SETUP mode. Depending on the SYSTEM SETUP parameters, sounds may not be output.
- Is there anything plugged into the RECORDING OUT/PHONES jack?
 - Disconnect the plug. No sound is output from the built-in speaker when anything is plugged into the RECORDING OUT/PHONES jack.

The COSM GUITAR sound isn't right

- Is the GK pickup setting correctly?
 - Check the GK pickup setting (p. 11).

Internal Effects Not Being Applied

- Is a foot switch connected?
 - If the effect has been turned off with the foot switch, you can turn the effect on by returning the knob to the "0" position.

Wah Sound Not Produced

- An expression pedal (the optional EV-5) is required to alter the filter used for the wah effect.

Interruptions in the Sound

- Is the noise suppressor effect set near "10" (higher threshold)?
 - Make a lower noise suppressor effect setting (p. 25).

The volume level of the instrument connected to EXT IN is too low

- Could you be using a connection cable that contains a resistor?
 - Use a connection cable that does not contain a resistor.

Other Problems

VGA-3 Receives Commands from Foot Controller or Other Device, But Memories Do Not Switch

- Is the external device transmitting over a MIDI channel that cannot be received by the VGA-3?
 - Set the MIDI channel on the external device to Channel 1. Otherwise, set MIDI OMNI MODE in the VGA-3's MIDI settings to ON (p. 26).

Tuner Meter Indicator Flashes With MIDI Device In Use

- Could the external MIDI device have transmitted a large volume of data all at once?
 - After the indicator flashes for a short while, the VGA-3 automatically returns to the condition it was in before receiving the data. Reduce the amount of data that will be transmitted by the external device, then have it send the data again.

Block Diagram/Effect Connection Procedure

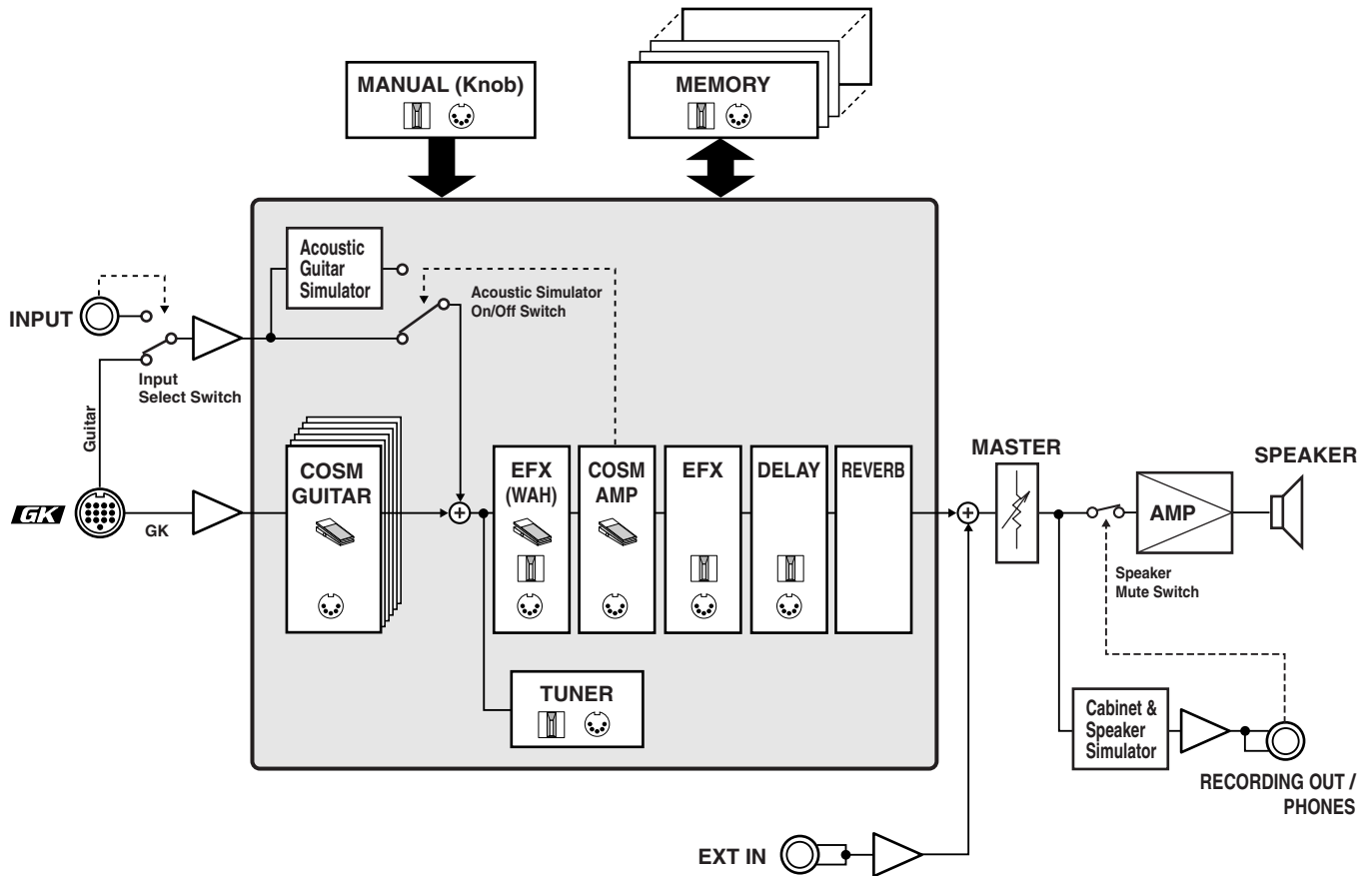

- * Wherever a block contains one or more icons, it means that some of the parameters of that block can be controlled using the external controller(s) that the icon(s) represent(s).
- * An EFX effect is placed either before or after the COSM amplifier, depending on the effect selected. WAH is before, and others are placed after.

MIDI Implementation Chart

V-GUITAR AMPLIFIER

Date : Oct. 1, 2002

Model VGA-3

MIDI Implementation Chart

Version : 1.00

Function...		Transmitted	Recognized	Remarks
Basic Channel	Default Changed	X X	1-16 / 1 X	Only ch. 1 (omni off)
Mode	Default Messages Altered	X X *****	OMNI ON/OFF X	Memorized
Note Number :	True Voice	X *****	X	
Velocity	Note ON Note OFF	X X	X X	
After Touch	Key's Ch's	X X	X X	
Pitch Bend		X	X	
Control Change	7	X	O	Volume *1
	16	X	O	Volume / GK / Wah *2
	64	X	O	EFX / Memory down / Tap / Manual *3
	80	X	O	Delay / Memory up / Delay / Tuner *4
Prog Change	: True #	X X	O 1-40	
System Exclusive		O	O	
System Common	: Song Pos : Song Sel : Tune	X X X	X X X	
System Real Time	: Clock : Command	X X	X X	
Aux Message	: All sound off : Local ON/OFF : All Notes OFF : Active Sense : Reset	X X X X X	X X X X X	
Notes	* 1 Depends on extension pedal. * 2 Depends on extension pedal. Functions the same as the VGA-3's EXP PEDAL. The function is selected according to the system settings. * 3 Functions the same as the VGA-3's FOOT SW tip (FS1). The function is selected according to the system settings. * 4 Functions the same as the VGA-3's FOOT SW ring (FS2). The function is selected according to the system settings.			

Mode 1 : OMNI ON, POLY

Mode 2 : OMNI ON, MONO

O : Yes

Mode 3 : OMNI OFF, POLY

Mode 4 : OMNI OFF, MONO

X : No

Specifications

VGA-3: V-GUITAR AMPLIFIER

● Rated Power Output

50W

● Patches

10 (Recalled from Panel)

40 (Recalled from MIDI Foot Controller)

● Nominal Input Level (1 kHz)

INPUT: -10 dBu

EXT INPUT: -10 dBu

* $0 \text{ dBu} = 0.775 \text{ Vrms}$

● Speakers

30 cm (12 inches) x 1

● Controls

COSM GUITAR Section

GUITAR TYPE Knob

PICKUP Button

COSM AMPLIFIER Section

AMP TYPE Knob

GAIN Knob

VOLUME Knob

EQUALIZER Knobs (BASS, MIDDLE, TREBLE)

EFX Knob

DELAY Knob

TAP Button

REVERB Knob

Master Section

TUNER Button

MANUAL Button

Memory Buttons (A/B, 1/6, 2/7, 3/8, 4/9, 5/10)

WRITE Button

MASTER Knob

POWER Switch

● Connectors

GK IN Connector

INPUT Jack

RECORDING OUT/PHONES Jack

EXT INPUT Jack

EXP PEDAL Jack

FOOT SW Jack

MIDI IN Connector

● Power Supply

AC 117 V, AC 230 V, AC 240 V

● Power Consumption

55W

● Dimensions

586 (W) x 260 (D) x 480 (H) mm

23-1/8 (W) x 10-1/4 (D) x 18-15/16 (H) inches

● Weight

18.5 kg

40 lbs 13 oz

● Accessories

Owner's Manual

● Options

Divided Pickup: GK-2A

Foot Controller: GFC-50

MIDI Foot Controller: FC-200

Expression Pedal: EV-5/FV-300L (BOSS)

Footswitch (momentary): FS-5U (BOSS)

Connection cable: PCS-31

GK Cable: GKC-3 (3 m)/GKC-5 (5 m)/GKC-10 (10 m)



In the interest of product improvement, the specifications and/or appearance of this unit are subject to change without prior notice.

Memory Sheet (Factory Settings)

Bank	No.	Name	GUITAR TYPE	AMP TYPE	EFX	DELAY	REVERB
0	1	HEAVY	POLY OCTAVE	R-FIER		CLEAR	PLATE
	2	BRIT CRUNCH	ST	BRITISH			
	3	JC CHORUS	ST	JC CLEAN	CHORUS	CLEAR	PLATE
	4	SWAMPY COMBO	ST	AMERICAN CLEAN	TREMOLO		SPRING
	5	CLASSIC STACK	LP	CLASSIC I			PLATE
	6	RICH ACOUSTIC GK	STANDARD	ACOUSTIC		CLEAR	PLATE
	7	BLUESY OCTAVE GK	POLY OCTAVE	MATCH		CLEAR	
	8	BRIGHT JAZZ GK	HOLLOW	JC CLEAN			PLATE
	9	ROCK 12 GK	12STRING(E)	AMERICAN CLEAN			SPRING
	10	JUNO BRASS GK	SYNTH LEAD	ACOUSTIC	CHORUS	WARM	PLATE
1	1	STRAIGHT JC	ST	JC CLEAN			PLATE
	2	LIVERPOOL	12STRING(E)	BRITISH			SPRING
	3	TWEED BLUES	ST	TWEED		WARM	SPRING
	4	SCOOPED CRUNCH	ST	BRITISH			PLATE
	5	DRIVEN D/C	ST	MATCH		CLEAR	
	6	HAZY DRIVE	ST	CLASSIC I			PLATE
	7	AIRY LEAD	ST	CLASSIC I+II		WARM	SPRING
	8	TRUE BRIT	LP	MODERN		WARM	PLATE
	9	METAL STACK	LP	METAL		CLEAR	PLATE
	10	LOW RIFFS	LP	R-FIER		DOUBLING	
2	1	MIXED PICKUP GK	ST	JC CLEAN			PLATE
	2	DARK 175 GK	HOLLOW	AMERICAN CLEAN		WARM	PLATE
	3	BRIGHT E12 GK	12 STRING(E)	JC CLEAN		CLEAR	PLATE
	4	OCTAVE SOLO GK	POLY OCTAVE	AMERICAN CLEAN			PLATE
	5	MELODIC SWELL GK	SLOW GEAR	ACOUSTIC		CLEAR	PLATE
	6	STAGE ACOUSTIC GK	STANDARD	ACOUSTIC			PLATE
	7	DOUBLE STRING GK	12 STRING(A)	ACOUSTIC			PLATE
	8	DIMENSION SITAR GK	SITAR	ACOUSTIC	CHORUS	CLEAR	PLATE
	9	SOLO SYNTH GK	SYNTH LEAD	ACOUSTIC		WARM	PLATE
	10	SAW PAD GK	SYNTH PAD	ACOUSTIC	CHORUS	CLEAR	PLATE
3	1	CHORUS LEAD	LP	METAL	CHORUS	CLEAR	PLATE
	2	FLANGE LEAD	ST	METAL	FLANGER		PLATE
	3	PHASE CLEAN	LP	JC CLEAN	PHASER		PLATE
	4	TREMOLO CLEAN	LP	AMERICAN CLEAN	TREMOLO		SPRING
	5	WAH LEAD	LP	MODERN	WAH	CLEAR	PLATE
	6	RHYTHMIC DELAY	ST	JC CLEAN		WARM	PLATE
	7	TEXAS ROTAR	ST	CLASSIC I	PHASER		SPRING
	8	INCENSE GK	SITAR	TWEED			SPRING
	9	SLOW PAD GK	SLOW GEAR	ACOUSTIC	CHORUS	WARM	PLATE
	10	SLICED SYNTH GK	SYNTH PAD	CLASSIC I+II	TREMOLO	CLEAR	PLATE

* The **GK** logo used in the chart above indicates COSM guitar effects available when GK IN (i.e., a guitar with a GK pickup) is used. COSM guitar effects are not available when INPUT (a normal guitar) is used.

MEMO



For EU Countries

This product complies with the requirements of European Directives EMC 89/336/EEC and LVD 73/23/EEC.

For the USA

FEDERAL COMMUNICATIONS COMMISSION RADIO FREQUENCY INTERFERENCE STATEMENT

This equipment has been tested and found to comply with the limits for a Class B digital device, pursuant to Part 15 of the FCC Rules. These limits are designed to provide reasonable protection against harmful interference in a residential installation. This equipment generates, uses, and can radiate radio frequency energy and, if not installed and used in accordance with the instructions, may cause harmful interference to radio communications. However, there is no guarantee that interference will not occur in a particular installation. If this equipment does cause harmful interference to radio or television reception, which can be determined by turning the equipment off and on, the user is encouraged to try to correct the interference by one or more of the following measures:

- Reorient or relocate the receiving antenna.
- Increase the separation between the equipment and receiver.
- Connect the equipment into an outlet on a circuit different from that to which the receiver is connected.
- Consult the dealer or an experienced radio/TV technician for help.

This device complies with Part 15 of the FCC Rules. Operation is subject to the following two conditions:

- (1) This device may not cause harmful interference, and
- (2) This device must accept any interference received, including interference that may cause undesired operation.

Unauthorized changes or modification to this system can void the users authority to operate this equipment.
This equipment requires shielded interface cables in order to meet FCC class B Limit.

For Canada

NOTICE

This Class B digital apparatus meets all requirements of the Canadian Interference-Causing Equipment Regulations.

AVIS

Cet appareil numérique de la classe B respecte toutes les exigences du Règlement sur le matériel brouilleur du Canada.

Free Manuals Download Website

<http://myh66.com>

<http://usermanuals.us>

<http://www.somanuals.com>

<http://www.4manuals.cc>

<http://www.manual-lib.com>

<http://www.404manual.com>

<http://www.luxmanual.com>

<http://aubethermostatmanual.com>

Golf course search by state

<http://golfingnear.com>

Email search by domain

<http://emailbydomain.com>

Auto manuals search

<http://auto.somanuals.com>

TV manuals search

<http://tv.somanuals.com>