

DESKTOP SIGN MAKER **PNC-900**
CAMM-1
USER'S MANUAL

ROLAND DG CORPORATION

For the USA

**FEDERAL COMMUNICATIONS COMMISSION
RADIO FREQUENCY INTERFERENCE
STATEMENT**

This equipment has been tested and found to comply with the limits for a Class B digital device, pursuant to Part 15 of the FCC Rules.

These limits are designed to provide reasonable protection against harmful interference in a residential installation. This equipment generates, uses, and can radiate radio frequency energy and, if not installed and used in accordance with the instructions, may cause harmful interference to radio communications.

However, there is no guarantee that interference will not occur in a particular installation.

If this equipment does cause harmful interference to radio or television reception, which can be determined by turning the equipment off and on, the user is encouraged to try to correct the interference by one or more of the following measures:

- Reorient or relocate the receiving antenna.
- Increase the separation between the equipment and receiver.
- Connect the equipment into an outlet on a circuit different from that to which the receiver is connected.
- Consult the dealer or an experienced radio/TV technician for help.

Unauthorized changes or modification to this system can void the users authority to operate this equipment.

The I/O cables between this equipment and the computing device must be shielded.

NOTICE

Grounding Instructions

Do not modify the plug provided - if it will not fit the outlet, have the proper outlet installed by a qualified electrician.

Check with qualified electrician or service personnel if the grounding instructions are not completely understood, or if in doubt as to whether the tool is properly grounded.

Use only 3-wire extension cords that have 3-prong grounding plugs and 3-pole receptacles that accept the tool's plug.

Repair or replace damaged or worn out cord immediately.

Operating Instructions

KEEP WORK AREA CLEAN. Cluttered areas and benches invites accidents.

DON'T USE IN DANGEROUS ENVIRONMENT. Don't use power tools in damp or wet locations, or expose them to rain. Keep work area well lighted.

DISCONNECT TOOLS before servicing; when changing accessories, such as blades, bits, cutters, and like.

REDUCE THE RISK OF UNINTENTIONAL STARTING. Make sure the switch is in off position before plugging in.

USE RECOMMENDED ACCESSORIES. Consult the owner's manual for recommended accessories. The use of improper accessories may cause risk of injury to persons.

NEVER LEAVE TOOL RUNNING UNATTENDED.
TURN POWER OFF. Don't leave tool until it comes to a complete stop.

For Canada

CLASS B NOTICE

This digital apparatus does not exceed the Class B limits for radio noise emissions set out in the Radio Interference Regulations of the Canadian Department of Communications.

CLASSE B AVIS

Cet appareil numérique ne dépasse pas les limites de la classe B au niveau des émissions de bruits radio-électriques fixés dans le Règlement des signaux parasites par le ministère canadien des Communications.



KEEP HANDS AWAY WHEN CUTTING TOOL IS IN MOTION.
REGARDEZ BIEN OÙ VOUS METTEZ LES MAINS LORSQUE L'OUTIL DE DECOUPE FONCTIONNE.

CAUTION

- 1) Unauthorized copying or transferral, in whole or in part, of this manual is prohibited.
- 2) The contents of this operation manual and the specifications of this product are subject to change without notice.
- 3) The operation manual and the product have been prepared and tested as much as possible. If you find any misprint or error, please inform us.
- 4) We cannot in any way assume any responsibility whatsoever with regard to whatever consequences that may happen subsequent to the making of changes or alterations to this product. We also cannot in any way assume responsibility for whatever may result when this product is operated, or with regard to whatever results from making use of any explanatory documentation.



ROLAND DG CORPORATION

1227 Ohkubo-cho, Hamamatsu-shi, Shizuoka-ken, JAPAN 432

MODEL NAME : See the MODEL given on the rating plate.

RELEVANT DIRECTIVE : EC MACHINERY DIRECTIVE (89/392/EEC)
EC LOW VOLTAGE DIRECTIVE (73/23/EEC)

YEARS OF MANUFACTURE
1995

Typographic Conventions

This manual uses certain typographic symbols, outlined below.

 This indicates a point requiring particular care to ensure safe use of the product.

 **DANGER** : Failure to heed this message will result in serious injury or death.

 **WARNING** : Failure to heed this message may result in serious injury or death.

 **CAUTION** : Failure to heed this message may result in minor injury.



 **NOTICE** : Indicates important information to prevent machine breakdown or malfunction and ensure correct use.



: Indicates a handy tip or advice regarding use.

⚠ To Ensure Safe Use

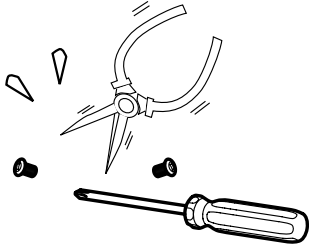
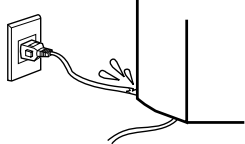
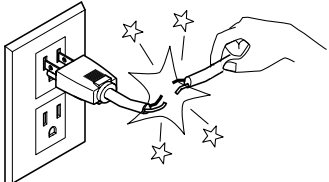
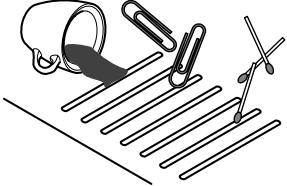
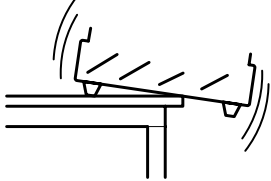
If you find some abnormality, immediately turn off the power switch and check the user's manual to find out what is wrong.

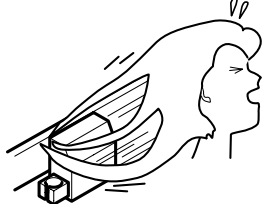
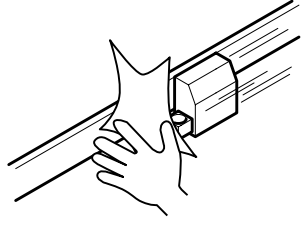
<p>⚠ WARNING Never disassemble or modify this product.</p> 	<p>⚠ CAUTION Handle the power cord with care.</p> <p>Do not step on or damage the power cord, or allow heavy objects to be placed atop it. Failure to heed this may result in electrocution or fire.</p> 	<p>⚠ CAUTION When pulling the power cord from an electrical socket, be sure to grip the plug.</p> 
<p>⚠ CAUTION Do not allow liquids, metal objects or flammables inside the machine.</p> <p>Fire or breakdown may result.</p> 	<p>⚠ CAUTION Do not install in an unstable or high location.</p> <p>Do not installation the machine on the edge of a table, or it may fall.</p> 	<p>⚠ CAUTION Handle the blade with care.</p> 
<p>⚠ CAUTION Ensure the safety of the area around the platen before switching on the power.</p> <p>The carriage moves simultaneously when the power is switched on.</p> 	<p>⚠ CAUTION Do not inadvertently allow the hands, hair, or necktie near the carriage while in operation.</p> 	<p>⚠ CAUTION Do not allow the hands near the platen while in operation.</p> 

⚠ About the Labels Affixed to the Unit

These labels are affixed to the body of this product. The following figure describes the location and content of these messages.

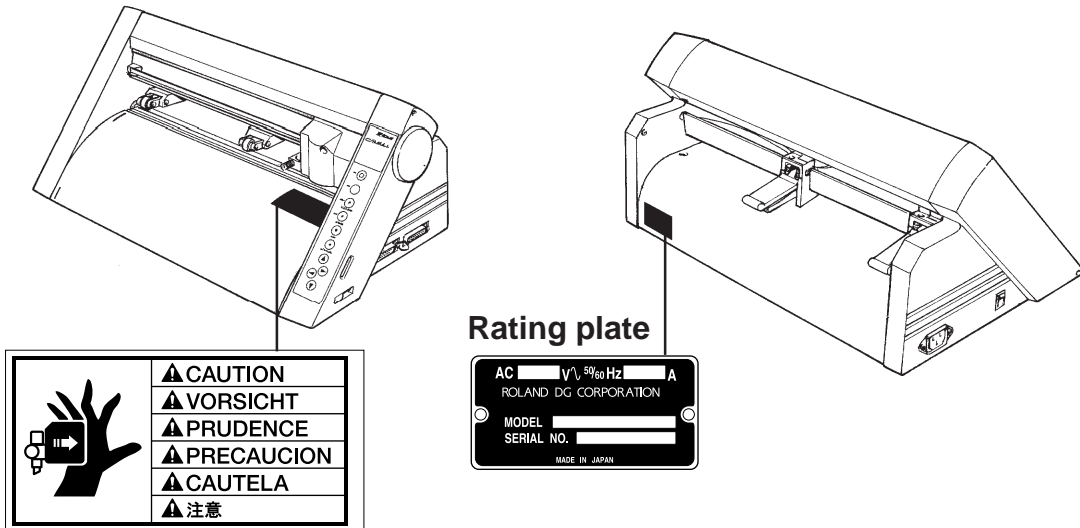

Do not allow the hands near the platen while in operation.

To Ensure Correct Use



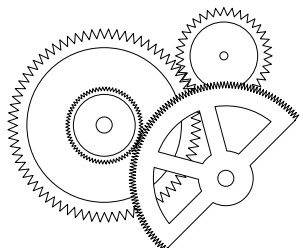

NOTICE
This product is a precision instrument and must be handled with care.



NOTICE
Do not install in an area subject to dust or high humidity or with poor ventilation.



NOTICE
Do not connect to an AC outlet that supplies other than the specified voltage.

100V 	117V 	220V 
	240V 	240V 

NOTICE
When the unit is not in use for an extended period, detach the power supply plug from the AC outlet.

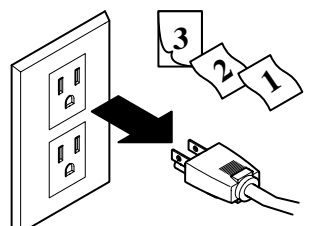









Thanks and Best Wishes

Thank you very much for purchasing the CAMM-1 PNC-900.

Since we wish you many years of productive use of your PNC-900, we ask you to read this manual and make yourself familiar with the PNC-900's operational procedures and requirements before running it.

If you find some abnormality, immediately turn off the power switch and check the user's manual to find out what is wrong.

TABLE OF CONTENTS

1 PRECAUTIONS	
• Precautions Regarding Placement	2
• Precautions in Use	2
2 CHECKING SUPPLIED ITEMS	2
3 PART NAMES AND FUNCTIONS	
• Front View	3
• Rear View	3
• Operation Panel	4
4 BASIC OPERATION	
4-1 Making the Connection with the Computer	5
4-2 DIP Switch Settings	5
4-3 Installing the Blade	6
• Installation	6
• Removal	6
4-4 Loading the Sheet - SETUP Key	7
• Turning on the Power	7
• Loading the Sheet	7
• Removing the Sheet	7
• About the Cutting Area	8
4-5 Setting the Origin Point -  ,  ,  ,  , and ORIGIN SET Keys	8
4-6 Cutting Test to Check Blade Force -  ,  ,  ,  , and TEST Keys	9
4-7 Downloading Cutting Data	10
• Software Settings	10
• Pausing Cutting Operations - Pause Key, Pause LED and SETUP Key	10
• Continuing Cutting	11
• Cutting a Thick Sheet	11
4-8 Applying the Completed Cutout	11
4-9 When Cutting Is Completed	12
Performing a Demo Cutting	12
5 SETTINGS FOR EACH FUNCTION	
• Using the Sheet Effectively (Rotate Function) - ROTATE key and ROTATE LED	13
• Plotting on Paper Media - PEN MODE Key and PEN MODE LED	14
6 ABOUT THE BLADE	15
7 WHAT TO DO IF...	
If the PNC-900 doesn't run... ..	16
The sheet is not cut properly	17
The sheet slips away from the pinch rollers during the cutting process	17
8 LIST OF CAMM-GL III INSTRUCTIONS	
• mode1	18
• mode2	18
• Instructions in mode1 and mode2	19
9 LIST OF DEVICE CONTROL INSTRUCTIONS	20
10 LIST OF OPTIONS	22
11 SPECIFICATIONS OF PNC-900	
• Hardware Specifications	23
• Interface Specifications	24

1 PRECAUTIONS

• When Moving the PNC-900...

Do not try to pick up or move the PNC-900 by grasping the top area of the unit -- be sure to use both hands to grip the PNC-900 securely on the left and right sides.

• Precautions Regarding Placement





- When choosing a place to set up the PNC-900, make sure you have a space that is at least 488 mm (19-1/4") wide, 290 mm (11-7/16") in depth, and 217 mm (8-9/16") in height.
- Since the sheet moves during cutting, make sure the unit is placed on a stable, sturdy surface. Also make sure there is nothing that can block the sheet at both front and rear.
- Never leave the unit in a place that is subject to high levels of humidity.
- Never leave the unit in a place that is subject to direct sunlight, or where the temperature could go to extremes.
- Never leave the unit in a place that is excessively dusty.
- Since it is normal for this device to emit heat when in operation, never place it where it is poorly ventilated and such heat cannot dissipate.

• Precautions in use

- To prevent injuries, be very careful when handling the blades.
- Use the rated power voltage within $\pm 10\%$.
- When turning the power to the unit off and then on again, wait at least 10 seconds after switching the power off before switching it back on.
- Always be careful whenever the unit is operated so as not to risk getting fingers or hair caught in its mechanisms.
- The power cord should always be handled with due care. Do not place heavy objects upon it.
- Under no circumstances should you attempt to disassemble the unit.
- When the unit is not in use, keep the pinch rollers raised. Also, pull out the power cord plug from the receptacle.
- Never move the tool carriage by hand.
- Never allow any liquids, metallic objects, or flammable material to get inside the unit.
- Never allow any strong shock to be applied to this unit.
- Do not place heavy objects on top of the unit.

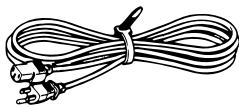
2 CHECKING SUPPLIED ITEMS

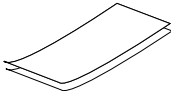
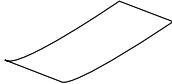
Check the following to make sure that you received all the items that were shipped along with the unit.

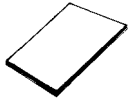
Power Cord: 1 	Blade for Sheet (Carbide): 1 	Blade Holder: 1 
Test-use Sheet: 2 	Test-use Application Sheet: 1 	Test-use Water-based Fiber-tipped Pen: 1 
User's Manual: 1 		

3 PART NAMES AND FUNCTIONS

• Front View

Stationary Pinch Roller

During cutting, this roller holds the sheet down so that it is in contact with the grit roller.

Guide Lines

Align the sheet with these lines when loading.

Grit Roller

Grasps and moves the sheet during cutting.

Platen

The sheet is moved over the platen during the cutting process.

Movable Pinch Roller

During cutting, this roller holds the sheet down so that it is in contact with the grit roller. It can easily be slid to the right or left, and should be positioned to suit the width of the sheet being used.

Tool Carriage

The tool carriage is where the blade holder is mounted. The tool carriage performs the cutting by moving the tool left/right or up/down.

DIP Switches

Used to make various settings.

Serial (RS-232C) Input Connector

In a serial configuration, this connector is where you need to connect the serial cable that is used to communicate with your computer.

Parallel (Centronics) Input Connector

In a parallel configuration, this connector is where you need to connect the parallel cable that is used to communicate with your computer.

Pen Force Control Slider

Sets the blade force to be used with the tool.

Operation Panel

These are keys for making settings for the various functions.

• Rear View

Sheet Loading Lever

Used to raise or lower the pinch rollers when loading or unloading a sheet.

Power Switch

When pushed toward [I], power is turned on.
Push toward [O] to turn it off.

Power Connector (AC IN)

This jack accepts connection of the power cord.

• Operation Panel

* The TEST key and the cursor keys function only when the SETUP LED is lighted, and the ROTATE key functions only when the SETUP LED is extinguished.

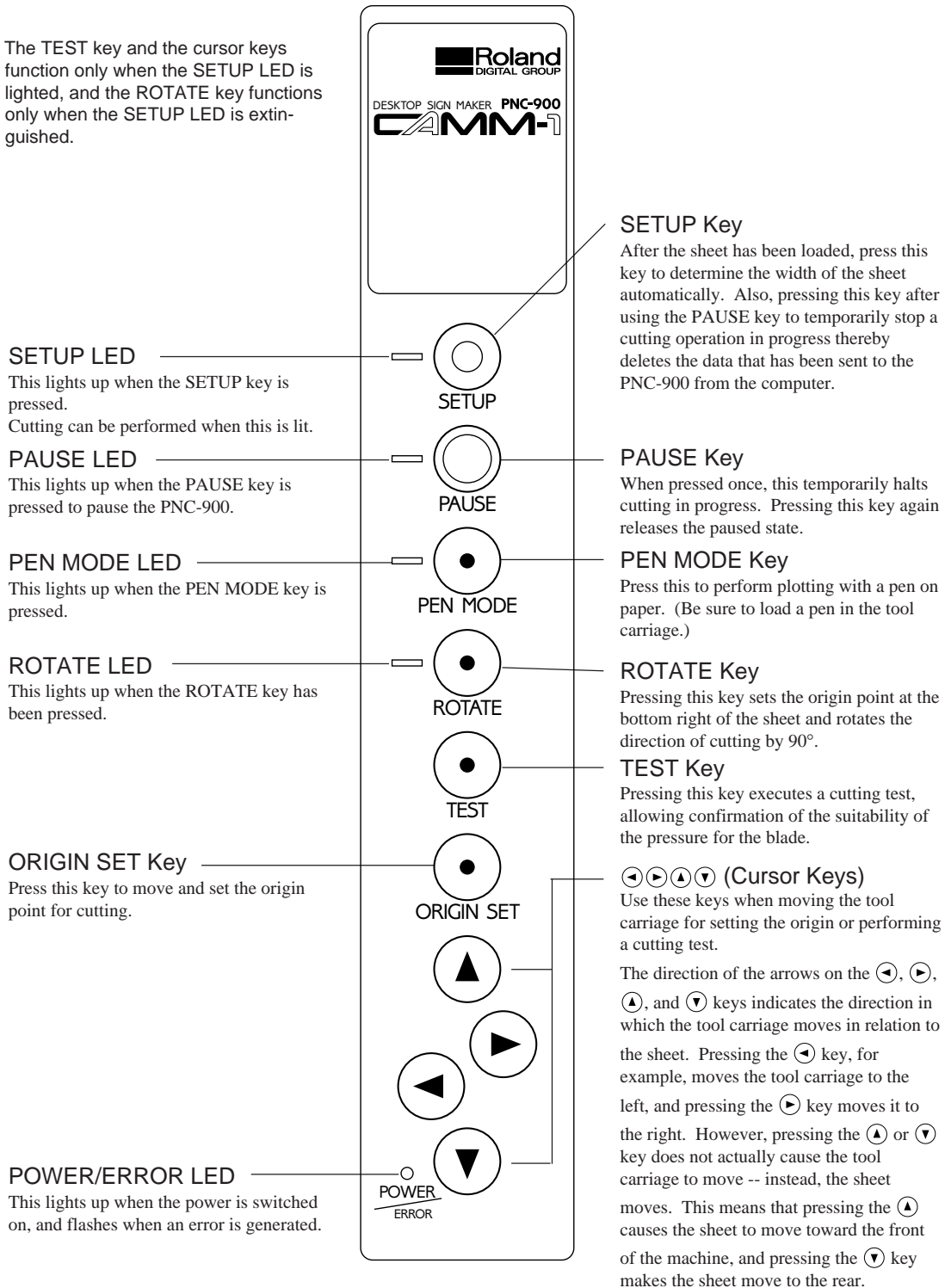

4 BASIC OPERATION

4-1 Making the Connection with the Computer

* Always make sure that the power is off on both the computer and the PNC-900 whenever any cables are connected or disconnected.

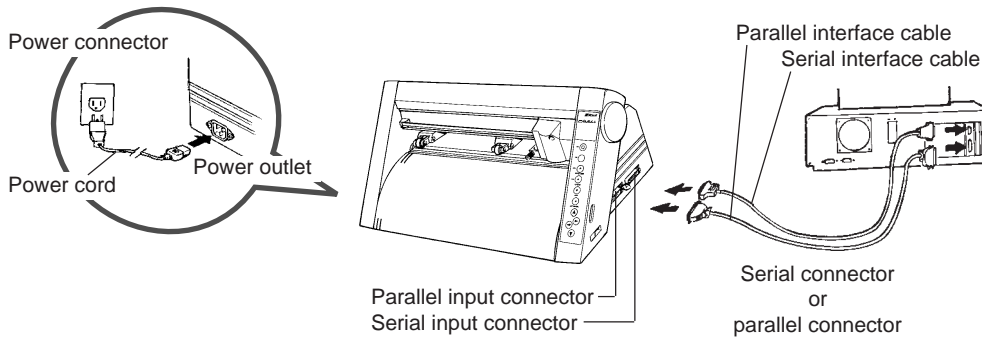

Cables are available separately. One which you are sure matches the model of computer being used should be selected.

When the PNC-900 is connected to the computer via the serial port, the communication parameters for the PNC-900 need to be set at the same values as for the computer. Use the DIP switches on the right-hand side of the PNC-900 to make these settings. Refer to "4-2 DIP Switch Settings" on page 5 to make the correct settings.

4-2 DIP Switch Settings

* DIP switches settings must be made only when the power is turned off.

The DIP switches are located on the right-hand side of the unit. The settings that can be made with these DIP switches are the communication parameters for when the serial port is used, and the value for the blade offset.

When the PNC-900 and the computer are connected through the serial port, use SW-1 through SW-6 to make the correct settings for communication parameters.

The blade offset, which is set with SW-7, should normally be set to OFF (0.25 mm).

The setting for sheet weight, made with SW-8, should normally be set to OFF (light). See "Cutting a Thick Sheet" on page 11 for an explanation of the settings for SW-8.

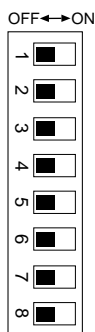

DIP switch	Function	OFF	ON
SW-1	Baud rate	9600	4800
SW-2	Parity check	Disable	Enable
SW-3	Parity check	ODD	EVEN
SW-4	Data bits	8-bit	7-bit
SW-5	Stop bits	1-bit	2-bit
SW-6	Handshake	Hardwire	XON/XOFF
SW-7	Blade offset	0.25	0.5*
SW-8	Sheet weight	Light	Heavy

*Option required ; please consult your dealer.

- All DIP switches are set to OFF when shipped from the factory.
- When SW-2 is set to OFF, SW-3 may be set to either ON or OFF.

4-3 Installing the Blade

- * Always make sure the power switch is off before installing (or replacing) the blade. To prevent injuries, be very careful when handling the blades. Do not touch the tip of the blade with your fingers, as the cutting performance of the blade will be impaired.

• Installation

(1) Insert the blade into the blade holder until it snaps into place with an audible click.

*Take care not to break or chip the blade.

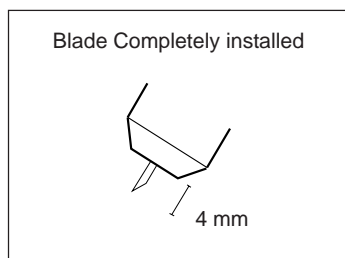
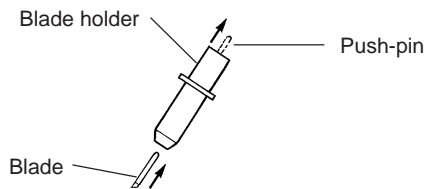

(2) Loosen the tool securing screw on the tool carriage, then insert the blade holder.

Tighten the tool securing screw until the blade holder is secured in place.

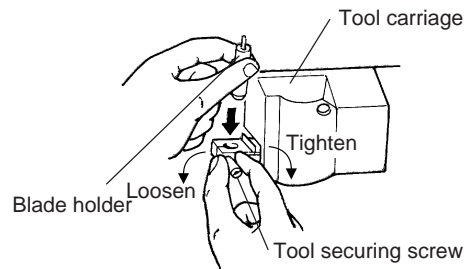

• Removal

(1) Loosen the tool securing screw on the tool carriage, then remove the blade holder from the tool carriage.

(2) Press the push-pin and remove the blade from the blade holder.

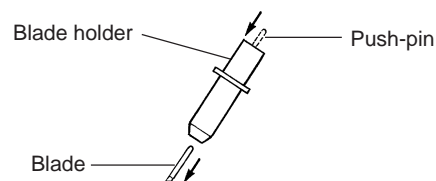
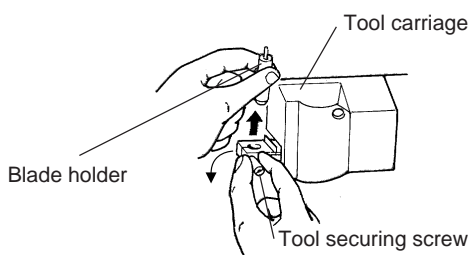

4-4 Loading the Sheet — SETUP Key

• Turning on the Power

* When the power switch is pressed to turn on the unit, the tool carriage moves. Take care to ensure that your hands or other objects do not become caught in the moving parts. When turning the power to the unit off and then on again, wait at least 10 seconds after switching the power off before switching it back on.

Switch on the power switch on the left side of the PNC-900.

• Loading the Sheet

Sheets with a width (horizontal dimension) of 50 mm (1-15/16") to 305 mm (12") can be loaded. There is no particular restriction on sheet length (vertical dimension). This means that either cut sheets or roll sheets can be used.

CAUTION

The tool carriage moves when the SETUP key is pressed. Take care to ensure that your hands or other objects do not become caught in the moving parts. Be sure to raise the sheet loading lever before attempting to move it. Never attempt to force the sheet loading lever.

- (1) Move the sheet loading lever
Before attempting to move the pinch roller, be sure to lower the sheet loading lever.

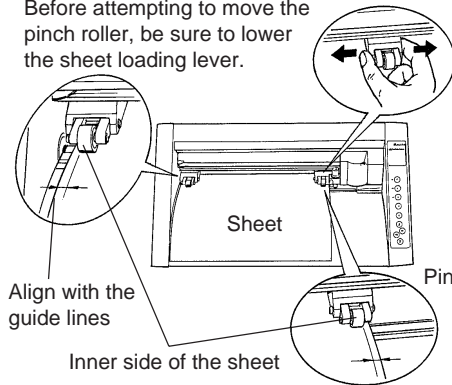

- (2)

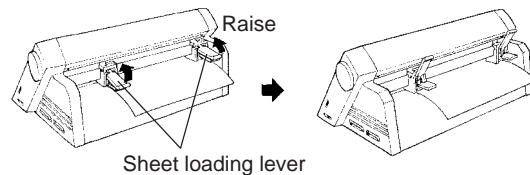

- (3)

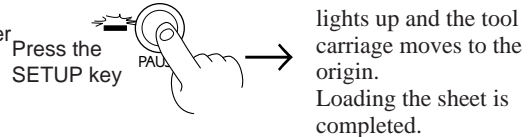

When you have finished loading the sheet, be sure to set the origin to the bottom left of the sheet. See "4-5 Setting the Origin Point" on page 8 for an explanation of how to do this.

* When using a roll sheet, load in place by passing the front edge of the sheet through from the rear of the PNC-900 over the platen. It may be helpful to use a sheet base (available separately).

• Removing the Sheet

- (1)

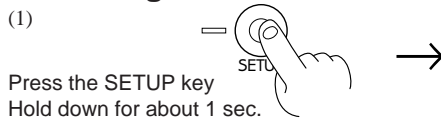

The SETUP LED goes out and the tool carriage moves to the right edge of the cutting area.

- (2)

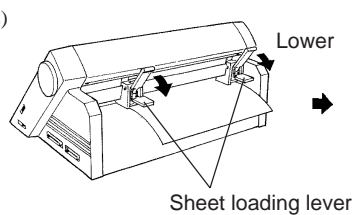

- (3) Remove the sheet.

• About the Cutting Area

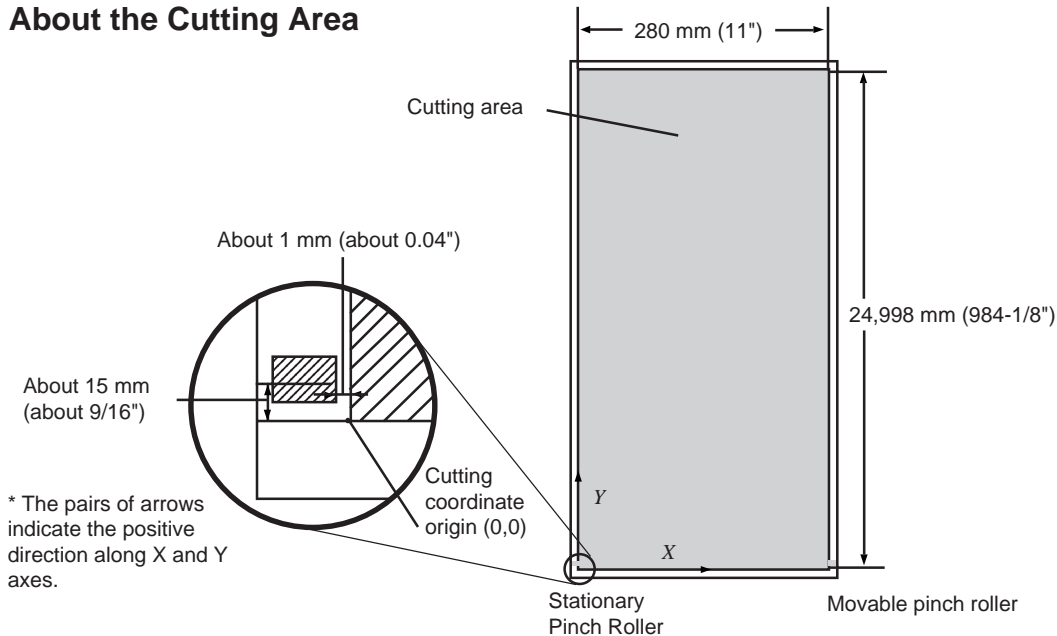

4-5 Setting the Origin Point — ▲, ▼, ◀, ▶, ORIGIN SET Keys

The PNC-900 allows you to set the origin point (0,0) to any location in the cutting area.

When the origin has been set at the desired point, cutting can be carried out anywhere on the loaded sheet.

After the sheet has been loaded, be sure to set the origin to the bottom left of the sheet. (When the Rotate function is used by pressing the ROTATE key, the direction of cutting is rotated 90°, moving the origin to the bottom right of the sheet.)

Also, to make efficient use of a sheet, you can set a new origin in an area on the sheet that has not been cut and then carry out cutting.

Immediately after loading a sheet and pressing the SETUP key to illuminate the SETUP LED, the origin point (0,0) is automatically set to a location near the stationary pinch roller.

When loading the sheet, the origin is set at the left front edge of the sheet if the sheet is loaded close to the stationary pinch roller without pulling the part of the sheet closest to the front of the unit over the platen. This makes it unnecessary to set a new origin point.

When the sheet is loaded with the part of the sheet closest to the front of the unit aligned with the guide line on the platen, no cutting is carried out on the portion of the sheet that is closer to the front of the unit than the origin point (i.e., cutting cannot be performed on areas of the sheet with negative coordinates). Follow the procedure described below to set the origin to the lower left edge of the sheet.

Procedure

* If a sheet has not yet been loaded, then before setting the origin point, refer to "Loading the Sheet" on page 7 to load the sheet correctly. Loading a sheet after the origin has been set (by pressing the SETUP key to extinguish the SETUP LED) cancels the origin that has been set.

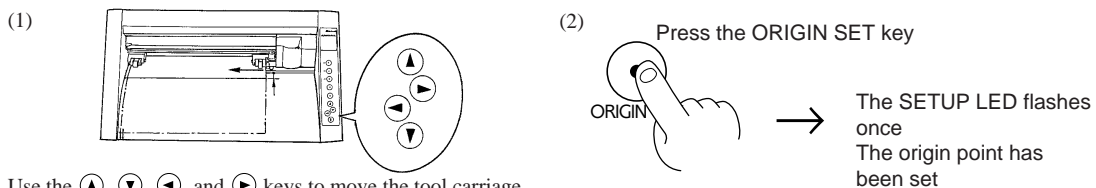

Use the ▲, ▼, ◀, and ▶ keys to move the tool carriage to the position on the sheet where the origin point is to be set.

4-6 Cutting Test to Check Blade Force — ▲, ▼, ◀, ▶, and TEST Keys

Before carrying out actual cutting, you may wish to perform a "cutting test" to check whether the unit produces the cutout satisfactorily.

This "cutting test" allows you to determine whether the settings you have for the blade force are appropriate. See below for a detailed explanation of blade force.

Procedure

* If a sheet has not yet been loaded, then refer to "Loading the Sheet" on page 7 to load the sheet correctly.

Move the pen force control slider all the way to the left (minimum blade force). Increase blade force gradually, keeping an eye on how well the sheet is being cut.

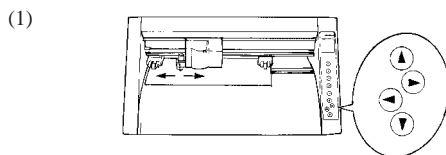

Use the ▲, ▼, ◀, and ▶ keys to move the tool carriage to the position on the sheet where the cutting test is to be executed.

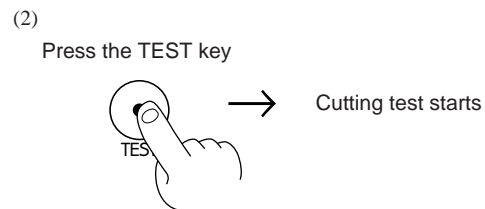

The resulting cutouts will then appear as illustrated. When completed, first peel off the portion indicated by slanted lines. If it can be peeled off by itself, without disturbing the square, you will know that the blade force is at the appropriate level. Next, peel off the square, and look at the backing that was under it. If you can clearly make out the lines left by the blade, you will know that you have the optimum setting.

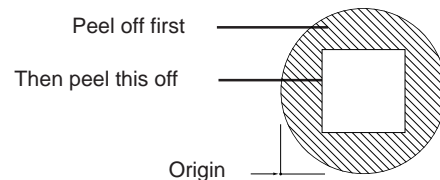

If you do not get results like those shown above, adjust the pen force control slider to obtain the appropriate blade force.

How to Adjust Blade Force

The pen force control slider is located on the right side of the unit. Move the blade force control slider sideways to alter the blade force.

When slid to the farthest setting on the left, the blade force will be set to 30 g. As the slider is moved to the right, the blade force will be gradually increased. When at the farthest setting on the right, the blade force will be set to 200 g, which is the maximum blade force setting provided by the unit. At the center, the blade force will be approximately 120 g.

When making the blade force setting, it is important to take into consideration the hardness of the blade and the thickness of the sheet to be cut, and set the most appropriate value. If the blade force is too weak, the sheet will not be cut satisfactorily. If the blade force is too strong, blade life will be shortened.

Additionally, be aware that problems such as the following may occur.

- The sheet is easily torn
- The blade pierces the sheet
- Cutting extends through the base paper, and normal advancing of the sheet becomes impossible
- The unit suffers damage

4-7 Downloading Cutting Data

The unit will begin cutting when it receives cutting data sent from the computer.

• Software Settings

When cutting with commercially available application software, select PNC-900 as the setting for the output device. (If the PNC-900 cannot be selected, choose any model in the CAMM-1 series -- PNC-1900/1600, PNC-1800, PNC-1100, PNC-1000A, or PNC-1000.)

Select either the parallel (Centronics) or serial (RS-232C) interface. Choose the one that the host computer and the PNC-900 are connected by.

* When loading a sheet that has been cut, be sure to use a sheet that is about 50 mm longer than the vertical size of the cutting data. If data larger than the vertical length of the sheet is sent, the PNC-900 will attempt to cut the data even if it does not all fit in the sheet. This means that the sheet is dislodged from the grit roller, and cutting continues with no sheet. This can cause not only breakage to the blade but also damage to the unit, and adequate care is required to prevent this.

If the sheet becomes dislodged, immediately press the PAUSE key or turn off the power switch.

• Pausing Cutting Operations — PAUSE Key, PAUSE LED, and SETUP Key

If you want to stop the PNC-900 momentarily while it is performing cutting, follow the procedure described below.

Procedure

(1)

Press the PAUSE key

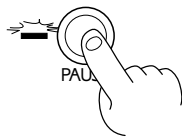

The PAUSE LED lights up and cutting is paused

(2)

To Resume Cutting

Press the PAUSE key

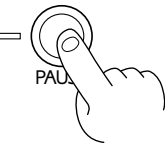

The PAUSE LED goes out and cutting resumes

To Terminate Cutting

(2)-1 Halt transmission of cutting instructions from the computer

(2)-2

Hold down the SETUP key

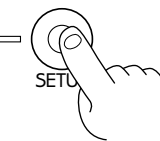

The SETUP LED goes out, cutting instructions already sent from the computer to the PNC-900 are deleted, the tool carriage moves to the right, and cutting stops

* If you want to completely stop the operation of the PNC-900, turn off the power switch.

• Continuing Cutting

Cutting After Changing the Sheet

Again carry out the procedure described from "Loading the Sheet" on page 7 to "4-7 Downloading Cutting Data" on page 10.
* If a sheet of the same type is used, there is no need to perform a cutting test.

Continuing Cutting on the Same Sheet

Refer to "4-5 Setting the Origin Point" on page 8 to set the origin for the area where cutting is to be carried out next. Then send cutting data from the computer to the PNC-900.

• Cutting a Thick Sheet

SW-8, one of the DIP switches located on the right side of the unit, is normally set to OFF (light). It is recommended that SW-8 be set to ON (heavy) when cutting a thick or heavy sheet. Cutting speed slows down when this is done, but the force used to move the sheet and the blade increases.
* Remember that DIP switch settings must be made only when the power is turned off.

4-8 Applying the Completed Cutout

Once cutting has been completed, the resulting work can be affixed in place as explained below.

Procedure

Notes

- Make sure beforehand that the surface where the work is to be stuck is clean and free of all dust or oily deposits.
- When applying the work to a transparent surface, such as a window, you can use a water-based pen (which can be wiped off afterwards) to mark guidelines on the reverse side of the glass, to aid in getting the work aligned properly.
- If you discover after it is stuck in place that air bubbles were trapped under the work, use a needle to puncture them. Then you can smooth out the sheet out so that it sticks securely.

(1)

For Cut Sheets

Refer to "Removing the Sheet" on page 7 to remove the sheet from the PNC-900.

For Roll Sheets

Use scissors or something similar to sever the area that has been cut from the roll sheet.

(2)

Strip away all unneeded portions from the completed work.
*You should direct that a rectangle be cut around the targeted work.

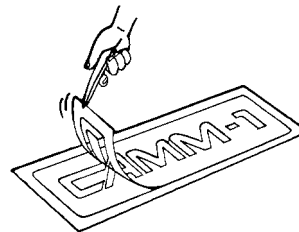

- (3)
Stick application tape over the completed work.
Press down firmly on the application sheet to remove air bubbles. If you do not press firmly enough the cut area will not stick to the surface.

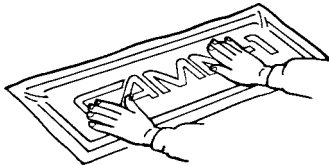

- (4)
Carefully apply the work at the desired location, while keeping it as straight as possible. Rub over the application tape to make sure the work is firmly stuck in place. Then peel off the application tape.

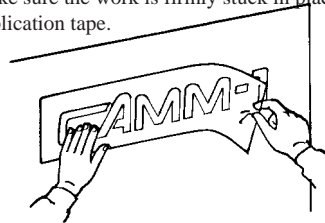

4-9 When Cutting Is Completed

- (1) When cutting is finished, press down the sheet loading levers and remove the sheet. (See "Removing the Sheet" on page 7.)
- (2) If a blade was used, wipe the blade with a soft cloth to remove any pieces of the sheet that may be adhering to it.
If a pen was used, remove the pen from the tool carriage and cap it securely.
- (3) Turn off the power.
If you do not intend to use the unit for an extended period of time, you should pull the plug for the power cord out of the outlet.

* For routine cleaning, use a soft piece of cloth.

Performing a Demo Cutting

The PNC-900 is equipped with a "self-test" function to conveniently allow you to check whether or not it is capable of operating normally. Should you ever suspect that the PNC-900 is not performing satisfactorily, you should follow the steps below to perform the self-test.

* A computer is not required in order to carry out the self-test.

- (1) Refer to "4-3 Installing the Blade" and install a blade holder (or pen) in the PNC-900's tool carriage.
- (2) Set the pen force to the smallest possible value (the pen force slider should be at the furthest point to the left). If after the first test you feel that the sheet was not cutout clean enough, you can try gradually increasing the pen force until you have the optimum level.
- (3) Hold down the  key on the panel while you turn the power on.

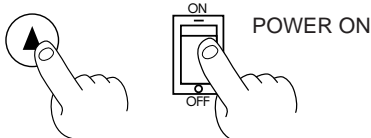

- (4) Load the sheet (or some paper), following the procedure described in "4-4 Loading the Sheet."

- (5) Press the SETUP key.
Demo cutting starts.

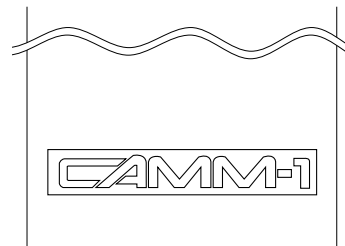

5 SETTINGS FOR EACH FUNCTION

• Using the Sheet Effectively (Rotate function) — ROTATE Key and ROTATE LED

If there is still unused material on the right side, rotation allows you to use this remaining material effectively. This function sets the origin point at the bottom right and rotates the text (or graphics) 90°.

You have already learned of the method whereby a new user origin is set, allowing further cutting to be carried out within the remaining material. Depending on the shape and the size of characters, however, you may wish to rotate a character instead in order to cut it.

In this case, you can use the rotate function to rotate the character string "Roland" at 90°, so that the whole character string then easily fits into the available material.

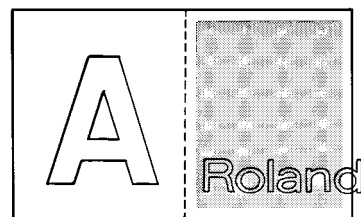

The "d" extends beyond the available material.

Procedure

- (1) Check that the SETUP LED has gone out, and press the ROTATE key.

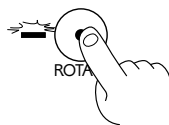

The ROTATE LED lights up

* If the SETUP LED is illuminated, the ROTATE LED will not light up when the ROTATE key is pressed. Press the SETUP key to extinguish the SETUP LED, then press the ROTATE key again.

- (2) Press the SETUP key

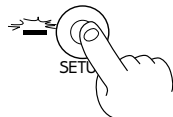

The SETUP LED goes out

- (3) Send cutting data from the computer

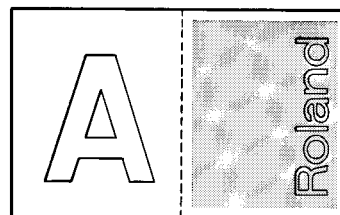

Character string rotated by 90°.

Canceling the Rotate Function

After holding down the SETUP key for about one second to make the SETUP LED go out, press the ROTATE key. The ROTATE LED is extinguished, and the origin returns to the point at bottom left.

The ROTATE function is also canceled when the power to the PNC-900 is turned off.

When the character string "Roland" is rotated by 90°, the X axis, Y axis, and origin change as follows:

0° Rotation

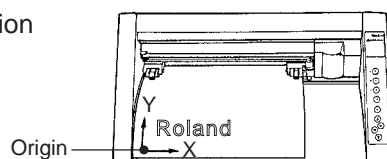

90° Rotation

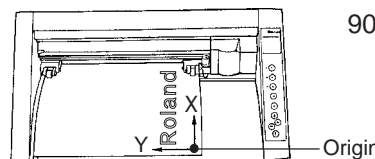

* The pairs of arrows indicate the positive directions along the X and Y axes.

• Plotting on Paper Media — PEN MODE Key and PEN MODE LED

The PNC-900 is also capable of plotting on paper media using plotter pens made by this company. You should use only thick water-based fiber-tipped pens.

Since the design of the PNC-900 differs inherently from that of dedicated plotters, it does not accommodate functions such as high-speed plotting, automatic pen changes, pen dry protection, or the like.

Procedure

- (1) Refer to "Installation" in on page 6 to install a pen. (In the instructions, read "pen" for "blade holder.") There is no need to perform an operation test when in the Pen Mode.
- (2) Refer to "Loading the Sheet" on page 7 to load a piece of paper in the same way as for loading a sheet. Paper with a width (horizontal dimension) between 50 mm (1-15/16") and 305 mm (12") can be loaded.

(3)

Press the PEN MODE key

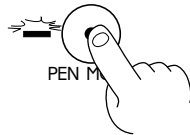

The PEN MODE LED lights up

- (4) Plotting begins when plotting instructions are sent from the computer.

* Be sure to perform pen plotting only in the Pen Mode.

Stopping Plotting on Paper Media

Press the PEN MODE key. The PEN MODE LED is extinguished and the unit returns to the cutting mode.

Pen Replacement

Pens will eventually wear out. Should the tip become rough and produce scratchy lines, try gradually increasing the blade force (refer to page 8, "4-6 Cutting Test to Check Blade Force"). If increasing the blade force does not help, the pen should be replaced.

6 ABOUT THE BLADE

If the blade becomes dull

When the blade starts to lose its sharpness, try gradually increasing the blade force (refer to page 8, "4-6 Cutting Test to Check Blade Force").

Increasing the blade force temporarily allows the blade to perform better. However, once the blade no longer provides reliable cutting, it is worn out. Since the blade is expendable, it must be replaced as often as necessary.

Average blade life

The life of a blade is determined mainly by the amount of cutting it performs. The following table shows the average life of blades.

The total cutting length actually obtained can vary considerably depending on the thickness, toughness, and type of adhesive layer that the sheet has. Set an appropriate blade force, one that is well matched to the type of sheet and hardness of the blade, and the life of the blade will be extended. Excessive blade forces can cause the blade to wear out quickly. Care should be taken.

Blade type	Available cutting length
Carbide blade	Approx. 3000 meters

7 WHAT TO DO IF...

If the PNC-900 doesn't run...

PNC-900

- Is the PNC-900 power on?
Turn on the power.
- Is the unit in SETUP status (the SETUP LED is lit)?
If the SETUP LED is not illuminated, make sure the sheet is loaded correctly and press the SETUP key to illuminate the SETUP LED.
- Is the PAUSE LED illuminated?
If the PAUSE key has been pressed and the PAUSE LED is lit up, the unit has been paused (see "Pausing Cutting Operations" on page 10).
If you want to resume cutting, press the PAUSE key again. The PAUSE LED is extinguished, and cutting resumes.
If you want to terminate cutting, first stop the transmission of cutting instructions from the computer to the PNC-900. Then press the SETUP key. This deletes the cutting instructions that have already been sent from the computer to the PNC-900, and cutting is stopped.
- If connected via the serial port, do the communication parameters for the PNC-900 match those of the computer?
Set the DIP switches correctly (see "4-2 DIP Switch Settings" on page 5.)

Computer

- Is the computer set up correctly?
Check the following items:
 - DIP switches
 - Memory switches
 - Interface board
 - Communication parameters
 - Other settings
Read the computer user's manual and set it up correctly.

Connection cable

- Are the computer and the PNC-900 linked with the right cable?
The type of cable you need is determined by your computer and the software you are using. Even if the computer is the same, running different software may require a different cable. Use the cable specified in your software.
- Is the cable making a secure connection?
Connect securely.

Software

- Is the OS set up correctly?
Check the following items:
 - Output port selection
 - Output device selection
 - Output port open
 - Communication parameters
 - Other settings
Check the OS user's manual and set it up correctly.
- Are the application software settings correct?
Check the following items:
 - Output device specifications (select a device name that matches the instruction system. If the wrong device is selected an incorrect instruction may be output, resulting in an error).
 - Communication parameters
 - Other settings
Check the software user's manual and set it up correctly.

The POWER/ERROR LED is blinking

- If there is an error in the data downloaded to the PNC-900 from the computer, the PNC-900 generates an error (the POWER/ERROR LED begins to blink), and cutting cannot be carried out. The error can be canceled by switching off the power. After turning off the power, check the following.
- If you are using application software, has the correct output device been selected?
Select "PNC-900" as the output device. If this selection is not available, select any model in the CAMM-1 series (the PNC-1900/1600, PNC-1800, PNC-1100, PNC-1000A, or PNC-1000).

-
- If you are using a program that you have created yourself, have correct commands been sent?
The PNC-900 is equipped with the CAMM-GL III instruction system. For details, refer to "8 List of CAMM-GL III Instructions" on page 18.
 - Do the DIP switch settings match the settings made for the application software?
Refer to "4-2 DIP Switch Settings" on page 5 to make the correct DIP switch settings.
 - Does the connecting cable match the settings for the application software and the computer?
Refer to the operation manuals for your application software and computer to select and connect the appropriate cable.

The sheet is not cut properly

- Are the blade and blade holder installed correctly and securely?
Install these so that there is no looseness (see "4-3 Installing the blade" on page 6).
- Is the blade chipped?
If it is, replace it with a new one (see "4-3 Installing the blade" on page 6).
- Check if there are any dirty deposits on the blade.
If dirty, remove and clean the blade.
- Make sure you are using an appropriate blade force setting.
Perform a "cutting test," then adjust the blade force slider as necessary to obtain the optimum blade force (refer to page 9, "4-6 Cut Test to Check Blade Force").
- If you are cutting a thick sheet, set DIP switch SW-8 to ON (heavy). (See "4-2 DIP Switch Settings" on page 5 and "Cutting a Thick Sheet" on page 11.)

The sheet slips away from the pinch rollers during the cutting process

- Are the sheet loading levers on both the left and right sides raised?
If a sheet loading lever has not been raised, then the sheet has not been secured in place. Make sure that the pinch rollers on the left and right sides are within the boundaries of the sheet, and raise the sheet loading levers. (Refer to "4-4 Loading a Sheet" in on page 4.)
- Make sure the sheet is parallel with the grit roller.
If the front edge of the sheet you are working with is at an angle, cut off the odd-shaped part to make it straight, then align it so that it is parallel with the grit roller.
- If the sheet is to be advanced over a long distance, moving the movable pinch roller inward slightly can help prevent the sheet from becoming dislodged. Also, after loading the sheet, it is recommended that you carry out cutting after first using the  key to advance the sheet by the amount that will be used for cutting, and make sure that the sheet does not slip away from the stationary and pinch rollers.
- If a roll sheet is used, carry out cutting after first pulling out the amount of sheet that is to be used. The sheet is susceptible to slips when it is pulled out by the cutting process.
- Make sure that the left and right edges of the sheet do not touch the inner surfaces of the PNC-900 during cutting. Such contact may not only damage the sheet, but could also make normal sheet advancing impossible and cause the sheet to slip.

8 LIST OF CAMM-GL III INSTRUCTIONS

*1: $-(2^{26}-1) \text{---} +(2^{26}-1)$ *2: $0 \text{---} +(2^{26}-1)$ *3: $-(2^{26}-1)^{\circ} \text{---} +(2^{26}-1)^{\circ}$ *4: $21_{(16)} \text{---} 3A_{(16)}, 3C_{(16)} \text{---} 7E_{(16)}$

• mode1

Instruction	Format	Meaning of Parameter [Parameter Range (Default)]	Explanation
H	H	None	Move to User Origin
D	D x1, y1..., xn, yn	xn: Absolute X-axis coordinate [*1] yn: Absolute Y-axis coordinate [*1]	Cut Absolute Line
M	M x1, y1...,xn,yn	xn: Absolute X-axis coordinate [*1] yn: Absolute Y-axis coordinate [*1]	Tool-up to Absolute Coordinate Point
I	I Δx1, Δy1...,Δxn, Δyn	Δxn: Relative X-axis coordinate [*1] Δyn: Relative Y-axis coordinate [*1]	Cut Relative Line
R	R Δx, Δy	Δxn: Relative X-axis coordinate [*1] Δyn: Relative Y-axis coordinate [*1]	Tool-up Move to Relative Coordinate Point
L	L p	p: Line pattern [-5 --- +5(0)]	Specify Line Type
B	B l	l: Pitch length [*2 1.5% of (P2-P1)]	Specify Broke Line Pitch
X	X p,q,r	p: Coordinate axis [0, 1] q: Tick interval [*1] r: Number [1---32767]	Plot Coordinate System
P	P c1c2...cn	cn: Character	Plot Character
S	S n	n: Character size [0 --- 127(61)]	Set Character Size
Q	Q n	n: Rotation angle (90°as a unit) [n =0---3(0)]	Specify Character Rotate Angle
N	N n	n: Number of special symbol [1---15]	Plot Special Symbol
C	C x, y, r, Ø1, Ø2,(Ød)	x, y: Center coordinates [*1] r: Radius [*1] Ø1•Ø2: Start angle • End angle [*1] Ød: Chord tolerance [*1 (5°)]	Cut Arc
E	E r, Ø1, Ø2,(Ød)	r: Radius [*1] Ø1•Ø2: Start angle • End angle [*1] Ød: Chord tolerance [*1 (5°)]	Cut Arc from Tool Position
A	A x, y	x: Center x coordinate [*1(0)] y: Center y coordinate [*1(0)]	Specify G & K Center Coordinate
G	G r,Ø1, Ø2,(Ød)	r: Radius [*1] Ø1: Start angle [*1] Ø2: End angle [*1] Δd: Chord tolerance [*1 (5°)]	Cut Arc Around A-Instruction Center
K	K n, l1, l2	n: Division line angle [*1] l1: Division line end point distance [*1] l2: Division line start point distance [*1]	Plot Division Line
T	T n, x, y, d, t	n: Hatching pattern [0 --- 3] x, y: Rectangle size [*1] d: Hatching spacing [*1] t: Hatching angle [1 --- 4]	Plot and Hatch Rectangle
^	[mode 2 instruction] [parameter]....., [parameter] [terminator]		Call mode 2

• mode2

Instruction	Format	Meaning of Parameter [Parameter Range (Default)]	Explanation
AA	AA x,y,Øc,(Ød);	x, y: Absolute center coordinates [*1] Øc:Center angle [*1] Ød: Chord tolerance [*1 (5°)]	Arc Absolute
AR	AR Δx, Δy,Øc,(Ød);	Δx, Δy: Relative center coordinates [*1] Øc: Center angle [*1] Ød: Chord tolerance [*1 (5°)]	Arc Relative
CA	CA n; CA;	n: Character set No. [0 --- 4, 6 --- 9, 30 --- 39]	Alternate Character set
CI	CI r,(Ød);	r: Radius [*1] Ød: Chord tolerance [*3 (5°)]	Circle
CP	CP nx,ny; CP;	nx: Number of characters in X-axis direction [*1] ny: Number of characters in Y-axis direction [*1]	Character Plot
CS	CS n; CS;	n: Character set number	Standard Character Set
DF	DF;	None	Default
DI	DI run, rise;	run: X-axis direction vector [*1 (1)] rise: Y-axis direction vector [*1 (0)]	Absolute Direction
DR	DR run, rise;	run: X-axis direction vector [*1 (1)] rise: Y-axis direction vector [*1 (0)]	Relative Direction
DT	DT t;	t: Label terminator [[ETX]]	Define Label Terminator
EA	EA x, y;	x, y: Absolute XY coordinates of opposite angle of rectangle [*1]	Edge Rectangle Absolute
ER	ER Δx, Δy;	Δx, Δy: Relative XY coordinates of opposite angle of rectangle [*1]	Edge Rectangle Relative
EW	EW r, Ø1, Øc,(Ød);	r: Radius [*1] Ø1: Start angle [*3] Øc: Center angle [*3] Ød: Chord tolerance [*3 (5°)]	Edge Wedge
FT	FT n,(d,(Ø)); FT;	n: Pattern [1 --- 5 (1)] d: Spacing [*2 ((P2x-P1x) x 0.01)] Ø: Angle [*3 (0°)]	Fill Type
IM	IM e; IM;	e: Error mask value [0 --- 255 (223)]	Input Mask
IN	IN;	None	Initialize
IP	IP P1x, P1y, P2x, P2y; IP;	P1x, P1y: XY coordinates of P1 [*1] P2x, P2y: XY coordinates of P2 [*1]	Input P1 & P2
IW	IW LLx, LLy, URx, URy; IW;	LLx, LLy : lower left coordinates of window URx,URy : Upper right coordinates of window	Input Window
LB	LB c1c2c3...cn [label terminator]	c: Character string	Label
LT	LT n,(l); LT;	n: Pattern number [0 --- 6 (solid line)] l: l pitch length [*2 (1.5% of (P2-P1))]	Line Type

Instruction	Format	Meaning of Parameter [Parameter Range (Default)]	Explanation
OA	OA;	None	Output Actual Point
OC	OC;	None	Output Commanded Position
OE	OE;	None	Output Error
OF	OF;	None When the PNC-900 receives an OF instruction from the computer, "40,40 [TERM]" is output.	Output Factor
OH	OH;	None	Output Hard-Clip Limits
OI	OI;	None When the PNC-900 receives an OI instruction from the computer, "900 [TERM]" is output.	Output Identification
OO	OO;	None When the PNC-900 receives an OO instruction from the computer, "0,0,0,0,1,0,0,0 [TERM]" is output. The "1" in this output indicates that circle and arc commands have been loaded	Output Option Parameter
OP	OP;	None	Output P1 & P2
OS	OS;	None	Output Status
OW	OW;	None	Output Window
PA	PA x1, y1(...,xn, yn); PA;	xn, yn: Absolute XY coordinates [*1]	Cut Absolute
PD	PD x1, y1(...,xn, yn); PD;	xn, yn: XY coordinates [*1]	Tool Down
PR	PR Δ1, Δy1(...Δxn, Δyn); PR;	Δxn, Δyn: Relative XY coordinates [*1]	Cut Relative
PT	PT d; PT;	d: Pen thickness (mm) [0—5 (0.3)]	Pen Thickness
PU	PU x1, y1(...,xn, yn); PU;	xn, yn: XY coordinates [*1]	Tool Up
RA	RA x, y;	x, y: Absolute XY coordinates of opposite angle of rectangle [*1]	Shade Rectangle Absolute
RR	RR Δx, Δy;	Δx, Δy: Relative XY coordinates of opposite angle of rectangle [*1]	Shade Rectangle Relative
SA	SA;	None	Select Alternate Set
SC	SC Xmin, Xmax, Ymin, Ymax; SC;	Xmin, Ymin: User XY coordinates of P1 [*1] Xmax, Ymax: User XY coordinates of P2 [*1]	Scaling
SI	SI w, h; SI;	w: Character width (cm.) [-128 — +127.99999 (3.8)] h: Character height (cm.) [-128 — +127.99999 (5)]	Absolute Character Size
SL	SL tanθ; SL;	tanθ: Character slant [*1 (0)]	Character Slant
SM	SM s; SM;	s: Character or symbol [*4 (Default: Clears symbol mode)]	Symbol Mode
SR	SR w, h; SR;	w: Character width (%) [*1 (3.8)] h: Character height (%) [*1 (5)]	Relative Character Size
SS	SS;	None	Select Standard Set
TL	TL lp,(lm); TL;	lp: Tick length in positive direction [*2 (0.5%)] lm: Tick length in negative direction [*2 (0.5%)]	Thick Length
UC	UC (c,)Δx, Δy,(c,).....Δxn, Δyn; UC;	c: Tool control value [-(67108863) — -99, +99 — +(67108863)] Δxn: Units of movement in X-axis direction [-99<Δxn<+99] Δyn: Units of movement in Y-axis direction [-99<Δyn<+99]	User Defined Character
VS	VS v; VS;	v: Tool speed (cm/sec.) [1 — 20]	Velocity Select
WG	WG r, Ø1, Øc,(Ød);	r : Radius [*1] Ø1 : Start angle [*3] Øc : Center angle [*3] Ød : Chord tolerance [*3 (5°)]	Shade Wedge
XT	XT;	None	X-Tick
YT	YT;	None	Y-Tick

• Instructions in mode1 and mode2

Instruction	Format	Meaning of Parameter [Parameter Range (Default)]	Explanation
!NR	!NR [terminator]	None	Not Ready
!PG	!PG n [terminator]	n: [-1600 — +1600 mm]	Page Feed
!ST	!ST n [terminator]	n: [0, 1]	Select Tool

9 LIST OF DEVICE CONTROL INSTRUCTIONS

Device control instructions are used to determine the communication sequence between the PNC-900 and computer through RS-232C interface and to tell the computer the current PNC-900 state. Among them, some device control instructions set the output specifications of CAMM-GL III instructions.

Each device control instruction is organized with three letters: [ESC], ".", and one uppercase letter. Device control instructions are of two types: one with parameters and the other without parameters.

Parameters can be omitted. A semicolon ";" is used as a delimiter to separate parameters if they are input in succession. A "." without parameters means that parameters were omitted.

If parameters are omitted, the default value is set. For a device control instruction with parameters, a terminator needs to be input in order to signify the end of instructions. A colon ":" is used as the terminator which cannot be omitted.





Instruction	Format	Parameter	Range ([] is default)	Explanation										
Handshake Instructions														
ESC .B Output Remaining Buffer Capacity	[ESC].B	None		Outputs the current remaining buffer capacity to the computer.										
ESC .M Set Handshake Output Specifications (1)	[ESC].M<P1>;<P2>;<P3>;<P4>;<P5>;<P6>;	P1: Delay time P2: Output trigger character P3: Echo terminator P4: Output terminator P5: Output terminator P6: Output initiator	0—32767 (msec) [0 (msec)] [0 (Sets nothing)] [0 (Sets nothing)] [13 ((CR))] [0 (Sets nothing)] [0 (Sets nothing)]	Sets handshake output specifications. Note: When you specify some values to <P4> and <P5>, always set 0 to <P6>. When you specify some value to <P6>, always set 0 to <P5>.										
ESC .N Set Handshake Output Specifications (2)	[ESC].N<P1>;<P2>;<P3>; <P11>;	P1: Intercharacter delay P2-P11 : Xoff character (for Xon/Xoff) Immediate response character (for ENQ/ACK)	0—32767 (msec) [0 (msec)] [All 0 (Sets nothing)]	Sets an intercharacter delay, and also an Xoff character for performing the Xon/Xoff handshake.										
ESC .H Sets ENQ/ACK Handshake Mode1	[ESC].H<P1>;<P2>;<P3>; <P12>;	P1: The number of bytes for data block P2: ENQ character P3-P12 : ACK character (only when <P2> is set)	0—15358 (byte) [80 (byte)] [0 (Sets nothing)] [All 0 (Sets nothing)]	When receiving the ENQ character set by <P2>, compares the value set by <P1> and the remaining buffer capacity, and returns the ACK character to the host computer when the remaining buffer capacity is larger. The [ESC].H with no parameter performs a dummy handshake.										
ESC .I Set Xon/Xoff Handshake and ENQ/ACK Handshake Mode2	[ESC].I<P1>;<P2>;<P3>; <P12>;	P1: Limit of the remaining buffer capacity (for Xon/Xoff) The number of data block bytes (for ENQ/ACK (mode2)) P2: ENQ character (for ENQ/ACK (mode2)) 0 (for Xon/Xoff) P3-P12 : Xon character (for Xon/Xoff) ACK character (for ENQ/ACK (mode2))	0—15358 (byte) [80 (byte)] [0 (Sets nothing)] [All 0 (Sets nothing)]	Used for performing the Xon/Xoff handshake and the ENQ/ACK handshake mode 2. The [ESC].I instruction with no parameter performs a dummy handshake. In a dummy handshake, always returns the ACK character to the host computer, regardless of the remaining buffer capacity, when receiving the ENQ character.										
ESC .@ Controls DTR	[ESC].@ P1:P2:	P1: Ignored P2: DTR signal control	0—255 [1]	Controls the DTR signal (No. 20 pin of RS-232C). An even number parameter (e.g. 0) always sets the DTR signal to High without performing the hardware handshake. An odd number parameter (e.g. 1) performs the hardware handshake and controls the DTR signal according to the remaining buffer capacity.										
Status Instructions														
ESC .O Outputs the Status of Buffer, Pause	[ESC].O	None		Outputs the status codes of PNC-900 shown in the table below. <table border="1" style="margin-left: auto; margin-right: auto;"> <thead> <tr> <th>Code</th> <th>Meaning</th> </tr> </thead> <tbody> <tr> <td>0</td> <td>Data remaining in buffer.</td> </tr> <tr> <td>8</td> <td>Buffer empty.</td> </tr> <tr> <td>16</td> <td>Data remaining in buffer, PNC-900 being paused (Pause On being displayed).</td> </tr> <tr> <td>24</td> <td>Buffer empty, PNC-900 being paused (Pause On being displayed).</td> </tr> </tbody> </table>	Code	Meaning	0	Data remaining in buffer.	8	Buffer empty.	16	Data remaining in buffer, PNC-900 being paused (Pause On being displayed).	24	Buffer empty, PNC-900 being paused (Pause On being displayed).
Code	Meaning													
0	Data remaining in buffer.													
8	Buffer empty.													
16	Data remaining in buffer, PNC-900 being paused (Pause On being displayed).													
24	Buffer empty, PNC-900 being paused (Pause On being displayed).													

Instruction	Format	Parameter	Range ([] is default)	Explanation																		
ESC .E Output RS-232C Error Code	[ESC].E	None		<p>Outputs an error code related to RS-232C interface (see the table below), and clears the error simultaneously. At the same time, the error being displayed is canceled.</p> <table border="1"> <thead> <tr> <th>Error code</th> <th>Possible cause and action</th> </tr> </thead> <tbody> <tr> <td>0</td> <td>No I/O errors</td> </tr> <tr> <td>10</td> <td>Cause: after execution of an output command, other output instructions are sent before the output was not completed. Action: let the computer to read the PNC-900 output by the output instruction and then send another output instruction.</td> </tr> <tr> <td>11</td> <td>Cause: an error occurs in a device control instruction. Action: correct your program.</td> </tr> <tr> <td>12</td> <td>Cause: incorrect parameter are set to a device control instruction (the default value is set to the erroneous parameter) Action: correct your program.</td> </tr> <tr> <td>13</td> <td>Cause: parameters are overflowing. Action: correct your program.</td> </tr> <tr> <td>14</td> <td>Cause: the number of the parameters set is more than specified or a colon ':' was not used to terminate. Action: correct your program.</td> </tr> <tr> <td>15</td> <td>Cause: framing error, parity error or over-run error at the time of data receipt . Action: match the communication protocols of both computer and PNC-900 (baud rate, data bit length, stop bit length).</td> </tr> <tr> <td>16</td> <td>Cause: the I/O buffer overflows. Action: This error does not occur when hardware handshake is performed, but may occur when software handshake is performed. If this error occurs, check the remaining buffer capacity of the PNC-900 and send less data than the remaining buffer capacity.</td> </tr> </tbody> </table>	Error code	Possible cause and action	0	No I/O errors	10	Cause: after execution of an output command, other output instructions are sent before the output was not completed. Action: let the computer to read the PNC-900 output by the output instruction and then send another output instruction.	11	Cause: an error occurs in a device control instruction. Action: correct your program.	12	Cause: incorrect parameter are set to a device control instruction (the default value is set to the erroneous parameter) Action: correct your program.	13	Cause: parameters are overflowing. Action: correct your program.	14	Cause: the number of the parameters set is more than specified or a colon ':' was not used to terminate. Action: correct your program.	15	Cause: framing error, parity error or over-run error at the time of data receipt . Action: match the communication protocols of both computer and PNC-900 (baud rate, data bit length, stop bit length).	16	Cause: the I/O buffer overflows. Action: This error does not occur when hardware handshake is performed, but may occur when software handshake is performed. If this error occurs, check the remaining buffer capacity of the PNC-900 and send less data than the remaining buffer capacity.
Error code	Possible cause and action																					
0	No I/O errors																					
10	Cause: after execution of an output command, other output instructions are sent before the output was not completed. Action: let the computer to read the PNC-900 output by the output instruction and then send another output instruction.																					
11	Cause: an error occurs in a device control instruction. Action: correct your program.																					
12	Cause: incorrect parameter are set to a device control instruction (the default value is set to the erroneous parameter) Action: correct your program.																					
13	Cause: parameters are overflowing. Action: correct your program.																					
14	Cause: the number of the parameters set is more than specified or a colon ':' was not used to terminate. Action: correct your program.																					
15	Cause: framing error, parity error or over-run error at the time of data receipt . Action: match the communication protocols of both computer and PNC-900 (baud rate, data bit length, stop bit length).																					
16	Cause: the I/O buffer overflows. Action: This error does not occur when hardware handshake is performed, but may occur when software handshake is performed. If this error occurs, check the remaining buffer capacity of the PNC-900 and send less data than the remaining buffer capacity.																					
ESC .L Output I/O buffer size	[ESC].L	None		PNC-900 outputs the size of the I/O buffer to the computer when receiving this instruction. It usually outputs 1024 (bytes).																		
Abort Instructions																						
ESC .J Abort Device Control Instruction	[ESC].J	None		Aborts both the currently executed device control instruction and output.																		
ESC .K Abort CAMM-GLIII Instruction	[ESC].K	None		Continues to execute the CAMM-GL III instruction in operation, aborts other incoming CAMM-GL III instructions and clears the data buffer.																		
ESC .R Initialize Device Control Instruction	[ESC].R	None		<p>Initializes all settings established by the device control instructions. Execution of [ESC].R brings the same states as the following device control instructions are executed.</p> <p>[ESC].J, [ESC].M., [ESC].N., [ESC].H., [ESC].I: and [ESC].@:</p>																		

10 LIST OF OPTIONS

Option name	Product number	Description
Spare blade (for standard vinyl sheet)	ZEC-U1005	Cemented carbide blade (5 pcs/set)
Spare blade (for thick, fluorescent vinyl sheet)	ZEC-U5025	Cemented carbide blade (5 pcs/set)
Blade holder	XD-CH1	Blade holder (1 piece)
Ajustable Blade Holder	XD-CH2	Blade holder (1 piece)
Water-based fiber-tipped pens	XD-4SPA-WNG XD-4SPB-WNG XD-4SPC-WNG XD-4SPA-WWG XD-4SPB-WWG XD-4SPC-WWG	0.3 mm 4 black 0.3 mm one each-black, red, blue, and green 0.3 mm one each-orange, pink, blown, and violet 0.6 mm 4 black 0.6 mm one each-black, red, blue, and green 0.6 mm one each-orange, pink, blown, and violet
Thick Water-based fiber-tipped pens	XD-4SPA-WBG XD-4SPB-WBG XD-4SPC-WBG XD-4SPD-WBG XD-4SPE-WBG XD-4SPF-WBG XD-4SPG-WBG XD-4SPH-WBG XD-4SPI-WBG XD-4SPJ-WBG	2.0 mm 4 black 2.0 mm one each-black, red, blue, and green 2.0 mm one each-orange, pink, blown, and violet 2.0 mm 4 red 2.0 mm 4 blue 2.0 mm 4 green 2.0 mm 4 orange 2.0 mm 4 pink 2.0 mm 4 blown 2.0 mm 4 violet
32 color plotter pens (0.3 mm)	XR-2P1A-WN ~ XR-2P8A-WN XR-2P1B-WN ~ XR-2P8B-WN XR-2P1C-WN ~ XR-2P8C-WN XR-2P1D-WN ~ XR-2P8D-WN	Fiber tip pen (0.3 mm) x 2 in 1 color
32 color plotter pens (0.6 mm)	XR-2P1A-WW ~ XR-2P8A-WW XR-2P1B-WW ~ XR-2P8B-WW XR-2P1C-WW ~ XR-2P8C-WW XR-2P1D-WW ~ XR-2P8D-WW	Fiber tip pen (0.6 mm) x 2 in 1 color
Sheet base (for roll sheets)	RSB-30	Sheet base (1 piece)

11 SPECIFICATIONS OF PNC-900

Mechanism	Media-movement method
Acceptable sheet widths	50 mm ~ 305 mm (1-15/16" ~ 12")
Maximum cutting area	Width: 280 mm (11") Length: 24998 mm (984-1/8") (Accuracy assured up to 1600 mm (62-15/16"))
Acceptable paper widths	50 mm ~ 305 mm (1-15/16" ~ 12")
Acceptable paper types	High-quality paper
Tools	Cutters: carbide Pens: Water-based fiber-tipped pens, Thick water-based fiber-tipped pens (options) and 32 color plotter pens (options)
Cutting speed	10 mm/sec ~ 200 mm/sec (When DIP switch SW-8 is at ON: 10 mm/sec - 100 mm/sec)
Blade force	30 gf ~ 200 gf
Mechanical resolution	0.05 mm/step
Software resolution	0.025 mm/step
Distance accuracy	Error of less than +/- 0.2% of distance travelled, or 0.1mm, whichever is grater
Repetition accuracy	0.1 mm or less (Excluding stretching/contraction of the sheet, and provided that sheet length is under 1600 mm (62-15/16"))
Interface	Parallel (Centronics compatible) Serial (RS-232C)
Buffer size	2K byte
Instruction system	CAMM-GLIII (mode1 and mode2)
Switches	Power switch, pen force slider, DIP switches
Control switches	SETUP, PAUSE, PEN MODE, ROTATE, TEST, ORIGIN SET,  ,  ,  , 
LED	POWER/ERROR LED, SETUP LED, PAUSE LED, PEN MODE LED, ROTATE LED
Power consumption	0.5 A / 117 V, 0.3 A / 220 - 230 V, 0.3 A / 240 V
Acoustic noise level	[Cutting mode] When DIP switch SW-8 is at OFF: under 63 dB (A) When DIP switch SW-8 is at ON: under 70 dB (A) [Standby mode] under 40 dB (A) (according to ISO 7779)
Dimensions	492 mm (W) x 289 mm (D) x 217 mm (H) (19-3/8" (W) x 11-7/16" (D) x 8-9/16" (H))
Weight	8.7 kg (19.2 lb.)
Operating temperature	5 ~ 40°C
Operating humidity	35% ~ 80% (non-condensing)

• Interface Specifications

[Parallel]	
Standard	In compliance with the specifications of Centronics
Input signals	STROBE (1 BIT), DATA (8 BIT)
Output signals	BUSY (1 BIT), ACK (1 BIT)
Level of input/output signals	TTL level
Transmission method	Asynchronous
[Serial]	
Standard	RS-232C specifications
Transmission method	Asynchronous, duplex data transmission
Transmission speed	4800, 9600 (Selected using DIP switches.)
Parity check	Odd, Even, or None (Selected using DIP switches.)
Data bits	7 or 8 bits (Selected using DIP switches.)
Stop bits	1 or 2 bits (Selected using DIP switches.)

Parallel Connector (in compliance with specifications of Centronics)

Signal number	Terminal number	Signal number	Pin Connection
NC	36	18	HIGH**
HIGH*	35	17	GND
NC	34	16	GND
GND	33	15	NC
HIGH*	32	14	NC
NC	31	13	HIGH*
GND	30	12	GND
	29	11	BUSY
	28	10	ACK
	27	9	D7
	26	8	D6
	25	7	D5
	24	6	D4
	23	5	D3
	22	4	D2
	21	3	D1
	20	2	D0
	19	1	STROBE

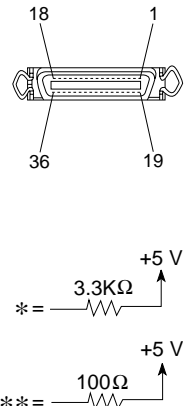

Serial Connector (RS-232C)

Signal number	Terminal number	Signal number	Pin connection
NC	25	13	NC
NC	24	12	NC
NC	23	11	NC
NC	22	10	NC
NC	21	9	NC
DTR	20	8	NC
NC	19	7	SG
NC	18	6	DSR
NC	17	5	CTS
NC	16	4	RTS
NC	15	3	RXD
NC	14	2	TXD
	1	FG	

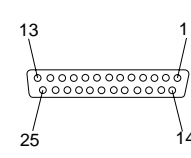



A3020195BE V4-1

Free Manuals Download Website

<http://myh66.com>

<http://usermanuals.us>

<http://www.somanuals.com>

<http://www.4manuals.cc>

<http://www.manual-lib.com>

<http://www.404manual.com>

<http://www.luxmanual.com>

<http://aubethermostatmanual.com>

Golf course search by state

<http://golfingnear.com>

Email search by domain

<http://emailbydomain.com>

Auto manuals search

<http://auto.somanuals.com>

TV manuals search

<http://tv.somanuals.com>