

# KCW-1

## POWERED SUBWOOFER

## Owner's Manual

Thank you, and congratulations on your choice of the Roland Powered Subwoofer KCW-1.

These sections provide important information concerning the proper operation of the unit. Additionally, in order to feel assured that you have gained a good grasp of every feature provided by your new unit, Owner's manual should be read in its entirety. The manual should be saved and kept on hand as a convenient reference.

**Before using this unit, carefully read the sections entitled:**

- **IMPORTANT SAFETY INSTRUCTIONS** (p. 2)
- **USING THE UNIT SAFELY** (p. 3–p. 4)
- **IMPORTANT NOTES** (p. 5)

### Main Features



---

- Equipped with a specialized 10-inch (25 cm) subwoofer speaker, the high-powered KCW-1 has an output of 200 watts.
- The KCW-1's CROSSOVER knob allows you to balance sounds according to the low-frequency playback capability of the connected device.
- Also featured is a BOTTOM switch that further boosts low-frequency sounds.
- INPUT and THRU OUT both feature 1/4" phone jacks and XLR connectors for greater connectivity to a variety of devices.
- With the THRU OUT connector, you can even connect devices with no SUBWOOFER OUT to the KCW-1.
- You can connect an optional foot switch and use your foot to switch the output from the KCW-1's speaker on and off.
- The unit also has a built-in handle for easy portability.

**Copyright © 2003 ROLAND CORPORATION**

All rights reserved. No part of this publication may be reproduced in any form without the written permission of ROLAND CORPORATION.

**WARNING:** To reduce the risk of fire or electric shock, do not expose this apparatus to rain or moisture.

  
<b>ATTENTION:</b> RISQUE DE CHOC ELECTRIQUE NE PAS OUVRIR
<b>CAUTION:</b> TO REDUCE THE RISK OF ELECTRIC SHOCK, DO NOT REMOVE COVER (OR BACK). NO USER-SERVICEABLE PARTS INSIDE. REFER SERVICING TO QUALIFIED SERVICE PERSONNEL.



The lightning flash with arrowhead symbol, within an equilateral triangle, is intended to alert the user to the presence of uninsulated "dangerous voltage" within the product's enclosure that may be of sufficient magnitude to constitute a risk of electric shock to persons.



The exclamation point within an equilateral triangle is intended to alert the user to the presence of important operating and maintenance (servicing) instructions in the literature accompanying the product.

INSTRUCTIONS PERTAINING TO A RISK OF FIRE, ELECTRIC SHOCK, OR INJURY TO PERSONS.

## IMPORTANT SAFETY INSTRUCTIONS SAVE THESE INSTRUCTIONS

**WARNING** - When using electric products, basic precautions should always be followed, including the following:

1. Read these instructions.
2. Keep these instructions.
3. Heed all warnings.
4. Follow all instructions.
5. Do not use this apparatus near water.
6. Clean only with a dry cloth.
7. Do not block any of the ventilation openings. Install in accordance with the manufacturers instructions.
8. Do not install near any heat sources such as radiators, heat registers, stoves, or other apparatus (including amplifiers) that produce heat.
9. Do not defeat the safety purpose of the polarized or grounding-type plug. A polarized plug has two blades with one wider than the other. A grounding type plug has two blades and a third grounding prong. The wide blade or the third prong are provided for your safety. If the provided plug does not fit into your outlet, consult an electrician for replacement of the obsolete outlet.
10. Protect the power cord from being walked on or pinched particularly at plugs, convenience receptacles, and the point where they exit from the apparatus.
11. Only use attachments/accessories specified by the manufacturer.
12. Unplug this apparatus during lightning storms or when unused for long periods of time.
13. Refer all servicing to qualified service personnel. Servicing is required when the apparatus has been damaged in any way, such as power-supply cord or plug is damaged, liquid has been spilled or objects have fallen into the apparatus, the apparatus has been exposed to rain or moisture, does not operate normally, or has been dropped.

For the U.K.

**WARNING:** THIS APPARATUS MUST BE EARTHED

**IMPORTANT:** THE WIRES IN THIS MAINS LEAD ARE COLOURED IN ACCORDANCE WITH THE FOLLOWING CODE.  
GREEN-AND-YELLOW: EARTH, BLUE: NEUTRAL, BROWN: LIVE

As the colours of the wires in the mains lead of this apparatus may not correspond with the coloured markings identifying the terminals in your plug, proceed as follows:

The wire which is coloured GREEN-AND-YELLOW must be connected to the terminal in the plug which is marked by the letter E or by the safety earth symbol  or coloured GREEN or GREEN-AND-YELLOW.

The wire which is coloured BLUE must be connected to the terminal which is marked with the letter N or coloured BLACK.

The wire which is coloured BROWN must be connected to the terminal which is marked with the letter L or coloured RED.

For EU Countries



This product complies with the requirements of European Directives EMC 89/336/EEC and LVD 73/23/EEC.

# USING THE UNIT SAFELY

## INSTRUCTIONS FOR THE PREVENTION OF FIRE, ELECTRIC SHOCK, OR INJURY TO PERSONS

### About ⚠ WARNING and ⚠ CAUTION Notices

<b>⚠ WARNING</b>	Used for instructions intended to alert the user to the risk of death or severe injury should the unit be used improperly.
<b>⚠ CAUTION</b>	Used for instructions intended to alert the user to the risk of injury or material damage should the unit be used improperly. * Material damage refers to damage or other adverse effects caused with respect to the home and all its furnishings, as well to domestic animals or pets.

### About the Symbols

	The ⚠ symbol alerts the user to important instructions or warnings. The specific meaning of the symbol is determined by the design contained within the triangle. In the case of the symbol at left, it is used for general cautions, warnings, or alerts to danger.
	The ⚡ symbol alerts the user to items that must never be carried out (are forbidden). The specific thing that must not be done is indicated by the design contained within the circle. In the case of the symbol at left, it means that the unit must never be disassembled.
	The ⚡ symbol alerts the user to things that must be carried out. The specific thing that must be done is indicated by the design contained within the circle. In the case of the symbol at left, it means that the power-cord plug must be unplugged from the outlet.

### ALWAYS OBSERVE THE FOLLOWING

#### ⚠ WARNING

- Before using this unit, make sure to read the instructions below, and the Owner's Manual.
- Connect mains plug of this model to a mains socket outlet with a protective earthing connection.
- Do not open or perform any internal modifications on the unit.
- Do not attempt to repair the unit, or replace parts within it (except when this manual provides specific instructions directing you to do so). Refer all servicing to your retailer, the nearest Roland Service Center, or an authorized Roland distributor, as listed on the "Information" page.
- Never use or store the unit in places that are:
  - Subject to temperature extremes (e.g., direct sunlight in an enclosed vehicle, near a heating duct, on top of heat-generating equipment); or are
  - Damp (e.g., baths, washrooms, on wet floors); or are
  - Humid; or are
  - Exposed to rain; or are
  - Dusty; or are
  - Subject to high levels of vibration.
- Make sure you always have the unit placed so it is level and sure to remain stable. Never place it on stands that could wobble, or on inclined surfaces.
- The unit should be connected to a power supply only of the type described in the operating instructions, or as marked on the rear side of unit.

#### ⚠ WARNING

- Use only the attached power-supply cord. Also, the supplied power cord must not be used with any other device.
- Do not excessively twist or bend the power cord, nor place heavy objects on it. Doing so can damage the cord, producing severed elements and short circuits. Damaged cords are fire and shock hazards!
- This unit, either alone or in combination with an amplifier and headphones or speakers, may be capable of producing sound levels that could cause permanent hearing loss. Do not operate for a long period of time at a high volume level, or at a level that is uncomfortable. If you experience any hearing loss or ringing in the ears, you should immediately stop using the unit, and consult an audiologist.
- Do not allow any objects (e.g., flammable material, coins, pins); or liquids of any kind (water, soft drinks, etc.) to penetrate the unit.
- In households with small children, an adult should provide supervision until the child is capable of following all the rules essential for the safe operation of the unit.
- Protect the unit from strong impact. (Do not drop it!)

## **WARNING**

- Immediately turn the power off, remove the power cord from the outlet, and request servicing by your retailer, the nearest Roland Service Center, or an authorized Roland distributor, as listed on the “Information” page when:
  - The power-supply cord, or the plug has been damaged; or
  - If smoke or unusual odor occurs
  - Objects have fallen into, or liquid has been spilled onto the unit; or
  - The unit has been exposed to rain (or otherwise has become wet); or
  - The unit does not appear to operate normally or exhibits a marked change in performance.
- Do not force the unit’s power-supply cord to share an outlet with an unreasonable number of other devices. Be especially careful when using extension cords—the total power used by all devices you have connected to the extension cord’s outlet must never exceed the power rating (watts/amperes) for the extension cord. Excessive loads can cause the insulation on the cord to heat up and eventually melt through.
- Before using the unit in a foreign country, consult with your retailer, the nearest Roland Service Center, or an authorized Roland distributor, as listed on the “Information” page.
- Do not put anything that contains water (e.g., flower vases) on this unit. Also, avoid the use of insecticides, perfumes, alcohol, nail polish, spray cans, etc., near the unit. Swiftly wipe away any liquid that spills on the unit using a dry, soft cloth.
- This device is designed to be set on the floor. When using this device, be sure to set it on a stable surface, with the unit’s port side facing forward. When setting up the unit, always make sure that there is ample clearance between the unit and walls and other obstructions to maintain easy access to the controls.

## **CAUTION**

- The unit should be located so that its location or position does not interfere with its proper ventilation.
- Always grasp only the plug on the power-supply cord when plugging into, or unplugging from, an outlet or this unit.
- At regular intervals, you should unplug the power plug and clean it by using a dry cloth to wipe all dust and other accumulations away from its prongs. Also, disconnect the power plug from the power outlet whenever the unit is to remain unused for an extended period of time. Any accumulation of dust between the power plug and the power outlet can result in poor insulation and lead to fire.
- Try to prevent cords and cables from becoming entangled. Also, all cords and cables should be placed so they are out of the reach of children.
- Never climb on top of, nor place heavy objects on the unit.
- Never handle the power cord or its plugs with wet hands when plugging into, or unplugging from, an outlet or this unit.
- Before moving the unit, disconnect the power plug from the outlet, and pull out all cords from external devices.
- Before cleaning the unit, turn off the power and unplug the power cord from the outlet (p. 10).
- Whenever you suspect the possibility of lightning in your area, pull the plug on the power cord out of the outlet.

# IMPORTANT NOTES

In addition to the items listed under “IMPORTANT SAFETY INSTRUCTIONS” and “USING THE UNIT SAFELY” on pages 2, 3 and 4, please read and observe the following:

## Power Supply

- Do not connect this unit to same electrical outlet that is being used by an electrical appliance that is controlled by an inverter (such as a refrigerator, washing machine, microwave oven, or air conditioner), or that contains a motor. Depending on the way in which the electrical appliance is used, power supply noise may cause this unit to malfunction or may produce audible noise. If it is not practical to use a separate electrical outlet, connect a power supply noise filter between this unit and the electrical outlet.
- Before connecting this unit to other devices, turn off the power to all units. This will help prevent malfunctions and/or damage to speakers or other devices.
- Although the LEDs are switched off when the POWER switch is switched off, this does not mean that the unit has been completely disconnected from the source of power. If you need to turn off the power completely, first turn off the POWER switch, then unplug the power cord from the power outlet. For this reason, the outlet into which you choose to connect the power cord's plug should be one that is within easy reach and readily accessible.

## Placement

- Using the unit near power amplifiers (or other equipment containing large power transformers) may induce hum. To alleviate the problem, change the orientation of this unit; or move it farther away from the source of interference.
- This device may interfere with radio and television reception. Do not use this device in the vicinity of such receivers.
- Noise may be produced if wireless communications devices, such as cell phones, are operated in the vicinity of this unit. Such noise could occur when receiving or initiating a call, or while conversing. Should you experience such problems, you should relocate such wireless devices so they are at a greater distance from this unit, or switch them off.
- Do not expose the unit to direct sunlight, place it near devices that radiate heat, leave it inside an enclosed vehicle, or otherwise subject it to temperature extremes. Also, do not allow lighting devices that normally are used while their light source is very close to the unit (such as a piano light), or powerful spotlights to shine upon the same area of the unit for extended periods of time. Excessive heat can deform or discolor the unit.
- When moved from one location to another where the temperature and/or humidity is very different, water droplets (condensation) may form inside the unit. Damage or malfunction may result if you attempt to use the unit in this condition. Therefore, before using the unit, you must allow it to stand for several hours, until the condensation has completely evaporated.
- Do not allow rubber, vinyl, or similar materials to remain on the unit for long periods of time. Such objects can discolor or otherwise harmfully affect the finish.
- Do not paste stickers, decals, or the like to this instrument. Peeling such matter off the instrument may damage the exterior finish.

- Do not allow objects to remain on top of the unit while it is in operation.

## Maintenance

- For everyday cleaning wipe the unit with a soft, dry cloth or one that has been slightly dampened with water. To remove stubborn dirt, use a cloth impregnated with a mild, non-abrasive detergent. Afterwards, be sure to wipe the unit thoroughly with a soft, dry cloth.
- Never use benzene, thinners, alcohol or solvents of any kind, to avoid the possibility of discoloration and/or deformation.
- For routine care of the carpeted surfaces, use a brush with stiff bristles.

## Additional Precautions

- Use a reasonable amount of care when using the unit's buttons, sliders, or other controls; and when using its jacks and connectors. Rough handling can lead to malfunctions.
- When connecting / disconnecting all cables, grasp the connector itself—never pull on the cable. This way you will avoid causing shorts, or damage to the cable's internal elements.
- A small amount of heat will radiate from the unit during normal operation.
- To avoid disturbing your neighbors, try to keep the unit's volume at reasonable levels. You may prefer to use headphones, so you do not need to be concerned about those around you (especially when it is late at night).
- When you need to transport the unit, package it in the box (including padding) that it came in, if possible. Otherwise, you will need to use equivalent packaging materials.
- Some connection cables contain resistors. Do not use cables that incorporate resistors for connecting to this unit. The use of such cables can cause the sound level to be extremely low, or impossible to hear. For information on cable specifications, contact the manufacturer of the cable.
- Do not place your hands inside the ports on the front of the KCW-1. Your hands may become lodged in the ports, possibly resulting in injury to your hand and damaging the unit. Particularly when using the unit in the presence of small children, always make sure that an adult is present to provide supervision and prevent children from inserting their hands or feet in the ports.

# Panel Descriptions

## Control Section

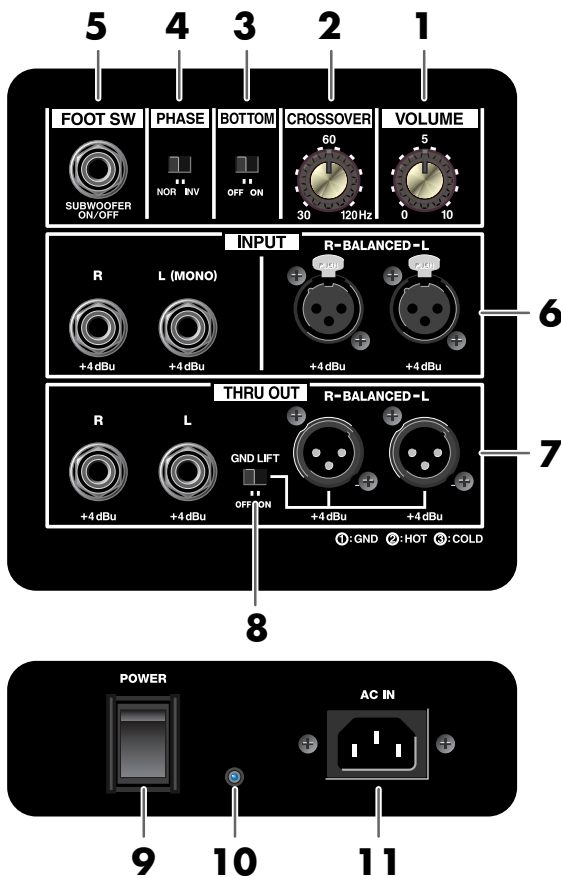

### 1. VOLUME knob

This adjusts the total volume level of the unit's internal speaker.

### 2. CROSSOVER knob

This adjusts the frequency range played back from the unit's speaker. Adjust this according to the low-frequency playback capabilities of the connected device, as well as the performance environment.

The relationship between the CROSSOVER knob indicator and the active frequency range is shown below.

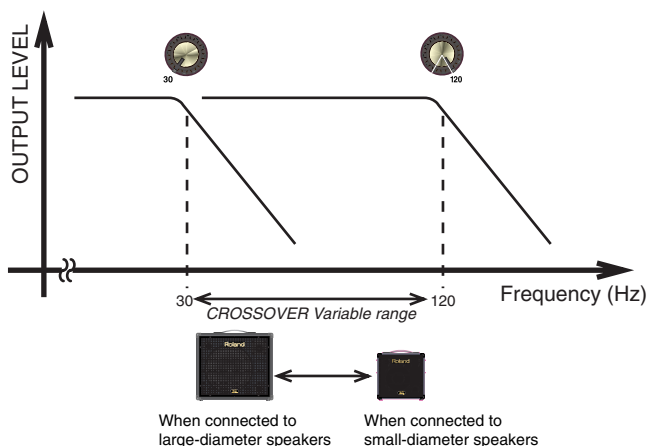

### 3. BOTTOM switch

Setting this switch to ON allows you to play the low end with even greater power and punch.

Use this switch according to the input source as well as the performance environment.

The BOTTOM switch is useful in the following situations.

- When you want to produce special low-frequency sounds in a range beyond what ordinary subwoofers can handle.
- To get the low bass effect at low volume levels.
- When the connected device features sufficient low-frequency playback, but the proper volume balance with the KCW-1 cannot be attained with the CROSSOVER and VOLUME knob.

\* The BOTTOM switch affects only the speaker output.

### 4. PHASE switch

Setting this switch to INV inverts the phase of sounds played from the KCW-1's speaker.

Ordinarily use the KCW-1 with this switch set to NOR.

Switch the setting as needed according to conditions where the unit is being set up to achieve greater volume in the bass range.

The PHASE switch is useful in the following type of situation.

- The KCW-1's low-frequency sound may not be fully apparent when the placement relation or room acoustics cause phase discrepancies between the KCW-1 and the connected device.

Switching the PHASE switch in such conditions can allow you to achieve greater volume in the bass range.

\* The PHASE switch affects only the speaker output.

### 5. FOOT SW jack

You can connect a momentary-type foot switch (the optional DP-2 or BOSS FS-5U) and use the switch to turn the output of the KCW-1's speaker on and off.

\* Switching with the foot switch affects only the speaker output.

## INPUT Section

### 6. INPUT jacks

Signals from devices equipped with a SUBWOOFER OUT connector are input here. For instructions on connecting to devices not equipped with any SUBWOOFER OUT, refer to "Instructions for Connecting to Devices With No SUBWOOFER OUT" (p. 9).

Two types of connectors are provided: XLR connectors and 1/4" phone jacks. Use the type of connector matching the device you are connecting.

These accept level input of +4 dBu.

## **THRU OUT Section**

### **7. THRU OUT jacks**

Signals input to the INPUT jacks are output here unchanged. These are convenient when connecting to devices that have no SUBWOOFER OUT. For detailed connection instructions, refer to "Instructions for Connecting to Devices With No SUBWOOFER OUT" (p. 9).

Two types of connectors are provided: XLR connectors and 1/4" phone jacks. Use the type of connectors that match the device you are connecting.

These output jacks provide +4 dBu line level output.

- \* *No sounds are output from the THRU OUT jacks when the power is turned off.*
- \* *The PHASE switch, BOTTOM switch, and CROSSOVER knob do not affect the output from THRU OUT.*
- \* *When inputting only to the INPUT L (MONO) jack, the signal is output from both the L and R jacks of THRU OUT.*

### **8. GND LIFT switch**

Allows you to make/break the connection between the GND pins of the THRU OUT XLR connectors and the KCW-1's ground.

If you encounter noise problems that are possibly caused by a ground loop, try changing the switch position to alleviate the problem.

### **9. POWER switch**

This switches the power on and off.

- \* *Before turning the power on or off, be sure to put the VOLUME knob at 0.*
- \* *This unit is equipped with a protection circuit. A brief interval (a few seconds) after power up is required before the unit will operate normally.*
- \* *Refer to p. 10 for the order in which to turn the power to connected devices on and off.*
- \* *If you need to turn off the power completely, first turn off the POWER switch, then unplug the power cord from the power outlet. Refer to "Power Supply" (p. 5).*

### **10. POWER indicator**

This lights up when the power is on.

### **11. AC inlet**

Connect the included Power cord here. Plug it firmly in, so that the cable does not accidentally become disconnected.

## **■ Front Panel**

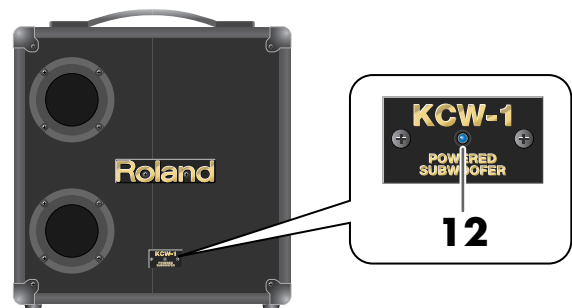

### **12. OPERATION indicator**

This lights up when the power is on. When a connected foot switch is used to switch off the KCW-1's speaker output, the indicator flashes.

# Connect your KCW-1

## Instructions for Connecting to Devices Equipped with SUBWOOFER OUT Connectors (Mono Connection)

When connecting to devices equipped with SUBWOOFER OUT connectors, make the connections between the KCW-1 and other devices after referring to the following figure.

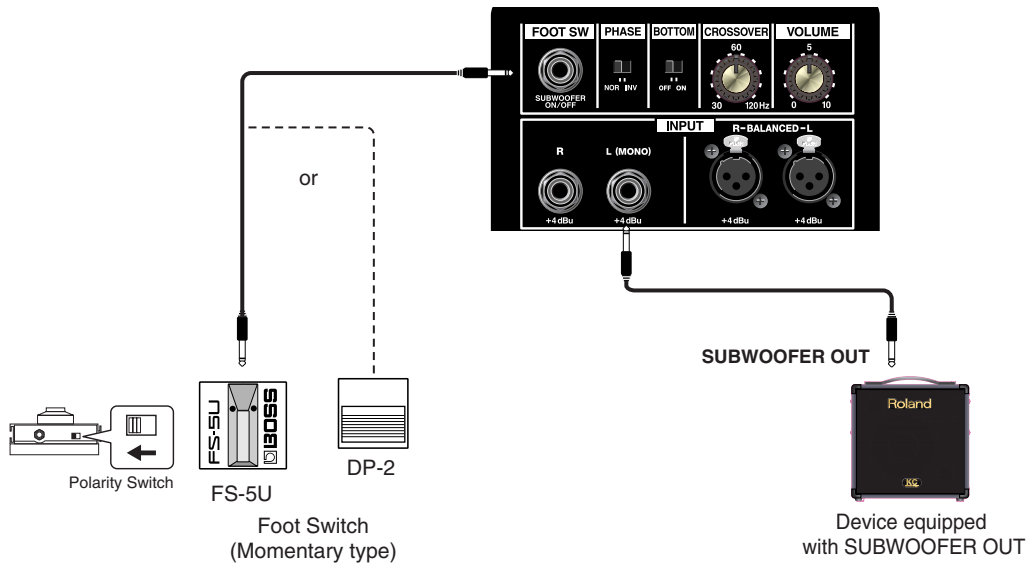

Use a 1/4" phone audio cable to connect the SUBWOOFER OUT on the device featuring the SUBWOOFER OUT connector to the KCW-1's INPUT L (MONO).

## Instructions for Connecting to Devices Equipped with SUBWOOFER OUT Connectors (Stereo Connection)

When connecting the KCW-1 to the KC-550/350 or similar devices, and using a stereo link to play sounds in stereo, make the connections to the KCW-1 as shown in the following figure.

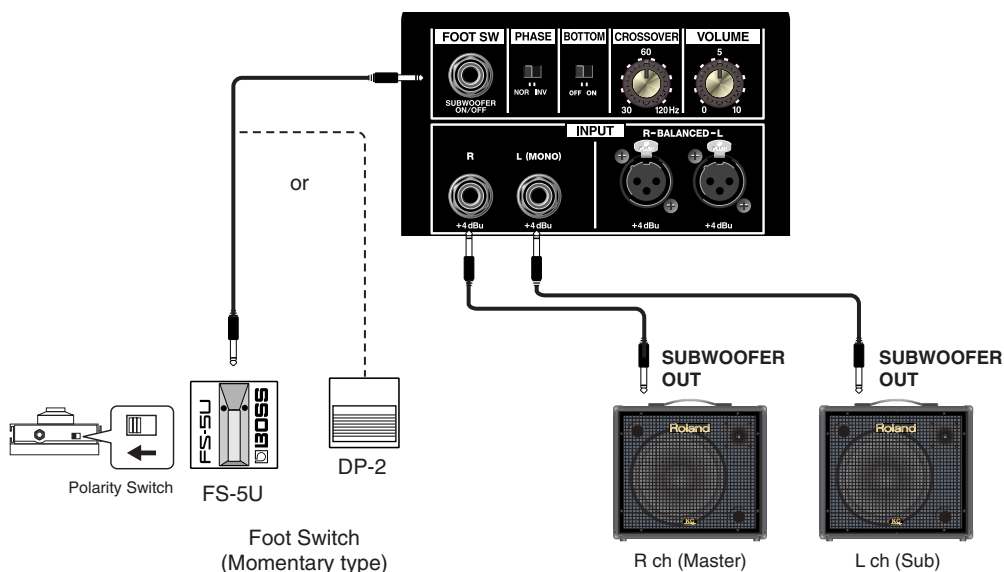

Use 1/4" phone audio cables to connect both the R (Master) and L (Sub) SUBWOOFER OUTs on the KC-550/350 or other devices to the KCW-1's INPUT L and R.



## Instructions for Connecting to Devices With No SUBWOOFER OUT

When connecting to devices with no SUBWOOFER OUT connectors, connect such equipment to the KCW-1 after referring to the following figure.

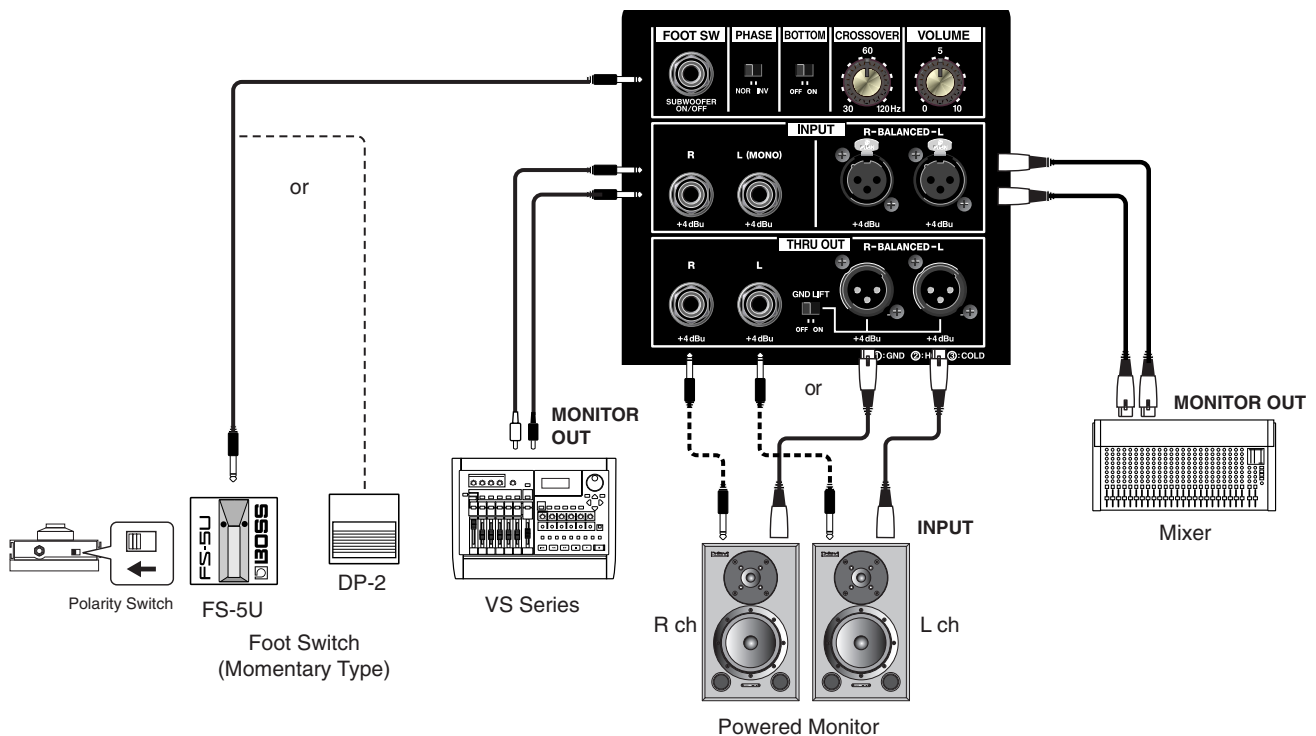

Input signals from the VS Series and other output devices to the INPUT connectors. Connect DS Series powered monitors or similar devices to the KCW-1's THRU OUT.

The INPUT section features XLR and 1/4" phone jacks. Although both types may be used simultaneously, adjust the connected devices to attain the proper volume balance between the input devices.

THRU OUT also includes XLR connectors and 1/4" phone jacks. Both types may be used simultaneously.

## Notes Regarding the Connections

- \* To prevent malfunction and/or damage to speakers or other devices, always turn down the volume, and turn off the power on all devices before making any connections. Set the KCW-1's VOLUME knob to zero.
- \* Some connection cables contain resistors. Do not use cables that incorporate resistors for connecting to this unit. The use of such cables can cause the sound level to be extremely low, or impossible to hear. For information on cable specifications, contact the manufacturer of the cable.
- \* This instrument is equipped with balanced (XLR) type jacks. Wiring diagrams for these jacks are shown below. Make connections after first checking the wiring diagrams of other equipment you intend to connect.

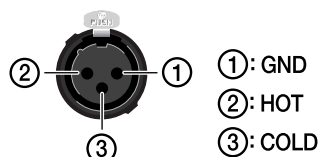

## Switching the Power On and Off

---

Once the connections have been completed (p. 8), turn on power to your various devices in the order specified. By turning on devices in the wrong order, you risk causing malfunction and/or damage to speakers and other devices.

1. Make sure that all volume controls on the KCW-1 and connected devices are set to 0.
2. Turn on all the devices connected to the KCW-1's input jacks.
3. Turn on the KCW-1.
4. Switch on any equipment connected to the KCW-1's THRU OUT jacks.
5. Adjust the volume levels for the devices.
6. Before switching off the power, lower the volume on each of the devices in your system and then TURN OFF the devices in the reverse order to which they were switched on.

\* *This unit is equipped with a protection circuit. A brief interval (a few seconds) after power up is required before the unit will operate normally. For protection from sudden big sound, always make sure to have the volume level turned down before switching on power.*

\* *Always make sure to have the volume level turned down before switching on power. Even with the volume all the way down, you may still hear some sound when the power is switched on, but this is normal, and does not indicate a malfunction.*

\* *If you need to turn off the power completely, first turn off the POWER switch, then unplug the power cord from the power outlet. Refer to **Power Supply** (p. 5).*

# Block Diagram

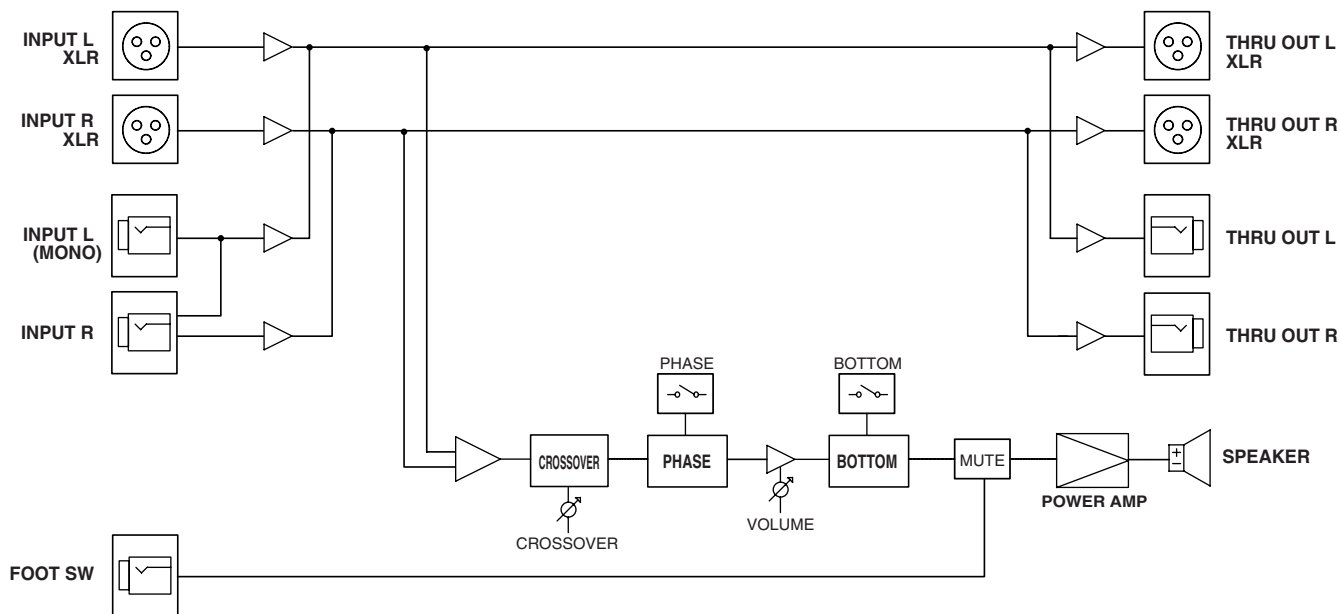

# Main Specifications

## KCW-1: Powered Subwoofer

### Rated Power Output

200 W

### Nominal Input Level (100 Hz)

Input: +4 dBu (XLR type, 1/4" phone type)

### Nominal Output Level (100 Hz)

Thru Out: +4 dBu (XLR type, 1/4" phone type)

\* 0 dBu = 0.775 Vrms

### Speaker

25 cm (10 inches) x 1

### Controls

VOLUME Knob  
 CROSSOVER Knob  
 BOTTOM Switch  
 PHASE Switch  
 POWER Switch  
 GND LIFT Switch

### Indicator

POWER  
 OPERATION

### Connectors

INPUT Connector L, R (XLR type)  
 INPUT Jack L (MONO), R (1/4" phone type)  
 THRU OUT Connector L, R (XLR type)  
 THRU OUT Jack L, R (1/4" phone type)  
 FOOT SW Jack (1/4" phone type)

### Power Supply

AC 117 V, AC 230 V, AC 240 V: 50/60 Hz  
 AC 220 V: 60 Hz

### Power Consumption

135 W

### Dimensions

438 (W) x 440 (D) x 460 (H) mm  
 17-1/4 (W) x 17-3/8 (D) x 18-1/8 (H) inches

### Weight

23.0 kg  
 50 lbs 12 oz

### Accessory

Owner's Manual  
 Power Cord

### Options

Pedal Switch: DP-2  
 Foot Switch: FS-5U (BOSS)

\* In the interest of product improvement, the specifications and/or appearance of this unit are subject to change without prior notice.



This product must be disposed of separately at your local waste recycling centre. Do not dispose of in household waste bin.



## Free Manuals Download Website

<http://myh66.com>

<http://usermanuals.us>

<http://www.somanuals.com>

<http://www.4manuals.cc>

<http://www.manual-lib.com>

<http://www.404manual.com>

<http://www.luxmanual.com>

<http://aubethermostatmanual.com>

Golf course search by state

<http://golfingnear.com>

Email search by domain

<http://emailbydomain.com>

Auto manuals search

<http://auto.somanuals.com>

TV manuals search

<http://tv.somanuals.com>